



Journal of the Royal Microscopical Society

CONTAINING ITS TRANSACTIONS AND PROCEEDINGS

AND

A SUMMARY OF CURRENT RESEARCHES RELATING TO
ZOOLOGY AND BOTANY

(principally Invertebrata and Cryptogamia)

MICROSCOPY, &c.

EDITED BY

R. G. HEBB, M.A. M.D. F.R.C.P.

WITH THE ASSISTANCE OF THE PUBLICATION COMMITTEE AND

J. ARTHUR THOMSON, M.A. F.R.S.E.

A. N. DISNEY, M.A. B.Sc.

*Regius Professor of Natural History in the
University of Aberdeen*

FELLOWS OF THE SOCIETY

AND

A. B. RENDLE, M.A. D.Sc. F.R.S. F.I.S.

Keeper, Department of Botany, British Museum

HAROLD MOORE, B.Sc.

Woolwich Arsenal

G. H. K. MACALISTER, M.A. M.D. (CANTAB.)

Assistant Bacteriologist Lister Institute

Minimis partibus, per totum Naturæ campum, certitudo omnis innititur
quas qui fugit pariter Naturam fugit.—*Linnaeus*.

FOR THE YEAR

1911



TO BE OBTAINED AT THE SOCIETY'S ROOMS

20 HANOVER SQUARE, LONDON, W.

OF MESSRS. WILLIAMS & NORGATE, 14 HENRIETTA STREET, LONDON, W.C.

AND OF MESSRS. DULAU & CO., 37 SOHO SQUARE, LONDON, W.

Extra and informal Meetings are held on the 1st and 4th Wednesday evenings of the month. These Meetings are devoted to :—(1) Biology, Bacteriology, and Histology ; (2) Microscopical Optics and Microscope Construction.

THE

Royal Microscopical Society.

Established in 1839. Incorporated by Royal Charter in 1866.

The Society was established for the promotion of Microscopical and Biological Science by the communication, discussion, and publication of observations and discoveries relating to (1) improvements in the construction and mode of application of the Microscope, or (2) Biological or other subjects of Microscopical Research.

It consists of Ordinary, Honorary, and Ex-officio Fellows of either sex.

Ordinary Fellows are elected on a Certificate of Recommendation signed by three Ordinary Fellows, setting forth the names, residence, and description of the Candidate, of whom the first proposer must have personal knowledge. The certificate is read at two General Meetings, and the Candidate balloted for at the second Meeting.

The Admission Fee is 2*l.* 2*s.*; and the Annual Subscription 2*l.* 2*s.*, payable on election, and subsequently in advance on 1st January annually. The Annual Subscriptions may be compounded for at any time for 31*l.* 10*s.* Fellows elected at a meeting subsequent to that in February are only called upon for a proportionate part of the first year's subscription. The annual Subscription of Fellows permanently residing abroad is 1*l.* 11*s.* 6*d.* or a reduction of one-fourth.

Honorary Fellows (limited to 50), consisting of persons eminent in Microscopical or Biological Science, are elected on the recommendation of five Ordinary Fellows and the approval of the Council.

Ex-officio Fellows (limited to 100), consisting of the Presidents for the time being of any Societies having objects in whole or in part similar to those of the Society, are elected on the recommendation of ten Ordinary Fellows and the approval of the Council.

The Council, in whom the management of the property and affairs of the Society is vested, is elected annually, and is composed of the President, four Vice-Presidents, Treasurer, two Secretaries, and twelve other Ordinary Fellows.

The Meetings are held on the third Wednesday in each month, from October to June, at 20 Hanover Square, W. (commencing at 8 P.M.). Visitors are admitted by the introduction of Fellows. (See preceding page.)

The Journal, containing the Transactions and Proceedings of the Society, and a Summary of Current Researches relating to Zoology and Botany (principally Invertebrata and Cryptogamia), Microscopy, &c., is published bi-monthly, and is forwarded post-free to all Ordinary and Ex-officio Fellows residing in countries within the Postal Union.

The Library, with the Instruments, Apparatus, and Cabinet of Objects, is open for the use of Fellows daily (except Saturdays), from 10 A.M. to 5 P.M. It is closed for four weeks during August and September.

Forms of proposal for Fellowship, and any further information, may be obtained by application to the Secretaries, or Assistant-Secretary, at the Library of the Society, 20 Hanover Square, W.

Patron

HIS MAJESTY THE KING.

Past-Presidents.

	Elected
*SIR RICHARD OWEN, K.C.B. D.C.L. M.D. LL.D. F.R.S.	1840-1
*JOHN LINDLEY, Ph.D. F.R.S.	1842-3
*THOMAS BELL, F.R.S.	1844-5
*JAMES SCOTT BOWERBANK, LL.D. F.R.S.	1846-7
*GEORGE BUSK, F.R.S.	1848-9
*ARTHUR FARRE, M.D. F.R.S.	1850-1
*GEORGE JACKSON, M.R.C.S.	1852-3
*WILLIAM BENJAMIN CARPENTER, C.B. M.D. LL.D. F.R.S.	1854-5
*GEORGE SHADBOLT	1856-7
*EDWIN LANKESTER, M.D. LL.D. F.R.S.	1858-9
*JOHN THOMAS QUEKETT, F.R.S.	1860
*ROBERT JAMES FARRANTS, F.R.C.S.	1861-2
*CHARLES BROOKE, M.A. F.R.S.	1863-4
*JAMES GLAISHER, F.R.S.	1865-6-7-8
*REV. JOSEPH BANCROFT READE, M.A. F.R.S.	1869-70
*WILLIAM KITCHEN PARKER, F.R.S.	1871-2
*CHARLES BROOKE, M.A. F.R.S.	1873-4
*HENRY CLIFTON SORBY, LL.D. F.R.S.	1875-6-7
*HENRY JAMES SLACK, F.G.S.	1878
*LIONEL S. BEALE, M.B. F.R.C.P. F.R.S.	1879-80
*PETER MARTIN DUNCAN, M.B. F.R.S.	1881-2-3
*REV. WILLIAM HY. DALLINGER, M.A. LL.D. F.R.S.	1884-5-6-7
*CHARLES THOS. HUDSON, M.A. LL.D. (Cantab.), F.R.S.	1888-9-90
ROBERT BRAITHWAITE, M.D. M.R.C.S.	1891-2
ALBERT D. MICHAEL, F.L.S.	1893-4-5-6
EDWARD MILLES NELSON	1897-8-9
WILLIAM CARRUTHERS, F.R.S. F.L.S. F.G.S.	1900-1
HENRY WOODWARD, LL.D. F.R.S. F.G.S. F.Z.S.	1902-3
DUKINFIELD HY. SCOTT, M.A. Ph.D. LL.D. F.R.S. F.L.S.	1904-5-6
THE RIGHT HON. LORD AVEBURY, P.C. D.C.L. LL.D. F.R.S., etc.	1907-8
SIR EDWIN RAY LANKESTER, K.C.B. M.A. LL.D. F.R.S. F.L.S. F.Z.S.	1909
J. ARTHUR THOMSON, M.A. F.R.S.E.	1910

* Deceased.

COUNCIL.

ELECTED 19TH JANUARY, 1911.

President.

HENRY GEORGE PLIMMER, F.R.S. F.L.S. F.Z.S.

Vice-Presidents.

*A. N. DISNEY, M.A. B.Sc.

R. G. HEBB, M.A. M.D. F.R.C.P.

E. HERON-ALLEN, F.L.S. F.Z.S. F.R.Met.Soc.

J. ARTHUR THOMSON, M.A. F.R.S.E., Regius Professor of Natural History in the University of Aberdeen.

Treasurer.

WYNNE E. BAXTER, J.P. D.L. F.G.S. F.R.G.S.

Secretaries.

J. W. H. EYRE, M.D. F.R.S.E.

*F. SHILLINGTON SCALES, M.A. M.B. B.C.(Cantab.)

Ordinary Members of Council.

F. W. WATSON BAKER.

J. E. BARNARD.

*FREDERIC J. CHESHIRE.

CHAS. LEES CURTIES.

C. F. HILL.

JOHN HOPKINSON, F.L.S. F.G.S. F.Z.S.

P. E. RADLEY.

*JULIUS RHEINBERG.

*CHARLES F. ROUSSELET.

D. J. SCOURFIELD, F.Z.S.

E. J. SPITTA, L.R.C.P.(Lond.), M.R.C.S.(Eng.).

SIR ALMROTH E. WRIGHT, M.D. D.Sc. F.R.S.

* Members of the Publication Committee.

LIBRARIAN.

PERCY E. RADLEY.

CURATORS.

CHARLES F. ROUSSELET.

F. SHILLINGTON SCALES, M.A. M.B. B.C.(Cantab.)

ASSISTANT SECRETARY.

F. A. PARSONS.

CONTENTS.

TRANSACTIONS OF THE SOCIETY.

	PAGE
I.—Some African Rotifers: Bdelloida of Tropical Africa. By J. Murray, F.R.S.E. F.Z.S. (Plates I., II.)	1
II.—A Simple Method of Obtaining Instantaneous Photomicrographs. By J. Edwin Barnard. (Fig. 1)	19
III.—On the Use of a Metallic Electric Arc in Photomicrography. By J. Edwin Barnard	21
IV.—Aerator Suitable for Laboratory Aquaria. By F. J. Gemmill, M.A. D.Sc. M.D. (Fig. 2).. .. .	24
V.—Adaptation of Ordinary Paraffin Baths for Vacuum Embedding. By F. J. Gemmill, M.A. D.Sc. M.D. (Fig. 3)	26
VI.—The President's Address: The Determination of Sex. By J. Arthur Thomson, M.A.	141
VII.—On the Measurement of Grayson's New Ten-Band Plate. By A. A. C. Eliot Merlin	160
VIII.—Australian Rotifera: Collected by the Shackleton Antarctic Expedition, 1909. By J. Murray, F.R.S.E. (Plates IV., V.)	164
IX.—Anomalies in Objective Screw Threads. By F. W. Watson Baker. (Fig. 24)	175
X.—Adams's "Variable" and the Evolution of the Modern Microscope. By Edward M. Nelson (Figs. 25-30)	178
XI.—Canadian Rotifera: Collected by the Shackleton Antarctic Expedition, 1909. By J. Murray, F.R.S.E. (Plates VI.-VIII.)	285
XII.—On the Recent and Fossil Foraminifera of the Shore-sands of Selsey Bill, Sussex.—VII. Supplement (Addenda et Corrigenda). By Edward Heron-Allen, F.L.S. F.R.M.S., and Arthur Earland, F.R.M.S. (Plates IX.-XIII.)	298
XIII.—Rotifera of some Pacific Islands: Collected by the Shackleton Antarctic Expedition, 1909. By James Murray, F.R.S.E. (Plates XIV., XV.)	429
XIV.—On the Recent and Fossil Foraminifera of the Shore-sands of Selsey Bill, Sussex.—VIII. Tabular List of Species and Localities. By Edward Heron-Allen, F.L.S. F.R.M.S., and Arthur Earland, F.R.M.S.	436
XV.—A Report on the Grayson's Rulings presented by Mr. C. Beck to the Royal Microscopical Society. By E. J. Spitta	449
XVI.—On some New Objectives and Eye-pieces by R. Winkel, of Gottingen. By Edward M. Nelson	451
XVII.—Rotifera of New Zealand: Collected by the Shackleton Antarctic Expedition, 1907-9. By James Murray, F.R.S.E. (Plates XVI., XVII.)	573
XVIII.—South African Rotifera: Collected by the Shackleton Antarctic Expedition, 1907. By James Murray, F.R.S.E. (Plate XVI.)	584

	PAGE
XIX.—Apparatus for Photomicrography with the Microscope standing in any Position, especially in Inclined Position. By Domingo de Orueta. F.R.M.S. (Figs. 70, 71)	588
XX.—A Method of Disintegrating Bacteria and other Organic Cells. By J. Edwin Barnard, F.R.M.S. (Plate XVIII. and Figs. 72, 73)	592
XXI.—The Re-appearance of the Nucleolus in Mitosis. By E. J. Sheppard. (Plate XIX.)	598
XXII.—1. On the Structure of Scales from <i>Thermobia domestica</i> (Packard). ii. Description of a Model Producing an Optical Effect similar to the Cuneate Markings on Insect Scales. By James Strachan. (Plate XXIV.)	717
XXIII.—Instantaneous Exposure in Photomicrography. By Walter Bagshaw. F.R.M.S.	721
XXIV.—The Structural Detail of <i>Coscinodiscus asteromphalus</i> . By T. W. Butcher, M.B. C.M. F.R.M.S. (Plates XXV.—XXVII.)	722
XXV.—New British Enchytreids. By The Rev. Hilderic Friend, F.L.S. F.R.M.S. (Plate XXVIII.)	730

SUMMARY OF CURRENT RESEARCHES

RELATING TO ZOOLOGY AND BOTANY (PRINCIPALLY INVERTEBRATA AND
CRYPTOGAMIA), MICROSCOPY, &C., INCLUDING ORIGINAL COMMUNICATIONS
FROM FELLOWS AND OTHERS.* 29, 185, 344, 453, 603, 737

ZOOLOGY.

VERTEBRATA.

a. Embryology.

GUYER, M. F.— <i>Accessory Chromosomes in Man</i>	29
MOLLÉ, J. VAN— <i>Mammalian Spermatozoon</i>	30
DAVENPORT, GERTRUDE C., & CHARLES B.— <i>Inheritance of Skin-pigmentation in Man</i>	30
MORSE, MAX— <i>Sterility</i>	30
MIRONESCU, T.— <i>Islands of Langerhans in the Human Embryo</i>	31
KUNTZ, A.— <i>Development of the Sympathetic Nervous System in Mammals</i>	31
“ <i>Development of the Sympathetic Nervous System in Birds</i>	32
O'DONOGHUE, CHAS. H.— <i>Duplicity in Chick Embryos</i>	33
PEARL, R., & F. M. SURFACE— <i>Inheritance in Hybrid Poultry</i>	34
“ “ <i>Inheritance of Colour-pattern in Hybrid Poultry</i>	34
SCHMALHAUSEN, J. J.— <i>Development of Limbs in Salamandrella kayserlingii</i>	35
HEFFORD, A. E.— <i>Teleostean Ova and Larvæ</i>	35
THOMSON, J. ARTHUR— <i>The President's Address: The Determination of Sex</i>	141
HERTWIG, O.— <i>Influence of Radium Rays on Ova and Sperms</i>	185
RÜCKERT, J.— <i>Polyspermy</i>	185
GRÉGOIRE, VICTOR— <i>Unity of Meiotic Process in Plants and Animals</i>	186
GEDDES, A. C.— <i>Abnormal Bone-growth in Absence of Functioning Testes</i>	186
TSCHIRWINSKY, N.— <i>Influence of Malnutrition and Castration on Development of Sheep's Skeleton</i>	186
STACH, J.— <i>Development of Rabbit's Teeth</i>	186
BRUNI, A. C.— <i>Development of Vertebral Column in Reptiles and Birds</i>	186

* In order to make the Contents complete, the papers printed in the 'Transactions' and the Notes printed in the 'Proceedings' are entered here.

	PAGE
REESE, ALBERT M.— <i>Development of Enteron in American Alligator</i>	187
WUNDERER, HANS— <i>Development of Alpine Salamander</i>	187
LISSITSKY, EUGEN— <i>Production of Supernumerary Limbs in Amphibians</i>	187
REIS, CAROLINE— <i>Development of Teleosts</i>	187
BOLK, L.— <i>Development of Pigment-cells in Teleostean Embryos</i>	187
MCLLROY, A. LOUISE— <i>Oogenesis in Mammals</i>	344
SIEGLBAUER, F.— <i>Development of the Extremities in Birds</i>	345
ROSENBERG, F. T.— <i>Development of the Limbs in Grebes</i>	345
MIETENS, H.— <i>Origin of White Blood-corpuses and Spleen in Bufo vulgaris</i>	346
STROMSTEN, FRANK A.— <i>Structure and Development of Posterior Lymph-hearts of</i> <i>Turtles</i>	346
GOODALE, H. W.— <i>Blastopore Closure in Amphibia</i>	347
BROWNLEE, J.— <i>Inheritance of Complex Growth-forms</i>	347
REGAUD, CL., & TH. NOGIER— <i>Castration by X-rays</i>	347
TH. NOGIER & CL. REGAUD— <i>Sterilization by X-rays</i>	347
MAZZETTI, L.— <i>Interstitial Testicular Cells and Secondary Sex Characters</i>	348
SMITH, GEOFFREY— <i>Injection of Testis-extract into Hens</i>	348
WARREN, ERNEST— <i>Mammalian Sports</i>	348
PUNNETT, R. C.— <i>Mendelism</i>	453
PLATE, L.— <i>Heredity and Evolution</i>	453
BATAILLON, E.— <i>Experimentally Induced Parthenogenesis in Toad</i>	454
.. .. . <i>Artificial Parthenogenesis of Toad's Egg</i>	454
.. .. . <i>Artificial Parthenogenesis in Toad</i>	454
DEHORNE, A.— <i>Number of Chromosomes in Parthenogenetically produced Larvæ of</i> <i>the Frog</i>	454
ROMIEU, M.— <i>Plasmic Reduction in Spermatogenesis</i>	454
DONCASTER, L., & F. H. A. MARSHALL— <i>Effects of One-sided Ovariectomy on Sex of</i> <i>Offspring</i>	454
HICKSON, SYDNEY J.— <i>Origin of Sex</i>	454
IWANOFF, E.— <i>Fertility of Hybrids of American and European Bison</i>	455
CHAPPELIER, A.— <i>State of Ovary in Hybrids of Goldfinch and Canary</i>	455
BONHOTE, J. LEWIS— <i>Webfoot Character in Pigeons</i>	455
GASKELL, J. F.— <i>Action of X-rays on Developing Chick</i>	455
STROMSTEN, F. A.— <i>Lymph-hearts of Turtles</i>	455
GOODRICH, E. S.— <i>Occipital Region of Urodela</i>	456
JØRGENSEN, MAX— <i>Ovarian Ovum of Proteus</i>	456
KUSCHAKEWITSCH, SERGIUS— <i>Development of Gonads in Frog</i>	456
MARCUS, HARRY— <i>Development of Head in Hypogeophis</i>	456
MAKUSCHOK, M.— <i>Development and Evolution of Lungs</i>	457
ARLDT, TH.— <i>Evolution-centres</i>	457
SCHAFFER, J.— <i>Post-natal Remains of the Notochord in Mammals</i>	603
ATHIAS, M.— <i>Maturation of the Mammalian Ovum</i>	603
SOBOTTA, J.— <i>Early Development of White Mouse</i>	603
BLUNTSCHLI, H.— <i>Teeth of Two Dentitions in a Dermoid Cyst</i>	604
POLL, HEINRICH— <i>Ovary in Hybrid Birds</i>	604
SMITH, GEOFFREY— <i>Fluctuations in Growth of Fowl's Comb</i>	604
KUNKEL, B. W.— <i>Development of Turtle Skull</i>	605
KUNTZ, A.— <i>Sympathetic Nervous System in Turtles</i>	605
.. .. . <i>Sympathetic Nervous System in Fishes</i>	606
KOPSCH, FR.— <i>Early Development of Trout</i>	607
HERONIMUS, CH.— <i>Development of Pectoral Fin in Amia</i>	607
AGAR, W. E.— <i>Spermatogenesis of Lepidosiren</i>	608
BROESIKE, G.— <i>Nature of Seminal Fluid in Man</i>	608
DANIEL, J. FRANK— <i>Gestation in White Mice</i>	737
BATAILLON, E.— <i>Factors of Traumatic Parthenogenesis</i>	737
BERGER, A.— <i>Alleged Lactation of Male Lepus bairdii</i>	737
BONHOTE, J. LEWIS, & F. W. SMALLEY— <i>Colour Inheritance in Pigeons</i>	738
PEEBLES, FLORENCE— <i>Interchange of Limbs of Chick by Transplantation</i>	738
BIANCO, SALVATORE LO— <i>Influence of Environment on Reproductive Period</i>	738
WINTREBERT, P.— <i>Involution of Tail in Alytes obstetricans</i>	738
DAKIN, W. J.— <i>Physiology of Fish-eggs and Larvæ</i>	738
WILLIAMSON, H. CHAS.— <i>Retarding Development of Herring's Eggs</i>	739

	PAGE
WAGNER, K.— <i>Colouring of Trout</i>	739
GEORGI, W.— <i>Origin of Notochord Epithelium</i>	740
SUNIER, A. L. J.— <i>Development of Myotomes</i>	740
MAZZETTI, L.— <i>Role of Interstitial Testicular Cells</i>	740

b. Histology.

HIRSCHLER, J.— <i>Interstitial Tissue of Striped Muscle</i>	35
MENCL, E.— <i>Direct Division of Red Blood Corpuscles in Scorpena</i>	35
TOYOFUKU, TOMAKI— <i>Cartilage in Thymus of Rat</i>	35
CURTIS, M.— <i>Ligaments of Oviduct of Domestic Fowl</i>	35
BURROWS, MONTROSE T., & OTHERS— <i>Culture of Tissues outside the Organism</i> ..	188
DANTSCHAKOFF, WERA— <i>Blood-formation in Grass Snake</i>	188
PATELLA, VINCENZO— <i>Endothelial Genesis of Leucocytes</i>	188
CAUWENBERGHE, A. VAN— <i>Giant-cells of Mole's Placenta</i>	188
SCHAFFER, JOSEPH— <i>Chordoid Tissue</i>	188
KOLMER, WALTHER— <i>Eye of Pteropus</i>	189
LOEWENTHAL, N.— <i>Thread-like Structures in Epidermic Cells of Tadpoles</i>	189
SAMSONOW, N., & F. MEVES— <i>Threads and Granules in the Cytoplasm</i>	189
ROSENSTADT, B.— <i>Protoplasmic Fibres in Epidermic Cells</i>	189
KOLMER, W.— <i>Supporting Elements in Sensory Epithelium</i>	189
FAURÉ-FREMIET, M. E.— <i>Continuity of Mitochondria through many Generations of Cells</i>	190
KARL, JOSEPH— <i>Reticular Apparatus in Cells of Corpus Luteum</i>	190
CILIMBARIS, P. A.— <i>Pigment-cells in Sheep's Cornea</i>	190
KOHN, A.— <i>Pigment in the Human Neurohypophysis</i>	190
ZARNIK, B.— <i>Kidney of Gecko</i>	190
SCHULTZE, OSKAR— <i>Direct Connexion between Muscle-fibrils and Tendon-fibrils</i> ..	348
LOGINOFF, W. J.— <i>Tracheal Epithelium in Domestic Mammals</i>	349
MOLLIER, S.— <i>Structure of Spleen Capillaries</i>	349
OPPEL, ALBERT— <i>New kind of Cell in Brunner's Glands</i>	349
DUBREUIL, G.— <i>Mitochondria of Adipose Cells</i>	349
SCHULTZE, OSKAR— <i>Origin of Granules in Gland Cells</i>	349
JOLLY, J.— <i>Mitotic Figures in Isolated Tissues</i>	349
PETIT, A.— <i>Mitosis in Grafted Tissue</i>	350
MAGIAT, A.— <i>Survival of Excised Cornea</i>	350
ERHARD, H.— <i>Trophospongia and Chlamidia</i>	457
SCHNEIDER, KARL CAMILLO— <i>Study of Chromosomes in Salamander</i>	457
HOWARD, W. T.— <i>Nuclear Budding in Tumor-cells</i>	458
BARBIERI, N. A.— <i>Physical Nature of Neuroplasm</i>	458
REITTERER, E., & A. LELIÈVRE— <i>Union of Muscle-fibre and Tendinous-fibre</i> ..	458
JOLLY, J.— <i>Involution of Bursa Fabricii</i>	458
FIRKET, JEAN— <i>Epidermic Fibrils in Chick</i>	458
FEDELE, M.— <i>Innervation of Heart in Reptiles and Batrachians</i>	458
FOOT, J. S.— <i>Minute Structure of Femoral Bones</i>	608
REITTERER, E., & AUG. LELIÈVRE— <i>Red Blood Corpuscles of Mammals</i>	609
ZIMMERMANN, K. W.— <i>Epithelial Cells of Mammalian Kidney</i>	609
REITTERER, E., & AUG. LELIÈVRE— <i>Tendons of Wing and Leg in Bats</i>	609
SCHAXEL, JULIUS— <i>Cytoplasm, Chondriosomes, and Chromidia</i>	609
EDINGER, L.— <i>Path of Hypophysial-secretio</i>	610
VIRCHOW, HANS— <i>Conjunctival Epithelium in Man</i>	610
DITLEVSEN, CHRISTIAN— <i>Nuclear Budding in Corneus Epithelium</i>	610
FRITSCH, GUSTAV— <i>Retina of Birds</i>	610
JACOBSON, L.— <i>Grouping of Nerve-cells in Spinal Cord of Tench</i>	610
SCHIEFFERDECKER, P.— <i>Muscles of Lamprey</i>	611
JOLLY, J.— <i>Survival of Isolated Leucocytes</i>	611
NEEMANN, E.— <i>Spindle-cells of Amphibian Blood</i>	740
FRITSCH, GUSTAV— <i>Eye of Pteropus</i>	740
GRYNFELT, E.— <i>Eye of Protopterus</i>	741
SALA, LUIGI— <i>Distribution of the Muscle-fibres in Heart of Fishes</i>	741
SANZO, L.— <i>Cutaneous Papillæ in Gobius</i>	741

c. General.

	PAGE
DOUVILLE, HENRI— <i>Evolution of Man</i>	36
TROUSSERT, E. L.— <i>European Mammals</i>	36
MILLER, GERRITT S.— <i>Six New European Mammals</i>	36
LANKESTER, E. RAY— <i>Atlas of the Okapi</i>	36
DANOIS, E.— <i>Spermaceti-organ of Kogia breviceps</i>	37
PERKINS, G. H.— <i>Fossil Cetacea</i>	37
STAPELEY, WALTER— <i>Guttural Pouches of Horse</i>	37
HOFHERR, OTTO— <i>Relative Immunity of Birds to Anthrax</i>	37
GUÉRIN-GANIVET, J.— <i>Grass Snake in the Sea</i>	37
LÉGER, LOUIS— <i>Muldy Taste in Fresh-water Fishes</i>	37
COCKERELL, T. D. A.— <i>Scales of Fishes</i>	38
CHAINED, J.— <i>Variations in Ureters of Weever</i>	38
FOWLER, H. W.— <i>Variation of Species of Notropis</i>	38
HAEMPEL, O.— <i>Growth of Salmo lueho</i>	38
JUDAY, CHANCEY— <i>Biological Stations</i>	38
THOMSON, J. ARTHUR— <i>Outlines of Zoology</i>	39
HILZHEIMER, M.— <i>Atarism</i>	191
CLARK, AUSTIN HOBART— <i>Interesting Structural Analogy</i>	191
LEDUC, STÉPHANE— <i>Osmotic Growths</i>	191
KAUDERN, W.— <i>Male Genital Organs in Insectivora and Lemuridæ</i>	191
TRUE, FREDERICK W.— <i>Beaked Whales</i>	192
STERLING, S.— <i>Musculature of Pectoral Girdle and Flipper in Cetacea</i>	192
GAUPE, E.— <i>Homology of Mammalian Lachrymal</i>	192
BARDELEBEN, KARL VON— <i>Right- and Left-handedness</i>	192
VERSLUYS, J.— <i>Birds and Deinosaur</i>	192
LELIEVRE, A., & E. RETTERER— <i>Neal Cæcum of Birds</i>	192
BEEBE, C. W.— <i>Account of the Houtzin</i>	193
BILLARD, G., & E. MAUBLANT— <i>Immunity to Viper Venom</i>	193
STEHLL, GEORG— <i>Evolution of Reptilian Scales</i>	193
OKAJIMA, K.— <i>Ear of Urodela</i>	193
FISCHER, H.— <i>Total Closure of Gut in Healthy Frog</i>	193
POPTA, C. M. L.— <i>Function of Swim-bladder</i>	194
DAMMERMANN, K. W.— <i>Structure and Function of the Saccus vasculosus in Fishes</i>	194
KNAUER, K.— <i>Ventral Musculature of Fishes</i>	194
ELMHIRST, RICHARD— <i>Yawning in Fishes</i>	194
DEIJUGIN, K.— <i>Pectoral Girdle and Fins of Teleosteans</i>	195
STEAD, DAVID G.— <i>Fisheries of New South Wales</i>	195
COLOMINA, A. DE— <i>Large Sun-fish</i>	195
SPILLMAN, L., & I. BRUNTZ— <i>Elimination by Leucocytes</i>	195
DADAY, E. VON— <i>Fresh-water Microfauna of German East Africa</i>	195
MAYER, A. G.— <i>Converse Relation between Ciliary and Neuro-muscular Movements</i>	350
POCOCK, R. I.— <i>Cutaneous Scent-glands of Ruminants</i>	351
EWART, J. COSSAR— <i>Descent of Cattle</i>	351
DANVIS, ED.— <i>Head of Kogia Breviceps</i>	351
WEST, JAMES A.— <i>Food of Shrew-mole</i>	352
WOOD, F. E.— <i>Habits of Shrew-mole</i>	352
TRACEY, H. C.— <i>Directive Markings of Passerine Birds</i>	352
MAGNAN & DE LA RIBOISIÈRE— <i>Size of Spleen in Birds</i>	352
TRAWINSKI, A.— <i>Penis of Drake and Gander</i>	353
GRINNELL, JOSEPH— <i>Limet of Hawaiian Islands</i>	353
WILSON, E. A.— <i>Changes of Plumage in Red Grouse</i>	353
ANNANDALE, N.— <i>New Burmese Frog</i>	353
SCHLESINGER, G.— <i>Electric Eels</i>	354
FAGE, LOUIS— <i>Study of Species of Gadus</i>	354
REGAN, C. TATE— <i>Synopsis of Lampreys</i>	354
MCDERMOTT, F. ALEX.— <i>Photogenic Function in Marine Organisms</i>	355
HESS, C.— <i>Sense of Light in Animals</i>	355
VIALLETON, L.— <i>Morphology of the Vertebrates</i>	459
LIVON, CH., & PEYRON— <i>Pigmentation of the Nervous Lobe of the Hypophysis</i>	459
LÖNNBERG, EINAR— <i>Pelvic Bones of some Cetacea</i>	459

	PAGE
ROUDSKY, D.— <i>Natural Immunity of White Mice to Trypanosoma lewisi</i>	159
LEGENDRE, R., & H. PIÉRON— <i>Physiology of Sleep</i>	159
JOLLY, J.— <i>Hæmopoietic Function of Spleen in Embryo Bird</i>	160
" <i>Function of Bursa Fabricii</i>	160
STRECKER, JOHN K., JUN.— <i>Notes on the Robber Frog</i>	160
DEHAUT, E. G.— <i>Heart of Lungless Urodela</i>	160
STRÖMER, ERNST— <i>Fossil Lepidosirenidae</i>	160
FRISCH, KARL VON— <i>Colour-change in Fishes</i>	160
TRACY, H. C.— <i>Swim-bladder of Teleosts</i>	161
CHAMBERS, HELEN, & S. RUSS— <i>Action of Radium Radiations on Blood</i>	611
BOUCHARD, CH.— <i>Sleeping and Waking</i>	611
TRUSCHEL— <i>Sense of Direction in Blind</i>	612
BARTELS, PAUL— <i>Plica semilunaris in Hereros und Hottentots</i>	612
GAUPE, E.— <i>Vertebrate Lower Jaw</i>	612
ALLAN, GLOVER M.— <i>Mammals of West Indies</i>	612
CURL, H. C.— <i>Digestive System of Hornbill</i>	612
SPULSKI, B.— <i>New Species of Odontopteryx</i>	613
JUILLET, A.— <i>Air-sacs in Birds</i>	613
DELEZENNE, C., & S. LEDEBT— <i>Suake-poison and Yolk of Egg</i>	613
SMALLWOOD, W. M., & C. G. ROGERS— <i>Effects of Starvation on Necturus maculatus</i>	613
KENNEL, PIERRE— <i>Corpora adiposa of Amphibians</i>	613
WINTREBERT, P.— <i>Lateral Line System in Tadpoles of Alytes and Rana</i>	614
WOLFF, GUSTAV— <i>Regeneration in Newts</i>	614
FRANZ, V.— <i>Function of Cerebellum in Fishes</i>	614
UNNA, P. G.— <i>Reduction and Oxidation in Animal Tissues</i>	614
BETHE, ALBRECHT— <i>Equilibration in Aquatic Animals</i>	614
HERDMAN, W. A.— <i>Summer Plankton of West of Scotland and Irish Sea</i>	614
HEINIS, FR.— <i>Moss-fauna of Central America</i>	615
PETERSEN, C. G. JOH., & P. BOYSEN JENSEN— <i>Animal Life of Sea-bottom</i>	741
MANDERS, N.— <i>Validity of some Forms of Mimicry</i>	741
TOLDT, K.— <i>Different kinds of Hair</i>	742
GAUPE, E.— <i>Composition of the Lower Jaw</i>	742
TROUSSART, E. L.— <i>Origin of Domestic Dog</i>	743
SCHMALTZ, R.— <i>Reproductive Organs of Domestic Animals</i>	743
VRGHOW, HANS— <i>Mobility of Penguin's Vertebral Column</i>	743
THOMSON, A. LANDSBOROUGH— <i>Migration of Birds</i>	743
CURTIS, MAYNIE R.— <i>Weighing Parts of Eggs</i>	744
PHISALIX, MARIE— <i>Bite of Heloderma</i>	744
ARTHUS, M., & B. STAWSKA— <i>Toxins and Antitoxins</i>	744
KENNEL, P.— <i>Corpora Adiposa of Frog</i>	744
REYMOND, C. DU BOIS— <i>Tadpoles with strongly developed Lips</i>	745
OSHIMA, HIROSHI— <i>Luminous Organs in Fishes</i>	745
WILLIAMSON, H. CHAS.— <i>Ichthyological Notes</i>	746
ELMHIRST, RICHARD— <i>Amibi-coloured Flatfish</i>	746

Tunicata.

DAUMÉZON, G.— <i>Tenuity of Life in Ciona intestinalis</i>	461
--	-----

INVERTEBRATA.

DADAY, E. V.— <i>Fresh-water Microfauna from German East Africa</i>	39
BROCH, HJALMAR— <i>Plankton of Spitzbergen</i>	39
HERDMAN, W. A.— <i>Scottish and Irish Plankton</i>	355
DADAY, E. VON— <i>Micro-fauna of the Nile</i>	355

Mollusca.

NOBRE, A.— <i>Molluscs of Portuguese East Africa</i>	355
STELFOX, A. W.— <i>Molluscs of Ireland</i>	356
COLGAN, NATHANIEL— <i>Marine Molluscs of Clare Island</i>	461
HORWOOD, A. R.— <i>Layers of the Molluscan Shell</i>	746

a. Cephalopoda.		PAGE
HOYLE, W. E.— <i>Genera of Dibranchiate Cephalopoda</i>		196
WÜLKER, G.— <i>Japanese Cephalopods</i>		615
BERRY, S. STILLMAN— <i>New Cephalopods from Hawaiian Islands</i>		746
γ. Gastropoda.		
ODHNER, NILS— <i>Genus Cumanotus</i>		39
VESICHELLI, N.— <i>Structure of Phylliroë bucephala</i>		39
BERGH, R.— <i>Opisthobranchs of South Africa</i>		39
TROJAN, E.— <i>Glands and Luminescence of Phyllirhœ</i>		196
BORN, ERNST— <i>Minute Structure of Phyllirhœ bucephala</i>		196
ROLLE, H.— <i>Abnormal Shells of Achatina</i>		196
DREYER, THOS. F.— <i>Blood-vessels and Nerves of Æolidiæ and Tritoniadæ</i>		196
GERMAIN, L.— <i>Caverniculous Gastropods</i>		356
WOOD, ELVIRA— <i>Phylogeny of Cerithiidæ</i>		356
LANG, ARNOLD— <i>Beating of the Heart in Hibernating Snail</i>		462
LEE, A. BOLLES— <i>Reduction in the Spermatogenesis of the Snail</i>		462
QUINTARET, G.— <i>Abnormality in Snail</i>		462
REED, F. R. COWPER— <i>New Fossil Chiton from Girvan</i>		615
PERRIER, REMY, & HENRI FISCHER— <i>Mantle-cavity and Pallial Organs of Bulleidæ</i>		747
SMIRO, J.— <i>Alimentary Canal of Helix pomatia</i>		747
PETERSEN, C. G. JOH.— <i>Damage to Plaiice-fishing by Whelks</i>		747
δ. Lamellibranchiata.		
DAKIN, W. J.— <i>Visceral Ganglion of Pecten</i>		40
FABRE-DOMERGUE— <i>Cleansing Oysters</i>		40
" " " <i>Feeding Habits of Oysters</i>		40
DREW, G. H., & W. DE MORGAN— <i>Reaction of Tissues of Pecten to Implantation of Foreign Bodies</i>		356
TUR, JAN— <i>Influence of Radium on the Development of Pholas candida</i>		462
ISRAEL, W.— <i>Notes on Fresh-water Mussels</i>		462
SOUTHWELL, T.— <i>Avicula and Gorgonid Association</i>		463
POYARKOFF, E.— <i>Incubation of Cyclas Embryos</i>		463
KOSTANECKI, K.— <i>Artificial Parthenogenesis in Mactra</i>		615
EWALD, W. F.— <i>Contraction of Adductors in Fresh-water Mussels</i>		616
Arthropoda.		
a. Insecta.		
LOVELL, JOHN H.— <i>Colour-sense of Hive-bee</i>		40
BUGNION, E., & N. POPOFF— <i>Scelionid Parasite of Spider's Eggs</i>		41
HOLSTE, GEORG— <i>Nervous System of Dytiscus marginalis</i>		41
SILVESTRI, F.— <i>New Termitophilous Staphylinid</i>		41
KIRCHHOFFER, O.— <i>Eye of Dermestes</i>		41
DEEGENER— <i>Intestinal Secretion in Dytiscus</i>		41
LEA, ARTHUR M.— <i>Beetles in Ants' Nests</i>		42
MEIJERE, J. C. H. DE, & HJ. JENSEN— <i>Insects in Nepenthes Pitchers</i>		42
PÉREZ, CH.— <i>Beginning of Muscular Phagocytosis in Larval Muscids</i>		42
" " " <i>Metamorphosis of Intestinal Musculature in Muscid Larvæ</i>		42
BRINDLEY, H. H.— <i>Habits of Procession Caterpillar</i>		42
COOK, MARGARET HARRIS— <i>Spermatogenesis in Lepidoptera</i>		43
DAMPF, ALFONS— <i>New Flea from Jeriou</i>		43
RUSS, E. L.— <i>Head-glands of Caddis-worms</i>		44
CARPENTER, GEORGE H.— <i>Injurious Insects in Ireland</i>		44
MARCHAL, PAUL— <i>Notes on Chermes pini</i>		44
NEERACHER, FERDINAND— <i>Insects of the Rhine</i>		197
ZANDER, ENOCH, & F. STELLWAAG— <i>Studies on Bees</i>		197

	PAGE
METZER, CHRISTIAN— <i>Junction of Fore-gut and Mid-gut in Hive-bee</i>	197
FRIESE, H., & F. VON WAGNER— <i>Species and Varieties of Humble-bees</i>	197
MAST, S. O.— <i>Blow-fly Larvæ and Gravity</i>	198
PÉREZ, C.— <i>Metamorphosis of Blow-fly</i>	198
ROUBAUD, E.— <i>Oviparity and Viviparity in Dung-fly</i>	198
TÖRNE, OSKAR— <i>Sudorial Disks of Male Dytiscids</i>	198
GÜNTHER, THOMAS— <i>Oogenesis in Dytiscidæ</i>	198
DEIBEL, JOHANNES— <i>Respiration in Donacia and Macroplea</i>	198
JUNBANSCHJANZ, SIMEON— <i>Post-embryonic Development of Stratiomyidæ</i>	199
BÖTTGER, OTTO— <i>Brain of Lepisma</i>	199
HAGEMANN, J.— <i>Study of Corixa</i>	199
POCOCK, R. I.— <i>Mimicry of Ant by Larval Mantis</i>	356
WHEELER, W. M.— <i>North American Species of Camponotus</i>	357
POPOVICI-BAZNOȘANU, A.— <i>Study of Sphegidae</i>	357
DONCASTER, L.— <i>Spermatogenesis in Currant-moth</i>	357
PAIVA, C. A.— <i>Carnivorous Mosquito Larvæ</i>	358
CROSBY, C. R.— <i>Apple Red Bugs</i>	358
HOOPER, DAVID— <i>Secretion of Ghost Bug</i>	358
ANDREWS, E. A., & A. R. MIDDLETON— <i>Rhythms in Termite Communities</i>	463
MERCIER, L.— <i>Insects as Disseminators of Ergot</i>	463
SCHUBERG, A.— <i>Dissemination of Disease by Stomoxys calcitrans</i>	463
LEON, N.— <i>Roumanian Mosquitos</i>	462
KIEFFER, J. J.— <i>East Indian Chironomidae</i>	463
POPOFF, M.— <i>Chromidia in Cells of Muscidae</i>	464
PORTIER, P.— <i>Digestion in Wool-eating Caterpillars</i>	464
CONTE, A., & C. VANÉY— <i>Acephalous Lepidoptera</i>	464
SCHWANGART— <i>Grape Moths</i>	464
MCDERMOTT, F. A., & C. G. CRANE— <i>Photogenic Organs of Lampyridæ</i>	464
SASAKI, C.— <i>Life-history of Schlechtendalia chinensis</i>	465
GRAVELY, F. H.— <i>Degenerate Cockroach</i>	465
NEUMANN, I. G.— <i>Mallophaga from Southern Birds</i>	465
LEWIS, R. T.— <i>Larva of Mantissa</i>	465
KRAUSS, H. A.— <i>Monograph on Embiidae</i>	465
SHELFORD, R.— <i>Blattidæ in Amber</i>	465
HANDLIRSCH, ANTON— <i>New Palæozoic Insects</i>	466
FELT, E. P.— <i>Injurious Insects</i>	466
HOLLANDE, A. CH.— <i>Blood of Insects</i>	616
SULC, KAREL— <i>Symbiosis of Yeasts and Insects</i>	616
DEMOLL, R.— <i>Migration of Iris-pigment in Compound Eye</i>	616
BOARD OF AGRICULTURE— <i>Bee Disease</i>	616
MEEK, C. F. U.— <i>Spermatogenesis of Stenobothrus viridulus</i>	617
WATERSTON, J.— <i>New Flea from South Africa</i>	617
HUFNAGEL, A.— <i>Fatty Body during Metamorphosis</i>	618
RITTER, WOLFGANG— <i>Flying Apparatus of Blow-fly</i>	618
SUMMERS, SOPHIA L. M.— <i>Oriental Species of Stomorox</i>	618
BEZZI, M.— <i>Cave Diptera</i>	618
LEHMANN, N., & C. VANÉY— <i>Occurrence of Ox-warbles</i>	619
ALCOCK, A.— <i>Classification of Culicidæ</i>	619
MARCHAL, PAUL— <i>Parasites of Olive-fly</i>	619
BOUNOUË, L.— <i>Digestive Ferments of Beetles</i>	619
BUGNON, E.— <i>Buccal Parts of a Ceylonese Staphylinid</i>	619
JEANNEL, R.— <i>Revision of Bathysciniæ</i>	620
LESNE, PIERRE— <i>Nutritive Habits of Bostrychidæ</i>	620
ZACHER, FR.— <i>Position and Classification of Protodermaptera</i>	620
SHOEBOTHAM, J. W.— <i>New Collembola in England</i>	620
BOLTON, H.— <i>Insect Remains from South Wales Coalfield</i>	620
STRACHAN, JAMES—1. <i>On the Structure of Scales from Thermobia domestica</i> (Packard). 2. <i>Description of a Model Producing an Optical Effect similar</i> <i>to the Canate Markings on Insect Scales.</i> (Plate XXIV.)	717
BERLESE, ANTONIO— <i>Studies on Injurious Insects</i>	747
KAPZOV, SERGE— <i>Minute Structure of Cuticle in Insects</i>	747
VERSON, E.— <i>Moulting in Silkworms</i>	748

	PAGE
LEA, ARTHUR M.— <i>New Stag-beetles</i>	748
RUNGIUS, H.— <i>Alimentary Canal of Dytiscus</i>	748
GRAVELY, F. H.— <i>Large Egg Laid by a Beetle</i>	748
DUBOIS, R.— <i>Fluorescence in Luminous Insects</i>	748
DONCASTER, L.— <i>Gametogenesis of Gull-fly</i>	748
BRUCE, DAVID, & OTHERS— <i>Tabanids and Trypanosomes</i>	749
RICARDO, GERTRUDE— <i>Revision of Oriental Species of Tabanus</i>	749
LEHMANN, N., & C. VANEY— <i>Influence of Weather Conditions on Frequency of Warbles</i>	749
BROWN, J. M.— <i>Respiration and Circulation in Tipula maximi</i>	749
GRAVELY, F. H.— <i>Mosquito sucked by Midge</i>	750
TILEYARD, R. J.— <i>Experiments with Dragon-fly Larvæ</i>	750
ZANARZIN, A.— <i>Histological Study of the Innervation of the Heart of Larval Dragon-fly</i>	750
BUGNION, E., & N. POPOFF— <i>Buccal Apparatus of Hemiptera</i>	750
BUFFA, PIETRO— <i>Study of a Thrips</i>	750
WESENBERG-LUND, C.— <i>Study of Phryganea grandis</i>	750
MJÖRBERG, ERIC— <i>Studies on Mallophaga and Anoplura</i>	751

β. Myriopoda.

BRÖLEMANN, H. W.— <i>Cavernicolous Myriopoda</i>	44
REINECKE, GEORG— <i>Study of Polyrenus</i>	199
BALDWIN, W.— <i>British Carboniferous Myriopods</i>	200
HIRST, S.— <i>New Termitophilous Millipede</i>	621
CHALANDE, JULES— <i>Doubling of Segments in Myriopods</i>	621
VERHOEFF, KARL W.— <i>Studies on Millipedes</i>	752
D'HERCULAIS, J. KÜNCKEL— <i>Habits of Scutigera coleoptrata</i>	752

γ. Prototracheata.

ANDREWS, E. A.— <i>Jamaica Peripatus</i>	466
BRUES, CHARLES T.— <i>New Species of Peripatus from Grenada</i>	752

δ. Arachnida.

COMSTOCK, J. H.— <i>Palpi of Male Spiders</i>	44
NEUMANN, L. G.— <i>New Ixodidae</i>	44
ELMASSIAN, M.— <i>Salivary Glands of Ticks</i>	45
SWEET, GEORGINA— <i>New Species of Argas</i>	45
COLE, LEON J.— <i>Pacific Pycnogonids</i>	45
" " <i>Notes on Endeis spinosus</i>	45
PETRUNKEVITCH, A.— <i>Circulatory System of Lyrost carolinensis</i>	200
REUTER, ENZIO— <i>Mites and Tunnours</i>	200
SOAR, CHARLES D.— <i>Hydrachnids of East African Lakes</i>	200
ELMHIRST, RICHARD— <i>Pycnogonids of Clyde Area</i>	200
BUGNION, E.— <i>Pentastomum of Python</i>	200
FREUND, LUDWIG— <i>Ear Mite of Cattle</i>	359
KEW, H. WALLIS— <i>False Scorpions of British Isles</i>	359
JOHNSTON, E. A.— <i>New Species of Linguatula</i>	359
MURRAY, JAMES— <i>Antarctic and other Tardigrada</i>	359
LUDMILA & WLADIMIR SCHIMKEWITSCH— <i>Development of Tetrapneumones</i>	466
POCOCK, R. I.— <i>Carboniferous Arachnida</i>	467
SCHTSCHELKANOWZEW, J. P.— <i>Male Reproductive Organs of Chelifer and Chernes</i>	467
CARPENTER, G. H.— <i>Sudanese Pycnogonids</i>	467
BOUVIER, E. L.— <i>New Decapod Pycnogonid</i>	467
SHIPLEY, A. E.— <i>New Pentastomid</i>	468
MURRAY, JAMES— <i>Notes on Tardigrada</i>	468
LUDMILA & W. SCHIMKEWITSCH— <i>Development of Ischnocolus</i>	621
HALBERT, J. N.— <i>Fresh-water Mites of Clare Island</i>	621

Annulata.

	PAGE
PÉREZ, CH.— <i>Cuticular Warts of Pylarix ferrucosa</i>	47
ELWES, E. V.— <i>Littoral Polychæta of Torquay</i>	48
HURWITZ, S. H.— <i>Reactions of Earthworms to Acids</i>	48
MICHAELSEN, W.— <i>Caucasian Earthworms</i>	48
MARTHIS, LUIGI COGNETTI DE— <i>Internal Fertilization in Parendrilus</i>	202
HÖNIG, JOSEF— <i>Neurochords of Criodrilus</i>	202
STAFF, FRANZ— <i>Development of Criodrilus lacuum</i>	202
ASHWORTH, J. H.— <i>Stultis on Arenicolidae</i>	202
" " <i>Arenicola loveni</i>	203
MICHEL, AUG.— <i>Precision of Regeneration in Polychæts</i>	203
HACKLOV, L.— <i>Sensilli and Eyes of Medicinal Leech</i>	203
RITTER-ZAHONY, RUDOLF VON— <i>Chaetognathu from Ireland</i>	203
" " <i>West Indian Chaetognatha</i>	204
COVENTRY, A. F.— <i>Theory of Dwarf Males in Myzostoma</i>	204
SOUTHERN, R.— <i>Pelagic Polychæts of Irish Seas</i>	360
MCINTOSH, W. C.— <i>Notes on Polychæts</i>	360
DEBSHAWIN, A.— <i>Polychæt from the Delta of the Volga</i>	360
SHEARER, CRESWELL— <i>Development of Trochophore of Hydroides</i>	360
SOLLAS, IGERNA B. J.— <i>Parasitic Castration of Earthworms</i>	360
JOHANNSON, L.— <i>Extra-enteric Aperture in a Leech</i>	361
STEPHENSON, J.— <i>Oligochæt Commensals in Spongilla carteri</i>	469
" " <i>Bothrion iris</i>	469
HARDING, W. A.— <i>New Leech from Egypt</i>	470
SCRIBAN, J. A.— <i>Adipose Cells of Pontobella muricata</i>	624
BUCHANAN, GWYNNETH, & OTHERS— <i>Studies on Australian Earthworms</i>	624
BIALKOWSKA, WANDA, & ZOFIA KULIKOWSKA— <i>Nerve-cells of Leech and Earthworms</i>	624
HEINEN, ADOLPH— <i>Nephtyidæ and Lycoriidæ of the North Sea and the Baltic</i>	624
MESNIL, F., & M. CAULLERY— <i>Papillomatous Neo-formati n in an Annelid</i>	625
SOKOLOV, IWAN— <i>New Species of Ctenodrilus</i>	625
FRIEND, HILDERIC, THE REV.— <i>New British Euchytræids</i>	730
NÄNNI, JAKOB— <i>Structure of Tomopteris</i>	758
GRAVIER, CH.— <i>Incubation in Polychæts</i>	758
ARWIDSSON, IVAR— <i>Irish Maldanidæ</i>	758
STEPHENSON, J.— <i>Littoral Oligochaeta of the Clyde</i>	758

Nematohelminthes.

SWEET, GEORGINA— <i>New Nematode in Eye of Queensland Fowl</i>	48
GILRUTH, J. A., & OTHERS— <i>Microfilaria in Magpies</i>	48
BUCHANAN, GWYNNETH— <i>Supposed Nematode in Circular Muscle of an Earthworm</i>	48
EDWARDS, C. L.— <i>Idiochromosomes in Ascaris</i>	204
GLAUE, H.— <i>Comparison of Ascaris felis and A. canis</i>	205
HELLEMANS, J.— <i>Strongylus pingucicola</i>	205
EMILE-WEIL, E., & G. BOYÉ— <i>Anti-coagulant Action of Nematode Extract</i>	205
RAILLIET, A., & A. HENRY— <i>Ascariids of Carnivores</i>	361
MAN, J. G. DE— <i>Anguillulidæ of the White Stime of Oaks</i>	361
MATHIS, C., & M. LEGER— <i>Microfilarie in Tonkin Birds</i>	361
MANDEL, H.— <i>Blood-filaria in Horse</i>	470
RAILLIET, G.— <i>Oxyuris in the Appendix vermiformis</i>	470
GOLDSCHMIDT, R.— <i>Nervous System of Ascaris</i>	470
BOVERI, TH.— <i>Potency of Blastomeres in Ascaris</i>	625
BERKÉ— <i>Microfilaria from a Fowl</i>	625
ROMIEU, MARC— <i>Plasmic Reduction in Spermatogenesis of Ascaris megalocephala</i>	625
CLELAND, J. B., & T. H. JOHNSTON— <i>Worm-nests in Australian Cattle</i>	626
BLANC, G., & L. CAUCHEMEZ— <i>New Species of Echinorhynchus</i>	626
HIGT, NOORDHOECK J.— <i>New Nematode</i>	759
HIDA, S.— <i>Structure of Filaria bancrofti</i>	759
GIRGOLAFF, S. S.— <i>Compression Experiments with the Fertilized Ovary of Ascaris megalocephala</i>	759
MEVES, FR.— <i>Role of Plastochondria in Fertilization of Ascaris megalocephala</i>	759
BRUMPT, E.— <i>Nematodes in Deer</i>	760

Platyhelminthes.

	PAGE
RILEY, W. A.— <i>Dipylidium caninum</i> in a Child	49
LÜHE, M.— <i>Tapeicorms</i> of South American <i>Felidæ</i>	49
SWEET, GEORGINA— <i>New Tapeicorm</i> in Chicken	49
JOHNSTONE, JAMES— <i>Parasites</i> from Irish Sea Fishes	49
NICOLL, W.— <i>Entozoa</i> from Clyde Fishes	49
JACUBOWA, LYDIA— <i>New South African Polyelud</i>	50
LINTON, EDWIN— <i>Trematodes</i> from Tortugas	205
DIETZ, EUGEN— <i>Echinostomidæ</i> of Birds	205
LÜHE, M.— <i>Cystotaxiæ</i> of South African <i>Felidæ</i>	206
LINTON, EDWIN— <i>Flesh-parasites</i> of Food-fishes	206
.. .. . <i>New Commensal Turbellarian</i>	206
DU PLESSIS, G.— <i>Hermaphroditism</i> in Nemerteans	206
NUSBAUM, JOZEF, & M. OXNER— <i>Regeneration</i> in Nemerteans	206
ZARNIK, B.— <i>Life-cycle</i> of <i>Dicrocoelium linceatum</i>	361
GOUGH, L. H.— <i>Stilisia</i> and its Relatives	362
SOUTHWELL, T.— <i>Pearl-inducing Parasite</i>	470
.. .. . <i>New Cestodes</i> from Ceylonese Fishes	471
ROSSETER, T. B.— <i>New Tapeicora</i> from a Duck	471
NICOLL, W., & E. A. MINCHIN— <i>Cysticeeroids</i> from Rat-flea	471
NICOLL, W.— <i>Gasterostomum tergestinum</i>	471
BERKÉ— <i>Horse Parasites</i> in Cameroon	471
HALLIZ, PAUL— <i>Non-parasitic Bdelloid</i>	471
.. .. . <i>Excretory System</i> of <i>Bothriomolus</i>	471
WAHL, BRUNO— <i>Dalyellidæ</i> and <i>Umaquillidæ</i>	472
GUERRINI, GUIDO— <i>Alleged Toxicity</i> of <i>Tapeicorms</i>	626
JOHNSTON, T. HARVEY— <i>Structure</i> of <i>Monopygidium passerinum</i>	626
STEINMANN, P.— <i>Regeneration</i> in Planarians	626
BERNINGER, J.— <i>Effects</i> of Starvation on Planarians	627
STEINMANN, PAUL— <i>Revision</i> of Swiss Tricladæ	627
GERING, G.— <i>Malacobolella grossa</i>	627
JOHNSTON, T. HARVEY— <i>Entozoa</i> in Australian Birds	760
SOLOWIOW, PAUL— <i>Tapeicorms</i> of Birds	760
HALL, C. M.— <i>Gid Parasite</i>	760
BEDDARD, F. E.— <i>Tapeicorms</i> from Mammals	760
JOHNSTONE, JAS.— <i>Parasites</i> of Fishes	760
HALLEZ, PAUL— <i>Two-fold Function</i> of <i>Ovaries</i> in some <i>Polyeluds</i>	761
KEILKEI, V. H.— <i>Regeneration</i> in Short Head-pieces of <i>Planaria</i>	761
STEPHENSON, J.— <i>Nemertines</i> of Millport	761
MORSE, MAX WITHROW— <i>Experiments</i> in <i>Ora</i> of <i>Cerobratalus</i>	762

Incertæ Sedis.

GILCHRIST, J. D. F.— <i>New Hemicorda</i> from South Africa	50
ROEBRICH, O.— <i>New Species</i> of <i>Acyonidium</i>	51
MAPLESTONE, C. M.— <i>Growth and Habits</i> of <i>Biporæ</i>	51
SCHRÖDER, OLAW— <i>New Mesozoon</i>	51
BUDDENBROCK, WOLFGANG VON— <i>Development</i> of the <i>Statoblasts</i> of <i>Bryozoa</i>	207
NICHOLS, A. R.— <i>Irish Polyzoa</i>	382
CALVERT, LOUIS— <i>New Mediterranean Bryozoa</i>	762
RITCHIE, JAMES— <i>Barentsia benedeni</i> in British Waters	762
KÖHLER, W.— <i>Plectinatella magnifica</i> near Berlin	763

Rotifera.

MURRAY, J.— <i>Some African Rotifers: Bdelloida of Tropical Africa.</i> (Plates I., II.)	1
.. .. . <i>Australian Rotifera: Collected by the Shackleton Antarctic Expedition, 1909.</i> (Plates IV., V.)	164
BRYCE, D.— <i>Bdelloid Rotifera: a New Classification</i>	207

	PAGE
FÜLLEBORNE, F.— <i>Rotifera of German East Africa</i>	208
MURRAY, J.— <i>Canadian Rotifera: Collected by the Shackleton Antarctic Expedition, 1909. (Plates VI.—VIII.)</i>	285
HIRSCHFELDER, GUSTAV— <i>Histology of Rotifera</i>	362
BEAUCHAMP, P. DE— <i>Dipleuchlanis, a new Sub-genus for Euchlanis (Diplois) propatula Gosse</i>	363
MURRAY, J.— <i>Rotifera of Some Pacific Islands: Collected by the Shackleton Antarctic Expedition, 1909. (Plates XIV., XV.)</i>	429
„ <i>Rotifera of New Zealand: Collected by the Shackleton Antarctic Expedition, 1907. (Plates XVI., XVII.)</i>	573
„ <i>South African Rotifera: Collected by the Shackleton Antarctic Expedition, 1907. (Plate XVI.)</i>	584
„ <i>Clare Island Rotifers</i>	627
ROUSSELET, C. F.— <i>New Rotifera</i>	763
„ „ <i>Clare Island Rotiferu</i>	763

Echinoderma.

CLARK, H. L.— <i>Echinoderms of Peru</i>	51
PÉREZ, CH.— <i>Seasonal Retrogression of Ovaries in Starfish</i>	52
EDWARDS, C. L.— <i>Species of Cucumaria</i>	52
MORTENSEN, TH.— <i>West Indian Echinoids</i>	209
HAWKINS, H. L.— <i>Teeth and Buccal Structures in Conulus</i>	209
SLUITER, C. PH.— <i>West Indian Holothuroids</i>	209
PEARSON, JOSEPH— <i>Holothuroids from the Indian Ocean</i>	209
BECHER, S.— <i>Studies on Holothurians</i>	209
KOEHLER, R.— <i>New Starfishes</i>	210
WANNER, J.— <i>Remarkable Permian Echinoderm</i>	210
YATSU, NAOHIDE— <i>Extra-ovate Experiments on Sea-urchin Ova</i>	363
TENNENT, D. H.— <i>Echinoderm Hybridization</i>	363
SCHAXEL, JULIUS— <i>Early Stages of Development in Echinoderms</i>	363
TENNENT, D. H., and V. H. KELLER— <i>Structure of Pentaceros reticulatus</i>	364
YATSU, NAOHIDE— <i>Polarity of Primary Oocyte of Asterias forbesii</i>	472
CLARK, H. L.— <i>North Pacific Ophiurans</i>	472
„ „ <i>Genera of Recent Clypeastroïds</i>	472
CLARK, A. H.— <i>New Unstalked Crinoid</i>	473
GEMMILL, JAMES F.— <i>Structure of Solaster endeca</i>	628
WALCOTT, C. D.— <i>Middle Cambrian Holothurians</i>	628
CLARK, A. H.— <i>Comparative Age of Recent Crinoid Faunas</i>	629
CLARK, AUSTIN HOWARD— <i>New European Crinoid</i>	763
„ „ <i>Recent Crinoids of Australia</i>	763

Cœlentera.

RITCHIE, JAMES— <i>Deep-sea Hydroids of Indian Museum</i>	52
BROCH, HJALMAR— <i>New Genus of Hydroids</i>	52
CARPENTER, F. W.— <i>Feeding Reactions of the Rose-coral</i>	53
WALTON, CHAS. L.— <i>Kodioides</i>	53
CARRUTHERS, R. G.— <i>Evolution of Zaphrentis delanouei</i>	54
KÜKENTHAL, W.— <i>West Australian Aleyonarians</i>	54
„ „ <i>Genus Anthomastus</i>	54
MÜLLER, ROBERT— <i>Rhizoxenia and Sarcodictyon</i>	55
„ „ <i>Formation of Axis of Corallium</i>	55
NUTTING, C. C.— <i>Plexaurids of 'Siboga' Expedition</i>	55
„ „ <i>Isidæ of 'Siboga' Expedition</i>	55
„ „ <i>Gorgonidæ of 'Siboga' Expedition</i>	55
„ „ <i>Gorgonellids of 'Siboga' Expedition</i>	55
HICKSON, SYDNEY J.— <i>New Octocoralliate Coral</i>	210
BEDOT, M.— <i>History of the Study of Hydrozoa</i>	210

	PAGE
TORREY, H. B.— <i>Regeneration in Corymorpha</i>	210
PAX, FERDINAND— <i>Studies of Actinians</i>	211
TORREY, H. B.— <i>Geotropism in Corymorpha</i>	211
TORREY, H. B., & A. L. MARTIN— <i>Senescence in Hydroids</i>	211
<i>Effect of Light on Obelia</i>	212
THOMSON, J. ARTHUR, & DORIS L. MACKINNON— <i>Australian Aleyonarians</i>	364
KINOSHITA, KUMAO— <i>Keraoididæ</i>	364
BROCH, HJALMAR— <i>Australian Pennatulids</i>	365
TORREY, H. B.— <i>Regeneration in Corymorpha</i>	365
BROCH, HJALMAR— <i>Hydroids of Drobak</i>	365
DESHAWIN, A.— <i>Polypodium hydriforme</i>	365
BILLARD, A.— <i>New Plumularid Genus</i>	365
SCHAXEL, JULIUS— <i>Oogenesis in Pelagia</i>	473
HÉROUARD, E.— <i>Fixation of Scyphistoma</i>	473
GÜNTHER, SIEGMUND— <i>History of Study of Coral-formations</i>	473
KINOSHITA, KUMAO— <i>New Genus of Antipatharia</i>	473
STECHE, O.— <i>Law of Budding in "Portuguese Man-of-war"</i>	473
ISSAKOWITSCH, A.— <i>Marginal Glands of Porpita</i>	474
MOTZ-KOSSOWSKA, S.— <i>Mediterranean Species of Halecium</i>	474
GOTO, SEITARO— <i>Hydractinia and Hermit-crab</i>	474
WILSMORE, LEONORA J.— <i>Hexactinidæ from New South Wales</i>	629
WALCOTT, C. D.— <i>Middle Cambrian Medusa</i>	629
WIETRZYKOWSKI, W.— <i>Development of Lucernarians</i>	629
BOULENGER, C. L.— <i>Notes on Structure and Budding of Limnocnida</i>	629
KÜHN, A.— <i>Structure and Affinities of Thyrozyphus</i>	630
HANITSCH, P.— <i>Development of Cuvonia parisitica</i>	764
HICKSON, S. J.— <i>New Type of Aleyonarian</i>	764
KÜENTHAL, W., & HJ. BROCH— <i>Pennatulacea</i>	765
CALMAN, W. T.— <i>Epizoid Hydroid on Crab</i>	765
BILLARD, A.— <i>'Siboga' Plumularids</i>	765
MORSE, MAX W.— <i>Polarity in Tubularia</i>	765

Porifera.

MAAS, O.— <i>Regeneration in Chondrosia reniformis</i>	56
TAYLOR, T. GRIFFITH— <i>Archæocyathinæ</i>	56
KIRKPATRICK, R.— <i>Hexatinellid Spicules</i>	212
KIRKPATRICK, R.— <i>Remarkable Phaceloid Sponges</i>	365
MAAS, O.— <i>Degenerative Changes in Sponges</i>	630
KIRKPATRICK, R.— <i>Merlia</i>	630
<i>New Lithonine Sponge from Christmas Island</i>	631
WELTER, O. A.— <i>Phaceloid Sponges of Essen Greensand</i>	631
WILSON, H. V.— <i>Development of Sponges from Dissoiated Cells</i>	766
TOPSENT, E.— <i>Classification of Halichondrina</i>	766
ANNANDALE, N.— <i>Sponges Associated with Vermetidæ</i>	766

Protozoa.

CHAPMAN, FREDERICK— <i>Foraminifera from Funafuti</i>	56
BROCH, HJALMAR— <i>Peridinium Plankton at Rovigno</i>	57
CHATTON, E.— <i>Parasitic Dinoflagellate</i>	57
GILRUTH, J. A., & OTHERS— <i>Blood Parasites</i>	57
GILRUTH, J. A.— <i>Protozoan Parasite from Mucous Membrane of Sheep's Abomasum</i>	57
<i>Hemogregarine in Blood of Varanus varius</i>	57
MACKINNON, DORIS L.— <i>Protist Parasites from Intestine of Trichoptera</i>	57
<i>Herpetomonads from Dung-flies</i>	57
GROSS, J.— <i>Cristispha and Spirocha</i>	58
STRICKLAND, C., & N. H. SWELLENGREBEL— <i>Development of Trypanosoma lewisi in Rat Flea</i>	58
PÉREZ, CH.— <i>New Microsporidium from Termite</i>	58
SIDEBOTTOM, HENRY— <i>New Species of Cassidinina</i>	212
STANIEWICZ, WITOLD— <i>Fat in Ciliated Infusorians</i>	212

	PAGE
CHATTON, E.— <i>New Flagellate in Pelagic Copepod</i>	212
CÉPÈDE, E.— <i>Astomatous Infusorians</i>	213
MATHIS, C., & M. LEGER— <i>Studies on Trypanosomes</i>	213
AUERBACH, M.— <i>Cnidosporidia</i>	213
LÉGER, L., & O. DEBOSCQ— <i>Selenococcidium and the Relationships of the Sporozoa</i>	213
LAVERAN, A., & A. PETTIT— <i>Hæmogregarines</i>	214
LEBEUF, A., & RINGENBACH— <i>Hæmatozoa from the Congo</i>	214
HERON-ALLEN, E., & A. EARLAND— <i>On the Recent and Fossil Foraminifera of the Shore-sands of Selsey Bill, Sussex—VII. Supplement (Adlenda et Corrigenda)</i> . (Plates IX.—XIII.)	298
HERON-ALLEN, E., & A. EARLAND— <i>Studies on British Foraminifera</i>	366
PENARD, EUGÈNE— <i>Antarctic Rhizopods</i>	366
MAST, S. O.— <i>Reactions of Amœba to Light</i>	366
LEWIN, K. R.— <i>Experiments on Paramecium</i>	366
LIPSKA, IRENE— <i>Effect of Iuauition on Paramecium</i>	366
WOODRUFF, L. L.— <i>Two Thousand Generations of Paramecium</i>	367
BOUET, G., & E. ROUBAUD— <i>Leptomonad in Euphorbias</i>	367
CHATTON, E., & A. LEGER— <i>Trypanosome and Leptomonad in Drosophila</i>	368
GRIFFIN, L. E.— <i>Structure of Euplotes</i>	368
“ “ <i>Division of Euplotes worcesteri</i>	368
MATHIS, C., & M. LEGER— <i>Species of Leucocytozoon</i>	368
ALEXIEFF, A.— <i>Intestinal Flagellates of Marine Fishes</i>	369
MATHIS, C., & M. LEGER— <i>Spirochaet from the Rabbit</i>	369
NUTTALL, G. H. F., & C. STRICKLAND— <i>Parasites of Biliary Fever in Horses</i>	369
DOBELL, C. CLIFFORD— <i>Affinities of Spirochaets</i>	369
GERBER, P.— <i>Spirochaets of the Mouth</i>	369
CLELAND, J. BURTON, & T. HARVEY JOHNSTON— <i>Hæmatozoa of Australian Birds</i>	369
HADLEY, P. B.— <i>Coccidiosis in Sparrows and other Wild Birds</i>	369
HERON-ALLEN, E., & A. EARLAND— <i>On the Recent and Fossil Foraminifera of the Shore-sands of Selsey Bill, Sussex—VIII. Tabular List of Species and Localities</i>	436
ALEXIEFF, A.— <i>Studies on Amœba</i>	474
“ “ <i>Division in Amœba punctata</i>	474
“ “ <i>Division and Encystation of Amœba limax</i>	474
ERDMANN, RIL.— <i>Depression and Apogony in Amœba diploidea</i>	475
BROWN, JAMES M.— <i>Rhizopods from Lake District</i>	475
CAULLERY, MAURICE— <i>Notes on Marine Heliozoon</i>	475
MOROFF, TH.— <i>Vegetative and Reproductive Processes in Thalassicola</i>	475
DOBELL, C. C.— <i>Hæmocystidium of the Gecko</i>	475
MINCHIN, E. A.— <i>New Parasite of Rat-flea</i>	476
BRUCE, DAVID, & OTHERS— <i>Inquiry into Sleeping Sickness</i>	476
MACKINNON, DORIS L.— <i>Protozoan Parasites from Trichoptera</i>	476
KLEINE, F. K., & M. TAUTE— <i>Trypanosome Studies</i>	476
LEBEDEF, W.— <i>Trypanosoma rotatorium Gruby</i>	476
CHATTON, E., & B. COLLIN— <i>New Type of Suctorina on a Copepod</i>	477
HARTMANN, MAX— <i>New Trichonympha</i>	477
LAVERAN, A., & L. NATTAN-LARRIER— <i>Leucocytozoon in Fish-eagle</i>	477
LAVERAN, A., & A. PETTIT— <i>New Hæmogregarine from the Horned Asp</i>	477
AUERBACH, M.— <i>Distribution of Mycosporidia</i>	477
SWARCZEWSKY, B.— <i>Lauksteria</i>	477
STOLC, ANTONIN— <i>Studies on Pelomyxa</i>	631
“ “ <i>Encystation in Pelomyxa</i>	631
FAURÉ-FREMIET, E.— <i>“Trichites” in Didinium</i>	632
ALEXIEFF, A.— <i>Notes on Flagellates</i>	632
LAVERAN, A.— <i>Classification of Trypanosomes in Mammals</i>	632
KOIZUMI, M.— <i>Frog Trypanosomes in Japan</i>	632
MATHIS, C., & M. LEGER— <i>Trypanosomes in Fresh-water Fishes</i>	632
MARTIN, C. H., & MURIEL ROBERTSON— <i>Cæcal Parasites of Fowls</i>	632
LEVADITI, C.— <i>Cilium of Treponema pallidum</i>	633
DUNKERLY, J. S.— <i>Leptomonad of the House-fly</i>	633
CLELAND, J. BURTON, & T. HARVEY JOHNSTON— <i>Hæmatozoa of Australian Batrachians</i>	633

BOTANY.

GENERAL.

Including the Anatomy and Physiology of Seed Plants.

Cytology,

Including Cell-Contents.

	PAGE
GATES, R. R.— <i>Chromosome-reduction in Oenothera</i>	370
" " <i>Chromosomes of Oenothera Mutants and Hybrids</i>	370
SCHILLER, J.— <i>Life-history and Physiology of Nuclei</i>	478
LAWSON, A. A.— <i>Synapsis of the Nucleus</i>	478
BEAUVERIE, J.— <i>Mycoplasma Hypothesis and Metachromatic Corpuscles</i>	479
VOUK, V.— <i>Movements of Plasmodia</i>	479
LEWITZKY, G.— <i>Chromriosomes in Plant-cells</i>	479
GRANIER, J., & L. BOULE— <i>Heterogamic gemini in Impatiens</i>	480
SCHULZE, E., & M. PFENNINGER— <i>Carbohydrates in Seeds</i>	480
SHEPPARD, E. J.— <i>The Re-appearance of the Nucleolus in Mitosis.</i> (Plate XIX) ..	598
LEPESCHKIN, W. W.— <i>Structure of Protoplasm</i>	636
" " <i>Chemical Composition of the Plasma-membrane</i>	636
ZALESKI, W.— <i>Function of Nucleoprotein</i>	637
MEYER, A.— <i>Chondriosomes in Plant-cells</i>	637
BÖNICKE, L. V.— <i>Heterotypic Division of Pollen-mother-cells</i>	637
LAKON, G.— <i>Starch-grains and Oil-drops in Conifer-wood</i>	638
PALLADINE, W., & P. IRAKLIONOFF— <i>Peroxydase and Respiratory Pigments</i> ..	638
SZÜCS, J.— <i>Permeability of Protoplasm</i>	773
GUILLIERMOND, A.— <i>Formation of Chloroleucites</i>	773
" " <i>Mitochondries of Plant-cells</i>	773

Structure and Development.

Vegetative.

CORDEUROY, H. JACOB DE— <i>Clusiaceae of North-west Madagascar: the Influence of the Soil upon their Secretory Apparatus</i>	59
DUFOUR, LÉON— <i>Observations on Primary Leaves</i>	215
CHERMEZON, H.— <i>Anatomical Researches on Sea-side Plants</i>	216
CHAUVEAUD, G.— <i>Transitory Tissues in Vascular Plants</i>	216
NOELLE, W.— <i>Anatomy and Morphology of Roots of Conifers</i>	371
BLODGETT, M.— <i>Origin and Development of Bulbs in the Genus Erythronium</i>	371
HENMENWAY, A. F.— <i>Phloem of Juglandaceæ</i>	480
CHAUVEAUD, G.— <i>Evolution of Conducting-tissues of Vascular Plants</i>	638
BOSHART, K.— <i>Leaf-symmetry and Ecotrophy</i>	639
FRIES, R. E.— <i>Monocotyledonous Characters in the Polycarpeæ</i>	640
KINGSLEY, M. A.— <i>Splitting of Rhizome and Root of Delphinium</i>	774
BERRY, EDWARD WILBER— <i>Epidermal Characters of Frenelopsis ramosissima</i> ..	774

Reproductive.

ANDREWS, FRANK M.— <i>Embryo-sac Development in Hybanthus concolor</i>	218
CAPITAINE, LOUIS— <i>Seeds of European Papaveraceæ</i>	218
MODILEWSKI, J.— <i>Embryology in Euphorbiaceæ</i>	372
LIGNIER, O., & A. TISON— <i>Gnetales as Apetalous Angiosperms</i>	372

	PAGE
Miyake, K.— <i>Gametophytes and Embryogeny in Cunninghamia</i>	481
Hannig, E.— <i>Significance of the Periplasmodium</i>	481
Hague, S. M.— <i>Morphology of Diospyros</i>	610
Hillmann, A.— <i>“Hypanth” of the Rosaceæ</i>	640
Dessiatoff, N.— <i>Embryo-sac of Euphorbia</i>	641
Sorensen, W.— <i>Fruit of Geraniaceæ</i>	641
Nicoloff, Th.— <i>Ovule and Embryo-sac of the Platanaceæ</i>	775

Physiology.

Nutrition and Growth.

Zach, Franz— <i>Occurrence of Plagocytosis in the Root-nodules of Cycads</i>	60
Jacobi, Helene— <i>Effect of Injury to the Cotyledons upon Seedling Development</i>	60
Colin, H., & I. de Ruzf Lavisson— <i>Absorption by Plants of Alkaline Earth Salts</i>	218
Atkins, W. R. Gelston— <i>Cry-scopic Determination of Osmotic Pressure in certain Plant-organs</i>	219
Doposcheg-Uhlar, J.— <i>Regeneration and Polarity of Plant-organs</i>	219
Deleano, N. T.— <i>Removal of Starch through the Petiole</i>	573
Lavisson, J. de Ruzf de— <i>Mineral Nutrition of Vascular Plants</i>	482
Overton, J. B.— <i>Living Cells in Relation to Transpiration and Sap-flow</i>	482
Schreiner, O., & M. X. Sullivan— <i>Reduction by Roots</i>	483
Gerber, M.— <i>Latex Diastases of Broussonetia</i>	483
Molisch, H.— <i>Liberation of Iron by Green Water-plants</i>	484
Schroeder, H.— <i>Permeability of the Sheath in Wheat-grains</i>	642
Fernbach, A., & M. Schoen— <i>Action of Protoclytic Diastases</i>	642
Combes, R.— <i>Opinions upon Physiology of Leaf-fall</i>	776
Dangeard, P. A.— <i>Complementary Chromatic Adaptation in Plants</i>	776

Irritability.

Pennington, L. H.— <i>Effect of Longitudinal Compression upon the Production of Mechanical Tissues in Stems</i>	373
Woycicki, Z.— <i>Mechanism of Movement in Gramineæ</i>	374
Pouquet, J.— <i>Action of Ultra-violet Rays upon Green Vanilla-pods</i>	484
Beauverie, J.— <i>Osmotic Pressure, and the Form and Structure of Plants</i>	484
Hempel, J.— <i>Effect of Etherization on Metabolism</i>	776

General.

Dixon, H. B.— <i>Edward Perceval Wright</i>	61
Brown, H. B.— <i>Cratægus: Some Theories concerning the Origin of its Species</i>	220
Westerg, P. G.— <i>Pollination Experiments with Anonas in South Florida</i>	374
BIBLIOGRAPHY	375
Bequerel, P.— <i>Traumatism in Relation to New Plant-forms</i>	485
Dubard, M.— <i>Remarks on Strephonema</i>	485
Fitting, H.— <i>Premature Fall of the Perianth</i>	485

CRYPTOGAMS.

Pteridophyta.

Scott, D. H.— <i>Studies in Fossil Ferns</i>	61
Bertrand, T.— <i>Zygopteridæ</i>	61
Bertrand, P.— <i>Stipes of the Fossil Asterochloa</i>	61
Zaleski, M.— <i>Lepidostrobos Bertrandi</i>	62
Gordon, W. T.— <i>Lepidophloios Scottii</i>	62
Horwood, A. R.— <i>Calamites compared with Equisetum</i>	62
Holloway, J. E.— <i>Anatomy of New Zealand Lycopodiaceæ</i>	62

	PAGE
BERRY, E. W.— <i>Fossil Lycopodium</i>	62
DRUERY, C. T.— <i>British Fern-varieties</i>	63
LITARDIÈRE, R. DE— <i>New Hybrid Asplenium</i>	63
CHRIST, H.— <i>Mexican Ferns</i>	63
ROVIROSA, J. N.— <i>Ferns of South Mexico</i>	63
WINKLER, H.— <i>Ferns of Borneo</i>	64
OLIVER, R. B.— <i>Ferns of the Kernadec Islands</i>	64
JEFFREY, E. C.— <i>Pteridophytal Origin of so-called Algal Coals</i>	221
CLUTE, W. N.— <i>Nomenclature of Nephrodium</i>	221
LITARDIÈRE, R. DE— <i>Fern-flora of Spain and Portugal</i>	222
ROSSI, L.— <i>Ferns of South Croatia</i>	222
HILL, E. J., & OTHERS— <i>Ferns of North America</i>	222
CHRISTENSEN, C.— <i>Ferns of Temperate South America</i>	223
HICKEN, C. M.— <i>Ferns of Argentina</i>	223
BRAUSE, G., & G. HIERONYMUS— <i>Ferns of German Central Africa</i>	223
MATSUMURA, J.— <i>New Japanese Ferns</i>	223
SINNOTT, E. W.— <i>Evolution of the Filicinean Leaf-trace</i>	376
CHARLES, G. M.— <i>Anatomy of Marattia</i>	377
SCHMIDT, W.— <i>Mechanism by which Fern Fronds roll up</i>	378
JEFFREY, E. C.— <i>Pteropsida</i>	378
KIDSTON, R., & D. T. GWYNNE-VAUGHAN— <i>Fossil Osmundaceæ</i>	379
SHIBATA, K.— <i>Chemotaxis of Fern-spermatozoids</i>	379
TAVEL, F. VON— <i>Mutations of Asplenium ruta-muraria</i>	379
CLUTE, W. N., & OTHERS— <i>North American Ferns</i>	379
SCHLUMBERGER, O.— <i>Relation of Woodsiæ to Cyatheaceæ and Polypodiaceæ</i>	486
BENEDICT, R. C.— <i>Genera of Vittariæ</i>	487
SHREVE, F.— <i>Hymenophyllaceæ in relation to Moisture</i>	487
HANNIG, E.— <i>Significance of the Periplasmodium</i>	488
CHODAT, R.— <i>Lepidodendron Brownii</i>	488
THOMAS, H. H.— <i>Leaves of Calamites</i>	488
RENIER, A.— <i>Calamotachlys Lubrigii</i>	489
JONGMANS, W.— <i>Calamites undulatus</i>	489
BERRY, E. W.— <i>Schizeopsis expansa, a Fossil Fern</i>	489
QUEVA, C.— <i>Anatomical Study of Azolla filiculoides</i>	490
KINDT, A.— <i>Spore-development in Salvinia natans</i>	490
FISCHER, H.— <i>Aqueous Cultures of Fern Prothallia</i>	490
.. .. . <i>Influence of Light and Darkness on Germination of Fern-spores</i>	491
BRIQUET, J.— <i>Corsican Ferns</i>	491
MAIDEN, J. H., & E. BETCHE— <i>Queensland Ferns</i>	491
VAN ROSENBERGH, C. R. W. K. VAN A.— <i>Malayan Ferns</i>	491
CHRIST, H.— <i>Chinese Ferns</i>	491
BOWER, F. O.— <i>Morphology of Ophioglossum palmatum</i>	642
FREIBERG, W.— <i>Forms of Ophioglossum</i>	643
BOWER, F. O.— <i>Origin of Medulla in Ophioglossaceæ</i>	643
.. .. . <i>Medullation in the Pteridophyta</i>	643
FERGUSON, M. C., & C. A. BLACK— <i>Embedded Antheridia in Pteris</i>	644
BANCROFT, N.— <i>Xylem Elements of the Pteridophyta</i>	644
BRUYN, H. DE— <i>Development of Stele in Dipteris</i>	644
GWYNNE-VAUGHAN, D. T.— <i>Anatomy of the Osmundaceæ</i>	645
PERRIN, G.— <i>Prothallia of Equisetum</i>	645
YASUI, K.— <i>Life-history of Salvinia natans</i>	645
NEGER, F. W.— <i>Spore-distribution in Selaginella</i>	646
JOHNSON, T.— <i>Lyginodendron (Crossotheca) in Irish Coal Measures</i>	646
COULTER, J. M., & W. J. G. LAND— <i>American Lepidostrobus</i>	647
PELOURDE, F.— <i>Some Mesozoic Ferns and their Leaf-scars</i>	647
KUBART, B.— <i>Spores of Spenceerites</i>	647
JOHNSON, T.— <i>Archæopteris</i>	647
VERHULF, A.— <i>Distribution of Equisetum maximum</i>	648
LITARDIÈRE, R. DE— <i>Asplenium Guichardii</i>	648
PAMPANINI, R., & OTHERS— <i>Woodwardia radicans in Italy</i>	649
JUNGE, P.— <i>Ferns of Schleswig-Holstein</i>	649

	PAGE
DURAND, E., & G. BARRATTE— <i>Pteridophytes of Libya</i>	649
HILL, E. J., & OTHERS— <i>North American Pteridophytes</i>	649
WRIGHT, C. H.— <i>Ferns of the Falkland Islands</i>	650
MATTHEW, C. G., & R. PAMPANINI— <i>Chinese Ferns</i>	650
CHRISTENSEN, C.— <i>Ferns of Corea and Quelpart</i>	650
CHRIST, H.— <i>Ferns of Annam</i>	650
CHRYSLER, M. A.— <i>Ophioglossum palmatum</i>	777
CLUTE, W. N.— <i>Hemigranma latifolia</i>	777
POYSER, W. A., & OTHERS— <i>Asplenium alternans in America</i>	777
JUNGE, P.— <i>Pteridophytes of Schleswig-Holstein</i>	778
KIMBALL, L. F., & OTHERS— <i>American Ferns</i>	778
COPELAND, E. B.— <i>Bornean Ferns</i>	778
RIDLEY, H. N.— <i>Ferns of Perak</i>	778
COPELAND, E. B.— <i>Philippine Ferns</i>	778
COPELAND, E. B., & E. ROSENST. CK— <i>Papuan Ferns</i>	779
HIERONYMUS, G., & A. GEPP— <i>African Ferns</i>	779

Bryophyta.

CAVERS, F.— <i>Inter-relationships of the Hepaticæ</i>	64
HERZOG, T.— <i>Parallelism and Convergence of Moss-pedigrees</i>	65
SCHIFFNER, V.— <i>Bryological Notes</i>	65
ROTH, G.— <i>Andrezæceæ</i>	65
COPELAND, E. B.— <i>Protolidsaya and other Bornean Ferns</i>	65
MERRILL, E. D., & M. L. MERRITT— <i>Ferns of the Philippine Islands</i>	66
GYÖRFY, I.— <i>Distribution of Molendoa Seidneriana in Hungary</i>	66
HAGEN, J.— <i>Dieranoloma</i>	66
<i>Annulus of Cynodontium Alpestre</i>	66
DIXON, H. N.— <i>Mercuriopsis g.n. and other Indian Mosses</i>	66
NICHOLS, G. E.— <i>Ephemerum and Nanomitrium in North America</i>	66
BURRELL, W. H.— <i>Norfolk Bryophytes</i>	67
ROTH, G.— <i>New and Rare European Mosses</i>	67
KRAHMER, B., & J. ROLL— <i>Moss-flora of South Thuringia</i>	67
JANZEN, P.— <i>Moss-flora of Eisenach</i>	67
SCHMIDT, J.— <i>New Records of Hamburg Mosses</i>	67
EVANS, A. W.— <i>New England Hepaticæ</i>	67
JENNINGS, O. E., & OTHERS— <i>North American Bryophyta</i>	68
CARDOT, J.— <i>Mexican Mosses</i>	68
HERZOG, T.— <i>Moss-flora of Bolivia</i>	68
MERRILL, E. D., & M. L. MERRITT— <i>Bryophyta of the Philippine Islands</i>	68
COCKAYNE, I.— <i>New Zealand Bryophytes</i>	69
ROLL, J.— <i>Adalbert Geheeb: Obituary</i>	69
CAVERS, F.— <i>Inter-relationships of the Bryophyta</i>	224
SCHIFFNER, V.— <i>Amphigastrical Antheridia in some Ptilidioid Hepaticæ</i>	224
JUEL, O.— <i>Structure of Riccia Bischoffii</i>	225
SCHIFFNER, V.— <i>Critical Forms of Aplezia</i>	225
HERZOG, T.— <i>Grimmia pilosissima</i>	226
BAUER, E., & OTHERS— <i>Rare Species of Bryum</i>	226
LACOUTURE, C.— <i>Figures of Hepatic Genera</i>	226
STEPHANI, F.— <i>Species Hepaticarum</i>	227
PARIS, E. G.— <i>Bryological Index</i>	227
ROTH, G.— <i>Illustrations of Exotic Mosses</i>	227
<i>New or Rare European Mosses</i>	227
RUSSELL, T. H.— <i>British Mosses and Liverworts</i>	227
FRY, SIR EDWARD & AGNES— <i>Introduction to British Liverworts</i>	228
INGHAM, W., & OTHERS— <i>British Mosses</i>	228
STIRTON, J.— <i>New Scottish Mosses</i>	228
COPPEY, A.— <i>Mosses of the Haute-Saône</i>	229
SCHIFFNER, V., & OTHERS— <i>Hungarian Bryophytes</i>	229
SAPÉHIN, A. A.— <i>South Russian Mosses</i>	229

	PAGE
ARNELL, H. W., & OTHERS— <i>Northern Mosses</i>	229
CAVERS, F.— <i>Inter-relationships of the Bryophyta</i>	380
STEINBRINCK, C.— <i>Desiccation-phenomena in Mosses</i>	381
ROTH, G.— <i>Illustrations of Exotic Mosses</i>	381
MÜLLER, K.— <i>European Hepaticæ</i>	381
KAALAAS, B., & H. N. DIXON— <i>British Bryophyta</i>	381
LEWIS, F. J.— <i>Moss-remains in Scottish Peat</i>	381
COPPEY, A.— <i>Moss-flora of the Haute-Saône</i>	382
RÖLL, J.— <i>Sphagnaceæ of the Rhöngengebirge</i>	382
SAFEHIN, A. A.— <i>Mosses of the Crimea</i>	382
HERZOG, T.— <i>Mosses of Ceylon</i>	382
GEHEER, A.— <i>Moss-flora of the Atlantic Islands</i>	382
DIXON, H. N.— <i>Teneriffe Mosses</i>	382
PITARD, J., & L. CORBIÈRE— <i>Moss-flora of Tunis</i>	382
PARIS, E. G.— <i>Hepaticæ of New Caledonia</i>	383
FRYE, T. C.— <i>Polytrichaceæ of North America</i>	383
CARPOT, J.— <i>Mexican Mosses</i>	383
BRITTON, E. G.— <i>Splachnobryum in Greenhouses</i>	383
DIXON, H. N.— <i>Fissidens tequendannensis</i> Mitten	383
HERZOG, T.— <i>Adalbert Geheeb</i>	384
NILS CONRAD KINDBERG	384
RÖLL, J.— <i>Variable Leaf-border in Fissidens</i>	492
GARJEANNE, A. J. M.— <i>Hepaticæ Infected by Fungi</i>	492
SPEER, J. M.— <i>Inflorescence of Funaria</i>	492
LOESKE, L.— <i>Lesquerexia</i>	492
MÖNKEMEYER, W.— <i>Cratoneuron and Hygroamblystegium</i>	493
SPINDLER, M.— <i>Hygrohypnum ochraceum</i>	493
GYÖRFFY, I.— <i>Buzbaumia viridis</i>	493
MÜLLER, K.— <i>European Hepaticæ</i>	493
ROTH, G.— <i>New and Rare European Mosses</i>	494
EVANS, W.— <i>British Bryophytes</i>	494
RICHARDS, E. A.— <i>Philonotis seridata with Fruit</i>	494
DIXON, H. N.— <i>Mosses of Spitzbergen</i>	494
MÖNKEMEYER, W.— <i>Muscineæ of Bornholm</i>	494
HILLIER, L.— <i>Moss-flora of the Jura</i>	494
TORKA, V., & OTHERS— <i>German Bryophytes</i>	494
WARNSTORF, C.— <i>Bryophytes of Southern Europe</i>	495
FLEISCHER, M.— <i>Mosses of New Guinea</i>	495
PARIS, E. G.— <i>Mosses of Eastern Asia</i>	495
OKAMURA, S.— <i>New Japanese Mosses</i>	495
BROTHERUS, V. F.— <i>Moss-flora in Central Asia</i>	495
STEPHANI, F., & OTHERS— <i>Bryophyta of German Central Africa</i>	496
PARIS, E. G.— <i>Bryophyta of Tropical West Africa</i>	496
KAISER, G. B., & OTHERS— <i>Bryophyta of North America</i>	496
WILLIAMS, R. S.— <i>Panama Mosses</i>	497
MASSALONGO, C.— <i>Brazilian Hepatics</i>	497
ARNAUDOFF, N.— <i>Dryptodon Hartmani</i>	497
HUSNOT, T.— <i>F. Renauld's Moss-herbarium</i>	497
CARDOT, J.— <i>New Antarctic Genera</i>	498
SCHOENAU, K. VON— <i>Branch-formation in Mosses</i>	651
MARCHAL, EM.— <i>Sexuality among the Mosses</i>	651
WOODBURN, W. L.— <i>Spermatogenesis in certain Hepaticæ</i>	652
WILSON, M.— <i>Spermatogenesis in the Bryophyta</i>	653
GYÖRFFY, I., & E. G. BRITTON— <i>Mosses attacked by Cladosporium</i>	653
WARNSTORF, C.— <i>Nomenclature of Sphagnaceæ</i>	653
BRITTON, E. G., & E. B. CHAMBERLAIN— <i>Philonotis revised by Dismier</i>	654
DIXON, H. N.— <i>Hylophilopsis, a New Indian Moss-genus</i>	654
HERZOG, T.— <i>Woolnya, a Genus of Bryaceæ</i>	654
WELDON, J. A.— <i>Suartzia inclinata in Lancashire</i>	654
CULMANN, P.— <i>Notes on Grimmia</i>	654
LOESKE, L.— <i>Tomenthypnum, a New Genus</i>	655

	PAGE
ZODDA, J.— <i>Drepanocladus</i>	655
STEPHANI, F.— <i>Goebeliella</i> , a New Genus	655
BURRELL, W. H.— <i>New Variety of Lophozia Schultzii</i>	655
DEGEN, A. VON— <i>Dichiton calyculatum in Croatia</i>	655
MACVICAR, S. M.— <i>Fossombronina echinata</i>	655
BAUER, E.— <i>Critical European Mosses</i>	656
BURRELL, W. H., & OTHERS— <i>British Muscinæ</i>	656
COPPEY, A.— <i>Moss-flora of Haute-Saône</i>	656
CORNET, A.— <i>Belgian Bryophytes</i>	656
BROCKHAUSEN, H.— <i>Moss-flora of Rhine-land</i>	656
RÖLL, J.— <i>Mosses of the Erzgebirge</i>	656
HERZOG, T.— <i>Moss-flora of Bernina</i>	657
TRAUTMANN, C.— <i>Mosses of Tirol</i>	657
GYÖRFFY, I.— <i>Hungarian Mosses</i>	657
PODPERA, J.— <i>Moss-flora of Bulgaria</i>	657
SAPEHIN, A. A., & OTHERS— <i>Crimæan Mosses</i>	657
DURAND, E., & G. BARRATTE— <i>Mosses of Libya</i>	658
GROUT, A. J., & M. E. JONES— <i>North American Bryophytes</i>	658
CARDOT, J.— <i>Mexican Mosses</i>	658
PARIS, E. G.— <i>Nomina nuda</i>	659
HUSNOT, T.— <i>E. G. Paris: Obituary</i>	659
DOUIN, I.— <i>Inflorescence of Muscinæ</i>	779
WHELTON, J. A.— <i>Social Groups and Adaptive Characters in the Bryophyta</i>	779
BROTHERUS, V. F.— <i>Allionella</i> , a new Genus	780
WILLIAMS, R. S.— <i>Austinella</i> , a new Genus	780
WILLIAMS, E. M.— <i>Leucobryum glaucum</i>	780
MEYLAN, C.— <i>Plagiothecium</i>	780
DUNHAM, E. M.— <i>Polytrichum</i>	781
DOUIN, I.— <i>Lophocolea minor not a Species</i>	781
SCHIFFNER, V.— <i>Metzeria</i>	781
CHEETHAM, C. A., & OTHERS— <i>British Bryophytes</i>	781
COPPEY, A.— <i>Mosses of Haute-Saône</i>	782
GOLA, G., & E. ARMITAGE— <i>Hepaticæ of the Atlantic Islands</i>	782
ANDREWS, A. LE ROY— <i>North American Sphagnum</i>	782
EVANS, A. W.— <i>North American Hepaticæ</i>	782
CARDOT, J.— <i>Mexican Moss-flora</i>	783
EVANS, A. W.— <i>Hepaticæ of the Bahama Islands</i>	783
" " <i>Hepaticæ of Puerto Rico</i>	783
GIBBS, L. S.— <i>New Zealand Hepaticæ</i>	783
OKAMURA, S.— <i>Japanese Bryophytes</i>	783
BROTHERUS, V. F.— <i>Mosses of New Caledonia</i>	784
CARDOT, J.— <i>Antarctic Mosses</i>	784

Thallophyta.

Algæ.

SLUTER, C. P.— <i>Chara contraria and C. dissoluta</i>	69
BENNETT, A.— <i>Chara stelligera</i>	70
DANGEARD, P. A.— <i>Algæ from the Laboratory at Roscoff</i>	70
MERTON, F.— <i>Pleodorina illinoensis</i> Kofoid	70
SCHERFFEL, A.— <i>Raphidonema</i>	70
DANGEARD, P. A.— <i>New Genus of Polyblepharidæ</i>	71
HENCKEL, A.— <i>Phytoplankton of the Caspian Sea</i>	71
OSTENFELD, C. H.— <i>Thorosphara</i>	71
LEMMERMANN, E.— <i>Plancton-algæ</i>	71
KOFOID, C. A.— <i>Ceratocornys</i>	72
WORONICHIN, N.— <i>Metachromatic Bodies in certain Green Algæ and Conjugatæ</i>	72
WOLOSZNYSKA, J.— <i>Algæ of the Upper Pruth</i>	72
WILLE, N.— <i>Algological Notes</i>	73

	PAGE
CHODAT, R.— <i>Studies on the Conjugatæ</i>	73
FORTI, A.— <i>Diatoms</i>	73
HUSTEDT, F.— <i>Diatoms from Dahomey</i>	74
VIRET, L.— <i>Swiss Desmids</i>	74
BOSSE, E. WEBER VAN— <i>Caulerpa</i>	74
PERESSLEGINN, B.— <i>Laminaria hyperborea</i>	74
GARD, M.— <i>Hybrid form of Fucus</i>	75
BOSSE, A. WEBER VAN— <i>New Genera from the Malay Archipelago</i>	75
BIBLIOGRAPHY	76
OKAMURA, K.— <i>Japanese Marine Algæ</i>	229
GEPP, A. & E. S.— <i>Marine Algæ from the Kermadecs</i>	230
STILES, M. H.— <i>Algæ of the Sheffield District</i>	230
M'KEEVER, F. L.— <i>Algæ and their Study</i>	230
" " <i>Algæ of the Elf Loch</i>	230
LEMMERMANN, E.— <i>African Fresh-water Algæ</i>	230
HAYDEN, A.— <i>Algal Flora of the Missouri Botanical Garden</i>	230
BARLOW, W. II.— <i>Analysis of Seaweeds</i>	231
HÄYREN, E.— <i>Saprophytism of Enteromorpha</i>	231
DANFORTH, C. H.— <i>Periodicity in Spirogyra</i>	231
NELSON, E. M.— <i>Navicula rhomboïdes</i>	232
LÜTKEMÜLLER, J.— <i>Desmidiaceæ of Bohemia</i>	232
WEST, G. S.— <i>New African Species of Volvox</i>	232
M'KEEVER, F. L.— <i>Phæothamion conferriculum</i>	233
TILDEN, J. E.— <i>Myzophyceæ</i>	233
HOREJSI, J.— <i>Symbiotic Alga</i>	233
BIBLIOGRAPHY	233
PALMER, T. C.— <i>Locomotion in Surirella</i>	384
DANGEARD, P. A.— <i>Behaviour of Chlorella in White and Coloured Lights</i>	385
LAUBY, A.— <i>Study of Diatoms in Sedimentary Deposits</i>	385
COMÈRE, J.— <i>Classification of Algæ</i>	385
TOBLER, F.— <i>Epiphytes of the Laminariæ</i>	386
WEST, G. S.— <i>Algological Notes</i>	386
PAVILLARD, J.— <i>Vegetable Protistology</i>	387
HENCKEL, A.— <i>Black Sea Algæ</i>	387
WISLOUCH, S. M.— <i>Stichococcus bacillaris</i>	387
NADSON, G. A.— <i>Effect of Coloured Light on Stichococcus bacillaris</i>	387
KESSLER, K. VON— <i>Phytoplankton of the Zeller See</i>	388
" " <i>Plankton from the Julischen Alps</i>	388
BACHMAN, H.— <i>Oscillatoria rubescens</i>	389
PLAYFAIR, G. I.— <i>Polymorphism and Life-history in the Desmidiaceæ</i>	389
VIRIEUX, J.— <i>Spirogyra from the neighbourhood of Besançon</i>	389
GEPP, A. & E. S.— <i>Codiaceæ</i>	389
BACHMANN, H.— <i>Fresh-water Algæ of Greenland</i>	390
WONISCH, F.— <i>Algæ of Andritz</i>	390
PETKOFF, S.— <i>Fresh-water Algæ from Macedonia</i>	390
BORNET, E.— <i>M. A. Gomont</i>	390
BIBLIOGRAPHY	391
BRUNNTHALER, J.— <i>Phylogeny of Algæ</i>	498
RICHTER, O.— <i>Nutrient of Algæ</i>	498
BRUNNTHALER, J.— <i>Coccolithophoridæ from the Adriatic</i>	499
WISLOUCH, S. M.— <i>Two Russian Chryomonads</i>	499
WAGER, H.— <i>Euglena viridis</i>	499
NADSON, G. A.— <i>Mastigocoleus testarum</i>	500
BOARD OF AGRICULTURE— <i>Injury to Water-cress Beds by Algæ</i>	500
MURRAY, J.— <i>Red snow</i>	500
BROWN, W. H.— <i>Cell-division in Lyngbya</i>	500
SNOW, J. W.— <i>Two Epiphytic Algæ</i>	501
SCHUSSNIG, B.— <i>Gonium pectorale</i>	501
PRICE, S. R.— <i>New Species of Debarya</i>	502
CHATTON, E.— <i>Pleodorina californica</i>	502
BIALOSUKNIA, W.— <i>Corroding Alga</i>	502
CAMPBELL, D. H.— <i>Californian Green Algæ</i>	503

	PAGE
MERLIN, A. A. C. ELIOT— <i>Diatomic Structure</i>	503
KAISER, P. E.— <i>Algological Notes</i>	503
LUTZ, L.— <i>Deformation of Ascophyllum nodosum</i>	503
THODAY, M. G.— <i>Medulla cells of Laminariaceæ</i>	504
HOFFMANN, E. J.— <i>Fructification of Macrocyctis</i>	504
McFADDEN, A. S.— <i>Ahnfeldtia gurgutinoides</i>	504
TWISS, W. C.— <i>Erythrophyllum delesserioides</i>	504
McFADDEN, M. E.— <i>Colacodasya</i>	505
LEMOINE, MME. P.— <i>Melobesia</i>	505
" " <i>Classification of Melobesiæ</i>	505
COTTON, A. D.— <i>Lithophyllum fasciculatum</i>	506
KYLIN, H.— <i>Algæ of the West Coast of Norway</i>	506
WRIGHT, E. P.— <i>Edward Perceval Wright (1834-1911)</i>	506
RICHTER, O.— <i>Nutrition of Algæ</i>	659
MÜSCHLER, R.— <i>Algæ of Tripoli</i>	660
BROWN, W. H.— <i>Algæ of North Carolina</i>	660
OSTENFELD, C. H.— <i>Diatoms and Flagellatæ from East Greenland</i>	660
KESSLER, K. V.— <i>Periodicity of Phytoplankton of the Leopoldstein Lake</i>	660
OSTENFELD, C. H.— <i>Halosphæra and Flagellata</i>	660
PASCHER, A.— <i>Two Brown Flagellatæ</i>	661
" " <i>Cryptomonadæ</i>	661
ULEHLA, V.— <i>Cyathomonas</i>	661
PASCHER, A.— <i>Chrysomonadæ from the Hirschberger Grossteich</i>	661
REINISCH, O., & A. PASCHER— <i>Chrysomonads</i>	661
DESROCHE, P.— <i>Chlamydomonas Steinii</i>	662
CHODAT, R.— <i>Coccoigenous Cyanophyceæ</i>	662
BACHMANN, H.— <i>Oscillatoria rubescens</i>	662
HARDY, A. D.— <i>Red Euglena</i>	662
" " <i>Myxozouma in Salmon Disease</i>	663
SPRATT, E. R.— <i>Life-history of Anabæna Cycadææ</i>	663
GAIN, L.— <i>New Species of Nostoc</i>	664
COTTON, A. D.— <i>Ulva latissima</i>	664
ANDREWS, F. M.— <i>Spirogyra</i>	665
MÜHLETHALER, F.— <i>Desmids of the Burgäschimoos</i>	665
LUTMAN, B. F.— <i>Cell and Nuclear Division in Closterium</i>	665
BURTON, J.— <i>Botrydium granulatum</i>	666
PAQUE, E.— <i>Vaucheria terrestris</i>	666
TOBLER, F.— <i>Codium tomentosum</i>	666
BRAND, F.— <i>New Chlorophyceæ from New Zealand and Tahiti</i>	667
BÖRGESEN, F.— <i>West Indian Chlorophyceæ</i>	667
YENDO, K.— <i>Development of Costaria, Undaria, and Laminaria</i>	667
SVEDELIUS, N.— <i>Rhodophyceæ</i>	668
CHALON, J.— <i>Goniophyllum Buffhami</i>	668
PETERSEN, H. E.— <i>C. ranium</i>	669
DRUCE, G. C.— <i>Tolypella intricata Leonh.</i>	669
HEYDRICH, F.— <i>Lithothamnium from Roscoff in Brittany</i>	669
BUTCHER, T. W.— <i>The Structural Detail of Coscinodiscus asteronophalus</i> . (Plates XXV.-XXVII)	722
MEINHOLD, T.— <i>Physiology of Diatoms</i>	784
KYLIN, H.— <i>Phycocythrin and Phycocyanin</i>	784
DANGEARD, P. A.— <i>Effect of Light on Algæ</i>	785
" " <i>Nuclear Autochromatism in Algæ</i>	785
MOLLARD, M.— <i>Algal Figures on Culture Flasks</i>	785
DENYS, G.— <i>Anatomy of Polyides and Furcellaria</i>	785
CONNOLLY, C. J.— <i>Floridææ</i>	786
SVEDELIUS, N.— <i>Erythrocladia</i>	787
BIGNOTTI, G.— <i>Batrachospermum growing on Molluscs</i>	787
COTTON, A. D.— <i>Colpomenia sinuosa</i>	787
VIRIUX, J.— <i>Dichtonomosiphon and Mischooccus</i>	788
GARRY, R.— <i>Fresh-water Algæ of the Clyde Area</i>	788
CLERICI, E.— <i>Pleurococcus sulphurarius</i>	788
TONI, G. B. DE— <i>Clathrocystis</i>	788

	PAGE
BURTON, J.— <i>Breaking of the Meres</i>	788
CLERICI, E.— <i>Fossil Diatoms in Italy</i>	788
JOERGENSEN, E.— <i>Ceratium</i>	789
KOLKOWITZ, R.— <i>Kammerplankton</i>	789
OSTENFELD, C. H.— <i>Arctic Plankton</i>	789
HONIGMANN, H.— <i>Plankton of Prester See, near Magdeburg</i>	789
LAUTERBORN, R.— <i>Vegetation of Upper Rhine</i>	789
MARCHI, M. DE— <i>Plankton of Lago Maggiore</i>	789
MAZZA, A.— <i>Marine Algology</i>	790
PILGER, R.— <i>Marine Alge of Kamerun</i>	790

Fungi.

GRIFFON & MAUBLANC— <i>Cladochytrium cæspitis</i> sp. n.	76
GUTTENBERG, A.— <i>Study of Synchytrium-galls</i>	76
NAMYŚLIOWSKI, BOLESŁAW— <i>Study of Mucorini</i>	76
DAUPHIN, J.— <i>Study of Mortierellæ</i>	77
PETERSEN, H. E.— <i>Danish Phycomycetes</i>	77
SCHIKORRA, W.— <i>Development of Mousascus</i>	77
MAGNUS, P.— <i>Oak Mildew</i>	78
FOEX, M. E.— <i>Oidium of Japanese Euonymus</i>	78
IHSSEN, G.— <i>Fusarium nivale and Nectria graminicola</i>	78
APPEL, O., & H. W. WOLLENWEBER— <i>Study of Hyphomycetes</i>	79
WACHTER, W.— <i>Coremium-formation in Penicillium</i>	79
RAVENNA, C., & G. FIGHINI— <i>Metabolism of Moulds</i>	79
LINOSSIER, G.— <i>Influence of Iron on the Formation of Spores in Aspergillus Niger</i>	79
ARTHUR, J. C., & OTHERS— <i>Uredineæ</i>	79
ZACH, F.— <i>Rusts of Cereals</i>	80
MCALPINE, D.— <i>Smuts of Australia</i>	81
KAUFMANN, F.— <i>German Cortinariæ</i>	81
BATAILLE, F.— <i>Monograph of Hygrophorus</i>	81
MAIRE, RENÉ— <i>Notes on the Larger Fungi</i>	81
TORRENT, C.— <i>Punctularia tuberculosa</i>	81
BULLER, A. H. R.— <i>Cystidia of Coprinus atramentarius</i>	82
PONROY, M.— <i>Mushroom Culture</i>	82
HORI, S.— <i>Do the Higher Fungi require Lime?</i>	82
HÖHNEL, F. V.— <i>Mycological Notes</i>	82
LLOYD, C. G.— <i>Notes on the Larger Fungi</i>	83
TUBEUF, C. V.— <i>Witches'-brooms on Firs</i>	83
" <i>Wintering of Plant Parasites</i>	83
SALTER, CHARLES T. C.— <i>Technical Mycology</i>	83
WHETZEL, H. H.— <i>Fungicides</i>	84
STEVENS, F. L., & J. G. HALL— <i>Diseases of Economic Plants</i>	84
VOGES, ERNEST, & OTHERS— <i>Plant Diseases</i>	84
BIBLIOGRAPHY	87
MAIRE, RENÉ, & ADRIEN TISON— <i>Research on Cladochytriaceæ</i>	233
PEGLION, VITTORIO— <i>Biology of Sclerospora</i>	234
LECHMERE, A. E.— <i>Notes on Saprotelium</i>	234
HEWITT, G. GORDON— <i>Fungus of House-fly</i>	234
BR-OWN, WILLIAM H.— <i>Ascocarp of Leotia</i>	234
SYDOW, P., & OTHERS— <i>Uredineæ</i>	235
HONCAMP, FR., & H. ZIMMERMANN— <i>Study of Smut-infection</i>	235
MATRUCHOT, L.— <i>Culture of an Edible Fungus</i>	236
MURRILL, W. A., & OTHERS— <i>Poisonous Mushrooms</i>	236
LINGELSHIM, A.— <i>Notes on the Larger Fungi</i>	236
MAGNUS, P.— <i>New Species of Bresadolia</i>	236
SCHORSTEIN, JOSEF— <i>Wood-destroying Fungi</i>	237
RICK, J.— <i>Notes on Geaster</i>	237
ATKINSON, G. F.— <i>Dictyophora and Ithyphallus</i>	237
THEISSEN, F.— <i>Mycogeography</i>	237

	PAGE
ARZBERGER, E. G.— <i>Fungus Root-tubercles</i>	237
MASSEE, G.— <i>Origin of Parasitism in Fungi</i>	238
DIKONOFF, HELENE V.— <i>Plant-diseases in Russia</i>	238
GRIFFON, & OTHERS— <i>Diseases of Plants</i>	238
BIBLIOGRAPHY	240
WARBURTON, C. W.— <i>Ergot on Oats</i>	391
GROH, HERBERT— <i>New Host for Claviceps</i>	391
MEDISCH, MARC— <i>Study of Hypocrea rufa</i>	391
SEAYER, F. J.— <i>North American Fungi</i>	392
KÖCK, GUSTAV— <i>Mildew of Gooseberry and Oak</i>	392
GUILLIERMOND, A.— <i>Copulation of Yeast-cells</i>	392
BERNARD, CH.— <i>Presence of Yeast on Tea</i>	392
OBERSTEIN-BRESLAU, OTTO— <i>Cicinobolus sp. parasitic on Sphaerotheca mors-uvæ</i>	392
VUILLEMIN, PAUL— <i>Cicinobolus sp. parasitic on Oak Mildew</i>	393
BAINIER, G.— <i>New Hyphomyces</i>	393
BANCROFT, C. K.— <i>Parasitic Fungi</i>	393
APPEL, O., & H. W. WOLLANWEBER— <i>Monograph of Fusarium</i>	393
DITTSCHLAG, E.— <i>Research on Uredineæ</i>	394
FEDERLEY, HARRY— <i>Conidial Fasion in Ustilago Tragopogi-pratensis</i>	394
RICKEN, A.— <i>German Agariceæ</i>	394
FERDINANDSEN, C., & J. LIND— <i>Fungi from Greenland</i>	395
FERDINANDSEN, C., & O. WINGE— <i>Fungi from Venezuela and the West Indies</i>	395
THAXTER, ROLAND— <i>Notes on Chilian Fungi</i>	395
HERTER, W.— <i>German Fungus-flora</i>	395
LAURENT, JULES— <i>Physical Condition of Resistance of the Vine against Mildew</i>	395
JØRGENSEN, ALFRED— <i>Micro-organisms and Fermentation</i>	396
JACZEWSKI, A. DE— <i>Geotropism and Phototropism in Fungi</i>	396
ZELLNER, JULIUS— <i>Chemistry of the Higher Fungi</i>	396
NEGER, F. W.— <i>Ambrosia Fungus</i>	396
JEMELLE & PERRIER DE LA BATHIE— <i>Termites and Fungi</i>	397
SPAULDING, PERLEY— <i>Fungi in Clay Mines</i>	397
MUNCH— <i>Research on Diseases of Trees</i>	397
BIBLIOGRAPHY	398
MCCORMICK, FLORENCE A.— <i>Homothallic Conjugation in Rhizopus nigricans</i>	507
HAGEN, O.— <i>Norwegian Mucorini. II.</i>	507
MULLER-THÜRGAU, H.— <i>Infection of the Vine by Plasmopara viticola</i>	507
PETHYBRIDGE, G. H.— <i>Experiments with Phytophthora</i>	507
GUILLIERMOND, A.— <i>Nuclear Evolution in Ascomycetes</i>	508
BRZEZINSKI, J.— <i>Mildew of the Vine in Poland</i>	508
MAGNUS, PAUL— <i>Oak-mildew</i>	508
PETERS, L.— <i>Pythium de Baryanum</i>	508
GRIGGS, R. F.— <i>Monochytrium, a New Genus of the Chytridiæ</i>	508
CARRUTHERS, D.— <i>Helvella crispa</i>	508
DEARNESS, J.— <i>Mushroom Poisoning</i>	509
WAGER, HAROLD— <i>Yeast-cells and Fermentation</i>	509
LEININGER, H.— <i>Study of Fungi imperfecti</i>	509
DIEDICKE, H.— <i>Genus Phomopsis</i>	510
JANCZEWSKI, ED., & B. NAMYSLOWSKI— <i>Glaosporium Ribis</i>	510
SUMSTINE, D. R.— <i>Studies in North American Hyphomyces</i>	510
FILIER, P.— <i>Tilletia horrida in Rice-meal</i>	510
TREBUC, V., & OTHERS— <i>Uredineæ</i>	510
ZIMMERMAN, H.— <i>Germination of Ustilago Spores</i>	511
KAWAMURA, S.— <i>Phosphorescence of Pleurotus japonicus</i>	512
MAIRE, RENÉ— <i>Boletus impolitus</i>	512
MOLLARD, MARIN— <i>Hypochaus Form of Fistulina Hepatica</i>	512
BAMBERE, CH. VAN— <i>Study of Ithyphallus impudicus and Mutinus caninus</i>	512
PENNINGTON, L. H.— <i>Assimilation of Nitrogen by Fungi</i>	512
MIGULA, W.— <i>German Fungus-flora</i>	512
GARJEANNE, A. J. M.— <i>Fungi in the Rhizoids of Leafy Hepatics</i>	513
WAGER, HAROLD, & OTHERS— <i>British Mycology</i>	513
DELAcroix, G.— <i>Plant Diseases in the Tropics</i>	514

	PAGE
BUBAK, FR., & OTHERS— <i>Diseases of Plants</i>	514
MERCIER, L.— <i>Insects as Fungus-carriers</i>	515
HÖHNEL, F. VAN— <i>Notes on Mycology</i>	516
MASSÉE, G., & HAROLD WAGER— <i>Notes on Fungi</i>	516
CROSSLAND, C.— <i>Fungus Foray at Sand end</i>	516
ROSE, LUDWIG— <i>Mycological Flora of Oak-tree Slime-flux</i>	516
BIBLIOGRAPHY	517
KASANOWSKY, V.— <i>Aphanomyces larvis</i>	669
MAGNUS, P.— <i>Parasitic Root-diseases of the Juncaceæ</i>	670
WESTERDIJK, JOH.— <i>Sclerotinia as a Plant-disease</i>	670
FISCHER, ED.— <i>Studies in Ascomycetes</i>	670
LAGARDE, J.— <i>Plicaria Planchonii</i> <i>Boud.</i>	670
MEDISCH, M.— <i>Hypocrea rufa</i>	670
BACCARINI, P., & OTHERS— <i>Research on Aspergillus</i>	671
PEGLION, VITTORIO— <i>Notes on Erysiphæ</i>	671
WORONICHIN, N.— <i>Physalosporina, a New Genus of Pyrenomycetes</i>	671
LEWIS, M.— <i>Development of the Spores in Pleuraige zygospora</i>	671
HARDEN, A., & W. J. YOUNG— <i>Alcoholic Ferment of Yeast-juice</i>	672
SYDOW, H. & P., & H. DIEDICKE— <i>Sphæropsidæ</i>	672
KEISZLER, K. VON— <i>Parasitic Lichen-fungi</i>	672
FAWCETT, H. S., & O. F. BURGER— <i>Gum-inducing Diplodia of Peach and Orange</i>	672
MAGNUS, P.— <i>New Fungi from the Tyrol</i>	673
BUCHANAN, R. E.— <i>Hyphomyces</i>	673
VUILLEMIN, P.— <i>Classification of the Hyphomyces</i>	673
ROBBER, G. B.— <i>Green Muscardine of Frog-hoppers</i>	673
GRIFFON & MAUBLANC— <i>Thermophilous Moulds</i>	673
BETHEL, ELLSWORTH, & OTHERS— <i>Uredinæ</i>	674
SHARP, LESTER W.— <i>Nuclear Phenomena in Puccinia Podophylla</i>	675
MCALPINE, D., & OTHERS— <i>Smut Fungi</i>	675
MUNERATE, O.— <i>Smut-infection Experiments</i>	676
PETCH, T.— <i>Note on the Biology of Septobasidium</i>	676
PATOUILLARD, N., & OTHERS— <i>Notes on Larger Fungi</i>	676
MARCHAND, LEON— <i>Fresco-painting of Fungi</i>	677
LLOYD, C. G.— <i>Mycological Notes</i>	677
CLARKE, E. D., & OTHERS— <i>Poisoning by Fungi</i>	677
OHTA, ROHSTRI— <i>Fat-destroying Fungi</i>	677
NAUNCH, E.— <i>Research on Diseases of Trees</i>	677
EVANS, I. B. POLE, & ETHEL M. DOIDGE— <i>Plant-diseases in South Africa</i>	678
ERIKSSON, JACOB, & OTHERS— <i>Plant-diseases</i>	678
KUSANO, S.— <i>Mycorrhiza of Gastrodia</i>	681
BIBLIOGRAPHY	681
MOREAU, FERNAND— <i>Notes on Mucorini</i>	790
MAIRE, RENÉ— <i>Notes on Hypocreaceæ</i>	790
FAULL, J. H.— <i>Study of Laboulbeniades</i>	790
FALCK, R.— <i>Infection by Ergot Spores</i>	791
MUTH, FR.— <i>Mildew of Cherries</i>	791
WINGE, O.— <i>Sphærotheca Castagnei</i> <i>Lév.</i>	791
MAYOR, E., & OTHERS— <i>Experimental Researches with Uredinæ</i>	791
PRITCHARD, F. J.— <i>Dissemination of Puccinia graminis</i>	792
KURSSANOW, L.— <i>Sexuality of Uredinæ</i>	792
MCALPINE, D.— <i>New Smut in a New Genus of Grass</i>	793
BREDEMAN, G.— <i>Bunt-spores in Meal, Bran, and Grain</i>	793
VUILLEMIN, P., & OTHERS— <i>Studies of Hyphomyces</i>	793
ARNAUD, G.— <i>Contribution to the Study of Fumagineæ</i>	794
HARDER, R.— <i>Cultures of Mixed Fungi</i>	794
BACCARINI, P., & BRESADOLA— <i>Notes on the Larger Fungi</i>	794
KNIEF, HANS— <i>Development of Basidia</i>	794
FRIES, ROB.— <i>Spore formation in Nidularia</i>	794
LLOYD, C. G.— <i>Mycological Notes</i>	795
FAWCETT, H. S.— <i>Fungus parasitic on Citrus White Fly</i>	795
VOGES, ERNST— <i>Leaf-spots of Currant</i>	795
PETCH, T.— <i>Physiology and Pathology of Hevea brasiliensis</i>	795

	PAGE
EDGERTON, C. W., & OTHERS— <i>Diseases of Plants</i>	796
SARTORY, A.— <i>Pathogenic Fungi</i>	798
PLEHN, M., & K. MULSON— <i>Fish Disease</i>	799
BARBIER, MAURICE— <i>Obituary Notice of F. H. Gillot</i>	799
BIBLIOGRAPHY	799

Lichens.

RIDDLE, L. W.— <i>American Species of Stereocaulon</i>	89
" " <i>Cladonia</i>	89
FINK, BRUCE— <i>Carolyn Wilson Harris: Obituary Notice</i>	90
BIBLIOGRAPHY	90
HOWE, R. HEBER— <i>Usnea and its Linnæan Nomenclature</i>	242
WHELDON, J. A.— <i>New Lancashire Lichens</i>	243
BIBLIOGRAPHY	243
ELFVING, F.— <i>Lichen Gonidia</i>	399
HÄYRÉN, ERNEST— <i>Culture of Lichen Gonidia</i>	400
WAHLBERG, ARTH.— <i>Apothecial Development in Anaptychia and Physcia</i>	401
BIBLIOGRAPHY	401
SAUNDERS, J.— <i>Distribution of Mycetozoa in the South Midlands</i>	401
OSBORN, T. G. B., & A. S. HORNE— <i>Spongospora subterranea</i>	401
TOBLER, F.— <i>Nutrition of Lichens</i>	518
HERRE, A. W. C. T.— <i>Lichen Flora of Santa Cruz Peninsula, California</i>	518
" " <i>Desert Lichens</i>	519
RIDDLE, LINCOLN, W., & G. K. MERRIL— <i>American Lichen Notes</i>	519
HUE, ABBÉ— <i>Crocynia, a Genus of Lichens</i>	519
KAJANUS, BERGER— <i>Systematic Position of Stereocaulon</i>	519
BIBLIOGRAPHY	520
BACHMANN, E.— <i>Relation of Siliceous Lichens to the Substratum</i>	683
HOWE, R. HEBER— <i>Northern Species of Alectoria in America</i>	683
BIBLIOGRAPHY	683
CLARE ISLAND SURVEY COMMITTEE— <i>West of Ireland Lichens</i>	800
STEINER, J.— <i>Lichens of Italy</i>	801
KAJANUS, B.— <i>Morphology of Lichens</i>	801
FINK, BRUCE— <i>Nature and Classification of Lichens</i>	801
BIBLIOGRAPHY	801

Mycetozoa.

LISLER, G.— <i>Colloderma, a New Genus of Mycetozoa</i>	90
SCHWARTZ, E. J.— <i>Parasites on the Roots of Junraccæ</i>	90
BIBLIOGRAPHY	91
MAIRE, RENÉ, & ADRIEN TISON— <i>New Genus of Plasmodiophoracæ</i>	243
BIBLIOGRAPHY	243
SAUNDERS, J.— <i>Distribution of Mycetozoa in the South Midlands</i>	401
OSBORN, T. G. B., & A. S. HORNE— <i>Spongospora subterranea</i>	401
VOUK, V.— <i>Streaming of Plasmodia</i>	520
ENGELKE, C.— <i>Notes on Myxomycetes</i>	520
SCHWARTZ, E. J.— <i>Sorosphæra</i>	520
BIBLIOGRAPHY	521
JAHN, E.— <i>Studies in Myxomycetes</i>	684
VOUK, V.— <i>Alteration of Generations in Myxomycetes</i>	685
MAIRE, RENÉ, & ADRIAN TISON— <i>New Research on Plasmodiophoracæ</i>	685
OSBORN, T. G. B.— <i>Spongospora subterranea</i>	685
SCHWARTZ, E. J.— <i>Life-history of Sorosphæra graminis</i>	685
LEDoux-LEBARD, R.— <i>Myxomycetes from the Neighbourhood of Paris</i>	801
LLOYD, C. J.— <i>Notes on Myxomycetes</i>	802

Schizophyta.

Schizomycetes.

	PAGE
BURRI, R., & P. ANDREJEW— <i>Comparative Study of Coli-form Organisms</i>	91
HEILE— <i>Bacteriology of Appendicitis</i>	91
RUBINSKY, B.— <i>Micro-organisms in Koumiss</i>	92
CONN, H. J.— <i>Bacteria in Frozen Soil</i>	92
PEKLO, Y.— <i>Actinomycosis of Plants</i>	92
HOUSTON, A. C., & OTHERS— <i>Disease-carriers</i>	93
ROCHAIN, A., & A. DUFOURT— <i>New Types of Urobacteria</i>	93
JONG, D. A. DE— <i>Relation between Avian and Mammalian Tuberculosis</i>	93
TWORT, F. W.— <i>Jöhne's Bacillus</i>	94
ABDERHALDEN & OTHERS— <i>Enzymes in Different Bacteria</i>	94
LOGIE, W. J.— <i>Action of Dysentery Bacilli on Nitrites and Nitrates</i>	94
METCHNIKOFF, E.— <i>Intestinal Flora</i>	94
BIBLIOGRAPHY	94
SCHULTZE, W. H.— <i>Oxidizing and Reducing Properties of Bacteria</i>	244
WALKER, L. C.— <i>Chlorine Method of Water-purification</i>	244
BEVACQUA, A.— <i>Bacteriology of Landry's Paralysis</i>	244
BIERNACKI, W.— <i>Bacillus Nenckii: New Agar liquefying Organism</i>	245
CAMISA, G.— <i>Bacteriology of Chorra</i>	245
MONACO, E. I. LO— <i>Virulence of Pneumococcus and Streptococcus</i>	245
SANGIORGI, G.— <i>Mouse Epizootic due to a Coliform Bacillus</i>	246
McLAUGHLIN, A. J., & E. R. WHITMORE— <i>Characters of Cholera and Cholera-like Organisms</i>	246
PETHYBRIDGE, G. H., & P. A. MURPHY— <i>Bacterial Disease of Potato-plant</i>	247
AUMANN— <i>Distribution of Paratyphoid Bacilli</i>	402
BEIJERINCK, M. W.— <i>Acetobacter melanogenum</i>	402
NÈGRE, L.— <i>Agglutination of Micrococcus melitensis by Normal Sera</i>	402
MAUREL, E.— <i>Survival of Intestinal Organisms in Cooked Meats</i>	403
DARBOIS, P.— <i>Resistance of Micrococcus melitensis to Lactic Ferments</i>	403
AMBROZ, A.— <i>Thermobiosis</i>	403
PÉNAU, H.— <i>Bacterial Cytology</i>	404
PINOT, M. E.— <i>Sporotrichum beurmanni in Man</i>	404
HEWLETT, R. T.— <i>Soured Milk</i>	404
MERCIER, L., & R. DE DROUIN DE BOUVILLE— <i>Bacillary Disease among Fish</i>	405
PRINGSHEIM, H.— <i>Nitrifying Organisms in Soil</i>	405
BEIJERINCK, M. W.— <i>Absorption Phenomenon in Microbes</i>	521
MENDEL, Y.— <i>Fermentation of Sugars by Bacteria</i>	521
REMY, TH., & G. RÖSING— <i>Methods of Agricultural Bacteriology</i>	521
STROMBERG, H.— <i>Change of Biological Characters in Bacteria</i>	522
NTOSI, F.— <i>Strict Anaerobic Bacillus causing Purulent Pleurisy</i>	522
GALLI-VALERIO, R.— <i>Verruga peruanu</i>	522
LEVADITI, C., & C. TWORT— <i>Trypanotoxin of Bacillus subtilis</i>	522
DARWACKI, L.— <i>Presence of Streptotrichæ in Tuberculous sputum</i>	522
DOBELL, C. C.— <i>Cytology of the Bacteria</i>	523
PAVARINO, G. L.— <i>Bacterium Briosii</i>	523
GREIG-SMITH, R.— <i>Action of Wax-solvents and the Presence of Thermolabile Bacteriotoxins on Soil</i>	523
BULLOCH, W.— <i>Tuberculosis</i>	523
FORD, W. W.— <i>Bacteriology of Baltimore City Water</i>	524
PÉNAU, H.— <i>Minute Structure of Bacillus anthracis</i>	524
GRÜNBAUM & OTHERS— <i>Experimental Typhoid Fever</i>	524
PENFOLD, W. J.— <i>Variability of Intestinal Bacteria</i>	525
KÜHNEMANN, G.— <i>Capsule-formation of Typhoid Bacilli</i>	525
GALLI-VALERIO, B.— <i>Etiology of Rhinoscleroma</i>	525
PELZ, E.— <i>Nitrite-formation by Various Bacteria</i>	526
WALPOLE, G. S.— <i>Action of Bacillus Lactis Aerogenes upon Glucose</i>	526
MÜLLER, REINER— <i>Variations of Typhoid and Dysentery Bacilli</i>	526
BERTARELLI, E.— <i>Cultivation of Leprosy Bacillus</i>	526
BIBLIOGRAPHY	527

	PAGE
BARNARD, J. EDWIN— <i>A Method of Disintegrating Bacteria and other Organic Cells</i> (Plate XVIII. and Figs. 72, 73)	592
DISTAS, A.— <i>Bacillus Cellulosæ Deragregans</i> sp. n.	686
ELLIS, D.— <i>Spirophyllum ferrugineum</i>	686
OMELIANSKY, W. L., & O. P. SSEWEROWA— <i>Pigment of Azotobacter Chroococcum</i>	686
EBER, A.— <i>Human and Bovine Tubercle</i>	686
GUÉGUEN, F.— <i>Alopecia areata of Bacterial Origin</i>	687
DISTASE, A.— <i>Studies of the Intestinal Flora</i>	687
VERDERAME, PH.— <i>Sarcina Citrea conjunctivæ</i>	688
LOUIS-MELIKOV, J.— <i>New Anaerobe in Typhoid Stools</i>	688
MERCIER, L., & PH. LASSEUR— <i>Pathogenicity of Bacillus chlororaphis</i>	688
PETRIE, G. F., & G. H. MACALISTER— <i>Rat Plague in East Anglia</i>	688
JENSEN, O.— <i>Bacteriological Studies of Danish Butter</i>	689
WALKER, E. W. A.— <i>Variation and Adaptation in Bacteria</i>	689
BIBLIOGRAPHY	689
PAYARINO, G. L.— <i>Bacterial Diseases of Orchids</i>	802
HORI, S.— <i>Bacillus Cypripedii</i>	802
SMITH, E. F.— <i>Bacterium tumefaciens</i>	803
PAYARINO, G. L.— <i>Bacterium briosianum</i>	803
MEYER, KURT— <i>Anaerobic Streptothrix</i>	803
KÖNIGSFELD, H.— <i>Penetration of the Normal Skin by Tubercle Bacilli</i>	803
REVIS, C.— <i>Artificial Production of a permanently atypical Bacillus coli</i>	803
POLACCI, G.— <i>Parasite of Rabies and Plasmodiophora brassicæ</i>	803
BETEGH, I. V.— <i>Foot-and-mouth Disease</i>	804
BECKWITH, T. D.— <i>Diplococcus galidurum, the cause of the Reddening of Cod and other allied Fish</i>	804
JOHNSTON, J. R.— <i>Bacillus coli and Plant-diseases</i>	804
GASPARI, F. DE— <i>Bacillus pappulus</i>	804
BERNHARDT— <i>Scarlet-fever Virus</i>	804
KUFFERATH, H.— <i>Growth of Bacterium zopfii</i>	805
BIBLIOGRAPHY	805

MICROSCOPY.

A. Instruments, Accessories, etc.

(1) Stands.

	PAGE
NELSON, EDWARD M.— <i>Adams's "Variable" and the Evolution of the Modern Microscope.</i> (Figs. 25-30)	178
WINKEL'S <i>Stand No. 1</i> (Fig. 31)	248
.. <i>Travelling Microscope</i> (Fig. 32)	248
.. <i>Dissecting Microscope</i> (Fig. 33)	251
BECK'S <i>Loudon Microscope: Handle Model</i> (Fig. 43)	406
WINKEL'S <i>Stand No. 1d</i> (Fig. 44)	406
.. <i>Demonstration Microscope with Detachable Foot</i>	407
BIBLIOGRAPHY	407
OLD <i>Microscope by J. Simons: presented by Members of the Council</i> (Fig. 49) ..	528
REJTÖS <i>Metal-Microscope</i> (Figs. 50-52)	531
REICHERT'S <i>New Metal-Microscope</i> (Figs. 53-59)	532
GARJEANNE'S <i>Simple Excursion Microscope</i> (Figs. 74, 75)	690
WINKEL'S <i>Demonstration Microscope with Detachable Foot</i> (Figs. 76, 77) ..	692
SOMMERFELDT, E.— <i>Recent Progress in the Construction of Mineralogical and Metallurgical Microscopes</i>	693
AMANN, J.— <i>The Binocular Microscope</i>	806
CAMBRIDGE SCIENTIFIC INSTRUMENT Co.— <i>Comparator or Reading Microscope</i> (Figs. 87, 88)	807

(2) Eye-pieces and Objectives.

WATSON BAKER, F. W.— <i>Anomalies in Objective Screw Threads.</i> (Fig. 24)	175
EDINGER'S <i>Pointer-Double Ocular</i> (Fig. 34)	252
BIBLIOGRAPHY	253
NELSON, EDWARD M.— <i>On Some New Objectives and Eye-pieces by H. Winkel, of Göttingen</i>	451
WINKEL'S <i>Eye-piece with Screw Micrometer and Graduated Glass Diaphragm</i> (Figs. 60-61)	536
NELSON, E. M.— <i>The Society's Standard Thread</i>	537
ALLAN'S <i>Variable Eye-piece</i> (Fig. 78)	693

(3) Illuminating and other Apparatus.

BANFIELD, H. C.— <i>Sliding nose-piece for use in Stereo-photomicrography</i> (Fig. 4) ..	95
GAGE, H. P.— <i>Arc Lamps for Projection</i>	96
CÉPÈDE, C.— <i>Improvement in the Illumination of Objects observed with the Binocular Microscope</i>	96
JENTSCH'S <i>Ultra-condenser</i> (Figs. 5-7)	97
.. <i>Concentric Condenser</i> (Figs. 8, 9)	98
PONZO, M.— <i>Simple Method of making Drawings for Projection Purposes</i>	100
JENTSCH'S <i>Electric Heating Apparatus for Microscopical Observations</i> (Figs. 10-14)	100
SOMMERFELDT, E.— <i>New Method for Microscopical Metallography</i> (Fig. 35)	253
KÖHLER, A.— <i>Application of Mercury Light to Microscopical Works</i> (Fig. 36) ..	253
HEATH, C. E.— <i>New Microscope Lamp</i> (Fig. 37)	255
HILGER, ADAM— <i>Microspectroscope</i> (Fig. 38)	256
HIPPLE, H.— <i>Plug Micrometer</i> (Fig. 39)	256
BIBLIOGRAPHY	256
HOUSTON, R. A.— <i>Efficiency of Metallic Filament Lamps</i>	408
REICHERT'S <i>New Breath Screen</i> (Fig. 45)	408

	PAGE
HIMOFF, M.— <i>Improved Micrometer</i> (Figs. 46 & 47)	408
ZEISS, MESSRS. CARL— <i>Directions for using Glass Micrometers</i>	538
BECK, C.— <i>Interferometer</i> (Fig. 62)	539
KEELEY, F. J.— <i>Micro-spectroscopic Observation</i>	539
IGNATOWSKY, W. V.— <i>History of the Cardioid Condenser: Memorandum on the Leitz Mirror-condenser</i>	693
SCHAFFNIT, E.— <i>Apparatus for Microscopical Observation of Frozen Objects</i> (Fig. 79)	693
LEISS' <i>Universal Spectral Apparatus</i> (Figs. 80, 81)	694
SCHULZ, H.— <i>Glass Polarizing Prisms</i> (Figs. 82, 83)	697
BECKENKAMP, J.— <i>Aids to Crystalloptic Projection</i>	698
EMRYS-ROBERTS <i>Microscope Lamp</i> (Fig. 84)	698
TRIEPEL, H.— <i>Model of the Vibration-planes of Light in the Polarizing Apparatus</i> (Fig. 85)	698
LEITZ <i>Liliput Arc-lamp</i>	699
KÖHLER, A.— <i>New Nernst Lamp for Microprojection</i> (Figs. 89, 90)	808
STUDNICKA, F. K.— <i>Sliding-objective Changers and Revolvers</i>	810
KOENIGSBERGER, J.— <i>Methods for the Identification of Sub-microscopic Structures</i> (Figs. 91, 92)	810
NEW ZEISS <i>Nernst Lamp</i> (Fig. 93)	810
NELSON, E. M.— <i>Winkel's Drawing Microscope</i> (Figs. 94-96)	811
REICHERT'S <i>Dark-ground Illuminator with Arrangement for Centring on a Plain Stage</i> (Figs. 97-99)	814

(4) Photomicrography.

BARNARD, J. EDWIN— <i>A Simple Method of Obtaining Instantaneous Photomicrographs</i> (Fig. 1.)	19
" " " <i>On the Use of a Metallic Electric Arc in Photomicrography</i>	21
MÜLLER, R.— <i>Simple Object-holder for Photomicrography: Tables of Magnifications</i>	103
WRATTEN & WAINWRIGHT'S <i>Photomicrography</i>	103
BOYER, J.— <i>New Photographic Apparatus of the Paris School of Mines</i> (Fig. 15)	103
BIBLIOGRAPHY	105
BURLING, L. D.— <i>Photographing Fossils by Reflected Light</i> (Fig. 40)	257
SIITTA, E. J.— <i>A Report on the Grayson's Rulings presented by Mr. R. C. Beck to the Royal Microscopical Society</i>	449
LEITZ' <i>Small Photomicrographic Apparatus</i> (Fig. 63)	540
" " " <i>New Large Photomicrographic Apparatus</i> (Fig. 64)	541
" " " <i>Photomicrographic Apparatus for Photographing Insects</i> (Fig. 65)	543
BARNARD, J. E.— <i>Practical Photomicrography</i>	544
ORUETA, DOMINGO DE— <i>Apparatus for Photomicrography with the Microscope standing in any Position, especially in Inclined Position</i> (Figs. 70, 71)	588
BIBLIOGRAPHY	700
BAGSHAW, WALTER— <i>Instantaneous Exposure in Photomicrography</i>	721
PIGG, J. I.— <i>Stereoscopic Photomicrography</i>	816

(5) Microscopical Optics and Manipulation.

HAUSWALDT, HANS— <i>Interference Phenomena in Polarized Light</i> (Plate III.)	105
MERLIN, A. A. C. ELIOT— <i>On the Measurement of Grayson's New Ten-Band Plate</i>	160
WRIGHT, F. E.— <i>Transmission of Light through Transparent Inactive Crystal Plates, with special Reference to Observations in Convergent Polarized Light</i>	409
CHAUVEAU, M. A.— <i>Phenomena of Visual Inhibition which may accompany the re-association of the two Retinal Images dissociated by the Prisms of the Stereoscope. Conditions and determination of these Phenomena</i>	410
BIBLIOGRAPHY	410
AMANN, J.— <i>Ultramicroscopical Study of Solutions of Iodine</i>	545
BARUS, C.— <i>Elliptic Interference with Reflecting Grating</i> (Fig. 66)	545
BIBLIOGRAPHY	546
LENDERFELD, R. VON— <i>Observations on the Technical Execution and Biological Realization of Microscopical Measurements</i>	700
BELL, L.— <i>Opacity of Certain Glasses for the Ultra-violet</i>	700
BECK, C.— <i>Pupil of an Optical System with regard to Perspective</i> (Figs. 100, 101)	817

(6) Miscellaneous.

	PAGE
RAYLEIGH—Sensibility of the Eye to Variations of Wave-length in the Yellow Region of the Spectrum	106
QUEKETT Microscopical Club	106
BIBLIOGRAPHY	106
SHATTOCK, S. G.—Microscopic Structure of Uric Acid Calculi	258
SOBOTTA, Y.—Coloured Plates of Microscopical Preparations	258
GIACOMO, A. DE—Micro-chemical Demonstration of Guanin	258
JONNESCO, V.—Histological Changes in Infantile Paralysis	258
QUEKETT Microscopical Club	259
GUYE, P. A.—Infinitely Small Chemical Magnitudes	410
BAILY, F. G.—Stereoscopic Illusion (Fig. 48)	411
QUEKETT Microscopical Club	412
BIBLIOGRAPHY	413
QUEKETT Microscopical Club	546
MERLIN, A. A. C. E.—Some New Diatomic Structure discovered with a New Zeiss Apochromat	700
THE MICROLOGIST	701
GRIFFITHS, WALDRON—Principal Starches used as Food	701
BIBLIOGRAPHY	701
QUEKETT Microscopical Club	819

B. Technique.

(1) Collecting Objects, including Culture Processes.

PARK, W. R., & C. KRUMWIEDE—Cultivation of Human and Bovine Tubercle Bacilli	107
TWORT, F. W.—Method of Isolating and Growing the Leptra Bacillus of Man	107
BURROWS, M. T., & OTHERS—Artificial Cultivation of Animal Tissues	107
MAYER, O.—Modified Method of Isolating Typhoid and Paratyphoid Bacilli	108
DUDGEON, L. S., & OTHERS—New Method for Differentiation of Bacteria	109
DOMERGUE, F., & R. LEGENDRES—Rapid Method of Identifying Bacillus coli	109
GLASER, E., & Y. HACHLA—Selective Action of Dieudonné's Medium	260
LIACHOWETZKY, M.—New Method for Studying Movements of Bacteria	260
NICOLLE, C., & L. MANCEAUX—Methods of Investigating Oriental Sore	261
WOLLMAN, ENG.—Rearing Sterile Flies	261
HARTWELL, H. F., & E. C. STREETER—Bacillus of Acne	262
VOLPINO, G., & E. CLER—Examination of Water for Typhoid Bacilli by the Complement-fixation Method	547
DUCLAUX, J., & A. HAMELIN—Collodion Filters	548
GRENET & SALIMBENI—Resistance to Passage of Microbes through Collodion Filters	548
GUÉGUEN, F.—Rapid Method for Isolating Oospora linguialis	548
FRASER, ELIZABETH T.—Cultivation Medium for the Influenza Bacillus and Ducrey's Bacillus	549
NICOLLE, C., & L. MANCEAUX—Culture of Leishmania tropica on Solid Media	549
BIBLIOGRAPHY	549
ARNHEIM, G.—Cultivation of Spirochætes	819
SCHOUTEN, S. L., & A. W. NIEUWENHUIS—Pure Cultures from a Single Cell	819
NOGUCHI, H.—Cultivation of Spirochæta pallida	820
THALHEIMER, W.—New Method for making Blood-agar for Cultivating Bacillus influenzae	820

(2) Preparing Objects.

ELMASSIAN, M.—Examining the Salivary Glands of Ticks	109
HIRSCHFELDER, G.—Methods of Studying Rotifera	110
MEEK, W. O.—Method of Studying Phagocytosis by Endothelial Cells	110
POPPE, K.—Simple Shaker (Fig. 16)	111
SCHRIDDE, H.—Fixation and Embedding of Embryological Material	111

	PAGE
BIBLIOGRAPHY	112
WAGER, H.— <i>Demonstrating the Structure of the Yeast-cell</i>	262
JEFFREY, E. C.— <i>Investigating Nature of Supposed Algal Coals</i>	262
BEDAČ, K.— <i>Studying the Compound Eyes of Water-mites</i>	413
SCHULTZE, O.— <i>New Methods of Histological Technique</i>	549
MONTANARI, A.— <i>Effects of Pyridin Fixation upon Nervous Tissues</i>	702
SCHAFFNIT, E.— <i>Simple Washing Apparatus</i> (Fig. 86)	702
STRECKER, F.— <i>Simultaneous Fixing and Staining</i>	702
RAWITZ, B.— <i>Preparation of Kaiserling Material for Microscopical Purposes</i>	703
BÜDECKER, C. F.— <i>Celloidin Decalcification Method</i>	820
ZIEGLWALLNER, F.— <i>Fixation and Staining of Glycogen</i>	821
PUSCHKAREW, B.— <i>Studying Amœbæ</i>	821
ROMEIS, B.— <i>Washing and Dehydrating Apparatus</i> (Fig. 102)	822

(3) Cutting, including Embedding and Microtomes.

GEMMILL, F. J.— <i>Adaptation of Ordinary Paraffin Baths for Vacuum Embedding</i> (Fig. 3)	26
BERNER, O.— <i>Apparatus for Rolling Wax Plates</i> (Figs. 17, 18)	112
WILSON, J. T.— <i>Manipulation of Paraffin Sections</i>	113
MAYER, P.— <i>Tetrandr Microtome</i> (Figs. 19, 20)	113
MAIER, F.— <i>New Method of making Celloidin Serial Sections</i>	116
WILSON, J. T.— <i>Utilizing Organized Structures as Directing Marks for Plastic Reconstruction</i> (Figs. 21, 22)	116
MOZEJKO, B.— <i>Injection Preparations of Petromyzon</i>	263
LATIER, O. II.— <i>Demonstrating Presence of Starch in a Leaf</i>	263
SHATTOCK, S. G.— <i>Method of obtaining Sections of Urinary Calculi</i>	263
BIBLIOGRAPHY	264
RUTHERFORD, N. C.— <i>Modification of the Freiburg Method of putting on a Directing plane</i> (Richtungs-Ebene) for Reconstruction	549
LEITZ, E.— <i>Microtome-knives</i>	703
GRAYSON, H. J.— <i>Improvements in Rock-section Cutting Apparatus</i> (Plates XX. to XXIII.)	703
GRAYSON, H. J.— <i>Method of Slicing, Grinding, and Mounting Rock-sections</i>	706

(4) Staining and Injecting.

ACHARD, C.— <i>Distinguishing Dead from Living Leucocytes</i>	117
LENARTOWICZ, J. T., & K. POTRZOBOWSKI— <i>New Method of Demonstrating Spirochæta pallida</i>	118
FRÖHLICH, A.— <i>Use of Picramic Acid for Staining</i>	118
HATANO, S.— <i>Combined Staining Methods for Tubercle bacilli</i>	118
MOREL, C., & BASSAL— <i>Staining in bulk with Hæmatoxylin</i>	118
COLLIN, R., & M. LUCIEN— <i>Staining the Internal Network in Nerve-cells</i>	119
BALINT, S.— <i>New Methods of Demonstrating Plasmodes</i>	119
LOYEZ, MARIE, & J. NAGHOTTE— <i>Staining Celloidin Sections of Nervous Tissue by the Iron-hæmatoxylin Method</i>	119
PÖTTER, E.— <i>Staining the Medullary Sheath in Brain-sections</i>	120
SABRAZÈS, J.— <i>Staining Blood-films</i>	264
RENAUT, J.— <i>Demonstrating the Presence of Mitochondria in Cartilage-cells</i>	264
GHOUREYB, A. A. W.— <i>New and Quick Method for Staining Spirochætes in Smear Preparations</i>	265
DOBELL, C. C.— <i>Studying the Cytology of Bacteria</i>	413
GIEMSA, G.— <i>Rapid Staining with Giemsa's Azur-eosin Solution</i>	414
KROGH, MENTZ VON— <i>New Method of Chromatin Staining</i>	414
MASSEN, P.— <i>Saffron in Histological Technique</i>	414
SMITH, J. LORRAIN, & W. MAIR— <i>Staining of Fats</i>	549
SCHILLING, C.— <i>Apparatus for Romanowsky Staining</i> (Fig. 67)	550
ROSENBLAT, S.— <i>Methods of Staining Tubercle Bacilli</i>	550
TOBLER, F.— <i>Improved Method of Iodine Staining</i>	551
REITTERER, E., & A. I. ELIÈVRE— <i>Method for Studying Osseous Tissue</i>	551

	PAGE
KOWALLIK, G.— <i>Staining Bordered Pits</i>	709
VIALLETON, L., & A. JUILLET— <i>Injection of Fusible Alloys in Microscopical Anatomy</i>	822
EURICH, F. W.— <i>New Method for the Detection of Tubercle bacilli in Sputum</i>	823
FISCHER, H.— <i>Negative Staining of Bacteria</i>	823

(5) Mounting, including Slides, Preservative Fluids, etc.

BROQUET, C.— <i>Method of Preserving Plaque Material</i>	120
BENTLEY-TAYLOR <i>Method of Mounting Mosquitos</i>	120
NEUMAYER, I.— <i>Celloidin in Microscopical Technique</i>	121
GREENISH, H. G.— <i>Microscopical Examination of Foods and Drugs</i> (Fig. 123)	121
HERZOG, G.— <i>Drop-bottle for Preventing the Action of Air on Copper-oxide-ammonia Solution</i> (Fig. 23)	122
KRAUSE, F.— <i>Simple Arrangement for Determining the Sinking-velocity of Plankton Organisms</i>	122
BÁLINT, S.— <i>New Mounting Medium for Botanical Preparations</i>	265
COLES, A. C.— <i>Fading of Anilin-stained Microscopical Preparations and a New Medium</i>	415
LANGERON, M.— <i>Mounting Arthropoda in AMAUX'S Chloralphenol</i>	416
HEATH, C. E.— <i>Fluid Mounting</i>	551
AMANN, Y.— <i>Direct Enumeration of Bacteria in Water</i>	552
LIESEGANG, R. E.— <i>Method of Preserving Brain Sections</i>	552

(6) Miscellaneous.

GEMMILL, F. J.— <i>Aerator Suitable for Laboratory Aquaria</i> (Fig. 2)	24
DELCOURT, A.— <i>Immobilizing Flies for Microscopic Investigation</i> (Fig. 41)	266
SEYMOUR-JONES, A.— <i>Anthrax Sterilization Process applied to Hides in Dry State</i>	265
TAIT, W. H.— <i>Self-regulating Siphon</i> (Fig. 42)	267
SABOURAUD, R., & A. VERNES— <i>Filtering by Aid of the Centrifuge</i>	267
MASTIN, JOHN— <i>Polishing Metallic Preparations for Microscopical Examination</i>	267
MOROSOFF, M.— <i>New Forceps</i>	416
FOX, C. P.— <i>Film Test for Crude Rubber</i>	416
PERMIN, C.— <i>Improved Form of Graduated Pipette</i> (Fig. 68)	553
HALL, M. C.— <i>Method of Examining Faces for Evidences of Parasitism</i>	554
R. & J. BECK'S <i>Grinding and Polishing Machine for making Microscopical Specimens for Metallurgical Work</i> (Fig. 69)	554
BREED, R. S.— <i>Enumeration of Bacteria in Milk</i>	710
STARCKE, A.— <i>Preserving Brains</i>	824
PAWSON, C. F., & H. P. BASSETT— <i>Turbidometer for Counting Vaccines</i>	824
LANGE— <i>Agglutination of Trypanosomes</i>	824
BIBLIOGRAPHY	825

Metallography, etc.

BENEDICKS, C.— <i>Polymorphism of Zinc</i>	123
BRECKENRIDGE, J. M.— <i>Aluminium-calcium Alloys</i>	123
MASING, G., & G. TAMMANN— <i>Alloys of Lithium</i>	123
URASOW, G. G., & R. VOGEL— <i>Gold-magnesium Alloys</i>	123
BRUNI, G., & E. QUERCIGH— <i>Silver-cadmium Alloys</i>	123
KURNAKOW, N., & OTHERS— <i>Silver-copper Alloys</i>	124
QUERCIGH, E.— <i>Silver-sodium Alloys</i>	124
BRUNI, G., & OTHERS— <i>Ternary Alloys of Magnesium, Zinc, and Cadmium</i>	124
PARRAVANO, N., & E. VIVIANI— <i>Alloys of Copper, Antimony, and Bismuth</i>	124
HEYN, E., & O. BAUER— <i>Heat-treatment of Bronze</i>	124
BARADUC-MÜLLER, L.— <i>Metallic Silicides</i>	125
JOHNSON, F.— <i>Impurities in Copper</i>	125
DONNAN, F. G., & T. W. A. SHAW— <i>Solubility of Oxygen in Molten Silver</i>	125

	PAGE
KROLL, A.— <i>Crystallography of the Iron-carbon System</i>	125
LÜTKE, H.— <i>Iron-carbon Alloys</i>	125
GOERENS, P., & H. MEYER— <i>Transformation-point Curve γ-to β- or α-Iron</i>	126
SCHOLS, C.— <i>Influence of Silicon on the Maximum Solubility of Carbide of Iron in γ-Iron</i>	126
FRIEDRICH, K.— <i>Iron Sulphide-iron System</i>	126
RUER, R., & E. SCHÜZ— <i>Iron-nickel System</i>	126
BURGESS, C. F., & OTHERS— <i>Iron-nickel-copper Alloys</i>	127
BIBLIOGRAPHY	127
BRONIEWSKI, W.— <i>Aluminium-silver Alloys</i>	268
GRENET, J.— <i>Quenching of Bronzes</i>	268
HAGUE, A.— <i>Bearing Metals</i>	268
SIEVERTS, A., & W. KRUMBHAR— <i>Behaviour of Copper towards Gases</i>	268
JANECKE, E.— <i>Ternary Systems</i>	269
PORTEVIN, A.— <i>Cementation by Gases</i>	269
GIOLITTI, F., & OTHERS— <i>Cementation of Steel</i>	269
WEYL, F.— <i>Cementation in a Vacuum</i>	269
WÜST, F., & H. L. FELSER— <i>Influence of Segregation on the Strength of Mild Steel</i>	270
GOERENS, P.— <i>Gases in Commercial Steel and Iron</i>	270
JOISTEN, A.— <i>Grain-size in Iron</i>	270
HILPERT, S.— <i>Magnetic Properties of the Modifications of Iron</i>	270
GERTLER, W.— <i>Iron-nickel Meteorite</i>	270
BARRETT, W. F.— <i>Historical Note on Recalescence</i>	270
EDWARDS, C. A.— <i>Theory of Hardening Carbon Steels</i>	271
BRAYSHAW, S. N.— <i>Hardening of Carbon and Low-tungsten Tool-steels</i>	271
MATWEIEFF— <i>Slag in Steel</i>	271
BRIDGMAN, P. W.— <i>Action of Mercury on Steel at High Pressures</i>	272
HAGUE, A., & T. TURNER— <i>Influence of Silicon on Cast Iron</i>	272
COE, H. I.— <i>Manganese in Cast Iron</i>	272
WAWRZINIK, O.— <i>Fixing Objects to Stage</i>	273
ROBIN, F.— <i>Photomicrographic Apparatus</i>	273
HILPERT, E., & E. COLVER-GLAUBERT— <i>Sulphurous Acid as an Etching Medium</i>	273
SMITH, J. H.— <i>Fatigue of Metals</i>	274
BAUME, G.— <i>Measurement of Hardness</i>	274
ANDRADE, E. N. DA C.— <i>Viscous Flow in Metals</i>	274
BORNEMANN, K., & P. MÜLLER— <i>Electrical Conductivity of Molten Alloys</i>	274
SOMERVILLE, A. A.— <i>Temperature Coefficients of Electrical Resistance</i>	274
PASSOW, H.— <i>Microscopical Examination of Blast-furnace Slag</i>	275
BIBLIOGRAPHY	275
BORNEMANN, K.— <i>Nickel-sulphur System</i>	416
PELLINI, G., & E. QUERCIGH— <i>Tellurides of Sodium and of Silver</i>	416
KOBAYASHI, M.— <i>Tellurium Alloys</i>	416
COSTE, M.— <i>Gold-tellurium System</i>	416
GEIBEL, W.— <i>Alloys of the Noble Metals</i>	417
COHEN, E., & K. INOUE— <i>Physico-chemical Studies of Lead</i>	417
COHEN, E., & P. J. H. VAN GINNEKEN— <i>Zinc Amalgams</i>	417
BARLOW, W. E.— <i>Alloys of Cadmium, Bismuth, and Lead</i>	417
BENGOUGH, G. D., & O. F. HUDSON— <i>Heat-treatment of Brass</i>	417
PRIMROSE, H. S.— <i>Metallography as an Aid to the Brassfounder</i>	418
EWEN, D., & T. TURNER— <i>Shrinkage of the Antimony-lead Alloys</i>	418
JOHNSON, F.— <i>Effect of Silver, Bismuth and Aluminium upon Copper</i>	418
GUILLEMIN, G., & B. DELACHANAL— <i>Ocluded Gases in Copper Alloys</i>	418
LIESCHING, T.— <i>Influence of Sulphur on the Iron-carbon System</i>	418
CHATELIER, H. LE— <i>Spontaneous Disintegration of Aluminium</i>	555
.. .. . <i>Metallographic Notes</i>	556
MATHEWSON, C. H.— <i>Alloys of Sodium with Silver and Gold</i>	556
PARRAYANO, N.— <i>Ternary System, Silver-tin-lead</i>	556
LOEBE, R.— <i>Ternary Alloys of Lead, Tin and Antimony</i>	556
PELLINI, G., & E. QUERCIGH— <i>Gold Tellurides</i>	557
JOYNER, R. A.— <i>Amalgams containing Silver and Tin</i>	557
BERRY, A. J.— <i>Occlusion of Hydrogen by Palladium-gold Alloys</i>	557
MORRIS, H. J., & A. MCWILLIAM— <i>Properties of Cast and Rolled Gold Plate</i>	557

	PAGE
JÄNECKE, E.— <i>Flow-pressure of Tin</i>	557
KIRNER, J.— <i>Influence of Nitrogen on Cementation of Steel</i>	558
LANG, G.— <i>Influence of Manganese on Mild Steel</i>	558
BAYKOFF, A., & H. LE CHATELIER— <i>Iron-carbon System</i>	558
PORTEVIN, A.— <i>Iron-antimony Alloys</i>	558
KRÖHNKE, O.—“ <i>Graphitic</i> ” <i>Cast-iron</i>	559
GIOLITTI, F., & OTHERS— <i>Malleable Cast-iron</i>	559
HATFIELD, W. H.— <i>Precipitation of Free Carbon in the Iron-carbon System</i>	559
BENEDICKS, C.— <i>Synthesis of Meteoric Iron</i>	559
WINTER, H.— <i>Effect of Galvanizing on Strength of Steel Wire</i>	559
CAMPBELL, W.— <i>Annealing of Steel</i>	559
BERNOULLI, A. L.— <i>Thermo-electric Forces of Solid Solutions</i>	560
DESCH, C. H.— <i>Defects in Alloys</i>	560
BENEDICKS, C., & A. LOTTERMOSE— <i>Solid Colloid Systems in Metallography</i>	560
MULLER, P.— <i>Electrical Conductivity of Molten Alloys</i>	560
BORNEMANN, K.— <i>Equilibrium Diagrams</i>	560
JÄNECKE, E.— <i>Ternary Systems</i>	561
PORTEVIN, A.— <i>Pseudo-binary Alloys</i>	561
SAUVEUR, A.— <i>Apparatus for Microscopical Examination of Metals</i>	561
ROBIN, F., & P. GARTNER— <i>Colour-etching of Steel</i>	561
FAUST, O., & G. TAMMANN— <i>Limits of Elasticity, and the Hardening of Metals</i>	562
GUILLET, L.— <i>Reheating of Cold-worked Metals</i>	562
HEYN, E., & O. BAUER— <i>Stresses in Cold-worked Metals</i>	562
GRIS, LE.— <i>Simplification in Technique of Metallography</i>	562
LOSEW, K.— <i>Composition of Eutectics</i>	563
BRONIEWSKI, W.— <i>Electrical Conductivity of Alloys</i>	563
WAGNER, E.— <i>Electrical Conductivity of Molten Metals</i>	563
JOHNSTON, J., & L. H. ADAMS— <i>Influence of Pressure on the Melting-points of Metals</i>	563
BIBLIOGRAPHY	
CARPENTER, H. C. H., & C. A. EDWARDS— <i>New Critical Point in Copper-zinc Alloys</i>	710
ROSENHAIN, W., & S. L. ARCHBUTT— <i>Alloys of Aluminium and Zinc</i>	711
WILM, A.— <i>Aluminium Alloys containing Magnesium</i>	711
MAZZOTTO, D.— <i>Lead-tin Alloys</i>	711
BRUNI, G., & D. MENEGHINI— <i>Formation of Solid Metallic Solutions by Diffusion in the Solid State</i>	712
FRILLEY, R.— <i>Alloys of Silicon with Metals</i>	712
GUICHARD, M.— <i>Extraction of Gases from Copper</i>	712
BENEDICKS, C.— <i>Crystallization of White Cast-iron</i>	712
GUILLAUME, C. E.— <i>Changes occurring in Nickel Steel</i>	713
BENEDICKS, C.— <i>Orvik's Iron</i>	713
GIOLITTI, F., & OTHERS— <i>Cementation of Alloy Steels</i>	713
GUERTHER, W.— <i>Structure of Galvanized Iron</i>	713
STEAD, J. E.— <i>Welding-up of Blow-holes and Cavities in Steel Ingots</i>	713
LAW, E. F., & OTHERS— <i>Some Studies of Welds</i>	714
ROBIN, F.— <i>Resistance of Steels to Abrasion and to Crushing</i>	714
GRIS, LE.—“ <i>Filiations</i> ” of <i>Metallic Alloys</i>	715
PRAUSS, S.— <i>Jointed Arm for Workshop Microscope</i>	715
BENGOUGH, G. D., & J. T. CORNER— <i>Corrosion of Metals</i>	715
HOWE, H. M.— <i>Nucleus Action and Grain-growth</i>	716
NATIONAL Physical Laboratory	716
BRONIEWSKI, W.— <i>Aluminium-magnesium Alloys</i>	825
VOURNASOS, A. G.— <i>Bismuthides</i>	825
JOLIBOIS, P., & OTHERS— <i>Arsenides of Tin</i>	825
PRERENKO, G. J., & A. S. FEDOROW— <i>Alloys of Silver with Cadmium</i>	825
PÉLABON, H.— <i>Selenium-antimony System</i>	826
GIEBEL, W.— <i>Alloys of Noble Metals</i>	826
RUER, N., & N. ILJIN— <i>Iron-carbon System</i>	826
CARPENTER, H. C. H.— <i>Growths of Cast-irons after repeated Heatings</i>	826
GONTERMANN, W.— <i>Iron-silicon-carbon Alloys</i>	826
LEVY, D. M.— <i>Malleable Castings</i>	827
COLVER-GLAUERT, E., & S. HILPERT— <i>Magnetic Properties of Nickel Steels</i>	827

	PAGE
PORTEVIN, A.— <i>Chromium Steels</i>	827
MCWILLIAM, A., & E. J. BARNES— <i>Nickel Steels</i>	827
MCWILLIAM, & OTHERS— <i>Influence of Vanadium on Iron and Steel</i>	827
MCCANCE, A.— <i>Troostite</i>	827
OKNOFF, M.— <i>Internal Structure of Pearlitic Steel</i>	828
LANGE, E. F.— <i>Crystallization of Steel</i>	828
COBB, J. W.— <i>Influence of Impurities on the Corrosion of Iron</i>	828
TAMMANN, G.— <i>Changes in Properties of Metals upon Working</i>	828
LORENZ, R., & OTHERS— <i>Metallic Fog in Fused Salts</i>	828
DESCH, C. H.— <i>Crystallization of Cast Metals</i>	828
BIBLIOGRAPHY	828

PROCEEDINGS OF THE SOCIETY.

Meeting, December 21, 1910	128
.. January 18, 1911	132
.. February 15,	276
.. March 15,	280
.. April 19,	419
.. May 17,	425
.. June 28,	565
.. October 18,	831
.. November 15,	835

GENERAL INDEX TO VOLUME	841
---------------------------------	-----

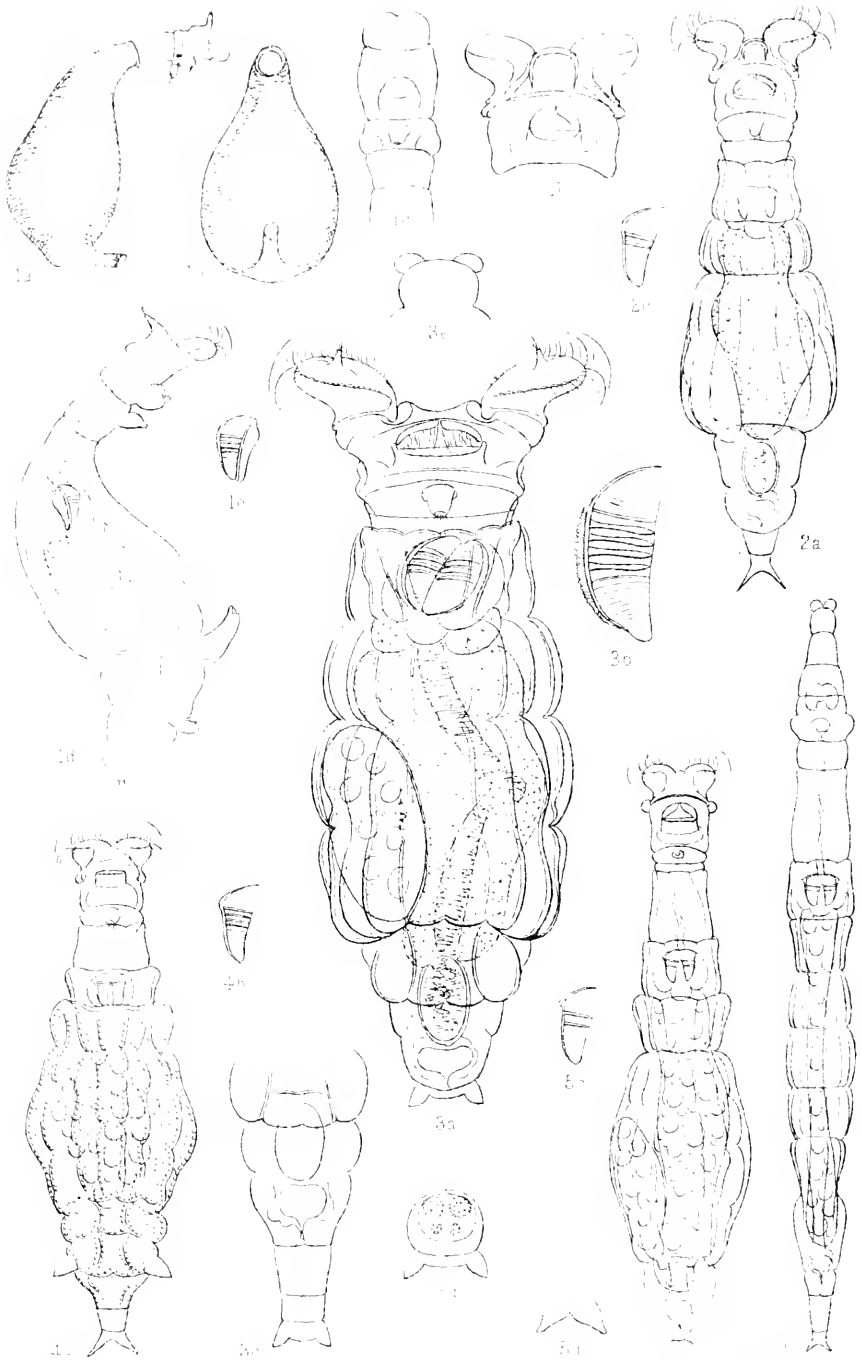

J. Murray, del. et sculp.

West, New York, photo lith.

African Rotifers

JOURNAL
OF THE
ROYAL MICROSCOPICAL SOCIETY.

FEBRUARY, 1911.

TRANSACTIONS OF THE SOCIETY.

I.—*Some African Rotifers: Bdelloida of Tropical Africa.*

By J. MURRAY, F.R.S.E. F.Z.S.

(Read December 21, 1910.)

PLATES I. AND II.

THESE notes on African Rotifers are rendered possible by the kindness of various friends, who have sent me mosses from different parts of tropical Africa. The material for a previous paper on the same subject was provided by Mr. N. D. F. Pearce, of Cambridge, and the results appeared in this Journal in 1908 (19).*

* The figures in brackets refer to the Bibliography at the end of paper.

EXPLANATION OF PLATE I.

- Fig. 1a.—*Habrotrocha caudata* sp. n. Lateral view of animal in its case.
,, 1b.— Ditto. Dorsal view of empty case.
,, 1c.— Ditto. Dorsal view of head.
,, 1d.— Ditto. Animal without its case, more highly magnified.
,, 1e.— Ditto. Jaw.
,, 2a.—*Callidina allani* sp. n. Dorsal view, feeding.
,, 2b.— Ditto. Head, to larger scale, showing horse-shoe mark.
,, 2c.— Ditto. Jaw.
,, 3a.—*Philodina*. Undescribed species, resembling *Mniobia russeola*.
,, 3b.— Ditto. Jaw.
,, 3c.— Ditto. Rump and foot.
,, 3d.— Ditto. Spurs and toes.
,, 3e.— Ditto. Rostrum and lamellæ.
,, 4a.—*Habrotrocha appendiculata* sp. n. Dorsal view.
,, 4b.— Ditto. Jaw.
,, 5a.—*H. brocklehursti* sp. n. Dorsal view, feeding.
,, 5b.— Ditto. Dorsal view, fully extended.
,, 5c.— Ditto. Jaw.
,, 5d.— Ditto. Spurs.

Feb. 15th, 1911

B

During 1910 Mr. A. Allan, of Kiknyu, British East Africa, was good enough to send frequently large parcels of moss, properly collected and dried, in which there were found numerous Bdelloid Rotifers, including several interesting and some new species.

Sir Philip Brocklehurst, on a hunting tour in the same region, kindly collected moss on a mountain 6000 feet high.

Mr. Allan's collections were from different localities and altitudes, of which he sent details in letters, but unfortunately this useful information cannot be used to discriminate the species from the different altitudes, as, owing to postal delays and irregularities, we often could not tell to which of several parcels an explanatory letter referred.

The species in this list appear under several unfamiliar generic names, which require a word of explanation. These genera, which include many old friends among the species, are adopted from Mr. Bryce's recently published Classification of the Bdelloids (5). The new genera represented in our list are three in number.

Pleuretra includes 4-toed Bdelloids (formerly *Callidina*) which have a stiff leathery trunk, deeply plicate, the folds on the ventral side transverse. (Species *alpinum*, *brycei*, *humerosa*.)

Mniobia includes those species (formerly *Callidina*) which have no distinct toes, but a discoid sucker instead. (Species *tetraodon*, *scarlatina*, *symbiotica*, etc.)

Habrotrocha includes all the pellet-making *Callidina*, except one or two very aberrant forms, which have been made into distinct genera. (Species *constricta*, *lala*, *perforata*, etc.)

The genera *Philodina* and *Callidina* remain as before, but restricted by the separation of the groups defined above, and of some others which are not represented in our list. The genus *Rotifer* is scarcely affected, but is more strictly defined, and receives a few viviparous species, previously regarded as *Callidina*.

In all descriptions as many of the principal dimensions as possible are given. These are not meant as hard and fast data, of specific importance. The species vary somewhat in size. They are intended to give the relative proportions with sufficient accuracy to enable one who knows the Bdelloids well to construct a figure which would give some idea of the appearance if the original drawing were lost.

The species in Sir Philip Brocklehurst's collection are not numerous—there were only four species of Rotifera and a few Tardigrada. Nevertheless, two of the Rotifera are new to science. One of these is known to Mr. Bryce, and will be described by him. The other I name after the finder. These facts indicate the assistance which can be rendered to science by sportsmen, when they are thoughtful enough amid the excitements of the chase to pocket a little moss as occasion offers in those remote regions to which they penetrate.

In this paper I am enabled to add to the results obtained from Mr. Pearce's material three species which were not so completely studied as to be published with the others. They are two tubedwelling species of *Habrotrocha*, *H. caudata* and *H. ampulla*, and a *Mniobia*, *M. scabrosa*. Only dead specimens were got in Mr. Pearce's moss. The animals have since been seen alive, both in Central and South Africa (and *M. scabrosa* even in Australia), and fuller studies have thus been rendered possible.

LIST OF SPECIES.

<i>Philodina rugosa</i> Bryce (4).	<i>M. scarlatina</i> Ehr. (10).
<i>P. plena</i> Bryce (3).	<i>M. scabrosa</i> sp. n.
<i>P. vorax</i> Janson (12).	<i>Rotifer longirostris</i> Janson (12).
<i>Pleuretra alpium</i> Ehr. (10).	<i>Habrotrocha perforata</i> Murray (15).
<i>P. brycei</i> Weber (23).	<i>H. caudata</i> sp. n.
<i>P. humerosa</i> Murray (14).	<i>H. ampulla</i> sp. n.
<i>Callidina habita</i> Bryce (3).	<i>H. longiceps</i> Murray (17).
<i>C. formosa</i> Murray (15).	<i>H. pusilla</i> Bryce (2).
<i>C. plicata</i> Bryce (1).	<i>H. acoruis</i> sp. n.
<i>C. punctata</i> sp. n.	<i>H. constricta</i> Duj. (7).
<i>C. allani</i> sp. n.	<i>H. appendiculata</i> sp. n.
<i>C. papillosa</i> Thomp. (22).	<i>H. brocklehursti</i> sp. n.
<i>C. aculeata</i> Milne (13).	<i>H. auriculata</i> sp. n.
<i>C. multispinosa</i> Thomp. (22).	<i>Adineta vaga</i> Davis (6).
<i>C. pinniger</i> Murray (19).	<i>A. barbata</i> Janson (12).
<i>Mniobia tetradon</i> Ehr. (9).	<i>A. longicornis</i> Murray (15).
<i>M. russeola</i> Zel. (24).	

NOTES ON THE SPECIES.

Philodina plena Bryce (3).

Synonym: *Callidina plena*.

The egg of *Philodina plena* is of unusual form. It is elliptical, with both poles produced into processes. It is not circular in transverse section, but a good deal flattened. Looking at its broad side, the whole outline shows a series of rounded knobs. Looking at the narrow side, the projections are seen to be rounded ridges, which are highest at the side and die out on the flat surface of the egg. They are like interrupted annulæ. In examples from Kikuyu there were about ten of these prominences, including those at the poles.

Philodina vorax Janson (12).

Synonym: *Callidina vorax*.

This species appears to be commoner in warm climates than in temperate. In Kikuyu it appears as a distinct variety, smaller than the type, and with the spurs narrower and with very small points.

Philodina rugosa Bryce (4).

This is the most frequent member of the genus in washings of mosses, and it occurs almost constantly in collections from tropical and sub-tropical countries. Abundant.

Philodina sp. Plate I. figs. 3a-3c.

A very remarkable species. I found it in Mr. Allan's moss, and figured and described it as a new species for inclusion in this paper, when I learned from Mr. Bryce that it had been previously found in South Africa by Mr. Milne. I have let the figure remain, as it was already drawn on the plate, and give a brief description here, while awaiting Mr. Milne's name.

Description.—Large and very stout; length, when feeding, 400μ ; diameter of corona, 150μ ; neck, 80μ ; trunk, 140μ ; across spurs, 35μ . Disks large, and sulcus as wide as disk; central peg-like papillæ on disks. Rostrum broad, lamellæ separate. Antenna moderate. Jaws large, 40μ long, with four or five teeth in each. Segments of trunk deeply constricted and plicate. Foot, 4-jointed: spurs, thick cones, separated by wide interspace. No eyes.

The most remarkable feature about this animal is its almost perfect mimicry of *Mniobia russeola*. It has the same stout figure, large corona, wide sulcus, peg-like central papillæ, spurs, numerous teeth, and red colour. Only the toes distinguish it. The difference between four or five teeth and six or seven teeth is not striking at a casual glance. Unless the toes happen to be noticed, it is very likely to be recorded as *russeola*. Abundant.

Pleuretra alpium Ehr. (10).

Synonym: *Callidina alpium*.

There is a form of *Pleuretra* which is common in warm climates, and differs conspicuously from the type, and which I yet hesitate to separate, on account of the absence of salient features. It differs from the type in its small size and lack of the warm brown colour. In size and colour it is like *P. humerosa*, yet it differs still more from that, having fewer transverse ventral folds, and lacking the peculiar characters of rostrum and face which distinguish that species. The spurs are slender, straight, parallel, and separated by a wide interspace.

Pleuretra brycei Weber (23).

Synonym: *Callidina brycei*.

Variety: distinctive characters.—Main dorsal row of processes consisting of eight blunt conical knobs and two low rounded knobs

(the outer processes at each end of the row): lateral knobs, two at each side; spines on anterior margin of trunk very small; two papillæ on preanal; semicircular lobe on first foot joint.

The differences from the commonest form are not great, the chief being the different form of the end spines of the main row, and the reduction of the anterior spines. Weber does not mention the lateral spines, or those on the preanal, but these are present in the majority of the forms. Another form has the dorsal row normal, and is strongly papillose.

Callidina formosa Murray (15).

Callidina formosa also seems to prefer warm climates. The Central African form differs from the type in having the foot and anal segment smooth, and the papillæ on the preanal very small. In the type the large papillæ continue on to the rump, and even to the first foot joint, scarcely reduced in size.

Callidina punctata sp. n. Plate II. figs. 11a-11d.

Specific characters.—Of moderate size, stout; colour dull opaque yellow, reddish in central parts; corona large; collar prominent; upper lip divided into two elevated lobes; antenna short; teeth $\begin{matrix} 2 + 1 \\ 1 + 2 + 1 \end{matrix}$ in each jaw; skin of trunk strongly stippled; foot and spurs papillose; foot, 4-jointed; spurs, divergent, obtuse, or subacute, with small interspace.

General description.—Measurements of a small example: length, 225 μ ; diameter of trunk, 75 μ ; corona, 58 μ ; neck, 46 μ ; across jaws, 25 μ . Though the average size is small, it occasionally attains to considerable dimensions. There are central papillæ and setæ on the disks. The rostrum is short and thick, and the lamellæ are separated. The length of the antenna is half the diameter of the neck. The lobes of the upper lip, which are like those of *Callidina habitata*, can be separated. The jaw has a broad border, and the principal teeth are very thick. The whole trunk and foot are dotted. The dots sometimes appear as papillæ between the folds of the trunk. On the foot, and especially the spurs, they are distinct papillæ. The spurs vary somewhat in form, being longer or shorter, obtuse or subacute, with the interspace sometimes nearly obliterated. The toes are small and short. The walls of the stomach contain large reddish globules. The egg is elliptical, with both poles produced, like that of *C. habitata* and *C. plicata*, etc. It measures 120 μ by 60 μ .

C. punctata is closely related to *C. plicata*, though it is not very like it in general appearance. It differs in many points—the stouter form, deep colour, different form of upper lip (which has,

however, a trace of the "keystone" of *C. plicata*), dotted skin, and total lack of the anal flanges (which become the "tails" of variety *hirundinella* Murray). The spurs are not so different, except in being papillose.

Kikuyu; also known in Australia and Hawaii (Brit. Antarctic Exped., 1907-9).

Callidina allani sp. n. Plate I. figs. 2a-2c.

Specific characters.—Size moderate; trunk ovate, plicate; corona less than trunk, sulcus about half as wide as disk; collar small; a horseshoe-shaped mark on the upper lip; rostrum broad, antenna short and very slender; jaw triangular, teeth 2/2; rump sharply marked from trunk, preanal subquadrate, anal rounded; foot short, of three segments, spurs relatively large, slender, divergent, without interspace.

General description.—Length, when feeding, 300 μ , diameter of corona 60 μ , collar 45 μ , neck 40 μ , trunk 85 μ , preanal 50 μ , tip to tip of spurs 25 μ , length of spur 15 μ . The animal is hyaline, and the longitudinal skinfolds are wide and shallow. The upper lip is undivided—the skinfold from the collar diminishes in thickness towards the lip and passes over the top of the horseshoe mark. This is thickest at the top; and tapers to the ends. The jaw is triangular, and is constricted just below the widest part. The two teeth are about centrally placed in the length of the jaw. The two segments of the rump have a characteristic constant form—the preanal has nearly parallel sides—the anal is rounded posteriorly.

Callidina allani belongs to the group of species resembling *C. habita* and *C. plicata*. The horseshoe mark on the head distinguishes it from all other species. It may correspond to the keystone mark on the upper lip of *C. plicata*, but in that there is no ridge, but simply fine lines. The form of spurs and the small and very slender antenna are further points of correspondence with *C. plicata*. The affinity is not close. *C. punctata* is much closer to *C. plicata*. *C. allani* has some affinity with *C. chrenbergi* Janson (12), which also has the upper lip undivided.

Kikuyu; fairly plentiful.

Callidina sp. ? Plate II. fig. 9.

Description.—Small, hyaline, trunk closely plicate; corona small; no teeth, but very fine striae; foot short, spurs short, obtuse. Antenna short.

Length 250 μ , greatest width of trunk 50 μ , across spurs 15 μ , length of jaw 15 μ . The rostrum is narrow and the lamellæ fairly large. The corona was not seen expanded, but it can be seen to be small, the disks being joined to form a reniform body. The gullet

is long. No teeth, in the ordinary sense, can be distinguished, but the whole jaw is crossed by excessively fine striæ, such as are found on the jaws of all Bdelloids, in addition to the thicker teeth. A ciliated tube could be distinguished in the lower part of the stomach. The foot is 3-jointed. Toes not seen.

Incomplete though the study is, this is obviously an animal of importance. The characters of the corona and jaws would indicate a pellet-maker, but the narrow alimentary tube shows that it is not. According as the fine striæ on the jaws are regarded as teeth or not, the animal may be supposed to approximate to Ehrenberg's *Callidina elegans* (8) or to his *C. edentata* (11), a suggestion made on the strength of the name alone, as I have not been able to find the diagnosis. Mr. Bryce (5) has shown that *C. elegans* possesses, according to Ehrenberg, a long foot and long spurs.

In the genus *Callidina*, to which this animal seems to belong, there are no species having numerous fine teeth (when we except *C. elegans*). Among the pellet-makers the distinction between the striæ and teeth is frequently not at all clear.

Callidina papillosa Thomp. (22).

Synonym: *Macrotrachela papillosa*.

The species of the group which include *Callidina papillosa* and *C. multispinosa* are so extremely variable that they are very puzzling to students. As there appear to be peculiar forms in almost every land, it is always desirable to add as many details as can be observed, not merely recording the occurrence of the species.

The Central African form is of moderate size, fairly typical in the arrangement of the warts. The teeth are only two in each jaw. The mouth has a rosette of ridges surrounding it, as in *Rotifer longirostris*. The form is almost identical with one found by Mr. Milne in South Africa.

Callidina aculeata Milne (13).

Synonym: *Macrotrachela aculeata*.

Like all of the group of species to which it belongs (the *multispinosa* group) *C. aculeata* is extremely variable. The Central-African form is very spiny. There are five transverse rows of spines on the dorsal side of the trunk, two on the anterior trunk, one at the broadest part of the central trunk, and two others behind it, the last doubtfully on the 4th central or preanal segments. There are many small spines on the rump and more on the foot. The first foot-joint has a distinct annular swelling. The dental formula is 2/2.

A very similar form occurs in Canada.

Callidina multispinosa Thomp. (22).Synonym: *Macrotrachela multispinosa*.

Several distinct varieties occurred. They are briefly described here, but not figured, as there is in preparation a study of all the forms of this and the related species, in which all the important varieties will be figured.

Variety *brevispinosa* Murray (19).—This form was first described from Tropical Africa, where it occurred in Old Calabar, Uganda, and Madagascar.

The short-spined forms, with very few exceptions, have the dental formula 2/2, an important distinction from the long-spined forms, which have from three to five teeth in each jaw.

Forma.—Several of the lateral spines on the anterior trunk replaced by ligular processes, with bulbous bases; dorsal transverse row of spicules on widest part of central trunk lacking; spurs slender, widely separated; dental formula 2/2.

This appears to be a stable variety, possibly a distinct species. There is an almost identical form in South Africa.

Variety.—One longish lateral spine on the anterior edge of the trunk—all other spines as in *brevispinosa*; dental formula $\frac{3+2}{4+1}$ or 5/5; spurs short cones, separated by wide interspace.

Though looking like *brevispinosa* this may have been derived from *multispinosa* by a reduction of the processes. The spurs are, however, very different from British examples of *multispinosa*, and it may be a distinct species.

EXPLANATION OF PLATE II.

- Fig. 6a.—*Habrotracha ampulla* sp. n. Animal and egg in case.
 „ 6b.— Ditto. Head, more highly magnified.
 „ 6c.— Ditto. Lateral view of head.
 „ 6d.— Jaw.
 „ 7a.—*H. acornis* sp. n. Feeding.
 „ 7b.— Ditto. Head and neck, extended.
 „ 7c.— Ditto. Jaw.
 „ 7d.— Ditto. Rump and foot.
 „ 7e.— Ditto. Ventral view of head, showing lateral flaps.
 „ 8a.—*H. auriculata* sp. n.
 „ 8b.— Ditto. Jaw.
 „ 9.— *Callidina* sp.
 „ 10a.— *Mniobia scabrosa* sp. n. Creeping.
 „ 10b.— Ditto. Jaw.
 „ 11a.— *Callidina punctata* sp. n. Feeding.
 „ 11b.— Ditto. Jaw.
 „ 11c, 11d.—Ditto. Two varieties of spurs.

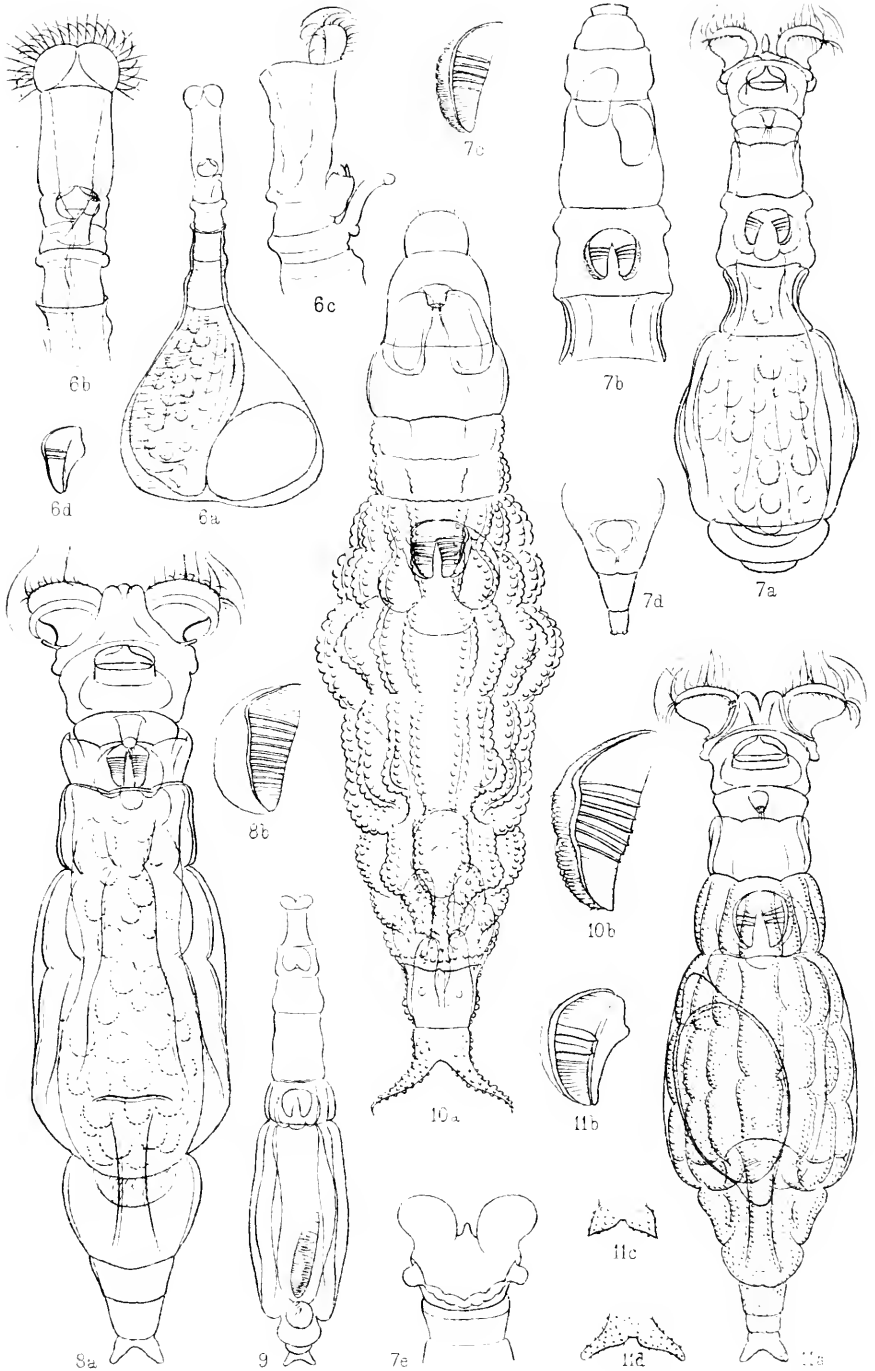

J. Murray del ad nat.

West, Newman photolith

African Rotifers.

Mniobia tetraodon Ehr. (9).

Synonym: *Callidina tetraodon*.

In African examples the disks have large, truncate, peg-like papillæ, bearing a few short cilia, such as have already been noted for *Embata laticeps* and *Callidina magna*.

Mniobia russeola Zelinka (2f).

Synonym: *Callidina russeola*.

The trunk and foot were distinctly papillose. Usually they are only stippled.

Mniobia scabrosa sp. n. Plate II. figs. 10a-10b.

Specific characters.—Large; trunk and foot papillose; rostrum stout, antenna of moderate length; jaws with thickened border, and six or seven teeth on each; corona large; foot short; spurs long, slender, tapering, widely divergent, papillose, without interspace; colour red.

General description.—Length when creeping $450\ \mu$, diameter of trunk $130\ \mu$, of rostrum $32\ \mu$, tip to tip of spurs $72\ \mu$, length of jaw $30\ \mu$. The trunk is deeply longitudinally plicate, and the segments are separated by deep constrictions. The papillæ cover the whole of the central and anterior trunk, the rump and the foot, even to the spurs. On the trunk they are set close together and are of uniform size. Each shows a small central dot. The neck and head are smooth.

The rostrum bears inconspicuous lamellæ, which meet in the middle line, and radiating straight setæ. The length of the antenna is three-fifths of the neck width. The corona is large, and the head resembles that of *Mniobia scarlatina*, but on the only occasion when it was seen feeding I failed to get a drawing of it. The neck is very short, and the segment bearing the antenna is not prominent.

The rump is not sharply marked off from the central trunk, and it is difficult to discriminate fourth central from preanal. The anal segment is very short. The foot is short, of only three segments. The first is constricted, then bulges again behind. The spurs measure about $40\ \mu$ in length. The terminal disc of the foot is two-lobed. The vibratile tags are somewhat broad and broaden towards one end.

The jaw has a very broad yellow border. Besides the six or seven strong teeth there is a thinner ridge or tooth at each end of the series.

It is only necessary to compare *M. scabrosa* with *M. scarlatina*, the only closely related species, and the only papillose species hitherto known in the genus. The two species differ in the papillæ,

the teeth and the spurs. The papillæ of *M. scarlatina* are scattered, not close together. They are irregular in size, and some are larger than those of *M. scabrosa*. It has more numerous teeth, eight, nine, or more. The spurs are short, conical, acuminate or obtuse, and separated by a wide interspace.

Habitat.—Uganda (N. D. F. Pearce), Kikuyu (A. Allan), New Zealand and Australia (Brit. Antaret. Exped. 1907-9).

In Queensland it attained to a length of 600 μ when creeping.

Habrotrocha caudata sp. n. Plate I. figs. 1a-1c.

Specific characters.—Small; antenna and rostrum short; corona small, disks close; lower lip spout-like; teeth, about four in each jaw; a long curved tail-like process at posterior part of central trunk; a smaller process of anus; spurs minute, narrow, acute; inhabits a brown case open at each end, the neck narrow and curved, the posterior tube to accommodate the tail.

General description.—Length when feeding about 170 μ ; case 120 μ long, by 70 μ diameter at widest part. The head is shaped like that of *Habrotrocha angusticollis*, the lower lip forming a prominent spout. The length of the antenna is equal to rather less than half the diameter of the neck. The rostrum is short and the lamellæ small. The neck is less elongate than that of *H. angusticollis*. There are prominences on each side of the antenna. The trunk segments are so indistinct that it is not easy to tell which of them bears the dorsal process or "tail." It is probably on the 4th-central segment or the preanal, possibly between the two. The tail appears to be tubular, but whether there is any opening at the end could not be ascertained. It is strongly curved, with the concavity on the anterior side. It can be partly inverted at the tip by the action of special muscles, and is shown truncate from this cause in fig. 1d. The process behind the anus is a small rounded flap, which appears ovate and acute in lateral optical section.

The foot is very short, but appears from slight swellings to consist of three segments from the anus to the spurs. The toes have not been seen. The spurs have not been seen in dorsal view. Seen from the side they are short, sharp, and curved downwards. There are usually four teeth, diminishing in thickness, with one thinner and many fine striae. The thicker teeth may vary from three to five. The general form of the case is like that of *H. angusticollis* (1 $\frac{1}{4}$), but it is smaller, and has the neck strongly curved towards the dorsal side, with a smaller opening. The posterior tube is set on nearly at right angles to the axis of the trunk, or inclined slightly forward at the free end. It is nearly straight and of uniform thickness; length about 40 μ .

There are many things in the organization of this extremely interesting species which await explanation. The peculiar case,

with its two openings, resembles that of *H. perforata* Murray (15) in its structure. In form that of *H. perforata* is quite different, having a wide neck and short two-lipped posterior tube. The perforation is to the dorsal side, as in *H. caudata*, but, curiously enough, the variety *americana* (18) has it on the ventral side, though the tube is of course always dorsal in its relation to the animal inside.

I can offer no suggestion as to the function of this posterior tube possessed by these two species. It seems a plausible suggestion that it serves for the ejection of the voided fecal pellets which cause so much labour to *H. angusticollis*, since it has to get rid of them through the neck tube, as there is no other opening. Mr. Bryce suggested that it served that purpose in *H. perforata*, but *H. caudata* throws doubt on this explanation, as in that species the tube is occupied by the mysterious "tail." If it does serve for getting rid of the pellets, even if that is not its chief function, we must suppose the tail can be drawn in to allow of it.

What is the purpose of the tail itself? There is another species, not yet described, which has a process in the same position, but it is small and wart-like. That might be regarded as protective, in common with the warts and spines on the trunks and feet of many species (*Pleuretra brycei*, *Callidina papillosa*, etc.), as the animal is not known to be a tube-dweller. The "tail" of *H. caudata* being itself protected by a tube, can hardly be supposed to serve for protection,

Many tube-dwellers, such as *H. longiceps* and *H. angusticollis*, are often found without tubes, from which it would appear that they may only secrete them for some special temporary use (as for the depositing of the eggs), or that they are under the necessity of leaving their tubes at times and constructing fresh ones. *H. caudata* has never been seen alive without a tube, but dead examples are often without cases.

Habitat.—Uganda: Old Calabar (N. D. F. Pearce); Katoomba, N.S.W. (Brit. Antarctic Exped. 1907-9); Pretoria, South Africa (J. Hewitt).

Habrotrocha ampulla sp. n. Plate II. figs. 6a-6d.

Specific Characters.—Small, with slender neck and elongate head; rostrum short, antenna long and slender; corona slightly wider than cheeks, disks close together; head greatly elongate between rostrum and corona; teeth two in each jaw; inhabiting a trigonous flask-shaped case with a narrow neck; foot unknown; reproduction oviparous.

General Description.—Length when feeding 210 μ , length of case 150 μ , diameter of widest part 100 μ , of neck 15 μ , of corona 20 μ , length of antenna 20 μ , egg 60 μ by 45 μ . The head is very long and narrow, scarcely wider than the neck. The disks are so strongly inclined forward that they are in line with the long axis of the body.

The separation of the two is so slight that the apparent motion of the cilia seems to pass uninterrupted round both. The lower lip is not prominent or spout-like. The mouth is large, occupying the whole length of the elongated head. The lamellæ are small, and seem distinct. The antenna has a strong sigmoid curvature, and shows a prominence at the back near the base. The second neck-segment shows a projecting rim at its anterior edge. The trunk is somewhat swollen, and diminishes posteriorly to what may be supposed to be the foot, but no details of anus, spurs or toes have been seen. The case is pale yellow, broadly triangular, and broadest near the base. The jaws are triangular and bear two teeth each.

Habrotrocha ampulla is a close relative of *H. angusticollis*, for which I mistook it for some years. It has the same general form, the same number of teeth, and a similar case. The greater breadth of the case is the first noticeable difference, and as it almost always contains an egg, it might be supposed if *H. angusticollis* secreted a case to protect itself and the egg it would take this form. Careful attention brings out other differences, of which the chief are the elongated head, the less prominent lower lip, and the longer antenna. The head lacks the ridges which are seen in *H. angusticollis*.

It is not necessary to compare *H. ampulla* carefully with any other species. Very few pellet-makers have only two teeth in the jaw. *H. aspera* is papillose all over the trunk; *Ceratotrocha cornigera* has been made the type of a new genus because of the possession of finger-like feelers at the sides of the head. *H. longiceps*, also a flask-maker and with similar elongated head, has more teeth and is not so slender.

Habitat.—Central Africa (N. D. F. Pearce); Pretoria, collected by J. Hewitt, April 1910. Mr. W. Milne, of Uitenhage, sent me a drawing which I believe to have been of this species, which I then considered as a form of *H. angusticollis*.

Habrotrocha perforata Murray (15).

Synonym: *Callilima perforata*.

Apparently characteristic of warm countries, though it has been found in some temperate regions (Switzerland, New Zealand). It is now known to possess spurs—which are small, blunt, and widely separated—and a “tail” like that of *Habrotrocha caudata*. The “tail” of *H. perforata* is much shorter and the neck much wider.

Habrotrocha longiceps Murray (17).

Synonym: *Callilima longiceps*.

Very common in warm countries, though originally discovered in Scotland. It is often detected by the presence of the peculiar cases, when the animal itself is not seen. In African examples the teeth were generally six or seven in each jaw.

Habrotrocha pusilla Bryce (?).Synonym: *Callidina pusilla*.

Cases with thick walls, of many layers. One case contained two eggs, which measured $90 \mu \times 50 \mu$.

Habrotrocha acornis sp. n. Plate II, figs. 7a-7e.

Specific Characters.—Size moderate; anterior trunk strongly constricted; corona large, disks widely separated (for the genus); collar prominent, with two large projections at either side of the mouth; rostrum very short and broad, antenna of moderate length; teeth, four or five in each jaw; foot of three segments, no spurs.

General Description.—Exact dimensions were unfortunately omitted, but it is one of the smaller species, though not among the smallest. The central trunk is expanded when feeding and is closely plicate. The segment immediately in front of it is very strongly constricted, forming a waist, and maintains this shape in all positions. The segment in front of the constricted one is enlarged and of a definite form, which is also maintained in all positions; it has a projecting annulus at the anterior edge, a constriction below that, and then expands towards the posterior edge. When feeding, the mastax is in this segment. The jaws have a broad border, and have usually four strong teeth and a thinner one on each.

The head has very distinctive characters. The disks are very large, and their size in relation to the constriction of the anterior trunk produces a curious result. When placed side by side the disks could not pass the constriction, and so they are held one in front of the other, asymmetrically, and this is their usual position in the creeping animal. The sulcus between the disks is about half as wide as a disk and bears normally a large ligule. The folds of skin from the collar end near the middle line in low rounded lobes, which do not project over the "bridge" joining the pedicels. The terminal joint of the rostrum is very short; it is much broader than long, and is the shortest I know in a Bdelloid. The lamellæ are short and seem quite separate, appearing as two distinct little sharp hooks. The quadrate flaps of skin projecting from the sides of the mouth recall those of *Habrotrocha angusta* Bryce (3). The length of the antenna is from $\frac{1}{2}$ to $\frac{2}{3}$ of the diameter of the neck. The rump is pyriform, and shows the two segments. The foot is very short, the first joint larger and tapering, the second very short, cylindrical, without a trace of spurs. The three toes are small but distinct.

Everything points to *H. acornis* being a tube-dweller, but it has never been seen in a tube. The constant shape of the trunk, in the feeding attitude, and the size of the constricted segment, even suggest that this is really no other than *H. perforatu* without its

case. Although *H. perforata* has occasionally been seen feeding, it has always been difficult to get a dorsal or ventral view of it, as its shape causes it to fall over on its side. Dead examples with the corona expanded do not show the disks separated. *H. perforata* has small spurs, which were not seen till after the original description was published, and it has a short "tail."

Mr. Bryce informs me that he believes a large proportion of the species of *Habrotrocha* secrete cases. It may be that all do so for temporary use at certain times. Many tube-makers are quite commonly found without tubes. *H. pusilla* is especially liable to desert its case.

Habrotrocha appendiculata sp. n. Plate I, figs. 4a-4b.

Specific Characters.—Small: trunk broad, coarsely stippled; preanal segment bearing two large divergent processes on its posterior angles; head relatively very small; corona a little wider than the neck, disks close together; collar prominent; teeth many, diminishing in size; foot short, spurs narrow, acute, divergent, without interspaces.

General Description.—Length when feeding 280 μ , diameter of corona 40 μ , collar 35 μ , neck 30 μ , central trunk 90 μ , across the "tails" of the preanal 60 μ , length of spur 12 μ . The central trunk is very broad and is regularly plicate. The stippling consists of pellucid dots, not papillae—it does not extend to the neck or foot. What appears to be the preanal segment is 2-lobed, and bears two pairs of dorsal skinfolds separated by a transverse fold. It may consist of the 4th-central and preanal. The "tail"-processes are large, about 12 μ long, conical, subacute, not stippled. The anal is short and diminishes very rapidly. The foot is 3-jointed, the first joint as broad as long. The neck segments diminish rapidly from the trunk forwards. The widest, next the trunk, usually contains the mastax when feeding. The upper lip forms a pointed arch. The teeth are like those of *H. constricta*—eight or more can be counted—the front one is thickest, and those behind diminish rapidly in size till they are as fine as the striæ which cover the whole surface of the ramus (except where the teeth are) in most Bdelloids. It is thus difficult to say what is the exact number of teeth in species like *H. constricta*.

H. appendiculata looks very like *H. microcephala*, as may be seen by comparing the figures (16). The most obvious differences are the smaller number of teeth in *H. microcephala*, and the tail-processes of *H. appendiculata*. The corona of *H. microcephala* is much smaller, the disks are angled, the collar is not prominent, the spurs are shorter.

The resemblance of *H. appendiculata* to *H. microcephala* is superficial—its real affinity is with *H. crenata* (14). That species

is papillose all over the trunk, but this character is discounted by Mr. Bryce, who says he knows *crenata* with the papilla reduced, or replaced by stippling. It has rounded bosses on the preanal, corresponding to the tails of *appendiculata*. I am decided in separating *H. appendiculata* as a distinct species by its greater relative breadth, lack of foot-boss on the first segment, and longer spurs. The teeth of *H. crenata* appear to be more definite, not diminishing to such fine striæ.

Kikuyu; several examples.

Habrotrocha brocklehursti sp. n. Plate I, figs. 5a-5d.

Specific Characters.—Small, very slender when extended; rostrum narrow, lamellæ small; disks slightly separated; upper lip triangular; collar inconspicuous, a large rounded process at each side of the mouth; antennæ very short; teeth 2/2; rump pyriform, preanal much larger than anal; foot short, of three segments, the first longest; spurs short, divergent, acuminate, sub-obtuse, with no interspace.

General Description.—Length, up to 400 μ in fullest extension, by no more than 36 μ in greatest width. When feeding, the body is shortened and the central trunk enlarged, when it may be 75 μ or more in diameter; corona 36 μ , cheeks 30 μ , neck 25 μ , across spurs 15 μ .

When extended, the four segments of the central trunk can be clearly seen, and are of equal length. The 4th central segment is then the narrowest part of the trunk, and is less than the preanal. The disproportion of the preanal and anal is unusual. The anal is a very short segment. The first foot-segment is relatively long, and the second very short.

There are only a few pellet-makers which have the dental formula 2/2. It is so usual for the species to have more than two teeth, that those with only two seem out of place in the group. Species having two teeth are *Habrotrocha angusticollis*, *H. aspera*, *H. tripus*, *H. ampulla*, *Ceratotrocha cornigera* (?). *C. cornigera* is placed in another genus, on account of its finger-like feelers; *H. aspera* is papillose; *H. ampulla* has an elongate head and long antennæ; *H. tripus* is distinguished by its tripod-like foot and large toes. *H. angusticollis* alone is near enough to require comparison. It is not so slender, but that is not a sufficiently definite character; it has a longer antenna; the lobes at the side of the head are not (as in this species) on the margin of the mouth; the gullet is longer; the lower lip is very prominent. *H. brocklehursti* is not known to secrete a case.

When fully extended it is so slender that it looks very much like a Nematode worm.

Several examples seen.

Habrotrocha auriculata sp. n. Plate II. figs. 8a, 8b.

Specific Characters.—Large; hyaline or pale yellow; trunk, with few wide longitudinal folds; corona, large; disks separated, the upper lip projecting between them like a little column to the level of the top of the disks; at the side of each disk a sort of ring projecting beyond the pedicels, and broken in the middle; central setae on disks; antenna, short; teeth, many (ten or more) diminishing; foot, short, of three segments, the first bearing two bosses, one in front of the other; spurs, short, divergent, obtuse, without interspace; toes very short and thick.

General Description.—Length, when feeding, 400 μ ; width of corona, 100 μ ; collar, 75 μ ; neck, 60 μ ; trunk, 100 μ ; tip to tip of spurs, 30 μ . Each disk measures 40 μ , and the interspace 20 μ . It is quite filled in front by the prominent upper lip. The central setae spring from very small papillae. The collar is prominent.

The ring-like auricles, from which the species is named, are of the most puzzling nature. They appear to have some relation to the cilia of the disks, and were, in fact, at first supposed to be merely optical appearances produced by the cilia, but there is no trace of motion in them. The part of the ring rising from the base of the pedicel, just above the collar, seems to be a solid peg-like process. The upper part, which is separated from it by a minute gap, appears to be of a different nature, very tenuous and transparent. It continues a ridge which runs round the dorsal side of the disk. The appearances it presents in lateral and ventral views are not readily reconcilable with the dorsal appearance. There are similar auricles in another species, known in England and not yet described, which have puzzled Mr. Bryce as much as those of this species have puzzled me. The length of the neck antenna is $\frac{2}{3}$ of the neck width.

The jaws are triangular, and constricted below the widest part. The whole surface is almost covered by the teeth, which begin at the widest part, and diminish in thickness towards the posterior end of the jaw, where they become mere lines. Their number is not easily determined, but ten or more may be counted. The whole trunk is finely stippled. The pellets are yellow. There are two strong skin-folds near the middle line, passing from the central trunk on to the rump. The brain is of moderate size.

Habrotrocha auriculata is a very distinct species, having no near relatives, except the undescribed British species above referred to, which has not got the columnar upper lip, and differs in many other respects.

Habitat.—Kikuyu, Brit. E. Africa (A. Allan); Katoomba, N.S. Wales (Brit. Antarctic Exped., 1907-9).

UNNAMED SPECIES.

In addition to the thirty species named in the list, five others were observed, undoubtedly distinct species, but as they have been all previously seen by others, though not yet described, we must wait for the descriptions.

One is the *Philodina* "double" of *Mniobia russeola*, which is here figured, though not named.

Another is a species long known to Mr. Bryce and myself. From certain points of structure recently ascertained, I suspect that it may prove identical with *Callidina perforata*.

A third is a well-marked species of *Adincta*, which appears to be the commonest African species. It always occurs in the moss which Mr. Milne sends me.

Yet another is a species of *Habrotrocha*, with peculiar spurs, like those of *Philodina antarctica* Murray (20). Mr. Bryce has known it for many years, and there is, I believe, some hope of identifying it with one of Ehrenberg's species.

SUMMARY.

This list of Bdelloid Rotifera from Tropical Africa is another illustration of the abundance of moss-dwelling species in this order. The richness of moss-faunas is only beginning to be understood. The list includes only moss-dwelling species, yet it numbers thirty-three named species, while some half-dozen other distinct species were observed though not yet named. Three species were recorded in the earlier paper on African Rotifers (19) which are not in the present list, making a total of thirty-six species for the region examined.

The thirty-six species are distributed as follows:—*Philodina* 3, *Pleuretra* 3, *Callidina* 9, *Mniobia* 4, *Rotifer* 1, *Habrotrocha* 13, *Adincta* 3.

The great preponderance of the pellet-making *Habrotrocha* over the other genera is noticeable. It is the same everywhere. It is a vast group, I believe of higher than generic value, which may have to be further subdivided before long.

The number of peculiar species in the list is remarkable. No fewer than ten of the species were first discovered in this district, and although many or all of them may eventually be found elsewhere, the fact is an indication that moss-dwelling Bdelloids are to some extent local in their distribution.

In South Africa Mr. Milne has found many peculiar Bdelloids, some of them very aberrant indeed, and similarly I have found in mosses from South Africa many new species distinct from Mr.

Milne's, as well as from those of Tropical Africa. When all of these are published the Bdelloid Rotifera of Africa will make a very respectable group.

BIBLIOGRAPHY.

1. BRYOE, D.—On the Macrotrachelous Callidinæ. Journ. Quekett. Micr. Club, ser. 2, v. (1892) p. 15.
2. „ On Two New Species of Macrotrachelous Callidinæ. Op. cit., ser. 2, v. (1893) p. 196.
3. „ Further Notes on Macrotrachelous Callidinæ. Op. cit., ser. 2, v. (1894) p. 436.
4. „ On Two New Species of *Philodina*. Op. cit., ser. 2. viii. (1903) p. 523.
5. „ On a New Classification of the Bdelloid Rotifera. Op. cit., ser. 2, xi. (1910) p. 69.
6. DAVIS, H.—A New *Callidina*, etc. Monthly Micr. Journ., 1873, p. 201.
7. DUJARDIN, F.—Histoire naturelle des Zoophytes: Infusoires. Paris, 1841.
8. EHRENBURG, C. G.—Ueber die Entwicklung und Lebensdauer der Infusionsthierchen. Abh. k. Akad. Wiss. Berl. (1831) 1832.
9. „ „ Fortgesetzte Beobachtungen über atmosphärische Organismen. Monatsber. k. Akad. Wiss. Berl. (1848) p. 379.
10. „ „ Diagnoses novarum formarum. Verh. k. Akad. Wiss. Berl. (1853) p. 529.
11. „ „ Mikr. geologie. 1854.
12. JANSON, C.—Ueber die Rotatorien-familie der Philodinæen. Marburg, 1893.
13. MILNE, W.—On the Defectiveness of the Eye-spot, etc. Proc. Phil. Soc. Glasgow, xvii. (1886) p. 134.
14. MURRAY, J.—A New Family and Twelve New Species of Rotifera. Trans. Roy. Soc. Edin., xli. (1905) p. 367.
15. „ Some Rotifera of the Sikkim Himalayas. Journ. Roy. Micr. Soc. (1906), p. 637.
16. „ The Bdelloid Rotifers of the Forth Area. Proc. Roy. Phys. Soc. Edin., xvi. (1906) p. 215.
17. „ The Rotifera of the Scottish Lochs. Trans. Roy. Soc. Edin., xlv. (1906) p. 151.
18. „ Some South American Rotifers. Amer. Nat., xli. (1907) p. 97.
19. „ Some African Rotifers. Journ. Roy. Micr. Soc., 1908, p. 665.
20. „ Antarctic Rotifera. Sci. Rep. Brit. Antarc. Exped., 1907-9, i. (1910) p. 41.
21. PLATE, L.—Ueber die Rotatorien-Fauna des baltischen Meerbusens. Zeit. f. Wiss. Zool., xlix. (1889).
22. THOMPSON, PERCY G.—Mos-haunting Rotifers. Science Gossip, 1892, p. 56.
23. WEBER, E. F.—Faune Rotatorienne du Bassin du Léman. Rev. Suisse de Zool., v. (1898) pp. 263-785.
24. ZELINKA, C.—Studien über Räderthiere. III. Zeit. f. wiss. Zool., liii. (1891) p. 323.

II.—*A Simple Method of Obtaining Instantaneous Photomicrographs.*

By J. EDWIN BARNARD.

(Read November 16, 1910.)

IN view of the considerable development, or what perhaps might more properly be described as the re-introduction of dark-ground illumination methods, it is desirable that some simple method should be available for photographing living or moving microscopic objects.

Various arrangements have already been described for effecting this, but they are of necessity somewhat elaborate and costly. The method that I have recently employed is to use an ordinary reflex camera in conjunction with a vertical photomicrographic camera. It may be that this is a perfectly well-known arrangement, but, if so, I can only say I have not hitherto seen any description of it.

The type of vertical camera most suitable is that usually known as the Van Heurek model, as made by Messrs. Watson, for this camera is much more stable and stiffly supported, not relying for its stability on a single rod as do most other vertical types. The lens, and if possible the whole front, is removed from the reflex camera, and it is then placed face downwards on the top of the vertical photomicrographic camera. The focusing screen is vertical and faces towards the observer. It is then quite easy to observe the image on the ground-glass screen of the reflex camera through the focusing hood, and at the same time to control with ease the necessary adjustments of the Microscope. Exposure would, of course, be

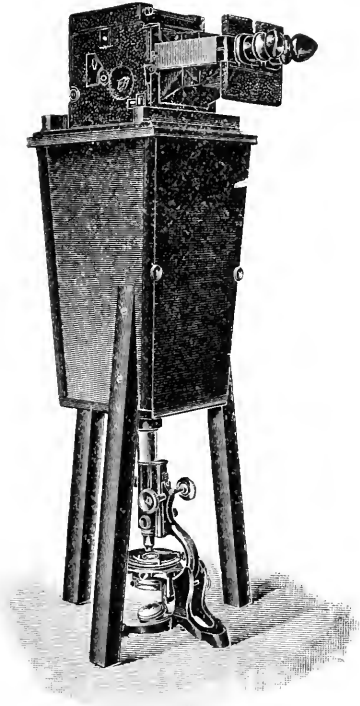

FIG. 1.

effected by releasing the focal plane shutter in the reflex camera, and its duration could be varied to suit the rapidity of movement of the object, as in ordinary camera manipulation. In practice it will rarely be found that high speeds are necessary.

The only practical objection that I am able at present to see to this method is that there is considerable liability of vibration on the release of the shutter. In a camera such as I am showing this evening (fig. 1), made by Messrs. Newman and Guardia, this perhaps does not constitute such an objection, as they claim, and I think with justice, that the exposure is effected so rapidly after the release of the mirror that there is no time for the transmission of a vibration to the apparatus itself. A much less expensive type of camera would probably answer the purpose.

I put this apparatus forward and make the suggestion in the hope that it may be of service to some of those who wish for a readily available means of obtaining a record of the appearance of living micro-organisms under dark-ground or similar methods of illumination.

III.—*On the Use of a Metallic Electric Arc in Photomicrography.*

By J. EDWIN BARNARD.

(*Read November 16, 1910.*)

SOME time ago I described to this Society a method of using a mercury vapour arc for visual microscopic work. I explained that it had such advantages that it was probably substantially ahead, as a source of light, of any other illuminant then available—an opinion that subsequent experience has more than confirmed. As the light is derived from the luminous arc itself, and not from either of the luminous electrodes, it follows that its spectrum is a bright-line one, and that it is possible, by a suitable arrangement of prisms, or by suitable colour screens, to obtain illumination in the Microscope that is truly monochromatic. While for visual work the amount of light so obtained is amply sufficient for use with the highest powers, when it comes to photomicrography the exposures are in many cases prolonged, and sometimes unduly so. I have therefore been experimenting for some time to see whether a metallic arc with solid metal electrodes might be made available for the purpose mentioned.

I must at once admit that up till quite recently the results obtained have not been favourable, as it is extremely difficult to get an electric arc with metallic electrodes to burn with any degree of steadiness; and, further, there is always the difficulty that with most metals the electrodes themselves either quickly melt, or the arc changes its position, owing to bending or displacement of the metals. Again, if, for instance, we take an arc formed between iron electrodes, in which the metal itself has not a low melting-point, and which may, by suitable arrangements, be made to run steadily, we are confronted with the difficulty that its spectrum consists of a great number of lines of moderate intensity which are distributed pretty evenly throughout the spectrum, so that, owing to the closeness of the lines one to another, there is no advantage over a source of light with a continuous spectrum, such as an ordinary carbon arc.

Of all metals giving a suitable spectrum, other than mercury, none so thoroughly fulfil the necessary conditions as cadmium; but unfortunately cadmium has a particularly low melting-point, rather lower even than that of lead, so that to use it in a pure state is simply impossible. A recent paper by Dr. T. Martin Lowry, on "A New Method of Producing a Cadmium Arc," has suggested that

by combining silver and cadmium in suitable proportions, electrodes are produced that have a very high melting-point, and that under ordinary conditions will produce a very good arc. The proportion of silver to cadmium may conveniently be 60 p.c. cadmium to 40 p.c. silver, and such an alloy has a melting-point above 700° C.

On examining the spectrum given, it is found that the principal lines are situated in the blue, green, and red portions of the spectrum, so that it is possible to obtain a monochromatic source of light at will in either of these regions, and of almost unlimited intensity—the intensity, in fact, being only dependent on the size of the electrodes, and the number of amperes used. If an attempt is made to run an arc with pure-metal electrodes of almost any sort, it will be appreciated how very difficult it is to so adjust the arc that anything approaching a constant source of light may be obtained. With the cadmium-silver arc the conditions are very much better, but to obtain the best result the electrodes should be rotated in opposite directions during the time that the arc is burning. This method is, of course, one perfectly well known, and requires no further explanation here. It is not one that entails any considerable complication in apparatus, in fact, it is quite practicable for the short exposures required in photo-micrography, to have a hand-driven type of mechanism, which is both inexpensive and sufficiently efficient.

It may be urged that owing to the fact that the electrodes suggested are an alloy, that the spectrum of silver will be equally evident with that of cadmium, and this is, of course, the case; but fortunately the spectrum of silver is such that it does not interfere to any extent with the cadmium spectrum, the principal cadmium lines, in fact, being so brilliant that the others are almost negligible. The red cadmium line, with a wave-length of $6438 \cdot 10$ m., is a particularly brilliant one not far from the region of the orange, so that it has considerable visual luminosity. The green line wave-length, $5085 \cdot 10$ m., is in the most brilliant portion of the spectrum, and running the cadmium silver arc with 10 amperes, a fully exposed plate may be obtained in a few seconds, even with the highest powers, using, of course, a suitably sensitized plate. The blue line wave-length, $4799 \cdot 10$ m., has very high luminosity for the blue part of the spectrum, so that it may be used for work with diatoms, or where the greatest visual resolution is required. It might be interesting to note that the bright lines in the cadmium spectrum are extremely narrow ones. It follows that the light transmitted, whether screened off, or obtained by spectroscopic methods, is of one wave-length.

In the case where this arrangement is used in conjunction with a monochromatic light apparatus, in which the light is split up by the aid of prisms, the slit may be opened very wide indeed so that the light transmitted becomes a very broad band, quite

sufficient to fill the field with moderate or high-power microscopic objectives.

It may be urged that the method, although, perhaps, not without scientific interest, is impracticable owing to the cost of the cadmium silver electrodes, and it must be admitted that this is not altogether a negligible factor. Cadmium is now, however, not a rare metal, and can be bought cheaply, whilst the value of silver is well known to you all. I may say, moreover, that I have recently obtained some of this alloy from Messrs. Johnson Matthey, the Metallurgists, of Hatton Garden, and that the cost of a single electrode works out at five shillings. This is sufficient for a fairly long run, so that after all the expense would not, in most cases, be an insuperable objection where some special result is aimed at.

IV.—*Aerator Suitable for Laboratory Aquaria.*

By J. F. GEMMILL, M.A. D.Sc. M.D.

(Read November 16, 1910.)

THIS instrument has some advantages over the one I described in a former number of the Journal.* It adapts itself readily to such

variations of pressure as occur from hour to hour in the water supply of towns, and accordingly it is somewhat easier of adjustment and needs less supervision than the other. At the same time, its construction is simpler, and it provides an uninterrupted supply of air. As in the former instrument, the air is washed free of impurities, and is under sufficient pressure to enable it to be distributed to different aquaria and to be forced through such nozzles (e.g. suitable pieces of partly decayed wood †) as will give out streams of very fine air-bubbles; also, should leakage occur anywhere there is no danger that the aquaria may be flooded with tap-water. The working of the instrument will be understood from the sketch, etc., appended (fig. 2).

A. An ordinary *small* aspirator of glass or metal attached to a water tap, the water supply being under considerable pressure.

B. Opening in the aspirator for the entrance of air.

C. Rubber tubing attached to outflow of aspirator, and connected with the tube E.

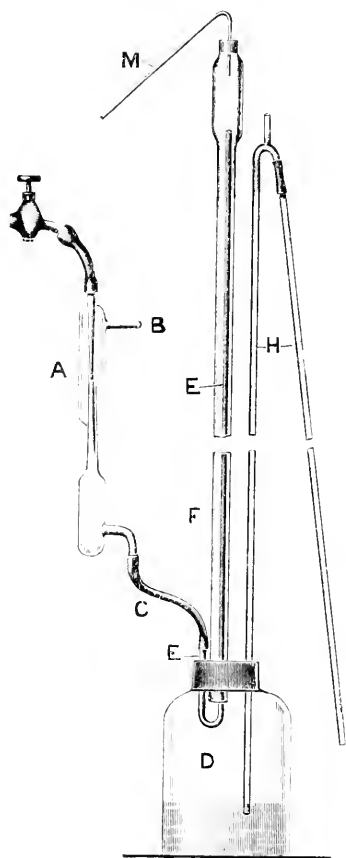

FIG. 2.

* See this Journal, 1910, pp. 9-13.

† Loc. cit.

D. Bottle, of e.g. 600 c.cm. capacity, with neck about 2 in. wide, and a tight cork pierced with the necessary holes.

E. Bent tube, of about $\frac{3}{8}$ in. internal diameter, one end connected with C, the other passing up within the wider tube F to 8 in. from the top, and opening there.

F. Wider tube, 6 or 7 ft. high, and of about $\frac{9}{16}$ in. internal diameter, passing through the cork, and connected at the upper end with M, the air-tube supplying the aquaria.

H. A bent tube of about $\frac{1}{2}$ in. internal measurement, and about 10 in. shorter than F, with an opening at the top of the bend. One limb of the tube pierces the cork and reaches nearly to the bottom of the bottle, while the other is led to a waste sink.

M. Air-tube for supply of aquaria.

When the tap is turned on, water mixed with air emerges at the top of the bent tube E within the wider tube. The water is free to fall down the wide tube into the bottle, while the air remains higher up. Pressure rises inside the bottle and the tubes coming from it, and the water used escapes by H, and thus runs to waste. This gives a supply of air along M under as much pressure as the height of H allows. If more air is supplied than is used for aeration, it gradually displaces the water in D as far down as the lower end of H, and then the surplus escapes.

The opening at the top of the bend on H ensures against syphon action taking place, and thus destroying the internal pressure. Should the water pressure at the tap slacken and give a diminished supply of air, the water level in the bottle and in the tube F rises till it adjusts itself to the lessened internal pressure. Should inflow at tap cease altogether, any water which may be in the tubes above the level of B escapes by this opening, and accordingly it is as well to have attached thereto a piece of rubber tubing leading to the waste sink.

The attachment between tap and aspirator needs to be secure. The nozzle of the tap should be of suitable shape, and pressure tubing, firmly tied on and strengthened by having string or a strip of strong tape wound round it, should be employed.

V.—*Adaptation of Ordinary Paraffin Baths for Vacuum Embedding.*

By J. F. GEMMILL, M.A. D.Sc. M.D.

(Read November 16, 1910.)

THE advantages of being able to embed certain objects in a vacuum, or under diminished atmospheric pressure, are well known. Baths made for the purpose are, however, costly, and many workers who possess a good ordinary paraffin bath may welcome a means of adapting it when desired to embedding *in vacuo*.

The following arrangement works satisfactorily in the case of a large open embedding bath which was made for me eight or nine years ago by the Cambridge Scientific Instrument Co., according to a model slightly modified from that given under No. 291 of their catalogue (fig. 3). A similar arrangement can be adapted to closed baths.

A. An ordinary small aspirator connected with C, a bell-jar, by means of strong rubber tubing, in the course of which a gauge or indicator (B in the sketch) may, if desired, be interposed. The bell-jar should be small, e.g. 2–3 in. across the mouth.

D. A flat ring of good rubber, about $\frac{1}{8}$ in. in thickness, $\frac{1}{2}$ in. broad, and of a diameter suited to the size of the bell-jar.

The jar I use was got by cutting off the bottom of a small bottle of fairly strong glass, grinding the cut end flat, and at the same time very slightly smoothing the edges.

Bell-jar and rubber ring were made just of the right size to fit over any one of the small embedding pots on the top of the bath. The ring serves as an air-tight joint or washer between the bell-jar and the bath. When the jar is fitted in position and the water turned on, the air pressure within the jar can readily be reduced to as low as $\frac{1}{2}$ in. of mercury. But unless when air has to be extracted from some cavity in the specimen being embedded, I prefer to work with a much more imperfect vacuum, especially in the case of delicate tissues.

One must remember that only a strongly made open bath could stand having a vacuum chamber fitted on any part of it. Practically all open baths have, however, places for holding embedding tubes. These tubes can be fitted with a suitable stopper and exhausted in the same way as the bell-jar, without risk of breakage of any kind unless they are very thin.

In the case of closed embedding baths, all one has to do is to

supply a suitable base for the bell-jar, and to put the jar so fitted into the inside of the bath, leading a tube to it from the aspirator in whatever way is most convenient. For example, a small piece of suitable piping can be soldered through one side and left as a permanent fixture, to which tubing may be attached, leading on the one hand to the aspirator, and on the other with the bell-jar inside. Or, as most baths have an opening in the roof for letting down a thermometer, this opening may be utilized for the passage of the tube. The base may be of strong copper, or, perhaps, better of plate glass, the thickness being greater the larger the bell-jar used.

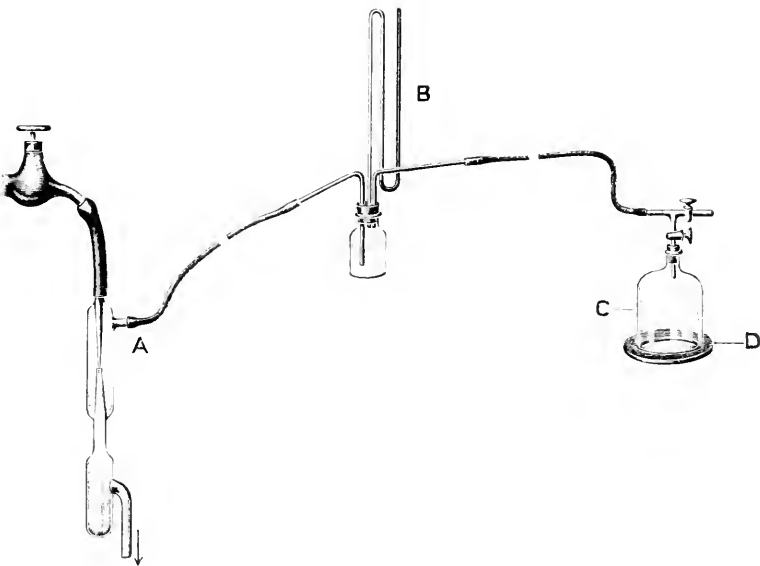

FIG. 3.

The dishes containing melted paraffin and the objects to be embedded are placed under the bell-jar. The latter is then fitted on to the base with the help of the rubber ring, and exhaustion is effected as before. Or again, as in the case of the open bath, the process may be carried on by using tubes with suitable stoppers.

It is well to have the top of the bell-jar fitted with stopcocks, as shown in the sketch. The lower of the stopcocks enables one to shut off the vacuum chamber at once when the required degree of diminished pressure has been attained. The upper of the stopcocks is useful when the process is at an end, as when opened it allows free entrance of air into the bell-jar without the least risk that any water may be sucked in from the tubing connected with the aspirator.

I find it useful for other purposes to have at hand in the laboratory a means of producing a vacuum, and it is simple to arrange that the tubing from the aspirator may be fitted whenever desired to another bell-jar with the requisite rubber washer and base, apart altogether from the bath. One can get very rapid and very perfect removal in vacuo of the absolute alcohol by the clearing agent, e.g. xylol or cedar oil. One can also extract absolute alcohol from these substances so that they can be used over again even for the final stages of clearing.

Then on the bath, paraffin already used, and now no longer free enough from traces of the clearing agent to allow it to be used again for the final embedding, may be rendered fairly pure if kept melted for a time under the aspirator. Even though the actual embedding of objects in paraffin is allowed to proceed in the ordinary way, it is still of very great advantage at the end of the process to submit the dish of melted paraffin, containing the object, for a short time to the action of a vacuum, as in this way the mass, when cooled, will be of uniform consistence and free from crystallization.

SUMMARY OF CURRENT RESEARCHES
RELATING TO
ZOOLOGY AND BOTANY
(PRINCIPALLY INVERTEBRATA AND CRYPTOGAMIA),
MICROSCOPY, ETC.*

ZOOLOGY.

VERTEBRATA.

a. Embryology.†

Accessory Chromosomes in Man.‡—M. F. Guyer describes the two accessory chromosomes as found in man, with other features of human spermatogenesis. Twenty-two chromosomes, differing considerably in size, were found to occur in all spermatogonia in which the investigator was able to make a definite count. In a few instances, two—apparently the two accessory chromosomes—were seen considerably to one side of the main mass of chromosomes, surrounded by a small clear court of cytoplasm. Twelve chromosomes appear for division in the primary spermatocyte, of which ten are evidently bivalent and two accessories. The two accessory chromosomes pass undivided to one pole of the spindle considerably in advance of the other chromosomes, with the result that half of the daughter-cells in this division receive twelve, and half only ten univalent chromosomes. This is evidently the reduction division. The ten univalent chromosomes which passed to the one secondary spermatocyte unite again in pairs—at least, in the majority of cases—to form five bivalent chromosomes, which appear at the equator of the spindle when the cell is ready for division. The division here is presumably an equation and not a second reduction division, judging from the size, shape and general appearance of the resulting daughter-chromosomes. Thus, while each of the spermatids formed as a result of this division receives only five chromosomes, the latter are bivalent, and equivalent to ten of the somatic or spermatogonial chromosomes. There is some slight evidence that the secondary spermatocytes may occasionally divide with their chromosomes in their original condition of univalence. Ten of the twelve chromosomes which passed to the other pole of the spindle in the primary spermatocyte behave in the way just described.

* The Society are not intended to be denoted by the editorial "we," and they do not hold themselves responsible for the views of the authors of the papers noted, nor for any claim to novelty or otherwise made by them. The object of this part of the Journal is to present a summary of the papers *as actually published*, and to describe and illustrate Instruments, Apparatus, etc., which are either new or have not been previously described in this country.

† This section includes not only papers relating to Embryology properly so called, but also those dealing with Evolution, Development, Reproduction, and allied subjects.

‡ Biol. Bull., xix. (1910) pp. 219-34 (1 pl.).

The two accessory chromosomes come to the equator of the spindle in the secondary spermatocyte with the five bivalents, making in all seven. Each accessory now divides, so that the resulting spermatids each receive seven chromosomes—that is, five bivalent, plus two accessory, or the equivalent of twelve univalent chromosomes. In reality, then, of the total number of spermatids half have in all probability received ten and half twelve (10 + 2) univalent chromosomes. Inasmuch as the spermatids transform directly into spermatozoa, there must be two classes of the latter, differing with respect to whether they have or have not the two accessory chromosomes. It is a significant fact that approximately half the resting spermatids, when strongly decolorized after iron-haematoxylin staining, show two chromatin nuclei and half do not. It seems probable that these nucleoli may correspond to the accessory chromosomes, and are to be identified with the two nucleoli of the primary spermatocyte and the two eccentric chromosomes seen in the spermatogonia. It is probable that in man and certain other Vertebrates, as also in the Insects, Myriapods, and Arachnids, the accessory chromosomes are in some way associated with the determination of sex.

Mammalian Spermatozoon.*—J. van Mollé has studied the spermatozoon in squirrel, mole, guinea-pig, and rat. He finds that the sheath, or "manchette," is of nuclear origin, and that it persists in the fully-formed spermatozoon. The centriole is of an elbow-like (?) (*équerre*) form, and retains this through the transformations of the tail and middle-piece. The "baton-like body," the transverse branch of the "centriole *équerre*," is not an ephemeral element, but persists till the spermatozoon has its final form.

Inheritance of Skin-pigmentation in Man.†—Gertrude C. Davenport and Charles B. Davenport have made a careful study of the inheritance of skin-pigment in typical Caucasians and in crosses between whites and negroes. They have also made a study of the inheritance of albinism in man. The conclusion from various data, qualitative as well as quantitative, is that skin-colour in negro and white crosses is not a typical "blend," but that, on the contrary, the original grades of heavy and slight melanogenesis segregate in the germ-cells—often imperfectly, because of the multiplicity of units (or grades) for skin-pigmentation—and thus the original colour characters are more or less perfectly restored. All studies indicate that blondes lack one or more units that brunettes possess; that the negro skin possesses still additional units; that individuals with the heavier skin-pigmentation may have slight pigmentation covered over (hypostatic), evidence of this condition appearing in the light offspring of such hybrids in the second or third generation; and that first-generation hybrids frequently show, somatically, a colour grade less than that which they carry potentially and may segregate in their germ-cells.

Sterility.‡—Max Morse has brought together a number of facts bearing upon the difficult problem of sterility. "As far as may be

* *La Cellule*, xxvi. (1910) pp. 425-49 (1 pl.).

† *Amer. Nat.*, xlv. (1910) pp. 641-72.

‡ *Tom. cit.*, pp. 624-33.

judged from studies upon the germ-cells which have been made thus far, sterility is a matter of the fundamental constitution of the organism. It concerns the bearers of hereditary traits, the chromosomes. All of the studies which have been made point to the conclusion that whatever may be its nature, there is an 'incompatibility' existing between the chromosomes of individuals of different species or varieties."

Islands of Langerhans in the Human Embryo.*—T. Mironescu has made a study of the development of the islands of Langerhans in the human embryo. He finds that the first rudiments of these are developed through the vascularization of epithelial buds or shoots arising from the glandular ducts and glandular acini. The islands are only recognizable by the arrangement of their cells and by their relation to the capillary vessels. The author does not agree with Kuster that there is no increase in the number of islands of Langerhans after early embryonic life; from his comparison of the pancreas of new-born infants with that of adults, he infers that they increase in number even after birth, arising in the same way as in the early life of the embryo.

Development of the Sympathetic Nervous System in Mammals.† A. Kuntz publishes an account of an investigation into the development of the sympathetic nervous system in Mammals, undertaken to further exact knowledge of the histogenesis of the sympathetic nervous system, to establish the histogenetic relationships between the sympathetic neurones and the neurones of the central nervous system, and to correlate the sympathetic system with the other functional divisions of the nervous system. His results are as follows: The sympathetic trunks arise as a pair of cell-columns lying along the sides of the dorsal surface of the aorta. In the early stages, medullary cells migrate from the neural tube into the dorsal and the ventral nerve-roots. The cells, which migrate into the ventral nerve-roots with similar cells which wander down from the spinal ganglia, migrate peripherally along the spinal nerves. Some of these cells deviate from the course of the spinal nerves, and, migrating along the paths of the communicating rami, give rise to the sympathetic trunks. The pre-vertebral plexuses arise as cell-aggregates lying along the ventro-lateral aspects of the aorta in the posterior region of the body. They are derived directly from the sympathetic trunks. The cardiac plexus and the sympathetic plexuses in the walls of the visceral organs are not derived from the sympathetic trunks, as has hitherto been supposed, but have their origin in neurons which migrate from the hind-brain and the vagus ganglia along the fibres of the vagi. In view of the relation of these plexuses to the vagi, the author calls them "vagal sympathetic" plexuses. The cells migrating peripherally from the cerebro-spinal system along the spinal nerves and the vagi are the descendants of the "germinal" cells of His—that is, the "indifferent" cells and the "neuroblasts" of Schaper—therefore, they are homologous with the cells giving rise to the neurones and the supporting elements in the central nervous system. The cells migrating peripherally along the spinal nerves and the vagi do not all take part in the development of

* Arch. Mikr. Anat., lxxvi. (1910) pp. 322-8.

† Journ. Comp. Neurol., xx. (1910) pp. 212-58 (18 figs.).

the sympathetic system. Some become distributed along the nerve-fibres and give rise to the neurilemma; therefore the cells of the neurilemma are homologous with the neuroglia-cells in the central nervous system. The cells taking part in the development of the sympathetic nervous system and the neurilemma do not all actually migrate as such from their sources in the cerebro-spinal system. Doubtless many arise by the mitotic division of "indifferent" cells along the course of migration. The existence of sympathetic sensory neurones in the sympathetic trunks and the pre-vertebral plexuses has not been demonstrated. Experimental evidence, however, indicates the presence of sympathetic sensory neurones in the sympathetic plexuses in the walls of the digestive tube.

While it is impossible by direct observation to trace either sympathetic excitatory or sympathetic sensory elements back to their specific source in the cerebro-spinal nervous system, indirect embryological and anatomical evidence warrants the conclusion that the sympathetic excitatory neurones arise from cells which migrate from the neural tube along the fibres of the motor nerve-roots, while the sympathetic sensory neurones, wherever such neurones exist, arise from cells which migrate from the cerebro-spinal ganglia. This interpretation makes the sympathetic neurones homologous with the afferent and the efferent components of the other functional divisions of the peripheral nervous system. As the cells migrating peripherally from the cerebro-spinal nervous system are the "indifferent" cells and "neuroblasts" of Schaper, Schaper's conception of the developmental relations of the neurones and the supporting elements in the central nervous system may be extended to the sympathetic neurones and the cells of the neurilemma. The nervous system is a unit, of which the sympathetic system is a part homologous with the other functional divisions. The sympathetic system may be looked upon as an accession to the nervous system, which has arisen comparatively late in the evolution of Vertebrates in response to the conditions of the vegetative life. The fact that the sympathetic system is homologous with the other functional divisions of the nervous system lends a new aspect to the problems involved in its functional relations. The fact that the vagal sympathetic plexuses have their origin in the hind-brain and the vagus ganglia will doubtless have an important bearing on certain physiological and psychological problems involving the heart action and the digestive functions.

Development of Sympathetic Nervous System in Birds.*—Following up his recent work on the development of the sympathetic nervous system in Mammals, A. Kuntz publishes the results of an investigation into the development of the nervous system in Birds. The primary sympathetic trunks in the chick arise about the beginning of the fourth day of incubation, as a pair of cell-columns lying along the sides of the aorta, and along the dorsal surfaces of the carotid arteries. The "anlagen" of the secondary sympathetic trunks arise about the beginning of the sixth day, as ganglionic enlargements on the median side of the spinal nerves. These ganglionic enlargements are at first

* Journ. Comp. Neurol., xx. (1910) pp. 283-308 (10 figs.).

independent of each other, but become united later by longitudinal commissures. The primary sympathetic trunks reach their maximum development during the course of the sixth day, after which they decrease in size until they disappear. These results agree essentially with those of His, jun., but the author finds that the cells giving rise to the sympathetic trunk are not derived exclusively from the spinal ganglia, as His supposes, but that they are derived wholly or in part from the neural tube. Medullary cells migrate from the neural tube into the ventral roots of the spinal nerves.

With similar cells which wander out from the spinal ganglia, these cells migrate peripherally along the spinal nerves. At a point a little above the level of the aorta, cells deviate from the course of the spinal nerves, and migrating towards the aorta, give rise to the primary sympathetic trunks. As migration proceeds, the cells which deviate from the course of the spinal nerves no longer wander into the primary sympathetic trunks, but become aggregated at the point of origin of the communicating rami, and give rise to the rudiments of the secondary sympathetic trunks. The pre-vertebral plexuses arise as cell-aggregates lying along the ventro-lateral aspects of the aorta from the supra-renals posteriorly. They are derived directly from the primary sympathetic trunks. The ganglion of Remak arises as an oval cell-column lying in the mesentery just dorsal to the rectum. It arises from cells which migrate ventrally from the hypogastric plexus. The cardiac plexus and the sympathetic plexuses in the walls of the visceral organs arise from cells which migrate from the hind-brain and the vagus ganglia along the fibres of the vagi. In the posterior region of the intestine the myenteric and the submucous plexuses probably receive some cells from the ganglion of Remak. The cells, which migrate from the neural tube and from the cerebro-spinal ganglia along the spinal nerves and the vagi, are the descendants of the "germinal" cells of His, the "indifferent" cells or "neuroblasts" of Schaper. They are, therefore, homologous with the cells which give rise to the neurones and the neuroglia cells in the central nervous system, and the sympathetic neurones are homologous with the afferent and the efferent components of the other functional divisions of the peripheral nervous system. These observations agree with the author's observations on mammalian embryos. Certain morphogenetic differences exist between the development of the sympathetic nervous system in Birds and Mammals, and these the author interprets as indicating that the sympathetic system has departed more widely from the ancestral type in Birds than in Mammals.

Duplicity in Chick Embryos.*—Chas. H. O'Donoghue describes three specimens of duplicity, worthy of note, as they are in other respects practically normal. In the three cases the two halves are practically equal in development, a condition called by Saint Hilaire autositic, although the extent to which fusion occurs differs considerably, varying from complete anterior fusion to complete independence. Two were syncephalic monsters, the third showed two apparently independent embryos, which were very closely approximated in their cranial portions,

* *Anat. Anzeig.*, xxviii. (1910) pp. 530-6 (4 figs.).

but widely divergent at their caudal ends. The author refers to the two rival theories of duplicity, that there are to start with two germinal areas, or that one area undergoes partial or complete fission. A case of ovum in ovo is described, the view taken being that a fragment of a larger egg is ruptured off and enshelled, and then incorporated with the next egg coming down.

Inheritance in Hybrid Poultry.*—R. Pearl and F. M. Surface have carried out a series of experiments in cross-breeding poultry, with the general purpose of throwing light on the fundamental principles of heredity. They publish an account of a detailed study of the reciprocal crosses of the Cornish Indian Game and Barred Plymouth Rock breeds. The percentage of fertility of eggs is found to be much higher when the cross is made in one direction (B.P.R. ♂ × C.I.G. ♀) than in the reciprocal. The hatching quality of the fertile eggs is not greatly different in the cross and its reciprocal. The hybrid matings in both cases gave a much larger percentage of fertile eggs hatched than did the pure matings. Study of the sex-ratios indicate that relatively more males were produced among the hybrid chicks than among those from pure matings, but the difference cannot be regarded as significant. The mortality of the hybrid chicks from pure Cornish mothers was about the same as that of the pure Cornish chicks; and that of the hybrids from Barred Rock mothers was about the same as of pure Barred Rock chicks. The percentage mortality of all chicks from Cornish mothers was higher than that of all chicks from Barred Rock mothers. Hybrid pullets from Cornish mothers were relatively good layers, those from Barred Rock mothers relatively poor. This result is discussed from the Mendelian point of view. Shank and beak colour are inherited in a sex-limited fashion. The down colour of the chicks in the female hybrids is different from what it is in either of the two pure breeds crossed. Dominance of pea-comb over single is found to be far from perfect. The hybrids show a perfectly graded series of comb types from perfect pea to the perfect single condition. In shape of body the hybrid males are essentially like the pure Cornish Indian Game males. The hybrid females are intermediate in shape of body between the females of the two pure breeds crossed.

Inheritance of Colour-pattern in Hybrid Poultry.†—R. Pearl and F. M. Surface discuss the barred or “cuckoo” colour pattern in hybrid poultry. Barring is inherited in a sex-limited fashion; the sex-limited inheritance is equivalent to a phenomenon of segregation in the female generation. The barred pattern is inherited as a unit character independent of the pigment which fills the pattern, and “more intense” pigmentation is dominant over “less intense”; with the final result that the actual somatic barring is less well-defined in the barred hybrids than in their barred parents. The ground colour of the barring is also different in the hybrids. There is no evidence of a blended inheritance of degrees of intensity of pigmentation.

* Report Maine Agric. Exper. Stat. (1910) 84 pp. (54 figs.).

† Arch. Entwickl. Mech., xxx. (1910) pp. 45-61 (3 pls.).

Development of Limbs in *Salamandrella kayserlingii*.*—J. J. Schmalhausen has made a careful study of the development of the limbs in this Urodele, which shows several remarkable peculiarities, e.g. in the position of the intermedium entirely between the primordia of the ulna (or fibula) and the radius (or tibia), and in the disposition of the basipodials in longitudinal rays. The author thinks that the evidence goes to show that the Protetrapoda had five centralia, a præ-hallux in front of the hallux, a postminimus behind the fifth digit, and an arrangement of the elements in regular rows, as if they were the results of the division of the fin-rays of a fish-like ancestor.

Teleostean Ova and Larvæ.†—A. E. Hefford gives an account of a large number of Teleostean ova, both pelagic and dimersal, observed at Plymouth. Among the pelagic forms described may be noted gold-sinny, gaper, scad, boar-fish, dragonet, sole, solenette, top-knot, whiting, rock-ling, frog-fish, and sprat. Among the dimersal forms dealt with may be noted the shanny, the cornish sucker, and the john-dory.

b. Histology.

Interstitial Tissue of Striped Muscle.‡—J. Hirschler concludes that the "trophospongia nets" in the wing-muscles of Insects (that are rich in plasma), in the heart-muscle of Vertebrates, or in the muscles of the crayfish, correspond to the basal membranes of these muscle-fibres (and in the frog to the middle membrane as well). The "trophospongia nets" in the skeletal muscles of Vertebrates are identical with the sarcosome rows of Krause and Retzius. The "trophospongia nets" in the skeletal muscles of Insects are identical with similar sarcosome rows. What Holmgren has described as exogenous and new structures are endogenous and essential parts of the muscle-fibre.

Direct Division of Red Blood Corpuscles in *Scorpæna*.§—E. Mencl observed two cases of the direct division of red blood corpuscles in *Scorpæna porcus*. An elongated dumbbell-like form was seen, with rounded contours round the two halves, and with the normal relations of cytoplasm and nucleoplasm.

Cartilage in Thymus of Rat.||—Tomaki Toyofuku found hyaline cartilage in the apex of the thymus in two cases. It has been shown by Erdheim that there are in the rat's thymus various epithelial vesicles and cysts and corpuscles of branchiogenous origin (from the third visceral cleft), and there can be no doubt that the piece of cartilage, which has been shown by Toyofuku to occur in a few cases, is derived from the branchial arch.

Ligaments of Oviduct of Domestic Fowl.¶—M. Curtis gives an account of the anatomical structure of the ligaments of the oviduct in the domestic fowl, the investigation of which he was led to undertake by

* Anat. Anzeig., xxxvii. (1910) pp. 431-6 (1 pl. and 7 figs.).

† Journ. Marine Biol. Assoc., ix. (1910) pp. 1-58 (2 pls.).

‡ Bull. Internat. Acad. Cracovie, 1910, pp. 448-76 (1 pl.).

§ Anat. Anzeig., xxxvii. (1910) pp. 539-40 (1 fig.).

|| Tom. cit., pp. 573-5 (1 fig.).

¶ Maine Agric. Stat. Exper., Bull. 176 (1910) pp. 1-19 (9 figs.).

the apparent disproportion between the amount of musculature in the walls of the oviduct and the physical activity of the organ. He shows that the dorsal and ventral ligaments undergo a progressive change in shape and size relations as the oviduct enlarges in preparation for functional activity, and the character of these changes is described. The ligaments of the oviduct possess a well-developed musculature which is continuous with the outer muscle-layer of the oviduct. The mutual relations of the abdominal viscera are such as to form a pocket in which the ovary lies. This walling off of the ovary tends mechanically to direct detached ova to the mouth of the oviduct.

c. General.

Evolution of Man.*—Henri Douville suggests that a change of climate towards cold caused a recession of forests in which Anthropoid apes lived and thrived. The area previously covered with forest became dry "bush," and it was there that Man emerged—adapted not to arboreal life, but to walking on the ground.

European Mammals.†—E. L. Trouessart makes a plea for the more thorough and critical study of the European Mammals. The Mammalian fauna is much less uniform than is usually supposed. The little grey squirrel of the north of Scandinavia, which sometimes becomes white in Siberia, the red squirrel of Central Europe, and the black squirrel of the mountainous parts of the Mediterranean region, cannot be included in the same diagnosis. In the same way the "weasel" of Sardinia (*Putorius boccamela*) is neither weasel nor stoat; in Ireland there is the intermediate *P. hibernicus*; in Malta and Egypt there is *P. subpalmatus*; and so on. The water-vole (*Arvicola amphibius* L.) of France is different from *A. terrestris* L. of Scandinavia, and from *A. scherman* (Shaw) of the Swiss Alps. These local differentiations demand further study.

Six New European Mammals.‡—Gerrit S. Miller gives brief descriptions of *Sorex araneus granarius* subsp. n. from Spain, *Dyromys robustus* sp. n. from Bulgaria, *Microtus dentatus* sp. n. from Spain, *Pitymys atticus* sp. n. from Greece, *Apodemus sylvaticus creticus* subsp. n. from Crete, *Capreolus capreolus canus* subsp. n. from Spain.

Atlas of the Okapi.§—E. Ray Lankester has published a fine atlas of this interesting type, which is isolated from other living forms, and nearly related to *Palaëotragus* and *Samotherium* of the Lower Pliocene of Greece. The atlas has been compiled with the assistance of W. G. Ridewood, and the beautiful plates are for the most drawn by G. M. Woodward and Grönvald. The variability of the skull and of the leg-striping is very remarkable. An interesting diagram compares the various planes of the skull in the Okapi with those of other Mammals. There is an interesting photograph of a young Okapi. There is no text published, but with its full descriptions the atlas is complete in itself, and a beautiful piece of work.

* Comptes Rendus, cli. (1910) pp. 742-6.

† Tom. cit., pp. 648-50.

‡ Ann. Nat. Hist., vi. (1910) pp. 458-61.

§ Monograph of the Okapi: Atlas. Printed by order of the Trustees of the British Museum, 1910 (48 pls.).

Spermaceti-organ of *Kogia breviceps*.*—E. Danois finds that the general character of this organ in *Kogia* is like that in the Cachalot. The cavities seem to be homologous in the two types. Danois corroborates the view of Pouchet and Beauguard that the spermaceti-organ is a dependence of the right nostril, and represents the mucous amygdaloid gland in the right nostril of other toothed Cetaceans, such as the dolphin.

Fossil Cetacea.†—G. H. Perkins reports on various fossil remains of Cetacea in North America, and the result of a painstaking inquiry is to show that the specimens in the museums of Ottawa, Halifax and Montreal may be referred to the following species:—*Delphinapterus leucas* Gray, *D. vermontanus* Thompson, *Monodon monoceros* Linn., and *Megaptera longimana* (Cooks) Gray.

Guttural Pouches of Horse.‡ —Walter Stapely discusses these hernial modifications of the auditory tube of the horse. Between the lateral and median fibro-cartilaginous laminae of the auditory tube, the mucous membrane of the tube finds its exit, in sac form, into the retropharynx. The mucous membrane of the tube has probably been dragged out of the tube by adhesion of the stylo-hyoid bone with the membranous lamina, and through it adhesion to the mucosa and stylo-hyoid has occurred. The development of depth of the mandible caused a descent of the larynx, with which organ the stylo-hyoid bones were also carried down. The mucous folds, once in the retropharynx, were spread to their present confines by flexion and extension of the atlas-occipital joint, etc., through adhesion of the sub-mucosa with the surrounding structures.

The guttural pouches have a protective value, and allow of free movement of the head. They adapt themselves to every movement so beautifully that nerve pressures or pulls do not occur. Perhaps the contained air lessens friction.

Relative Immunity of Birds to Anthrax.§ —Otto Hofherr finds that, though there is no absolute immunity, it is very rare for healthy adult birds to be naturally infected with anthrax. He has brought about artificial infection in pigeons, ducks, and fowls, by introducing large numbers of anthrax spores into the alimentary canal. The conditions that favour infection are inanition, disease, and youth.

Grass Snake in the Sea.||—J. Guérin-Ganivet reports the capture of a grass snake (*Tropidodontus natrix*) well out to sea between the Finistère coast and the Glénan Islands. If it came from the islands, it must have gone four miles, but it was probably from the mainland—six miles off.

Muddy Taste in Fresh-water Fishes.¶—Louis Léger has made some interesting experiments showing that the well-known disagreeable

* Comptes Rendus, cli. (1910) pp. 690-2.

† Proc. Trans. Nova Scotia Inst. Halifax, xii. (1910) pp. 139-63 (8 pls.).

‡ Proc. R. Soc. Victoria, xxiii. (1910) pp. 33-5.

§ Centralbl. Bakt., lv. (1910) pp. 434-64.

|| Bull. Inst. Oceanogr. Monaco, No. 131 (1909) pp. 1-2.

¶ Comptes Rendus, cli. (1910) pp. 900-2.

taste of some fresh-water fishes from certain basins is due to the animals becoming saturated with "the essence of Oscillarias," on which they directly or indirectly feed. The bad taste is most marked in the skin-glands and the kidneys, and is less marked, of course, in proportion as the fish is less vegetarian in its diet.

Scales of Fishes.*—T. D. A. Cockerell describes the structure of the scales of some African Characinid fishes, which are primitive relatives of the Cyprinidæ. The sculpture of an ordinary fish-scale includes two important elements, the circuli and the radii. The circuli are circular lines, sometimes referred to as "lines of growth," while the radii are lines or grooves radiating outward from the nuclear area. The radii seem to be of secondary origin. They may lose their radial arrangement and simulate circuli, just as circuli may become transverse. The African Characinidæ have scales of two main types—one Cyprinoid (including Hydrocyoninæ and Citharininæ), the other Ctenoid (including Ichthyoborinæ and Distichodontinæ). In another paper,† the author describes the scales of Mornirid fishes, which are cycloid, with well-developed circuli and with strong basal radii, but with this remarkable feature, that the apical radii are greatly modified and join irregularly, forming a network.

Variations in Ureters of Weever.‡—J. Chaine finds that in this fish (*Trachinus draco*) the commonest arrangement of the ureters is that they unite just behind the posterior end of the kidney, forming a relatively long common canal to the bladder. In many cases they do not unite till near the bladder. In rare cases (two were observed) they open separately into the bladder.

Variation of Species of Notropis.§—H. W. Fowler shows the range of variation in the important or fundamental characters of a majority of the species of this genus of Cyprinidæ.

Growth of *Salmo hucho*.||—O. Haempel finds that the methods of estimating age in various Teleosteans apply well to *Salmo hucho*, where the winter and summer zones can be read in the scales, otoliths, operculum, vertebrae, and upper jaw. The rings on the vertebrae are particularly clear. In the first four years there is great increase in length, about 15 cm. annually, but it then sinks to 2-5 cm. annually. On the other hand, the increase in weight is at first slight (250 gm. in a year), but from the fifth year onwards, 1-2 kilogram. per annum.

Biological Stations.¶—Chancey Juday gives an interesting illustrated account of some of the European biological stations—at Plymouth, Port Erin, Cullerecoats, Sutton Broad, Millport, St. Andrews, Bergen, Kristineberg, Furesee, Helder, Overmeire, Heligoland, Plön, Roscoff,

* Smithsonian Misc. Coll., lvi. (1910) No. 1, pp. 1-10 (2 pls. and 2 figs.).

† Tom. cit., No. 3, pp. 1-4 (3 figs.).

‡ P.V. Soc. Sci. Bordeaux, 1909, pp. 5-6.

§ Proc. Acad. Nat. Sci. Philadelphia, 1910, pp. 273-93 (7 pls.).

|| Internat. Rev. Hydrobiol., iii. (1910) pp. 136-55. See also Zool. Zentralbl. xvii. (1910) p. 686.

¶ Trans. Wisconsin Acad., xvi. (1910) pp. 1257-77 (4 pls.).

Banyuls, Cette, Wimereux, Villefranche, Monaco, Trieste, Rovigno, Lunz, Naples, Cagliari, and Sebastopol.

Outlines of Zoology.*—J. Arthur Thomson has revised his *Manual of Zoology*, introducing a large number of new figures and a number of modifications in his treatment of the subject.

INVERTEBRATA.

Fresh-water Microfauna from German East Africa.†—E. v. Daday continues his interesting task, and reports a number of new Ostracods (e.g. species of *Stenocypris*, *Cypridella*, and *Potamocypris*), thirty of which are known as yet only from German East Africa, a new species of *Macrobiotus*, and some Hydraenids.

Plankton of Spitzbergen.‡—Hjalmar Broch deals with the plankton from the Eisfjord of Spitzbergen. Some Tintinnidae, two Plutei of an Ophiuroid—*Sagitta* and *Eukrohnia hamata*—various Copepods, the Pteropod *Limacina helicina*, and the Appendicularian *Fritillaria borealis*, are among the forms dealt with. The author describes three new species of *Peridinium*, and has some interesting notes on a number of others. Of particular importance are his observations on the form-changes associated with growth.

Mollusca.

γ. Gastropoda.

Genus Cumanotus.§—Nils Odhner compares *Cumanotus beaumonti* from Plymouth with the Norwegian *C. laticeps*, and finds they are the same. Thus he concludes that this genus of Nudibranchs has only one species, viz. *C. beaumonti* (Eliot, 1906), of which *C. laticeps* Odhner 1907 is a synonym. The species has consequently a wide distribution, being obtained in England as well as in northern Norway.

Structure of Phylliroë bucephala.||—N. Vessicelli gives an account of the nervous system, which bears a close resemblance to that of *Aplysiella* and *Tritonia* and the Gymnosomata. The pedal, labial, cutaneous, and other glands are described, and the structure of the gonads is discussed. The association of *Phylliroë* with *Mnestra*, with an Anthomedusoid, and with *Halitemma*, is also discussed.

Opisthobranchs of South Africa.¶—R. Bergh reports on a collection which adds greatly to the little that was known of South African Opisthobranchs. He establishes new species of *Aplysia*, *Philine*, *Doridium*, *Pleurobranchæa*, *Oscaniella*, *Archoloris*, *Doriopsis*, *Nembrotha*, *Tritonia*, *Pleurophyllidea*, and other genera, and contributes a large amount of anatomical description.

* *Outlines of Zoology*. Edinburgh, Glasgow, and London: 1910, 5th ed., xxi. and 855 pp. (420 figs.).

† *Zoologica*, xxiii. (1910) Heft 59, pp. 177-240 (3 pls. and 8 figs.).

‡ K. Svenska Vetensk. Handl., xlv. (1910) pp. 25-64 (27 figs. and map).

§ *Journ. Marine Biol. Assoc.*, ix. (1910) pp. 82-4.

|| *M.T. Zool. Stat. Neapel*, xx. (1910) pp. 108-28 (1 pl. and 3 figs.).

¶ *Trans. S. African Phil. Soc.*, xvii. (1908, received 1910) pp. 1-144 (14 pls.).

8. Lamellibranchiata.

Visceral Ganglion of Pecten.*—W. J. Dakin describes the large-complicated visceral ganglion, whose great development is correlated with the extent of the area of innervation, and due to the reduction of the more anterior parts of the animal, the absence altogether of the anterior adductor, and the corresponding increase of the posterior muscle and other parts.

Dakin describes the lobes of the ganglion, the innervation of the osphradium, the central neuropil (an intricate mass of neurofibrils) and the cortical layer of motor ganglion-cells, and the minute structure generally.

The scallop is very sensitive to the presence of starfishes, which are recognized by the olfactory sense, and not by touch or sight. The osphradia and abdominal sense-organs do not appear to play any visible part in the perception of starfish.

The orientation of the animal is apparently controlled by the otcocysts. The movements of the velum and adductor muscle are co-ordinated, and are concerned in several important functions, as swimming, orientation, and expulsion of reproductive cells.

Removal of the abdominal sense-organ has no visible effect on the perception of vibrations in the water. The function of this organ is probably different from that of the osphradium, and may be the regulation of currents in the pallial cavity.

Cleansing Oysters.†—Fabre-Domergue has made an interesting and practically important series of experiments to show that oysters may be kept for eight days or more in filtered water, frequently renewed, without losing in weight or in vital resistance or in appearance. In this way the cleansing of the pallial cavity from deleterious micro-organisms can be secured without affecting the market value of the oysters.

Feeding Habits of Oysters.‡—Fabre-Domergue refers to the belief that oysters feed selectively on Diatoms, Infusorians, Copepods, and the like, rejecting by their labial palps what is unsuitable, while the gills exhibit no filtration. This view is weakened by experiment. Oysters placed in water badly contaminated with recognizable faecal matter ingested large doses of this. A bacteriological inquiry should extend to the intestinal contents of the oyster.

Arthropoda.*a. Insecta.*

Colour-sense of Hive-bee.§—John H. Lovell has made a number of very interesting experiments bearing on the much-discussed question whether hive-bees can distinguish colours. His conclusions are the following: Bees easily distinguish colours, whether these are artificial or natural. They are more strongly influenced by a coloured slide than by one without colour. Bees which have been accustomed to visit a

* *MT. Zool. Stat. Neapel*, xx. (1910) pp. 1-40 (2 pls.).

† *Comptes Rendus*, cli. (1910) pp. 734-6.

‡ *Tom. cit.*, pp. 829-31.

§ *Amer. Nat.*, xliv. (1910) pp. 673-92.

certain colour tend to return to it habitually. They exhibit colour fidelity; but this habit does not become obsessional, since they quickly learn to discriminate between colours when this is for their advantage.

Scelionid Parasite of Spider's Eggs.*—E. Bugnion and N. Popoff describe *Baeus apterus* sp. n., a small apterous Hymenopteron, allied to the Proctotrupidæ, which lays its egg in the egg of a Ceylonese spider, *Argyope ætherea* Walckenaer. The parasite develops in about 12 to 13 days, which corresponds to that of the spider (14 to 15 days). The male insect is winged; and the authors note the curious point that in *Oophthora semblidis* Aur., studied by Silvestri, it is the male that is apterous, while the female is winged.

Nervous System of *Dytiscus marginalis*.†—Georg Holste gives a full and well illustrated account of the macroscopic features of the nervous system of this beetle. The nerves of the thorax and abdomen are thoroughly worked out and named for the first time. Attention may also be directed to the analysis of the sympathetic nervous system—the ganglia and nerves of the gut, the dorsal blood-vessel, and the tracheæ.

New Termitophilous Staphylinid.‡—F. Silvestri describes *Termitochochus indicus* g. et sp. n. from Singapore termitaries (*Eutermes singaporensis* Havil.). It is allied to *Termitomimus* Träg., but is very distinct. The female has an elongated body, with a triangular inflated abdomen turned upwards and forwards, so that sternites 2-6 are posterior and dorsal.

Eye of *Dermestes*.§—O. Kirchhoffer has studied the development of the eye in this beetle. The conical ingrowths of the cornea (corneal processes) cannot be regarded as crystalline cones which have fused with the cornea. The crystalline cones are intra-cellular structures due to "Semper's cells," and they are not developed in *Dermestes vulpinus*. The corneal processes are extra-cellular products of "Semper's cells," which lie in the imago between the corneal processes and the retinula.

In the formation of the cornea a part is played to begin with not only by "Semper's cells," but also by the main and the accessory pigment-cells. The corneal processes are formed in the same way as the cornea proper.

The retinula consists primarily of eight cells, of which one is central, while seven are peripheral. By the coalescence of the peripheral cells the central cell is compressed down to its nucleus.

The pigment is not a product of the cells in which it occurs in the imago. It arises from the pigment of the larval eyes, which retreat during metamorphosis towards the optic ganglion. The pigment-granules migrate along the post-retinal fibres, first into the retinula cells and then into the pigment-cells.

Intestinal Secretion in *Dytiscus*.||—Deegener describes what goes on in *Macrodrytes* (*Dytiscus*) *circumciuctus*, and compares the process with

* Rev. Suisse Zool., xviii. (1910) pp. 729-38 (1 pl.).

† Zeitschr. wiss. Zool., xevi. (1910) pp. 419-76 (12 figs.).

‡ Boll. Lab. Zool. Scuola Agric. Portici, v. (1910) pp. 37-9 (3 figs.).

§ Arch. Natur., lxxvi. (1910) pp. 1-26 (2 pls. and 7 figs.).

|| Tom. cit., pp. 27-43.

that in the caterpillar of the spurge moth. The latter eats almost continuously; a full crop may serve the beetle for 24 hours. The secretory activity of the intercrypt-cells and villus-cells seems to be interrupted for considerable intervals, so that these elements may also be absorptive. The crypt-cells of the posterior mid-gut and the cells of the smooth crypt-portion of the anterior mid-gut, which, with the crypts, are absent in the caterpillar, are purely secretory. In the caterpillar there are two kinds of secretory cells—kalykocytes and sphaerocytes; in the beetle there is only one kind, comparable to sphaerocytes. In the beetle there is a continuous separation and regeneration of cells or small cell-groups. In both caterpillar and beetle the same cell may form secretion repeatedly. There are no preformed openings for the escape of the secretion. The whole cell passes into the lumen of the gut.

Beetles in Ants' Nests.*—Arthur M. Lea records a large number of Australian and Tasmanian Coleoptera inhabiting or resorting to the nests of ants. A number were found along with two species of termite and along with the hive-bee and *Trigona carbonaria*. The paper is purely systematic.

Insects in Nepenthes Pitchers.†—J. C. H. de Meijere and H. Jensen have studied the insects which develop in the pitchers of *Nepenthes*. No fewer than seven species of Diptera were reared from larvæ taken from the pitchers—four Culicidæ, two Phoridae, and an Anthomyid, *Phaonia nepenthicola*. Jensen put a small pill of albumen in a pepsin solution, and added the juice of the larvæ. He found that this delayed the action of the peptic ferment, and the inference is that the larvæ have an anti-ferment which enables them to resist the digestive juice in the pitchers.

Beginning of Muscular Phagocytosis in Larval Muscids.‡—Ch. Pérez has observed that leucocytes penetrate absolutely healthy sarcoclemma, and get into absolutely normal sarcoplasm. The disintegration of the sarcoplasm and the degeneration of the muscle-nuclei do not begin until the leucocytes have found their way in.

Metamorphosis of Intestinal Musculature in Muscid Larvæ.§—Ch. Pérez finds that the mid-gut musculature is a network of circular and longitudinal fibres, which contracts into a compact sheath at the beginning of pupation. When the imaginal epithelium forms a continuous layer, the larval musculature undergoes phagocytosis. But the muscle-nuclei persist, and only the myoplasm is engulfed. The nuclei become the nuclei of new muscle elements, and the regeneration is accompanied by direct nuclear division.

Habits of Procession Caterpillar.||—H. H. Brindley adds some fresh observations on the habits of the procession caterpillar, *Unethocampus pinivora*, to those made by him in 1901, and by T. G. Edwards in 1909.

* Proc. R. Soc. Victoria, xxiii. (1910) pp. 116-230 (3 pls.).

† Ann. Jard. Bot. Buitenzorg, iii. (1910) pp. 917-46 (4 pls.). See also Zool. Zentralbl., xvii. (1910) pp. 679-80.

‡ P.V. Soc. Sci. Bordeaux, 1909, pp. 25-6.

§ Tom. cit., p. 34.

|| Proc. Cambridge Phil. Soc., xv. (1910) pp. 576-87 (2 pls.).

Many nests containing living larvæ were found on the young saplings of a pine forest at Arcachon, and in all cases the branches near the nest were matted with the threads secreted by the larvæ. Below the nest threads were rare, and only a few (none of which reached the ground) were found on the trunks. The threads gave no evidence that leaving the nest and returning to it was a frequent habit. Many experiments were made with the thread formed by a procession on the march. The general result of these was to show that the thread is of very slight importance either in the formation of a procession, or in maintaining its integrity. The thread forms the nest in the tree and the cocoon in the pupa state, but the reason why it should continue to be secreted while the larvæ are feeding or away from the nest remains obscure, unless it may be regarded as an excretion. Experiments in regard to leadership showed that the same leader took the head of the procession in about 50 p.c. of cases, when it was re-formed after either natural or artificial massing. It seems certain that contact between the larvæ is of much importance, and that, though there is no permanent leadership, the leader for the time being does determine the behaviour of the procession, because all its members endeavour to maintain a head-to-tail contact. Mass formation is always, and burrowing frequently, begun by the leader. The observer experienced no irritation from handling the caterpillars, and believes with Edwards, that the sensibility to the glandular hairs varies with the individual.

Spermatogenesis in Lepidoptera.*—Margaret Harris Cook has studied *Callosamia promethea* and some other types. A careful examination of the chromatin elements shows that one acts differently from the others during a certain period in the development of the germ-cells. It is distinguished from all other cell-structures by its staining reaction, its precocious division, and its close association with a plasmosome; while later it shows likeness to the other chromosomes in form, valence, and division; such behaviour makes it necessary to interpret this, as other workers have done, as an equal pair of idiochromosomes representing different characters from those of the other chromosomes, and expressing by their peculiar behaviour a masked dimorphism.

The following facts are in favour of the theory of the individuality of the chromosomes: the number remains the same from generation to generation; they are seen in maturation-divisions to be formed of pairs of equal size; in smear preparations the boundaries can be traced, and the chromosomes never entirely lose their continuity during the growth stage, and at least one of the chromatin elements shows marked peculiarity in its behaviour, and can therefore be traced throughout the growth period. These facts show that Lepidoptera, like the other Insect orders, may be brought into harmony with recent cytological work. A summary of the detailed observations is given.

New Flea from Jerboa.†—Alfons Dampf gives a full description of *Mesopsylla eucta* g. et sp. n. from *Macranga javulus*, and makes comparative notes on *Palæopsylla* Wagner, and other fleas.

* Proc. Acad. Nat. Sci. Philadelphia, 1910, pp. 294-327 (6 pls.).

† Zool. Jahrb., 1910, Suppl. 12, Heft 3, pp. 609-64 (34 figs.).

Head-glands of Caddis-worms.*—E. L. Russ has studied the glands in the head of larval Trichoptera, especially those of the fourth and fifth head-segments. Two different types occur: the Limnophilid type, consisting of a group of more or less distinct cells opening into an efferent duct, and the Rhyacophilid type, consisting of closely compacted glandular cells radially disposed around a central canal. An extra pair of internal mandibular glands is reported in the larva of *Rhyacophila obliterata*.

Injurious Insects in Ireland.†—George H. Carpenter reports on injurious insects and other animals observed in Ireland during the year 1909, such as the March moth (*Anisopteryx æscularia* Schiff), the female of which is wingless, like that of the allied winter moth; the fir-seed Chalcid (*Megastigmus strobilobius* Ratz.), the ox-louse (*Hæmatopinus euryesternus* Nitzsch). Besides insects, he deals with spotted Millipedes (*Blaniulus*), which enter potato-tubers by minute lesions, the harvest bug (*Trombidium*), the root-knot eelworm (*Heterodera radicicola* Greef), which has hitherto been unknown in Ireland, and other animals.

Notes on Chermes pini.‡—Paul Marchal suggests that the extraordinary mechanical activity of the migration in the sunshine, followed by abundant absorption of sap when they settle, may be connected in these insects with the bringing on of the production of sexual forms. He also calls attention to interesting intermediate forms between the "exules alatae" and the "sexiparous" forms.

β. Myriopoda.

Cavernicolous Myriopoda.§—H. W. Brölemann continues his studies in "biospeleology," and reports on a number of Myriopods from caves. He deals with *Scutigrella immaculata* Newport among the Symphyla, *Polyxenus lucidus* among the Pselaphognatha, a number of Polydesmoidea, and *Callipus fatidissimus* Sav. among the Lysiopteroidea. Among the Polydesmids is a new genus, *Haploleptodesmus*.

δ. Arachnida.

Palpi of Male Spiders.||—J. H. Comstock describes some of the types of palps, and seeks to establish a satisfactory nomenclature. He begins with a generalized type of palp, as in *Filistata* and *Eurypelma*, and works on to the highly complex types, as in *Linyphia* and *Aranea*. An account is given of the numerous different parts in a specialized palp, and emphasis is laid on the importance of describing palpi from expanded specimens.

New Ixodidæ.¶—L. G. Neumann describes the following new species: *Ixodes elegans* from Chili, *Apouamma pattoni* from India, *Rhipicephalus plauus* from S. Cameroon, and *Argas delicatus* from Central Asia, and a number of imperfectly known forms.

* Arch. Zool. Expér., v. (1910) Notes et Revue, No. 3, pp. lxi-lxvii (2 figs.).

† Econ. Proc. R. Dublin Soc., ii. (1910) pp. 8-30 (1 pl. and 10 figs.).

‡ Comptes Rendus, cli. (1910) pp. 832-4.

§ Arch. Zool. Expér., v. (1910) pp. 339-78 (4 pls.).

|| Ann. Entomol. Soc. America, iii. (1910) pp. 161-85 (25 figs.).

¶ Ann. Sci. Nat. (Zool.) xii. (1910) pp. 160-76 (12 figs.).

Salivary Glands of Ticks.*—M. Elmæssian describes these in two Ixodidæ, *Margaropus annulatus* and *Hyalomma ægyptium*, and in *Argas persicus* one of the Argasinæ. There are two pairs of glands, one of the tubular type and the other acinous. The tubular gland of *Margaropus annulatus* is taken as a type of a gland with mucous secretion. The acinous gland of *Hyalomma ægyptium* is taken as a type of a gland with mixed mucous and serous secretion. The minute details of the process of secretion are described.

New Species of Argas.†—Georgina Sweet describes *Argas victoriensis* sp.n., from a fowl in North Victoria. All other fowl-ticks, so far, examined from Victoria, New South Wales, and Tasmania, have been undoubtedly *A. persicus*, but this new form seems to be distinct.

Pacific Pycnogonids.‡ Leon J. Cole reports on six Pycnogonids collected by the 'Albatross' from four stations in the Eastern Pacific: *Ascorhynchus agassizii* Schinckewitsch, *Colosseudeis gigas* Hoek, and *C. cucurbita* sp.n., which is closely related to *C. gigas*, but has a proboscis with an upward curve, and the fourth joint of the palp longer than the second.

Notes on Endeis spinosus.§—Leon J. Cole reports the abundant occurrence of this Pycnogonid, new to North America, among the colonies of *Obelia dichotoma* growing on the Sargasso weed drifted into Vineyard Sound. The specimens were inseparable from others from Naples, Plymouth, Norway, and the Tortugas. It seems to have become pelagic on the American side of the Atlantic. The heart showed 172 contractions per minute. There appeared to be a real circulation from the body out into the legs and back, but this was rendered more or less indefinite by the peristaltic contractions of the intestine, which imparted a sort of churning motion to the blood and kept it moving back and forward. In a specimen under a cover-glass these peristalses recurred at intervals of two or three seconds.

ε. Crustacea.

Photophores of Decapod Crustacea.||—S. Kemp describes the structure of the photophores of Decapod Crustaceans. Photophores only occur, as far as is known, in three types of Decapod Crustaceans, one of them, *Sergestes*, belonging to the Penæidea, the other two, *Acanthephyra* and *Holophorus*, to the Caridæ. The structure is wholly different in the Penæid and Carid types, but they possess one very striking feature in common: a deep-blue pigment is associated with the luminous organ in both. In *Sergestes* the photophores are distributed on the lower sides of the eye-stalks, antennules and antennal scales, on the oral appendages, on the thoracic and abdominal sterna, on the ventral surface of the outer uropods, and on many of the leg-joints. In *S. challengeri* photophores occur in the roof of the branchial chamber, and illuminate

* Arch. Zool. Expér., v. (1910) pp. 379-419 (2 pls.).

† Proc. R. Soc. Victoria, xxiii. (1910) pp. 15-18 (1 pl.).

‡ Bull. Mus. Comp. Zool. Harvard, li. (1909) pp. 185-91 (3 pls.).

§ Biol. Bull., xviii. (1910) pp. 193-203 (2 figs.).

|| Proc. Zool. Soc. London, 1910, pp. 639-51 (3 pls.).

the gills from above. In this group the photophores are all identical in structure and are quite immovable, though some of them are borne on short thick stalks, that they may bear more directly downwards. They apparently increase in number even after the animal has reached maturity. In *Acanthephyra* the organs differ in complexity according to their position. There are twelve highly-developed organs, each placed so that the light it produces is thrown directly downwards. One is situated on the distal and external aspect of the protopodite of each pleopod, and one behind the protopodite of each uropod. A dark violet-blue streak on each side of the inner wall of the carapace immediately behind the last pair of thoracic legs, is evidently from its structure also a photophore, though it is less highly specialized than those at the base of the pleopods. In addition, there are very numerous pigmented spots, which the observer agrees with Coutière in regarding as simple aggregations of luminous cells. The brilliant scarlet-red colour characteristic of deep-sea Decapods is quite undeveloped in the neighbourhood of the photophores. The more complex photophores appear first, the earliest known larva already possessing the twelve organs. Fresh spots of blue pigment appear after every moult; in the largest individual examined they reached the number of 147. The great majority of animals which possess photophores live on the surface or in intermediate depths.

Abnormal Cheliped of Lobster.*—Leon J. Cole describes an interesting abnormality in the cheliped of a lobster (*Homarus americanus*), the abnormality consisting of a double extra claw. While the extra part actually separates from the normal propodite, it is shown that the effects of the doubling may be traced to the base of the leg. It is further shown that the conditions in this appendage illustrate almost diagrammatically the "rules of secondary symmetry" formulated by Bateson, if allowance be made for the effects of the torsion which occurs in the normal lobster cheliped, and the mechanical conditions which may modify such torsion. Other similar abnormalities are discussed.

Heterocuma.†—W. T. Calman describes an immature female of *Heterocuma sarsi* Miers from the Straits of Korea, and makes some remarks on the genus, which occupies an interesting position among Cumacea. It agrees in some respects with *Cumopsis*, among the Bodotriidae, and in some ways with *Vauntomponia*; it seems to make clear that the line of separation between Bodotriidae and Vauntomponiidae can no longer be maintained.

Monograph of Phyllopoda Anostraca.‡—Eugène Daday de Déès has completed an elaborate monograph on this sub-order of Phyllopods. Among the extant families the Polyartemiidae, Branchipodidae, and Streptocephalidae have well-defined boundaries. The uniformity of the family Branchinectidae is interrupted only by the genus *Artemiopsis*, which has a penis of divergent structure. Much importance cannot be attached to the presence of eight segments in the abdomen of *Artemia* and *Artemiella*, or to the two branchial lamellae in *Branchinectella*. The

* Biol. Bull., xviii. (1910) pp. 252-68 (9 figs.).

† Ann. Nat. Hist., vi. (1910) pp. 612-16 (1 pl.).

‡ Ann. Sci. Nat., xi. (1910) pp. 91-489 (84 figs.).

limits of the Chirocephalidæ are not very precise, but its sub-families Chirocephalinae and Eubranchipodinæ are uniform. The sub-family Branchinellidæ is divergent in the structure of the penis.

The author gives a genealogical tree, and inclines to the conclusion that the sub-order has had a polyphyletic origin—a view that is corroborated by the facts of geographical distribution.

New Antarctic Phyllopod.*—Engène Daday de Dées describes *Branchinerta gaini* sp. n., a new Anostracan Phyllopod found by L. Gain of the 'Pourquoi-pas?' Expedition in Petermann Island and adjacent islands. It was found in crevices among the rocks where water collected from melted snow. It is like some of the northern species, but seems distinct, and is the first Antarctic representative of its race.

Affinities of Philichthydæ.†—A. Quidor has studied the life-history and affinities of *Leposiphilus labrei* Hesse parasitic on the scales of *Labrus domovani*. In their first parasitic stages the Philichthydæ show relationship with the Dichelestidæ; in their free stages they show relationship with such Lernæidæ as *Lernæa* and *Penella*. It seems likely that the Philichthydæ should be ranked as intermediate between Lernæidæ and Dichelestidæ.

Parasitic Copepod from Cephalodiscus.‡—W. T. Calman describes *Zanclopus cephalodisci* g. et sp. n., one of the Ascidocolidæ, found in *Cephalodiscus*. It is most nearly allied to *Enterognathus comatulæ* of Giesbrecht; it also approaches *Enterocola*, *Aplostoma*, and *Enteropsis* in the vermiform or maggot-shaped body and non-natatory thoracic feet of the female, and in the absence of a brood-sac and of maxillipedes; but it is a very distinct type.

Ostracods from Funafuti.§—Frederick Chapman reports on fifty-two species and varieties of Ostracods from near Funafuti, eight of them from great depths (2¼ to 3 miles). Nine new species of *Cythere* and other genera are described, and Brady's Pliocene *Lorocorcha latissima* is noted for the first time as recent.

Notes on Cladocera.¶—E. A. Birge discusses *Pseudosida bidentata* Herrick and the genus, *Latona parviremis* sp. n. and the genus, *Latonopsis fasciculata* Daday, *Wlassicsia kinistinensis* sp. n., *Odontalona* g. n. (erected for *Alona tenuicaudis* Sars and *O. longicaudis* sp. n.), and the genus *Alonella*.

Annulata.

Cuticular Warts of Pilargis verrucosa.¶¶—Ch. Pérez found at Arcachon an interesting Polychæt described by Saint-Joseph under the name *Pilargis verrucosa*. Its thick cuticle is more like that of an Arthropod. There are no mucous glands, and the whole dorsal surface is studded with peculiar warts, almost wholly cuticular.

* Comptes Rendus, cli. (1910) pp. 688-90. † Tom. cit., pp. 834-6 (1 fig.).

‡ Marine Investigations in S. Africa, v. (1908, received 1910) pp. 177-84 (2 pls.).

§ Journ. Linn. Soc. (Zool.) xxx. (1910) pp. 388-444 (4 pls.).

¶ Trans. Wisconsin Acad., xvi. (1910) pp. 1017-66 (6 pls.).

¶¶ P.V. Soc. Sci. Bordeaux, 1909, pp. 24-5.

Littoral Polychæta of Torquay.* E. V. Elwes continues his notes on these worms, giving a list of the representatives of many families. He gives very useful keys to the genera of Eunicidæ, Spionidæ, Cirratulidæ, Maldanidæ, Terebellidæ, Sabellidæ, and Serpulidæ, found on the French and English coasts of the Channel.

Reactions of Earthworms to Acids.† S. H. Hurwitz has investigated the influence of organic and inorganic acids on the common manure worm *Allobophora fetida* Sav. He found that the reactions of the earthworms may be ascribed to the hydrogen ions the solutions contain, and that the reaction-time depends upon the number of hydrogen ions present in the solution of the acid. Using the reaction-time as a basis, the investigator found that the earthworm discriminated more certainly than man between a solution of acids at a concentration of $\frac{n}{400}$. The response of the earthworms to solutions of acetic acid was more active than might have been expected from the degree of dissociation of this acid, and in this respect the earthworm's reactions are in agreement with human sensations, as worked out by Kahlenberg and by Richards.

Caucasian Earthworms.‡—W. Michaelsen reports on eight new species, mostly from the Caucasus and Trans-Caucasus. There are so many Lumbricidæ in this region, and so many basal and amnetic types, that it seems reasonable to regard the region as the headquarters and centre of dispersion for earthworms. The classification which Rosa and Michaelsen established—mainly on the position of the male gonads and of the receptacula, and on the setæ and pigmentation—is being modified by the discovery of intermediate types. Thus *Eiseniella*, *Eisenia*, and *Dendrobæna* must be included in the single genus *Helodrilus*.

Nematohelminthes.

New Nematode in Eye of Queensland Fowl.§—Georgina Sweet describes *Oxyspirura parvovum* sp. n., which causes "worm in the eye" in Queensland poultry. It is really extra-ocular, like *O. munsoni*, occurring in numbers beneath the nictitating membrane. Four other Nematodes are reported, and a list is given of Metazoan parasites recorded from the fowl in Australia.

Microfilaria in Magpies.||—J. A. Gilruth, G. Sweet, and S. Dodd describe larval forms of *Microfilaria gymnorhina* sp. n. from the blood of Australian magpies (*Gymnorhina tibicen*). They are distinctly smaller than those observed by previous workers in crows, and described as larvæ of *Filaria tricuspidis* and *F. attenuata*, but they may turn out to be referable to one or other of these species.

Supposed Nematode in Circular Muscle of an Earthworm.¶ Gwynneth Buchanan describes in a Queensland earthworm, *Diporochæta*

* Journ. Marine Biol. Assoc., ix. (1910) pp. 59-81.

† Proc. Amer. Acad., xlvi. (1910) pp. 67-81.

‡ Ann. Mus. Zool. Acad. Imp. Sci. St. Pétersbourg, xv. (1910) pp. 1-74.

§ Proc. R. Soc. Victoria, xxiii. (1910) pp. 242-56 (5 pls.).

|| Tom. cit., pp. 236-41 (1 pl.).

¶ Proc. R. Soc. Victoria, xxiii. (1910) pp. 99-101 (2 pls.).

grandis, a parasite which in many features resembles a Nematode—perhaps a larval form of some already recognized species. But the entire absence of reproductive structures made it impossible to attempt a classification.

Platyhelminthes.

Dipylidium caninum in a Child.*—W. A. Riley reports the occurrence of this tapeworm in a boy at Ithaca. It is more generally known as *Tænia canina*, or *T. cucumerina*, or *T. elliptica*, and sixty-two cases have been recorded, mostly in children. The intermediate hosts are the dog-louse, *Trichodectes canis*, and the flea *Ctenocephalus canis*. Man may accidentally ingest one of these insects, and the parasites are able to complete their development in the unusual host.

Tapeworms of South American Felidæ.†—M. Lühe finds that *Tænia oligarthra* Dies. from *Felis concolor* is nearly allied to *T. echinococcus* v. Sieb., and that *Cysticercus macrocystis* Dies. from *Lepus brasiliensis* is the bladderworm stage of a new tapeworm, *T. macrocystis* (Dies.) from species of *Felis*. He also describes *T. omissa* sp. n. from *Felis concolor* and other species of *Felis*.

New Tapeworm in Chicken.‡—Georgina Sweet describes *Davainea varians* sp. n. from chickens in Melbourne. It is superficially very like *D. proglottina*, and in some respects it suggests a combination of features of *D. proglottina* and of *D. echinobothrida*. Two other species of *Davainea* and *Choanotænia infundibulum* are reported.

Parasites from Irish Sea Fishes.§—James Johnstone deals with *Lebouria ulonea* Nicoll from a common dragonet, *Prosthecobothrium dujardini* (van Beneden) from the skate, and *Echeneiobothrium variabile*. He discusses the genus *Echeneiobothrium*, which is defined by the presence of four Echeneiform bothria carried on contractile pedicels; by the absence of any armature of the bothria; and by the presence of a contractile myzorhynchus, at the apex of which there is a terminal "os."

Entozoa from Clyde Fishes.||—W. Nicoll describes *Peracreadium genu* (Rud.) from *Labrus berggylta*, *P. commune* (Olsson) from the same, *Lebouria varia* sp. n. (= (*Lebouria*) *alacris* (Lss.) Nicoll) from the dragonet, *Helicometra pulchella* (Rud.) from *Labrus berggylta* and the conger, *Pharyngora bacillaris* (Molin) from *Scomber scombrus*, *Prosorhynchus aculeatus* Odhner from the conger, and a number of other Trematodes. Adult forms of *Bothriocephalus bipunctatus* Zeder were found: *Cottus scorpius* and *Abothrium rugosa* (Goeze) in the pollack. The first is frequent in the turbot, the second is a typical gadoid parasite. The so-called *Scolex polymorphus* was common—a composite form that includes the larvæ of several species of *Calliobothrium*.

* Science, xxxi. (1910) pp. 349-50.

† Zool. Jahrb., 1910, Suppl. 12, Heft 3, pp. 687-710 (2 pls. and 8 figs.).

‡ Proc. R. Soc. Victoria, xxiii. (1910) pp. 243-56 (5 pls.).

§ Proc. and Trans. Liverpool Biol. Soc., xxiv. (1910) pp. 78-99 (10 figs.).

|| Parasitology, iii. (1910) pp. 322-59 (1 pl.).

New South African Polyclad.*—Lydia Jacobowa describes *Planocera gilchristi* sp. n. from Cape Town, which differs considerably from other species of the genus. The male copulatory apparatus is characterized by the abnormal structure of the penis and the granule gland. In the female apparatus the bursa copulatrix is provided with papillæ, and there is no accessory vesicle.

Incertæ Sedis.

New Hemichorda from South Africa.†—J. D. F. Gilchrist described (in 1907) a new genus of the Phoronidea, differing from *Phoronis* chiefly in having an involution of epidermis with definitely differentiated (cubical) cells. The involution occurs below the nerve-ring, which it partly covers: it passes round the body, encircling the mouth, anus, and nephridial apertures. In addition to this new type, *Phoronopsis albomaculata* g. et sp. n., he described *Phoronis capensis* sp. n. and *Ptychoderma capensis* sp. n.

The following observations were made on *Phoronis capensis*. Currents of water, with food and other particles, pass in between the outer and inner circle of tentacles towards the mouth. They pass out between the expanded tentacles, downwards between those of the outer row, and inwards and upwards between those of the inner. Another current of water passes in succession over two special patches of nervous epithelium, the nephridial openings, and the anal opening, and joins the last-mentioned current. Most of the particles in the first current come in contact with the tentacles, and are carried on them to the mouth region: some of these are then carried back on the same tentacles on which they came, and dropped off.

Two special patches of nerve-tissue on the nerve-ring are in a position with regard to currents of water similar to the pallial olfactory organ of Mollusca, and probably exercise a similar function. The nervous tissue at the commencement of the digestive tract appears, from the definite rejection of particles after reaching this region, to be an organ for the discrimination of food particles, and may be called an organ of taste.

The lophophoral gap between mouth and anus is, in the living and expanded animal, no wider than the spaces between the tentacles, and plays no special part in the passage of currents of water. The projecting free part of the lophophoral organ is relatively large and leaf-like in life, and in discharge of ova overlaps the nephridial opening conveying the ovum to the brood-cavity in the tentacles. The more glandular part probably supplies the mucus in which ovas and embryos are enveloped. The whole organ may be called a glandular oviducal furrow.

The blood (corpuscles and plasma) in the normal condition of the animal passes successively through a median (dorsal?) vessel, two circumoesophageal dilatable vessels, a lateral (ventral?) vessel, and on again to the median vessel. That is, in these vessels there is a true circulation which, however, becomes oscillatory, or partly so, under abnormal conditions. The movement of the blood is oscillatory (to and fro) in

* Marine Investigations S. Africa, v. (1908, received 1910) pp. 145-9 (1 pl.).

† Tom. cit., pp. 151-76 (2 pls.).

the vascular diverticula of the tentacles, the body-cavity and the gonads. It is also oscillatory in the small circular vessel at the base of the tentacles.

Reproduction may take place throughout the year, but is much more marked in the summer months. This species does not die off annually.

New Species of Alcyonidium.*—O. Roerich describes *Alcyonidium topsenti* sp. n., thrown up on the shore at Luc-sur-Mer. It somewhat resembles *A. gelatinosum*, but its surface is covered with fine asperities, and the zoecial orifice is bi-labiate. In *A. albidum* the orifice is trilobed, and Roerich proposes to modify the definition of the genus *Alcyonidium* to include these two labiate species. In the other species the orifice is simple and papilliform.

Growth and Habits of Biporæ.†—C. M. Maplestone thinks that the conical Biporæ in their living state have the base uppermost. All of them have on the apex small avicularia and pores, and the author considers that from these pores there grow out filaments similar to those recorded by Whitelegge on *Bipora philippinensis*, and probably attach themselves to fragments of shells, etc., on the surface of the ocean-bed, and so anchor themselves. He discusses the somewhat enigmatical "semi-lunar slits," and indicates his view that they do not indicate the commencement of new zoëcia.

Maplestone also describes‡ an interesting massive Polyzoon—*Cellepora verticalis* sp. n.—from the South Australian coast, and a noteworthy species, § *Parmularia obliqua* McG., which has a flexible stem or filament 6-7 cm. long and 2 mm. thick.

New Mesozoon.||—Olaw Schröder describes *Buddenbrockia plumatellæ* g. et sp. n. found by von Buddenbrock in colonies of *Plumatella repens*. The stage found in the body-cavity of *Plumatella* was worm-like: the largest were 1.5 mm. in length by 0.08-0.1 mm. in breadth. There are two layers of cells and a lumen. In older stages the inner layer changes greatly and gives rise to an oogonial layer, producing ova. These seem to develop parthenogenetically into oval embryos. The author indicates the resemblances between this parasite and Orthonectids and Dicyemids, but thinks that it must in the meantime remain unattached. It is the first "Mesozoon" from a fresh-water animal.

Echinoderma.

Echinoderms of Peru.¶—H. L. Clark reports on a collection from Peruvian coasts. There are no Crinoids known from the region. There are only seven Holothurians and ten Ophiuroids. The Echinoids are represented by a dozen species, and the starfishes by twice that number.

It is interesting to note that the Peruvian marine fauna is made up of two quite different elements, that from the Panamic region and that

* Arch. Zool. Expér., v. (1910) Notes et Revue, No. 6, pp. clix-viii (3 figs.).

† Proc. R. Soc. Victoria, xxiii. (1910) pp. 1-7 (1 pl.).

‡ Tom. cit., pp. 39-41 (3 pls.).

§ Tom. cit., pp. 42-3 (1 pl.).

|| Zeitschr. wiss. Zool., xvi. (1910) pp. 525-37 (2 pls. and 4 figs.).

¶ Bull. Mus. Comp. Zool. Harvard, lii. (1910) pp. 321-58 (14 pls.).

from the Chilean. The latter furnishes all of the Echinoderms found south of Aguja Point, 6° S. lat., while the Panamic fauna is practically confined to the shores north of that point. In spite of its low latitude, the coast of Peru south of Aguja Point is far from tropical, and the marine life is distinctly that of temperate seas, owing to the great Humboldt or Peruvian current, which brings the cold waters of the Antarctic region down nearly to the Equator.

Seasonal Retrogression of Ovaries in Starfish.*—Ch. Pérez has observed the autumnal retrogression of ovaries in *Asteracanthion rubens*. The large ova show degenerative changes in the cytoplasm and in the nucleus. Small cells accumulate in the cavity, and many of these, laden with minute granules, appear to be dispersed by the perigenital lacunæ. No very active phagocytosis was observed, but some of the inclusions of the small cells indicate that this process is going on.

Species of Cucumaria.†—C. L. Edwards corrects the statement that *Cucumaria frondosa* (Gunner) occurs off the north Pacific coast of North America. There are, however, four closely allied species—in the same "species-cycle"—viz. *C. californica* Semper, *C. japonica* Semper, *C. fallax* Ludwig, and *C. miniata* Brandt.

☐Cœlentera.

Deep-sea Hydroids of Indian Museum.‡—James Ritchie reports on a collection which indicates for the first time the aspect of the Hydroid fauna of the deeper Indian Ocean waters. A Sertularian (*Idia pristis*) and an epizoic Campanularian (*Campanularia corrugata*) share the honour of having been dredged at the greatest depth, 1343 fathoms, and it is noteworthy that both have been previously recognized in shallow water. This range recalls that of *Sertularella tricuspidata*, which occurs from almost the shore to 1375 fathoms.

The collection increases the recognized Hydroid fauna of Indian seas by eleven species, and that of Malaysia by two. Four species are new. The deep-sea Indian Hydroid fauna seems to agree more markedly with that of the South Pacific than with that of any other region.

The author proposes to re-introduce the Hincksian names "sarcotheca" and "sarcostyle" to differentiate the chitinous protection of the "nematophore" from its fleshy content. He describes in *Aglaophenia septata* Ritchie a peculiar and distinctive gonosome—a modified type of corbula, in which the protective leaflets, which are arranged in two tiers, bristle outwards from the body of the gonosome, while the gonangia are covered in and protected by delicate plates of chitin.

New Genus of Hydroids.§—Hjalmar Broch establishes a new genus *Bonneviella* for *Lafosa gigantea* Bonnevie (= *Campanularis grandis* Allman). Indeed, a new family is proposed, because of the remarkable "veloid," which forms a pre-oral cavity. The hydrotheca is bell-shaped,

* P. V. Soc. Sci. Bordeaux, 1909, p. 19.

† Zool. Jahrb., xxix. (1910) pp. 597-612 (1 pl.).

‡ Records Indian Museum, v. (1910) pp. 1-20 (1 pl.).

§ Nyt Magazin Naturvid. Kristiania, xlvi. (1909) pp. 195-205 (6 figs.).

with a thin diaphragm. Broch also re-establishes Allman's genus *Lictorella*: Lafoëidae with more or less bell-like hydrothecae, which have a strongly developed diaphragm: the hydrocaulus is upright, and regularly branched; nematophores are absent; the gonangia are aggregated in a scape. There is one species, *Lictorella pinnata* (G. O. Sars), from deep water in the North Sea and the Bay of Biscay.

Feeding Reactions of the Rose-coral.*—F. W. Carpenter has investigated the reactions which follow the stimulation of the rose-coral polyp of the genus *Isophyllia* by means of nutrient substances. When concentrated meat extract is applied to the oral disk of the polyp, the disk is drawn downwards by the contraction of the retractor muscles of the mesenteries, and the margin of the oral surface is folded inward over the disk by the action of a well-developed sphincter muscle. Meanwhile the stomodæum is everted, and the mesenterial filaments are extruded both through the mouth and through temporary apertures in the oral disk. The tentacles react quickly to contact stimulation, and affix the object which touches them to their distal ends, which are heavily loaded with nematocysts. When the end of a tentacle is chemically stimulated with meat extract, the retractor muscles of the polyp contract. Carmine grains dropped on the oral surface of an expanded polyp are transferred by ciliary action to the periphery. When the particles of carmine have previously been soaked in meat juice, the cilia usually continue to beat in an outward direction; occasionally, however, they reverse their effective strokes. The chief function of the cilia seems to be that of keeping the oral surface clean. When a polyp is fed with plankton, the small organisms are caught by the tentacles, the oral disk sinks and the marginal zone folds inward until it completely roofs over the tentacles and the depressed oral disk. Into the superficial chamber thus formed, the stomodæum and mesenterial filaments project, and here the mesenterial filaments, which are the digestive organs of the polyp, probably digest and ingest or absorb the captured plankton, little of which seems to find its way into the reduced gastrocœliac cavity. Extra-cœlenteric digestion apparently takes place, therefore, in the rose-coral polyps. There is experimental evidence of the transmission of impulses of at least a nervoid character from ectodermal receptor cells through the mesogloea to endodermal effectors (muscles). This transmission is not confined to a single polyp, but may pass from one polyp to another. It is known that branching cells (so-called "connective-tissue" cells) occur in the mesogloea of *Isophyllia*. These extend from the ectoderm to the endoderm, and so have the topographical relations of adjustor cells, placing the receptor in communication with the effector. Notwithstanding absence of exact information as to the origin, mutual relationships, and functions of these cells, it is suggested that future studies may show them to be the primitive synaptic neurones.

Kodioides.†—Chas. L. Walton describes *Kodioides borlyi* sp. n. from 20 fathoms close to the Dutch coast. The previously known species of

* Proc. Amer. Acad., xlv. (1910) pp. 149-62 (1 pl.).

† Journ. Marine Biol. Assoc., ix. (1910) pp. 85-7.

this remarkable Actinian genus (*K. pedunculata* Dan.) was obtained from 1050 fathoms between the Farøe Islands and Norway. In the new species the mesenteries and tentacles are numerous; in *K. pedunculata* there were twelve pairs of mesenteries and twenty-four tentacles. The modified generic diagnosis of *Kodioides* reads:—The body encrusted, pyriform, with a long bare stem, terminating in a pedal disk. Tentacles few or many, in two or more series, retractile, twelve or more pairs of mesenteries, half of their number perfect. Suckers on the encrusted portion of the body. No siphonoglyph. Mesodermal annular muscles. Acontia.

Evolution of *Zaphrentis delanouei*.*—R. G. Carruthers has traced a succession of stages in the evolution of this coral in Lower Carboniferous times. The series illustrates very gradual change (mutation in Waagen's sense).

West Australian Alcyonarians.†—W. Kükenthal reports on a rich collection mostly from the littoral region of Shark's Bay. He reduces twenty-eight species of *Sarcophytum* to five. Seven new species of *Nephthya*, one of *Dendronephthya*, two of *Stereonephthya*, are described. A new Siphonogorgiid genus, *Nephthyigorgia*, is established; it has some affinities with *Stereonephthya*, and has probably its centre of origin in West Australia; four new species are described. The generic diagnosis is as follows:—"Very stiff Siphonogoiids with abundant branching in one plane; stem, branches, and lateral twigs thick and cylindrical; spicules on the branches, mostly confined to the cortex and frequently projecting from the surface; the crowded polyps, absent only from the lowest part of the stem, are retractile into distinctly protruding calices and arranged in transverse rows." Kükenthal adds two new species to Thomson's remarkable genus *Stuleriotes*, which he refers to the family Fasciculariidae. There is also a description of a new *Clathruria* and various species of *Plexaurioides*, *Euplexaura*, and *Mopsella*.

Genus *Anthomastus*.‡—W. Kükenthal proposes some modifications in the definition of this genus. The colony is like a mushroom or an inverted cone; the autozooids are large in comparison with the siphonozooids; only the latter have gonads; the autozooids are completely retractile into calices, which usually show distinct longitudinal ribs; the spicules are slender rods and spindles, and the lower cortex of the stem always shows numerous very minute crosses, double-crosses, or the like. Most of the species are abyssal. Twelve species are discussed, three of which are new. Several species, such as *A. agaricoides* Thomson and Henderson, and *A. aberrans* Thomson and Henderson, are transferred (rightly) from the allied genus *Sarcophytum*.

Rhizoxenia and Sarcodictyon.§—Robert Müller brings forward arguments which go to show that the genus *Sarcodictyon* must be included in *Rhizoxenia*, which is thus defined: Colony formed by basal stolons, which may coalesce into plates; polyps occur singly or in small groups on the

* Quart. Journ. Geol. Soc., lxxvi. (1910) pp. 523-8 (2 pls.).

† Fauna Südwest-Australiens, iii. (1910) lief. 1, pp. 1-108 (4 pls. and 52 figs.).

‡ Beitr. Natur. Ostasiens, in Abh. K. B. Akad. Wiss. München (1910) pp. 1-16 (1 pl. and 10 figs.).

§ MT. Zool. Stat. Neapel, xx. (1910) pp. 94-100.

stolons; they are quite retractile: the tentacles are turned inwards in the retraction: there is no horny cuticle in the basal part of the polyp. Müller recognizes *R. rosea* and *R. catenata*.

Formation of Axis of Corallium.*—Robert Müller finds that *Corallium* possesses an axial epithelium of ectodermic origin which agrees with that of the Gorgonids. The axial skeleton is formed by the excretion of crystalline calcareous bodies, whereby a cementing of the mesodermic spicules is brought about. The union of the latter with the axial skeleton is due to divergence of the adjacent cells of the axial epithelium, which afterwards come together again.

Plexaurids of 'Siboga' Expedition.†—C. C. Nutting reports on the Plexaurids collected (1899–1900) by the 'Siboga' in the Dutch East Indies. Five new species of *Plexaura* and three of *Euplexaura* are described. A Ceylonese form, *Plexaura antipathes* var. *flexuosa* Thomson and Henderson, is included (May 1910) in a new species, *P. aggregata*, but in February 1910 Thomson and Russell raised it to specific rank as *Euplexaura flexuosa*. This will require to be looked into. A new genus, *Hicksonella*, is established and thus defined:—"Plexauridæ with a thick cœnenchyma, calices included and on all sides of the branches, horny axis cylinder, and two very different types of spicules—very small, short warty spicules, and long slender bar-like smooth spindles." The name of Simpson's new genus, *Hicksonella*, more recently established for a Gorgonellid type, will have to be changed.

Isidæ of 'Siboga' Expedition.‡—C. C. Nutting describes *Isis reticulata* sp. n. which goes beside *I. hippuris*, hitherto the only representative of the genus. It differs from *I. hippuris* "in manner of branching, reticulation, slenderness of twigs, colour, and most of all in the character of the spicules." The author describes a new species of *Ceratoisis*, two of *Acanella*, two of *Mopsea*, and two of a new genus, *Peltastisis*, which "bridges the narrow gulf between the Isidæ and Primnoidæ, in that it combines the jointed axis of the former and the characteristic operculum of the latter, which it also resembles closely in its spiculation."

Gorgonidæ of 'Siboga' Expedition.§—C. C. Nutting describes *Lophogorgia pinnata* sp. n., *Leptogorgia formosa* sp. n., *Stenogorgia miniata* (Val.), *S. studeri* sp. n. and *Platycaulus sibogæ* sp. n.

Gorgonellids of 'Siboga' Expedition.||—C. C. Nutting describes two new species of *Gorgonella*, one of *Verrucella*, one of *Juncella*, one of *Scirpearella*, two of *Nicella*, and erects two new genera, *Plumigorgia* and *Isidooides*. He has not had the advantage of utilizing J. J. Simpson's recent revision of the Juncellids, and thus retains a genus like *Ctenocella*, which seems bound to be merged with some other. The genus *Scirpearia* is ruled out, since *Scirpearia* was originally used for a Pennatulid. The new genus *Plumigorgia* has symmetrically arranged, delicate, pinnate,

* M.T. Zool. Stat. Neapel, xx, (1910) pp 101–7 (4 figs.)

† Monographie xliiib. 'Siboga' Expedition, 1910, pp. 1–20 (4 pls.).

‡ Tom. cit., pp. 1–24 (6 pls.).

§ Op. cit., No. 7, 10 pp. (3 pls.).

|| Op. cit., No. 6, pp. 1–39 (11 pls.).

ultimate branches, minute calices, and minute oval lenticular and disk-shaped spicules embedded in a translucent horn-like cœnenchyma. The new genus *Isidoïdes* has a solid calcareous axis, club-shaped calices; large bar-like spicules, and an operculum of eight pieces.

Porifera.

Regeneration in *Chondrosia reniformis*.*—O. Maas cut up this sponge and put the pieces in an aquarium. When the piece consisted of cortex and medulla, or of medulla alone, it grew in a week or so into an almost normal sponge. Pieces of cortex by themselves always died. Pieces of medulla and cortex, or medulla only, formed a fresh cortex. The choanocytes and archæocytes coalesce in syncytia, and are re-grouped. The canals disappear in part and are re-formed. The regenerative capacity of *Chondrosia* is, on the whole, slight, and Maas connects this with the fact that this sponge is not, in natural conditions, very liable to injury.

Archæocyathinæ.†—T. Griffith Taylor deals with the Archæocyathinæ of the Cambrian of South Australia, and gives an account of the structure and affinities of the whole class. Five families are recognized, Archæocyathidæ, Coscinocyathidæ, Dictyocyathidæ, Spirocyathidæ, and Syringonemidæ, and their inter-relations are discussed. The author rejects the view that the Archæocyathinæ were algæ, and is not inclined to place them near Anthozoa. He gives his reasons for placing them in a new class nearer to the calcareous sponges than to any other. The variation in shape and structure of a series of eighty species—dealt with in his memoir—affords more trustworthy evidence than the microscopic character of the skeletal elements which must have been considerably modified in post-Cambrian periods. Practically all the form-variations can be paralleled by the sponges and by the sponges alone. It is suggested that in the Archæocyathinæ we have evidence of the modifications of the "generalized type," which gave rise to the Calcareia and Anthozoa.

Protozoa.

† **Foraminifera from Funafuti.**‡—Frederick Chapman reports on 231 species and varieties of Foraminifera from around Funafuti. He describes *Lagena juddiana* sp. n., and two new varieties of *Biloculina lucernula* and *Cassidulina bradli*. Two fossil species, *Lagena ventricosa* and *Virgulina pertusa* are noted as recent for the first time. In relation to the influence of light on the coloration of organisms in the ocean depths, it is interesting to note the occurrence of deeply coloured (rose-pink) tests of *Polytrema miniaceum* at a depth of 507 fathoms. A special interest of the collection attaches to the large number of abyssal forms occurring at depths from 2000 to 2728 fathoms, or from $2\frac{1}{4}$ to over 3 miles.

* Arch. Entwickl., xxx. (1910) pp. 356-78 (4 figs.). See also Zool. Zentralbl., xvii. (1910) pp. 560-1.

† Mem. Roy. Soc. South Australia, ii. (1910) pt. 2, pp. 55-188 (16 pls.).

‡ Journ. Linn. Soc. (Zool.) xxx. (1910) pp. 388-444 (4 pls.).

Peridinium Plankton at Rovigno.*—Hjalmar Broch has studied the species of *Peridinium* from the Val di Bora at Rovigno. Apart from *P. tristylum* Stein and *P. adriaticum* sp. n. (whose geographical range is not known), the species are cosmopolitan or sub-tropical. There are two distinct maxima in the year—a spring maximum, shorter in duration, but quantitatively richer, and an autumn maximum, more prolonged, though less rich. Characteristic of the spring maximum are *P. conicum*, *P. oceanicum* f. *drupinensis*, and *P. crassipes* f. *typica*; while *P. quirnerense* and *P. crassipes* f. *dutuminalis* are characteristic of the autumnal maximum.

Parasitic Dinoflagellate.†—E. Chatton describes *Syndinium turbo* g. et sp. n. in the body-cavity of *Paracalanus parvus*, a pelagic Copepod. The organism traverses the epithelium of the gut, and develops in plasmodial form, like one of the enplasmodial Mycetozoa, in the general cavity of its host. They fill the host with legions of macrospores and microspores. The transformations of the macrospores suggest that *Oxyrrhis* has close affinities with Dinoflagellates.

Blood Parasites.‡—J. A. Gilruth, G. Sweet, and S. Dodd describe *Proteosoma biziuræ* sp. n. from the musk duck (*Biziura lobata*), and *Hæmogregarina megalocystis* sp. n. from a python.

Protozoan Parasite from Mucous Membrane of Sheep's Abomasum.§ J. A. Gilruth describes a minute oval cyst, with a delicate wall and groups of sporozoites. It may be the schizogonic stage in the evolution of some parasitic sporozoon—perhaps of a *Sarcosporidium*. It seems that the same parasite has been found by Mesnil and Chatton in Paris.

Hæmogregarine in Blood of Varanus varius.||—J. A. Gilruth has some notes on an intra-corpuseular Hæmogregarine in this lizard. Some free ovoid and curved bodies were also found.

Protist Parasites from Intestine of Trichoptera.¶—Doris L. Mackinnon has found in the alimentary canal of caddis-fly larvæ certain well-known Gregarines, and several Protist parasites which have not hitherto been described. Chief among these are (a) *Trichomastix trichopteræ* sp. n.; (b) a Spirochæte; and (c) a Flagellate which appears to be related to *Macrostoma caulleryi* Alexieff.

Herpetomonads from Dung-flies.**—Doris L. Mackinnon notes that *Musca domestica*, and other non-biting flies frequenting similar feeding grounds, are probably all liable to infection with a common Flagellate of variable form. Infection is casual, i.e. by the mouth. In the case of the dung-flies examined, the larvæ ingest faecal matter infested with Herpetomonad cysts: the cysts develop into Flagellates in the mid-gut, where they multiply with great rapidity: towards the close of larval life, when the larva stops feeding, they round up in the hind-gut, and

* Arch. Protistenk., xx. (1910) pp. 176–200 (11 figs. and 1 chart).

† Comptes Rendus, cli. (1910) pp. 654–6.

‡ Proc. R. Soc. Victoria, xxiii. (1910) pp. 231–41 (3 pls.).

§ Tom. cit., pp. 19–20 (1 pl.). ¶ Tom. cit., pp. 36–8 (1 pl.).

¶ Parasitology, iii. (1910) pp. 245–54 (1 pl.).

** Tom. cit., pp. 255–74 (1 pl. and 4 figs.).

are, for the most part, passed out as cysts. A few survive the pupal stage in a half-encysted condition, but it is probable that the infection of the adult fly is usually freshly acquired. The cycle in the fly is similar to that in the larvæ, and is in agreement with Patton's account of *Herpetomonas muscæ domestica*.

The apparent double flagellum is produced in the course of longitudinal division. The new flagellum grows up alongside the old, and is not merely split off from it.

In encystment the flagellum is not cast off bodily, but is drawn down into the cell by the kinto-nucleus, which moves to a position either alongside of, or posterior to the tropho-nucleus. In this way apparent Crithidia, or even Trypanosome forms, are produced, but there is no hint of an undulating membrane.

Cristispira and Spirochæta.*—J. Gross describes a peculiar parasite, *Cristispira pectinis* g. et sp. n., from the stomach and intestine of *Pecten jacobæus*. Along with *Spiroinema* Vuillemin this new genus must be referred to Bacteria—to a new family Spirohemacea. The resemblance of *Spirochæta* to *Cristispira* and *Spiroinema* is not more than superficial. The Spirohemacea are described as elongated, spiral, or undulating Bacteria, with a cylindrical body consisting of a row of compartments. In *Cristispira* there is a quite unique "crista," which has been called an undulating membrane. Multiplication is by simple constriction, or by the formation of a partition wall, usually preceded by a process of incurvation. Along with *C. pectinis* there is another—*C. interrogationis* sp. n.

Development of Trypanosoma lewisi in Rat Flea.†—C. Strickland and N. H. Swellengrebel infected fleas (*Ceratophyllus fasciatus*) from the rat and studied the development of the Trypanosome. They found "large oval forms," "round forms," "little ovals," intermediate Crithidiæ, and small Trypanosomes. The broad fact remains established that *T. lewisi* undergoes a morphological cycle of development in the gut of its invertebrate host.

New Microsporidian from Termite.‡—Ch. Pérez found in the body-cavity of a Termite a Microsporidian which he names *Dubosequia legeri* g. et sp. n. The parasite has a peripheral vegetative zone of budding nuclei, but the elements which are detached towards the interior, instead of forming by division a variable number of naked spores, retain their individuality, increase in size, and are transformed into pansporoblasts, each containing sixteen spores.

* *MT. Zool. Stat. Neapel*, xx. (1910) pp. 41-93 (1 pl.).

† *Proc. Cambridge Phil. Soc.*, xv. (1910) pp. 531-3.

‡ *P.V. Soc. Sci. Bordeaux*, 1909, pp. 17-19.

BOTANY.

GENERAL,

Including the Anatomy and Physiology of Seed Plants.

Structure and Development.

Vegetative.

Clusiaceæ of North-west Madagascar; the Influence of the Soil upon their Secretory Apparatus.*—H. Jacob de Cordeuroy publishes a detailed account of his investigation of this subject, and arrives at some very definite and interesting results. The number and dimensions of the secretory organs, he finds, are variable, and the variations are the direct result of the character of the soil. These organs are, generally speaking, extensively developed in plants growing on primitive rock soils (gneiss, basalt, crystalline schists), and relatively poorly developed, for the same species, where the soil is the product of sedimentary rocks, especially sandy and calcareous soils. This distinction is strikingly illustrated in the case of *Ochrocarpus angustifolius*.

The secretory apparatus consists of canals, in the following regions: cortex, pith, primary bast, and secondary bast. Two main types emerge, according as the apparatus is the more conspicuous in the primary tissue-systems (*Garcinia verrucosa*, *Tsimatimia Perrillei*), or in the secondary tissue, the secretory system in the primary tissues being relatively reduced (*Tsimatimia pedicellata*, *Symphonia* sp.). In *Ochrocarpus* the secretory organs are evenly distributed among primary and secondary tissues. The canals in the cortex seem to be present invariably, whether the soil be of igneous or sedimentary origin; the pith canals, on the other hand, often disappear in the latter case (*Rhœdia*, *Symphonia*, *Tsimatimia*); while secretory canals tend to be suppressed from the primary phloem of *Ochrocarpus* when grown on sedimentary soils—a significant fact when it is remembered that their presence in this tissue is a recognized anatomical character of this genus. Dryness of the soil, moreover, has its effect upon the secretory system. The medullary system is reduced, or disappears as a consequence; and when the soil is sedimentary, secretory organs do not tend to appear in the bast, by way of compensation, as they do in the case of igneous soils (*Tsimatimia pedicellata*, *Symphonia*). Altitude, again, seems to induce diminution in the activity of resinous secretion (*Symphonia elusioides*, *Ochrocarpus eugenioides*).

The author draws the obvious and important conclusion that, in view of this variability, extreme caution must be used in the employment of the extent and disposition of the secretory system for the purposes of classification in this group.

* Ann. Sci. Nat. Bot. xi. (1910), pp. 287-359.

Physiology.

Nutrition and Growth.

Occurrence of Phagocytosis in the Root-nodules of Cycads.*

Franz Zach publishes his investigation of the nodules which occur on the so-called "breathing-roots" of Cycads (compare the same author's previous study of *Elæagnus*), in their association with peculiar brown excretion bodies. It is well known that special layers of the cortex in *Cycas* are organized for the accommodation of the blue-green alga *Anabæna*. These layers form a completely closed cylinder, interrupted only at the growing-point. Within this zone an endophytic fungus may be observed in the cells of the nodules, with its hyphæ (5μ in thickness) regularly distributed in the protoplasm. The hyphæ in some cells branch profusely, and these become coiled together. The fungus-coils so formed are absorbed by an excretion-product; the details of this digestion-process are described. As the coils are organized, the cell-protoplasm becomes divided, in a manner analogous to phagocytosis in animals. During the digestion-process the nucleus shows signs of degeneration, assuming at the same time a long spindle shape; in a few cases it was observed to divide by simple fragmentation. After some time, often as soon as the coil is formed, protoplasm and nucleus are disorganized. The author is of opinion that nodule-formation is not due to the fungus; nor is this a case of symbiosis, but of parasitism. The fungus, it seems, infects tissues which are abnormally developed at the expense of metabolism products; and the cell reacts upon the fungus by a process of phagocytosis.

Effect of Injury to the Cotyledons upon Seedling development.†

Helene Jacobi concludes from experiments with seedlings of *Phaseolus multiflorus*, *Cucurbita Pepo*, and certain Conifers, that this effect is produced by the consequent disturbance of the food-reserves. Diminution in the cotyledonary food-stores during the earliest periods of vegetative development evokes acceleration in growth; but the effect upon the individual organs varies according to the species on the one hand and the environment on the other. The experiments were conducted in light as well as in darkness, and both water- and pot-cultures were employed. In *Phaseolus multiflorus*, the bulk of the food-reserve is stored in the cotyledons; in this case their injury resulted in relative lengthening of the stem, both in light and in darkness. In *Cucurbita Pepo* and Conifers the seed-leaves are not so rich in food-reserves; and in this case the cotyledons displayed activity in growth when cultivated in daylight, the increase in the stem being relatively feeble. The Conifer seedlings grown in the dark, however, had abnormally developed stems. The author concludes that while the seedling is dependent upon its food reserves, it devotes its energies to stem development; growth-increase in the cotyledons occurs only in light of a particular intensity. Emphasis is laid on the fact that the accelerated growth of the cotyledons is due to the decrease in food-reserve, and not to the stimulus of wounding; and this is borne out by the case of an abnormal pine-

* Oesterr. Bot. Zeitschr. lx. (1910) No. 2, pp. 49-55. See also Bot. Zeit., lxviii. (1910) p. 148.

† Flora, n.s. i. (1910) pp. 279-289.

seedling, possessing very few cotyledons; these were much larger than those of normal seedlings.

General.

Edward Perceval Wright.*—H. H. Dixon writes a note on the late E. Perceval Wright, Professor of Botany at Trinity College, Dublin, for thirty-five years, and Keeper of the Herbarium. He was born in 1834 in Dublin, was educated at home, and began life as a clerk in a commercial company at the age of sixteen. This post, however, he resigned in 1853, and devoted himself to Natural Science, entering Trinity College. In 1857 he took his degree, and was appointed Director of the Museum in Trinity College. In 1858 he was appointed Lecturer in Zoology in Trinity College, and Lecturer in Botany in Steeven's Hospital Medical School. In 1862 he took his M.D. degree, and in a few years he had made himself a position as oculist in Dublin. In 1865 he was, however, appointed *locum tenens* for Harvey at Trinity College, and the following year he gave up his ophthalmic work. His various voyages and travels gave him material for the publication of numerous reports and papers, which were a valuable addition to botanical literature.

Cryptogams.

Pteridophyta.

(By A. GEPP, M.A., F.L.S.)

Studies in Fossil Ferns.†—D. H. Scott, in the second edition of his *Fossil Botany*, adds much new matter, especially in connexion with the Pteridospermæ and Bennettiteæ. Two chapters are devoted to giving a connected account of the Pteridospermæ and the so-called Cycadofilices. Another chapter treats of the Sphenopsida (including Equisetales, Psendoborniales, Sphenophyllales, Psilotales), the Lycopsida (Lycopodiales), and the Pteropsida (including Filicales, Pteridospermæ, Gymnospermæ, Angiospermæ).

Zygopterideæ.‡—T. Bertrand publishes a detailed account of the Zygopterideæ, treating of their anatomy as compared with that of the Anachoropterideæ and Botryopterideæ, which contain one genus each. He gives a systematic account of all the genera and species known in the group.

Stipes of the Fossil *Asterochlæna*.§—P. Bertrand gives an account of the general anatomical characters of the stipes of *Asterochlæna laxa* Stenzel, and lays special stress on the median bands of protoxylem. The affinities of the plant are *Clepsydroopsis* and *Ankyropteris*. Bertrand briefly indicates the principal forms of fibro-vascular bundle in the stipes of the Zygopterideæ.

* Irish Nat., xix. (1910) pp. 61-3 (1 pl.).

† Studies in Fossil Botany, ed. 2, ii. (1909) 321 pp. (85 figs.).

‡ Étude sur la Fronde des Zygoptéridées: Lille, 1909, 289 pp. (37 figs.), and Atlas (16 pls.).

§ Comptes Rendus, cli. (1910) pp. 1088-90.

Lepidostrobus Bertrandi.*—M. Zaleski, writing on the fossil plants of the Carboniferous of the Donetz basin, gives a description of the anatomical structure of *Lepidostrobus Bertrandi*, a new species resembling *L. Oldhamius*, but differing in its larger size, longer-stalked sporangial bracts, etc. It occurred in a limestone block with *Stigmuria Sphenophyllum*, etc., at a locality not precisely known.

Lepidophloios Scottii.†—W. T. Gordon gives an account of the structure of *Lepidophloios Scottii*, a new species from the calciferous sandstone series at Pettycur (Fife). It has halonial tubercles, and has the characteristic leaf-bases of *Lepidophloios*, but its central strand has not the structure of *L. Harcourtii*, which is usually regarded as typical of *Lepidophloios*. It agrees much more with *Lepidodendron vasculare* and *L. Hickii*, which are typical species of *Lepidodendron*. The vascular bundles which run out to the halonial tubercles have the customary solid central wood. The leaf-trace is collateral, the xylem mesarch. Below it lies a parichnos-bundle which only forks close up to the leaf-scar. The ligular pit has certain peculiarities.

Calamites compared with Equisetum.‡—A. R. Horwood gives an account of the fossil *Calamites Schützei* Stur., found near Leicester. It has a hollow stem and a regular succession of uniformly increasing internodes, with a marked recurrence of a short internode—a feature which is common also, with some modifications, in modern *Equisetum*. These points he discusses in detail, and illustrates with five tables and two plates.

Anatomy of New Zealand Lycopodiaceæ.§—J. E. Holloway has made a comparative study of the anatomy of six New Zealand species of *Lycopodium*, viz. *L. volubile*, *L. scariosum*, *L. densum*, *L. laterale*, *L. cernuum*, *L. Billardieri*. A description is given of the early stages in the development of the young plants, and of the development of the stelar anatomy of the mature plant; and also of the development of dimorphism in the leaf-arrangement of *L. volubile* and *L. scariosum*. The prothallus, protocorm, foot, first root, protophylls, young stem and leaves, etc., are discussed. As regards their stelar structure, the six species may be classified as follows. 1. Mixed (*L. cernuum*, *L. laterale*). 2. Banded—(a) radial (*L. Billardieri*); (b) parallel (*L. volubile*, *L. scariosum*, *L. densum*). The relation between the "radial" and the "parallel" types is discussed, as also is the difference between the "mixed" and "banded" types.

Fossil Lycopodium.||—E. W. Berry gives an account of *Lycopodium cretaceum*, a previously undescribed species from the Upper Cretaceous sands near Middendorf, in South Carolina, corresponding with the Turonian of Europe. The fragments found consist of some seventeen fruiting spikes, of various sizes, the largest being 5 cm. long by 5 mm.

* Mém. Com. géol. n. s. livr. 46, St. Pétersbourg, 1908, 33 pp. (9 pls.).

† Trans. Roy. Soc. Edin., xlvi. (1908) pp. 443-453 (3 pls.).

‡ Journ. Linn. Soc. (Bot.) xxxix. (1910) pp. 277-289 (2 pls.).

§ Trans. Proc. New Zealand Inst., xlii. (1910) pp. 356-370 (4 pls. and 2 figs.).

|| Amer. Journ. Sci., xxx. (1910) pp. 275-6 (figs.).

wide. The bracts are truncate at base and ovate-acuminate above, and entire. The sporangia apparently spring from the surface of the bract and appear to be spheroidal, but are probably reniform. The vegetative organs are absent.

British Fern-varieties.*—C. T. Drury publishes a book on British ferns and their varieties, illustrated with 40 coloured plates, 96 nature prints, and 319 woodcuts. Few as are the species of indigenous British ferns, their forms are infinite even in the wild state. They have indeed been estimated at nearly 2000 by some authors. The present work is intended to be a complete compendium of all recorded forms for the use of the practical amateur rather than for the systematic botanist. The successive chapters treat of British ferns as a hobby; life-history of ferns; fern propagation and culture; fern selection; hybridizing; multiple parentage; rockeries, etc.; wild "sports" and how found; types of variation; fern foes and remedies; and then the species, varieties, etc., are treated in alphabetical order, with brief descriptions. The long series of nature prints is selected from a collection of some 300 prepared by the late A. M. Jones of Clifton.

New Hybrid Asplenium.†—R. de Litardière describes a new hybrid fern. \times *Asplenium Pugesii* = *A. foresiacum* \times *Trichomanes*, gathered at St. Laurent-des-Nières, in the department of Hérault by E. Pagès. It approaches *A. Trichomanes* in its brown stipes and its oval-obtuse leaf-segments; and *A. foresiacum* in its hairy thick rachis and in the division and form of the teeth of its leaf-segments. It also approaches the hybrid \times *A. dolosum* Milde (*A. Adiantum-nigrum* \times *Trichomanes*). The writer gives new French localities for two other hybrids, \times *A. Murbeckii* Dörfler (*A. Ruta-muraria* \times *septentrionale*) and \times *A. Gautieri* Christ (*A. fontanum* \times *viride*).

Mexican Ferns.‡—H. Christ publishes descriptions of five new ferns collected by G. Arsène near Morelia, in the province of Michoacan, in the middle of the high plateau of Mexico, and also near Puebla. The new species are *Polypodium (Goniophlebium) pachyrhizon*, *Notholaena Arsenii*, *Pellaea Arsenii*, *Dryopteris tremula* and *D. patula* var. *Moreliae*.

Ferns of South Mexico.§—J. N. Rovirosa has prepared an account of the fern-flora of the south of Mexico, which is published after his death at the expense of J. D. Casasús. It consists of a classification and description (in Spanish) of the ferns of that region, and—what is the most striking feature of the work—a series of seventy beautifully drawn quarto plates, in which the plant-habit, the venation, the sorus, sporangia, scales, etc., are shown. Six new species and one variety are described.

* British Ferns and their Varieties. London: Routledge (1910) 8vo. 459 pp. (40 coloured plates, 96 nature prints, 319 woodcuts).

† Bull. Acad. Intern. Géogr. Bot., xix. (1910) pp. 204-5.

‡ Notulæ Systematicæ Mus. Paris, i. (1910) pp. 231-5.

§ Pteridographia del sur de Mexico. Mexico: Escalante (1910) 298 pp. (70 pls.).

Ferns of Borneo.*—H. Winkler gives an account of the flora and plant-geography of south-east Borneo, and includes a list of ninety-eight ferns determined by Lauterbach, and seven species of *Selaginella* determined by Hieronymus, four of which are new and described at great length.

Ferns of the Kermadec Islands.†—R. B. Oliver includes in his account of the vegetation of the Kermadec Islands a list of the ferns. These are thirty-three in number, together with five Lycopodiaceæ. Among the most interesting are *Cyathea Milnei* Hook and *C. kermadecensis*, a new species which has hitherto been confounded with *C. Milnei*, but has a much taller (60–70 ft.) and more slender stem, from which the dead fronds fall off completely, leaving a clean scar. With very few exceptions the species occur in New Zealand and elsewhere. The ferns are mostly found in the wet forests. The author gives some ecologic notes about them. Owing to the introduction of goats the indigenous plants are now very rare.

Bryophyta.

(By A. GEPP.)

Inter-relationships of the Hepaticæ.‡—F. Cavers, continuing his account of the inter-relationships of the Bryophyta, discusses the group of the acrogynous Jungermanniales. He first passes under review the chief morphological characters of the group, with special reference to the wealth of parallel developments, which is one of its most striking features. Thus he discusses the various types of leaves and perianths, the development of the marsupial sac and of the sporogonium, as found in different genera. He offers a scheme of classification in which he raises Schiffner's eight sub-families to the status of families and briefly defines them. From a study of the inter-relationships of the Acrogynæ, he finds evidence that they form a monophyletic group; and he thinks that the following are relatively primitive gametophytic characters:—Leaves symmetrically bilobed, and either flat or slightly folded; the presence of underleaves; archegonia borne on the main axis; perianth free from involucre, and either cylindrical or trigonous from the fusion of three flat bracts; protonema filamentous. Also he finds on the other hand that the following may be regarded as advanced or specialized characters—the complete absence of lobing from the leaf, or, on the contrary, its division into several deep lobes, or its division into two lobes of very unequal size; the absence of underleaves; the restriction of the archegonia to special short branches; the fusion of perianth with involucre; lateral or dorsiventral flattening of the perianth, and the development of wings on its exterior; discoid protonema; and, finally, various elaborations such as the formation of pitchers, paraphylls, marsupia, etc. Many of these specialized characters have arisen independently in different lines of affinity, and are to be classed as parallel developments. In the phylogenetic scheme figured on page 299, the

* Engler's Bot. Jahrb. xliv. (1910) pp. 497–571.

† Trans. Proc. New Zealand Inst., xlii. (1910) pp. 118–175.

‡ New Phytologist, ix. (1910) pp. 269–301 (figs.).

Acrogynæ are shown as allied to *Fossombromia* through *Lophozia*, from which can be traced three main lines:—(1) Direct through *Sphenolobus* to the Scapaniaceæ and on to Radulaceæ, Porellaceæ and Lejeuneaceæ, the Pleuroziaceæ being a lateral offshoot. (2) A second line leads through *Plagiochila*, *Lophocolea*, etc., to Cephaloziaceæ, and through *Lepidozia* to Ptilidiaceæ. (3) A third line leads through *Marsupella* to *Southbya* and other marsupial genera. A bibliography of eighty-five items is appended to the paper.

Parallelism and Convergence of Moss-pedigrees.*—T. Herzog discusses parallelism and convergence in the pedigrees of the mosses. There are three main groups—Sphagnales, Andreaeales, Bryales—which have nothing whatever to do with one another. The Bryales include the vast majority of the mosses, and they contain a number of parallel and distinct lines of development, the apical members of which show an apparent systematic unity. Some of these lines or families, for example, the Orthotrichaceæ, Bryaceæ, Bartramiaceæ, Polytrichaceæ, etc., are evidently distinct from one another. But two of the larger groups are so alike in their systematic characters as to appear almost of the same descent: the first group includes the families Dicranaceæ and Leucobryaceæ, and the second includes the Hypnaceæ, now divided up into several families. He then proceeds to describe the lines of development of these two groups and their points of convergence and similarity.

Bryological Notes.†—V. Schiffner continues his notes on bryological subjects. (62) *Frullania explicata* Mont. is identical with *F. apiculata* Dnm, according to Stephani; but in that case Montagne's description is at fault. Schiffner does not, however, consider that two species are mixed in the type material. The species is probably a variable one; and he describes a form from Samoa as *F. apiculata* var. *explicata*, to which he refers as a synonym *F. oceanica* Mitt. in Seemann's Flora Vitiensis. (63) *F. saxicola* and *F. cloistostoma*, the latter a European species, and the former from North America—these are very nearly allied to one another, but probably are distinct, and the more so because of their widely separated habitats. (64) *Riccia glaucescens*, its synonyms and allies, are discussed at some length; and the views of various authors are criticized. It is identical with *R. Lescuriana*, but not with *R. Micheliï*. The presence or absence of marginal cilia is not a character of specific value. (65) *Leskea laxiramea* is recorded from North Persia.

Andreaeaceæ.‡—G. Roth begins a series of descriptions of extra-European mosses, announcing that Vol. I. will contain the Andreaeaceæ, Archidiaceæ, Cleistocarpæ, and Trematodontæ. The first part, now issued, is given up almost entirely to *Andreaea*, 102 species of which are described. Every species is figured; and a key to the species is provided.

Protolindsaya and other Bornean Ferns.§—E. B. Copeland publishes some additions to the Bornean fern flora, namely, twelve species

* Hedwigia, l. (1910) pp. 86-99.

† Oesterr. Bot. Zeitschr. lx., (1910) pp. 431-6.

‡ Die aussereuropäischen Laubmoose, Dresden: Heinrich, 1910, Band I. pp. 1-96 (8 pls.).

§ Philippine Journ. of Sci., Bot., v. (1910) pp. 283-5.

collected by C. J. Brooks and others. Among them are four new species, three new varieties, and a new genus—*Protolindsaya*, a little fern allied to *Saccoloma moluccanum* and *Lindsaya cultrata*.

Ferns of the Philippine Islands.*—E. D. Merrill and M. L. Merritt in their account of the flora of Mount Pulog, in the Philippine island of Luzon, include a list of eighty-one ferns and six fern-allies determined by E. B. Copeland. A description is given of the ascent, of the flora of the several zones, and of the relationships with the floras of other regions.

Distribution of *Molendoa Sendtneriana* in Hungary.†—I. Györfly treats of the distribution of the moss, *Molendoa Sendtneriana*, in Hungary. Hitherto it was recorded from the Hohe Tatra only. But Györfly now announces its occurrence in the lower Tatra mountains down to 1660 ft. above sea-level. Previously it had not been found lower than 3000 ft.

Dicranoloma.‡—J. Hagen refers again to the faulty construction of the name *Dicranoloma*, and cites a general rule that the second part of such a name constitutes the principal member, while the first part serves only to qualify it. Thus to coin the name in such a way as to give it the meaning "Dicranum with bordered leaves," it would be necessary to make it *Lomato-dicranum*.

Annulus of *Cynodontium Alpestre*.§—J. Hagen describes the annulus of the sporogonium of *Cynodontium alpestre*, a structure which has hitherto escaped notice in that species, and which is of a nature unknown elsewhere in the moss kingdom. The annulus lies round the base of the peristome, and consists of a single series of nucleated, hyaline cells, with the outer wall not thickened. Further it is abnormal in that, without reaching the surface, it lies in a hollow furrow along the interior margin of the operculum, and is completely covered by its exterior margin.

Merceyopsis g. n. and other Indian Mosses.||—H. N. Dixon gives an account of *Merceyopsis*, a new genus of mosses with seven Indo-Malayan species ranging from the north-west Himalaya to Java and the Philippines. It is closely allied to *Merceya*, but differs in having a hyophiloid areolation, and in the median (not ventral) deuter-cells of its leaf-nerve section. From *Hyophila* it is distinguished by the absence of a central strand in the stem, and by the elliptic (not cylindrical) capsule with lax thin-celled exothecium. A key to the species is given. In the same paper is a list of some twenty-four Indian mosses collected in the Western Ghats and in the Almora district. Among these are six new species with descriptions and figures. *Pterobryum kaurarensis*, previously described, proves to be identical with *P. Walkeri* Broth.

Ephemerum and Nanomitrium in North America.¶—G. E. Nichols publishes some field notes on *Ephemerum* and *Nanomitrium*, which.

* Philippine Journ. of Sci., Bot., v. (1910) pp. 315-24.

† Magyar Bot. Lapok, ix. (1910) pp. 194-8.

‡ Rev. Bryolog., xxxvii. (1910) pp. 132-3.

§ Tom. cit., pp. 133-4.

|| Journ. of Bot., xlviii. (1910) pp. 297-310 (2 pls.).

¶ Bryologist, xiii. (1910) pp. 121-3.

though rare in herbaria, are not so in distribution. The plants of both genera are very minute, but in some species are rendered conspicuous by their persistent green protonema. They are annual plants, producing fruit during the winter months. Their habitats are as follows: cultivated soil, paths, roadsides, river banks, dried-up ponds, sides of ditches, etc. They do not occur in woods, but in more or less sunny situations, and are often associated with species of *Riccia*. Their geographical distribution needs investigation.

Norfolk Bryophytes.*—W. H. Burrell publishes a supplementary list of Norfolk mosses and hepatics with a view to establishing eventually a complete record of the distribution of the species throughout the county. In the meantime it is shown clearly what species occur in East and West Norfolk respectively. Ninety-nine mosses and sixteen hepatics are enumerated.

New and Rare European Mosses.†—G. Roth gives an account of some new or little known European mosses, with figures of their structure, namely, *Distichophyllum carinatum* Dixon and Nicholson, and six species of *Drepanocladus* and two of *Calliergon*. The *Distichophyllum* is remarkable as being a genus new to Europe, and a species with antarctic affinities. It was discovered near Salzburg; and the family Hookeriaceæ to which it belongs is represented by very few genera in Europe.

Moss-flora of South Thuringia.‡—B. Krahnmer gives an account of the moss-flora of the environs of Arnstadt and southern Thuringia, with introductory notes on the work of previous collectors, on the physical geography of the region, and on ecology. The enumeration includes 263 mosses and fifty-two hepatics.

J. Röhl § criticises the above paper, and indicates the points in which he differs from Krahnmer, mostly points of minor importance.

Moss-flora of Eisenach ||—P. Janzen gives an account of the hepatics of the environs of Eisenach, with an enumeration of sixty-eight species. One of the most active collectors was Rudert, who found ninety-three mosses and forty-one hepatics in one gorge.

New Records of Hamburg Mosses.¶—J. Schmidt gives some new results arising from an investigation of the flora of Hamburg, comprising notes on thirty-one mosses, their distribution and peculiarities.

New England Hepaticæ.**—A. W. Evans publishes an eighth series of notes on the hepaticæ of New England. He gives a description of *Riccia sarocarpu* Bisch, and discusses its history and synonymy, and the question whether *R. minima* of Linnæus can be retained for *R. nigrella* or for *R. sarocarpu*. He also redescribes *Ricciella membranacea*, moving

* Trans. Norfolk and Norwich Nat. Soc., ix. (1910) pp. 99-106.

† Hedwigia, l. (1910) pp. 105-114 (1 pl. and fig.).

‡ Mitteil. Thuring. Bot. Ver., xxv. (1910) pp. 2-28.

§ Op. cit., xxvii. (1910) pp. 17-21.

|| Op. cit., xxv. (1910) pp. 35-40.

¶ Allgem. Bot. Zeitschr., xvi. (1910) pp. 172-5.

** Rhodora, xii. (1910) pp. 193-204.

the species out of *Riccia*; it is allied to *Ricciella crystallina*. He gives critical remarks on four rare species of *Lophozia*, on *Pedinophyllum interruptum*. *Pedinophyllum*, being more closely related to *Mylia* and to *Chiloscyphus* than to *Plagiochila*, should be kept separate from the latter genus. Finally Evans treats of *Fruillania inflata* and of *F. saricola* Austin. The latter is a good species; but how far it may be conspecific with the European *F. cleistostoma* of Schiffner and Wöllny, he is not prepared to say until he has examined specimens of the latter.

North American Bryophyta.*—O. E. Jennings gives a brief description of the great Pymatuning Swamp in north-west Pennsylvania, and of its main plant-associations. He was surprised to find one small area covered with *Polytrichum strictum* Banks, a northern alpine never before recorded from so far south nor from so low an elevation.

A. Lorenz † publishes some brief notes of her collecting experiences during a European trip, principally in Germany and Switzerland, and compares the moss-floras of the localities visited with those of similar spots in the United States.

E. J. Hill ‡ gives an account of the collection of mosses made by J. Röhl in the United States and Canada in 1888-9, and of the late C. R. Barnes's contribution to the determination of the species.

W. W. Calkins § gives a list of fifty-one mosses collected in Cook County, Illinois, and all found growing within a radius of ten to twenty-two miles from Chicago.

Mexican Mosses.||—J. Cardot publishes his seventh article on Mexican mosses, and gives descriptions of seventeen new species, a few varieties and two new genera *Barnesia* and *Morinia*, both members of the tribe Trichostomæ. The former is named after the late C. R. Barnes of Chicago; and *Morinia* is named after Morin, author of a paper on the histology of leaf-nerve of the mosses. The specimens upon which the paper is based were collected by Pringle, by Barnes and Land, by Purpus, and others.

Moss-flora of Bolivia.¶—T. Herzog publishes some further contributions to the moss-flora of Bolivia, founded on two collections; one made by himself, and the other sent by O. Buchtien to J. Kaulfuss. Herzog's gathering contains twenty-one species, seven of which are new. Buchtien's contains twenty-five species, four of which are new. In all, some 700 species have been recorded for Bolivia.

Bryophyta of the Philippine Islands.**—E. D. Merrill and M. L. Merritt in their account of the flora of Mount Pulog, in the Philippine island of Luzon, include a list of twenty-three hepaticæ and thirty-four mosses determined by F. Stephani and V. F. Brotherus respectively. A description of the ascent is given, and the flora of the various zones is discussed and compared with that of other regions.

* Bryologist, xiii. (1910) p. 100.

† Tom. cit., pp. 100-3.

‡ Tom. cit., pp. 105-7.

§ Tom. cit., pp. 107-11.

|| Rev. Bryolog., xxxvii. (1910) pp. 117-28.

¶ Beih. Bot. Centralbl., xxvii., Abt. ii. (1910) pp. 348-58.

** Philippine Journ. of Sci., Bot., v. (1910) pp. 311-15.

New Zealand Bryophytes.*—L. Cockayne gives a list of the mosses and hepatics collected by him and by J. W. Murdoch in Stewart Island, New Zealand, during October 1908. Stewart Island is extremely rich in Bryophytes and Lichens, and the list represents but a tithe of the flora. It contains thirty-five hepatics determined by F. Stephani, and thirty-four mosses determined by V. F. Brotherus.

Adalbert Geheeb.†—J. Röhl writes some sympathetic reminiscences of Adalbert Geheeb (b. 1842; d. 1909), an apothecary at Geisa, in the department (Kreis) of Eisenach, and a bryologist of the highest rank. He is well known by his prolonged bryological investigations in the Rhöngebirge, and by his illustrations of the mosses of New Guinea, etc. J. Röhl enjoyed a close personal friendship with Geheeb for forty years, travelled and collected with him, and exchanged specimens and ideas with him. He has much to say of Geheeb's happy and simple domestic life, and tells of his devotion to music, of his beautiful genial nature, his generosity and unselfishness, and his eagerness to help all around him and especially apothecaries and bryologists. He had friends and correspondents in all lands, and he never made an enemy. In 1897 he moved from Geisa to Freiburg in Breisgau. His herbarium was purchased by a friend and presented to the Berlin Botanical Museum.

Thallophyta.

Algæ.

(By MRS. E. S. GEPP.)

Chara contraria and **C. dissoluta.**‡—C. P. Sluiter writes an exhaustive account of these two species, which have been sometimes united and have always been somewhat puzzling. The author first gives a history of all the views held by former authors on the systematic position of these plants, and then sets herself to answer the following questions: 1. What are the relations between *Chara dissoluta* A. Br. and *C. contraria* A. Br.? 2. Is an uncorticated *Chara* from Busskirch (submitted to the author for examination) a member of the *contraria* group, is it identical with *C. dissoluta*, or is it more nearly related to other uncorticated species? In order to answer these questions the author made a careful and minute study of the external and internal morphology of the two species in question from excellent material, and she gives details of her results, illustrated by text-figures. The same study was made of the Busskirch plant, and the results finally discussed. The similarity between *C. contraria* and *C. dissoluta* f. *helvetica* is so great that the author apparently regards the latter as being a degenerate form of the former, and the Busskirch plant as belonging to the same series of forms. She finds that the uncorticated form of *C. dissoluta* f. *helvetica* is quite independent of the form with one row of corticating cells; but what causes this form she is unable to say, and declines to enter into any

* Trans. Proc. New Zealand Inst., xlii. (1910) pp. 320-4.

† Mitteil. Thüring. Bot. Ver., xxvii. (1910), pp. 1-13.

‡ Bot. Zeit. lxxviii. (1910) pp. 125-68 (5 tables and figs. in text)

discussion regarding the position of the various forms, varieties, and species. Critical remarks are made with regard to other allied species of *Chara*.

Chara stelligera.*—A. Bennett records the finding of *Chara stelligera* in good fruit near the bridge between Flegg Burgh and Filby. He also records seven other localities in Norfolk, and others in Hants, Surrey, and South Devon.

Algæ from the Laboratory at Roscoff.†—P. A. Dangeard records the finding of *Prasinorhynchus lubricus* Kueckuek and *Euglenopsis subsalsa* Davis in the tubs of the aquarium at the laboratory at Roscoff. The former has only been recorded from Heligoland and the latter from Cambridge, Mass. Both species have been incompletely known, and the present paper completes our knowledge of them as well as rectifying certain errors with regard to them. Both genera have been placed in the Tetrasporæ, together with *Ecballocystis* and *Collinsiella*. Their affinities, in the opinion of the author, are, however, with *Chlamydomonas* and *Carteria*, the differences in the reproductive cells being due to a localization in the secretion of the gelatine. If this view be adopted, the family Chlorodendraceæ proposed by Oltmanns in 1904 would take its place, like the Chlamydomonadineæ, at the bottom of the Algæ, near the Flagellates. At Roscoff, the two species form a moss-like growth on the glass walls of the vessels, and are much appreciated as food by some of the animals living therein.

Pleodorina illinoisensis Kofoid.‡—F. Merton gives an account of the structure and reproduction of *Pleodorina illinoisensis* Kofoid, a North American species which has been found in the neighbourhood of Heidelberg and in the Pfalz. It is an instance of the oft-repeated assertion that most Protista, being cosmopolitan, are not of value in distribution-studies. The material was properly fixed and various histological details were made out; for instance, the movement of the nucleus to the periphery of the cell and its karyokinesis. Centrosomes were not observed. Conjugation of microgametes and macrogametes occurs; the resulting zygotes secrete a firm wall and become zygospores.

Raphidonema.§—A. Scherffel describes a new species of *Raphidonema*, *R. brevirostre*, found in dirty snow in the Hohe Tatra, at a height of 1700 metres. The snow contained also *Chionaster nivalis* and the aplanospores of *Pteromonas nivalis* Chod. The characters of the new species are: length of filaments 52–56 μ , breadth 4 μ , not so long drawn out as in *R. nivale* Lag.; in every cell a yellow-green chromatophore; reproduction normally by division of the filament in the middle into two halves. Young germinating swarm-spores were observed. In the interior of the cell are fat-drops but no pyrenoid. *Raphidium nivale* Chod. is a typically one-celled organism; *Raphidonema nivale* Lag. is typically many-celled. The latter plant has chromatophores, and is consequently no fungus. "Red snow" has never been observed in the Hohe Tatra.

* Trans. Norfolk and Norwich Nat. Soc., ix. (1910) pp. 49, 50.

† Comptes Rendus, cli. (1910) pp. 765–7.

‡ Zeitschr. wiss. Zool., xc. (1908) pp. 445–77.

§ Botan. közlemények, ix. (1910) pp. 116–23. See also Hedwigia, l. (1910) p. (101).

New Genus of Polyblepharidæ.* P. A. Dangeard describes a new genus of Algae, represented by one species, *Stephanoptera Fabreæ*, found in a culture in the laboratory at Concarneau. It belongs to Polyblepharidæ, which hitherto has contained only two genera. A description is given of the alga, and of its method of division. As a rule the two individuals resulting from a division are of equal size, but sometimes the inequality is so great as to give the impression of budding; this is an extremely rare phenomenon in Flagellates or Algae. At the time of division each half retains one of the old flagella, and the second is pushed out like a protoplasmic prolongation by the side of the first. Development is terminated by an encystment; the cell rounds itself into a sphere and becomes surrounded by a very resistant membrane. The cysts enclose a single nucleus as a rule, though some have two. The new genus is distinguished from the two others of the family by the reduction of the number of flagella to two. It shows a remarkable adaptation to a medium saturated with sea-salt, while the other species are fresh-water. Bipartition begins at the anterior part of the cell, while in *Polyblepharis* and *Pyramimonas* it begins at the posterior part. As regards the binucleate cysts, the author suggests that they may present phenomena of sexual autophagy similar to those that he has recently described in the *Monas* forms of *Anthophysa vegetans*.

Phytoplankton of the Caspian Sea.†—A. Henckel gives a preliminary list of phytoplankton from the Caspian Sea, in which he enumerates 20 species. He collected 120 samples from different parts of the Sea, and proposes to publish a full account of the collection later, with plates. The present note is in Russian.

Thorosphæra.‡—C. H. Ostenfeld describes a new genus of Coccolithophoridae which he names *Thorosphæra*, discovered by him between 600 metres and the surface of the sea, south of Cape Spartivento. He describes and figures the organism, which he places near *Syrosphæra*. It is characterized by a remarkable formation of coccoliths, which act as a floating apparatus.

Plankton-algæ.§—E. Lemmermann continues his contributions to the study of plankton algae. No. 26 is an account of the phytoplankton of Paraguay, founded on material collected by Herzog at Medanos. It contained almost pure phytoplankton: Peridineæ were absent and Flagellates were very scarce. The author treats the subject from all points of view. No. 27 describes plankton-algæ from the Schliersee, collected by Zacharias. No. 28 on *Dinobryon sociale* Ehrenb. No. 29 contains a description of a new species, *Dinobryon inflatum*, from a small lake south of Bysjön in Sweden, and a new variety of *Cosmarium Novæ-Semliæ* Wille var. *suecicum*. No. 30 contains a description of *Peridinium trochoideum* formerly placed in *Glenodinium*.

* Comptes Rendus, cli. (1910) pp. 991-3.

† Script. Bot. Hort. Univ. Imp. St. Petersburg, xxvi. (1910) pp. 53-6.

‡ Ber. Deutsch. Bot. Gesell., xxviii. (1910) pp. 397-400 (figs.).

§ Archiv f. Hydrobiol. u. Planktonkunde, v. (1910) pp. 291-338. See also Hedwigia, l. (1910) pp. (100-1).

Ceratocornys.*—C. A. Kofoid publishes a revision of the genus *Ceratocornys* based on skeletal morphology. He places in the genus three other species which had previously been placed in other genera of the Dinoflagellates, describes a new species, gives a new description of the genus, as well as an analytical key and detailed diagnoses of the five species of the genus.

Metachromatic Bodies in certain Green Algæ and Conjugatæ.†—N. Woronichin describes his experiments on the behaviour of metachromatic bodies towards certain reagents, employing the methods used by Guilliermond for fungi. The Algæ which he experimented upon were *Stigeoclonium*, *Draparnallia*, *Tetraspora*, *Vaucheria*, *Spirogyra*, *Zygnema*, *Closterium*, etc. The methods of work are described, and the results of the use of different reagents. It is seen that the metachromatic bodies in both Algæ and Fungi behave in a similar manner towards a number of reagents. On the other hand there is an inconstancy towards the few important reagents in the behaviour of both Algæ and Fungi. This fact confirms the views of Meyer, Nadson and Brüllowa as to the nature of the metachromatic bodies. These bodies are to be regarded as a group of substances, which are different from one another, though very nearly related. In this they are analogous to sugar, fats, and other chemical formations which form combinations peculiar to themselves.

Algæ of the Upper Pruth.‡—J. Woloszynska gives a short account of the algæ living in the upper waters of the river Pruth. She divides the algæ of all running water into three groups: 1. Those which by some means manage to find a hold, be it by haptera or by growing on the lower side of stones. 2. Free-living species which flourish under the protection of the first group. 3. The species which inhabit the mud. Of this last group the most frequent algæ of the Pruth are diatoms and desmids. The author mentions four principal algæ-associations. The first occurs in the water-falls, where *Lemanea* and *Cladophora glomerata* flourish, as well as *Chantransia amethystea* and *C. violacea*, growing epiphytically on *Lemanea*. *Eidogonium* and *Phormidium* also occur. The second association is represented by the felt-like growth on stones, found most richly developed in mid-stream. The third is formed by the algæ which creep about in the mud. These three associations are found in the main stream. The fourth is found in the shallow backwaters which are cut off from the main stream, and forms a connecting link between the algæ of the river and those of the neighbouring swamps. Other lesser associations were found which are dependent on climatic conditions. The factors which govern a formation are to be sought in the constant change of the level and temperature of the water; on these depends the life of all species living in the river, and it is just this variability which is the unchanging law governing the flora of a mountain stream.

* Univ. of California Publications, Zool., vi. (1910) pp. 177-87. See also Hedwigia, 1. (1910) pp. (99-100).

† Script. Bot. Hort. Univ. Imp. St. Petersburg, xxvi. (1908-9) pp. 71-83.

‡ Bull. Internat. Acad. Sci. Cracovie, 5B (1910) pp. 346-50.

Algological Notes.*—N. Wille publishes a continuation of his notes, founded on the results of his studies at Tatihou and Cherbourg in July and August 1909. He records the finding of *Pseudonocardium submarinum* Wille on the wood of the quay at St. Vaast-la-Hougue, and describes certain points in its growth and anatomy. He found it subsequently at Tatihou: it has hitherto only been recorded from northern seas. *Ulothrix pseudoflaccra*, described by the author from Dröbak in Norway, was found by him on *Fucus spiralis* at Cherbourg. It has hitherto been considered an arctic species. A doubling of the filament is described here, occurring as a freak. A new species of *Streptococcus*, *S. Malaridii*, was found on the quay wall at St. Vaast-la-Hougue, and is described and figured. The author next deals with a very interesting endozootic Chlorophyceæ which grows in the sponge *Halichondria punicæa* Johnston. It was found not only among the exterior parts of the sponge, but also in the interior, and consists of long unbranched filaments which are sometimes straight, sometimes intertwined. After a full description of the alga, the author states his views on its systematic position. He is inclined to think that it is not a new genus as might be supposed, but merely a very much changed form of *Rhizoclonium Kernerii* Stockm. He discusses the points for and against such an assumption, a point which can only be settled by further study of fresh material. The next note describes a sample of plankton from St. Vaast-la-Hougue, taken with a view to testing whether marine plankton is always poor in the summer months, as has been supposed. The sea was found to contain large quantities of sand-grains, and the plankton was purely a coast-plankton. The small number of species is, in the author's opinion, probably accounted for by the large quantity of sand-grains which, in sinking to the bottom of the sea, carry with them the light floating plankton. In the final note, a new species, *Coccomyxa Corbierei*, is described. It was found growing in a glass-house in Emmanuel Liass Park, Cherbourg, forming a green covering to some woodwork. The points of distinction between this species and the others of the genus are given.

Studies on the Conjugatæ.†—R. Chodat writes on the copulation of *Spirogyra quadrata* var. *mirabilis*, which takes place in two ways, called respectively "xenogamic" (conjugation of distinct filaments), and "pedogamic" (conjugation of contiguous cells of the same filament). In the former mode (described as "copulation scalariforme") the filaments are differentiated into male and female; and Chodat gives a detailed account with figures. In "pedogamic" two contiguous cells of one filament unite after perforation of the septum that divides them.

Diatoms.‡—A. Forti continues his studies on Diatoms, publishing three contributions to the series. The first (No 9) deals with *Ceratulus polymorphus* and *C. orbicularis* sp. n., with their systematic revision; and discusses the true nature of *C. thermalis* Ralfs. The varieties and forms of each species are carefully described, together with

* *Nyt. Mag. Naturvidensk.*, xlviii. (1910) pp. 281-306 (2 pls.).

† *Bull. Soc. Bot. Genève*, sér. 2, ii. (1910) pp. 158-67 (figs.).

‡ *Atti R. Ist. Veneto Sci. Lett. Art.* lxix. (1910) pp. 1249-1317 (9 pls.).

a list of synonymy, references to literature, and critical remarks. The next contribution (No. 10) treats of quaternary and subfossil Diatomacea collected in fresh-water in Ethiopia by Négri. The more ancient material was found in the hills of Soddo, and the more recent came from the terrace of Lake Zuay. Both collections are discussed critically, and a list of 106 species is given.

The third contribution contains lists of 94 and 167 species respectively, contained in the Tertiary deposits of Bergonzano, Reggio d'Emilia, and of Marmorito, Alessandria. Many of the species are common to both lists, and indeed two species, *Isthmia Squinaboli* and *Cocconeis Lanzii*, have never been recorded from any other deposits. The paleontological affinity between the collections is clearly established.

Diatoms from Dahomey.*—F. Hustedt records 100 species of diatoms in samples of mud from Porto-Novo (French Dahomey), divided among 28 genera. The Naviculae are the most numerous both in number of species and of individuals. A remarkable phenomenon is the occurrence of marine and of mountain forms. The author suggests that the marine species are brought by birds.

Swiss Desmids.†—L. Viret gives a list of Desmids from the valley of Salanfe in canton Valais, Switzerland. They were collected on the edge of a lake and in some neighbouring peat-moss, at a height of 2000 metres. Forty-seven species were observed, of which eleven are new. They represent eight genera. Descriptions are appended to many of the records.

Caulerpa.‡—A. Weber van Bosse writes on some species of *Caulerpa* from the island of Tahiti, and also describes a new species of the genus collected by Hedley on Kangaroo Island, South Australia. Among the Tahiti specimens is a new species, *C. Seuratii*, which is closely allied to *C. Brownii* var. *selaginoides*. The author explains her reasons for not following the grouping of Reinke in associating the Bryoideae, Lycopodioidae, and Araucarioideae under one group. She separates the two former, but considers it possible that the two latter may belong to the same section.

Laminaria hyperborea.§—B. Peressleginn gives an account (unfortunately in Russian, but with a short German abstract), of the anatomy of the stipes of *Laminaria hyperborea*. The material was collected by Foslie in Finnmark and given to the author for examination. The stipes possesses a many-celled assimilative tissue, consisting of cells which are rich in phaeoplasts. Further the author records tufts of hairs arising from the external assimilative tissue, as well as the ordinary "fasergrübchen." As regards the various theories put forward by authors as to the function of these fasergrübchen, Peressleginn holds to that of Wille and Reinke, namely, that the hairs serve as imbibition-tissue, thus fulfilling the role of the root-hairs of higher plants. The

* Archiv Hydrobiol. u. Planktonkunde, v. (1910) pp. 365-82 (1 pl.). See also Hedwigia, l. (1910) p. (39).

† Bull. Soc. Bot. Genève, sér. 2, ii. (1910) pp. 184-93 (1 pl.).

‡ Ann. Instit. Océanograph., ii. (1910) 8 pp. (2 pls.).

§ Script. Bot. Hort. Univ. Imp. St. Petersburg, xxvi. (1903-9) pp. 99-112 (1 pl.).

author finds that the air-chambers, which occur frequently in the assimilative tissue, are clothed with an epithelial sheath and arise schizogonously. He believes that they form respiratory chambers for the plant, such as has been proved by Henckel for *Chordaria*. The storing tissue consists of large parenchymatous cells, and has sometimes intercellular spaces. Here may be seen the macropores of Wille. The author cannot attribute to this tissue any mechanical role, which is confined to the mechanical and assimilative tissues. Finally he discusses the genesis of the inner tissue, the "connective and sieve hyphæ," which together represent the conductive tissue. These cells are of similar origin, and in the author's opinion represent all stages of mutual transition. Sometimes their membranes are thickened, and then they are able to form a mechanical tissue, which considerably strengthens the stipes against stress. The membrane was found to consist of two layers, which when stained with CZnI showed an outer pectin layer, and an inner cellulose layer.

Hybrid form of Fucus.*—M. Gard describes an interesting hybrid between *Fucus platycarpus* and *F. ceranoides*, which occurs at Mimizan and in the Landes. The two species were found growing along the bank of a stream which issues from the Aureilhan water. *F. platycarpus* is found up to about 80 metres above high watermark, and *F. ceranoides* to about 120 metres. The two species are, however, abundantly mixed, and in that region the hybrid is found. It resembles in dimensions and colour the frond of *F. ceranoides*, but the receptacles are very variable, not only in different plants but even in the same individual. Some are branched, pointed and flattened like those of *F. ceranoides*, some are thick and rounded like those of *F. platycarpus*. At first the author found only male conceptacles, but later in certain receptacles at the extreme basal limit, he found some conceptacles with abundant antheridia and a few rare oogonia. These latter were young or abnormal, and of small dimensions. None were seen which had reached maturity. On the other hand, the antheridia seemed quite normal. The hermaphroditism of the hybrid was a character transmitted from *F. platycarpus*, since all the specimens of *F. ceranoides* examined in the neighbourhood were unisexual. The same hybrid was also found by the author in one of the "courants" at Cap-Breton, Landes. It is not possible to determine at present the sexual-role of the parents.

New Genera from the Malay Archipelago.†—A. Weber van Bosse publishes preliminary diagnoses of new genera collected by herself in the Malay Archipelago, on the 'Siboga' Expedition. Full accounts and figures will be given in her complete paper on the marine algae of the region, which will appear later. The genera described in the present note are: *Bryobesia* belonging to Derbesiaceae, *Mesospora* belonging to Ralfsiaceae, *Erophyllum*, of which the cystocarps are still unknown, but which appears to belong to Rhodomeniaceae, *Acanthochondria*, *Aneuria*, and *Oligocladius* all belonging to the Rhodomelaceae, *Chalicostroma* to Ceramiaceae, and finally, a genus of uncertain position, *Perinema*.

* Comptes Rendus, cli. (1910) pp. 888-90.

† Ann. Jard. Bot. Buitenzorg, sér. 2, viii. (1910) pp. 25-33.

- LEMOINE, MME. PAUL.—**Répartition du Lithothamnion calcareum (Maerl) et de ses variétés dans la région de Concarneau.** (Distribution of *L. calcareum* and its varieties in the region of Concarneau).
 [A concise and interesting summary of the paper by the same author, published in the Ann. de l'Institut Océanographique, i, 1910.]
Bull. Mus. d'Hist. Nat. Paris (1909) No. 8, pp. 552-4.
- WILLE, N.—**Mikal Heggelund Foslie.**
 [A short biographical notice of the late M. H. Foslie, written in Norwegian.]
Naturen, Dec. 1909, pp. 353-6.
- EDWARDS, A. M.—**Desmidiæ came by Energenesis.**
 [An extraordinary composition, asserting that the author has seen spontaneous generation of desmids, the phenomenon occurring on April 1.]
Nuov. Notar. xxi. (1910) pp. 200-3.
- MAZZA, A.—**Saggio di Algologia Oceanica.** (Marine algology.)
 [A continuation.]
Nuov. Notar. xxi. (1910) pp. 169-99.
- HARDY, A. D.—**Association of Alga and Fungus in Salmon-disease.**
 [An account of a species of *Myxozoma* and a fungus growing associated on fish in fish-ponds at Kew, Melbourne. A list of algae is appended, which are either new for Victoria or are interesting in connexion with the fish question.]
Proc. Roy. Soc. Victoria, xxiii. (1910) pp. 27-32.
- BOYER, C. S.—**Jelly-pores in the Diatomaceæ.**
 [A short note on a discussion held by the author on the observations of other authors concerning these pores.]
Proc. Acad. Nat. Sci. Philadelphia, lxii. (1910) p. 271.

Fungi.

(BY A. LORRAIN SMITH, F.L.S.)

Cladochytrium cæspitis sp. n.*—Griffon and Maublanc noticed that some young seedlings of rye grass became yellow and died off. They found, in the decaying tissues, fine branching filaments which swelled at intervals to form round or irregular vesicles, so that the cells became filled with necklace-like structures. In time the vesicles became rounded off and isolated, the fine filaments disappearing; they then became encysted with a colourless or yellowish membrane of varying dimensions, on an average about 25μ in diameter; germination was not observed. In one instance zoosporangia were found, that had developed similarly to the cysts. They were filled with minute zoospores possessing one cilium.

Study of Synchytrium-galls.†—A. Ginttenberg examined these galls on *Mercurialis*, *Anemone*, and *Adonis*, and found that the host-cells had swollen enormously under the influence of the parasite. In these cells the nucleus had left its normal position on the cell-wall and was suspended on plasma threads in the centre of the cell. Near by lay the cell of the parasite, and from it a fine canal-system penetrated the cell-nucleus and abstracted nourishment for the parasite.

Study of Mucorini.‡—Boleslaw Namyslowski has isolated from soil and from dung a number of species of Mucorini, which he has cultivated

* Bull. Soc. Mycol., xxvi. (1910) pp. 317-21 (1 pl.)

† Jahrb. Wiss. Bot., xlvi. (1909) pp. 453-77 (2 pls.). See also Zeitschr. Bot., i. (1909) pp. 609-10.

‡ Bull. Acad. Sci. Cracovie, Math. Nat. Kl. No. 6B (1910) pp. 477-520 (1 pl. and 2 figs.)

and studied from the zygospore standpoint. He describes in detail the culture media, the temperature at which the experiments were made, and the development of the moulds. In several of them zygospores were formed, homothallic or heterothallic. In others he failed to secure any zygospore formation.

Study of *Mortierellæ*.*—J. Dauphin has written a monograph of the group, and reduces the species to twenty-seven. *M. polycephala* received special attention, and the formation of zygospores was followed in that species. The more air supplied the better for the growth of the fungus. Under zero and above 35° C. there is no growth; at 45° C. the spores are killed. Darkness retards growth, and there is no germination in a dry atmosphere. Experiments were also made with light and with x-rays, etc. Almost all of the species are figured.

Danish Phycomycetes.†—H. E. Petersen publishes a translation of a paper by him which originally appeared in the *Botaniska Tidsskrift*. It is divided into three parts. The first treats of the systematic position of the Phycomycetes; the second discusses the biology and ecology of the group; the third and last part contains a list with diagnoses of the species found by the writer, a number of genera and species being new to science.

The first part deals mainly with the Chytridineæ. Petersen looks on them not as Archimycetes but as reduced forms; he divides them into two groups: that of the *Synchytrium* where the zoospore on germination forms a sorus, and a second group where no sorus is formed, as in *Olpidium*, *Lagenidium*, and *Rhizidium*. These groups and genera with their inter-relationships are thoroughly discussed.

Submerged Phycomycetes occur as saprophytes on dead animals (fishes, frogs, etc.), or on dead parts of plants (branches, leaves and fruits of land plants), or they grow parasitically on fishes, frog's-eggs, etc.; a certain number grow on plankton-Crustaceans. The Chytridineæ are parasites on algæ, in the hyphæ of other Phycomycetes, in the eggs of *Rotatorizæ*, etc., and in eel-worms; there are also a few saprophytes, some of them growing in the pollen-grains of spruce and fir, which are blown into water in great quantities.

Full descriptions are given of the families, genera and species of the different groups, with many illustrations in the text; a complete bibliography is appended.

Development of *Monascus*.‡—W. Schikorra has examined two species of *Monascus*: *M. purpureus*, and a second form received from Lindner which he calls *Monascus v.* He describes the methods of examination employed by him, and reviews the work and results of previous students. Finally he sums up his conclusions as follows:—In both species of *Monascus* examined by him there is little morphological difference. The development of the peritheciium proceeds from a multinucleate ascogonium, which by means of the trichogyne is in open relationship with the multinucleate antheridium. The male nuclei pass over,

* Ann. Sci. Nat. sér. 9 (1908), pp. 1–112 (45 figs.). See also Zeitschr. Bot., i. (1909) p. 545.

† Ann. Mycol., viii. (1910) pp. 489–560 (27 figs.).

‡ Zeitschr. Bot. i. (1909) pp. 379–410 (1 pl.).

and each male nucleus finds place by a female nucleus; the fertilized ascogonium becomes surrounded by hyphae produced from the stalk-cell; two layers of hyphae are ultimately formed round the developing fruit. The ascogonium swells after fertilization, and produces ascogenous hyphae, which are binucleate; these increase by conjugate division. In the penultimate cell of the crooked ascogenous hypha the conjugate pair—a male and a female—fuse; the stalk and terminal cell of the “crook” are multinucleate. The fused nucleus is the primary ascus nucleus. By threefold division, eight spore-nuclei are formed; details of spore-formation could not be followed on account of the smallness of the nuclei. The mature asci are almost globose and contain eight multinucleate spores; the ascus membrane breaks down and all the spores become free within the perithecium. The whole nuclear history corresponds closely with that of *Pyronema confluens*. The genus *Mousses* belongs to the Ascomycetes and to the family Aspergillaceae.

Oak Mildew.*—P. Magnus publishes his views on this obscure epidemic. He does not consider that the fungus has been introduced from America, as American oaks in Europe are particularly free from the disease. He thinks it is probably a form of *Microsphaera Alni* which has passed to a new host and taken on great activity, but so far forming only *Oidium* on the oak.

Paul Vuillemin † finds that the oak mildew which threatened the existence of oak forests all over Europe has received a check. It has itself been invaded by a fungal parasite, *Cicinnobolus Cesatii*, well known as a parasite of Erysiphæe. The form and dimensions of the parasite correspond with the var. *Euonymi*, which was found on the *Oidium* of the Japanese *Euonymus*. Vuillemin is confident that the *Oidium* scourge will be largely if not completely checked by the *Cicinnobolus*.

Oidium of Japanese Euonymus.‡—M. E. Foex has followed the development of this fungus which persists on the leaves of the host-plant during the winter. During early winter there were only hyphae present; about the middle of January conidiophores were produced, but a spell of cold weather prevented further formation of conidia, and finally destroyed those already developed; with warmer weather, growth again began, and the fungus increased very rapidly. Foex noted certain thickenings in the mycelium which he examined biologically and chemically; he thinks they are probably connected with the winter-growth of the *Oidium*.

Fusarium nivale and Nectria graminicola.§—G. Ihssen has followed the development of these two forms of the same fungus. The cereal can be infected by *Fusarium* from the soil, but usually the seed itself contains the fungus, which can be easily detected in rye as hyphae with chlamydospores under the outer seed-coat. Sometimes it

* Vereinskchr. Ges. Luxemb. Naturfr., 1910, pp. 108–11. See also Bot. Centralbl., cxiv. (1910) p. 385.

† Comptes Rendus, cli. (1910) pp. 667–8.

‡ Bull. Soc. Mycol., xxvi. (1910) pp. 322–6 (1 pl.).

§ Centralbl. Bakt., xxvii. (1910) p. 18. See also Bot. Centralbl., cxiv. (1910) pp. 517–18.

kills the seed, or attacks the young seedling and kills the roots. In cases where the plant survives with the fungus still in the tissues, the hyphæ emerge through the stomata and form flat pustules, from which the perithecia are developed, identical with *Nectria graminicola*. *Fusarium nivale* is thus synonymous with *F. minimum* and *F. hibernans*. Seed-infection probably takes place at the time of flowering.

Study of Hyphomycetes.*—O. Appel and H. W. Wollenweber have had recourse to artificial cultures to aid them in understanding and determining species of *Fusarium*. They can thus find out the limitations of size and form of the spores, and the fruiting conditions of the species. They find that *Fusarium Solani* includes a number of forms. Other species in cultures developed perithecia of various genera. With special interest they record that *Fusarium Willkommii*, which causes canker on deciduous trees, developed in the cultures perithecia of *Nectria ditissima*. They recommend the same method for the further study of such genera as *Verticillium*, *Spicaria*, *Volutella*, *Periola*, *Ascochyta*, and others.

Coremium-formation in Penicillium.†—W. Wachter has taken *Penicillium glaucum* from various sources and cultivated it on a series of culture solutions varying in nutritive strength. He found that only some of the forms could be induced to make *Coremium*-growths (out of eleven, only nine were *Coremium* forms). He concludes that *P. glaucum* is a composite species, and that the tendency to *Coremium*-formation should be counted a diagnostic character. Tables are given to illustrate the experiments.

Metabolism of Moulds.‡—C. Ravenna and G. Pighini have been examining the toxic properties of *Aspergillus fumigatus* in connexion with the research as to the cause of Pellagra. Research workers in this field have had their attention specially directed to *Penicillium gluticum*, the most frequent parasite of maize, and it has been held that a toxic principle had been isolated from that mould. The authors were able to do the same for *Aspergillus fumigatus*, though the quantity secured was too small to determine its nature.

Influence of Iron on the Formation of Spores in Aspergillus Niger.§—G. Linossier publishes a note explanatory of the fact stated by Santon that *Aspergillus niger* would not form spores in a culture in which iron was absent. Linossier has examined the spore-pigment and finds that it contains iron; hence the reason of their non-formation is that iron is essential to them.

Uredineæ.||—J. C. Arthur has published a general survey of American Rose-rusts, species of *Phragmidium*. The geographical distribution is somewhat remarkable, most of the species occupying isolated areas. *P. speciosum*, however, occurs all over the United States.

* Ber. Deutsch. Bot. Gesell., xxviii. (1910) pp. 435-48 (1 pl.).

† Jahrb. Wiss. Bot., xlvi. (1910) pp. 521-48.

‡ Atti Reale Accad. Lincei, cccvii. (1910) pp. 312-16.

§ Comptes Rendus, cli. (1910) pp. 1075-6.

|| Torreyia, ix. (1910) pp. 21-8. See also Ann. Mycol., viii. (1910) p. 571.

The same author * has been stating his views on the classification and consequent nomenclature of rusts. The pycnidia and spermatia he looks on as conidial forms; the other spore forms are sexual and arise after cell-fusion.

Ed. Fischer † has conducted a series of experiments with the teliospores of a *Gyranosporangium*, which he collected on Juniper trees in the Jura. The *Roestelia* form grew on *Amelanchier* and not on *Sorbus*, so he found that he was really dealing with a different species, *G. Amelanchieris*, the *Aecidium* of which had been discovered by De Candolle on *Amelanchier*. Other interesting observations were made in the course of the culture experiment, and are fully described: a good bibliography is appended to the paper.

The same author ‡ has also published a review of Uredine experiments undertaken during 1908. Arthur in America, Müller, Boch and others in Europe, have helped to advance our knowledge of this branch of mycology. In the experiments, details of which are published by their authors, too much emphasis is placed, Fischer considers, on negative results, and he quotes with approval Magnin's statement in a preface to Hariot's "Uredineæ" that it may be purely ignorance of conditions that has caused the particular failure. Many of the experiments tend to split up species: others, such as Boch's on *Puccinia Gentianæ*, unite a great many forms under one. A full bibliography of papers cited is added.

In a paper § on the parasitic fungi of Liguria, P. Magnus publishes notes on a Uredine of *Euphorbia spinosa*. A form was found in Syria by Haussknecht, on *E. thamnoides*, and Magnus considered the Ligurian species to be the same. He now determines it as *Uromyces excavatus*, the typical form of which grows on *E. verrucosa*. The teliospores appear within the *Aecidium*-cup.

C. V. Tubenfl ¶ remarks on the rarity of finding Uredineæ on pine-needles. He explains this by the fact that infection as a rule takes place in leaves through the stomata, and as these are closed by wax in Coniferae, the germinating tube of aecidiospores fails to gain entrance.

Rusts of Cereals. ¶—F. Zach publishes the results of careful research on rusted plants, undertaken to examine the ultimate effects of the parasite on the host's cells, and incidentally to throw light on Eriksson's mycoplasma theory. He describes in detail the changes that occur in the plasma and nucleus after penetration of the cell by the haustoria of the fungus. He declares against the mycoplasma theory, and decides that the spread of the fungus is always due to new infection. The seeds of badly rusted cereals may produce a perfectly healthy and vigorous progeny.

* Proc. Ind. Acad. Sci., xxv. (1910) 8 pp. See also Ann. Mycol., viii. (1910) p. 572. † Zeitschr. Bot., i. (1909) pp. 683-714 (8 figs.).

‡ Tom. cit., pp. 284-7.

§ Mitteil. Thüring. Bot. Ver., xxvii. Heft. (1910) pp. 50-1. See also Bot. Centralbl., cxiv. (1910) p. 591.

¶ Naturw. Forst. Landw., viii. (1910) pp. 346-9. See also Bot. Centralbl., cxiv. (1910) p. 593.

¶ SB. Akad. Wiss. Math.-Nat. Kl., cxix. (1910) pp. 307-30 (2 pls.).

Smuts of Australia.*—These have been described by D. McAlpine in a companion volume to his "Uredineæ," published some years ago. He includes ten genera already established, but he finds thirteen new species. *Entyloma Meliloti* sp.n. is the first of that genus detected on a leguminous plant. The author describes the conditions that favour the growth of the fungi, the life-histories of the organisms, their vegetative and reproductive organs, etc. He also touches on the questions of parasitism and immunity, and gives special attention to the smuts of cereals.

German Cortinariii.†—F. Kaufmann has published a systematic account of the two subgenera *Phlegmacium* and *Inoloma*. He gives keys to the species, which take into account all the points that help in determination, especially the colours of the pileus and the gills. The author inclines to refer nomenclature back to Linnæus rather than to Fries. The selection of Fries's *Systema* as the starting point shuts out mycologists who have an undoubted right to be considered, and confuses the often interesting history of many species.

Monograph of Hygrophorus.‡—F. Bataille's account of this genus includes descriptions of eighty-two species. He retains Fries's subdivisions of the genus, and does not consider the number of spores on the basidium as a generic character. He provides a key to the species, using all characters easy to be recognized.

Notes on the Larger Fungi.§—René Maire published some time ago the result of his employment of reagents as aids to the determination of species in *Russula*. Potron has worked on the same lines, and publishes a short paper explaining his methods of using the reagents, and the success that attended their application. Usually he found that boiling a small portion of the pileus in water was sufficient to obtain a coloured fluid, which varied for the different species. He gives the colour-reactions for eight species of *Russula*.

C. Torrend|| records finding a variety of *Trametes ochroleuca* in Portugal, a fungus previously found only in the tropics. Torrend calls attention to the remarkable fact that several fungi supposed to be confined to the tropics have been found in Portugal.

Punctularia tuberculosa.¶—C. Torrend found this tropical member of the Thelephoreæ on an oak-tree in Portugal. It is of a beautiful violet-red colour, and spreads widely, though in Portugal it has not been observed to form spores. There was also found beside it a form of *Cerionomyces*, with many filaments and red-violet spores. Torrend finds the *Thelephora* to be identical with *Reticularia renulosa* B. & C. The

* Melbourne, 1910, 285 pp. (56 pls.). See also Ann. Mycol., viii. (1910) pp. 574-5.

† Ber. Westpreuss. Bot.-Zool. Ver., xxxii. (1910). See also Bot. Centralbl., cxiv. (1910) pp. 565-6.

‡ Extrait Mém. Soc. d'Emul. du Doubs, sér. 8, iv. (1909) 85 pp. See also Bot. Centralbl., cxiv. (1910) p. 459.

§ Bull. Soc. Mycol. France, xxvi. (1910) pp. 327-9.

|| Bull. Soc. Port. Sci. Nat., iv. (1910) pp. 35-7. ¶ Tom. cit., pp. 9-10.

formation of the *Ceratomyces*-form is due to humidity. He points out that *Ceratomyces* can no longer be considered as exclusively a form of Polyporeæ.

Cystidia of *Coprinus atramentarius*.*—A. H. R. Buller gives a résumé of what has been known as to the presence and function of cystidia in Hymenomycetes, and then takes up the *Coprini* with a special study of *Coprinus atramentarius*. The gills of that species are wide, thin and flexible, with massive cystidia that extend across the space from gill to gill. At maturity these disappear by auto-digestion, just before the ripening of the spores, though their prop-function is retained till the last moment necessary. The author has examined many species of the genus. In only three has he found cystidia absent (in *C. comatus*, *C. sterquilinus*, and *C. plicatilooides*), and in these he found that the swollen edges sufficed to keep the gills apart during spore-formation.

Mushroom Culture.†—M. Ponroy draws attention to the necessity of studying conditions of humidity in order to secure successful beds of mushrooms. If these were properly understood, he thinks the mushroom might be grown at any season, and that the quality and quantity would be greatly enhanced. Different degrees of humidity he finds are necessary according to the stage of growth, and if the state of the atmosphere in the caves where mushrooms are grown were properly considered and regulated, the result in increased crops would repay all the trouble taken.

Do the Higher Fungi require Lime? ‡—S. Hori was led to investigate this subject as he contrasted the development of higher and lower fungal forms with those of the higher and lower Algæ. It had been proved that oxalate of potash was poisonous for organisms that require lime; for those that do not require lime it was harmless. Hori grew an Agaric, a species of *Hypochyus* and various moulds in his research cultures, and he found that, in certain fungi, oxalate had a distinct influence on the growth, which seemed to prove the indispensability of lime. Further communications are promised.

Mycological Notes.§—F. v. Höhnel re-states the necessity of revising the old genera and species and of re-writing the diagnoses. For this purpose he has overhauled a great deal of material in the larger herbaria at Berlin, Kew, Paris, and Upsala. The present paper deals with about sixty diagnoses of these old plants. Höhnel has found it necessary to establish the following new genera:—*Clypeotella* (Microthyriaceæ); *Coccochorella* (Dothideaceæ); *Apiosporina* (near to Capnodiaceæ); *Sirothryella* (Pyknothyriaceæ); *Trichopelrella* similar to *Trichopeltis* but with 2-celled brown spores; *Parenglerula* to include *Meliola Macowaniana*, which differs from a true *Meliola* in the character of the perithecial membrane.

* Ann. Bot., xxiv. (1910) pp. 613-29 (1 pl.).

† Bull. Soc. Mycol. France, xxvi. (1910) pp. 298-306.

‡ Flora, n. s., i. (1910) pp. 447-8.

§ SB. Akad. Wiss. Math.-Nat. Kl., cxix. (1910) pp. 393-473.

Notes on the Larger Fungi.*—In Polyporoid Issue, No. 2, C. G. Lloyd discusses the genus *Flavolus*, *Hexagona*, and some noteworthy Polyporoids, with an account of the genus *Ptychogaster* (*Ceriumyces*); he states the generally received opinion that it is a modification or conical form of a Polypore, but he has seen nothing to justify the statement. In Issue No. 3, Lloyd describes other forms of *Polyporus* that have more recently come under his notice, such as the large species *P. Berkeleyi* and the minute *P. pocula*.

He has also sent out recently Notes No. 33,† with a portrait of Paul Hennings and a sketch of his life. There are also comments on a great number of plants. No. 34 with a photograph and a short account of G. Masee and notes on various Phalloids with criticisms of various published diagnoses of fungi. No. 35 presents a photograph and an account in French of G. Bresadolola, and gives a description of the Polypores in Persoon's herbarium. No. 36 has a photograph of the late W. A. Kellerman, with a short note of his work. The botanical congress at Brussels is discussed, and several important and rare fungus genera are described, such as *Lycogalopsis*, *Jansia* and *Cyclomyces*. The latter contains two species only, one from the East and one from America. Lloyd publishes also a plate and description of *Polyporus dryadeus*, the weeping Polypore. In Europe it grows on oak, but was found in America growing on elm.

Witches'-brooms on Firs.‡—These have generally been attributed to the damage caused by a Uredine fungus. C. V. Tubeuf has, however, demonstrated that they are not originated by a parasite. He has sown seeds collected from trees bearing the witches'-brooms, and the resulting trees again formed brooms.

Wintering of Plant-parasites.§—Among other parasitic plants C. S. Tubeuf studied the wintering of the fungus causing mildew of apples and the mallow fungus *Puccinia malvacearum*. The mildew was found to shelter in the buds; soon after opening the young leaves were covered with the spores already formed, which must have developed within the bud. As to *Puccinia malvacearum*, which grew on *Althea rosea*, the teliospores were found to be capable of germination after the melting of the snow. Other observations proved that the mycelium of the fungus persisted in the root-stock of *Althea rosea*.

Technical Mycology.—This important work of Franz Lafar has been before the public for some time, and Charles T. C. Salter has just completed the translation into English from the German original of the second volume. It deals generally with fermentation, and the fungoid organisms that take part in that process. The work therefore embraces a discussion of yeasts, their life-history and development, and

* Cincinnati, 1909-10, pp. 17-48 (many figs.).

† Tom. cit., pp. 425-92 (pls. and figs.).

‡ Naturw. Zeitschr. Forst.-Landw., viii. (1910) pp. 349-51. See also Ann. Mycol., viii. (1910) p. 579.

§ Naturw. Zeitschr. Forst.-Landw., viii. (1910) pp. 56-8. See also Ann. Mycol., viii. (1910) pp. 578-9.

|| London: Charles Griffin and Co. (1910) pp. ix. and 748 (text-figs.).

the various conditions of environment that help or hinder their growth and fermentative activity. Other fungi that have been found to take part in fermentation are also described, certain Ascomycetes and Hyphomycetes. The final section is devoted to an account of enzymes, enzyme activities of yeast and the chemistry of alcoholic fermentation. A full bibliography adds immensely to the value of the book.

Fungicides.*—A paper has been issued under the auspices of Cornell University describing the various methods of applying sprays, etc., to diseases in plants, many of these being due to insects. The section dealing with fungoid diseases is written by H. H. Whetzel. In the introduction the grower is recommended to spray for fungous diseases before rains, not after; as the spores germinate during rain, the plants must be protected before the wet season begins. Further, we are told that, "timeliness and thoroughness are more important factors in the control of diseases than are the particular mixtures of poisons used." In the course of the work these mixtures and the methods of applying them are described.

Diseases of Economic Plants.†—A text-book on this subject has been prepared by F. L. Stevens and J. G. Hall. They aim at meeting the needs of those who desire to recognize and treat diseases without the burden of long study as to their causes, and they also endeavour to help the student to recognize and name the parasites that are the cause of so many plant diseases. The authors give an historical account of the subject, talk of the importance of plant diseases economically, and describe methods and means of cure. They then go on to the diseases that affect particular crops, and describe these in general terms; purely microscopic characters being relegated to the Appendix. The book is well illustrated.

Plant Diseases.‡—Ernest Voges writes on the possibility of overcoming the *Fusicladium* disease of apples and pears. He names the varieties of apple-trees that are more or less immune to the disease, and points out that young and very vigorous trees suffer less than old trees or than those in poor soil. He traces the life-history of the fungus, and holds that young shoots are not only attacked, but harbour the fungus during the winter. The most abundant source of infection is to be found in the fallen leaves that are scattered through garden or orchard, and Voges recommends above all things the burning of such leaves. He does not think spraying of the leafless trees of great value, but he advises spraying the growing leaves with Bordeaux mixture.

F. Gueguen§ describes a hyphomycetous fungus which does considerable damage to the fruits of the cocoa. He found that it gained entrance to the young seed by the bite of an insect that pierced the capsule to get at the radicle of the embryo. The mycelium of the fungus was colourless, then brown: the spores were simple and colourless. The

* Cornell Univ. Agric. Exp. Stat. Bull. 283 (1910) (17 figs.).

† New York: Macmillan Co. (1910) x. and 513 pp. (3 pls. and 214 figs.).

‡ Zeitschr. Pflanzenkr., xx. (1910) pp. 385-93.

§ Bull. Soc. Mycol. France, xxvi. (1910) pp. 287-97 (2 pls.).

fungus belongs to the genus *Acrostalagmus*, and was named by Gueguen *A. Vilmorini* f. *Thomensis*. Though the insect was generally present, some fruits were attacked where no insect was to be found. The author advises spraying and washing by arsenide of copper, a poison that would destroy both the insect and the spores of the fungus.

Griffon and Maublanc * have examined a microscopic fungus on the branches of pear-trees, causing spots and dried areas which become somewhat large and deep wounds, resulting in the death of the smaller twigs. The authors found on the twigs several different fungi already described, species of *Sphæropsis* and *Diplodia*, usually saprophytic, but able in certain conditions to become harmful parasites. Two of these fungi, *Sphæropsis malorum* and *S. pseudo-diplodia* have been previously recognized as saprophytes or parasites both in Europe and America. The third fungus, *Diplodia* sp., which was found on the branches of pear-trees at Grignon, has been left undetermined.

A series of notes † on plant pathology have been made by T. Petch. He calls attention to "pink disease" of *Hevea*, which is due to *Corticium javanicum*, and recommends coal-tar for healing up wounds caused by pruning.

A disease of tomatoes ‡ is ascribed to the *Bacillus solanacearum*, causing the leaves to wilt. The bacteria live in the root, and plants should be dug up and burned. A root disease of tea caused by *Poria hypolateritia* was supposed to be confined to high altitudes, but cases occurred recently in the lower districts. The *Poria* is thin and pink in colour, and attacks the tree at the soil surface. In the same paper it is stated that old stumps form a starting point for diseases that spread to living trees. Thus *Ustilina zonata* passes from *Grevillea* stumps to tea-trees near by.

Preventive measures § are being taken in Ceylon, Petch informs his readers, against the importation of diseased tea seed from districts in India infested with "blister blight," due to the leaf-fungus *Exobasidium vexans*.

The wilt disease || of pepper has been ascribed to an eel-worm, but *Nectria* fruits and mycelium have been found on the dying trees, and are probably the cause of the mischief.

Tea seedlings ¶ were found to have been killed by a species of *Fusarium*, which attacks at the soil level and kills the young tree about an inch above the ground; when the fungus penetrates the wood the supply of water is stopped and the plant dies. Sterilizing of seed-beds is recommended.

A number of diseases** on the roots of trees have also been described by Petch. *Hevea* is attacked among other fungi by *Sphærostilbe repens*. In the first case recorded, three large trees twenty-five years old were killed. The fungus burrows below the bark of the root, where it forms

* Bull. Soc. Mycol. France, xxvi. (1910) pp. 307-16 (2 pls. and 2 figs.).

† Tropical Agric., xxxiii. (1909) No. 5.

‡ Tom. cit., No. 6.

§ Tropical Agric., xxxiv. (1910) No. 2.

¶ Tom. cit., No. 6.

|| Op. cit., xxxv. (1910) No. 3.

** Circ. and Agric. Journ. Roy. Bot. Gard. Ceylon, v. No. 8 (1910) pp. 65-71 (2 pls.).

strands or sheets of black or red mycelium. The conidial form is a red stalk with a head of spores; the perithecia are small dark red bodies.

A second paper* deals with root diseases of *Acacia decurrens*, a tree that is "planted in up-country districts as a wind-break in tea." One of these diseases is caused by *Armillaria fuscipes*, which forms sheets of red or white mycelium under the bark; the fructification does not appear till the tree has been dead for some time. The habit of the fungus is very like that of *A. mellea*.

Another disease also described is caused by *Fomes australis*, one of the bracket fungi. Infection probably takes place through wounds, but the fungus can also spread from tree to tree by the roots. The fungus is of slow growth, and can be rooted out if taken in time.

Brown root disease† due to *Hymenochæte noxia*, is characterized by a thin dark brown crust adhering to the base of the stem. It attacks a considerable number of different trees, and Petch records its appearance on several new hosts—camphor, cacao, cinnamon, etc.—he recommends burning the diseased trees and roots. A somewhat similar disease (*H. rigidula*) is found in the jungle also on a number of trees.

Information is given‡ by the Board of Agriculture as to the appearance of powdery mildew of peach and cherry. It begins as small white patches on both surfaces of the leaves, and on the young twigs. In the case of peaches it does great damage, as it attacks the young fruit. It is recommended to spray the trees with half-strength Bordeaux mixture when the disease appears.

A leaflet§ has been issued dealing with *Spongospora scabies*, corky scab of potatoes. Experiments in Western Ireland have proved that lime in the soil rather aids the disease. Care should be taken to plant seed free from the parasitic organism, and also to see that the clean tubers have not been in contact with any that are diseased. Soaking in formalin will kill the parasite if it is only in the superficial cells of the potato.

L. Pavarino|| found that in the leaves of plants attacked by *Eroascus* the temperature rose higher than in healthy leaves, and he considers this phenomenon as a local fever induced by the action of the fungus poison.

F. R. Bubak¶ has detected on fir-needles a Pyrenomycete with many-spored asci, which he names *Rehmielopsis bohémica* g. et sp. n., and the pyrenidial form, also a new discovery, *Phoma bohémica*.

A disease of pine-needles** has been observed by E. Münch and C. v. Tubent. The trees looked as if they were suffering from smoke, an impossibility in the circumstances. A fungus, *Hendersonia acicola* sp. n., was found on the decaying leaves, and was probably the cause of the trouble.

* Circ. and Agric. Journ. Roy. Bot. Gard. Ceylon, v. No. 10 (1910) pp. 89-94 (3 pls.). † Tom. cit. No. 6, pp. 47-56 (2 pls.).

‡ Journ. Board Agric. xvii. (1910) pp. 652-3 (1 pl.).

§ Board of Agric. and Fish. Leaflet N. 232 (1910) 4 pp. (1 fig.).

|| Riv. Pat. Veg. iv. (1909) pp. 3-4. See also Centralbl. Bakt., xxviii. (1910) p. 274.

¶ Naturw. Zeitschr. Forst.-Landw., viii. (1910) pp. 313-20 (5 figs.). See also Ann. Mycol., viii. (1910) p. 572.

** Tom. cit., pp. 39-44. See also Ann. Mycol., viii. (1910) pp. 577-8.

C. v. Tuben^{*} has also followed the life-history of *Lophodermium Pinastris*, a parasite on pine-needles. It is connected with small black pycnidia that produce innumerable colourless spores. Inoculation experiments were unsuccessful.

Frombling[†] has also written on diseases of Conifers which have become so prevalent in recent years. As to larch disease, he considers that the tree has been taken from its native surroundings and planted often in rich soil, which induces quick and luxuriant growth, but also renders it more open to attack. He also accuses the constant re-planting of pines in one locality of having a weakening effect on the tree. Much depends on the source from which seed is procured. He recommends procuring seed where possible in the country itself, as the trees grown from native seed will be better fitted to meet native conditions.

K. Störmer[‡] seeks to prove that cherry disease, said to be due to *Valsa leucostoma*, apple disease to *Cytospora piricola*, and potato-leaf rolling to *Fusicillium albo-atrum* or *Fusarium*, are all really caused by the same organism, some endogenous bacterium. Incidentally the author has proved the existence of bacteria in healthy plants.

E. Vinet[§] traces a disease of vines in Anjou to the presence of fungus mycelium in the tissues, which had destroyed the wood and the bark. *Stereum hirsutum* and *Polyporus versicolor* both grew on the diseased trees. *P. igniarius* has also been regarded as the cause of the malady.

A. Møller^{||} gives advice as to fighting the disease of Conifers due to *Trametes Pini*. In general, care should be taken to root out all stumps of felled trees, and to destroy the fruiting bodies of the fungus that have developed on any trees that must be left standing. Infection takes place through the ends of cut branches and through wounds in the bark. The most fatal time for the tree is between fifty and seventy years of age.

P. Magnus[¶] records a disease of rhubarb caused by a *Peronospora*. It forms spots on the leaves, the diseased portions ultimately falling out, and the mycelium in them, owing to abundant glycogen contents, is able to persist as resting mycelium, and re-infect new leaves.

BATAILLE, F.—**Champignons rares ou nouveaux de la Franche-Comté II.** (New or rare fungi from Franche-Comté.)

[Complete descriptions are given of all the species.]

Bull. Soc. Mycol., xxvi. (1910) pp. 330-48.

* *Naturw. Zeitschr. Forst.-Landw.*, viii. (1910) pp. 408-11. See also *Ann. Mycol.*, viii. (1910) p. 578.

† *Forst. wiss. Centralbl.*, xxxii. (1910) pp. 193-200. See also *Centralbl. Bakt.*, xxviii. (1910) pp. 275-6.

‡ *Jahresb. Ver. Angew. Bot.*, vii. (1910) p. 119. See also *Centralbl. Bakt.*, xxviii. (1910) pp. 278-9.

§ *Rev. Vitic.* xxxii. (1909) pp. 676-81. See also *Centralbl. Bakt.*, xxviii. (1910) p. 282.

|| *Zeitschr. Forst. Jagdw.*, xlii. 3 (1910) pp. 129-46. See also *Bot. Centralbl.*, cxiv. (1910) p. 547.

¶ *Ber. Deutsch. Bot. Gesell.*, xxviii. (1910) pp. 250-3 (1 pl.). See also *Bot. Centralbl.*, cxiv. (1910) pp. 595-6.

- BROILLI, J.**—**Versuche mit Brand-Infektion zur Erziehung brandfreier Gerstenstämme.**
 [Experiments in the cultivation of races of barley immune to smut-infection.]
Nat. Wiss. Forst.-Landw., viii. (1910) pp. 335-44.
 See also *Bot. Centralbl.*, cxiv. (1910) pp. 594-5.
- COKER, W. C.**—**Another New Achlya.**
 [The new fungus *A. caroliniana* has branched oogonial stalks.]
Bot. Gaz., 1. (1910) pp. 381-3 (8 figs.).
- DIBDIN, W. J.**—**The Biological Disposal of Waste Yeast.**
 [Accounts of sewage bed processes.]
Journ. Inst. Brewing, xvi. (1910) pp. 535-43.
- FAES, HENRY**—**Les maladies des plantes cultivées et leur traitement.** (The diseases of cultivated plants and their treatment.)
 [A book of plant diseases, with directions how to recognize the causes of disease, and with advice as to the remedies.]
 Lausanne (1909) 256 pp.
 See also *Centralbl. Bakt.*, xxviii. (1910) pp. 274-5.
- HARDY, A. D.**—**Alga and Fungus in Salmon-disease.**
 [*Suprolegnia* sp. was found on dying fish, and its connection therewith is discussed.]
Proc. Roy. Soc. Victoria, xxiii. (1910) pp. 27-32.
- HÖHNEL, F. VON**—**Atichia Treubii v. Höhnel.** (Saccharomycetes.)
 [The spores of the yeast are two-celled: it was found on leaves of *Ficus elastica*.]
Ann. Jard. Bot. Buitenzorg, Suppl. 3 (Treub. Festschrift) i. (1910) pp. 19-28. See also *Bot. Centralbl.* xiv. (1910) p. 428.
- HERZFELD, S.**—**Ueber eine neue Taphrina auf Polystichum Lonchitis.** (A new *Taphrina* on *Polystichum*.)
 [Differs in various respects from other fern *Taphrinæ*.]
Oesterr. Bot. Zeitschr., lx. 7 (1910) pp. 249-54 (8 figs.)
 See also *Bot. Centralbl.*, cxiv. (1910) p. 544.
- HEINRICHER, E. & E. ELSLER**—**Pachyma Cocos. Ein interessanter Pilzfund für Tirol.** (*Pachyma Cocos*: an interesting fungus find in the Tyrol.)
 [Found hitherto in China.]
Zeitschr. Ferd. Innsbruck, iii. Folge liv. (1910), pp. 339-48 (1 pl.)
 See also *Bot. Centralbl.*, cxiv. (1910) p. 428.
- ILTIS, HUGO**—**Ueber eine durch Maisbrand verursachte intracarpellare Prolifiration bei Zea Mays.** (An intracarpellary proliferation in *Zea Mays* caused by maize smut, *Ustilago Zea Maydis*.)
SB. Akad. Wiss. Math.-Nat. Kl. cxix. (1910) pp. 331-45 (2 pls.)
- LOVEJOY, RUTH HARRISON**—**Some New Saprophytic Fungi of the Middle Rocky Mountain Region.**
 [Several new species of the larger fungi and one new genus of Agarics, *Calathelasma*.]
Bot. Gaz., 1. (1910) pp. 883-5.
- MASSEE, G.**—**Fungi exotici. X.**
 [New fungi chiefly from the West Indies, but a few from Tropical Africa and elsewhere. There is one new genus, *Hartiella* near to *Arthrosporium*.]
Kew Bull., 1910, pp. 1-6 (1 pl.).
- PÉNAU, HENRY**—**Cytologie d'Endomyces albicans.** (Cytology of *Endomyces albicans*.)
 [Notes on nuclear division (amitotic) in filamentous yeasts.]
Comptes Rendus, cli. (1910) pp. 774-6.
- RICKEN, ADALBERT**—**Die Blätterpilze.** (Agaricaceae.)
 [First part of a work on German and Swiss Agarics.]
Weigel, Leipzig, 1910, 32 pp. (8 col. pls.).
- RICK, J.**—**Fungi Austro-Americani. Nos. 201-300.**
 [The fascicle contains many fine tropical species. Several specimens are accompanied by drawings.]
Feldkirch in Vorarlberg, 1910.
 See also *Bot. Centralbl.*, cxiv. pp. 382-3.

- STRASZER, PIUS.—**Fünfter Nachtrag zur Pilzflora des Sonntagberges.** (Fifth contribution to the fungus flora of the Sonntagberg.)
 [The present list includes about 300 species, several of them new.]
Verh. k.k. Zool. Bot. Ges. Wien, lx. (1910) pp. 305-35.
- SELIBER, G.—**Sur le virage du pigment de deux champignons.** (On the changes of colour in the pigment of two fungi.)
 [The fungi experimented with were *Fusarium heidelbergianum* (red) and *Cephalosporium subsessile* (violet). They changed their colours according to the acid-alkaline culture medium.]
Comptes Rendus, cl. (1910) pp. 1707-9.
- SARTORY, A.—**Etude biologique du Sterigmatocystis quercina.** (Biological study of *Sterigmatocystis quercina*.)
 [Results of culture experiments.]
Bull. Soc. Mycol. France, xxiv. (1910) pp. 349-57 (4 figs.).
- SYDOW.—**Mycotheca Germanica, Fasc. xviii.-xix. (Nos. 851-950).**
 [List of the species, with diagnoses of a number new to science.]
Ann. Mycol., viii. (1910) pp. 489-93.
- TORREND, C.—**Première Contribution à l'étude des Champignons de l'île de Timor (Océanie).** (First contribution to the study of the fungi of the Island of Timor.)
 [The list includes several new species.]
Brot. Ser. Bot., ix. (1910) pp. 83-91 (2 pls.).
 See also *Ann. Mycol.*, viii. (1910) p. 576.
- WESTLING, R.—**En ny Askusbildende Penicillium-art.** (An ascus-forming species of *Penicillium*.)
 [*Penicillium baculatum*, sp.n. formed on leaves, nearly allied to *P. glaucum*.]
Svensk. Bot. Tidskr., iv. (1910) pp. 139-45 (1 fig.).
 See also *Ann. Mycol.*, viii. (1910) pp. 576-7.)

Lichens.

(By A. LORRAIN SMITH.)

American Species of *Stereocaulon*.*—L. W. Riddle finds the American species of *Stereocaulon* fall into two groups: one, with *S. paschale* as the central species, is typical of northern regions; the other group is tropical, and is represented by *S. ramulosum* and its allies. As a result of careful examination of a great mass of material, Riddle has been able to draw up a key based on salient and persistent species characters. Between *S. paschale* and *S. tomentosum* he finds the most constant feature of distinction in the cephalodia; in the former they contain *Stigonema* algæ, in the latter *Nostoc*. These two species are apt to be confused: the same character is used to distinguish between *S. dendratum* (with *Stigonema*) and *S. alpinum* (with *Nostoc*). These species are European as well as American.

Cladoniæ.†—L. W. Riddle has published a key to the species of *Cladonia* in New England. The species in this genus are extremely variable, and no key can be constructed, he tells us, that will serve for the determination of all specimens. He adds a list of the species and varieties with synonyms used in Tuckerman's Synopsis of North American Lichens.

* *Bot. Gaz.*, l. (1910) pp. 285-304 (9 figs.).

† *Bryologist*, xiii. (1910) pp. 92-7.

Obituary Notice.*—Bruce Fink writes a short sketch of the life and work of Carolyn Wilson Harris, who died at Lakewood, New Jersey, in May of last year. She collected and studied Lichens for many years, and contributed many papers on the subject to the *Bryologist*, a journal that, owing to her interest in the matter, has been largely concerned with the study of Lichens as well as of Mosses. She laid emphasis on macroscopic characters or such as could be seen with a hand-lens. Her papers deal with the larger foliose or fruticose species.

HASSE, H. E.—Additions to the Lichen Flora of Southern California

[Two species new to California, and one *Lecanora marginalis* new to science.] *Bryologist*, xiii. 1910, pp. 111-12.

HEBER HOWE, R. (JR.)—Lichens of the Mount Monadnock Region, N.H., No. 5.

[Species of *Stereocaulon* and *Cladonia*, the latter determined by L. Scriba, Frankfort.] *Bryologist*, xiii. (1910) pp. 119-21.

MERRILL, G. R.—Lichen Notes, No. 15.

[Discussion as to the similarity of *Cladonia mitrula* and *Helopodium capitatum*.] *Bryologist*, xiii. (1910) pp. 103-5.

SERVIT, MIR.—Zur Flechtenflora Norddalmatiens. (The Lichen Flora of N. Dalmatia.)

[A list of species collected by the author.] *Magyar Bot. Lapok*, ix. (1910) pp. 164-93.

Mycetozoa.

(By A. LORRAIN SMITH.)

Colloderma a New Genus of Mycetozoa.†—G. Lister has received from W. Crau two gatherings of a mycetozoon collected by him in Aberdeenshire. She has identified them with specimens previously collected and named by G. Lippert as *Didymium oculatum*. As the species has no lime crystals it is removed from Didymiaceæ and placed in the new genus as above. It is characterized by having two sporangial walls, an outer one gelatinous, and an inner membranaceous. Spores and capillitium are dark purplish-brown.

Parasites on the Roots of Juncaceæ.‡—E. J. Schwartz finds two distinct parasites on the roots of Juncaceæ. One of these, which he has named *Sorosphæra Junci*, occurred in spherical balls on the roots of *Juncus articulatus*. He worked out the life-history, which follows that of the previously described *S. Veronicæ*. The first stage observed was a small plurinucleate amœba in one of the root-hairs, in this infection differing from *S. Veronicæ* where the parasite enters at the root apex. The amœbæ increase in size, and the nuclei divide. They then break up into a number of small amœboid organisms; the nucleus of these divide twice, forming four small bodies; these become spores which are collected into sorospheres, or are loosely aggregated. The writer places *Sorosphæra* next to *Plasmodiophora*. He also describes a fungus, *Euto-*

* *Bryologist*, xiii. (1910) pp. 89-91.

† *Journ. Bot.*, xlviii. (1910) pp. 310-12.

‡ *Ann. Bot.*, xxiv. (1910) pp. 511-22 (1 pl.).

rhiza cypericola (Ustilaginæ), which forms tubercles on the roots, brown or black when mature. Infection in the latter case probably takes place by a root-hair.

BILGRAM, HUGO—Unusual forms of *Myxomycetes*.

[Sessile sporangia of *Physarum pulcherrimum* and stalked forms of *Perichæna chryso-spora*, both very rare.]

Proc. Acad. Nat. Sci., lxii. (1910) pp. 271-2.

BURRELL, W. H.—Norfolk *Mycetozoa*.

[Supplemental list (one, *Orcadella operculata*, new to this country).]

Trans. Norfolk and Norwich Nat. Soc., ix. (1909-10) pp. 106-7.

KUSANO, S.—Studies on the Chemotactic and other Reactions of the Spores of *Myxomycetes*.

[Experiments were made with various chemical solutions.]

Coll. Agric. Imp. Univ. Tokyo II., i. (1909) pp. 1-83 (1 fig.)

See also *Bot. Centralbl.*, cxiv. pp. 383-5.

Schizophyta.

Schizomycetes.

Comparative Study of Coli-form Organisms.*—R. Burri and P. Andrejew have investigated a number of organisms allied to *Bacillus coli*, which do not ferment lactose or saccharose naturally, but will after some training attack the latter sugar. Five bacteria from fermenting grass, and five from fresh cow dung, were studied. Five paratyphoid strains were used for purposes of comparison. In most points, all these organisms resembled the paratyphoid bacillus closely, but were distinguished by agglutination tests. Further investigation showed that these strains could be separated into three well-marked groups, distinguished by their cultural reactions and biochemical affinities. The organisms obtained from cattle gave the indol reaction, but did not yield tryptophan, whereas the grass bacilli gave a positive tryptophan reaction, but failed to produce indol. The authors conclude that a more precise identification of *Bacillus coli* should be made, before adducing its presence in water or milk as evidence of faecal contamination.

Bacteriology of Appendicitis.†—Heile gives an account of his investigations of the micro-organisms associated with appendicitis. In nine early cases, where the disease was circumscribed, he found a streptococcus six times, *Bacillus coli* twice, and a mixed growth of streptococci and *B. coli* in the remaining case. This streptococcus showed some peculiarities on cultivation. It was strongly hæmolytic when grown on blood-agar. Colonies on nutrient agar produced a characteristic brownish-red pigment. This organism was found to be highly pathogenic to mice and rabbits, less markedly so to guinea-pigs. Smear preparations from the contents of the appendix showed that the leucocytes were rapidly ingesting these cocci, and active phagocytosis could also be demonstrated experimentally. This streptococcus was

* *Centralbl. Bakt.*, 1^{te} Abt. Orig., lvi. (1910) pp. 217-33.

† *Tom. cit.*, pp. 233-41.

also found pure in two cases of appendicitis associated with septicaemia and peritonitis. In the more common type, where appendicitis was accompanied by peritonitis unassociated with septicaemia, *B. coli* was present in nearly every case. Other organisms found in such cases were pyogenic streptococci, *Diplococcus lanceolatus*, *Bacillus pyocyaneus*, *B. proteus*, *B. mesentericus vulgaris*, and pseudo-diphtheria bacilli.

§ **Micro-organisms in Koumiss.***—B. Rubinsky finds that four species are usually present. Two characteristic forms, koumiss-bacterium and koumiss-yeast, are the agents essentially concerned with the preparation of this material. *Streptococcus lactis* and *Bacillus aerogenes* (*B. acidi lactici* Hüppe) are very constant accessories, and play probably an important part in producing in the milk a degree of acidity destructive to hostile organisms, as well as in keeping a set balance between the specific yeast and bacterium.

The most peculiar features of the yeast, its physiological reactions, are dealt with in detail. The bacterium is a non-motile, non-sporing organism, which exhibits a high degree of polymorphism. It is most closely related to the *B. acidophilus* of Moro.

Koumiss is usually prepared from mare's milk. The author found that with cultures of yeast and bacterium in symbiosis, koumiss was readily made from the milk of mares or camels, but not from that of goats.

Bacteria in Frozen Soil.†—H. J. Conn gives an account of a year's work upon the quantitative and qualitative investigation of soil bacteria under winter conditions. He finds that when the soil is completely frozen, there is an unexpectedly rapid multiplication of organisms; the number obtained being greater than that obtained in summer or autumn enumerations. The general rule is that the number of bacteria varies directly with the moisture curve, but these winter observations show that there are exceptions to this rule. The results of qualitative investigations, so far, indicate that there may be two groups of bacteria in the soil, one group flourishing in summer, the other in winter.

Actinomycosis of Plants.‡—From the root-nodules of *Alnus Glutinosa* and *Myrica Gale*, Y. Peklo has cultivated organisms which he assigns to the Actinomyces. In the first place, he considers in detail the histological appearances of the tissues invaded by or in juxtaposition with this organism, and shows how its relation to the host is at times parasitic, at times symbiotic. The most suitable culture medium contained beer-wort and some calcium salts. Inoculation with pure cultures into fresh plants proved that infection could be transmitted in this way. Microscopically, the organism was found to be a typical *Streptothrix*, consisting of a network of threads, chains of coecal or bacillary cells, enmeshing clumps of endospores.

The author then considers certain analogies between the changes produced by this species and the histopathological changes associated with actinomycosis in animals. He also states that in certain media con-

* Centralbl. Bakt., 2^e Abt., xxviii. (1910) pp. 161-219.

† Tom. cit., pp. 422-34.

‡ Tom. cit., pp. 451-579.

taining salts, tubercle bacilli assume *Streptothrix* forms, and expresses the view that the study of these endophyta associated with plants may throw light upon the pathology of infections in man and animals.

Disease-carriers.*—In opening a discussion upon this subject, A. C. Houston pointed out that, hitherto, attention had been paid to the passive transmitters rather than to the living storehouses of disease. It is now known that, after an attack of enteric fever, a person may continue to harbour and excrete typhoid bacilli for many years. Recent work has shown also that pathogenic bacteria may increase and multiply within the stomachs of flies and other insects. On the other hand, the conditions existing in soil, water or air are unfavourable to the multiplication, even to the survival, of disease germs.

O. Lenz described the organization of the typhoid campaign in south-west Germany. Bacteriological stations were organized for the purpose of assisting practitioners in the diagnosis of typhoid, investigating sources of infection and finding when convalescents cease to eliminate the bacteria. Convicted carriers received instructions as to care and cleanliness, but were subject to no legislative control. The results of this campaign were satisfactory, as statistics showed a material reduction in the number of typhoid cases.

Papers upon diphtheria and dysentery carriers were read. In both these diseases the convalescent carrier is an important agent in the spread of infection, but this condition is not so persistent as in the case of typhoid. Lastly, in a summary of recent researches upon the transmission of the plague bacillus, G. F. Petrie stated that human carriers played no important part in the transmission of disease. The rat appears to be the ultimate reservoir of this organism.

New Types of Urobacteria.†—From various samples of urine, A. Roehaix and A. Dufourt have isolated eight new microbes of ammoniacal fermentation. These organisms also produce ferments capable of liquefying gelatin or serum, and of coagulating milk. They act upon neutral red media, producing canary-yellow with green fluorescence. All but one form indol. Their power of transforming urea into ammonium carbonate diminishes as the cultures become old and accustomed to artificial media. These organisms are pathogenic to laboratory animals, and may cause fatal septicæmia.

Relation between Avian and Mammalian Tuberculosis.‡—D. A. de Jong, who formerly held the doctrine of the duality of the bacilli of Birds and Mammals, now gives reasons for altering his opinion, and declares in favour of unity. He has made observations which have led him to the conclusion that the difference between Avian and Mammalian tubercle is not absolute, and that the passage from one form to the other is possible. Health authorities should therefore take measures against Avian tuberculosis, as man, monkey, ox, pig, rabbit, rat, and mouse may be infected.

* Brit. Med. Journ., 1910, ii. pp. 1499-1510.

† C. R. Soc. Biol. Paris, lxi. (1910) pp. 312-14.

‡ Ann. Inst. Pasteur, xxiv. (1910) pp. 895-906.

Jöhne's Bacillus.*—F. W. Twort has succeeded in isolating and cultivating the acid-fast bacillus found in the intestine of cows in Jöhne's disease. The first generation of this bacillus grows long, with branching and club formation. In subcultures it is smaller; being, in the second or third generations, about the size of *B. tuberculosis*. The growth is only just visible to the naked eye. The cultures were incubated at 40° C.

Enzymes in Different Bacteria.†—E. Abderhalden, L. Pincussohn, and A. Walther find the culture fluids of a paratyphoid-like bacillus and of *Streptococcus pleuro-pneumoniæ* have no peptolytic action on various kinds of peptone. *Bacillus paratyphus* slightly decomposes casein peptone. Various bacilli were grown in different media with and without peptone, and the change in the rotary power noted. It is hoped that this method, of which a few preliminary examples are given, may be utilized in the differentiation of micro-organisms.

Action of Dysentery Bacilli on Nitrites and Nitrates.‡—W. J. Logie remarks that all the dysentery strains examined, with one exception (*Bacillus Neisser*, etc.), reduced nitrates to nitrites; none which fail to ferment mannitol destroyed nitrites. *B. dysenteriæ* Jürgens, although closely related to *B. dysenteriæ* Flexner, differs from it in its action on litmus whey, and in failing to destroy nitrite. *B. dysenteriæ* Jürgens is the only strain found to form indol, and therefore to give the cholera-red reaction. The addition of dextrose enables *Shiga* strains to destroy nitrites. With an abundant supply of oxygen, all the strains fail to destroy nitrites and nitrates, but in media which contain dextrose the inhibitory effect of oxygen is less marked. Under anaerobic conditions, *Shiga* strains and *B. dysenteriæ* Jürgens still fail to destroy nitrites.

Intestinal Flora.§—E. Metchnikoff, in a second memoir on intestinal bacteria || discusses the effect of the toxins on the organism, and comes to the conclusion that sclerosis of tissues, e.g. of arteries, is often the result of the absorption of these poisons.

FOWLER, G. J., E. ARDERN, & W. T. LOCKETT.—Oxidation of Phenol by certain Bacteria in pure culture

Proc. Roy. Soc., lxxxiii. (1910) pp. 149-56.

* *Proc. Roy. Soc.*, lxxxiii. (1910) p. 158.

† *Zeitschr. Physiol. Chem.*, lxviii. (1910) pp. 471-6, through *Journ. Chem. Soc.*, xcvi. and xcvi. (1910) ii., 989.

‡ *J. Hygiene* (1910) pp. 143-54, through *Journ. Chem. Soc.*, xcvi. and xcvi. (1910) ii., 988.

§ *Ann. Inst. Pasteur*, xxiv. (1910) pp. 755-70 (3 pls.).

|| See this Journal, 1909, p. 236.



MICROSCOPY.

A. Instruments. Accessories, etc.*

(3) Illuminating and other Apparatus.

Sliding Nose-piece for use in Stereo-photomicrography.†—H. C. Banfield describes a useful piece of apparatus for moving the objective

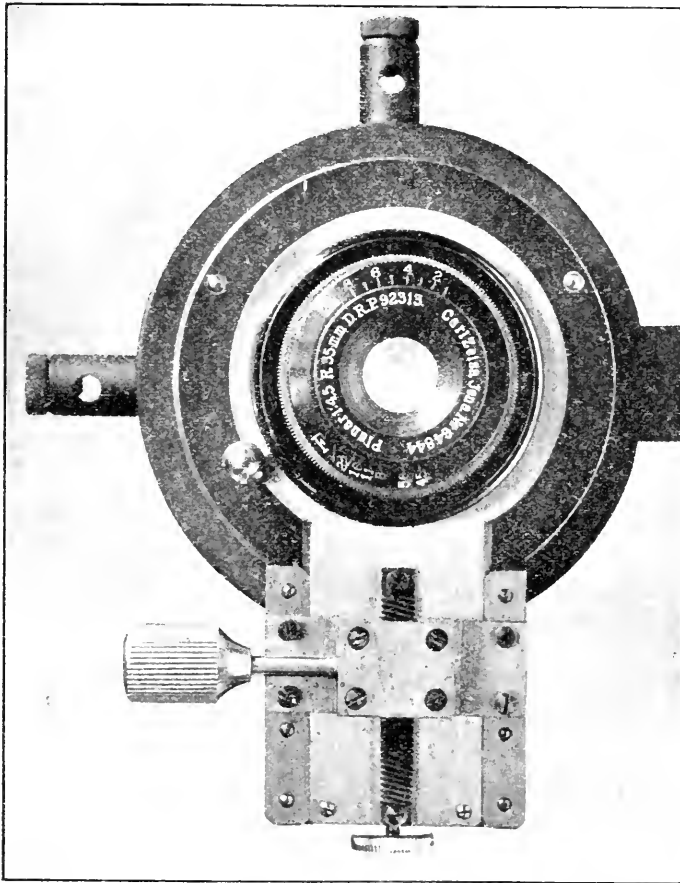

FIG. 4.

* This subdivision contains (1) Stands; (2) Eye-pieces and Objectives; (3) Illuminating and other Apparatus; (4) Photomicrography; (5) Microscopical Optics and Manipulation; (6) Miscellaneous.

† Journ. Quekett Micr. Club, xi. (1910) pp. 121-2 (1 fig.).

for low-power photomicrography. The device consists of a sliding plate screwed to carry the objective, and laterally displaceable by means of a small rack-and-pinion (fig. 4). For several reasons this method is more convenient than moving the object, as the illumination is unaltered and the shadows fall on their right place. The apparatus can be used only on Microscopes with a large body-tube, but a half-plate camera and a Microscope fitted with the Zeiss sliding objective changers are all that is necessary for high-power work, as the lateral screw of these changers moves the objective adequately and efficiently.

Are Lamps for Projection.*—H. P. Gage has, with the help of the General Electric Company at Schenectady, made an exhaustive series of investigations on the above subject. These investigations were suggested by, and supplementary to, certain preliminary investigations at Cornell University. They dealt with direct and alternating currents as applied to the three ordinary types of projection lamps, viz. with inclined carbons, with electrodes at right angles, with converging electrodes. Full descriptions, with diagrams, are given of the experiments and results. The author concludes that a direct current obtained from a mercury-arc rectifier gives almost as much light as a direct current from a generator. In every case direct current gives much more light for equal current values than does alternating current. He is of opinion that evidently the power drawn from the line depends upon the power consumed at the arc and the efficiency of the "ballast" or transforming device. Of the devices tested the rectifier was the most efficient, and the least efficient was a resistor used with alternating current.

Improvement in the Illumination of Objects observed with the Binocular Microscope.†—C. Cépède, in the course of his botanical and zoological researches with the binocular Microscope, has found rather serious inconvenience arise from the formation of a shadow zone in the part of the object turned towards the observer. This shadow is a hindrance, by its depth, to the minute morphological and anatomical study of all this part of the object. The author has overcome the difficulty by illuminating the part in question by the help of a concave mirror, which may be applied in three ways.

First Arrangement.—In this case, midway between the holes admitting the spring-clips, the stage is pierced by a similar hole for the admission of a cylindrical screw-piece, resembling those bearing the clips. To this screw-piece is attached a brass or nickel rod, bent at right angles, and carrying a mirror-holder at its further extremity. The mirror is fixed by help of screws, so that it has movement in two directions. The whole arrangement thus has a triple articulation, and can be directed as desired.

Second and Third Arrangements.—In these the screw which fixes the arm of the Microscope to the stage is used for screwing the mirror-holder, which may be fastened either to the upper part of the arm (second arrangement) or to its lower part (third arrangement). The mirror-carrier itself is substantially the same as in the first arrangement.

* *Electrical World*, Oct. 13, 1910; and as a separate pamphlet, 5 pp. (9 figs.).

† *Comptes Rendus*, cli. (1910) pp. 948-9.

Jentsch's Ultra-condenser.*—This apparatus has been designed by F. Jentsch for investigations concerned with molecular movement in gases. It permits the passage of rays from all azimuths of the plane perpendicular to the Microscope-axis, and, in addition to these, many

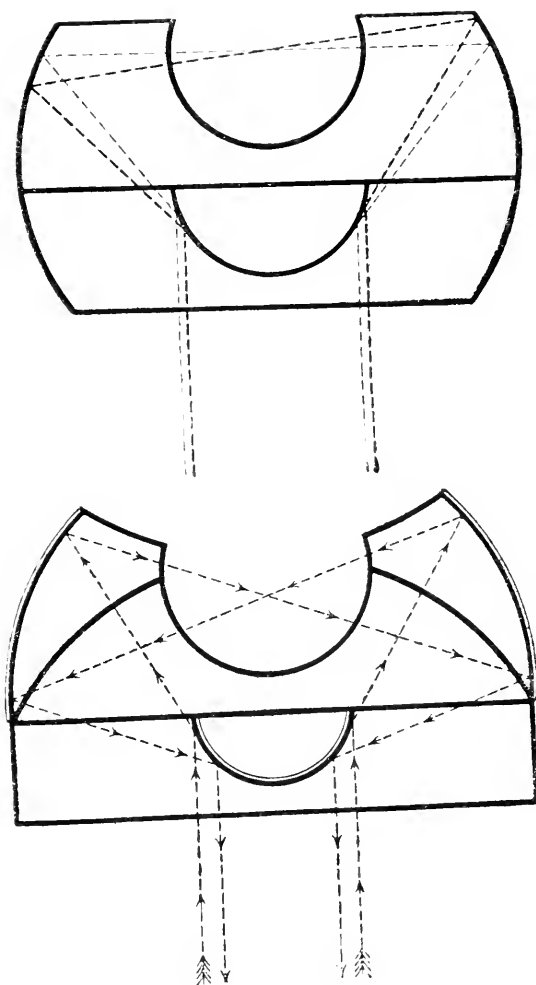

FIGS. 5, 6.

other rays above and below this plane find their way to one and the same point. This peculiarity distinguishes the apparatus from Zsigmondy's ultramicroscope, which only admits a beam of rays from

* Verh. Deutsch. Phys. Gesell., xii. pp. 992-4 (3 figs.).

one side. The author attains his purpose by the arrangements shown in figs. 5, 6, 7. Thus, in fig. 5, by means of the two reflecting spherical surfaces, each ray undergoes four reflexions, two before, and two after, reaching the particles contained in the upper spherical cavity. It will be noticed that the rays quit the condenser on the same side of the apparatus as they enter it. The pattern in fig. 5 is built up of two constituent pieces of glass; that in fig. 6 is composed of three constituents. The substance under examination in the upper cavity may be a gas, a vapour, or a fluid. For many fluid examinations, especially when only a small quantity of a strongly absorbing substance is available, the form shown in fig. 7 is better adapted. In this form

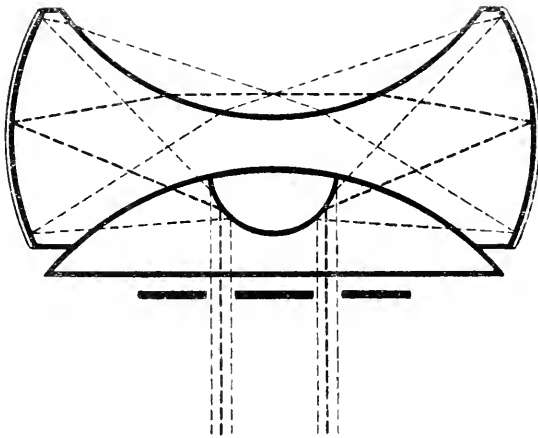

Fig. 7.

the hollow space is so arranged that boundary surface breaks the rays and takes part in forming the ray-combination. In addition to great brilliance, these designs, at any rate Nos. 5 and 6, offer the great advantage of freedom from colour-error, as their action depends exclusively on reflexion. Even with No. 7 colour-error need not arise if the aqueous solution be so chosen as to preserve the principle of "homogeneous dispersion."

If tobacco smoke be blown into this condenser, a very great number of bright particles is seen in active molecular movement. If an electric spark be introduced, the tiny particles of metal torn off from the electrodes can be seen whizzing about.

Jentsch's Concentric Condenser.*—F. Jentsch, after some general remarks about mirror-condensers in general, discusses in detail the principles of one based on the properties of two concentric circles. These will be understood from fig. 8, where AP_1P_2B is a ray originating at A and arriving at B after a convex reflexion at P_1 , and a concave

* Verh. Deutsch. Phys. Gesell., xii. pp. 975-91 (8 figs.).

reflexion at P_2 . O is the common centre of the circles, $a = oA$, and $b = oB$; the inner and outer radii being r_1 R_1 respectively. By properties of a triangle, it follows that

$$a \sin \alpha = r \sin \phi = R \sin \gamma = b \sin \beta;$$

whence
$$b = a \frac{\sin \alpha}{\sin \beta}.$$

If the origin be removed to infinity, then for a ray of incidence-height h ,

$$f = \frac{h}{\sin \beta},$$

where f is the focal distance of the zone in question. The condition for aplanatism is

$$\frac{\sin \alpha}{\sin \beta} = \text{a constant};$$

or, if A be at infinity,

$$\frac{h}{\sin \beta} = \text{a constant}.$$

Moreover, it can be shown that a system of two concentric reflecting circles is free from coma. Owing to the fact that one mirror reflects convexly and the other concavely, the catacaustics will have opposite

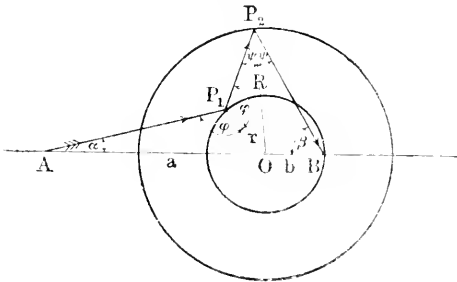

FIG. 8.

sense, and will tend to neutralize one another. With medium aperture the zone-aberration-values will change but slightly, and the system will have its greatest advantage under such a condition. There will, again, be many pairs of rays whose aplanatism will be perfect, and by suitable choice of radii this property can be made to apply to any desired range of aperture. The author also discusses the conditions under which the brightness will be a maximum, and shows that theoretical values can almost be attained in practice.

Fig. 9 shows how the principle of the concentric condenser can be actually realized for an aperture range of 0.97 to 1.35.

It will be noticed that in Jentsch's design the two curved surfaces are worked out of one and the same piece of glass, while in Ignatowsky's and in Siedentopf's patterns two pieces are required, thus introducing centring errors which are here absent. Jentsch's upper glass is a square

plane-parallel piece; it has only the significance of an intermediate piece, and serves to approximate the upper surface of the condenser to the object-carrier. This peculiarity also makes it less sensitive to injury in the use of high temperatures which might affect the cement. Both mirrors are silvered so that only those rays emerge which are required for dark-ground illumination; thus the concave mirror functions also somewhat as a diaphragm stop.

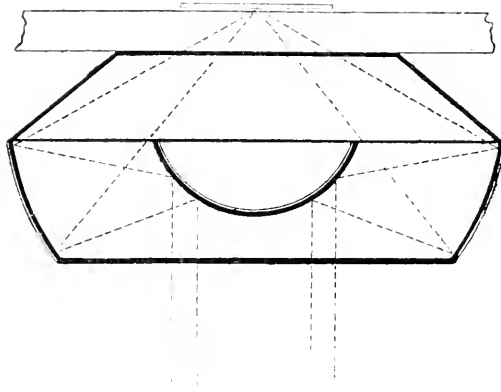

FIG. 9.

Simple Method of Making Drawings for Projection Purposes.*

M. Ponzo pours filtered gelatin over glass plates; old cleaned-up photographic plates do very well. When dry, these plates may be drawn on with ink, Indian ink, anilin colours, with brush or pencil. Mistakes may be remedied by scratching off the gelatin and refilling the erased spaces with fresh gelatin.

Electric Heating Apparatus for Microscopical Observations.†—

Figs. 10, 11, 12 show that the main idea in F. Jentsch's heating apparatus is a rectangular or circular brass box. This contains the heating apparatus, well isolated externally by means of asbestos: the box is fastened by two screws on to a slate slab 6 or 7 mm. thick, and is placed directly on the object-stage. The heating chamber is, in figs. 10 and 11, a small hollow metal box of good heat-conductivity in order to warm up the preparation uniformly, and is especially capable of resisting loss of heat by the observation-hole. In pattern No. 1 (fig. 10) the stove has a certain slowness, so that heating up, and cooling down, require some minutes (perhaps one minute for 250° C.). If the observation-hole is covered with a cover-glass a preparation may be kept for a whole day at a constant temperature. This effect is essentially due to a special spirally shaped coiling of the heating resistance wire, which gives within wide limits a temperature gradient proportional to the time. The highest temperature attainable depends

* Zeitschr. Biol. Technik u. Methodik, ii. (1910) p. 46.

† Zeitschr. wiss. Mikrosk., xxvii. (1910) pp. 259-64 (5 figs.).

only on the melting-point of the material used. With the above-mentioned stoves 900° C. could be reached: with platinum stoves,

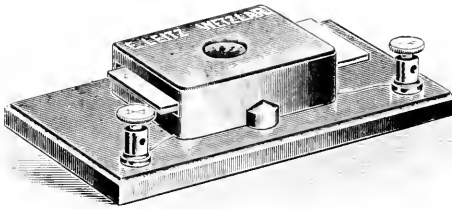

FIG. 10.

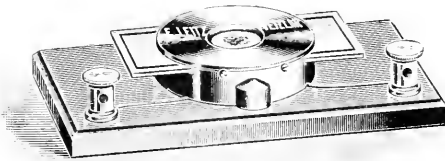

FIG. 11.

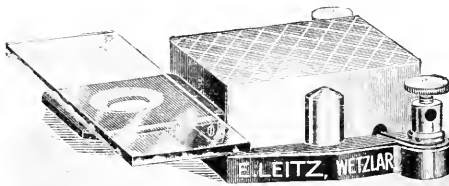

FIG. 12.

1500° C. With pattern No. 1 (fig. 8) the objective can be lowered to a working distance of 5 mm., which with Leitz' objectives would furnish a magnification of 258 diameters.

Pattern No. 2 (fig. 9) is for higher magnifications, the object-slide being brought up closer to the objective. A dry system will give 2000 diameters.

Pattern No. 3 (fig. 10) is arranged for the convenience of the illuminating system, the object-slide being placed on a laterally projecting slab. With this pattern, however, the constancy of the temperature is evidently liable to be affected by air-currents. On the other hand, changes in the object can be more readily noted.



FIG. 13.

Nos. 1 and 2 are suitable for mineralogical and petrographical sections, and No. 3 for microchemical reactions and interference figures in convergent polarized light. Another pattern is made intended for biological studies.

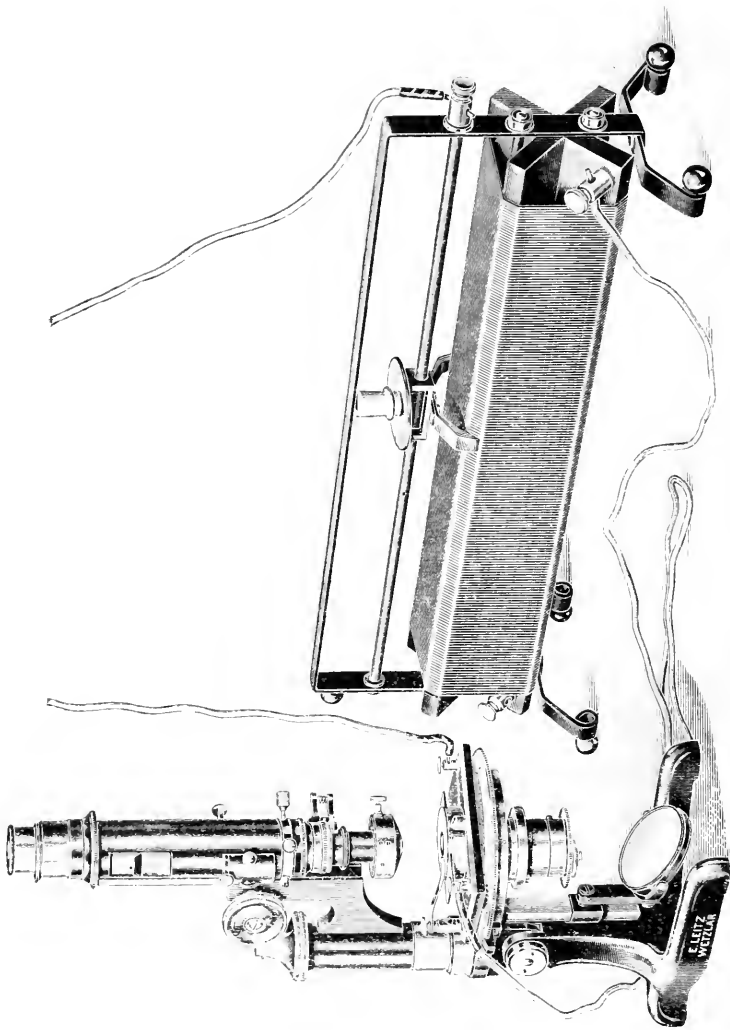

FIG. 14.

For small magnifications, and therefore for considerable objective distances, the objective does not require special protection. But for all cases of high temperature the objective needs a small protecting cap

(fig. 13). This cap easily fits on to the objective, and surrounds it with an isolating mantle of air.

For the determination of temperatures at which fluid crystallization and allotropic changes occur, the author considers his apparatus would be eminently suitable.

Fig. 14 shows the general arrangement with resistance coil.

(4) Photomicrography.

Simple Object-holder for Photomicrography: Tables of Magnifications.*—R. Müller describes this apparatus, which he has designed and found very useful. He uses it with the Zeiss horizontal-vertical camera, but slight alterations would adapt it to other Microscopes. The apparatus consists of a board 50 × 50 cm., secured by two lateral boards to the object-stage: it may be arranged for horizontal or vertical adjustment. In the horizontal position, the surface of the object-holder lies accurately at the height of the Microscope stage, the Microscope itself being perpendicular and firmly clamped on the foot-plate. In the vertical position, a hole is cut out of the board for the object-stage of the horizontally-inclined Microscope. Two adjustable laths with clamps serve for holding the objects to be photographed, e.g. culture-dishes, negatives, water-chambers, etc. A special shelf is used for photographing paper pictures. The whole arrangement is ingenious, and the author gives numerous pictorial illustrations of its application, as well as a very complete tabular list of the necessary numerical adjustments.

Wratten and Wainwright's Photomicrography.†—This handy little book is written in a clear and lucid style, and is intended to be a trustworthy guide to the beginner. Its style is expository, not scientific. Its object is not to discuss possible methods, but to explain the easiest, and, while some of the statements made need qualification, it has been thought best to do so rather than to perplex the beginner by diffuseness. The work is not intended to replace the regular text-books of the subject, but to supplement them. Some beautiful examples of photomicrography are given in the plates.

New Photographic Apparatus of the Paris School of Mines.‡ J. Boyer describes this apparatus, which was devised by H. Ragot, of the Geological Laboratory of the Sorbonne, for the reproduction of opaque and of transparent objects. It is also intended for photographing microscopic objects (fig. 15), but instead of moving the Microscope by means of a rack-and-pinion, focusing is effected by moving the object. The entire apparatus is attached to a rigid beam, and may be used in a horizontal or a vertical position. The object-holder rests on a carriage which is movable upon a second and larger carriage. The large carriage is moved rapidly by turning one of the wheels and long rods shown in the photograph, and the smaller carriage is moved slowly, with respect to the

* Zeitschr. wiss. Mikrosk., xxvii. (1910) pp. 265-71 (11 figs.).

† Wratten and Wainwright, Ltd., Croydon, 16 pp. (6 pls. and several figs.).

‡ Scientific American, ciii. (1910) p. 104 (2 figs.).

large one, by turning the other wheel and rod. A Zeiss planar lens of short focus is used for moderate enlargements, and a Microscope objective for enlargements on a greater scale. As the pitch of the screw threads which are cut on the long rods is only one-fifth inch, the focusing can be accomplished as easily and accurately as with a rack-and-pinion. The object is illuminated by a Nernst lamp of 120 candle-power, provided with condensing lenses. The part of the object which it is desired to photograph is brought into the field by means of a total reflection prism and a Microscope eye-piece attached to the camera, as the great length of the apparatus makes it impossible to move the object by hand while observing its image on the ground-glass screen. In addition to these

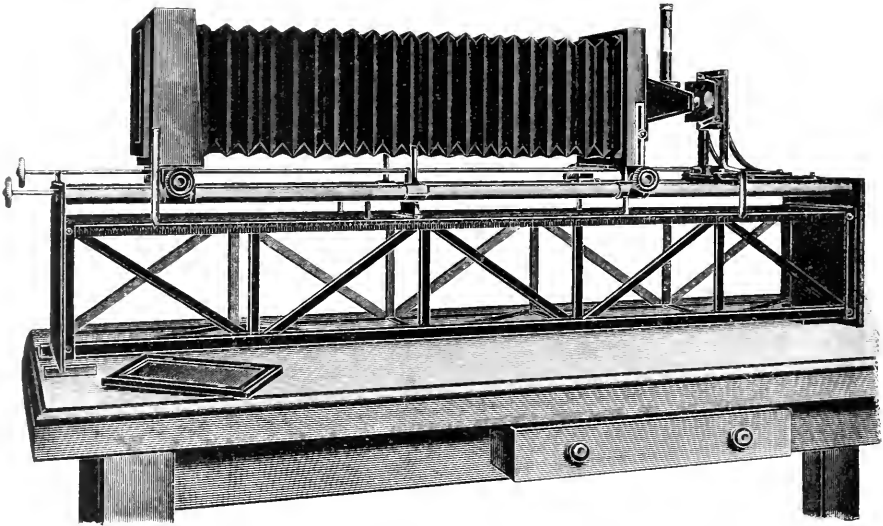

Fig. 15.

two forms of apparatus, the photographic laboratory of the School of Mines contains an excellent equipment, including two dark-rooms provided with all necessary apparatus, and a third and larger dark-room containing an enlarging camera and a paper-holder for the production of enlarged positives, 30 by 40 cm. (12 by 16 in.) in size. The camera and the paper-holder are mounted on a single frame, which is supported by springs on four light masonry columns. In consequence of this arrangement the tremors produced by the passage of railway trains and trolley-cars affect the negative, the lens, and the paper simultaneously and to the same degree, and therefore do not diminish the sharpness of the reproduction. Another enlarging camera, sliding on rails, and provided with a lens of 12 in. focus, is used for the reproduction of drawings, measuring 12 by 16 in. The same apparatus, with the addition of two arc-lamps and a series of screens, is employed for instructing the future engineer in the methods of photo-engraving.

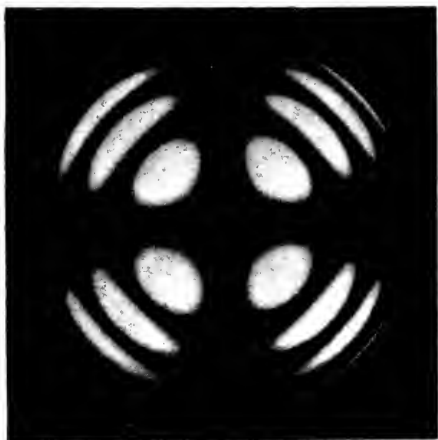

FIG. 1.



FIG. 2.

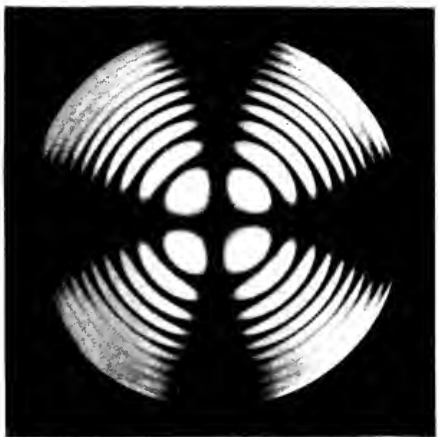

FIG. 3.

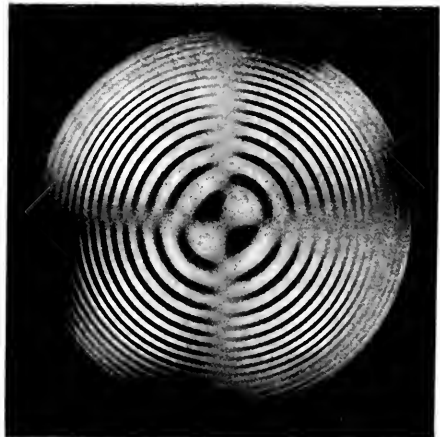

FIG. 4.

EDER, J. M.—*Jahrbuch für Photographie und Reproduktionstechnik.*

[The "Separat-abdruck" from the above summarizes with its usual completeness the most important progress made during the year.]

Halle: Wilhelm Knapp.

LINDER, P.—*Mikro-photographische Aufnahmen von lebenden Objekten in der Ruhe und in der Bewegung.*

Muschau, 1910, p. 787.

(5) *Microscopical Optics and Manipulation.*

Interference Phenomena in Polarized Light.*—These three volumes, by the late Hans Hauswaldt, together form the most complete black-and-white photographic record of polarization phenomena that has ever been produced, and which it is very unlikely will ever be surpassed. The work has been done with characteristic German thoroughness. Neither brains, time, nor money have been spared. This statement will be understood when it is remembered that the various crystal sections used were prepared by Steg and Reuter, the apparatus employed was made by Carl Zeiss, and the description of the same was written by Siedentopf, of ultra-microscope fame.

The first volume consists of some thirty-three full-sized autotypes showing the stauoscopic figures produced by plates of various thicknesses, and cut at different obliquities to the axis, in white and sodium light, of such typical uniaxial crystals as calc spar, nitrate of soda, apatite, zircon, quartz (including amethyst), and such biaxial crystals as arragonite, mica, gypsum, topaz, and sugar.

The illustration given shows one of these plates. Fig. 1, pl. III., is the figure given by a plate of apatite, cut normal to the axis of the crystal, in sodium light and between crossed nicols; whilst fig. 2, pl. III., shows the same plate combined with a quarter-wave mica, to show the test for negative crystals. Figs. 3 and 4, pl. III., show similarly the figures given by a plate of zircon—a positive crystal.

The second volume, containing eighty plates, is a very interesting one. It gives, in the first place, the different figures obtained in convergent sodium light—the N.A.'s employed being 0.636, 1.168, and 1.70—in such crystals as calc spar, topaz, gypsum, etc. These figures are followed by others showing the effect of using practically monochromatic lights of different wave-lengths in calc spar and brookite. The mica combinations of Rensch and Norrenberg, the spectrum analysis of the colours produced by double refraction, and the figures produced by various shapes of glass, stressed in different ways, are finally dealt with.

The third volume, of seventy-two plates, deals largely with the phenomena produced by circularly polarized light, twin crystals, etc.

Enough has been said to indicate the complete nature of the work done by Hauswaldt. This, as will be seen, is not so remarkable for the originality of the problem, attacked as it is for the thoroughness with which work so often attempted by others has been done. Indeed, until colour-photography becomes practical for this class of work, it would be labour in vain for anyone to attempt to rival the work of Hauswaldt.

* *Interferenz-Erscheinungen an doppeltbrechenden Krystallplatten im konvergenten polarisirten Licht.* By Dr. Hans Hauswaldt. Magdeburg, 1902 (33 pls.); Op. cit., 1904 (66 pls.); Op. cit., 1907 (80 pls.).

No first class text-book dealing with the subject is, in our opinion, likely to be published during the next half-century which does not draw upon these rich store-houses of illustrations.

(6) Miscellaneous.

Sensibility of the Eye to Variations of Wave-length in the Yellow Region of the Spectrum.*—From observations on his own vision, Rayleigh concludes that the distinction in colour of the two D lines can be perceived if favourably presented to the eye.

Quekett Microscopical Club.—The 470th Ordinary Meeting was held on January 24, the President, Professor E. A. Minchin, M.A. F.Z.S., in the Chair. From particulars supplied by Mr. F. J. Keeley, of Philadelphia, who possesses a mount labelled "*Naricula amicii*, Florence, Italy—from Professor Amici to C. A. Spencer." Mr. Nelson considers the much-disputed Amician test to be certainly identical with what he terms the "English *rhomboides*." † Mr. C. F. Rousselet, F.R.M.S., described and exhibited three new species of Rotifer. These are *Anuræopsis naricula* sp.n., from central Ceylon, a very small species, lorica $92\ \mu$; *Brachionus salanicus* sp. n., from Devil's Lake, North Dakota, U.S.A.; and *B. havaniensis* sp. n., from Illinois River, near Havana. Mr. R. T. Lewis, F.R.M.S., read a note "On the Larva of *Mantispa*." The differences between mature specimens of the Mantidae family and those of sub-family Mantispidæ are not very obvious to the casual observer. Perhaps the most noticeable difference is in the life-history of the larvæ of the two groups. In *Mantis*, on emerging the young insects closely resemble the adult form, except as to size, colour, and absence of wings. In *Mantispa* the emerging larvæ bear not the slightest resemblance to the perfect insect. They are only about 1 mm. in length; have two simple eyes; are armed with apparent mandibles; have 3-jointed antennæ and 7-jointed palpi; the six legs are of equal size, and are terminated by a hollow trumpet-shaped appendage instead of the usual claws. On leaving the egg the larva bores its way into the ovisac of a spider and feeds upon the eggs or young until the second ecdysis. In the subsequent stage it becomes a helpless, fleshy grub, and spins a cocoon. Emerging from this it begins to resemble the perfect insect, but has only rudimentary wings, and not until two more moults does it become a mature Neuropterous *Mantispa*. Mr. H. Gummery, of Acomb, York, exhibited a number of preparations for the Microscope, mostly botanical sections, and a series of lantern slides, mostly photomicrographs of various stages of nuclear division in *Lilium*. The Microscopes used were kindly lent by Messrs. C. Baker.

ABNEY, SIR W. DE W.—Colour-blindness and the Trichromatic Theory of Colour Vision. Parts i. and ii.

[Part i. treats of the relation of complete, and Part ii. of incomplete, colour-blindness to the trichromatic theory of colour vision.]

Proc. Roy. Soc., Series A, lxxxiii.—lxxxiv. (1910) pp. 462-74 and 449-64.

BLAKESLEY, T. H.—A Means of Measuring the Apparent Diameter of the Pupil of the Eye in very feeble Light. *Phil. Mag., Dec. 1910.*

* *Proc. Roy. Soc., Series A (1910) pp. 464-8.*

† See *Journ. Quekett Micr. Club, ser. 2, xi. (1910) p. 95.*

B. Technique.*

(1) Collecting Objects, including Culture Processes.

Cultivation of Human and Bovine Tubercle Bacilli. †—W. R. Park and C. Krumwiede, who have been investigating the relative importance of the bovine and human types of tubercle bacilli in the different forms of human tuberculosis, state that all cultures were isolated by means of the guinea-pig, and finding that egg-media were eminently successful, used them in the following two combinations: (1) Dorset's medium, the whole egg mixed with 10 p.c. water; (2) Lubenau's medium, 10 eggs mixed with 200 c.cm. of glycerin-bouillon. It was found that the human virus grew better from the start on the glycerin-egg medium, while the bovine variety was inhibited. They arrive at the following general conclusions: (1) All cultures growing luxuriantly on glycerin-egg from the start are of the human type. (2) All cultures growing sparsely (or even not at all) on glycerin-egg in the first few generations are of the bovine type.

Method of Isolating and Growing the Lepra Bacillus of Man. ‡ F. W. Twort started from the idea that, as there may be a close relationship between tubercle and leprosy, the leprosy bacillus might be cultivated on media to which tubercle bacilli had been added. Accordingly, pure cultivations of tubercle were obtained, and the bacilli were ground up with glycerin and saline, and having been steamed for half an hour were added to the yolk and white of new laid eggs in the following proportions: Eggs 75 parts, 8 p.c. sodium chloride 25 parts, tubercle bacilli 1 p.c., glycerin 5 p.c. or less. The medium was placed in test tubes, heated to 60° C. for 1 hour; on the following morning incubated at 38° C. for 6 hours, and again heated in a water bath at 60° C. for 1 hour, and set in slopes at 85° C.

The ericolized nasal discharge of a leper § was inoculated into this medium, the tubes being capped with rubber, and incubated at 38° C. After 24 hours the medium absorbed a quantity of the ericolin, so that the material was lifted off with a platinum loop and rubbed over fresh tubes. The bacilli grew and were subcultured in pure growth. The bacilli were fairly long-headed rods, and quite acid-fast. The growth at first was extremely slow, and only evident to the naked eye after about six weeks as a colourless film along the needle track.

Artificial Cultivation of Animal Tissues. ||—M. T. Burrows and A. Carrel give, in a series of communications, an account of their experiments, which show that portions of various animal tissues can be removed from their natural environment and cultivated in an artificial medium

* This subdivision contains (1) Collecting Objects, including Culture Processes; (2) Preparing Objects; (3) Cutting, including Embedding and Microtomes; (4) Staining and Injecting; (5) Mounting, including slides, preservation fluids, etc.; (6) Miscellaneous.

† Centralbl. Bakt., 1te Abt. Ref., xlvii. (1910) pp. 673-80.

‡ Proc. Roy. Soc., lxxxiii. (1910) pp. 156-8.

§ For the Eriocolin method see this Journal, 1909, p. 526.

|| C.R. Soc. Biol. Paris, lxi. (1910) pp. 291-4, 298-301, 328-34, 365-8.

at 39° C. This medium is composed of plasma derived from the animal or the parent of the animal, from which the culture material is to be obtained, but no particulars of its preparation are given.

In the first communication, Burrows describes his experiments with chick embryos. The myosomes, neural tube, heart and epithelium were dissected upon the warm stage of a binocular Microscope at a temperature of 39° C. The tissues were then kept in plasma in a sealed chamber at this temperature. Mesenchymatous cells began to grow and multiply after an interval of 2 to 12 hours. Long nerve-fibres developed in 3 or 4 hours. The heart continued to beat for 8 hours, and from portions of exposed surface of heart-muscle grew mesenchymatous cells and muscular cells which contracted at the same rhythm as that of the adjoining heart. From the central nervous system cultivations were also made, which grew more slowly.

Further communications deal with the cultivation of adult tissues. The authors have been successful in obtaining growth with artificial cultures of conjunctiva, cartilage, bone-marrow, peritoneum, vascular endothelium, kidney, thyroid, suprarenal, ovary, and lymphatic glands. The abundance and rapidity of growth vary according to the nature of the tissue, the age of the animal, and a number of other factors. The material was obtained from dogs and cats. In cultivations of thyroid from a kitten a few hours old, growth was observed within 12 hours. Cartilage, conjunctiva, and peritoneum grew more slowly. The beginnings of growth were marked by the appearance of fine granulations at the periphery and upon the upper surface. Each organ produced two types of cell—the connective-tissue cell and the differentiated cell. Detailed accounts are given of the cultivation of renal tissue, spleen, and bone-marrow. With the thyroid gland, the authors have succeeded in producing secondary and tertiary subcultures.

Further, from sarcoma in the chick and in man, cultures have been obtained. These grow even more rapidly than normal tissues in artificial culture. By means of continuous observations, the process of multiplication of sarcoma cells *in vitro* has been observed.

J. Jolly,* criticising the above research, considers that the authors have only demonstrated the survival of animal tissues, a phenomenon already established by previous researches. He is doubtful as to whether any true cultures have been obtained, and even regards some of the phenomena described as in reality necrobiotic changes.

Modified Method of Isolating Typhoid and Paratyphoid Bacilli.† O. Mayer has made extensive use of a modification of the Lentz-Tietz method. Six loopfuls of the faeces to be investigated were spread on a malachite green agar plate, and then the same glass spreader was rubbed over three large plates of lactose-litmus-agar or fuchsine-agar. The malachite green plate was incubated for 24 hours at 37°, the other plates for 48 hours at 30° C. After this incubation, the growth upon the malachite green plate was washed off with a small quantity of saline. This emulsion was allowed to stand for five minutes, and then one loopful was

* C.R. Soc. Biol. Paris, lxi. (1910), pp. 470-3.

† *Centralbl. Bakt.*, 1^{te} Abt. Orig., lvi. (1910) pp. 552-75.

plated upon lactose-litmus-agar or upon fuchsin-agar. The author found that these organisms were often recovered from the malachite green plate by this means, when a negative result was obtained from the plates directly inoculated. He emphasized two points: firstly, that the emulsion on the malachite green plate should not be shaken, as this permits less motile and less easily detached organisms to be taken up; and, secondly, that the malachite green (Höchst 120) should be fresh or kept in an ice chest.

The author concludes that this method is a necessary adjunct to the method of simple plating, and gives a better chance of finding the organisms when they are scarce. The greater the bulk of faeces plated, the more valuable the results obtained.

New Method for Differentiation of Bacteria.*—L. S. Dudgeon, D. N. Panton, and H. A. F. Wilson have made a series of observations upon the influence of bacterial extracts upon phagocytosis. These extracts were prepared by freezing and thawing alternately thick bacterial pastes, so that the organisms became disintegrated. By dividing phagocytosis experiments into stages and, in the first place, incubating extract and leucocytes, extract and bacteria, or extract and serum, and then adding the third component and again incubating, it was shown that the specific action of the extract was upon the serum; but it was also found that this action was not directly related to absorption of complement. The diagnostic value rests upon the observation that an extract will remove from a serum with which it has been incubated almost all the homologous opsonin. Thus if serum after incubation with typhoid extract be added to leucocytes and typhoid bacilli and incubated, no phagocytosis will occur; while, on the other hand, phagocytosis of another organism, such as *Bacillus achard*, is not much diminished.

Rapid Method of Identifying *Bacillus coli*.†—F. Domergue and R. Legendres give an account of their method for determining the presence of this organism in samples of water or shellfish. Tubes of nutrient broth are prepared, and, after sterilization, there are added to each tube fifteen drops of a solution containing 0.5 p.c. of neutral red and 5 p.c. of phenol. The tube is then inoculated with material, and placed within a large thick glass tube containing a few cubic centimetres of water and tablets of caustic soda and pyrogallie acid. The outer tube is now hermetically sealed, and in a few moments oxygen and carbon-dioxide are completely absorbed. After incubation at 42° C. for 24 or 48 hours the culture is examined, and the presence of *Bacillus coli* is indicated by the canary-yellow colour of the medium, green fluorescence, and the production on the surface of gas-bubbles. The high incubation temperature and the anaerobiosis are important agencies for the selection of *B. coli*.

(2) Preparing Objects.

Examining the Salivary Glands of Ticks.‡—M. Elmassian dissected out the salivary glands in saline water by Christophers' method and then

* Proc. Roy. Soc., lxxxiii. B (1910) pp. 33-7.

† Comptes Rendus, cli. (1910) pp. 1401-3.

‡ Arch. Zool. Expér. et Gén., xlv. (1910) pp. 379-419 (2 pls.).

fixed them. The most satisfactory fixative was Orth's liquid, to which a little acetic acid was added. Paraffin sections were stained with Heidenhain's iron-haematoxylin, Delafield's haematoxylin (3 p.c. in H_2O) for 24 hours and then differentiated with absolute alcohol. The methods of Benda and of Mann were also used, as well as the well-known toluidin-blue and orange G; the action of the latter is uncertain.

Methods of Studying Rotifera.*—G. Hirschfelder gives an account of the technique employed in a study of this class. The examination of living specimens was facilitated by the use of a 1 : 50,000 neutral red solution. The animal, in a drop of this fluid, was placed on a slide, and a coverslip with wax feet laid over it. Sufficient pressure was applied to the slip to immobilise the animal without destroying it.

In order to obtain satisfactory dead specimens, it is necessary, in the first place, so to narcotise the animal that it dies fully expanded. The object is put in a vessel containing 1.5 c.c. of water, and to this are added two or three drops of a cocaine solution. Rousset's mixture—cocaine hydrochloride, 2 p.c., 3 parts; alcohol, 90 p.c., 1 part; water, 6 parts—is a very suitable solution. Care should be taken not to shake the specimen. After about a quarter of an hour, the creature comes to rest, and a drop of 1 p.c. osmic acid is added. Ten minutes later the specimen is transferred to distilled water; it is left in distilled water about five hours, and then transferred to 2 p.c. formalin. The whole specimen may be mounted without further treatment between two slips separated by wax feet, the margins being sealed with paraffin.

For sections, the narcotised animal may be treated with a mixture of picric and chromic acids, followed by warm water and rising alcohols. Ehrlich's haematoxylin followed by orange G form the best staining system. Picric and acetic acids may also be used as fixing fluid.

Method of Studying Phagocytosis of Erythrocytes by Endothelial Cells †—W. O. Meek obtained endothelial cells from ascitic fluid from cases of hepatic cirrhosis. The fluid was passed straight from the siphoning tube in the sterile normal saline containing 0.85 p.c. of sodium citrate. The cells obtained by centrifugalizing were washed in normal saline, the mass of cells being gently broken up between each washing with a platinum wire. A suitable emulsion in saline was then prepared. The cells were used as soon as possible after removal from the body.

The erythrocytes employed consisted of 1.0 p.c. suspensions in normal saline of washed red cells from a normal man and various patients. The sera were obtained from normal persons and from a number of hospital patients.

Serum, erythrocytes, and endothelial cells were mixed in small lengths of glass tubing sealed at one end. The open end was plugged with sealing-wax, and the tubes incubated in a vertical position at 37° C. for 30 minutes. The erythrocytes and cells then fall to the bottom of the column, and a film is made containing a minimum of fluid. The Microscope was used to ascertain whether agglutination of red cells had occurred.

* Zeitschr. wiss. Zool., xcvi. (1910) pp. 211–17.

† Lancet, 1910, ii. p. 1267.

Simple Shaker.*—K. Poppe describes a new type of shaker, worked by a water turbine (fig. 16). The rockers *a b*, *a' b'*, which work round the axes *a*, *a'*, support a carriage, the base of which is hinged to a connecting rod attached eccentrically to the revolving wheel. On the platform *c* can be placed a tray (not illustrated) for carrying test-tubes horizontally. The upper stage, for carrying flasks, is attached by means

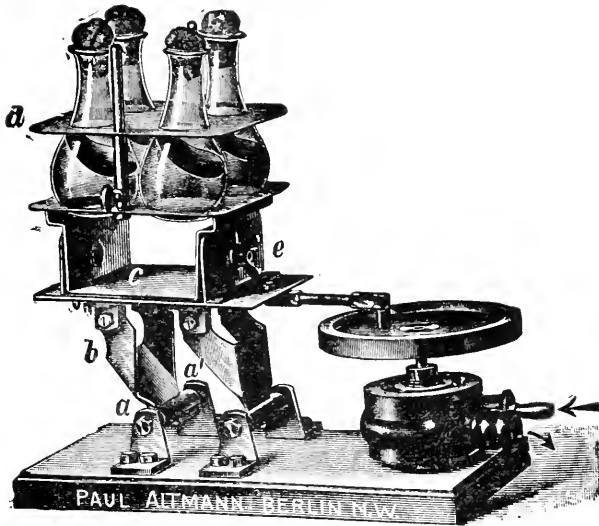

FIG. 16.

of wing screws. The flasks are kept in position by means of a movable plate *d*. The whole apparatus is small enough to go into a medium-sized incubator.

Fixation and Embedding of Embryological Material.†—H. Schridde, from a long experience, finds that Orth's mixture of Müller's fluid and formalin (9 : 1) is the best fixative for the purpose. The fluid should be warm. Small objects should remain at a temperature of 36° in the mixture for 4 to 6 hours. Large specimens require from 12 to 24 hours. On removal the preparations are placed in running water for from 3 to 12 hours, and then transferred to 50 p.c. alcohol. When required for embedding they are passed through up-graded alcohols to absolute alcohol, after which they are transferred to cedar-wood oil, wherein they remain until they are quite clear. After this the preparations are immersed in xylol or toluol for 20 to 30 minutes, according to size. This procedure is followed by paraffin m.p. 42°–44°: small objects 15 to 30 minutes, the larger one, 30 to 60 minutes. After this they are transferred to paraffin m.p. 54°–56°, in which they remain for $\frac{3}{4}$ to 1 hour. For large objects an intermediate

* Centralbl. Bakt., 1te Abt., Orig., lv. (1910) pp. 527–8.

† Zeitschr. wiss. Mikrosk., xxvii. (1910) pp. 360–5.

stage with paraffin m.p. 48° - 50° is advisable. The objects are embedded in a metal frame placed on a warm glass plate, and when the surface of the paraffin is set the plate is at once placed in cold water.

Poso, P.—*Über Fixierung und Einbettung von Placenta und Uterus des Menschen.*
Zeitschr. wiss Mikrosk., xxvii. (1910) pp. 353-9.

(3) Cutting, including Embedding and Microtomes.

Apparatus for Rolling Wax Plates.*—O. Berner describes an apparatus (fig. 17) by means of which wax plates of any required thickness can be rolled for reconstruction work. It consists of an iron plate, a heater, a steel roller, and a special heater for the roller. The iron plate, of which the dimensions are 60×40 cm., is supported upon

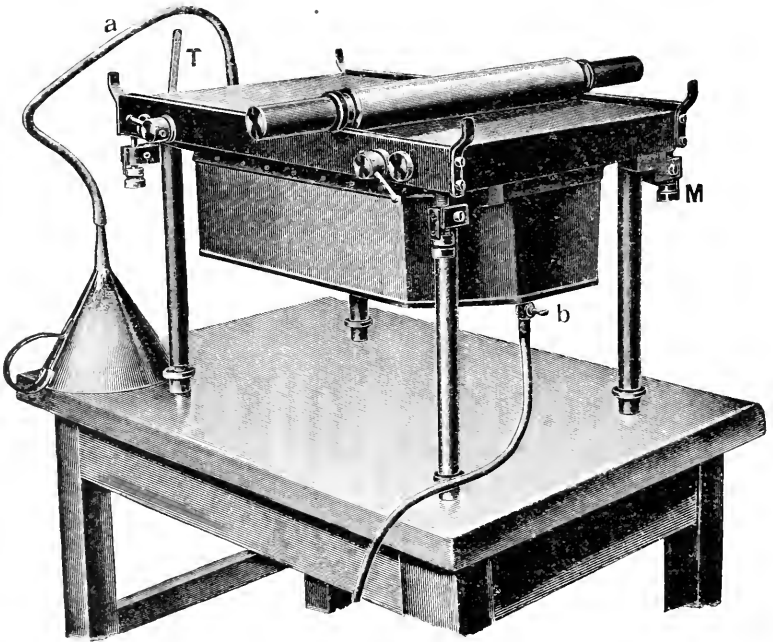

FIG. 17.

four metal feet, provided with screws for adjusting the level. This plate carries the wax. Along the long sides of the plate are guide-ridges, along which the rolling-pin travels. Screws, M, adjust the height of these guide-ridges, and so determine the thickness of the plate. Underneath the plate is a copper water-vessel, provided with a thermometer, T. This vessel is heated by a Bunsen burner; it is filled through the tube *a*, emptied through the tube *b*. The rolling-pin is a solid steel

* *Zeitschr. wiss. Mikrosk.*, xxvii. (1910) pp. 44-7.

bar, grooved to fit the guide-flanges. It is raised to the required temperature by means of the heater shown in fig. 18. Before-use, the plate is moistened with turpentine. The most convenient temperatures are about 52° C. for the plate, and 100° C. for the roller.

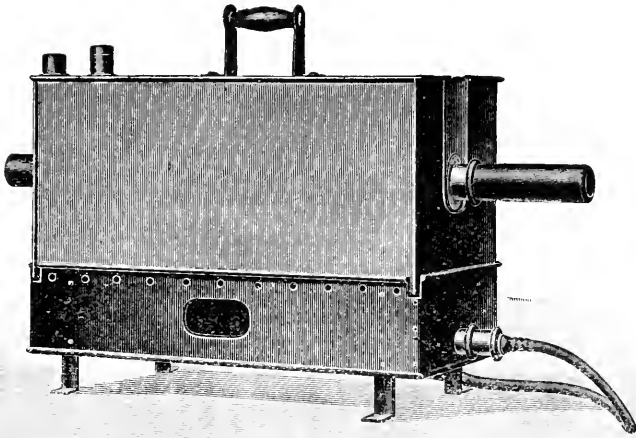

FIG. 18.

Manipulation of Paraffin Sections.*—J. T. Wilson hastens the setting of paraffin blocks by using a metal plate on the floor of the embedding chamber, and placing this on a freezing microtome.

For floating out paraffin sections placed on top of the water-bath he employs a mercury surface as an artificial horizon. On the top of the bath is placed a shallow glass tray filled to a depth of 6 or 7 mm. with mercury. On this surface the slides may be placed until the sections are completely flattened.

For celloidin-paraffin sections a much deeper tray or box is required; this is covered with an accurately fitting lid. When the slides are placed on the mercury surface a small pledget of cotton-wool soaked in ether is placed in one corner, and then the lid is put on.

For passing blocks of tissue through various fluids he uses short segments of wide glass tubing 18 to 30 mm. in diameter; one end is closed with mosquito netting, or some fine material, while the other is plugged with a perforated cork; the cork must be bulky enough to float the whole in the fluid.

Tetrandler Microtome.†—P. Mayer describes this instrument, which owes its name to the number of persons who co-operated in the design.

* Zeitschr. wiss. Mikrosk., xxvii. (1910) pp. 232-4.

† Tom. cit., pp. 52-62.

In principle it is a sliding microtome, in which the object moves and the razor remains stationary. The razor is held firmly in a massive metal

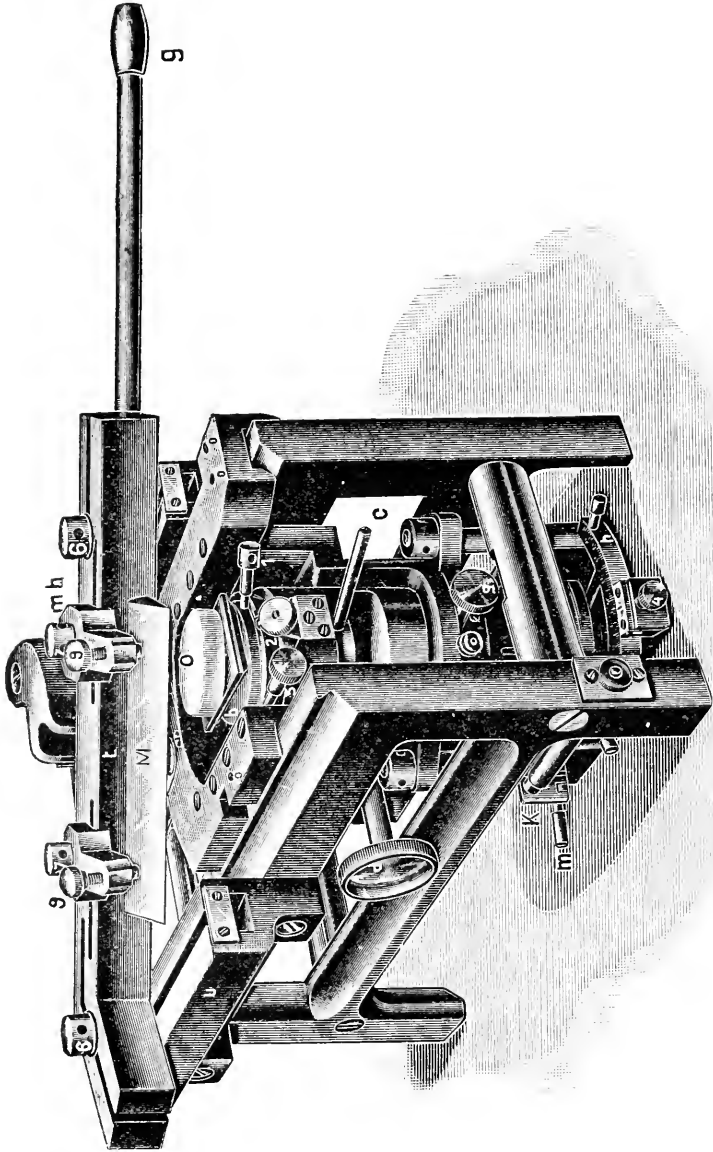

Fig. 19.

bar, upon which, as can be seen in the diagram, there are a number of screws for controlling the inclination and adjustments of the cutting

edge. Figs. 19 and 20 illustrate two models, which differ principally in the design of this mechanism for holding the razor. The movement to and fro of the microtome-stage is controlled by the lever *g*. The

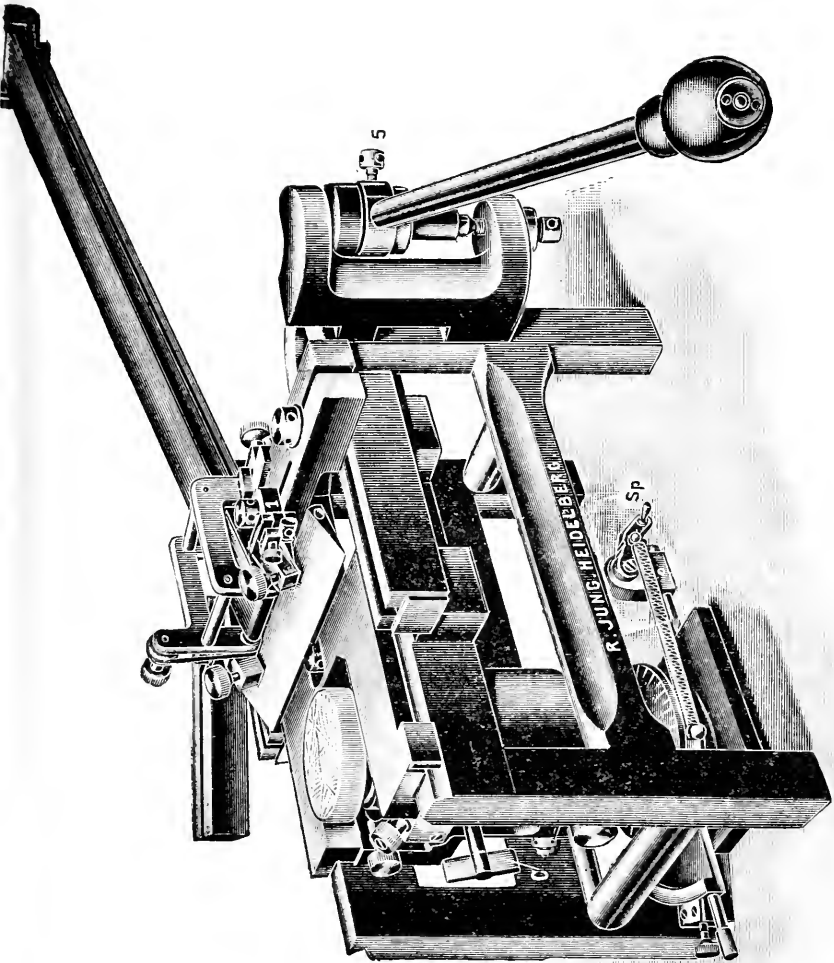

FIG. 20.

thickness of sections is determined by the adjustment of the lever *h*, which can be moved along the index shown in the lower part of fig. 19. The substage mechanism also allows of free movement of the stage up and down, so as to bring the block into the proper position for cutting.

New Method of making Celloidin Serial Sections.*—F. Maier cuts celloidin sections under 75 p.c. alcohol and transfers them to slides; there should be a margin of celloidin outside the tissue of from 0.25 to 0.5 cm. The sections are pressed firmly down on the slide with blotting paper. Over the series is poured a mixture of oil of cloves 1 part, and absolute alcohol 9 parts; this is allowed to remain until the celloidin is soft, i.e. from 15 to 30 seconds; the superfluous fluid is poured off, and then the slide is laid flat for a while in order to let the sections get fixed. Then a mixture of ether and alcohol is poured over the series in order to remove all traces of oil of cloves; this is removed by evaporation merely. After 15 to 30 seconds sulphide of carbon is poured over the series and allowed to act for 10 to 15 minutes. All traces of the carbon sulphide are removed by means of 96 p.c. alcohol changed more than once. After this, down-graded alcohols to water, in order that staining, etc., may be carried out in the usual way.

The object of this technique is to make sections of any thickness stick to the slide.

Utilizing Organized Structures as Directing Marks for Plastic Reconstruction.†—J. T. Wilson described over ten years ago‡ a system for obtaining directing marks in microscopical sections for the purposes of plastic reconstruction. In his new system he still builds up an embedding chamber on a base-plate, but has discarded the Naples bars, and has adopted an apparatus the dimensions of the component parts of which may be varied as desired.

The base of the embedding chamber is formed by a brass plate *a* (figs. 21 and 22), through which are bored two pairs of cylindrical holes *b*, each about 3 mm. in diameter. The ends of the embedding chamber are formed by rectangular brass plates *c*, set up upon the base-plate; they are held in position by projecting dowel pins *d*, which fit into the holes in the base-plate. The lower end of each end-plate is provided with two socket holes *e*. These fit over two pins *f*, which project 2 to 3 mm. up from the base-plate. The calibre of the pins is 1 mm. or less, and the distance between them must be exactly the same at either end, 2 to 3 mm.

In order to carry out the nerve-strand method of embedding, a filament is gently stretched around the two pairs of pins, and the filament must be taut but not strained. The loose ends should be crossed on the plate at one end and held there in position, while the corresponding end-plate is placed in position and its dowel pins firmly pressed home; the nerve-filament is thus securely clamped. The second end-plate is similarly treated. This done it will be found that the two parallel nerve-filaments are in contact with the surface of the base-plate. Two pieces of wire (common pins decapitated) are inserted between the surface of the base-plate and the nerve-strands, close to the end-plates. The embedding chamber is then completed by the addition of the special side-

* München. med. Wochenschr., lvii. (1910) pp. 637-8, through Zeitschr. wiss. Mikrosk., xxvii. (1910) pp. 385-7.

† Zeitschr. wiss. Mikrosk., xxvii. (1910) pp. 227-32 (2 figs.).

‡ See this Journal, 1900, p. 735.

walls *g*; the sloping sides tend to minimize the pitting of the paraffin block.

An alternate method of utilizing organized structures so as to provide directing marks in paraffin blocks is as follows :—A glass plate is smeared evenly with a minimum of glycerin. A slab of bulk-stained tissue some 50 microns thick is deposited on the plate, some water is run under it,

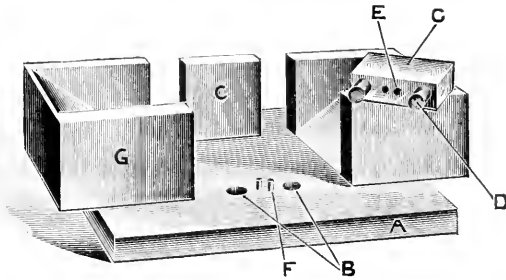

FIG. 21.

and the plate is gently heated; the water is drained off and the section allowed to dry on. When required for reconstructive purposes, embedding bars are set up on the plate, the paraffin section forming the floor. The object is then embedded in the usual way, so that eventually a block

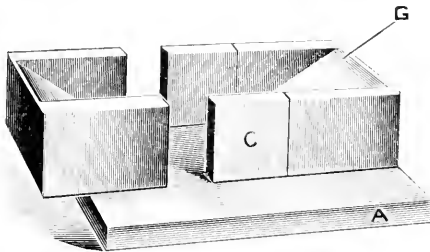

FIG. 22.

with one covered surface is obtained. This face is then grooved with a "Ritzler." No further treatment is required, and the block is cut in the usual way, taking precautions to ensure that the grooves made by the "Ritzler" shall be perpendicular to the cutting plane.

(4) Staining and Injecting.

Distinguishing Dead from Living Leucocytes.*—C. Achard finds that when leucocytes are treated with neutral red, the living are uncoloured or contain red-stained and intra-protoplasmic vacuoles or granulations; the nuclei of dead leucocytes stain red-brown, and there is no intra-protoplasmic coloration. Two solutions are used, one is normal saline with 6 per 1000 citrate of sodium, another is normal

* Brit. Med. Journ. (1910) ii. p. 1416.

saline with 1 per 1000 neutral red. Ten drops of each solution are mixed in a tube, and then 1 drop of blood, or 1-4 drops of the sediment of a centrifuged exudate. The tube is incubated at 37° for 20 minutes, and then the liquid is examined in a glass cell and the living and dead leucocytes separately enumerated.

New Method of Demonstrating *Spirochæta pallida*.*—J. T. Lenartowicz and K. Potrzobowski give the following procedure: Perfectly clean slides are exposed to the vapour of $\frac{1}{2}$ -2 p.c. osmic acid for 5 seconds; the vaporized side is then covered with a smear of the material to be examined; the smear is at once fixed for 10 to 20 seconds with osmic acid vapour, and when quite dry is stained for $\frac{1}{4}$ to 1 minute with the Ziehl-Neelsen carbol-fuchsin tubercle stain. This done, the preparation is washed with water, dried and examined under an oil-immersion. It is important to notice that the exposure to the osmic acid vapour should not exceed the time given above. In successful preparations the ground is stained red, and upon this *Spirochæta pallida* stands out as an unstained appearance; other bodies, such as *S. refringens*, red corpuscles and bacteria, stain well; hence, according to the authors, this procedure not only facilitates the search for *S. pallida*, but also serves for a differential diagnosis. The method is also useful for detecting flagella.

Use of Picramic Acid for Staining.†—A. Fröhlich, after alluding to the ill qualities of picric acid, recommends as substitute picramic acid, and gives the following procedure: (1) Stain in hæmalum, wash in tap water, or in faintly ammoniacal distilled water until blue. Transfer to saturated alcoholic solution of picramic acid for 3 to 5 minutes or longer. Wash quickly in absolute alcohol. Next immerse in saturated alcoholic solution of chromotrop 2 R or 6 B (Höchst) for $\frac{1}{2}$ to 2 minutes until the sections begin to turn red. Lastly, a short wash in absolute alcohol, xylol-alcohol, xylol-balsam.

Combined Staining Methods for Tubercle bacilli.‡—S. Hatano gives two methods for the better staining of tubercle bacilli: (1) Stain with warm carbol-fuchsin for 5 minutes; wash; 25 p.c. sulphuric acid for 10 to 30 seconds; 75 p.c. alcohol until all the colour has disappeared. Stain with methylen-blue solution for 2 minutes and wash. Then Gram's stain. In the second method the procedure is reversed.

Staining in bulk with Hæmatoxylin.§—C. Morel and Bassal fix in a mixture the following solutions: A. Bichromate of potassium 2, water 100. B. Formol 10, acetic acid 10, water 80, for 8 to 20 hours. The pieces are thoroughly washed in running water for 24 hours, and then immersed for 1 day in 95 p.c. alcohol. The pieces are then placed in a freshly made mixture of the two following solutions: I. Hæmatoxylin 1 gm., 95 p.c. alcohol 100 c.c.m. II. Perchloride of iron 2 c.c.m.; hydro-

* Centralbl. Bakt., lvi. (1910) pp. 186-91 (1 fig.).

† Zeitschr. wiss. Mikrosk., xxvii. (1910) pp. 549-52.

‡ Berlin Klin. Wochenschr., xlvi. (1909) pp. 1694-5, through Zeitschr. wiss. Mikrosk., xxvii. (1910) p. 313.

§ Journ. Anat. et Physiol., xlv. (1909) pp. 632-3.

chloric acid 1 c.cm.; 4 p.c. aqueous solution of copper acetate 1 c.cm.; water 95 c.cm. After an immersion of from 24 to 48 hours the pieces are removed to a mixture of equal parts of alcohol and distilled, and, if necessary, afterwards to running water. Dehydration in absolute alcohol (24 hours); acetone 24 hours; paraffin 6 to 8 hours. Sections are stuck on with 0.1 p.c. gelatin with a few drops of formalin added.

Staining the Internal Network in Nerve-cells.*—R. Collin and M. Lucien fixed the material in the following mixture: 20 p.c. formalin 30; 1 p.c. solution of arsenious acid 30; 96 p.c. alcohol 30. After 6 to 8 hours the pieces are transferred to $\frac{1}{2}$ p.c. silver nitrate solution for 13 hours to a few days. After a wash in distilled water they are immersed in the following mixture: hydroquinone 20, anhydrous sulphate of sodium 5, formalin 50, distilled water 1000. The pieces are next washed, hardened, and embedded preferably in celloidin. The sections are then gold-stained by means of the following solutions, mixed immediately before use. A. Hyposulphite of sodium 30, ammonium sulphocyanate 30, distilled water 1000. B. Gold chloride 1, distilled water 100. In this the sections remain until they assume a grey hue. Though the following steps are not indispensable, they bring out the network better. After washing in distilled water the sections are treated with the following mixture: potassium permanganate 0.5, sulphuric acid 1, distilled water 1000. Then wash thoroughly in 1 p.c. oxalic acid and afterwards in distilled water. Stain in carnalium, wash, dehydrate, and clear up.

New Methods of Demonstrating Plasmodes.†—S. Bálint fixed the material in 2 p.c. formalin and then cut sections, which were preserved, while awaiting further treatment, in 4 p.c. formalin. The sections are stained with an iodine solution made by dissolving the iodine in 2 p.c. formalin and then adding 25 p.c. sulphuric acid. While the sections are staining, a few drops of 4 p.c. formalin, saturated with iodine, are added: staining is completed in from 2 to 3 hours. The preparation may be mounted in glycerin or balsam, but unfortunately the finer details do not last longer than six months. Another method which gives good results consists in staining sections, which have been fixed in formalin and preserved in alcohol, or subsequently further fixed with aqueous or alcoholic sublimate, with the following solution: anilin oil 3 c.cm., acid-fuchsin 20 gm., H_2O 200 c.cm. After treatment with the staining solution for 10 to 20 minutes, they are washed out with a saturated alcoholic solution of picric acid, which has been diluted with 100 c.cm. distilled water to every 50 c.cm. Then follow 96 p.c. alcohol, benzol-alcohol, benzol (in each of which a little picric acid is dissolved), benzol-balsam.

Staining Celloidin Sections of Nervous Tissue by the Iron-hæmatoxylin Method.‡—Marie Loyez fixes the material in 10 p.c. formalin for eight days or longer; the pieces are carried through in the

* C.R. Assoc. Anatomistes, 1909, pp. 238-44 (7 figs.), through Zeitschr. wiss. Mikrosk., xxvii. (1910) pp. 294-5.

† Zeitschr. wiss. Mikrosk., xxxii. (1910) pp. 243-5.

‡ C.R. Soc. Biol. Paris, lxi. (1910) pp. 311-13.

usual way, and the celloidin sections are treated as follows. They are first mordanted with 4 p.c. iron-alum for 24 hours, and then rapidly washed. Next they are stained with Weigert's hæmatoxylin (hæmatoxylin 1 gm., alcohol 10 c.cm., water 90 c.cm., saturated solution of lithium carbonate 2 c.cm.), for 24 hours: the staining at 37° in an incubator is advisable, but not indispensable. After a wash in water the sections are differentiated in two stages: first with 4 p.c. iron-alum until the grey substance begins to clear up, and then, after a careful washing, in Weigert's solution (borax 2 p.c., ferricyanide of potassium 2.5 p.c.). They are next washed in ammonia water, and after this washed again in water for a long time: finally they are passed through ascending alcohols to xylol and balsam.

J. Nageotte* remarks that staining the celloidin sections with hæmatein, and decolorizing with the ferricyanide solution, gives results equally good.

Staining the Medullary Sheath in Brain-sections.†—E. Pötter cuts sections of brain which have been fixed in 10 p.c. formalin, with the Reichert large microtome. The sections, about 15 mm. thick, are then placed in Weigert's fluorchrom-copper mordanting fluid for 14 days at room temperature. They are then dehydrated in upgraded alcohols (70°, 80°, 96°, 100°, 2 days each). Next ether-alcohol (āā) for 2 days, as a preparatory for thin celloidin (2 days); this is followed by celloidin of syrupy consistence. To render the thick celloidin more suitable for sectioning it is advised to add 4 drops of cedar-wood oil to every 20 c.cm. The celloidin is then allowed to inspissate, and when sufficiently thickened the material is cut into blocks and preserved in 70 p.c. alcohol. The sections are made with an immersion-microtome, and preserved, if necessary, in 70 p.c. alcohol; when required for staining they are placed between two sheets of acid-free tissue paper. They are then immersed in Weigert's iron stain without the hydrochloric acid for 2½ to 3 hours. On removal they are treated with Lustgarten's fluid, which makes the cortex assume a dark-brown hue, the medullary sheaths being black. After this the sections are further differentiated with borax 2, ferricyanide of potash 2, H₂O 100, until they assume a yellowish tinge. This is followed by washing for several days in frequently changed water. Then dehydration in upgraded alcohols, carbol-xylol, balsam.

(5) **Mounting, including Slides, Preservative Fluids, etc.**

Method of Preserving Plague Material.‡—C. Broquet finds that if the viscera of animals affected with or dead of plague be preserved in 20 p.c. glycerin the virus will retain its activity for 8 or 9 days, while the addition of 2 p.c. carbonate of lime gives still more satisfactory results.

Bentley-Taylor Method of Mounting Mosquitos.§—This method is extremely simple and rapid. Twelve specimens can be mounted in

* C.R. Soc. Biol. Paris, pp. 517-19.

† Zeitschr. wiss. Mikrosk., xxvii. (1910) pp. 238-42 (1 fig.).

‡ Ann. Inst. Pasteur, xxiv. (1910) pp. 888-94.

§ Proc. Roy. Soc. Med., iv. (1910) med. sect., pp. 41-2.

about 24 minutes, and few or none are ever spoiled in the process, which is as follows:—1. Prepare a solution of 1 p.c. celloidin in absolute alcohol. 2. A solution of celloidin (5 p.c.) in absolute alcohol of the consistence known as “thick” in ordinary histological work. It is essential that no ether be employed in the solution, as it makes the scales transparent. 3. Catch the mosquito. 4. Chloroform it. 5. When dead or narcotized, place a drop of solution No. 1—thin celloidin—on a cover-glass. 6. Place the insect back downwards on the cover-glass. In the majority of cases wings and legs spread themselves out in the orthodox exhibition position. If they do not do so the solution remains fluid sufficiently long in Bombay at a temperature of 85° F. to 90° F. for from 3 to 5 minutes to permit them to be adjusted with a needle. 7. When the thin solution has become “tacky,” to use the language of the motorist—i.e., in about 8 or 10 minutes from the commencement of operations—place a drop of the thick solution, No. 2, over the insect. 8. Invert the cover-glass over a hollowed slide, to which it may be fixed by a ring of balsam. The specimen is now complete, and in this condition both ventral and dorsal surfaces can be examined under the Microscope.

If it be thought desirable to employ a white background, instead of manœuvre 8 proceed thus:—*8a.* Suspend some oxide of zinc in ordinary mounting Canada balsam. Shake or stir well immediately before using; fill the cell or hollow of the slide with this emulsion; invert the cover-glass with the mosquito, and press rather firmly into the emulsion. 9. Clean off any of the emulsion that spreads beyond the edge of the cover. Specimens prepared by this latter method will, of course, display only one surface.

Celloidin in Microscopical Technique.*—L. Neumayer has found that celluloid in plate form may be found useful as slides or coverslips. The best material is practically as transparent as glass, and can be obtained in any size and thickness. In this connexion it may be recalled that mica and gelatin have also been used instead of glass. The inflammability of celluloid must be taken into consideration; in other respects it seems that celluloid is a convenient substitute for vitreous plates.

Microscopical Examination of Foods and Drugs.—This work, by H. G. Greenish,† is a practical introduction to the method adopted in the microscopical examination of foods and drugs in the entire, crushed and powdered states. It has deservedly reached a second edition.‡ Its principal features remain unaltered, though certain revisions and additions have been made. Among these may be mentioned the chapter on fibres, saffron, liquorice, calumba, etc. A chapter has been added on the more commonly occurring adulterants of powdered foods and drugs. A new section consists of a general scheme of examination which will be found specially useful in the investigation of an unknown powder.

Drop-bottle for Preventing the Action of Air on Copper-oxide-ammonia Solution.§—G. Herzog describes a drop-bottle which he has

* Zeitschr. wiss. Mikrosk., xxvii. (1910) pp. 234–8.

† London: J. and A. Churchill, 1910, xvii. and 386 pp. (209 illus.).

‡ See this Journal, 1903, p. 561.

§ Zeitschr. wiss. Mikrosk., xxvii. (1910) pp. 272–4 (1 fig.).

devised for keeping copper-oxide-ammonia solution from the action of air. This reagent, so important in testing the fibres of hemp and flax, rapidly deteriorates, and under ordinary conditions is not permanent for long. The bottle is made of brown glass, and, as will be seen in the illustration (fig. 23), the neck is closed by a caoutchouc plug, in which are two holes for the passage of glass tubes; one of these dips into the ammoniated copper solution, the other just ends below the stopper, its outer extremity being fitted with a teat having a small perforation. The

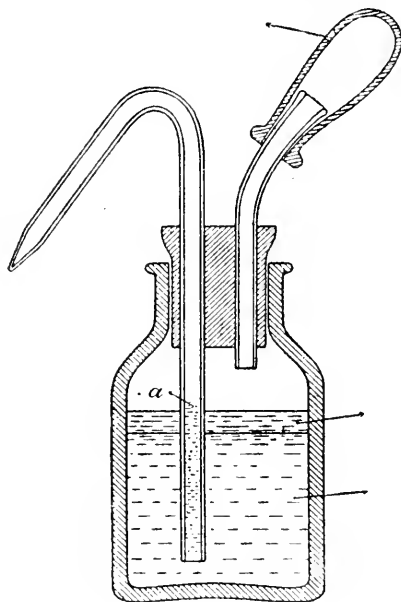

FIG. 23.

copper solution is covered with a layer of paraffin oil. The same device is used for several purposes in laboratories, but has not been exploited for this special purpose before.

Simple Arrangement for Determining the Sinking-velocity of Plankton Organisms.*—F. Krause was led to contrive his apparatus by desire of pursuing the following investigations: "What influence has body-form and body-magnitude of plankton-organisms on their sinking-velocity? How is the velocity of the same individual affected by the viscosity of the medium? How are such results affected by various temperatures in the same water?" His apparatus consists of two parts—a receptacle for the organism, and an observation instrument. The receptacle is formed out of a rectangular metal plate 65 mm. long, 35 mm. broad, and 2.5 mm. thick, whose middle part is cut away so as to leave a rectangular notch 45 mm. long and 6 mm.

* Zeitschr. wiss. Mikrosk., xxvii. (1910) pp. 347-9 (2 figs.).

broad. There is an arrangement for closing the front of the notch by a large cover-glass, and the back is closed by a milk-glass scale, e.g. a fragment of an old thermometer-scale. The notch thus forms a trough of suitable shape, and its metal surroundings, being pivoted by two screws on a suitable frame, materially assist in procuring a perpendicular position, to which a circular level contributes. This frame is prolonged into a tripod foot, and can be raised or lowered. The observation part of the apparatus is one of Zeiss' Brans-Drühner preparation Microscopes, and this is directed on to one of the divisions of the glass scale. When the organism has reached this division a stop-watch is released, and the time of reaching the next division recorded. The author hopes at some future time to publish an account of his researches.

Metallography, etc.

Polymorphism of Zinc.*—C. Benedicks has determined the electrical resistance of samples of pure and commercial zinc, at small temperature intervals, between 16° C. and the melting-point. The existence of a transformation-point at about 340° C., discovered by Le Chatelier, was confirmed, and a similar point was found at about 170° C. The author concludes that zinc is trimorphous, the α form being stable up to 170° C., β in the range 170° to 330° C., γ from 330° to 419.4° C. Abnormal results were given by the impure samples.

Aluminium-calcium Alloys.†—From the results of determinations of electro-chemical potential and electrical conductivity of a series of aluminium-calcium alloys, J. M. Breckenridge deduces the existence of the compound Al_3Ca .

Alloys of Lithium.‡—G. Masing and G. Tammann have studied the binary systems of which the components are lithium and one of the metals sodium, potassium, tin, cadmium, and magnesium. By using very thin thermocouple wires and protecting tubes, it is possible to apply the methods of thermal analysis to a few grams of material, and thus to work out equilibrium diagrams of systems of metals which can be obtained in a pure state only in small amounts. The original should be consulted for the detailed results of the investigation.

Gold-magnesium Alloys.§—G. G. Urasow and R. Vogel explain differences in the equilibrium diagrams obtained by them when working independently. The existence of Au_2Mg_5 is confirmed, but it is stable only in the range 796° – 716° C., breaking up into AuMg_2 and AuMg_3 at the lower temperature.

Silver-cadmium Alloys.||—G. Bruni and E. Quercigh have determined the equilibrium diagram by means of cooling curves of 30 alloys. The compounds AgCd and AgCd_4 occur; these form solid solutions with silver, or cadmium, or each other, according to the composition of the alloy.

* Metallurgie, vii. (1910) pp. 531-7 (5 figs.).

† Met. and Chem. Eng., viii. (1910) p. 349.

‡ Zeitschr. Anorg. Chem., lxxvii. (1910) pp. 183-99 (5 figs.).

§ Tom. cit., pp. 442-7 (4 figs.).

Tom. cit., pp. 198-206 (3 figs.).

Silver-copper Alloys.*—N. Kurnakow, N. Puschin, and N. Senkowsky have determined the electrical conductivity at 25°, 50°, and 100° C. of 16 silver-copper alloys before and after annealing. Hardness measurements, by the Brinell method, confirm the results of the electrical determinations, which indicate that the limits of solid solubility are 4 atomic p.c. silver in copper, and 9 atomic p.c. copper in silver.

Silver-sodium Alloys.†—E. Quereigh, by means of a thermal study of twenty alloys melted in an atmosphere of nitrogen, has found that silver and sodium are miscible in all proportions in the liquid state, that no compound is formed, and that the single eutectic lies close to the sodium end of the equilibrium diagram. The solid solution of sodium in silver has the concentration limits 0 to 13 atomic p.c. sodium.

Ternary Alloys of Magnesium, Zinc, and Cadmium.‡—G. Bruni, C. Sandonini, and E. Quereigh have investigated by thermal methods the binary systems zinc-cadmium, zinc-MgZn₂, and cadmium-MgZn₂. The compound MgZn₂ is the only one occurring in the magnesium-zinc system, and behaves like a simple metal in ternary alloys. Having cleared up the doubtful points in the binary systems, the authors proceeded to study the ternary system, cadmium-zinc-MgZn₂, as a portion of the complete ternary system. Cooling curves were taken of 109 alloys lying in fifteen vertical sections of the usual triangular diagram; these sections were parallel to the zinc-magnesium side of the triangle. The ternary system examined has three binary eutectic lines meeting in a ternary eutectic point at 250° C. and 73 atomic p.c. cadmium, 25 zinc, 2 magnesium.

Alloys of Copper, Antimony, and Bismuth.§—N. Parravano and E. Viviani, first investigating the binary systems, find that antimony and bismuth appear to form a continuous series of solid solutions. Antimony does not retain copper in solid solution, and copper does not retain more than a minute quantity of antimony in solid solution. The compound Cu₃Sb melts without decomposition; the ternary system is therefore regarded as two systems, Cu-Cu₃Sb-Bi and Cu₃Sb-Sb-Bi. The compound Cu₃Sb and bismuth are only partly miscible in the liquid state, and they do not form compounds or solid solutions. The general form of the equilibrium diagram of the ternary system Cu₃Sb-Sb-Bi is discussed.

Heat-treatment of Bronze. ||—E. Heyn and O. Bauer have investigated the unsatisfactory behaviour of some bronze bushes containing 93 p.c. copper and 7 p.c. tin, which were shown by hardness measurements to be softer than good specimens having the same composition. Microscopical examination revealed that the hard samples contained two constituents, the soft samples only one. Heat-treatment experiments showed that the soft condition and its corresponding structure were produced by

* Zeitschr. Anorg. Chem., lxxviii. (1910) pp. 123-40 (4 figs.).

† Tom. cit., pp. 301-6 (2 figs.).

‡ Tom. cit., pp. 73-90 (8 figs.).

§ Atti R. Accad. Lincei, xix. 1 (1910) pp. 835-40; xix. 2 (1910) pp. 69-75, through Journ. Chem. Soc., xviii. (1910) pp. 779, 852.

|| Mitt. Kgl. Materialprüfungsamt, xxviii. (1910) pp. 344-8, through Journ. Soc. Chem. Ind., xxix. (1910) p. 1110.

slow cooling between 1030° and 855° C., while the hard condition and duplex structure resulted from rapid cooling through this interval.

Metallic Silicides.*—L. Baraduc-Muller, in the course of an extended investigation of the action of silicon carbide on metallic oxides at high temperatures, and of the properties of the metallic silicides produced, has studied the metallography of these bodies. Two etching reagents were used: (1) commercial hydrofluoric acid, to which was added twice its volume of alcohol, and an amount of water depending on the rapidity of action required: addition of water increases the activity of the reagent; (2) a preparation of aqua regia and ferric chloride. The method of taking cooling curves is described, and some account of the microstructure of alloys of silicon with numerous metals is given.

Impurities in Copper.†—F. Johnson summarizes the available information as to the effect of arsenic, lead, nickel, bismuth, cobalt, antimony, tellurium, iron, tin, silver, sulphur, and oxygen occurring as impurities in copper.

Solubility of Oxygen in Molten Silver.‡—F. G. Donnan and T. W. A. Shaw find that the concentration of oxygen in molten silver is proportional to the square root of the oxygen-pressure over a wide range of pressures. From this it is inferred that the oxygen is either physically dissolved as atomic oxygen, or more probably exists in the form of dissolved silver monoxide.

Crystallography of the Iron-carbon System.§—A. Kroll has sought to establish the relation existing between the crystallography and the equilibrium diagram of the iron-carbon system. The main experimental method employed consisted in heating polished sections in an atmosphere of hydrogen or nitrogen; the different structures resulting are identified as the effects of the more or less sudden crystalline rearrangements taking place at the thermal critical points. A crystallographical explanation of the formation of troostite and of the precipitation of graphite is attempted. Ordinary cementite appears to be hexagonal, but the carbide entering into solution in γ -iron is regular; troostite is this solution-carbide saturated with γ -iron.

Iron-carbon Alloys.||—H. Lütke has investigated the effect of manganese on the concentration at the eutectic temperature (1130° C. in the iron-carbon system) of the saturated solid solution of cementite in γ -iron. Two series of alloys, containing respectively about 5 p.c. and 10 p.c. of manganese, the carbon ranging from 1.5 to 4 p.c. in each series, were examined thermally and microscopically. While in both series the cooling curves indicated the first appearance of eutectic at 2.0 to 2.3 p.c. carbon, the microscopical examination showed that 1.8 p.c. was the concentration of the saturated mixed crystals. Manganese, therefore, appears to have little influence on the carbon-concentration of the saturated solid solution.

* Rev. Métallurgie, vii. (1910) pp. 657-834 (44 figs.).

† Met. and Chem. Eng., viii. (1910) pp. 570-5 (9 figs.).

‡ Journ. Soc. Chem. Ind., xxix. (1910) pp. 987-9 (1 fig.).

§ Journ. Iron and Steel Inst., lxxxi. (1910) pp. 304-402 (33 figs.).

|| Metallurgie, vii (1910) pp. 268-73 (7 figs.).

Transformation-point Curve γ - to β - or α -Iron.*—P. Goerens and H. Meyer give a summary of previous investigations dealing with the positions of the critical points A_3 and A_2 in iron-carbon alloys, and describe their own work on six alloys containing 0.16 to 0.78 p.c. carbon, with about 0.23 p.c. manganese and 0.15 p.c. phosphorus. Thin disks were heated to 950°–1000° C., cooled to a given temperature, at which they were held for 15 minutes, then quenched in water and microscopically examined. With each series a number of quenchings at temperatures ascending by steps of 10° C. were performed. For each alloy the mean of the two quenching temperatures which gave, respectively, martensite + a little ferrite, and pure martensite, was taken as the transformation point. The transformation temperature falls from 905° C. in the 0.16 p.c. carbon-steel to 855° C. in that containing 0.54 p.c. In the alloys with higher carbon, the point was not so definitely ascertained.

Influence of Silicon on the Maximum Solubility of Carbide of Iron in γ -Iron.†—C. Schols has taken cooling curves of thirty-one melts classified in four series, containing respectively about 1.2, 1.5, 1.9, and 2.5 p.c. carbon, the silicon-content varying between 0 and 10 p.c. With all carbon-concentrations the addition of silicon lowers the temperature of commencing solidification, leaves the temperature of final solidification constant at about 1120° C., and raises the temperature of pearlite formation. Pearlite is no longer formed when silicon-content exceeds a certain percentage, this limit being 5.6 p.c. for alloys containing 1.2 p.c. carbon, and 4.5 p.c. for alloys containing 1.5 p.c. carbon. The eutectic halt (1120° C.) appears at lower carbon concentrations as silicon-content rises, indicating the diminished solubility of carbon in γ -iron with increase of silicon-content. Pieces of selected alloys were heated to 1140° C., slowly cooled to 1120° C. and quenched after 10 minutes at 1120° C. The microscopical examination of these specimens, together with the cooling curves, enabled the author to ascertain the silicon-content necessary for the formation of eutectic in alloys containing less than 2.2 p.c. carbon, the saturation point of the solid solution of carbide of iron in γ -iron when no silicon is present. Eutectic occurred in the 1.2 p.c. carbon alloy when more than 5.6 p.c. silicon was present. Sodium picrate, which coloured the eutectic brown in the quenched samples, was used for etching, also nitric acid in amyl-alcohol.

Iron Sulphide-iron System.‡—K. Friedrich has re-determined the freezing-point diagram, using more pure materials than those employed by Treitschke and Tammann, and finds some differences. The critical points of iron are somewhat lowered by addition of sulphide of iron, but are not caused to coincide.

Iron-nickel System.§—Discrepancies in the results obtained in previous investigations of this system have led R. Ruer and E. Schütz to determine the temperatures of solidification of a number of alloys prepared from pure materials. The temperatures of magnetic transformation

* Metallurgie, vii. (1910) pp. 307–12 (18 figs.).

† Tom. cit., pp. 644–6 (15 figs.).

‡ Tom. cit., pp. 257–61 (9 figs.).

§ Tom. cit. pp. 415–20 (7 figs.).

on heating and cooling were determined by measuring the permeability at different temperatures. The smooth and continuous freezing-point curve shows a minimum at 70 p.c. nickel, at which concentration the magnetic transformation temperature curve shows a maximum. These facts point to the existence of FeNi_2 , but measurements of electrical conductivity have afforded no indication of the existence of this compound. Alloys containing less than 29 p.c. nickel are irreversible, those with more nickel are reversible.

Iron-nickel-copper Alloys.*—C. F. Burgess and J. Aston summarize the results of their previous investigations on the mechanical properties of the binary alloys of electrolytic iron with nickel and with copper, and describe a similar investigation of a series of ternary alloys. Monel metal is an alloy of nickel and copper obtained directly from the ore; the nickel content is about three times the copper content. The ternary alloys were prepared by melting electrolytic iron with Monel metal, the successive members of the series containing proportions of Monel metal increasing by steps of 2 p.c. to 20 p.c. The curves showing the relation of mechanical properties to proportion of alloy added are very similar to the corresponding curves for the iron-nickel alloys. Copper does not in general appear to have a deleterious effect, and when nickel + copper does not exceed 10 p.c., the copper appears to be beneficial.

G. A. Ronsh † gives the results of determinations of hardness by means of the scleroscope, of binary and ternary alloys of iron with nickel and copper, other properties of which have been determined by Burgess and Aston.

G. H. Clamer ‡ and J. A. Matthews § give particulars of the properties of some copper-nickel steels.

ARNOLD, J. O.—**A Fourth Recalescence in Steel.**

[Attempts to explain an evolution of heat occurring between Ar_2 and Ar_1 in a steel containing about 0.2 p.c. carbon.]

British Association, Sheffield, September 1910.

CHAPPELL, C., & F. HOBSON—**Influence of Heat-treatment on the Corrosion Solubility, and Solution Pressures of Steel.** *Loc. cit.*

DUCELLIEZ, F.—**Alloys of Cobalt and Silver.**

Bull. Soc. Chim., vii. (1910) pp. 506-7.

MAZZOTTO, D.—**Heat of Solidification of Alloys of Lead and Tin.**

Nuovo Cim., xix. (1910) pp. 215-32.

VIGOUROUX, E.—**Alloys of Nickel and Silver.**

Bull. Soc. Chim., vii. (1910) pp. 621-2.

PANNAIN, E.—**Variations in the Physical Properties of Metallic Alloys subjected to Mechanical and Thermal Action. I. Specific Gravity.**

Gaz. Chim. Ital., xl. 1 (1910) pp. 431-3.

* *Met. and Chem. Eng.*, viii. (1910) pp. 452-6 (6 figs.).

† *Tom. cit.*, pp. 468-70, 522-3 (7 figs.).

‡ *Tom. cit.*, p. 527.

§ *Tom. cit.*, pp. 527-8.

PROCEEDINGS OF THE SOCIETY.

MEETING

HELD ON THE 21ST OF DECEMBER, 1910, AT 20 HANOVER SQUARE, W.,
DR. E. J. SPITTA, IN THE CHAIR.

The Minutes of the last Meeting were read and confirmed.

The List of Donations (exclusive of exchanges and reprints) received since the last meeting was read as follows, and the thanks of the Society were voted to the donors.

	From
Jean Massart, Esquisse de la Géographie Botanique de la Belgique, 2 vols., Text and Annexe containing 466 photographs, 9 charts and 2 diagrams. (8vo, Bruxelles, Henri Lamertin, 1910)	} <i>The Author.</i>
Léo Errera, Recueil d'Œuvres de Léo Errera Physiologie Générale Philosophie. (8vo, Bruxelles, H. Lamertin, 1910) }	} <i>Madame Léo Errera.</i>
Jas. Murray, British Antarctic Expedition, 1907-9, Vol. I. Biology, Part V. Tardigrada. (4to, London, 1910) . . . }	} <i>Sir Ernest Shackleton.</i>

Mr. W. Traviss exhibited a small Microscope Lamp, of which he gave a short description. He considered it very efficient for opaque objects and dark-ground illumination with high powers, also with polarized light, especially where the prisms are small; it was simply made, beautiful in appearance, and was easily moved up and down by means of a square pillar-tube made of $\frac{3}{8}$ -in. square brass tube about 6 in. high, fixed at one corner of a small iron tripod of about 5 in. span. Sliding over this is another square tube, which is "sprung" so as to give an even tension. On the upper end of the larger tube is fixed a solid square elbow, into which a hole is drilled and tapped to take a small gas tap and another ordinary brass elbow pointing downwards, on to which an incandescent burner with inverted mantle is fixed. A small nipple is fixed on the solid end of the larger square tube to take a small rubber tube, which is to be connected with an ordinary gas-burner. The nipple can be on either side, up or down, or on end so as to form a T with the solid elbow.

The Chairman asked whether there was any objection to the rubber tube being placed so near the heat of the lamp?

Mr. C. E. Heath said that he had had practical experience of the lamp and had had no difficulty in this way, and considered the danger to which the Chairman referred could be overcome by using a flexible

metallic tube, and the insertion of an asbestos washer between the stand and tube fastener.

The thanks of the Society were accorded to Mr. Traviss for his exhibit.

Dr. Hebb read the following communication from Mr. A. J. Allan on "An Easy Method of Treating Printing-out Paper for all Kinds of Photography." The two prints of *hydra* and specimen of group mounting will show the result of this method. They were treated in the following manner, which may be of interest to some of your members who do this class of work. First wash the prints in a very strong solution of salt and water for ten minutes, then lift the prints and place them without washing into a saturated solution of hypo; in about fifteen minutes the prints will be done. They should then be washed in running water for two hours. The advantages of this method are first, simplicity; second, uniformity of tone, every print will finish the same; third, the whites are pure.

A communication from Mr. A. A. C. E. Merlin on "The Measurement of Grayson's New Ten-Band Plate," was taken as read.

The thanks of the Society were accorded to Mr. A. J. Allan and to Mr. Merlin for their communications.

Mr. F. Shillington Scales gave a synopsis of a communication from Mr. Higgins on "A New System of Filing Slides," suggesting an adaptation of the ordinary card-index system by means of guide cards for every ten slides, the slides being placed on edge with an index number on the upper edge.

The thanks of the Society were accorded to Mr. Higgins for his communication.

A paper by Mr. James Murray on "Some African Rotifers, Bdelloida of Tropical Africa," was taken as read. Mr. Murray gave a short description of drawings of a number of species. The following is an abstract of the paper.

Thirty-three species of Bdelloids were obtained from dried moss sent by Mr. A. Allan and Sir Philip Brocklehurst from British East Africa. Nine of the species are new to science. Several of them have very distinct characters, not previously noted for any Bdelloids. *Habrotrocha caulata* has a tail-like process, the function of which is unknown. The animal secretes a protective shell, and the "tail" is enclosed in a slender tube, open at the end, so that the shell has two openings.

H. acornis has no trace of spurs, otherwise universal in the order. Several other species approach it in this respect, having the spurs reduced to minute papillae.

H. auriculata, when feeding, has at each side of the head a peculiar ring-like "auricle," giving it the appearance of a two-handled vase. The nature and function of the "auricles" remain unknown. Their form, even, is difficult to interpret, as they present apparently contradictory appearances from different points of view.

The Bdelloids take a very important place in moss-faunas. In every country they are abundant, and in most regions there is a fair

proportion of peculiar species. When more fully known the Bdelloids seem likely to prove a group of hitherto unsuspected importance, both in point of numbers and diversity of forms.

All of these moss-dwellers can revive after desiccation. The adult animals become dormant when deprived of moisture, and revive when remoistened. It is not, as Zacharias concluded from his experiments in 1886, that the survival of the species is effected by means of eggs.

Mr. Roussetet remarked that this would be a most interesting paper when published, for the specimens described had been collected from all parts of the world, and would be most interesting records to read.

The thanks of the Society were voted to Mr. Murray for his exhibit.

Mr. A. Earland gave a lantern lecture dealing with the apparatus and methods employed in the cruisers of the International North Sea Commission, with special reference to the work of the "Goldseeker," the cruiser of the Scottish branch of the Commission. The hydrographical cruises were explained and their utility demonstrated. Various kinds of apparatus, including the Petterson-Buchanan water-bottle, Ekman's current-meter, Bidder's bottom-drift bottle, were shown on the screen, and their uses explained. Passing to the zoological work of the Commission, the lecturer showed many different forms of surface, mid-water and bottom nets, and described the methods of working them; dealing at some length with the otter-trawl. The life-history of several typical fishes was briefly dealt with, and the lecture concluded with a description of the Faroese methods of capturing schools of the Pilot Whale (*Globicephalus melas*), and some account of modern methods of whaling as now carried out in the Shetland Islands.

The Chairman said that he was sure that all would wish to return a most hearty vote of thanks to Mr. Earland for his exceedingly interesting lecture, and for all the trouble he had taken in preparing the pictures and explaining them.

The unanimous thanks of the Society were heartily accorded to Mr. Earland for his lecture.

The following list of Fellows of the Society, nominated by the Council for election as Honorary Officers for the coming session, was read by the Secretary:—

President—H. G. Plimmer, F.R.S. F.L.S. F.Z.S.

Vice-Presidents—A. N. Disney, R. G. Hebb, E. Heron-Allen, J. Arthur Thomson.

Treasurer—Wynne E. Baxter.

Secretaries—John W. H. Eyre and F. Shillington Scales.

Ordinary Members of the Council—F. W. Watson Baker, J. E. Barnard, F. J. Cheshire, C. L. Curties, C. F. Hill, J. Hopkinson, P. E. Radley, J. Rheinberg, C. F. Roussetet, D. J. Scourfield, E. J. Spitta, A. E. Wright.

Librarian—Percy E. Radley.

Curator of Instruments, etc.—Charles F. Roussetet.

Curator of Slides—F. Shillington Scales.

Auditor on behalf of the Council—C. F. Hill.

In connexion with the election of officers, the Chairman said that it would have been noticed in the list just read that there was to be a change of one of the Secretaries. In other words, their old and valued Secretary, Dr. Hebb, was retiring. He (Dr. Spitta) had not known that he would be asked to fill the chair that evening, or he would have certainly endeavoured to have been prepared with some more fitting words on such an occasion. He was sure, however, that all present would wish to accord a very warm vote of thanks to Dr. Hebb, who had been their Secretary for certainly over thirteen years. His work as Secretary was not merely that in connexion with the Meetings, which in themselves involved a great deal of preparation, but he had all along worked most assiduously on behalf of the Society. He was sure that all would agree with him that it was a fitting occasion to return to Dr. Hebb a very hearty vote of thanks for all the hard work during the past years he had devoted for the benefit and advantage of the Society.

The vote of thanks was unanimously and enthusiastically carried.

Dr. Hebb returned his thanks for the cordial way in which the vote had been carried.

In connexion with the election of new Officers, the Chairman further said that Mr. Hill had been elected as Honorary Auditor on behalf of the Council, and he wished to ask the meeting whom they desired to propose to fill the place of Honorary Auditor on behalf of the Fellows of the Society.

Mr. Soar said he would like to propose Mr. Charles Curties; this was seconded by Mr. Gardner.

The Chairman said that it had been proposed and seconded that Mr. Curties should be once again appointed Honorary Auditor, and, having put it to the meeting, the motion was carried unanimously.

He further said that at the Meeting of the Council that evening the point had been brought forward that it would be very beneficial for the Society if they could manage to show in their rooms some, if not all, of their valuable collection of microscopical instruments and microscopes. These hitherto had been all lying in cases, where they could indeed be shown to those who wished to see them, but it seemed a great pity that this magnificent series of exhibits should not be set out for general inspection, both for the benefit of those members who came from abroad, and for others who were interested. Carrying out the idea would involve a good deal of expense—something like 50*l.* for the show-cases necessary, and unfortunately the finances of the Society were such that the Council did not feel that they could draw upon their funds for the purpose. He had, therefore, been desired by the Council to lay the matter before the Fellows that evening and invite subscriptions, so that if possible something like the sum of 50*l.* might be raised to provide a set of glass cases wherein to show the instruments of historic interest possessed by the Society. It seemed, he thought, an excellent suggestion, and he hoped that those present would try and circulate the proposal among other members, so as to enable the Council to collect the money required for the purpose.

The Annual Meeting of the Society was announced for January 18th next, when the President would give the annual address, the subject of which would be announced later on.

The following Instruments, Objects, etc., were exhibited:—

Mr. W. R. Traviss—A New Microscope Lamp.

Mr. Jas. Murray—A series of drawings in illustration of his paper.

New Fellows—The following were elected *Ordinary* Fellows of the Society:—William John Caird, John Arthur Carter, R. T. Hewlett.

MEETING

HELD ON THE 18TH OF JANUARY, 1911, AT 20 HANOVER SQUARE, W.,
PROFESSOR J. ARTHUR THOMSON, M.A. F.R.S.E., PRESIDENT, IN
THE CHAIR.

The Minutes of the Meeting of December 21 last were read and confirmed, and were signed by the President.

The President said that before passing on to formal business, he thought a few words should be said in deploring the great loss the world had sustained in the death of Sir Francis Galton, which took place on the evening of January 17. He was not a Fellow of the Microscopical Society, but he certainly was one of the princes of science in Great Britain, and his loss would be much felt by all those who were in any way connected with scientific work.

Messrs. J. I. Pigg and A. W. Sheppard were appointed by the President as Scrutineers of the Ballot for the election of Officers and Council of the Society for the ensuing year.

The List of Donations (exclusive of exchanges and reprints) received since the last Meeting was read as follows, and the thanks of the Society were voted to the donors:—

D. G. Stead, A Brief Review of the Fisheries of New South Wales, Present and Potential. (8vo, Sydney, 1910) ..	From The Department of Fisheries, New South Wales.
Richard T. Baker and Henry G. Smith, A Research on the Pines of Australia. (8vo, Sydney, 1910)	The Authors.

Mr. T. Chalkley Palmer, in explanation of the slide of *Surirella elegans* exhibited by him, stated that there had been three or four theories

advanced as to the method of locomotion in diatoms—all of them with a good deal of pertinacity—and especially to be noted was the theory put forward by Mr. Jackson, which was commented upon recently in the Journal. All these theories, however, failed to agree with the actual phenomenon. Still another theory had been propounded by R. Lauterborn, namely, that the diatom moved by the protrusion of what he called gallerie, a sort of jelly.

Lauterborn referred to *Surirella* as moving because of the streaming of gallerie in the keels. There were four keels occupied by tubes running fore and aft the diatom. Lauterborn said the streaming substance was not protoplasm, since he was unable to find any of the Butschli structure in the contents of the keel. He had also stained it, and had been unable to find any keel protoplasm. This was astonishing, since when properly stained after fixing the protoplasm showed itself very clearly. The slide under the Microscope contained *Surirella* which had been killed and fixed with corrosive sublimate, and stained with iron-alum and hæmatoxylin. It showed the protoplasm extending in unbroken continuity through the ribs and the tube of the keel. That which circulated in this keel was most certainly protoplasm, and it moved the diatom by action upon the environment through the minute cleft that ran the length of the keel.

Mr. Scourfield said that he would like to ask how the protoplasm was supposed to produce the movement of the Diatom, as it did not seem to be very clear. If there were a tube along each ridge he did not see how the protoplasm inside could affect external objects. It was, however, quite certain that something moved along the tubes. Only a few evenings before he had been looking at a living *Surirella* and saw quite distinctly that small particles of dirt were passed along the ridges, but he could not make out exactly how this movement was brought about.

Mr. Palmer said that certainly the protoplasm streaming in the cleft of the keel was competent to do this, since it visibly moved particles of debris along this cleft.

Mr. Scourfield assumed that the protoplasm came out of the cleft in a series of waves, or it might be in a continuous band running along, but certainly projecting somewhat from the surface.

Mr. Palmer replied that that might be so, but that the protoplasm did not necessarily extend much beyond the surface of the silica, and it was probably clothed with a thin layer of sticky gallerie or jelly at that point, since small particles of external substances adhered to it quite strongly.

Mr. Shillington Scales said that in regard to Mr. Nelson's suggestions on the subject of examination questions upon Microscopy on p. 771 of the last issue of the Journal, Mr. Merlin had written a note to Mr. Nelson saying that "he had succeeded in accomplishing the resolution."

The Annual Report of the Society for the year 1910 was then read by Mr. Shillington Scales.

REPORT OF THE COUNCIL FOR 1910.

FELLOWS.

Ordinary. During the year 1910, 32 new Fellows have been elected, whilst 7 have died, 10 have resigned, and 7 have been removed, and 3 elections have been declared void.

Among the names of deceased Fellows the Council regrets to record those of Sir William Huggins, F.R.S., etc., and of Walter Wesché, sympathetic notices of whom were made from the Chair at the April and October meetings.

Honorary.—The Council regrets to announce the deaths of two Honorary Fellows:—Prof. A. Agassiz and Prof. E. van Beneden.

The number of Honorary Fellows is now 38.

The List of Fellows now contains the names of 393 Ordinary, 1 Corresponding, 38 Honorary, and 79 Ex-officio Fellows, being a total of 511.

FINANCE.

The amount received from Members' subscriptions is £70 less than last year, but this does not affect the stability of the Society's permanent income, arising as it does from fewer arrears being collectable and less having been paid in advance. The amount received from admission fees is larger than it has been for many years. There is a considerable falling off in the sales of the Journal. The receipts from this source having been £78 less than last year. This may be partly caused by changes in the publishing trade. If such be the case it will no doubt correct itself in the future.

JOURNAL.

Seventeen valuable papers on important subjects are recorded in the Transactions of the Society; the front part of the Journal also includes three Notes, making a total of twenty communications.

The Proceedings of the Society deserve attention, notably those containing an interesting communication by the President.

The summary of current researches has been continued on lines similar to those of previous years, and the thanks of the Council are due to the members of the editorial staff for their continued efforts in maintaining the high standard of the abstracts of Zoology, Botany, Microscopy, and Metallography.

LIBRARY.

The Library has been maintained in good order, but the number of new books received during the year 1910 has been fewer than usual. More use has been made of the Library since the publication of the new Catalogue.

INSTRUMENTS AND APPARATUS.

The Instruments and Apparatus in the Society's Collection continue to be in good condition.

During the past twelve months the following additions have been made :—

- Jan. 19.—A Projection Lantern with Self-regulating Arc Light. Presented by Mr. J. W. Ogilvy.
- Feb. 16.—An Old Microscope, by Browning.
 „ An Old Microscope, by Trécourt and George Oberhaeuser.
 „ Eight Lieberkühn Microscopes, in cases. Presented by Members of the Council.
 „ A Withering's Botanical Microscope. Presented by Mr. A. N. Disney.
- Mar. 16.—A Live-box, with micrometer scale engraved on the glass tablet, by Andrew Pritchard. Presented by Mr. John Cooper Webb.
- May 25.—An Old Wooden Nürnberg Microscope. Presented by Mr. C. F. Rousselet.
 „ An Old Microscope, of Culpeper and Scarlet model. Presented by Mr. A. Ashe.
- Oct. 19.—A Lucernal Microscope, by Adams. Presented by Mr. Frank Slade.
 „ A Microscope, by Hugh Powell, dated 1840. Presented by Mr. P. T. B. Beale.
- Nov. 16.—Old Ivory Sliders with Objects, and a Slider containing magnifiers in brass holder. Presented by Mr. H. C. Gooding.
 „ Old Pocket Magnifiers, in brass box. Presented by Mr. Charles Lees Curties.
 „ An Old Microscope, by Oberhaeuser and Hartnack. Presented by Mrs. Wesché.

CABINET.

The following additions have been made to the Slide Cabinet during the past year :—

- Feb. 16.—Twenty-four slides from the collection of the late Mr. Frederick Fitch (mostly insect preparations in fluid). Presented by Miss Fitch.
 „ Two Grayson's Rulings—a complete inch divided into hundredths, and 25 mm. divided into 0.25 mm. Presented by Mr. Conrad Beck.
- May 25.—Two slides of Insects mounted by the late B. F. Grimby, of Chicago, one of which was a Bee and the other a Croton Bug. Presented by Miss V. A. Latham, M.D.
- June 15.—Two slides of the rare Synaptid, *Trochodota danedlinensis* (Parker). Presented by Mr. M. J. Allan, of Geelong, Victoria.
- Nov. 16.—Two slides of *Pleurosigma*. Presented by Hon. T. Kirkman.
 „ Eight slides, including one of *Trochodota* eggs, mounted in fluid. Also presented by Mr. M. J. Allan.

	£	s.	d.		£	s.	d.
To Balance from 1909	53	11	11	By Rent, Coal, etc.
" Admission Fees	67	4	0	" Salaries and Reporting
" Annual Subscriptions—				" Books and Periodicals purchased
1906	0 10 0	" Bookbinding	6 18 4
1907	1 11 6	" Expenses of Journal—
1908	3 13 6	Editing	£167 16 6
1909	27 10 3	Illustrations	45 10 3
1910	554 18 1	Printing and Postage	437 19 1
1911	23 19 2				
1912	0 0 11				
Interest on Investments	612	3	5	" Purchase of 60 <i>l.</i> India Three per Cents...	651 5 10
" Sale of Journals	63	15	9	" Refreshments at Meetings	50 3 0
" Advertisements	272	1	0	" Stationery	9 0 0
" Sale of Surplus Books	60	0	0	" Fire Insurance	16 13 1
" .. Reprints and List of Fellows	6	5	0	" Postage and Petty Disbursements	3 5 0
" Income Tax returned	0 16 4	" Rent of Stock of Journals	32 11 4
" Sale of Tools	3 8 11	" Repairs	3 18 9
" Library Catalogue, Donations and Sales	5 19 6	" Deposit Withdrawn	200 0 0
" Donation to Show Case	11 12 2	" Subscription returned (paid in error)	2 2 0
" Deposit	1 1 0	" Printing of Library Catalogue	48 9 3
" Compounding Fees	200 0 0				
" Debt Balance	63 0 0				
			6 11 9				
			£1427 13 9				

	£	s.	d.
North British Railway	400 0 0
Nottingham Corporation	400 0 0
New South Wales Three and a Half per Cents.	400 0 0
India Three per Cents.	760 0 0
Metropolitan Water Board B Stock	150 0 0
			£2110 0 0

We have examined the foregoing Account, and compared the same with the Vouchers in the possession of the Society; we have also verified its Securities as above mentioned, and find the same correct.

WYNN E. BAXTER, *Treasurer.*

C. F. HILL }
C. LEES CURTIS } *Auditors.*

The Treasurer presented his Cash Statement, which commenced with a balance from the year 1910 of 53*l.* 4*s.* 11*d.*, against a balance last year of only 2*l.* 6*s.* Most of that, however, consisted of subscriptions given for the Library Catalogue, and had been mostly spent on the printing, etc., of the said catalogue, so that the Society's general finances had not greatly benefited. The admission fees, amounting to 67*l.* 4*s.*, were the largest they had had for many years. In the sum total of annual subscriptions there seemed to be a great falling off, which, however, might be accounted for by the fact that last year many subscriptions not paid with promptness had been collected, and which of course could not now again be collected. In analysing the actual amount of subscriptions for the current year, it would be seen that it exceeded last year's amount by some 6*l.*

The amount received for the sale of the Journals was certainly most deplorable, being only 27*l.* 1*s.* as against 340*l.* 10*s.* 5*d.* As the Council Report had mentioned, this might possibly be accounted for by some publishing firms in the science world having changed hands during the past year, and thus upset the receipts of the Society. He trusted that this was really the explanation, and that next year it would be remedied.

He had to announce under the "Receipts" column the new item of "Donations to the Show Case," and after the appeal made at the last Meeting it might be expected that a large amount had been received, but he was sorry to say that up to then it had only been 1*l.* 1*s.*; he hoped, however, that this might shortly be increased.

He had to announce with satisfaction the amount received in Composition Fees, viz. 63*l.* As an outcome of the Report, he had to bring out a debit balance of 6*l.* 11*s.* 9*d.*, which, looked at generally, and in view of the fact that the investments had been increased by the purchase of 60*l.* India Three per cents., was better than it had been for many years.

Mr. Offord said that they had heard the Report of Council and the Treasurer's Statement, and he thought that on the whole they might be considered satisfactory. The sale of the Journal had certainly fallen off very much, but perhaps that was only temporary, and might right itself next year. He proposed that the Report and Statement should be passed.

Mr. James Smith having seconded the motion, it was put to the Meeting and carried unanimously.

The President announced that the Scrutineers having handed in their report as to the result of the ballot, the following Fellows proposed by the Council had been duly elected as the Officers and Council of the Society for the ensuing year:—

President—Henry George Plimmer, F.R.S. F.L.S. F.Z.S.

Vice-Presidents—A. N. Disney; R. G. Hebb; Edward Heron-Allen; J. Arthur Thomson.

Treasurer—Wynne E. Baxter.

Secretaries—J. W. H. Eyre; F. Shillington Scales.

Ordinary Members of the Council—F. W. Watson Baker ; J. E. Barnard ; F. J. Cheshire ; Charles Lees Curties ; C. F. Hill ; J. Hopkinson ; P. E. Radley ; J. Rheinberg ; C. F. Rousselet ; D. J. Sconrfield ; E. J. Spitta ; Sir Almoth E. Wright.

Librarian—P. E. Radley.

Curator of Instruments, etc.—C. F. Rousselet.

Curator of Slides—F. Shillington Scales.

The President then gave his Annual Address on "The Determination of Sex."

After the Address the President said that he wished to congratulate the Society on their increasing Membership, and on the activity and interest maintained during the past session. He also wished to thank them, and especially the Council and Officers of the Society, for the kindness and consideration which they had shown to him during his term of office. It had been a great pleasure to him to serve the Society, with which he had been so long connected, and he was not a little gratified at the happy coincidence of his presidency with a year of prosperity. He hoped that the prosperity would continue and increase. He thought, however, if he might say so, that two practical improvements were eminently desirable and urgent. 1. That they should display in a fitting and dignified manner a considerable proportion of the Microscopes and other instruments in the possession of the Society, which should, he thought, be described in an illustrated catalogue. 2. That they should develop on an ambitious scale the Society's collection of microscopical slides, partly by the industry of the Fellows themselves, and partly by soliciting typical slides from other workers. In that way might gradually be built up what did not exist, namely a typical collection—a Reference Museum—of microscopical preparations which would be a valuable asset not only to the Society but to scientific workers in general.

He hoped that as Vice-President, or otherwise, he might still continue to express actively his interest in the Society's welfare.

Mr. Michael said that after the great applause following on the President's Address it seemed to him hardly necessary to propose the usual vote, namely, that the thanks of the Society be returned to the President for his Address, and that he be asked to give his consent for its publication in the Society's Transactions. The opinion of the Meeting had been pretty definitely expressed. The Address to which they had listened that evening had been an extremely able contribution to one of the most interesting of existing subjects, and had been treated in a manner (as might indeed be expected) entirely characteristic of the care, ability and open-mindedness for which the President was characterized in whatever research he took up. The Address would commend itself as a clear summary of the present state of our knowledge on a fascinating subject, and it came with especial appropriateness from Professor Thomson, who had spent much time and thought on its consideration. The subject could not altogether be said to have been lifted out of the realm of conjecture, but so far as our present knowledge went the conjectures to which Professor Thomson had drawn special attention in his Address seemed to

him (Mr. Michael) the most likely to prove themselves the correct ones, or, at all events, to include the correct one.

Mr. Disney said he had pleasure in rising to second the vote of thanks which Mr. Michael had proposed.

He said he would also like to draw especial attention to the useful and valuable suggestions which the President had urged, namely, the provision of adequate show cases for the Society's collection of Microscopes and other instruments, as well as the arrangement of a thoroughly representative exhibition of slides.

The motion was put to the Meeting and carried with acclamation.

The President thanked the meeting for the hearty way in which they had received the motion, and said that it would give him great pleasure to have his Address published in the Transactions.

Mr. Earland said that it fell to his lot to propose the next vote of thanks, namely, to the Honorary Officers of the Society. He supposed that he had been asked to undertake this pleasant task as a Fellow of the Society who had had some experience elsewhere of the difficulties which came in the way of Honorary Officers. He thought that all would allow that the success of a Society depended almost entirely on the energy and efficiency of its officers. Fellows of the Society came to the meetings expecting entertainment and instruction, and were very rarely disappointed, and it might not occur to them that the success of such meetings had been secured, perhaps, at the cost of sleepless nights spent by the Secretary in the attempt to obtain an emergency paper, or that the Treasurer had been occupied in trying to bring out his balance on the right side of the sheet—not always with the success which he desired! He had always admired the Treasurer's office more than that of any other Officer, since it had always been quite beyond his capacity to understand a balance sheet.

He also wished to move a vote of thanks to those who might perhaps be called the "lesser lights" among the Officers of the Society, namely, to its Librarian and Curator, who had no less arduous duties to perform, but who came less under the public notice.

The Society had just dropped one of its pilots in the person of their genial and popular friend, Dr. Hebb, who for many years past had been their Secretary, and whose never-failing kindness and good humour had been one of the most attractive features of the Society. He thought that it might truly be said that the success of the Society during the years of Dr. Hebb's activity as Secretary had been very largely due to his exertions. His successor was well known to microscopists, and he had no doubt that in him they would have an equally energetic man.

He begged to move the vote of thanks to all Officers.

Mr. Pledge rose to second the proposal, which, having been put to the Meeting, was carried unanimously.

Mr. Wilson said that he rose to propose a vote of thanks to two gentlemen who were not included in Mr. Earland's vote, and in whom the Society placed great confidence, namely, the Honorary Auditors. Unless reliance could be placed on the statements made by the Auditors, he thought the Society would be placed in rather a queer box. He had

great pleasure in moving the vote of thanks both to the Auditors and to the Scrutineers of the ballot.

Mr. Davies said he had pleasure in seconding that proposal, which, having been put to the Meeting, was carried unanimously.

Mr. Shillington Scales said that he regretted Dr. Hebb's absence that evening, as it would have been the last time he would have been present as Honorary Secretary, but those examination duties which had compelled him to give up his Secretaryship had prevented him from being present. He was glad to know, however, that, as Vice-President, the Society would still have the opportunity of taking advantage of his great experience as Secretary. Dr. Hebb had been with them for many years, and had worked very hard, and had fully earned a rest.

The increased prosperity of the Society had been alluded to, but of course he must impress upon the Meeting that a good deal of anxiety lay before them in the future owing to the growing expenditure. It was a great satisfaction to know that the Fellowship had been increased, but a still greater number of new Fellows would be welcomed by all, and the present Fellows of the Society could help in this direction greatly by bringing forward suitable candidates for the Fellowship. The two new Secretaries following Dr. Hebb would have many difficulties to contend with, and they were very wishful to increase still further the usefulness of the Society, and would therefore welcome gladly any suggestions which could be made. It was satisfactory to know that the Library had been more used in the past year, but the Slide Cabinet might be more often referred to, and efforts would be put forward to make the Meetings of even more interest than they were now, especially in a social direction. He would be very glad indeed to receive any suggestions or help which could be given, for the Fellows themselves could be of as much assistance in this direction as the Honorary Officers.

The next Meeting was announced for February 15, when a paper by Mr. E. M. Nelson, "On Some New Objectives and Eye-pieces by R. Winkel, of Göttingen," would be read.

The following Instruments, Objects, etc., were exhibited :—

Mr. T. Chalkley Palmer :—Slide of *Surirella elegans*, stained to show protoplasm.

New Fellows :—The following were elected *Ordinary* Fellows of the Society :—Frank Armstrong, William Ayrton, John Ross, Charles James Tabor.

JOURNAL
OF THE
ROYAL MICROSCOPICAL SOCIETY.

APRIL, 1911.

TRANSACTIONS OF THE SOCIETY.

VI.—*The President's Address: The Determination of Sex.*

By J. ARTHUR THOMSON, M.A.

(*Delivered January 18, 1911.*)

I HAVE taken as the subject of my Address, not without much hesitation, one of the great unsolved problems of Biology—The Determination of Sex. Though the subject cannot be discussed with thoroughness within the compass of an Address, I hope to be able to make clear what the general trend of investigation has been, and what the present position of the question is. The particular appropriateness of the subject on this occasion is to be found in the fact that several of the most marked steps of progress in the investigation have been due to *microscopic* work of the finest kind. There is also a personal appropriateness, for I have taken a great interest in the subject since I shared in the responsibility of writing "The Evolution of Sex" more than twenty years ago. It seemed to me natural and useful that I should state something of what I know of the crop of investigations in regard to this extremely important problem, and indicate what, in my opinion, are the most promising recent developments.

THE DETERMINATION OF SEX.

1. From ancient times a keen interest has been taken in the question of the determination of sex—the settling of the sex of the offspring; and the numerous suggestions offered in answer might almost serve as an index of the progress of natural knowledge. For there were theological and metaphysical answers to the question, before it began to be approached scientifically; and even after the problem was recognized as one that must be tackled

April 19th, 1911

scientifically or not at all, the solutions suggested have not always adhered strictly to scientific method. Scores of books and pamphlets redolent of good intentions must be set aside because of *obvious* scientific unsoundness. Some lay stress on what even the most tolerant must call unverifiable factors, such as the desire of the parent to have a male child; others allege the operation of factors which are physiologically absurd; others base a generalization on an outrageously small number of cases. The number of theories on the subject is legion, and one can hardly wonder, since the practical importance of the problem is as great as its theoretical interest.

THE PROBLEM STATED.

2. The general problem is: What determines whether an embryo will develop into a male or into a female organism? But let us look at some of the particular forms of the problem. What are called "true twins" in the human race, which appear to result from the division of a single ovum into two independently developing ova, are always of the same sex; but ordinary twins, which result from two distinct ova developing simultaneously, are often of different sexes. Why is there this difference?

In one household the family consists of both boys and girls; in the house next door to the right the children are all girls; in the house next door to the left the children are all boys! What determines this? A guillemot usually lays but one egg in a season: what determines the sex of the offspring? A setting of hen's eggs gives rise to cocks and hens in varying proportions—is the proportion practically modifiable? The unfertilized eggs of a queen-bee develop into drones; the unfertilized eggs of aphides develop into females all through the summer, but at the end of the season males are produced. What does this mean? In great part the question comes to be, *When* is the sex of the offspring determined finally? Is there sex-determination in ova before fertilization, or during fertilization, or in the course of development after fertilization? How long may a germ-cell or an embryo remain with the potentiality of *either* sex?

THREE CHIEF METHODS OF INVESTIGATION.

3. The problem has been attacked scientifically along three distinct lines, and it is particularly interesting to notice that some of the clearest steps of progress have been made by the co-operation of two methods.

Statistical.—Some generalizations as to the determination of the sex of the offspring have been based on statistics of the relative numbers of male and female offspring in different localities, at different times (e.g. in times of war and famine), with different ages

of parents, and so on. These statistics are valuable when the basis is broad enough, but great care is necessary in giving a physiological interpretation of statistical results.

Cytological.—Some generalizations as to the determination of the sex of the offspring have been based on observations of the germ-cells in particular cases. Thus it has been shown that there are two kinds of spermatozoa in some animals, that in some cases one half of the spermatozoa have “an accessory chromosome” absent in the other half, that in some insects ova fertilized by spermatozoa with an accessory chromosome develop into females, and so on. It has also been shown that some animals have two kinds of ova, the larger developing into females.

Experimental.—Some generalizations as to the determination of the sex of the offspring have been based on experiment, e.g. subjecting the eggs, or embryos, or parents, to particular conditions of temperature, nutrition and the like, and observing whether the relative numbers of the sexes in the offspring are in any way different from those obtaining in ordinary conditions; or by trying particular breeding experiments in reference to what are called sex-limited characters.

THE CHIEF THEORIES OF SEX-DETERMINATION.

4. Theories on sex-determination may be divided into (*a*) those which are based on the supposed occurrence of two kinds of germ-cells (male-producing and female-producing), predestined from the beginning and immune to environmental influences; and (*b*) those which credit the environment with determining influence, supplying stimuli which give the germ-cell or the developing organism a bias to maleness or to femaleness.

But I would propose a more detailed classification as clearer, distinguishing five theses:—

(A) That environmental conditions, operating on the sexually undetermined developing offspring-organism (after fertilization), may at least share in determining the sex;

(B) That the sex is quite unpredestined in the germ-cells before fertilization, and that then it is settled by the relative condition of the gametes, or by a balancing of the tendencies they bear, neither gamete being necessarily decisive;

(C) That the sex is predestined at a very early stage by the constitution of the germ-cells as such, there being female-producing and male-producing germ-cells, predetermined from the beginning, and arising independently of environmental influence;

(D) That maleness and femaleness are Mendelian characters;

(E) That environmental and functional influences, operating through the parent (or, in short, the parent's acquired peculiarities), may alter the proportion of effective female-producing and male-producing germ-cells.

TWO PRELIMINARY CAUTIONS.

5. Two preliminary cautions may be noted. In the first place, these main theories are not in any very strict way mutually exclusive. Even if we conclude that there are two kinds of ova in the ovary, one set pre-determined to develop into males and the other set pre-determined to develop into females, it does not follow that the relative numbers of these may not be changed as life goes on, e.g. in relation to the diet of the parent. Even if we conclude that there are two kinds of eggs, it does not follow that the determination of these is absolute; it may be strengthened or weakened in the process of fertilization, or by environmental influences during early development.

In the second place, we must be careful in arguing from one set of organisms to another. What determines sex in frogs may not hold true for cattle; what determines sex in rotifers may not apply to birds. Nature is very manifold, and it may quite well be that sex is determined by a variety of factors operative in different cases and at different stages in development.

A.—DO ENVIRONMENTAL CONDITIONS, OPERATING ON THE SEXUALLY UNDETERMINED DEVELOPING OFFSPRING-ORGANISM (AFTER FERTILIZATION), SHARE IN DETERMINING ITS SEX?

6. The first possibility which we shall discuss is that environmental influences acting on *the developing organism* (embryo or larva), may determine or help to determine whether it is to become a male or a female. This possibility assumes that in certain cases the developing organism is for some time indeterminate as regards sex. That this is not a wild assumption, is evident when we remember that in the case of many animals it is for a long time impossible to distinguish the sexes.

In support of the theory that environmental influences may determine sex in developing organisms, assumed to be indeterminate, reference has been made for many years past to a series of experiments on tadpoles, carried on by Professor Emile Yung, of Geneva, to whom recognition is due for beginning experimental investigation of the subject at a time when that mode of approach was much neglected.

Let us recall some of Yung's evidence. Tadpoles are said to linger for some time in a state of sex-indifference or potential hermaphroditism. In normal conditions there are about 57 females to 43 males in the hundred. But tadpoles fed with beef, fish and frog-flesh, yielded respectively 78, 81 and 92 females in a hundred. This was, of course, a very interesting result, but it has been pointed out that Yung did not pay sufficient attention to differential mortality, that he had not sufficiently large numbers, and that although some tadpoles are potentially hermaphrodite (with testes around the ovaries), there are others which are quite distinctly male or

female even in young stages. But the most important criticism is the first, which leads Beard, for instance, to say that Yung's experiments are only of importance in regard to the relative viability of the two sexes.

It is necessary to have renewed experiments on a large scale, and to have more precise data as to the time when the sex of the tadpole is unmistakably distinguishable. One of the objections raised against Yung's conclusions is that even in natural conditions the percentage of females is sometimes very high, but we would note that finding, say, 86·8 p.c. of females in a collection of frogs from a pond does not in itself prove that Yung's results were fallacious. There may have been, for instance, peculiar nutritive conditions in the locality where the collection was made.

7. Various observers—Landois, Treat, and Gentry—have noted that when insufficient food is given to a crowd of caterpillars there is an unusually large number of males. But as the sex of the caterpillar is said to be fixed when it leaves the egg, the experiments were probably irrelevant, and the most that they showed was that there are sometimes great differences in the rate of juvenile mortality of the two sexes. Professor Poulton observes in regard to the poplar hawk-moth (*Smerinthus populi*), for instance, that the female larvæ being larger require more food, and will therefore starve first when supplies are scarce. Kellogg and Bell found that the sex of the silkworm is not appreciably affected by the nutrition of parents or even grandparents, and Cuénot found that the sex of blow-fly larvæ was not affected by what they ate or by what their parents ate.

8. It must be admitted, then, that there is no cogent evidence to show that environmental influences operating on a developing organism may decide what its sex is to be. On the other hand, when we recall how a little nutritive attention makes a worker-grub a queen-bee, or how Aphides produce females parthenogenetically through months (or even years) of high feeding and pleasant temperature, and how the advent of autumn, with its cold and its scarcity of food, is followed by a birth of males, and so on, we may not be able to share the dogmatism of some who assert that the theory of the environmental determination of sex is preposterous. We shall consider in a subsequent section the question of the influence of the environment on the parents.

B.—IS THE SEX QUITE UNPREDESTINED IN THE GERM-CELLS BEFORE FERTILIZATION, AND IS IT THEN SETTLED BY THE RELATIVE CONDITION OF THE GAMETES, OR BY A BALANCING OF THE TENDENCIES THEY BEAR, NEITHER GAMETE BEING NECESSARILY DECISIVE?

9. Hofacker (1823) and Sadler (1830) independently published statistics in support of the theory that when the male parent is the

older the offspring are preponderatingly male, and *vice versa*. In short, the sex of the offspring tends to be that of the older parent. This has not been confirmed, and Schultze's experiments tell strongly against it.

Yet it seems fair to notice, that if the germ-cells remain for some time undetermined in regard to the sex which they will express—in other words, if they retain for some time the potentiality of either—there is no *a priori* reason against the theory that the absolute and relative ages of the parents may have influence.

Or, again, even if the ova and spermatozoa are, from their first appearance as such, determined towards female-production or towards male-production, the age of the parent may favour the production of one kind rather than of the other, or may favour the survival of one kind rather than of the other.

10. It is hazardous for the inexpert to draw conclusions from statistics, but there seems evidence in mankind of a correlation between the age of the mother and the sex of the child. The younger mothers have more female children; the older mothers have more male children. On this the self-regulating balance of sex in a nation depends. When females are scarce—for instance, in a colony—they mate early, and supply the demand for girls. When men are scarce—for instance, after war—there are more late marriages, and therefore more boys.*

11. By many authors, e.g. Girou, and at various dates, the theory has been propounded that the sex of the offspring tends to be that of the more vigorous parent. This is a favourite opinion among breeders and among the fathers of many boys, but it lacks substantiation, and the concept of comparative vigour is too vague to be useful.

So far as parental vigour may depend on what may be called strained reproduction, or on deterioration supposed to result from close in-breeding, Schultze's experiments on mice do not in the least confirm the view that it has any effect on the proportions of the sexes.

Starkweather was responsible for the theory that the sex of the offspring tends to be the opposite of that of the superior parent; but there do not seem to be any secure facts warranting the idea that a prepotent sire has any influence on the sex of the offspring, giving them a bias either towards his own sex or towards the opposite.

11A. Van Lint maintains that the offspring has the sex of the sexually weaker parent, i.e. the parent whose sex-cells are relatively the weaker at the time of fertilization. If a relatively feeble ovum is fertilized by a relatively vigorous spermatozoon, the embryo will be a female, but its body will follow the father. The author

* See R. J. Ewart, *Nature*, Jan. 5, 1911.

explains under six heads what is meant by being sexually weaker or stronger, but he naïvely points out that the sure and certain sign of a man's being more sexually vigorous than his wife is his having a daughter. The sex of the child settles the question. "Le sexe de l'enfant tranchera la question." The theory lacks scientific backing.

12. It has been repeatedly suggested that a determining factor may be found in the relative maturity or freshness of the sex-cells which unite in fertilization. Thury and other breeders have maintained that an ovum fertilized soon after ovulation is likely to produce a female. That is to say, the fresher ovum, not exhausted in any way, e.g. by continuing to live without feeding, will tend to produce a female. The bias of the ovum may be corroborated or contradicted by the condition of the fertilizing spermatozoon.

As the outcome of a very large series of experiments, Professor Richard Hertwig found that either over-ripeness or under-ripeness of the eggs (due to artificially delaying or hastening fertilization) led to a large excess of males. Unfortunately, as in the case of Yung's experiments, the cogency of Hertwig's results is lessened by the high mortality of the tadpoles and the possibility that this is differential.

A side-light is here available from Vernon's experiments on hybridizing sea-urchins, for he found that the offspring of a cross usually exhibited the characters of the parent whose germ-cells were the fresher, the less stale, at the time of fertilization.

13. From a survey of 200,000 births in Buenos Ayres, Pearl found that the proportion of males is distinctly greater (1.5 per cent.) when the parents are of different races.

14. In connexion with fertilization we may notice a theory that has been suggested by Prof. H. E. Ziegler. Let us start with a fertilized ovum whose chromosomes have become fixed towards female development: at a certain stage in the development the reproductive cells are segregated; let us suppose that they, like the fertilized ovum, have a predisposition to develop into females; let us suppose that this predisposition is not affected by nutritive oscillations in the body; let us suppose a similar state of affairs in a male; and that fertilization occurs. A number of chromosomes, say twelve, in a spermatozoon from the male parent, which tend by hypothesis to be the material basis of male offspring, unite in fertilization with an equal number of chromosomes in an ovum from the female parent, which tend by hypothesis to be the material basis of female offspring, then the fertilized ovum will not be biased towards the production of either sex, as far as its complement of chromosomes is concerned. On this view the proportions of the sexes should be equal, which is often far from being the case.

Prof. Ziegler's suggestion is that since the parental chromo-

somes include contributions from grandfather and grandmother, and since the relative numbers of these depend on the chances of the reduction division in maturation, it will be a "toss-up" whether grandfatherly or grandmotherly chromosomes predominate. If the former, the child will be a boy; if the latter, a girl.

Suppose the potential offspring has 12 chromosomes from the father and 12 from the mother, as in the human species: "If amongst the former there are 8 grandmother chromosomes and amongst the latter 7 grandmother chromosomes, the child will be a girl, for there are at least 15 of the 24 derived from the grandmother's side."*

15. Probably, however, this speculation is inadmissible. We must rid our minds of the view (held by many in the past) that there is in ordinary cases any necessary *intrinsic* bias in the egg to produce a female, any necessary *intrinsic* bias in the spermatozoon to incite the development of a male, and that there is thus a combination of maleness and femaleness in the fertilized egg. It is enough to recall the fact that the drone-bee has a mother but no father, and the same is true of many Hymenoptera. This is but a striking instance of the numerous facts which lead us to conclude that every germ-cell—whether ovum or spermatozoon—has in it the potentiality of the distinctive characters of both sexes. At some stage or other, as we are discussing, something occurs, perhaps a fixing of the metabolism-rhythm, perhaps some alteration of the ratio between nucleoplasm and cytoplasm, perhaps the introduction of a specific qualitative sex-determinant in fertilization, which decides whether the masculine or feminine hereditary characters will find expression.

16. Finally, in reference to the question of the relative conditions of the parents at the time of fertilization, we must refer to O. Schultze's prolonged experiments with enormous numbers of mice, which are good subjects, being ready to breed when seven weeks old, and littering it may be every three weeks, if not allowed to suckle. He found that the proportions of the sexes were unaffected by age of parent, by apparent vigour, by consanguineous unions, by frequency of births, or by any kind of nutritive change. And one doubts whether there is much warrant for supposing that the germ-cells come together free from any sex-predestination, or that much importance can be attached to their relative condition at the time of amphimixis. On the other hand, the experiments of such a careful worker as Richard Hertwig incline one to keep the question open a little longer. The possibility that determination occurs in fertilization when already predestinated germ-cells meet, will be discussed later on.

* T. H. Morgan, "Experimental Zoology," 1907, p. 419.

C.—IS THE SEX PREDESTINED AT A VERY EARLY STAGE BY THE CONSTITUTION OF THE OVUM, OR OF THE SPERMATOZOON, OR OF BOTH, THERE BEING FEMALE-PRODUCING AND MALE-PRODUCING GERM-CELLS, PREDETERMINED FROM THE BEGINNING, AND ARISING INDEPENDENTLY OF ENVIRONMENTAL INFLUENCE?

On a third view, the bias towards one sex is established at a very early date—in the germ-cells themselves.

(A) *Two kinds of Ova.*

17. It may be that there are two kinds of ova—some predisposed to developing into males, others predisposed to developing into females—a view not inconsistent with the assumption that all ova carry the material basis that can produce a complete equipment of both masculine and feminine characters. What evidence is there of two kinds of ova?

There is no doubt that some animals normally produce two sizes of ova. In certain cases, e.g. *Phylloxera* among Insects, and *Hydatina senta* among Rotifers, there are large eggs which develop into females, and small ones which develop into males. Both develop parthenogenetically, so that the problem is not complicated by the influence of the sperm.

In *Dinophilus apatris*, according to Von Malsen, and in a mite, *Pediculopsis*, according to Reuter, where fertilization occurs as usual, there are large and small ova, respectively female-producers and male-producers.

One must not too hastily conclude that the size determines the sex, since it may equally well be that the predisposition to a particular sex determines the size. The ovum of relatively greater anabolic bias will gather into itself more reserve material. Perhaps the occurrence of two kinds of ova will turn out to be commoner than is supposed. Thus Baltzer has recently described it in sea-urchins.

18. In some of the higher Pteridophytes there are two kinds of spores, micro- and macro-spores, which produce respectively male and female prothallia. Professor E. B. Wilson notes that a similar predestination, not marked by visible differences, has been proved by Blakeslee in both zygotes and spores of various species of fungi, and that it has also been demonstrated in liverworts and mosses. He refers in particular to the recent studies of the Marchals on dioecious mosses. "Isolation cultures prove that the asexual spores, though similar in appearance, are individually predestined as male-producing and female-producing; and all efforts to alter this predestination by changes in the conditions of nutrition, such

as are known to be effective in the case of fern prothallia, failed to produce the least effect."

19. The view that there are two kinds of ova, determined *ab initio* as male-producers and female-producers, has found a vigorous supporter in Beard, who finds visible evidence of this in the skate. He maintains that the sex is determined when the primitive germ-cells divide into oocytes. In his 1902 paper on "The Determination of Sex in Animal Development," Beard scouted the idea of environmental interference with the determination of sex. "Any interference with, or alteration of, the determination of sex is absolutely beyond human power. To hope ever to influence or modify its manifestations would be not less futile and vain than to imagine it possible for man to breathe the breath of life into inanimate matter." To this, an experimenter like Russo would answer that he has succeeded in effectively interfering with the determination of sex. Although it may not be possible to alter the bias of an egg which has become fixed as a male-producer or a female-producer, it may be possible by altered nutrition to change the proportions of these two kinds of eggs in the maternal ovary, and it may be possible in other ways to change the normal proportions of survival.

20. We give one instance of the numerous facts that might be cited as suggestive in connexion with the theory of two kinds of ova determined in the ovary as male-producers and female-producers. In the case of five eggs laid by a sparrow-hawk (according to Shufeldt), the first became a male, the second a female, the third a male, the fourth a female, and the fifth a male—in regular alternation. Yet these were produced in a short time from *one* ovary, and probably fertilized by the same set of spermatozoa.

21. Of much interest are the facts of Poly-embryony—the production of multiple embryos from one ovum. In the armadillo *Praopus (Tatusia) hybrida* von Jhering found on two occasions eight embryos within one chorion—presumably, therefore, from one ovum—and all were males. In some parasitic Hymenopterous insects, e.g. *Encyrtus*, investigated by Marchal and Bugnion, *Litomastix* and *Agrniaspis*, investigated by Silvestri, one segmented ovum forms a group of embryo, all of the same sex—female if the egg be fertilized, male if it be not fertilized. These facts suggest that the sex of the offspring is quite determined in the egg.

(B) *Two kinds of Spermatozoa.*

22. In about thirty different kinds of animals, such as the freshwater snail *Puludina*, and the freshwater beetle, there are dimorphic spermatozoa, and it has been suggested that each kind is predisposed towards the development of one sex. There is however, no definite evidence of this.

(c) *The Accessory Chromosome.*

23. Of great interest are the facts that have recently come to light regarding what is called *the accessory chromosome*. In a number of Insects, Myriopods, and Arachnids, the females have more chromosomes in their cells than the males have. In the simplest cases (*Anasa*, *Protenor*) the female has one more chromosome than the male, and the egg has one more likewise. Now half of the spermatozoa differ from their neighbours in having the same number of chromosomes as the egg, while the others have one fewer. This extra chromosome which half have and half have not is called the X-element or accessory chromosome. There are facts which go to show that fertilization of the eggs by one class of spermatozoa results in males, by the other in females. When two equal numbers come together the result is a female.

The chromosomic dimorphism has been proved in about a hundred species, but all are not equally convincing, and there are many variations in detail. As the subject is difficult, especially without diagrams, and as the facts have been repeatedly summed up in the last few years (e.g. by Wilson, who has contributed more than any other to the investigation), we do not propose to do more than refer to two or three important points.

(a) In many cases, instead of there being an accessory chromosome in one half of the spermatozoa and no corresponding body in the other half, there is a "large idiochromosome" or X-element in one half and a "small idiochromosome" or Y-element in the other half.

(b) The evidence that the one set of spermatozoa induce male-development and the other set female-development is indirect; it is obtained by an examination of the state of the chromosomes in the body-cells of the offspring. The Y-element, for instance, is found only in the males, while the X-element is found in both sexes, but doubled in the female, single in the male.

(c) Wilson gives the following formulæ:—

(a) In the absence of a Y-element

Egg X + spermatozoon X = zygote XX (female).

Egg X + spermatozoon no X = zygote X (male).

(b) In the presence of a Y-element

Egg X + spermatozoon X = zygote XX (female).

Egg X + spermatozoon Y = zygote XY (male).

24. A fine corroboration of the importance of the chromosomes has been recently afforded by the work of T. H. Morgan on *Phylloxera* and of von Baehr on *Aphis saliceti*. In these forms half of the spermatocytes degenerate (as Meves pointed out in the bee), namely those without the accessory chromosome; therefore all the spermatozoa are female-producers, and every one knows that all

the fertilized ova produce females. An interesting accessory discovery is that in Phylloxera and Aphides; the males have in their bodies one chromosome fewer than the females have. "The male-producing egg," Wilson notes, "must therefore eliminate one chromosome, and this, we cannot doubt, is the X-element."

25. These cytological studies are so very striking that one inquires anxiously as to the distribution of the phenomena in the animal kingdom. There have been some noteworthy recent extensions.

An accessory chromosome is reported by Boveri and Gulick in *Heterakis*, a Nematode of the pheasant. The ovum has five chromosomes; the sperms are of two types, one with four, the other with five—a condition similar to that described by Wilson for *Protenor*, one of the Hemiptera. In the common *Ascaris megalocephala* there is also evidence of an accessory chromosome, but it seems at present somewhat discrepant and difficult. As one would expect from the difficulty of the inquiry, there is still considerable discrepancy of description in regard to many cases in which an accessory chromosome has been affirmed. It is very interesting to inquire whether there is any hint of an accessory chromosome in Vertebrates. In a recent paper, Professor M. F. Guyer brings forward evidence to show that in man half of the spermatids (or immature spermatozoa) have ten, and half twelve chromosomes, which would correspond to one of Wilson's cases; *Syromastes*, where half of the spermatids were found to possess two more chromosomes than the others. Guyer has found evidence, still unpublished, which leads him to think that, as regards accessory chromosomes, conditions obtain among Vertebrates (fowl, guinea-pig, rat, and man) similar to those found in numerous Tracheates, and he ventures to express the expectation that the somatic cells of man will be found to contain twenty-two chromosomes, and those of woman twenty-four chromosomes.

26. The theory that the presence of one X-element in a fertilized ovum means male offspring, and that the presence of two means female offspring is morphological, and our physiological sense is left unsatisfied. Is the difference significant in itself, or as an index of metabolic differences? If the eggs with more chromatin than their neighbours develop into females, and if chromatin be an index of a relatively preponderant anabolism or anabolic capacity, can the theory be brought into line with the thesis of "The Evolution of Sex," that the female is the outcome and expression of relatively preponderant anabolism, and the male of relatively preponderant katabolism? On the other hand, it may be that the additional chromatin material is of *qualitative* importance. To give point to his theory, Professor E. B. Wilson suggests quite provisionally that the X-element contains factors (enzymes or hormones?) that are necessary for the production of

both the male and the female characters; that these are so adjusted that in the presence of a single X-element the male character dominates, or is set free; and that the association of two such elements leads to a reaction which sets free the female character.

27. Here we may refer to Professor E. B. Wilson's proposal to draw a distinction between sexual predetermination and sexual predestination. "The definitive determination of maleness or femaleness only occurs when all the factors necessary to their production have been brought together. This *may* be effected before fertilization ('progamic determination' of Haecker), but may also first ensue upon union of the gametes ('syngamic determination'). Thus one may suppose that all the sexual eggs of a queen-bee and of Maupas' *Hydatina* are predestined towards *maleness*, but this is reversed by fertilization when determination occurs."

D.—ARE MALENESS AND FEMALENESS MENDELIAN CHARACTERS?

28. We have seen that many facts point to the conclusion that the sex-cells have definite sexual tendencies or predispositions. The question has naturally arisen whether these tendencies to male-production or female-production correspond to two contrasted Mendelian characters, to the dominant and recessive members of a pair of allelomorphs. This Mendelian interpretation of sex, first suggested by Strasburger, has been developed by Castle, Correns, Bateson, and others. As Professor Wilson points out, the interpretation has taken "three forms, which exhaust the *a priori* possibilities. These are, first, that both sexes are sex-hybrids, or heterozygotes (Castle); second, that the male alone is a heterozygote, the female being a homozygote recessive (Correns); third, that the female is the heterozygote, the male being a homozygote recessive (Bateson)."

As Professor Wilson has shown, each of these forms of the theory has its special difficulties, which seem to be most serious in the case of the first.

Professor Correns's theory was based on beautiful experiments in crossing dioecious and monoecious forms of Bryony, which showed that the monoecious condition behaves as a unit character, which is recessive to the dioecious.

The experiments made by Correns go to show that the pollen-grains of the dioecious Bryony, though apparently all alike, must be regarded as of two kinds in equal numbers—male-producing and female-producing. What immediately arise, as a matter of fact, are the rudimentary male prothallia, which produce the reproductive gametes or pollen-nuclei, and the egg-cells fertilized by half of these produce male-plants, while the egg-cells fertilized by the other half produce female-plants.

The third form of the Mendelian interpretation is supported by a number of very striking facts, especially in regard to the common magpie-moth (*Abraxas grossulariata*) and the canary. Let us re-state it very briefly. Assuming that there are sex-determinants of maleness and femaleness, the experimenters suggest (1) that these behave as Mendelian units, femaleness being always dominant over maleness; (2) that female individuals are heterozygous as regards sex (having maleness recessive) and that they give rise to equal contingents of male-producing and female-producing ova; (3) that male individuals are homozygous as regards sex, and give rise only to male-producing spermatozoa; (4) when a male-producing spermatozoon fertilizes a male-producing ovum the result is of course a male; when a male-producing spermatozoon fertilizes a female-producing ovum the result is a female, femaleness being by hypothesis dominant over maleness.

29. Doncaster refers to the confirmation which the Mendelian theory of sex receives from the results of castration. In Vertebrates the castration of the male may prevent the expression of masculine features, but it does not induce the expression of feminine characters. This may mean that the male is homozygous. I would, however, point out that in many cases there is a lack of positiveness in the feminine characters; the masculine characters are usually positive and distinctive. In other words, a good deal of latent femininity might express itself in the castrated male without there being much to show for it. It would be extremely interesting, if feasible, to experiment with some case like the Red-necked Phalarope, where the female bird is the more masculine of the two.

When a Vertebrate female is castrated, or when the ovary atrophies, there is often a development of masculine characters. Let me quote a striking case from Guthrie. A spae'd pullet may acquire not only the outward structural features of the opposite sex—cock's comb, wattles, long hackle and tail feathers, rapidly developing spurs, carriage, etc.—but the behaviour as well and the pugnacious character.

It may be pointed out that these facts, while fitting in well with the Mendelian interpretation that the female is heterozygous, also bear out the general idea that every germ-cell carries with it a complete inheritance of masculine and feminine characters, and that it is the particular kind of metabolic rhythm set up that determines maleness and femaleness, and, through this, or more directly, affords the liberating stimuli for the masculine or feminine characters.

In Crustaceans the course of events is curiously the reverse of what is true of Vertebrates. A female whose ovary has been destroyed by a Rhizocephalous parasite has its secondary sex characters reduced, but a castrated male assumes more or less completely the characters of the female. Perhaps the female characters

are more positive here, e.g., the broad abdomen. "If the parasite dies and the host recovers, the ovary of the female may again become functional; but in the male under such circumstances eggs may be produced in the testis. Geoffrey Smith concludes from these observations and from others on the Cirripedes, that the female is homozygous in sex and the male heterozygous. There seems no *a priori* reason," Mr. Doncaster continues, "why this should not be true in the case of Crustacea and flowering plants, while the converse is the case in moths and Vertebrates."

30. The fact that the proportions of the sexes are sometimes very variable (as Heape points out in regard to canaries) does not of itself tell against the view that the ova are determined at an early stage to be male-producers or female-producers. There may be a process of discriminate selection during the maturing of the ova, and we know that in higher Vertebrates the possible ova do not all come to maturity.

That the proportions of the sexes in different types are very diverse seems at first sight to tell against the idea of an internal automatic production of two kinds of gametes—"against the existence of an intrinsic and uniform mechanism of sex-production and against the specific assumption that sex is transmitted as a Mendelian character." But Professor E. B. Wilson suggests that this difficulty may be overcome by supposing that there is a disproportion in the number of one kind of spermatozoa (like that which reaches a climax in Aphids, Daphnids, etc., where only the female-producing spermatozoa are left), or that there is a certain proportion of impotent spermatozoa, as is well known to be true of the pollen-grains of some flowering plants, like *Mirabilis*.

E. — CAN ENVIRONMENTAL AND FUNCTIONAL INFLUENCES, OPERATING THROUGH THE PARENT, OR, IN SHORT, THE PARENT'S ACQUIRED PECULIARITIES, ALTER THE PROPORTION OF EFFECTIVE FEMALE-PRODUCING AND MALE-PRODUCING GERM-CELLS ?

31. Supposing that an immature ovum is as likely to develop into a male as into a female, we can conceive it possible that a change in the nutrition of the parent may decide its destiny. Or, going further back, supposing the original germ-cells are already, as Mendelian theory would lead us to expect, divided into two camps, male-producing and female-producing, it may be that environmental conditions can influence the relative rate of increase and percentage of survival in these two camps.

32. From human statistics some have tried to prove that abundant food favours the production of female offspring, and *vice versa*; but others have concluded, also from statistics, that the parental nutrition is of no moment, unless in bringing about a differential death-rate. The fact that 30 p.c. of human twins are of different

sexes seems enough to show that the dieting of the parent is not of great importance. Schenk's notorious theory (1898) that the sex of children could be adjusted by dieting the mothers, rested on entirely insufficient evidence—a very small number of cases.

In a statistical enquiry in London, Prof. Punnett found that the proportion of males is lowest (99·5) in the poorest quarter and highest (100·7) in the wealthiest, but he concluded that the differences are due to differential infantile mortality, birth-rate, and probably marriage-rate.

33. Careful experiments have been made, e.g. by Quénot and Schultze, on the possible influence of the nutrition of the mammalian parent (e.g. mouse) on the sex of the offspring; but the results are all against the reality of this supposed influence, in which, however, some breeders strongly believe. Schultze extended his experiments over three generations, but the high feeding of grandparents as well as parents did not seem to have any influence on the proportion of the sexes among the offspring.

Against these results, however, we have to balance the very important work of Heape, who has brought forward evidence for mammals and birds that peculiarities in nutrition and in other environmental influences may exert a selective influence on the germ-cells, affecting the proportion of male-producing and female-producing gametes. "Through the medium of nutrition supplied to the ovary, either by the quantity or the quality of that nutrition, either by its direct effect upon the ovarian ova or by its indirect effect, a variation in the proportion of the sexes of the ova produced, and therefore of the young born, is effected in all animals in which the ripening of the ovarian ova is subject to selective action." "When no selective action occurs in the ovary, the proportion of the sexes of ovarian ova produced is governed by the laws of heredity."

34. As it seems to us, Russo's recent experiments in feeding rabbits with lecithin lend considerable support to the view that the germ-cells may be pre-disposed to one sex or the other by the nutritive condition of the parent, and to the view that the difference between the sexes is primarily a question of the rhythm of metabolism. Russo attaches much less importance to the chromosomes and much more importance to the nature of the metabolism than do most biologists of to-day. He says, in so many words, that he believes the sex of the offspring to depend on the special metabolism of the germ-cells; and he thinks he has succeeded in artificially altering the metabolism of the ovarian ova, and thus altering the normal proportions of the sexes. In the normal ovary there are well-nourished and ill-nourished ova, and the proportion of the former can be increased by lecithin treatment.

Female rabbits fed (in various ways) with lecithin developed large ovaries, large Graafian follicles, ova rich in nutritive material,

and an unusual number of female offspring. The sperm may, as it were, corroborate the bias of the ovum, for the percentage of female offspring is higher when both parents are fed with lecithin. It is not possible to follow the ova and prove that a relatively anabolic one always becomes a female, and never a male, and so on, but the argument from altered proportions seems sound. It is interesting to notice Russo's statement that in nature male offspring are always in the majority, from 52 to 58 per cent. A curious result of Russo's experiments must also be mentioned, though we cannot follow it up—that the more highly nourished ova produce not only females, but females with the maternal colour.

It has been objected to Russo's work that one of the two kinds of ova he distinguished was due to degenerative changes, and that he worked with selected families of rabbits.

An acute friend, Dr. Ronald Macfie, has suggested to me that it would be extremely interesting to try on both parents the converse of Russo's experiment, by seeking to promote relatively greater katabolism—for instance, by increased oxygenation.

35. We should be slow, I think, to reject the view that changes in nutrition and other environmental conditions may affect the mother so as to alter the ordinary proportions of the sexes. Issakowitsch, working with the parthenogenetic females of the Daphnid *Simoccephalus*, von Malsen, working with *Dinophilus apatris*, in which the ova are fertilized, found that differences of temperature affected the proportion of the sexes, apparently by affecting the nutrition of the mothers. Both sets of experiments are the more satisfactory in that they seem to be free from any fallacy due to differential death-rate in the young of the two sexes.

36. Many experiments have been made with the Rotifer *Hydatina senta*, but the results are conflicting. There is great sex dimorphism, the males being small and gutless. The females are from birth either male-producers or female-producers; and, according to Maupas and Nussbaum, this is determined before birth, while the female embryo is still within its mother's uterus, by conditions of temperature and nutrition. Well-fed mothers produce females which produce females only; starved mothers produce females which produce males only. According to Punnett's researches, however, changes of temperature and nutrition have no effect; but some stocks give rise to many male-producing females, others to few or none.

37. Another piece of evidence in support of the conclusion that environmental influences may count is furnished by Nussbaum's elaborate experiments on *Hydra grisea*, which he subjected to varying nutritive conditions. In this species hermaphrodite and dioecious forms occur and periods of asexual budding. Nussbaum found that he could bring on sexual reproduction by altering the nutrition, that the optimum nutritive conditions were marked by a pre-

dominant production of female polyps, and that groups wholly male could be produced by relative starving. It seems from these experiments that in Hydra at any rate the nutrition of the body determines the production of ovary or testis. This corroborates the physiological view of sex. It would be interesting, though obviously difficult, to go a step further and inquire whether the fertilized ova of highly nourished females showed any tendency, in normal environment, to develop into female rather than male or hermaphrodite polyps.

38. The case of Hydra suggests a reference to analogous facts in regard to plants. Klebs has shown that the mode of reproduction in *Vaucheria repens* is very plastic under environmental influence. By altering the temperature and illumination, for instance, he was able to suppress the oogonia. Prantl found that spores of the Royal Fern and of *Ceratopteris thalictroides* sown in soil without nitrogenous supplies developed into male prothallia, that female organs were formed when ammonium nitrate was supplied, and that wholly male prothallia might become wholly female prothallia. Similar results have been obtained for horsetails by Buchtien.

It is plain, of course, that in cases like fern-prothallia and Hydra, what actually occurred was the inhibition or suppression of one set of sexual organs in favour of another in normally hermaphrodite forms. Therefore such cases, though suggestive and analogous, are not quite to the point.

39. Against the possibility of environmental influence are Strasburger's numerous experiments on dioecious Phanerogams, such as *Mercurialis perennis*, spinach and hemp. He found that changes in illumination, soil, crowding, and so on, had no effect in altering the proportions of male and female offspring. He is of opinion that in such cases the sex is fixed by the time the seed is formed.

CONCLUSION.

40. The general trend of research is certainly towards the conclusion that in most cases the sex of the future offspring is predestined at a very early stage in the germ-cells, though the actual determination may not come about until fertilization occurs or does not occur. The belief which used to be widespread that environmental conditions sometimes determine the sex of the offspring during development has in greater part yielded to a criticism of the evidence, and to the demonstration given by the cytologists that predestination of the gametes sometimes occurs early in their history. It remains possible that the nutrition of the parents may influence the proportions in which the two kinds of gametes are produced and survive.

41. I find myself unable to get away from the view that there may be no sex-determinant at all in the usual sense, but that what

determines sex is a metabolism-rhythm, or a relation of nucleoplasm and cytoplasm, or a relation between Anabolism and Katabolism.

Many sets of facts lead one to suppose that each sex-cell has a complete equipment of masculine and feminine characters, and it may be that the liberating stimulus which calls the one set or the other into expression or development, is afforded by the metabolism conditions that have been set up in the field of operations, which lead also to the establishment of ovary or spermary, as the case may be.*

That the fundamental thing is a physiological alternative is suggested in various ways. For instance, there is the sometimes striking evidence that sex is "a quality that pervades all the cells of the organism." Professor Wilson notes that, "In the Mosses the Marchals demonstrate that all the products of a single spore are likewise immutably determined, since new plants formed by regeneration from fragments of the protonema, or from any part of the gametophyte, are always of the same sex."

It must be remembered that many at least of those who are keenest on the scent of morphological criteria are also alive to the importance of trying to get at the physiological realities behind these. Thus we find Professor Wilson saying, "Since the two classes of spermatozoa differ in nuclear constitution it is highly probable that they differ in respect to their metabolic processes." Or, again, "Upon what conditions within the fertilized egg does the sexual differentiation depend? In some way, we may now be reasonably sure, upon the physiological reactions of nucleus and protoplasm."

And I may be pardoned, perhaps, for quoting from a recent able article by Professor H. E. Jordan, the last paragraph: "The results of the newer investigations on sex-determination seem, at least temporarily, to have brought us back to the position of Geddes and Thomson, namely, that femaleness is causally related to a dominating cell-anabolism, and maleness to a relatively preponderant cell-katabolism. This conclusion would seem to be the base from which future investigations will start in the attempt to further elucidate the fundamental mechanism of sex-differentiation."

* When this was written I had not enjoyed the pleasure of reading Dr. C. E. Walker's *Hereditary Characters* (1910). In the chapter on "Sex and Natural Selection" he says (p. 207), "The evidence then seems to suggest that the secondary sexual characters are dependent for their development upon the presence of the sexual glands in the individual, and that the potentiality of producing them is present in all individuals of both sexes."

VII.—*On the Measurement of Grayson's New Ten-Band Plate.*

By A. A. C. ELIOT MERLIN.

(Read December 21, 1910.)

MR. GRAYSON has recently improved his ruling machine, and has kindly sent me a new ten-band plate which I have measured, with the most perfect appliances, and found to be much better than his earlier productions, good as these are. The new plate exactly resembles the older form, the ten groups running from $\frac{1}{10000}$ to $\frac{1}{100000}$ of an inch, and such is its accuracy that I greatly doubt whether the old-fashioned methods of micrometry, still almost invariably employed, could reveal the very slight inequalities which exist in the spacing. No human work is, or can ever be, perfect, but it is doubtful if any production of the kind has hitherto approached so nearly to perfection.

The plate has been most carefully standardized with a picked semi-apochromatic objective of I.M.P. 143 on 10-inch tube and 1.32 N.A., used with a W.A. of 0.95 and a screen. The micrometer is the Nelson-Powell screw-traversing form, which facilitates accurate setting and reduces such errors to a minimum. This was, of course, supported on a separate pillar-stand, and arranged so as not to actually touch the tube of the Powell No. 1. When a plate consisting of varying bands has to be measured, the most suitable optical combination is such as will yield the best average results over the entire range of rulings. With the magnification selected, the interval between the lines of a $\frac{1}{10000}$ in. spacing was found to equal about field/3, while probably field/4, or field/5, would have been chosen as likely to yield the best results had such spacings been alone in question. Such a power, however, would have proved a serious and unnecessary disadvantage on all the other nine bands, and therefore, could not be reasonably selected for the purpose of standardizing the whole plate.

The annexed table* (first set of columns) gives the results obtained. Each spacing throughout the plate was spanned twice, the "fixed" wire being first set by screw to the lower edge of a line, and the interval measured to the lower edge of the next; the setting was then repeated from upper to upper edges of the lines, and the mean of the two readings registered as the interval

* The table herewith gives the results of Mr. Merlin's measurements in summarized form. The complete tables of measurements are kept in the Society's library, and are available for reference.

between the rulings. By this plan setting errors are minimized, and the distance from centre to centre of the rulings is shown. As a matter of fact, there are occasional slight variations in the breadth of the lines themselves, and thus measures merely from edge to edge of a ruling may not indicate the exact distance from centre to centre. In the older stage micrometers* the errors of spacing were so gross that refinements of the kind were not usually employed, or necessary, in their measurement, and indeed, we find that the screw micrometer still almost universally used, with no means of accurately adjusting its "fixed" wire, is a survival of the rough methods now utterly inadequate when dealing with such a masterpiece as Grayson's new plate. The Nelson-Powell screw-setting micrometer is alone suitable for the purpose of all accurate work, for the bi-filar kind, where each wire is independently moved, introduces complicated screw errors.

A glance at the table will make it evident that the means exhibit little variation, for, taking 920.0 as the standard, the greatest divergence on each side does not amount to quite four drum divisions, or $\frac{1}{230000}$ in., and most of the means are much closer. In the measurements of the individual spacings, there is an apparently somewhat marked inequality in the first $\frac{1}{1000}$ in. space amounting to 6.3 divisions above the 920.0 mean, but this only represents a difference of about $\frac{1}{140000}$ in.

In addition to standardizing the new plate, meaned measurements were taken of the first ten spaces of the last six bands using a Powell objective of I.M.P. 122 and 1.27 N.A. This was employed with a negative amplifier, it being furnished with a correction collar, which enabled critical definition to be thus obtained with a W.A. of 0.95. It was judged inadvisable to measure the four coarser bands with this combination, as a $\frac{1}{1000}$ in. space would extend over more than three-fourths of the entire field, making parallax any other errors possible, even when all precautions are taken. The results are shown in the second set of columns of the annexed table, the intervals representing the distances from the centres of the lines. It will be seen that the extremely minute inequalities of these bands are rendered very manifest through the enormous magnification, which causes one drum division to only equal about $\frac{1}{2087000}$ in.†

The next step consisted in the measurement of the diameters of the first two lines of each band, which proved quite feasible with the optical arrangements above specified. The highest of the 20 readings thus obtained was 49.6 drum divisions, the lowest 41.0, and the mean was found to be 43.7 drum divisions.

With the magnification employed, 43.7 drum divisions represent

* See 'Carpenter,' 8th ed. p. 275.

† This is more particularly applicable to the complete table of measurements preserved in the Society's Library.

$\frac{1}{47718}$, or 0·00002096 in., the true mean diameter of the lines with the proper antipoint correction applied thus being 0·00002488 in.

In order to ascertain the results obtainable on certain of the rulings with much lower apertures and magnifications, the following measurements of the first, second, and tenth bands which are shown in the last three sets of columns of the table were effected. With these lower powers the images of the lines themselves did not prove nearly so satisfactory as with the preceding optical arrangements, although all the lenses utilized are picked specimens of their class. The difficulty of accurately setting the wires on the lines was much augmented, and it proved impracticable to secure double readings. To make matters worse, a small setting error now represents a far greater real distance than is the case with the high magnifications. It is true that the means are often close, but this is mainly due to the plus and minus errors compensating each other.

The outcome of my experience with the foregoing fairly exhaustive measurements is to convince me, beyond the shadow of a doubt, that the lower magnifications are wholly inadequate to reveal the minute real variations in lines and spacings of the new plate, while I feel equally certain that the higher magnifications employed are quite capable of doing so when used with proper appliances and strictly critical conditions, for it is especially necessary that the lines themselves be resolved so that their individual irregularities, trifling as they are, may be rendered clearly recognizable. If anyone who has not performed the arduous work under the specified conditions should cavil at the excessively small real differences indicated, and contend that such quantities are altogether beyond the grasp of the Microscope, the only alternative is that the latest production of Mr. Grayson possesses no real inequalities capable of demonstration under the highest powers and most perfect instrumental means at our disposal.

ADDENDUM.—The essential measurements on which this paper is based not being printed fully in their original form, although they have been ably abridged and handled by a member of the Society's Council, the author nevertheless finds it necessary to request the indulgence of those familiar with refined practical micrometry for any shortcomings or failure of the abridged figures, given herewith, to properly sustain all the claims made in the text, which, under the unavoidable circumstances, may, in some instances, appear to be unsupported by adequate evidence, or even resemble mere assumptions. This is practically inevitable with any curtailment of the full figures and measurements of the individual spacings, which are, in themselves, means of double-edge readings.

VIII.—*Australian Rotifera: Collected by the Shackleton Antarctic Expedition, 1909.*

By JAMES MURRAY, F.R.S.E.

PLATES IV. AND V.

(This preliminary Report is published with the consent of Sir Ernest Shackleton.)

(Read March 15, 1911.)

ON the return of the 'Nimrod' from the Antarctic, a stay of nearly a month in New South Wales, and a few days in Queensland, afforded opportunities for extensive collecting of Australian Rotifera, etc.

In New South Wales we collected in and around Sydney, and in the Blue Mountains and Australian Alps. In the cool climate of the Alps the Rotifer fauna closely resembled that of Britain, only two species occurring which are unknown there. The Blue Mountain region was very much more productive, and all the new species were obtained there.

I have to thank Mr. C. F. Rousselet for much assistance in preparing the Bibliography of this and subsequent papers, and for giving me the benefit of his advice in regard to the few non-Bdelloid Rotifera collected. I have to thank Mr. D. Bryce for similar assistance with the Bdelloida.

The necessity for subdividing this paper, which was originally written to be published as a whole, has given rise to some asynchronisms—references in earlier parts to species which are not

EXPLANATION OF PLATE IV.

- Fig. 1.—*Philodina australis* sp. n.
 „ 2a.—*Callidina armillata* sp. n.
 „ 2b.—Ditto. Ditto. Ventral side of head.
 „ 2c.—Ditto. Ditto. Rostrum and lamellæ.
 „ 2d.—Ditto. Ditto. Jaw.
 „ 3a.—*Callidina lepida* sp. n.
 „ 3b.—Ditto. Ditto. Spurs.
 „ 4a.—*Callidina longistyla* sp. n.
 „ 4b.—Ditto. Ditto. Jaw.
 „ 4c.—Ditto. Ditto. Antenna, to same scale as 4a.
 „ 4d.—Ditto. Ditto. Head and rostrum.
 „ 4e.—Ditto. Ditto. Side view of rump and foot.
 „ 4f.—Ditto. Ditto. Spurs.
 „ 5.—*Habrotrocha angusticollis*; var. with curved neck.
 „ 6a.—*Habrotrocha strangulata* sp. n.
 „ 6b.—Ditto. Ditto. Head and neck.
 „ 6c.—Ditto. Ditto. Jaw.
 „ 6d.—Ditto. Ditto. Spurs.
 „ 6e.—Ditto. Ditto. Side view of foot.

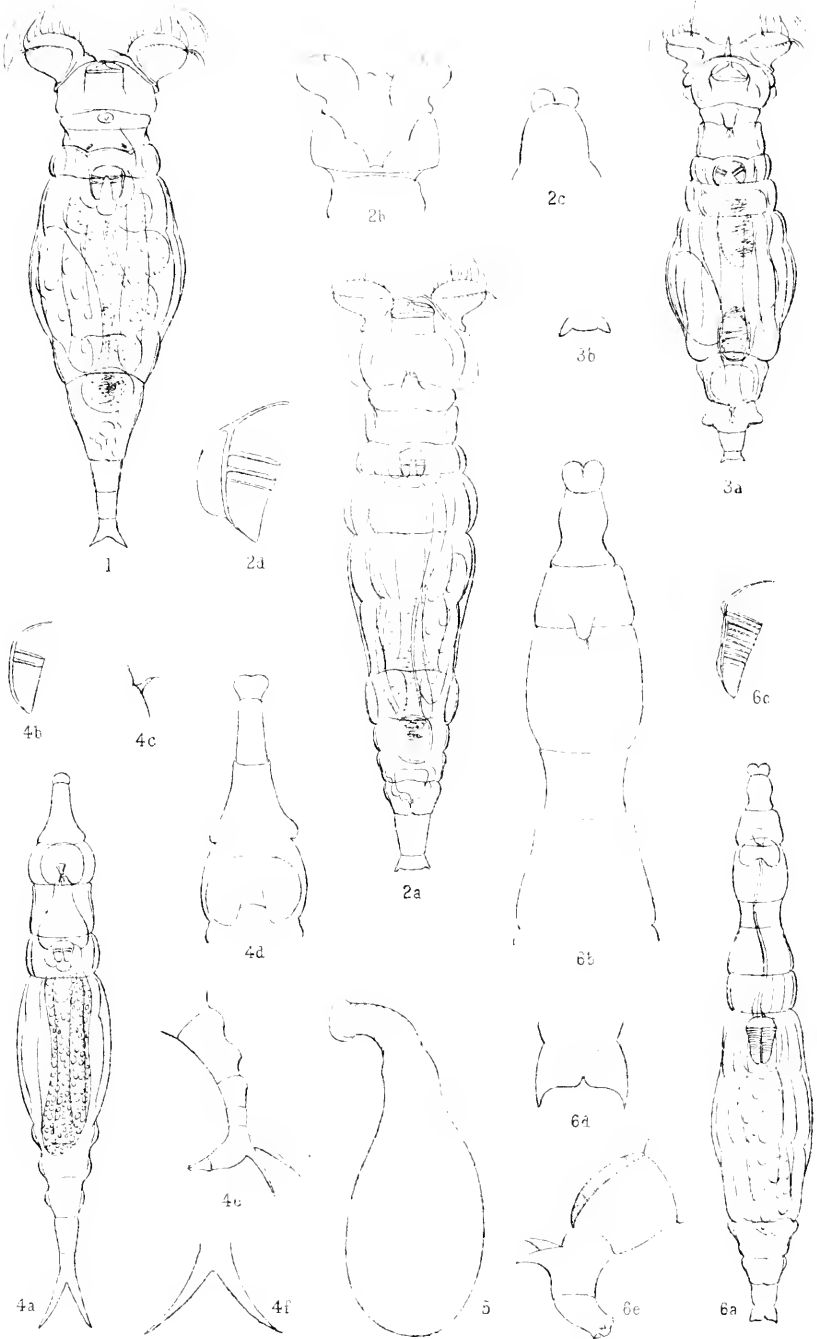

G. Murray del. ad nat.

West, Newman photo-lith.

AUSTRALIAN ROTIFERA.

described till later parts. As far as possible, these have been explained by notes in parentheses.

Historical Sketch.—This notice of works on Australian Rotifera makes no claim to be complete. I have not yet had time to seek carefully through the Australian Societies' publications for recent years. It is a note of such works as I have seen or heard of, and is chiefly concerned with the Bdelloids. These have received scant attention in Australia, as usual everywhere and always.

Schmarda, 1859 (5)* found *Pterodina patina* in New South Wales. Thirty years later, Thorpe (11) in his first list of Queensland Rotifers, makes the first mention of a Bdelloid (*Actinurus*). Whitelegge's list, 1889 (16), contains 110 species (6 Bdelloids). Thorpe's second list of Queensland Rotifers, 1889 (12), includes 4 Bdelloids, and in another paper in the same year (13) he notes 5 Rhizota, a *Brachionus* and *Pedalion*. Also in 1889 (2) Hudson and Gosse describe 3 new Rhizota, and mention a fourth. Anderson and Shephard, 1892 (1), in their list of Victorian Rotifers, note 4 Bdelloids. Strickland, 1894 (10), also notes 4 Bdelloids.

Papers by Thorpe, 1891 (14); Shephard, 1896 (6), 1897 (7), 1899 (8); Shephard and Strickland, 1899 (9); Rousset, 1899 (3) and 1900 (4), deal with Rhizota only. Thorpe, 1893 (15) notes an *Asplanchna* and *Asplanchnopus*.

The Bdelloids in all these works number only 9 species—*Philodina roseola*, *citrina*, *megalotrocha*, *aculeata*; *Rotifer vulgaris*, *macroceros*, *citrinus*, *tardus*, *neptunius*.

The *Rotifer citrinus* in the above list is not recorded by anybody, but Strickland's notes on a *Rotifer* sp. ? (10), which he thinks may be *R. macrurus*, seem to me to indicate *R. citrinus*.

LIST OF SPECIES.

PLOIMA.

In the water supply of Sydney, and in ponds in the public parks, a few species other than Bdelloids were noted. As most of them are already in Whitelegge's list for the same district, they are omitted from this list. I only note a few which are not in Whitelegge's paper.

Triarthra brachiata Rouss.

Notops minor Rouss.

Dinocharis inornata Hilzendorf.

Metopidia acuminata Ehr.

M. rhomboides Gosse.

Diaschiza gibba (Ehr.).

Brachionus urceolaris Ehr.

Pedalion sp.

* The figures in brackets refer to the Bibliography at the end of the paper.

BDELLOIDA.

	Sydney.	Katoomba.	Australian Alps.	Queensland.
<i>Philodina australis</i> sp. n.	+			
<i>P. brevipipes</i> Murray		+		
<i>P. plena</i> (Bryce)		+	+	+
<i>P. vorax</i> (Janson)				+
<i>P. rugosa</i> Bryce		+		+
<i>Pleuretra alpium</i> (Ehr.)	+	+	+	+
<i>Dissotrocha macrostyla</i> (Ehr.)	+	+	+	+
<i>Callidina habita</i> Bryce		+	+	+
<i>C. formosa</i> Murray	+	+		+
<i>C. quadricornifera</i> (Milne)		+	+	+
<i>C. plicata</i> Bryce		+	+	
<i>C. punctata</i> Murray		+		+
<i>C. ehrenbergii</i> Janson		+		
<i>C. armillata</i> sp. n.		+		
<i>C. lepida</i> sp. n.	+	+		
<i>C. longistyla</i> sp. n.		+		
<i>C. papillosa</i> (Thomp.)	+	+		+
<i>C. multispinosa</i> (Thomp.)		+		+
<i>C. serrulata</i> sp. n.		+		
<i>C. mirabilis</i> sp. n.		+		
<i>C. microcornis</i> Murray		+		
<i>Mniobia tetraodon</i> (Ehr.)		+	+	
<i>M. russeola</i> (Zel.)		+	+	
<i>M. scabrosa</i> Murray				+
<i>Rotifer vulgaris</i> Schrank			+	
<i>R. hapticus</i> Gosse			+	
<i>R. longirostris</i> (Janson)	+	+	+	+
<i>R. montanus</i> Murray			+	
<i>Habrotrocha angusticollis</i> (Murray)	+	+	+	+
<i>H. longiceps</i> (Murray)		+		+
<i>H. perforata</i> (Murray)		+		+
<i>H. caudata</i> Murray		+		
<i>H. pusilla</i> (Bryce)		+		+
<i>H. constricta</i> (Duj.)	+	+		
<i>H. tridens</i> (Milne)			+	
<i>H. strangulata</i> sp. n.		+		
<i>H. leitgebii</i> (Zel.)		+	+	
<i>H. auriculata</i> Murray		+		
<i>H. aspera</i> (Bryce)	+	+		
<i>Scephanotrocha rubra</i> Bryce			+	
<i>Ceratotrocha cornigera</i> (Bryce)			+	
<i>Adineta vaga</i> (Davis)		+	+	
<i>A. gracilis</i> Janson			+	
<i>A. barbata</i> Janson		+	+	
<i>A. tuberculosa</i> Janson			+	
<i>A. longicornis</i> Murray		+	+	

NOTES ON THE SPECIES.

Philodina australis sp. n., pl. IV. fig. 1.

Specific Characters.—Small, hyaline, free-swimming; corona as wide as trunk; sulcus as wide as disk; lobes of upper lip widely separated, not reaching level of convex bridge; rostrum and antenna short; eyes small, oblong; teeth 2; foot 4-jointed; spurs short, conical, acute, divergent, without interspace.

Length 280 μ , width of corona 85 μ , neck 48 μ , trunk 85 μ . Central trunk barrel-shaped; collar inconspicuous; jaw triangular.

Apparently an eastern representative of *P. megalotrocha*, which it closely resembles. It differs in the smaller corona, short rostrum, and short antenna. *P. megalotrocha* has larger eyes and top-shaped trunk, and it usually keeps the rostrum extended when swimming, which *P. australis* does not do. *P. megalotrocha* is also recorded for Australia, but we did not find it.

Habitat.—Common in the water-supply of Sydney. Afterwards found in Vancouver.

Philodina plena (Bryce).

In Australia *P. plena* tends to have more than the normal number of teeth, though otherwise typical. Teeth 3 to 5 in each jaw. The same tendency was seen in Hawaii, and the variety is figured in the paper on the Rotifera of the Pacific Islands (in a later number of this Journal).

Pleuretra alpium (Ehr.).

The type is a large animal of a warm brown colour. It is rare, and I doubt if it has been previously found outside of Europe and the Arctic. It never occurs in dry moss. In warm countries a small dull-coloured form (probably distinct) is common. It often appears among dry mosses.

The type was only obtained in the Australian Alps at 6000 ft. The small form occurred in all the localities. Ehrenberg described a variety from the Himalaya.

Callidina formosa Murray, pl. V. fig. 13.

Only known in warm countries (India, Africa, Australia). The egg found in India has the poles produced. The egg found with the species near Sydney was similar, but there was an additional lateral knob at the widest part.

Callidina punctata Murray.

Though only recently discovered, it is already known in Hawaii, Africa, and Australia.

Callidina armillata sp. n., pl. IV. figs. 2a-2d.

Specific Characters.—Small, hyaline; corona large; sulcus wide; collar produced laterally as broad hyaline band, joining the margin of the mouth; antenna short; teeth 2 + 1; jaw with broad wing; foot 4-jointed; spurs very small cones, interspace wide; lumen of stomach wide; toes small.

Length, feeding, 300 μ ; width of corona 80 μ , collar 70 μ , neck 50 μ , trunk 70 μ , across spurs 22 μ . The broad hyaline collar projects beyond the cheeks, but it is somewhat mobile, and varies in amount of expansion. Antenna equal to half the neck-width. The lumen is of unusual width for a *Callidina*, but there is no resemblance to the pellet-makers (*Habrotrocha*), which have the lumen wide.

The expanded collar distinguishes *C. armillata* from all known Bdelloids. It has its only close relatives in *C. lepida* (described in this paper) and *C. microcornis*, a New Zealand species. These have similar minute, widely separated spurs, and wide lumen.

Habitat.—Katoomba, New South Wales, frequent.

Callidina lepida sp. n., pl. IV. figs. 3a, 3b.

Specific Characters.—Small, hyaline; corona wide, sulcus shallow; collar prominent; antenna short; teeth 2; anal segment short, with lateral prominences; foot short, 3-jointed; spurs short cones, with wide interspace; stomach lumen wide.

Length, feeding, 230 μ ; width of corona 60 μ , neck 32 μ , trunk 70 μ , spurs 14 μ . Upper lip not lobed, not as high as bridge, bearing a median "ligule." Central setae on disks. Margins of mouth expanded, showing beyond cheeks. Trunk closely plicate. Antenna equal half neck-width. Pre-anal and anal segments distinct.

Most resembling *C. armillata*, it differs in not having the collar connected with the expanded mouth margin, in the unlobed upper lip, and the cuneate anal segment. The jaw has not a broad wing.

Habitat.—Katoomba, Blue Mountains.

EXPLANATION OF PLATE V.

- Fig. 7a.—*Callidina serrulata* sp. n.
 ,, 7b.—Ditto. Ditto. Jaw.
 ,, 8a.—*Callidina mirabilis* sp. n.
 ,, 8b.—Ditto. Ditto. Head and neck.
 ,, 8c.—Ditto. Ditto. Antenna.
 ,, 8d.—Ditto. Ditto. Jaw.
 ,, 9a.—*Callidina*? species?
 ,, 9b.—Ditto. Ditto. Jaw.
 ,, 10.—*Callidina multispinosa* (Thomp.). Form from Queensland.
 ,, 11.—Ditto. Ditto. Form from Katoomba.
 ,, 12.—*Rotifer montanus* Murray. Spurs of Australian variety.
 ,, 13.—*Callidina formosa* Murray. Egg.

Callidina microcornis Murray.

(Described in "Rotifera of New Zealand" in a later number of this Journal). This species, first discovered in New Zealand, was afterwards obtained at Katoomba. With *C. armillata* and *C. lepida* it makes a group of species, having very wide lumen and minute spurs, at present only known in Australasia.

Callidina longistyla sp. n., plate IV. figs. 4a-4f.

Specific Characters.—Small, slender, hyaline; rostrum slender, antenna minute; teeth 2; rump nodose; foot 3-jointed; spurs large, gradually tapering, slightly curved, not shouldered, no interspace; toes minute, slender; stomach with large globules, not pellets.

Length 300 μ ; width of trunk 50 μ , length of spur 32 μ . Not seen feeding, but corona small.

The narrow form, slender rostrum, long spurs, and nodose rump, give a superficial resemblance to *Dissotrocha macrostyla*, but the antenna is minute, reproduction is not viviparous, and the spurs are thicker, and not shouldered at base. The toes are 3.

Altogether an animal standing by itself, with no near relatives. It has most in common with *C. crucicornis* Murray.

Habitat.—Katoomba.

Callidina papillosa (Thompson).

Like the smaller of the two Canadian forms, which is near the type, but has more numerous warts (see "Canadian Rotifera," in a later number of this Journal).

Callidina multispinosa (Thompson).

Several diverse varieties of this protean species occurred.

First Variety.—(Figured in "Rotifera of New Zealand," in a later number of this Journal.) Long-spined; teeth 4 + 1 or 5. On each side of the anterior trunk 5 strong curved spines, with large bases; all other processes small spicules; on the foot some truncate or furcate pegs. At junction of first and second segments of anterior trunk a short thick spine at each side, pointing forward.

Habitat.—Katoomba; confined to Australasia.

Second Variety (plate V. fig. 10).—Long-spined; 3 very long setæ, with bulbous bases, at each side—one on each of the segments of the anterior trunk, and one on the foot; most of the other processes thick conical knobs. Number of teeth not noted. The development of the setæ on the foot is unusual, and this may prove to be a distinct species.

Habitat.—Queensland.

Third Variety (plate V. fig. 11).—One pair of long, strong spines on the anterior trunk. Very few small spicules on body. Imperfectly studied.

Habitat.—Katoomba.

Fourth Variety, var. *brevispinosa*.—Differing from the African form in having 4 transverse dorsal rows of spicules on central trunk. There are some additional spines on the anterior trunk. The ventral surface is distinctly transversely plicate.

Callidina serrulata sp. n., plate V. figs. 7a, 7b.

Specific Characters.—Of moderate size, papillose; teeth 2; trunk bearing many lanceolate serrate processes, in pairs, and some stout spines, spicules, and ligular processes.

Length, creeping 350 μ , width of trunk 125 μ , neck 48 μ , processes up to 50 μ or more in length.

Related to *C. pinnigera*, the processes are more numerous, longer, and taper to acute points, instead of being fan-shaped and truncate. Most of them are serrate. The second anterior trunk segment has a pair of stout spines, with broad conical bases; a smaller pair of stout spines at widest part of central trunk. The head and foot are as in *C. multispinosa* and *pinnigera*.

Habitat.—Katoomba, Blue Mountains.

Callidina mirabilis sp. n., plate V. figs. 8a–8d.

Specific Characters.—Size moderate; trunk broad, bearing many paired excrecences, apparently produced by a secretion; anterior margin of trunk with three large fleshy processes, one median, two lateral. Head small, disks narrow; sulcus deep, narrow; collar prominent; antenna moderate; teeth, about six; rump with several conical spiny processes, and two posterior, broad flanges. Foot short; spurs narrow, straight, tapering, divergent, with wide interspace.

Length 350 μ , width of trunk 150 μ , corona 80 μ , neck 60 μ , tip to tip of spurs 28 μ .

Tubercles on trunk like those of *M. incrassata* and *D. macrostyla* form *tuberculata*, irregular, some capped by flat plates. Antenna stout; rostrum short, broad, constricted below; teeth very strong, jaw with broad border.

The fleshy processes of the anterior trunk are the strangest feature of the animal, and require further study. The lateral ones are strongly curved outwards, and along the convex border there is a prominent band, which is transversely striate. The central process has a large median pore. It could not be seen whether it had a striate border.

One of the most specialized of the *Philodinada*, this species

stands apart, and has no near relatives. The jaw, with its broad border and strong teeth, suggests affinity with *Mniobia*, in which genus *M. incrassata* has been placed. The shape of the head, and the spiny processes on the rump, show, I believe, a true relationship to *C. multispinosa*, and for this reason the animal is placed in the genus *Callidina*, although the toes were not seen. It may eventually have to be made a distinct genus.

Habitat.—Katoomba, Blue Mountains.

Callidina? species? plate V. figs. 9a, 9b.

Specific Characters.—Size moderate; trunk papillose; teeth 2 + 1. Central trunk bearing a number of peg-like, truncate processes, up to 8 or 10 μ in length.

This undoubtedly distinct species is not named, because neither head nor foot was seen, and so it cannot be placed in any genus. It is probably a *Callidina*.

Habitat.—Queensland.

Mniobia scabrosa Murray.

Recently discovered in Africa, since found in New Zealand and Australia.

Habitat.—Queensland.

Rotifer montanus Murray, plate V. fig. 12.

This dusky little species, first obtained by Dr. Mackay on the Nun's Veil Mountain in New Zealand, was found, also at a high elevation, in the Australian Alps. The spurs were slightly different, being subacute, separated by a straight interspace, and held parallel.

Habrotrocha angusticollis (Murray), plate IV. fig. 5.

In Queensland the common form differed from the type in having the neck of the case elongate, as in var. *attenuata* (India), but strongly curved.

Habrotrocha pusilla (Bryce).

At Katoomba there was a form with a very pretty case, composed entirely of hyaline pellets, regularly arranged in several concentric layers.

Habrotrocha caudata Murray.

Recently discovered in Africa, a single example occurred at Katoomba, its only known occurrence outside Africa.

Habrotrocha longiceps (Murray).

In Australian examples several points of structure were observed which were not known when the species was described.

Foot very short, 3-jointed; spurs small, conical or ovate acuminate, sometimes without interspace, sometimes with wide convex interspace. Relatively large lamellæ were seen in examples from Katoomba. The original Scottish examples showed no trace of lamelle. It may be that there are distinct species having similar cases.

Habrotrocha strangulata sp. n., pl. IV. figs. 6a-6c.

Specific Characters.—Small, narrow; antenna very short, neck constricted in third segment; gullet very long; jaw long, with very numerous teeth; foot short, 3-jointed; spurs very broad, acuminate, no interspace; rostrum constricted below.

Length 300 μ , width of trunk 50 μ , across spurs 15 μ . Second neck segment very long, bulging. The permanent constriction of the third neck segment recalls *H. acornis*, and is probably due to its dwelling in a narrow-necked case, but in neither species has a case ever been seen.

The antenna is less than half the neck-width. The corona has not been seen unfolded, but in contraction it is small. Though incompletely studied, the constricted neck, numerous teeth, and broad acuminate spurs, distinguish this from all other species.

Habitat.—Katoomba, numerous.

Habrotrocha auriculata Murray.

Recently discovered in tropical Africa, and afterwards in Australia.

Scephanotrocha rubra Bryce.

Though described only a few months ago, the animal has long been known. The generic characters can only be seen when the animal is feeding, but it can be distinguished by the specific characters even when creeping.

Found in Britain, North America, New Zealand, and Australia.

Ceratotrocha cornigera (Bryce).

This remarkable Bdelloid appears to be rare or local. It is usually found among moist mosses (*Sphagnum*, etc.) or on mountain tops. It appeared in dry moss from the Australian Alps, the first time I have found it in dry moss.

It is recorded for Spitsbergen, Britain, Switzerland, and Australia.

Adineta longicornis Murray.

Supposed to be limited to tropical and sub-tropical countries, till its recent discovery in the coldest region where any Rotifera

exist (the Antarctic) showed this impression to be erroneous. After all it is found chiefly in the mountain ranges—Himalaya, Australian Alps, Blue Mountains—and elevated plateaus—Transvaal, Uganda. Egg elliptical, smooth, not knobbed.

Adineta barbata Janson.

The Australian form has the spurs somewhat longer and more gradually tapering than in the type. The egg is typical.

Habitat.—Katoomba and Australian Alps.

SUMMARY.

Bdelloids.—We recognized 46 species, besides some half-dozen others previously known to other naturalists, but not described, or still insufficiently studied. Forty-five are new to the Australian fauna, as we only found *R. vulgaris* which had been previously noted.

The four districts visited gave the following numbers: Sydney 10 species, Katoomba 35, Alps 22, Queensland 17.

Compared with the rest of the world the Australian Bdelloids show a good deal of peculiarity. There are 7 new species described, six confined to Australia (one afterwards found in Canada), and eight others occur as more or less distinct varieties. Two species, *C. microcornis* and *R. montanus*, are only known in New Zealand and Australia. *C. punctata*, *M. scabrosa*, *H. caudata*, and *H. auriculata* are in Australia and Africa (*M. scabrosa* in New Zealand also).

Of the 22 species from the Australian Alps, 20 are known in Europe and nearly all are common British species. Only 4 species occurred in all four districts in Australia, 3 in three districts, 15 in two districts (7 in mountain districts only), 21 in one district only.

It is evident how much more productive the mountainous districts are. So far as our work goes it indicates that the arid low-lying districts are poor in Bdelloids—the highest Alpine district has a temperate fauna quite like that of Europe—the intermediate elevation, just high enough to temper the heat somewhat, is much the most productive, and yields most of what is peculiar in Australian Bdelloids.

With the 8 species noted in the introductory paragraph, which did not occur in our collections, there are 54 Bdelloids recorded for Australia.

Considering the facility with which new species and peculiar varieties were obtained during an all too hurried journey over a limited area, it is permissible to suggest that the Australian Bdelloid fauna is far from being thoroughly known, and that any

naturalist sufficiently equipped for the study may look for interesting discoveries.

Ploima.—There is nothing in our short list calling for any remark except the extension of the range of *Dinocharis inornata* Hilgendorf to Australia.

BIBLIOGRAPHY.

1. ANDERSON AND SHEPHARD.—Notes on Victorian Rotifers. Proc. Roy. Soc. Victoria, n.s. 4 (1892) p. 69.
2. HUDSON AND GOSSE.—The Rotifera, 1886. Supplement, London (1889).
3. ROUSSELET, C. F.—On a Mounted Slide of *Trochosphaera solstitialis*. Journ. Quekett Micr. Club. April (1889).
4. " " Notes on the Genus *Lacinularia*. Journ. Quekett Micr. Club, p. 313. April (1900).
5. SCHMARDA, L.—Neue wirbellose Thiere. Leipzig (1859).
6. SHEPHARD, J.—A New Rotifer, *Lacinularia elongata*. Viet. Naturalist, p. 22. May (1896).
7. " " A New Rotifer, *Lacinularia elliptica*. Viet. Naturalist. October (1897).
8. " " A New Rotifer, *Lacinularia striolata*. Proc. Roy. Soc. Viet. 12, p. 20. August (1899).
9. SHEPHARD AND STRICKLAND.—A New Rotifer, *Melicerta fimbriata*. Viet. Naturalist, 16, p. 38. July (1899).
10. STRICKLAND, W.—The Rotifer in Melbourne. Viet. Naturalist, p. 111. November (1894).
11. THORPE, V. G.—On certain Rotifera found in Ponds, Brisbane. Proc. Roy. Soc. Queensland (1888) p. 28.
12. " " A List of Queensland Rotifers. Proc. Roy. Soc. Queensland (1889) p. 70.
13. " " A New Species of *Megalotrocha*. Journ. R. Micr. Soc. October (1889) p. 613.
14. " " New and Foreign Rotifers. Journ. R. Micr. Soc. (1891) p. 301.
15. " " Note on the Recorded Localities for Rotifers. Journ. Quekett Micr. Club (1893) p. 312.
16. WHITELEGGE, T.—Marine and Fresh-water Invertebrata of Port Jackson, etc. Journ. and Proc. Roy. Soc. N.S. Wales (1889) p. 308.

IX.—*Anomalies in Objective Screw Threads.*

By F. W. WATSON BAKER.

(Read March 15, 1911.)

THE purpose of this short paper is:—

1. To call attention to the great diversity which exists in the objective screw threads made by the various makers and described as of the Royal Microscopical Society's standard size.

2. To indicate disadvantages connected with the present system of sizing gauges and measurements as set out by the Royal Microscopical Society.

3. To consider how more uniform results can be attained.

1. The Diversity of Objective Threads. That the objective of one maker will frequently not screw into the nose-piece of the

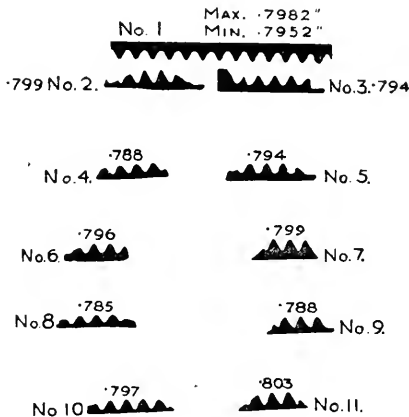

FIG. 24.

Microscope of another maker is a matter of common knowledge, but will not be cause for wonder when it is known how distant is the approach to accuracy of the majority of the screw threads of objective makers.

For the purpose of this paper I have photographed the standard sizing gauge supplied by the Royal Microscopical Society (fig. 24, No. 1), in order to show the shape and size of the screw threads and the objectives of ten different makers in comparison with it (fig. 24, Nos. 2-11).

From these it will be seen that some of the screws exceed in diameter the maximum allowed in the specification; others are smaller than the minimum, the difference between the largest and the smallest being 0·018 in., and that the shape of the thread has greater differences than would seem possible. Exactly similar differences occur in the nose-piece thread.

In addition, the plain fitting above the thread of the object-glass which should be $\frac{1}{10}$ in. long is rarely considered; the number of threads or the length of screw is variable, yet both of these are of vital importance in order that revolving nose-pieces may be made with as short a fitting as possible.

All the photographs have been taken with exactly the same magnification and under the same conditions.

The defects to which attention is called can be quite easily controlled in any well ordered workshop, provided the tools are accurate and definite correct standards are established.

The present state of things is a reflection on the exactness of the work of those who being connected with the production of scientific instruments should make accuracy, in so important a feature as interchangeability, a primary consideration.

2. We will now consider the second point. Although it cannot be denied that gross carelessness on the part of manufacturers is accountable for such wide variations and departures from the standard sizes as have been shown in the photographs, I would submit for consideration that the permissible latitude given by the Society in their specification for the sizes of screw threads is far too great. If you go to a workman and tell him that you want something made accurately within 0·001 in. of a specified size he will probably express some doubt of his ability to do it, but if that same thing were ordered to be of a definite size and no latitude were mentioned, proper tools, gauges, etc., being provided, it would invariably be found that the work had less than 0·001 in. of error. With skilful workmen this has been found to be the case many times. Unconsciously they are in the habit of working with very great accuracy. Contracts are now regularly placed for large quantities of instruments having interchangeable parts with a minus allowance of only 0·0011 in.

The latitude given by the Royal Microscopical Society for the top of the thread of the object-glass is 0·003 in.—that is the difference between the maximum size 0·7982 in. and the minimum 0·7952 in.

Similar latitude is given in the nose-piece size, namely 0·803 in. to 0·8 in. at the bottom of the thread. It is therefore possible, taking the extreme limits of the object-glass thread and the corresponding nose-piece thread, for a difference of 0·0078 in. to exist.

Various makers have apparently interpreted these limits in different ways. Some have used less than the minimum size,

others a mean, and the remainder the maximum size or too large altogether.

Next, a few remarks may be made with regard to the standard sizing gauges which are supplied by the Society. The purpose for which these are intended is not as gauges as ordinarily understood in a workshop, but are so set that if an objective is arranged to screw into the die, and the nose-piece of the Microscope is sized to receive the tap, the objective will undoubtedly enter the nose-piece, but it will have a considerable shake.

The specification gives exactly the same limits and sizes for these gauges as for the objectives and nose-pieces respectively themselves, and this in itself is an element of weakness. There is no reason why the tap and the die should not be made within far closer limits, in fact of a specified size with a very small limit of possible error.

As a matter of fact, the set which I have tested is just the mean between the maximum and the minimum.

3. We have now to consider how uniform results could be attained. In the first place I should suggest that the specification were revised, and that the diameters of threads of object-glasses and nose-pieces at the top and bottom of the threads were given in absolute figures, these figures to be the maximum size of objective thread and the minimum size of nose-piece thread permissible. Any latitude that is to be taken advantage of should be a minus quantity for the objective and a plus quantity for the nose-piece.

Next, if it were thought well to adhere to the present sizing tap and die, seeing that the die has adjustable jaws, a master male-gauge should be supplied smaller by a small amount than the specified size, and that difference should be indicated upon it. This master gauge would be kept in the office in the works, and from time to time the adjustable jaws on the die would be set to it, and thus a standard would be maintained.

Alternatively, or in addition, a pair of limit gauges could be supplied by the Society to which all objectives and all nose-pieces would be referable. Any maker having such limit gauges, exercising care and wishing conscientiously to adhere to the standard thread, the correct shape of screw thread being assumed, would not then be able to send out an objective or a nose-piece that would not receive other makers' fittings.

These proposals are submitted by way of suggestion only, and it is hoped that they may lead to consideration of ways and means that may have a practical outcome.

X.—*Adams's "Variable" and the Evolution of the Modern Microscope.*

By EDWARD M. NELSON.

(Read March 15, 1911.)

THIS Microscope* (fig. 27), designed in 1770 by an anonymous "noble person," and made by George Adams, is by far the most important



FIG. 25.—Watkins, 1755.

* *Micrographia Illust.* Adams, 4th ed., 1771, pl. ii., 60 Fleet Street.

of all the ancient Microscopes, because in it we find embodied the main principles of the Microscope as constructed at the present time. It may briefly be described as a stand with a hinged joint at the top, to which is attached a bar carrying the body, the stage, and the illuminating apparatus, i.e. the mirror. If, therefore, the Microscope body is inclined, the stage and the mirror are inclined with it, precisely as in the Microscopes of to-day.

The first Microscope to have a limb carrying the body, stage, and mirror attached by a joint to a stand in this manner, is that of F. Watkins * (1755), fig. 25, but there the idea was carried out in such an impossible manner that even when it was merely

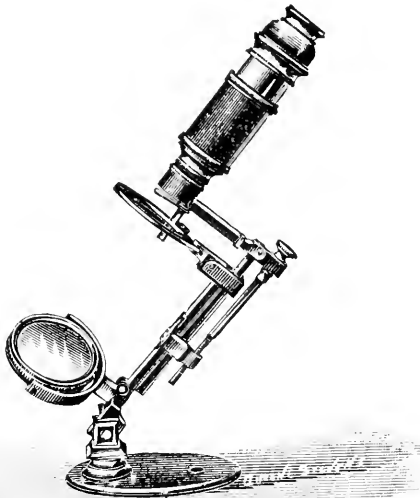

FIG. 26.—Cuff, 1765.

touched it could not help shaking like an aspen, for the pivot was at the tail end of the limb ; but, be that as it may, it probably gave the idea to the noble inventor of the " Variable," who in a thoroughly practical manner corrected the faults of the Watkins Microscope. Previous to Watkins's Microscope, there were tube or drum Microscopes, and those on the telescope plan, where the object at which the Microscope was pointed was disconnected from the body. Hertel's Microscope, the first to possess a mirror (1715), was built on this telescope plan. Bonami's Microscope (1691), the first to have the object and illuminating apparatus connected to the body, was a type by itself ; for the whole apparatus was fixed to a base-

* Journ. R.M.S. 1908, p. 137.

board, similar to a photomicrographic or projection Microscope of the present day.

The second is a portable Microscope by John Cuff,* fig. 26, which differs both from the Watkins and the Variable, because the limb is hinged to the foot and not to the top of a pillar. The mirror, stage, and body arm all fold up on joints, so it is a very shaky affair, nevertheless, it is an important model, as it is the second known example of a Microscope which has the body, stage, and mirror attached to a hinged limb.† Its date can be fixed approximately because it is signed Cuff, and Adams, who took

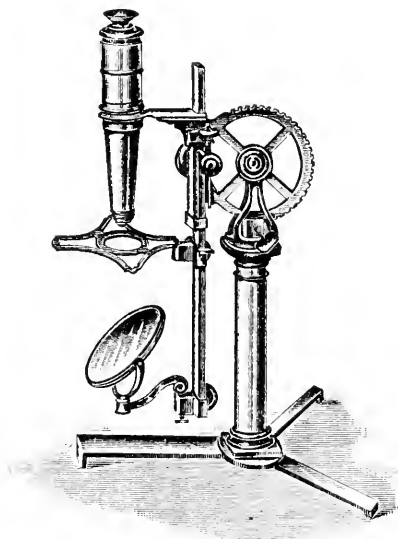

FIG. 27.—The Variable, 1770.

over Cuff's business in 1770, made this same model under his own name; also it was said to be an improved form of Ellis's Aquatic Microscope, which was made in 1755, so it may be dated "circa 1765" without much error. It was one of Cuff's latest Microscopes, probably inspired by the Watkins model of 1755. With all these loose joints it was a type that, like the Watkins, could never last. After Adams had appropriated this Cuff model, Benjamin Martin was not long in following suit, for the large instrument, which formerly belonged to His Majesty George III.,

* Journ. R.M.S. 1898, p. 675, fig. 117.

† Microscopes of this form, without the folding joints, are still made in France, and are sold here as youths' microscopes, for 14s. 6d.

which is now in our collection, is made precisely upon that plan, and is the earliest Microscope of this type in our collection, as its date is 1775.

We are therefore justified in calling the Variable, fig. 27, although the third in seniority, the most important of the three.

It has always been an interesting problem to discover the

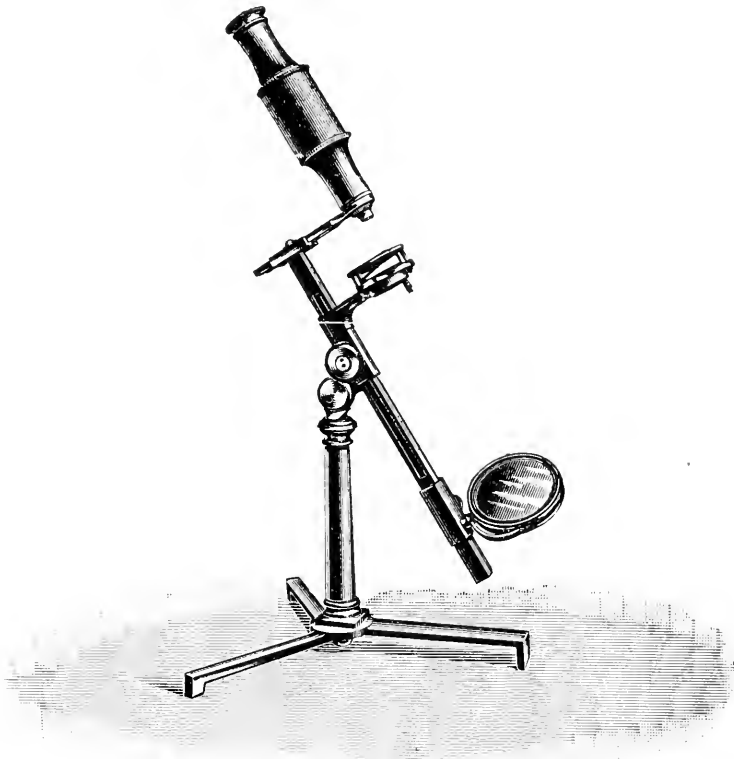

FIG. 28.—Adams, 1785.

identity of this anonymous "noble person," and now I think I am able to give you his name; not, of course, with the evidence of an affidavit, but with a very high degree of probability.

First, the fact that he was a noble person narrows down the list from which we have to select a name. At that date there was one man who, if he was not the anonymous author of this important instrument, fits the circumstances of the case in all particulars. He was not a peer, but the son of the brother of a

duke, and on that account may very well have been given by Adams the courtesy title of a "noble person."

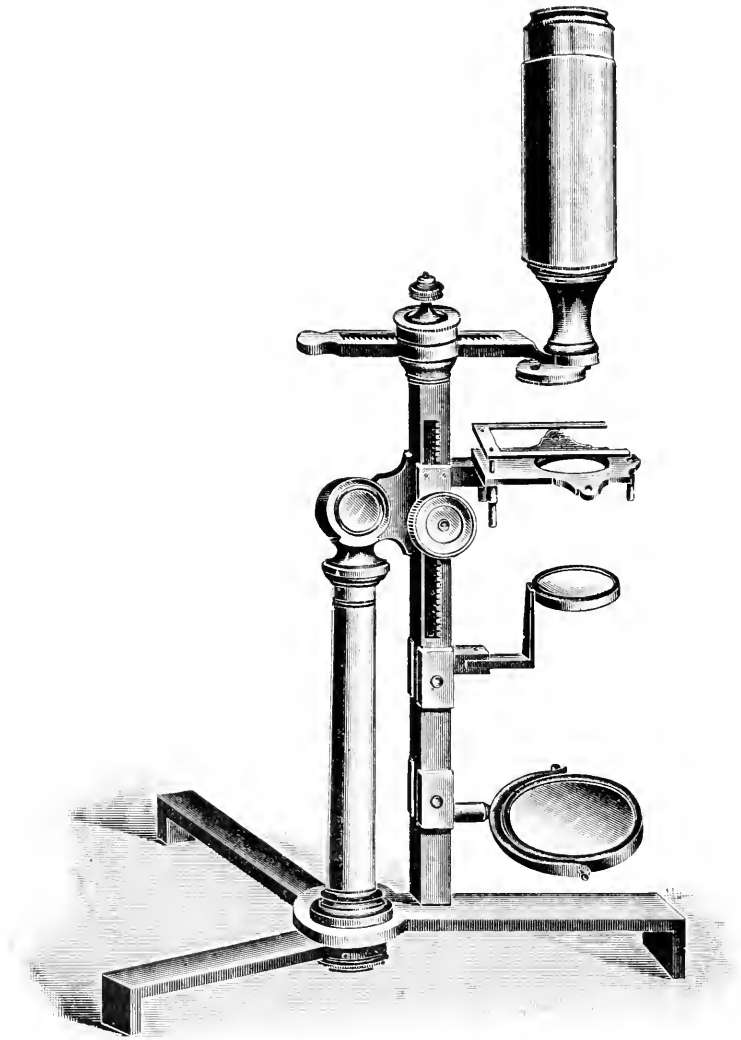

FIG. 29.—Jones's Most Improved, 1797.

His name was Henry Cavendish (1731–1810), son of Lord Charles Cavendish, brother of the third Duke of Devonshire, His mother was Lady Anne Grey, a daughter of the Duke of Kent.

After Newton he was the greatest English scientist of that time. He was exceedingly clever, exceedingly shy, very wealthy, and had a house full of scientific apparatus.

Now obviously there was just a shade of plagiarism about the design; it therefore suited Henry Cavendish to remain anonymous, and it suited George Adams to throw the responsibility of its production upon the broad shoulders of a "noble person." The whole story fits the historical facts of the case.

So we see that we owe the present form of our Microscope first

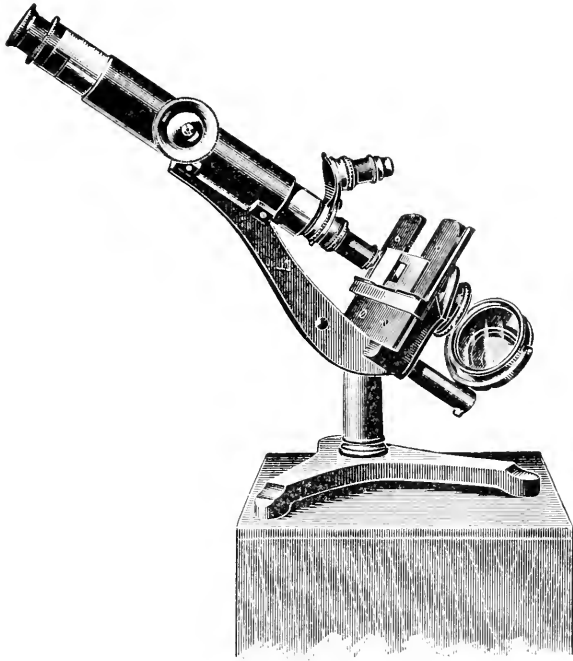

FIG. 30.—Powell, 1840.

to Francois Watkins * (mother probably French), and secondly to Henry Cavendish, who, by attaching the joint to the centre of gravity of the limb, made it a practical type, which has lasted to the present time.

The figures 25 to 30 show the several steps in the evolution of the modern Microscope in their chronological order.

Fig. 30 shows the highest type of this class of Microscope, for in design it is far in advance of its many imitations. The author, who has constantly used this instrument for rough work during a

* Author of *L'Exercice du Microscope*. London: Charing Cross, 1754.

period of thirty-five years, has described it in this Journal, 1899, p. 209, where the measurements of its various parts will be found; but the Varley foot and the conical joint are described in the Journal, 1900, p. 291.

Since the reading of this paper, Mr. Parsons has found a notice (date 1854) of the firm of opticians, Watkins and Hill, at Charing Cross.

Erratum.—A correction is needed in my note on Watkins Microscope (this Journal, 1908, p. 141, line 26). For “. . . an objective which was a combination,” read “. . . a dividing objective.” A dividing objective must obviously be a “combination,” but the reverse is not necessarily true. The word “combination” in technical optics has a special meaning, and is only used to denote an objective whose lenses, or groups of achromatic lenses, are separated from one another. For example, an object-glass consisting of two or more achromatic doublets is a “combination,” but a single achromatic doublet would be called a “doublet.” Similarly the historically famous triple inch by Tulley would be called a “triple,” and not a “combination.”

The first Microscope to possess a “combination” was that of Grindl, described in Zahn's *Oculus Artificialis*, 1685.

SUMMARY OF CURRENT RESEARCHES
RELATING TO
ZOOLOGY AND BOTANY
(PRINCIPALLY INVERTEBRATA AND CRYPTOGAMIA),
MICROSCOPY, ETC.*

ZOOLOGY.

VERTEBRATA.

a. Embryology.†

Influence of Radium Rays on Ova and Sperms.‡—O. Hertwig has subjected fertilized ova of frog and axolotl to radium rays. During the exposure, and for some time after, no effect is seen, but after a considerable interval the influence of the radium becomes apparent, always in a very detrimental way, but varying with the duration and intensity of the rays and with the stage of development reached. The differentiation of nerve and muscle is much more affected than that of the more vegetative tissues. Hertwig also exposed mature spermatozoa of sea-urchin and frog to radium rays, and then tested their effect on the egg. The spermatozoon induces serious disorders and finally disintegration in the egg, acting like a virulent bacterium, and the disturbing effect spreads from cell to cell with the chromatin at each mitosis.

Polyspermy.§—J. Rückert discusses cases of frogs' eggs fertilized by two or three spermatozoa, in which abnormal results may be avoided by elimination of the supernumerary spheres. Polyspermy seems often to occur in meroblastic ova, e.g., of Selachians and Birds, and pathological results are averted by the exclusion of the supernumerary nuclei from the segmentation area. In sea-urchin ova, with little yolk, the entrance of more than one spermatozoon disturbs the fertilization process. In the small space the expulsion of the centrosomes and their spheres cannot prevent a pathological union of the pro-nuclei. In Urodela polyspermy may occur without disadvantage; the supernumerary spermatozoa are not eliminated, but in some way destroyed or annulled.

* The Society are not intended to be denoted by the editorial "we," and they do not hold themselves responsible for the views of the authors of the papers noted, nor for any claim to novelty or otherwise made by them. The object of this part of the Journal is to present a summary of the papers *as actually published*, and to describe and illustrate Instruments, Apparatus, etc., which are either new or have not been previously described in this country.

† This section includes not only papers relating to Embryology properly so called, but also those dealing with Evolution, Development, Reproduction, and allied subjects.

‡ SB. k. Preuss. Akad. (1910) pp. 221-33.

§ Anat. Anzeig., xxxvii. (1910) pp. 161-81.

Unity of Meiotic Process in Plants and Animals.*—Victor Grégoire has made a critical comparative study of the results which have been reached by observers of the maturation or meiotic process in plants and animals. The general result is that he is able to apply one scheme of interpretation to a large number of cases in both kingdoms. Just as there is a unity in the behaviour of the chromosomes in somatic karyokinesis, so there is in the reduction division. The scheme followed is described in somewhat forbidding terms as “une préréduction hétérohoméotypique préparée par une pseudo-réduction prophasique par parasyndèse ou zygoténie.” A large bibliography is appended.

Abnormal Bone-growth in Absence of Functioning Testes.†—A. C. Geddes believes that the immediate effects of removing functioning gonads are (1) that the demands upon the internal food-supply of the body are lessened; and (2) that the body is deprived of some internal secretion or nervous stimulus. The immediate effects are certainly twofold: (1) the cells of the epiphyseal cartilages are stimulated more rapidly to proliferate; and (2) there is an arrest in the development of the penis, the scrotum, the prostate, the antrum of Highmore, and possibly the brain. There is no evidence to show why the arrest in the growth of these parts takes place. It may be supposed to be due to the absence of a stimulus to growth conveyed by an internal secretion or through the nervous system. However it be effected, it appears to differ in origin altogether from the stimulus to growth experienced by the epiphyseal cartilages. The departures from the normal inter-relations of the amount and rate of growth of the cartilages when the gonads are removed or destroyed are not fortuitous, but follow the same regular plan in men and animals. This plan is discussed at length.

Influence of Malnutrition and Castration on Development of Sheep's Skeleton.‡—N. Tschirwinsky shows how malnutrition in youth affects the development of the bones, sometimes retarding the rate of growth without final effect; sometimes lessening weight and size in different parts proportionally, sometimes causing disproportionate growth; and so on.

Castration of rams at the age of a month affects the form of the skull, lengthens the neck, shortens and broadens the os innominatum, lengthens long bones, inhibits the horns, greatly affects weight but in different directions in different parts.

Development of Rabbit's Teeth.§—J. Stach finds that the rudimentary teeth discovered by Huxley in front of the incisors are really the milk predecessors of the large incisors.

Development of Vertebral Column in Reptiles and Birds.||—A. C. Bruni has studied *Gongylus ocellatus* and the chick. It is shown in detail that a vertebral body is formed from three components, (a) the

* La Cellule, xxvi. (1910) pp. 223-422 (145 figs.).

† Proc. R. Soc. Edinb., xxxi. (1910) pp. 100-150 (3 pls.).

‡ Arch. Mikr. Anat. lxxv. (1910) pp. 522-61.

§ Bull. Acad. Sci. Cracovie (1910) pp. 215-59 (2 pls.).

|| Atti R. Accad. Sci. Torino, xlv. (1910) pp. 750-7 (1 pl.).

cellular notochordal sheath; (*b*) a tract of sclerotome which is transformed directly into cartilage; and (*c*) the intra-arcual membrane.

Development of Enteron in American Alligator.*—Albert M. Reese describes the development of the alimentary canal, with a brief description of the minute structure for each stage discussed. An account of the development of the derivatives of the digestive tract is postponed. No summary is given of the more important results.

Development of Alpine Salamander.†—Hans Wunderer describes in particular the development of the external form in *Salamandra atra*. He describes the total unequal segmentation of the telolecithal ovum, the gastrulation, the formation of the medullary groove and its closure, the development of gill-arches and gills, and so on. An interesting general result is that *S. atra* is in many respects nearer to Tritonidæ and Amblystomatidæ than to *S. maculosa*. Its origin from the latter is out of the question, and perhaps it is not a *Salamandra* at all.

Production of Supernumerary Limbs in Amphibians.‡—Eugen Lissitzky has followed Tornier's method of cutting the primordia of the limbs in young tadpoles, and thus inducing duplicity. Sometimes two pelvic girdles were produced. His particular aim has been to enquire into the minute structure of the supernumerary growths, but the main results of this enquiry are held over.

Development of Teleosts.§—Caroline Reis has studied the early development of *Amiurus nebulosus* and a number of other types. Among the conclusions reached we note the following. The embryo develops mainly from the material at the posterior margin of the blastoderm, where the endoderm, the notochord, and the mesoderm are established. There is a concentration of this embryo-forming material towards the middle line. With the appearance of Kupffer's vesicle, which forms the most posterior end of the endoderm, the most important embryo-forming material reaches the longitudinal axis of the embryo. What is left peripherally is used in forming the tail.

Kupffer's vesicle does not remain where it appears, but is shunted forwards during the formation of the end of the embryo from the posteriorly coalescent marginal ring. A similar coalescence of the halves of the marginal ring takes place at the opposite end.

Development of Pigment-cells in Teleostean Embryos.||—L. Bolk has studied this in *Atherina*, *Alburnus*, *Box*, *Belone*, and *Lophius*. Some of the noteworthy points are the following: that the pigment-cells appear very early; that they are very regular in their arrangement; that they sometimes show a metameric character. Those that are metamericly disposed arise in situ from unpigmented cells. Migration, however, in the cutis was well seen in the tail end of the angler.

* Smithsonian Misc. Coll., lvi. No. 11 (1910) pp. 1-25 (15 pls.).

† Zool. Jahrb., xxix. (1910) pp. 367-414 (9 pls.).

‡ Arch. Mikr. Anat., lxxv. (1910) pp. 587-633 (3 pls. and 3 figs.).

§ Bull. Acad. Sci. Cracovie (1910) pp. 521-42 (3 pls.).

|| Arch. Mikr. Anat., lxxv. (1910) pp. 414-34 (1 pl. and 6 figs.).

b. Histology.

Culture of Tissues outside the Organism.—Montrose T. Burrows* has cultivated dissected tissues of a 60-hour chick in a plasma derived from the adult. In this he followed Ross Harrison's lead. Skin, nerves, and mesenchyme-cells flourished well. Nerve-fibres grew for three or four days. A heart continued to beat for eight days. The growth of nerve-fibres was especially studied.

Alexis Carrel† and Montrose T. Burrows have succeeded in cultivating in plasma all sorts of adult tissues from cat and dog. Their experiments included connective-tissue, cartilage, marrow, skin, peritoneum, spleen, kidney, thyroid, supra-renal, ovary, lymphatic ganglion. Abundant karyokinesis occurred.

J. Jolly‡ has succeeded in keeping Batrachian leucocytes alive for ten months.

Blood-formation in Grass Snake.§—Wera Dantschakoff finds that the erythropoiesis in *Tropidonotus natrix* occurs during the greater part of embryonic life in the blood vessels associated with the yolk-sac. At the end of embryonic life a new blood-forming organ develops, namely the medulla of the bones, which in the grass-snake is localized in the vertebrae. Here, as in the chick and other forms, the first free cell, the lymphoid haemocyctoblast, develops in loco from mesenchyme-cells; and from its many-sided differentiation arise all the different cells of the blood.

Endothelial Genesis of Leucocytes.||—Vincenzo Patella has made a prolonged study of the genesis of the mononuclear leucocytes, and has come to the conclusion, which, if correct, is very important both theoretically and practically, that they arise from detached endothelial cells of the blood-vessels. This conclusion, he notes, was also reached by Tigri so long ago as 1857.

Giant-cells of Mole's Placenta.¶—A. van Cauwenberghe finds in the placenta of the mole a set of cells comparable to the megacaryocytes of haematopoietic organs, in their genesis, in their repeated pluripolar nuclear divisions, and in their fate or cytolysis. But the megacaryocytes arise from white blood corpuscles, these placental giant-cells from decidual connective-cells. The megacaryocytes disintegrate to nourish the erythroblasts; the placental or decidual giant-cells elaborate certain substances characteristic of the blood-plasma during gestation.

Chordoid Tissue.**—Joseph Schaffer distinguishes diffuse and compact chordoid supporting tissue. Under diffuse chordoid supporting tissue he discusses the vesicular connective substance in Molluscs and in Decapod Crustaceans, the vesicular tissue of the Tunicate test, the perimeneal filling tissue in Ammocoete and lamprey, the vesicular tissue near the eye of the hag, the chordoideal tissue of *Petromyzon*

* C.R. Soc. Biol. Paris, lxi. (1910) pp. 291-2.

† Tom. cit., pp. 293-4.

‡ Tom. cit., p. 295.

§ Verh.-Anat. Ges. (1910); Anat. Anzeig. Ergänz., xxxvii. (1910) pp. 70-75.

|| La Genèse Endothéliale des Leucocytes Mononucléaires du Sang. Siem e, 1910, 242 pp. (113 figs.).

¶ Arch. Biol., xxv. (1910) pp. 99-168 (4 pls.).

** Zeitschr. wiss. Zool., xcvi. (1910) pp. 1-90 (2 pls.).

marinus, the endoneural cell-vesicles, the tissue in the sinus of vibrissæ and in the rhomboidal sinus of birds, and the fatty tissue. Under compact chordoid supporting tissue he discusses the notochord-tissue in embryos and the remains of it in adults, the supporting tissue in the tentacles of Hydroids and around the margin of Medusæ, and the so-called cartilage of *Amphiorus*.

Eye of Pteropus.*—Walther Kolmer finds that the eye of *Pteropus* stands quite by itself. It shows peculiarities of choroid and retina which have no parallel among Vertebrates, at least beyond the limits of the Megachiroptera. In *Cynonycteris*, another large bat, the choroid showed the same peculiarities as in *Pteropus*, but the eyes of Microchiroptera show no hint of them. One of the most striking peculiarities is the development of a layer of cone-shaped elevations in the choroid. In consequence of this the outer surface of the retina is not smooth as in all other animals, but shows even on macroscopic investigation numerous depressions or indentations.

Thread-like Structures in Epidermic Cells of Tadpoles.†—N. Loewenthal discusses peculiar coiled threads of considerable thickness which occur in the cytoplasm of the cells of the epidermis in tadpoles. They are quite smooth and homogeneous, and not composed of granules. Therefore they cannot be mitochondria. It is possible that they represent chondriokonts.

Threads and Granules in the Cytoplasm.—N. Samssonow ‡ has found evidence in cartilage, connective-tissue, and epidermic cells, that Flemming's threads and Altmann's granules are really the same. His figures of similar cells treated with Flemming's mixture or by Altmann's method are very convincing.

F. Meves § has studied, in reference to the same question, the white blood corpuscles of rabbit and rat, and brings forward evidence in support of the conclusion, that Flemming's "Fila," Altmann's "Bioplasts," and the chondriosomes or plastosomes of to-day are all the same.

Protoplasmic Fibres in Epidermic Cells.||—B. Rosenstadt has studied the adult and embryonic epidermis of man and various other types, with special reference to the fibres in the cytoplasm. They run longitudinally, transversely, and vertically. Some of each direction go from cell to cell through the intercellular spaces, forming the so-called "bridges." The minute "knots," sometimes described as forming part of the bridges, are really fibres in section.

Supporting Elements in Sensory Epithelium.¶—W. Kolmer has studied the sensory papillæ of the axolotl, the taste papillæ of mammals,

* Zeitschr. wiss. Zool., xcvi. (1910) pp. 91-104 (1 pl.).

† Anat. Anzeig., xxxviii. (1911) pp. 55-67 (1 fig.).

‡ Arch. Mikr. Anat., lxxv. (1910) pp. 635-41 (1 pl.).

§ Tom. cit., pp. 642-53 (1 pl.).

|| Tom. cit., pp. 659-88 (1 pl.).

¶ Anat. Anzeig., xxxvi. (1910) pp. 281-99 (1 pl. and 3 figs.).

the olfactory epithelium of various types, and a number of other examples of sensory epithelium. He calls attention to the presence of supporting fibrils as distinct from neurofibrils in all the kinds of sensory cells in Vertebrates, and discusses the topographical and physiological relations of the two.

Continuity of Mitochondria through many Generations of Cells.* M. E. Fauré-Fremiet finds evidence in Infusorians and in germ-cells that specific mitochondria are divided at each generation of cells, and a continuity thus sustained. Meves has shown for the fowl, and Duesberg for the bee and the rabbit, that the mitochondria of the ovum are seen in the embryo. The author inquires in a critical spirit into the significance of this, whether the mitochondria are vehicles of inheritance, or whether they have a trophic value; and many other theories are discussed.

Reticular Apparatus in Cells of Corpus Luteum.†—Joseph Karl Riquier has studied this in the cow. He finds that Golgi's reticular apparatus, though varied in appearance, is usually evident in a perinuclear position. The continuity of the clumps and threads of the network is often far from evident. Three stages in the involution of the network are described, ending in practically complete disappearance.

Pigment-cells in Sheep's Cornea.‡—P. A. Cilimbaris has found in the substantia propria of the cornea, under the anterior epithelium, beside the ramifications of the plexus subepithelialis and basalis, numerous pigment-cells. They occurred not merely near the corneal margin, but over the whole surface.

Pigment in the Human Neurohypophysis.§—A. Kohn discusses the posterior lobe or nervous portion of the hypophysis (the neurohypophysis), as contrasted with the anterior lobe (the epithelial or glandular portion). What particularly interests him is the pigmentation, which has its seat in the glia-cells and their processes, especially in the latter. The pigment is not fat nor a lipochrome, but its precise nature has not been ascertained. It is probably a disintegration-product. It increases with age. The author gives many reasons why he cannot agree with those who call the neurohypophysis a gland.

Kidney of Gecko.||—B. Zarnik has studied the structure of the multilobate kidney in *Ascalobota*, and compares it with that of other Reptiles and of Mammals. That of other Reptiles may be derived from the Gecko type, which also shows most resemblance to that of Mammals. It is pointed out that in Geckos the differentiation into cortex and medulla has begun. The author suggests that a lobe of the Gecko kidney is homologous with those parts of the cortex in Mammals that are enclosed by the medullary rays.

* Anat. Anzeig., xxxvi. (1910) pp. 186-91 (3 figs.).

† Arch. Mikr. Anat., lxxv. (1910) pp. 772-80 (1 pl.).

‡ Tom. cit., pp. 689-91. § Tom. cit., pp. 337-74 (2 pls.).

|| SB. Phys. Med. Ges. Würzburg (1910) pp. 2-4.

c. General.

Atavism.*—M. Hilzheimer thinks that biologists have been too easy-going in the use of the word and concept "atavism." He maintains that although atavisms occur, we cannot give this interpretation to supernumerary fingers and toes, nor to zebroid stripes in horses, and so forth. It is interesting to notice that atavisms in domestic animals are clearest in those which have had a monophyletic origin, but have been separated by isolation into numerous races. In intercrossing of these races the isolated primordia come together again. In polyphyletic races it is extremely improbable that there could be an atavism harking back for a considerable number of generations.

Interesting Structural Analogy.†—Austin Hobart Clark points out the resemblance between the "snow-shoes" of the ruffed grouse (*Bonasa umbellata*) and the supplementary plates in Crinoid arms. The "snow-shoes" which develop in winter are formed from two rows of "scutes" on either side of each toe, which increase the area of the foot by as much again. "Thus a bird walking about in the winter brings to bear only half as much weight in any given spot as the same bird in summer, and is thereby enabled to tread securely upon slightly compacted snow."

In Crinoids the food consists of small organisms which fall on the upturned and outstretched arms and pinnules, and are thence conducted by a ciliated "ambulacral groove" to the mouth. The increase of area by two rows of supplementary plates on each side of the median row is very advantageous. The development of accessory side-plates occurs in the Crinoids of deeper waters, where the food consists mainly of dead organisms. They are suppressed or absent in littoral and pelagic forms, whose food consists of minute living animals.

Osmotic Growths.‡—Stéphane Leduc regards Biology as a department of the physico-chemistry of fluids. With gelatin and drops of potassium ferrocyanide one can make nucleated artificial cells which "die" after a time, and by dropping fragments of salt into appropriate solutions one can get osmotic growths like polyps and periwinkles, mushrooms and moulds, corals and leaves. Of course, osmotic phenomena are important in organisms, and require much more study than they have as yet received, but Leduc's osmotic growths do not afford what the title of his book suggests.

Male Genital Organs in Insectivora and Lemuridæ.§—W. Kaudern has made a comparative study of the male genitalia in these two orders, and some of his results throw light on systematic relationships. It appears, for instance, that the Chrysochloridæ are more primitive than other Insectivora, and the Tupajidæ more specialized. It is shown that as regards the penial structure the Lemuridæ exhibit two divergent types, derivable however from a common stock—that of the Madagascar Lemurs, and that of the Lemurs on the African continent and in Asia.

* Zeitschr. indukt. Abstammungslehre, iii. (1910) pp. 201-14.

† Ann. Nat. Hist., v. (1910) pp. 358-61 (2 figs.).

‡ Théorie physico-chimique de la Vie et Générations spontanées, Paris, 1910, 202 pp. (57 figs.).

§ Zool. Jahrb., xxxi. (1910) pp. 1-106 (46 figs.).

Beaked Whales.*—Frederick W. True gives an account of the beaked whales of the family Ziphiidae in the collection of the United States National Museum, with remarks on some specimens in other American museums. With the exception of the bottle-nosed whales of the genus *Hyperoodon*, the Ziphiidae are among the rarest of Cetaceans. There are three genera, *Mesoplodon*, *Ziphius*, and *Berardius*. Of the last-named, only about fourteen specimens have been collected thus far. Attention is called to Stejneger's important discovery that the three genera are represented at Bering Island in the North Pacific.

Musculature of Pectoral Girdle and Flipper in Cetacea.†—S. Sterling finds that the resemblance of Odontoceti and Mystacoceti as regards fore-limb is rather that of convergence than of close relationship. That of Odontoceti is further from the typical Mammalian fore-limb than that of Mystacoceti, and the Odontoceti must have sprung from a Mammalian stock more ancient than the ancestors of the Mystacoceti. The order Cetacea must have had a diphyletic origin, as Kükenthal has suggested.

Homology of Mammalian Lachrymal.‡—E. Gaupp brings forward much evidence in support of the view that the lachrymal bone in the Mammalian skull is homologous with the pre-frontal of Sauropsida, and not with the somewhat inconstant lachrymal of Sauropsida.

Right- and Left-handedness.§—Karl von Bardeleben calls attention to the need of more data in regard to this much-discussed subject. We cannot even state percentages of left-handedness for different peoples. A study in the German army in 1910 showed 10,322 left-handed men, about 3.88 p.c. The author points out that there should be enquiry into the degree of the left-handedness, as tested by power of writing, throwing, knitting, and the like, by finer tests as to sensitiveness, and by precise measurement. The gibbon and orang are right-handed, chimpanzee and gorilla are left-handed, but we do not yet know how the predominant right-handedness of mankind has arisen.

Birds and Deinosauers.—J. Versluys shows that the free movement of the skull which is so characteristic of Birds, was also possessed by Deinosauers. It seems to him likely that Birds and Deinosauers were both derived from Diaptosaurians, which were able to run about on their hind legs. The author argues in favour of this view with great learning and ingenuity.

Ileal Cæcum of Birds.¶—A. Lelièvre and E. Retterer have studied in the duck the structure and development of the third cæcum or ileal appendix, which is present in many birds. It is, like the appendix vermiformis in man, a portion of the alimentary tract, and has to begin with the same structure. But as development goes on, the epithelium

* U.S. Nat. Mus. Bull. lxxiii. (1910) pp. 1-89 (42 pls.).

† Jen. Zeitschr. Naturw., xlvi. (1910) pp. 667-80 (1 pl. and 4 figs.).

‡ Anat. Anzeig., xxxvi. (1910) pp. 529-55 (14 figs.).

§ Verh. Anat. Ges., 1910; Anat. Anzeig. Erganz., xxxvii. (1910) pp. 10-13.

¶ Zool. Jahrb., xxx. (1910) pp. 175-200 (1 pl. and 25 figs.).

¶ C.R. Soc. Biol. Paris, lxi. (1910) pp. 334-7.

of the glands or crypts diverges from that of open glands; it gives rise to a mass of reticular tissue producing fluid and corpuscles, which pass into the blood.

Account of the Hoatzin.*—C. W. Beebe gives an account of the feeding and breeding habits and other oecological relations of this extremely interesting bird, *Opisthocomus hoatzin*, which he had the fortunate opportunity of studying in Venezuela and British Guiana.

Immunity to Viper Venom.—G. Billard † and E. Maublant find that the common duck shows a remarkable indifference to the venom of the viper. The same is true of the owl (*chevêche commune*). Two were bitten badly on the feet, but did not seem much the worse.

G. Billard ‡ also finds that the domestic cat has almost complete immunity as regards the neurotoxin of the viper. Perhaps this is true of many *Felidæ*.

Evolution of Reptilian Scales.§—Georg Stehli has studied the development of the bony scales in *Anguis fragilis* and in *Gongylus ocellatus*, the segmental arrangement of the scales in lizards and snakes, the cutis-ossifications in the crocodile and in Chelonians, and the segmental arrangement of the integumentary bones in *Aëtosaurus ferratus* (Triassic). With Hasse and Otto he concludes that in Reptiles a segmental arrangement of scales is primitive, and that each horny scale originally belonged to a subjacent bony scale. The phyletic stages are:—(1) segmental horny scales, with subjacent bony scales; on each segment one row of scales, or sometimes, by doubling, two rows; (2) breaking up of the bony scale into mosaic-like plates (as in Scincoids); (3) disappearance of the bony scale; (4) multiplication of the horny scales, and loss of the segmental arrangement.

Ear of Urodela.||—K. Okajima has studied the structure of the ear in *Megalobatrachus*, *Siredon*, *Onychodactylus*, *Hynobius*, *Triton*, and *Salamandra*, and finds that there are at least three apertures for the auditory nerve in the internal vestibular wall. The nerve divides on its entrance into three or more branches. Those that traverse the median apertures always go to the sacculus.

Total Closure of Gut in Healthy Frog.¶—H. Fischer describes a curious case of a specimen of *Rana esculenta* which seemed in good condition, but showed on dissection an enormously dilated rectum which ended blindly. The sac was full of blackish green material, and the abnormality must have persisted for a long time. It seems necessary to suppose that remains of the food must have been passed out by the mouth.

* Zoologica, New York Zool. Soc., I., No. 2, Dec. 1909, pp. 45-66 (9 figs.). See also Zool. Zentralbl., xvii. (1910) p. 637.

† C.R. Soc. Biol. Paris, lxxix. (1910) pp. 316-17.

‡ Tom. cit. pp. 318-19.

§ Jen. Zeitschr. wiss. Zool., xlvi. (1910) pp. 737-800 (1 pl. and 19 figs.).

|| Arch. Biol., xxv. (1910) pp. 77-93 (1 pl.).

¶ Anat. Anzeig., xxxviii. (1911) pp. 79-86 (1 fig.).

Function of Swim-bladder.*—C. M. L. Popta gives an account of a large number of experiments on this subject, and a full account of previously recorded data, inferences, and opinions. She finds that the swim-bladder favours the circulation of oxygen, and of gas in general, in the body of fishes. This function is related to the needs of the animal, and may be voluntarily controlled. The gases enter the cavity by the blood-vessels, and pass out by the lymphatics. The organ in question is not hydrostatic nor directly respiratory—it may have some accessory uses, but its real function is to favour the circulation of gases.

Structure and Function of the Saccus vasculosus in Fishes.†—K. W. Dammermann has made a careful study of this structure, which arises as a diverticulum from the posterior infundibular wall, and lies with the hypophysis in the sella turcica. As has been repeatedly suggested, the saccus vasculosus is not a gland, it is a sense-organ, and a full account is given of its minute structure, its afferent and efferent nerves, and its blood-supply. The organ is confined to Fishes, though in higher Vertebrates there may be a representation of the recessus posterior infundibuli. The saccus vasculosus is probably homologous with the infundibular organ of lancelets and the ciliated groove of Tunicates. Dammermann argues ingeniously in support of the theory that the saccus vasculosus enables the fish to become aware of the degree of oxygenation in the water, and thus to choose the most comfortable depth. He proposes to call it a Benthic organ.

Ventral Musculature of Fishes.‡—K. Knauer has studied this in various types. The simplest relations are in dog-fishes. There the lateral trunk musculature is divided by four interstitial partitions, of which the interstitium laterale is most conspicuous. But it cannot be taken as the boundary between dorsal and ventral musculature, since part of the muscle ventral to it is continued forwards to the skull, and is undoubtedly dorsal. What is below the interstitium sublaterale is ventral musculature. But this is only an indication of the general nature of Knauer's investigation.

Yawning in Fishes.§—Richard Elmhirst describes in cod, saithe, cobbler, plaice, eel, and other fishes, an action like yawning, consisting of a wide opening of the month, slow expansion of the buccal cavity, erection of the gill-arches, followed by a rapid expulsion of the indrawn water, most of which is emitted from the mouth, although some certainly goes through the gill-slits. This is often accompanied by a distinct heaving of the pectoral region and erection of the pectoral fins, and is quite different from the rapid movement of the operculum and jaws, which is used to remove a foreign object, such as a bit of seaweed, from the gills. From numerous observations, Elmhirst has been led to think that this action of fishes is a real yawn, and serves the true physiological purpose of a yawn, i.e. flushing the brain with blood during

* Ann. Sci. Nat. (Zool.), xii. (1910) pp. 1-160.

† Zeitschr. wiss. Zool., xcvi. (1910) pp. 654-726 (4 pls. and 1 fig.).

‡ Arbeit. Zool. Inst. Univ. Wien, xviii. (1910) pp. 207-26 (3 pls. and 6 figs.).

§ Zoologist, 1910, pp. 321-4.

periods of sluggishness. The conditions conducive to yawning are a slight increase in the temperature of the water, and, probably, the accompanying diminution of oxygen.

Pectoral Girdle and Fins of Teleosteans.*—K. Derjugin has studied the structure and development of the pectoral girdle and fins in *Lophius piscatorius* and other Teleosteans, and goes carefully into the difficult questions involved, which are complicated by the fact that the secondary ossified parts, which have no essential phylogenetic importance, tend to disguise the mutual relations of the primary cartilaginous elements. Two general summaries of results are given in the paper.

Fisheries of New South Wales.†—David G. Stead gives an interesting account of the fisheries of New South Wales, present and potential. He deals with Fishes, Crustaceans, Molluscs, Cetaceans, Sponges, and even seaweeds. He notes that there is reasonable prospect of a sponge fishery being started. Some of the species of *Euspongia* and *Hippospongia* make very good bath sponges. The uses of the "sea-grass," *Zostera*, for packing, etc., and of "vegetable isinglass" (a species of *Gelidium*) are commented on.

Large Sun-fish.‡—A. de Colomina gives a description of a large specimen of *Orthogoriscus oblongus* Schneider, from the coast of Spain. It was 2 m. long, and the height of the trunk was 1.15 m.

Elimination by Leucocytes.§—L. Spillman and L. Bruntz have made numerous experiments with crayfish, snails, frogs, rabbits, and many other animals, injecting coloured fluids such as ammoniacal carmine, and tracing the process of elimination. They distinguish three phases in the elimination :—(1) the fluids are fixed mechanically by some forms of leucocytes (phase of fixation) ; (2) the leucocytes carry the fixed substances to open or closed excretory organs (phase of transport) ; and (3) these organs, by a glandular process, get rid of the products fixed by the leucocytes (phase of excretion).

Fresh-water Microfauna of German East Africa.||—E. von Daday continues and completes his report. He deals with some Hydrachnids, and then gives lists of the microfauna in general from different localities. It is shown that the fauna of small basins, temporary pools, marshes and the like, is richer and more varied than that of large lakes. He makes some interesting comparisons of the great lakes. Altogether the author has dealt with 327 species, of which many are new.

* Zeitschr. wiss. Zool., xcvi. (1910) pp. 572-653 (3 pls. and 8 figs.).

† A Brief Review of the Fisheries of N.S. Wales, present and potential. 8vo. Sydney (1910) pp. 1-31 (17 pls.).

‡ Bol. Soc. Españ. Hist. Nat., x. (1910) pp. 453-6 (1 pl. and 1 fig.).

§ Comptes Rendus, clii. (1911) pp. 154-6.

|| Zoologica, xxiii. (1910) pp. 241-314 (3 pls.).

INVERTEBRATA.

Mollusca.

a. Cephalopoda.

Genera of Dibranchiate Cephalopoda.*—W. E. Hoyle has prepared a list of the generic names with their type species, which will be of much service to future enquirers. In each case the ground upon which the type has been selected is stated, and whenever the author is certain that the type specimen of the type species exists in a particular collection, the fact is stated.

b. Gastropoda.

Glands and Luminescence of *Phyllirhoe*.†—E. Trojan describes two kinds of gland-cells in the body-wall: mucus-cells and albumin-cells, the former inclining to be multicellular, the latter always single. There are chromatophores with numerous pigment-granules, functioning like those of Cephalopods. On the lips there are particularly large mucus-glands, which take the place of salivary glands. There are unicellular and multicellular integumentary sense-organs. The luminescence requires stimulus. It is of two kinds, diffuse and restricted, the former due to mucus-cells, the latter to combinations of these cells in clusters. The luminescence is extracellular. The animal is probably poisonous, and the luminescence a warning.

Minute Structure of *Phyllirhoe bucephala*.‡—Ernst Born has made a detailed study of the minute structure of this pelagic Gastropod. He gives an histological account of the skin, the pigment-cells, the nervous-system, the sense-organs, the musculature, the glands, the vascular system, and the excretory structures.

Abnormal Shells of *Achatina*.§—H. Rolle describes and figures some remarkable abnormal shells of *Achatina*, such as a sinistral spiral and an extraordinary scalariform shell.

Blood-vessels and Nerves of *Æolididæ* and *Tritoniadæ*.||—Thos. F. Dreyer has studied a number of different genera in these two families of Gastropods. In no artery, vein, or lacuna was a proper epithelium discernible. All these were lined by a membrane composed of much-branched cells. In both families the heart contains mixed blood. The cerata are specialized respiratory organs. In the *Tritoniadæ* there are blood-glands at the base of the afferent branchial veins. The nerves (except the acoustic and optic) are mixed nerves, united at the periphery by a nerve-plexus of small much-ramified cells. The neuropile breaks up into a number of bundles. Every ganglion-cell has a large thick neurite, and probably numerous dendrites. There is a perinuclear network of neurofibrils from which fibrils extend to the periphery and then

* Abh. Senckenberg Nat. Ges., xxxii. (1910) Festschr. Kobelt, pp. 407-13.

† Arch. Mikr. Anat., lxxv. (1910) pp. 473-518 (2 pls. and 4 figs.).

‡ Zeitschr. wiss. Zool., xcvii. (1910) pp. 105-97 (5 pls. and 2 figs.).

§ Abh. Senckenberg Nat. Ges., xxxii. (1910) Festschr. Kobelt, pp. 191-3 (1 pl.).

|| Zeitschr. wiss. Zool., xcvi. (1910) pp. 373-418 (4 pls. and 4 figs.).

to the neurites. The muscle-fibres are innervated in two ways. Either the plasma of the muscle-cell is in direct connexion with the cells of the plexus, or the whole muscle-fibre is surrounded by a network of nerve-fibres. These are but a few of the many points in this paper.

Arthropoda.

a. Insecta.

Insects of the Rhine.*—Ferdinand Neeracher has made an interesting study of the larval and adult insects found in the Rhine and its tributaries, with especial reference to the seasonal changes and the life-histories. He discusses the mouth-parts of Perlidæ, some new or unknown species of Perlidæ and Ephemeriidæ, and the male dimorphism in *Perla cephalotes* Curt., and *Dictyopteryx microcephala* Pict.

Studies on Bees.—Enoch Zander † gives an analysis of the thoracic skeleton in the hive-bee and in wasps, and sketches the development from the larva onwards. The much-discussed waist is an extremely developed intersegmental groove, between the fourth and fifth segment. The fourth ring is displaced on to the dorsal wall of the thorax, while the fifth segment becomes the stalk and the front wall of the abdomen.

F. Stellwaag ‡ describes the movements of the wings in flight, the mechanism involved, and the musculature. All the parts are so wonderfully connected that a single muscular pull suffices to set all the movements going. It has only a single point of insertion at the root of the wing.

Junction of Fore-gut and Mid-gut in Hive-bee.§—Christian Metzger finds that all the parts of the abdominal connecting portion between fore-gut and mid-gut are differentiations of the fore-gut, which ends blindly. These differentiations are established, in the earliest pupal stages, far forward in the thorax, as a row of successive chambers. They are secondarily displaced into the abdomen. The funnel, which regulates the passage of food into the mid-gut and prevents regurgitation into the honey-sac, is homologous with the gizzard in other insects.

Species and Varieties of Humble-bees.||—H. Friese and F. von Wagner have made a very careful and interesting study of the German species of *Bombus*, discussing the extraordinary variability (with parallelism, convergence, and other phenomena), and their phyletic relations to one another. Tables are given contrasting *Bombus* with other bees, contrasting queen and drone *Bombus* with the queen and drone of its *Doppelgänger Psithyrus*, contrasting the queens of the fifteen German species, showing the times of appearance, and the size. Finally the main varieties of the fifteen species are dealt with in an elaborate table.

* Rev. Suisse Zool., xviii. (1910) pp. 497-590 (19 figs.).

† Zeitschr. wiss. Zool., xcv. (1910) pp. 507-17 (1 pl. and 8 figs.).

‡ Tom. cit., pp. 518-50 (2 pls. and 6 figs.).

§ Op. cit., xciv. (1909) pp. 539-71 (2 pls. and 2 figs.).

|| Zool. Jahrb., xxix. (1910) pp. 1-104 (7 pls. and 20 figs.).

Blow-fly Larvæ and Gravity.*—S. O. Mast has investigated the statement of Loeb that blow-fly larvæ “swim downward” in water, but has found that they do not react to gravity, either in water or out of it. “In air they may be found to orient and crawl nearly straight upward on objects, but this is not due to a response to gravity on the part of the organisms. In water they sink to the bottom or float at the top, depending upon the amount of gas they contain, but there is no evidence whatever indicating that they can swim.”

Metamorphosis of Blow-fly.†—C. Pérez has done a very fine piece of work in his histological account of the metamorphosis of *Calliphora erythrocephala*. He refuses to subdivide the nymphal period into two successive phases of histolysis and histogenesis, for what occurs is a progressive substitution, and the beginning of histogenesis actually precedes that of histolysis. The parts that disappear entirely are the parts most specialized for larval life; the parts that are built wholly de novo from embryonic histoblasts are the parts most specialized for adult life. The less specialized parts, which are more plastic, are re-organized in situ. The importance of phagocytosis, recently doubted by some critics, is made doubly clear by the author's careful work.

Oviparity and Viviparity in Dung-fly.‡—E. Rouband finds that *Musca corvina* Fab. in tropical Africa is viviparous all the year round, and may produce a larva every four days. This viviparity requires for its manifestation an average temperature of at least 30° C. The constant viviparity is interesting, for Portehinsky has shown that in the north of Russia *M. corvina* is constantly oviparous, laying regularly 24 eggs, while in the Crimea it gives birth to a large larva at the end of spring and in summer.

Suctorial Disks of Male Dytiscids.§—Oskar Törne gives a careful account of the structure and mode of action of these familiar organs. The unicellular glands, which Graber interpreted as producing an adhesive secretion, open not on the sucker itself, but in a circle at the base of the stalk. They have nothing to do with adhesion, but may produce a sort of varnish for the setæ, so that the air between the setæ is less readily displaced by the water. The adhesion is mechanical; the suckers of preserved specimens work effectively.

Oogenesis in Dytiscidæ.||—Thomas Günthert has studied the ovary of *Dytiscus* and *Colymbetes*, and describes the origin of the ova and nutritive-cells, the relations between them, and the secretory function of the nutritive-cells.

Respiration in Donacia and Macrolea.¶—Johannes Deibel has studied the habits of these water-beetles, with especial reference to their respiration. The larvæ live on the roots and rhizomes and between the

* Biol. Bulletin, xviii. (1910) pp. 191-2.

† Arch. Zool. Expér., iv. (1910) pp. 1-274 (16 pls.).

‡ Comptes Rendus, clii. (1911) pp. 156-8.

§ Zool. Jahrb., xxix. (1910) pp. 415-48 (2 pls.).

|| Op. cit., xxx. (1910) pp. 301-72 (7 pls. and 2 figs.).

¶ Op. cit., xxxi. (1910) pp. 107-60 (2 pls. and 3 figs.).

leaf-sheaths of various aquatic plants, and feed on the sap which flows out from bitten parts. The larval period lasts for three months, and there are six moults. The ordinary stigmata are closed till the penultimate moult, and the final form is not assumed until the last moult. Respiration is discharged by the special terminal "Häkchen-stigma" which has a closing apparatus. The imago of *Macroplea* remains permanently in the water. It does not use atmospheric gas, but what it gets from plants. This is collected by a multitude of hairs on the antennæ.

Post-embryonic Development of Stratiomydæ.*—Simeon Jusbaschjanz has studied larvæ and pupæ of *Odontomyia* and *Stratiomys*, with special reference to the thoracic imaginal disks, the mesoderm of the appendages, the head-disks, the metamorphosis of the thoracic muscles (in which the new formation is wholly due to the activity of the imaginal myoblast-mass), and the gullet (with its masticatory specializations). Two peculiarities are the thoracic hypodermis-primordia and the secondary formation of a peripodial space.

Brain of Lepisma.†—Otto Böttger has done a very useful piece of work in making a thorough study of the brain of *Lepisma saccharina*, a welcome contribution to the comparative anatomy of the insect's brain. *Lepisma* (the silverfish not uncommon in houses) has a quite peculiar brain, and shows some parts which have not been observed as yet in other insects. The characteristic peculiarities are: (1) the spherical shape of the mushroom-like bodies; (2) the large cell-mass which lies behind these—the quite peculiar grape-like body; (3) the large size of the olfactory lobe and the small size of the optic lobe; and (4) the strength of the labro-frontal nerve and its origin from a particular lobe on the œsophageal commissure.

Study of Corixa.‡—J. Hagemann has made some very interesting observations on *Corixa*, both in its larval and its adult stages. He describes the respiration at successive stages and the structure of the stigmata. A new tympanal organ is described, which occurs in close association with the second stigma. It probably serves for the perception of the notes (of two kinds) which the males produce by rubbing their tarsi against the striated rostrum. The abdominal glands of the larvæ are described, and the asymmetry of the male abdomen is discussed.

β. Myriopoda.

Study of Polyxenus.§—Georg Reinecke has made an interesting study of *Polyxenus lagurus*, a beautiful little Millipede, with particular reference to its mode of life, and its respiratory, alimentary, and reproductive systems. There is relatively little known of the minute structure of the Pselaphognatha to which *Polyxenus* belongs.

The creature lives under bark and the like in moist places. It feeds on wood and vegetable matter. Its alleged destruction of *Phylloxera*

* Jen. Zeitschr. Naturw., xlvi. (1910) pp. 681-736 (3 pls. and 7 figs.).

† Tom. cit., pp. 801-44 (2 pls. and 6 figs.).

‡ Zool. Jahrb., xxx. (1910) pp. 373-426 (2 pls. and 2 figs.).

§ Jen. Zeitschr. Naturw., xlvi. (1910) pp. 845-96 (6 pls. and 21 figs.).

requires confirmation. It has no repulsive glands, such as the majority of the Millipedes possess. The spines may take their place, but it should also be noticed that the animal is very small and shy, and that its coloration is protective. The mid-gut was sometimes almost choked with Gregarines. Pairing has not been seen. Males are very scarce: the author found none among 2000 specimens. Perhaps parthenogenesis occurs. Attention must be directed to the beautiful drawings of the adults.

British Carboniferous Myriopods.*—W. Baldwin describes some fossil Myriopods from the middle coal-measures of Rochdale, namely *Acantherpestes giganteus* sp. n., an enormous specimen of about 195 mm., *Euphoberia armigera* Meek and Worthen, *E. robusta* sp. n., another larger form of about 68 mm. in length, *E. woodwardi* sp. n., and *Xylobius platti* (H. Woodward).

δ. Arachnida.

Circulatory System of *Lycosa carolinensis*.†—A. Petrunkevitch points out that most of the text-book descriptions of the heart of spiders are erroneous. He corroborates the results of Causard, and gives a fine figure from an injected specimen. The heart has three pairs of ostia, not four (except in Theraphosidae). The arterial system is described. As the blood that enters by the second pair of ostia comes directly from the body-cavity, it is probably venous. It is likely therefore that the heart contains mixed blood.

Mites and Tumours.‡—Enzio Renter criticises the evidence brought forward in support of the theory that mites (*Tarsonemus* in particular) may have causally to do with tumours in man and mammals. As an expert acarologist he shows how readily accidental association might come about, and he does not regard the evidence as at all convincing.

Hydrachnids of East African Lakes.§—Charles D. Soar describes three new species, *Neumania papillosa*, *Mideopsis minuta*, *Hygrobates edentipalpis* from Lake Tanganyika, and *Unionicula cunningtoni* sp. n. from Lake Nyassa. He also gives a list of the 18 Hydrachnids as yet recorded from East African Lakes.

Pycnogonids of Clyde Area.||—Richard Elmhirst records *Pycnogonum littorale*, *Endeis (Phorichilus) spinosus*, *Phorichilidium femoratum*, *Anaphia (Anoplodactylus) petiolata*, *A. pygmaea*, *Pallene brevirrostris*, *P. producta*, *Nyuphon rubrum*, *N. gracile*, *Ammotha lævis*, and *A. echinata* from the Clyde area.

Pentastomum of Python.¶—E. Bugnion describes three female specimens of *Porocephalus moniliforme* Dies. from the lungs of a python in Ceylon. The largest was 6½ cm. in length; the head end was very

* Geol. Mag., viii. (1911) pp. 74-80 (2 pls.).

† Zool. Jahrb., xxxi. (1910) pp. 161-8 (1 pl.).

‡ Centralbl. Bakt. Parasitenk., lvi. (1910) pp. 339-44 (2 figs.).

§ Journ. Quekett Mic. Club, 1910, pp. 109-14 (1 pl.).

|| Trans. Nat. Hist. Soc., Glasgow, viii., pt. 2 (published 1910) pp. 146-9.

¶ Bull. Soc. Vaud. Sci. Nat., xlvi. (1910) pp. 467-72 (2 figs.).

slightly club-shaped; the number of rings was about twenty-seven; no stigmata could be seen; the posterior end showed the anus and a genital aperture. The author adds a few more details in regard to a type which still remains inadequately known.

f. Crustacea.

Genital Pores in Norway Lobster.*—D. C. McIntosh has examined over 3000 specimens of *Nephrops norvegicus*, and has combined his results with those previously noted by F. H. A. Marshall. Out of 4237 males 9.8 p.c. had other than the normal two spermiatic openings. Sixteen different arrangements have been noticed, and the total observed range in number of genital openings is from one to six. Marshall observed one case of seven. Of the forms showing variation, 0.5 p.c. had one, 72.3 had three, 21.1 had four, 4.7 had five, and 1.4 p.c. had six. Out of 2064 individuals only 76 were females; out of 4491 less than 5.7 were females, all with two oviducal openings. The author adheres to a view previously expressed that the females being smaller than the males escape from the trawl net more readily.

Fossil Idoteid.†—E. G. Racovitza and R. Sevastos describe *Proidotea haugi* g. et sp. n., a fine fossil from Oligocene strata in Rumania. It is to be referred to the vicinity of *Chiridotea* Harger and *Mesidotea* Richardson, and the author establishes for the three genera a new sub-family Mesidoteini. They form "a natural group, of very ancient origin, completely isolated from the rest of the Idoteids."

Maxillary Glands of Cirripedes.‡—A. Defner has studied the structure of these glands in *Lepas*, *Conchoderma*, and *Balanus*. The relations of the terminal saccule and the urinary canal are carefully worked out. Of importance is the demonstration of a rod-cuticle and plasmic striations in the epithelium of the urinary canal, for this establishes the homology of this part with the urinary canal of the nephridium in other Crustacea.

Geographical Distribution of Diaptomidæ.§—M. Annunziata Tollinger has done a laborious piece of work in summarizing the distribution of Diaptomidæ and some other fresh-water and brackish-water genera in the family Centropagidæ. He uses his results in reference to general problems, such as the derivation of fresh-water forms from a marine stock, the systematic relationships of the genera, and the modes of dispersal.

Revision of North American Species of Cyclops.||—C. Dwight Marsh notes that most of the American species are identical with those in Europe, and that many have a wide range of variation which has led to the premature erection of new species. Following Schmeil's treatise, he has revised the North American species and provided a useful key.

* Proc. R. Phys. Soc. Edinburgh, xviii. (1911) pp. 145-53 (1 fig.).

† Arch. Zool. Exper., vi. (1910) pp. 175-200 (2 pls. and 18 figs.).

‡ Arb. Zool. Inst. Univ. Wien, xviii. (1910) pp. 183-206 (1 pl. and 2 figs.).

§ Zool. Jahrb., xxx. (1911) pp. 1-302 (4 pls. and 178 figs.).

|| Trans. Wisconsin Acad. Sci., xvi. (1910) pp. 1067-1134 (10 pls.).

Copepods parasitic on Aleyonarians.*—Antonio de Zulueta describes some new species of *Lamippe*, and discusses the constitution of the characteristic buccal apparatus and of the furca. On the latter there are interesting aciculi, which alter in length and often bear a refringent globule. The author compares this peculiar kind of aciculus to the axis in the pseudopod of a Heliozoon. One of the interesting facts about the species of *Lamippe* is that each of the eleven Aleyonarians examined had its own particular parasite.

Annulata.

Internal Fertilization in Pareudrilus.†—Luigi Cognetti de Martiis finds evidence that the receptaculum seminis in *Pareudrilus pallidus* is not merely a storage-house for spermatophores, but is adapted to facilitate internal fertilization by migration of the spermatozoa.

Neurochords of Criodrilus.‡—Josef Hönig finds three neurochords in the dorsal part of the ventral nerve-cord of this Oligochæt, extending from the hindmost ganglion to the sub-oesophageal. They appear to arise from nerve-cells in the last ganglion. In all parts of the body they are connected with ganglion-cells, in a perfectly definite way, which is described. Each lateral twig of the neurochord contains a twig of the neurofibril bundle of the giant fibres. The envelope of the neurochord and of its lateral twig contains a variety of glia-cells.

Development of Criodrilus lacuum.§—Franz Staff finds that the cell lineage in this type is like that described by Wilson, Bergh, and Vejdovsky in Lumbricidæ. Between the mesoderm band and the ectoderm, embedded in the latter, there are on each side four pairs of cell-rows, which spring from posterior pole-cells.

The nephridia develop from the retro-peritoneal cell-row which lies laterally to the "primitive muscle-fibres." The row falls into segmentally arranged groups of cells which protrude into the cœlom and are enveloped in peritoneum.

The upper lip of the funnel arises from a large præ-septal cell ("funnel-cell" of various authors), which divides repeatedly. The lumen of the funnel arises by a folding of the septal wall between the upper lip and the first cells of the loop.

Studies on Arenicolidæ.—J. H. Ashworth|| reports on the Arenicolidæ in the Berlin Museum, which include *Arenicola marina* (Linnæus) = *A. piscatorum* Lamarck, *A. claparedii* Levinsen, *A. assimilis* Ehlers, *A. assimilis* var. *affinis* Ashworth, *A. grubii* Claparède, and *A. caudata* Johnston.

The author reports also¶ on the North and South American species, which include the first three mentioned above, along with the gigantic *A. cristata* Stimpson and *A. glacialis* Murdoch. Of the last-named a

* Arch. Zool. Expér., vi. (1910) pp. 137-48 (17 figs.).

† Atti Accad. Sci. Torino, xlv. (1910) pp. 737-50 (1 pl.).

‡ Arb. Zool. Inst. Univ. Wien, xviii. (1910) pp. 257-82 (1 pl. and 1 fig.).

§ Tom. cit., pp. 227-56 (2 pls.).

|| MT. Zool. Mus. Berlin, iv. (1910) pp. 347-54.

¶ Proc. U.S. Nat. Mus., xxx. (1910) pp. 1-32.

full description is given. There is a useful diagnostic key of American species.

In another paper Ashworth* reports on the collection in the Paris Museum, which includes *A. marina*, *A. grubii*, *A. ecaudata*, and *A. pusilla* Quatrefages. Of the last a description is given.

Arenicola loveni.†—J. H. Ashworth gives an account of *A. loveni* Kinberg from Durban and Saldanha Bay. Its systematic position may be stated thus—there is no affinity beyond a generic one between it and *A. claparedii*, *A. assimilis*, and *A. glacialis*. In general appearance it most nearly resembles the large Laminarian examples of *A. marina*, but in its prostomium and setae, and in some of its internal organs, especially its septal pouches and statocysts, it departs markedly from *A. marina* and much more nearly approaches *A. cristata*, from which it differs chiefly in the number of its segments and gills. These facts indicate that the affinities of *A. loveni* lie between *A. marina* and *A. cristata*, but more closely to the latter than to the former. The median lobe of the prostomium is large; neuropodia are clearly visible on each segment; each notopodial seta bears numerous finely toothed crests at regular intervals along the distal third of the shaft; there are two enormous muscular pouches projecting backwards from the first septum, passing through the second, and ending immediately in front of the third; the two statocysts are closed oval sacs, each containing a large oval secreted statolith.

Precision of Regeneration in Polynoids.‡—Aug. Michel has experimented with *Halosydna gelatinosa* and *Lagisca extenuata*, which are very readily provoked to autotomy of segments and elytra. The striking fact which he brings out is the absolute precision with which the normal number of elytra, which alternate in twos or in threes, is preserved in the regeneration.

Sensilli and Eyes of Medicinal Leech.§—L. Hacklov gives an account of the sensilli or unspecialized sensory cells of the leech, which respond to all sorts of stimuli, and shows how by their specialization in one direction they have given rise to eyes, and in another direction to olfactory organs. There can be no doubt that the eyes of *Hirudo* are highly organized results of the evolution of touch-organs.

Chaetognatha from Ireland.||—Rudolf von Ritter-Zahony finds that in the upper layers off the Irish coast this group is almost solely represented by *Sagitta bipunctata* and *Spadella cephaloptera*. There is a comparatively rare occurrence of *Sagitta serratodentata*, and of younger stages of *Eukrohnia hamata*. A very different state of things prevails as regards the Chaetognaths of the mesoplankton; *Sagitta bipunctata* and *Spadella cephaloptera* are entirely absent; *Eukrohnia hamata* predominates, and with it we have nine additional species, of which some are permanently

* Ann. Sci. Nat. (Zool.), 1910, pp. 111-24 (4 figs.).

† Arkiv Zool., vii. (1909) No. 5, pp. 1-17 (1 pl.).

‡ Comptes Rendus, clii. (1911) pp. 152-3.

§ Zool. Jahrb., xxx. (1910) pp. 261-300 (4 pls. and 3 figs.).

|| Fisheries Ireland Sci. Invest., iv. (1910) pp. 1-7.

confined to the mesoplankton, and some are only met with there in an adult state after having passed the earlier stages of their development in the epiplankton of warmer regions. This great difference in the number of species between epiplankton and mesoplankton is characteristic of the temperate zone. In tropical and subtropical regions the Chætognatha of the surface are much more multifarious owing to the presence of numerous epiplanktonic warm-water species, while those of the lower layers, in consequence of the cosmopolitanism of most (perhaps all) of the mesoplanktonic species, scarcely change.

West Indian Chætognatha.*—Rudolf v. Ritter-Zahony reports on a collection from the Tortugas, including *Sagitta helenæ* sp. n., and numerous previously known species. The collection supports the conclusion that the distribution of the epiplanktonic warm-water species is not localized, but extends round the earth in zones bounded to north and south by isotherms.

Theory of Dwarf Males in Myzostoma.†—A. F. Coventry applies G. W. Smith's theory of the dwarf males in barnacles to *Myzostoma*. The theory is that secondary hermaphroditism has been imposed on a primitive dioecism, on the males. Ordinary monœcious Cirripedes are really males, all the females having been suppressed. The complementary males are in an arrested state of development due to the condition of protandric hermaphroditism through which they at one time passed. In Rhizocephala, the dwarf males never become sexually mature, being represented by the *Cypris* larvæ found on the young *Sacculina externa*. Smith believes that these *Cypris* larvæ and the complementary males of the Pedunculata are potential hermaphrodites, arrested by the position taken up by them on fully developed individuals. In Epicarida, all individuals are at first larval males, which, after crawling upon the adult (functionally female) individuals and fertilizing them, migrate to and become parasitic on various Crustaceans, and there assume the female condition. Coventry points out that the facts known about *Myzostoma* seem to be susceptible of a similar interpretation to that suggested by Smith for Cirripedes.

Nematohelminthes.

Idiochromosomes in Ascaris.‡—C. L. Edwards finds evidence of a distinct idiochromosome in *Ascaris megalcephala*. One half of the spermatozoa contain the two well-known rod-shaped elements, while the remaining spermatozoa possess, in addition to the two large chromosomes, the small heterotrophic idiochromosome. In a *univaleus* worm he found a number of equatorial plates of the first cleavage division which showed an unpaired idiochromosome.

In *Ascaris lumbricoides* the sex-determinant is in the form of five univalent idiochromosomes. Some of the spermatozoa have simply 19 chromosomes, and these fertilizing ova with 24 (including 5 idio-

* Zool. Jahrb. (1910), Supplement xi., Heft 2, pp. 133-44 (1 pl.).

† Ann. Nat. Hist., v. (1910) pp. 378-80.

‡ Archiv f. Zellforsch., v. (1910) pp. 422-9 (2 pls.).

chromosomes) are supposed to yield males. The other spermatozoa have 24 chromosomes (including 5 idiochromosomes), and are supposed to yield females.

Comparison of *Ascaris felis* and *A. canis*.*—H. Glaue has made a careful comparison of these two species, which are so near one another in general appearance. By a thorough survey he shows that they differ in numerous anatomical and histological features.

***Strongylus pinguicola*.**†—J. Hellemans describes this Nematode, which is the same as Diesing's *Stephanurus dentatus* and Verrill's *Sclerostoma pinguicola*. He studied it in Java and Sumatra, where it occurs in the domestic pig. The larva occurs in the portal system, the adult in the abdominal fat, in the wall of the pelvis of the kidney, and in the ureter. The parasites produce a very serious inflammation of the portal vein, liver, and kidneys.

Anti-coagulant Action of Nematode Extract.‡—E. Emile-Weil and G. Boyé have found that extract of *Ascaris equorum* has a retardative influence on the coagulation of rabbit's blood, and suggest that this property may in part explain the hæmorrhages caused by these parasites. Anti-coagulants have been demonstrated in *Ankylostomum*, *Ixodes*, *Hirudo*, etc., by various investigators.

Platyhelminthes.

Trematodes from Tortugas.§—Edwin Linton describes a large number of new Trematodes from Tortugas fishes and one from the Loggerhead Turtle. A new sub-order (Deontacotylea) is established for *Deontacylix ovalis* g. et sp. n., and a new family (Siphoderidæ) for certain forms with an anterior oral and a ventral genital sucker. The Allocreadiinæ are well represented, and some very interesting morphological problems are raised. Especially suggestive is the singular Trematode fauna of the black angel-fish (*Pomacanthus arcuatus*), some of the genera of which bear a strong resemblance to genera which are characteristic of turtles. Attention is called to certain cells about the neck and elsewhere in a number of Distomes, e.g., *Deraclena ovalis* g. et sp. n., which are interpreted as yolk-forming.

Echinostomidæ of Birds.|| — Engen Dietz gives an elaborate account of this family of Trematodes, the members of which are characterized by a spinose head-collar round about the oral sucker, but open ventrally. In most cases the shape is reniform. The author recognizes no fewer than twenty-two genera, of which a large number are new. The monograph includes diagnostic tables, arrangement according to hosts, and the like.

* Zeitschr. wiss. Zool., xcv. (1910) pp. 551-93 (26 figs.).

† Centralbl. Bakt. Parasitenk., lvii. (1911) pp. 212-39 (8 figs.).

‡ C.R. Soc. Biol. Paris, lxi. (1910) pp. 284-5.

§ Publication No. 133, Carnegie Inst. Washington (1910) pp. 11-98 (28 pls.).

|| Zool. Jahrb., Supp. xii. (1910) Heft 3, Festschr. Prof. Max Braun, pp. 265-512 (6 pls. and 78 figs.).

Cystotæniæ of South American Felidæ.*—M. Lühe reports on three tapeworms, *Tænia oligarthra* Dies., which is nearly allied to *T. echinococcus* von Siebold; *T. macrocystis* Dies., whose bladder-worm has been known for long from *Lepus brasiliensis*; and *Tænia omissa* sp. n., which seems to have been previously confused with *T. crassicollis*.

Flesh-parasites of Food-fishes.†—Edwin Linton has found Sporozoa along the backbone of young alewives and herring; *Ichthyonema globiceps* in the flesh of a gar (*Tylosaurus acus*); Trematodes in the skin and fins of tautog, cunner, flounders, and tomcod; Cestodes in the flesh of gars, sand lance, and stickleback. The flesh of marine food-fishes is to a very high degree free from parasites, but Cestode cysts sometimes occur in great numbers in the common butterfish (*Poronotus triacanthus*) and occasionally in its rarer relative the harvest-fish (*Peprilus alepidotus*).

New Commensal Turbellarian.‡—Edwin Linton describes *Graffilla gemillipara* sp. n., a Rhabdocel found abundantly in the ribbed mussel (*Modiolus plicatulus*) at Woods Hole. It rarely reaches 2 mm. in length and has a white colour, often tinged with yellow or greenish-yellow along the middle line. The mode of progression is peculiar, in a series of irregular zig-zags, perhaps in adaptation to life within a host. If it went straight on, it would be lost. Another noteworthy feature is that all the larger specimens contained numerous ciliated embryos, which, as a rule, lie together in twos inside a thin capsular envelope. When the reproductive powers of the parent are exhausted, the young escape through the ruptured body-wall.

Hermaphroditism in Nemerteans.§—G. du Plessis finds that *Proso-rochmus claparedi* Keferstein (= *Monopora vivipara* Salensky), a large, brilliantly coloured viviparous Nemertean, with direct development, is also interesting in being viviparous. The testes are very minute sacs irregularly disposed between the intestinal sacs. It seems that *Proso-rochmus* should be included in the genus *Tetrastemma*, beside *T. marioni* and *T. kefersteini*, which are also hermaphrodite. All the Geonemerteans are hermaphrodite. In the fresh-water *Stichostemma vilhardi* Mont., the ovary includes a testicular element which divides into a small group of sperms.

Regeneration in Nemerteans.||—Jozef Nusbaum and M. Oxner have made some interesting observations on *Lineus ruber*, which show that the regenerative "rhythm" (or even the regenerative capacity) differs in different parts of the body. Other things equal, it is a function of the position. Another point clearly illustrated is that an excised piece is distinctly different at its two ends. They have different regenerative potencies, which may be called polarities.

* Zool. Jahrb., Supp. xii. (1910) Heft 3, Festschr. Prof. Max Braun, pp. 687-710 (2 pls. and 8 figs.).

† Bull. Bureau Fisheries, xxviii. (1908) pp. 1195-1209; Bureau of Fisheries Document No. 714 (1910).

‡ Journ. Exp. Zool., ix. (1910) pp. 371-84 (4 pls.).

§ Rev. Suisse Zool., xviii. (1910) pp. 491-5.

|| Bull. Acad. Cracovie, 1910, pp. 439-47 (2 figs.).

Incertæ Sedis.

Development of the Statoblasts of Bryozoa.*—Wolfgang von Buddenbrock has made a careful study of the development of the statoblasts in *Cristatella mucedo* and *Plumatella repens*, in regard to which Braem and Kraepelin have given discrepant account. The author's results corroborate those of Braem in almost every particular. A useful summary is given at the end of the paper, sketching the development of the funiculus and the statoblasts, but it is too long to quote.

Rotifera.

Bdelloid Rotifera: a New Classification.†—D. Bryce puts forward a new classification intended to substitute for that hitherto current an arrangement based on the fuller knowledge of to-day. Without discussing the relationship of the Bdelloida to other Rotifera, he accepts the position given them by Plate and by Wesenberg-Lund as constituting an order of the sub-class Digononta (or two-ovary Rotifera), distinguishing them from the Seisonaceæ by their ramate jaws, their more or less effective rostrum, and their contractile cloaca.

He divides the Bdelloida into three families:—1. Philodinidæ, including all species with well-developed rostrum and corona, the latter always capable of retraction within the mouth. 2. Adinetidæ, including all forms with imperfect rostrum, and a corona which cannot be retracted within the mouth. 3. Microdinidæ, including species possessing a rostrum but without a corona.

It is pointed out that in being able to creep about without the use of the corona the Philodinidæ differ not only from the Adinetidæ, but also from all other members of the class Rotifera.

The family Philodinidæ comprises nearly 100 recognized species which, with few exceptions, conform closely in most respects to one structural plan. The primary and most important distinction is based on the proportion of the lumen, or cavity of the lining membrane of the stomach, to the cavity of the outer or enclosing membrane. It is found that in about one-fourth of the species the lumen is nearly as great as the cavity of the outer membrane, whilst in the remaining three-fourths it is relatively small. The Philodinidæ divide thus into two sections, having respectively a wide and a narrow lumen of the stomach. From consideration of the greater average size, the great proportional development of the corona (and especially of the trochal disks), and of the greater activity, mobility and boldness of the species which have a narrow lumen, the author believes that these represent a later stage in evolution of the family type than that indicated by the species with a wide lumen.

The latter group is represented by three genera:—1. *Habrotrocha* g. n., corona of normal type. 2. *Ceratotrocha* g. n., corona having two

* Zeitschr. wiss. Zool., xevi. (1910) pp. 477-524 (3 pls. and 8 figs.).

† Journ. Quekett Micr. Club, Ser. 2, xi., No. 67, Nov. 1910, pp. 61-92 (1 pl.).

horn-like processes. 3. *Scepanotrocha* g. n., corona screened by a dorsal membranous plate arising from the upper lip.

The species with relatively narrow lumen are divided into three sub-sections:—1. With four toes. 2. With three toes. 3. With toes bearing a number of cup-like suckers or united to form a broad disk or twin disks.

The four-toed species are arranged in five genera:—1. *Philodina* Ehr., skin smooth, spurs short, non-parasitic. 2. *Embata* g. n., skin smooth, spurs long, parasitic. 3. *Dissotrocha* g. n., skin coarse, abdominal transverse skinfolds few, viviparous. 4. *Pleuretra* g. n., skin coarse, abdominal transverse skinfolds numerous, oviparous. In these four genera there is always a distinct throat or gullet. 5. *Abrochtha* g. n., gullet absent, rami protrusible into mouth-cavity.

The three-toed species are assigned to already existing genera according to their customary mode of reproduction, thus:—(a) *Cullidina* Ehr., oviparous; (b) *Rotifer* Schrank, viviparous.

The small group in which the foot ends in a sucker-like disk or twin disks consists mostly of moss-dwelling species, which do not otherwise greatly differ from the family type. A similar foot structure distinguishes, however, two curious parasitic forms, which again differ in the arrangement of the foot-glands. This group therefore is divided into three genera:—1. *Mniobia* g. n., foot short, foot-glands in longitudinal series. 2. *Anomopus* Piovaneli, foot long, foot-glands in longitudinal series. 3. *Discopus* Zelinka, foot-glands in transverse series.

The family of the Adinetidae comprises two genera, differing notably in the type of foot:—1. *Adineta* Hudson and Gosse, foot slender, spurs two. 2. *Bradyscela* g. n., foot stout, spurs modified or absent.

The family Microdinidae is represented only by the genus *Microdina* Murray, having four toes.

The new classification deals with 105 species considered to be capable of recognition, and a list is further given of 49 species thought to be insufficiently described or otherwise invalid. Descriptions are given of two new species, for which it has seemed desirable to create the new genus *Scepanotrocha*, as above. In *S. rubra* sp. n., found in sphagnum from several localities in Great Britain, Germany, and U.S.A., the dorsal membranous corona-screen has its lateral edges rounded. In *S. corniculata* sp. n., obtained from ground moss from Bournemouth, the lateral edges of the screen are produced each into a short point somewhat ventrally deflected.

Rotifera of German East Africa.*—In the 8th Memoir on the Microfauna of German East Africa, collected by F. Fülleborn during the years 1898–1900, E. von Daday enumerates 98 species of Rotifera from that region, of which the following are described as new: *Notommata brachiata* (which evidently is Kirkman's *Copeus triangulatus*, described in this Journal in 1906), *Hydatina oblonga*, *Brachionus bakeri* var. *inermis*, *B. bakeri* var. *fülleborni*, and *B. bakeri* var. *michaelsenii*. The author also gives a tabulated list of all species found in other parts of Africa.

* Zoologica, xxiii. (1910) Heft 59, pp. 59–106 (2 pls.).

Echinoderma.

West Indian Echinoids.*—Th. Mortensen describes the exceedingly beautiful long-spined *Calocularis micans* (Mortensen), *Tretocularis bartletti* (A. Agassiz), *Aræosoma belli* Mortensen, and a number of other forms. A careful description is given of the beautiful blue lines on *Diadema antillarum* Philippi. The difference between the European and the North American Echinoid fauna seems to be very pronounced.

Teeth and Buccal Structures in Conulus.†—H. L. Hawkins has gone into the question of the presence or absence of teeth and jaws in this Cretaceous sea-urchin. They were described by Edward Forbes in 1850, and denied by Duncan in 1884. Most subsequent workers have regarded *Conulus* as toothless. The author examined numerous specimens of *C. albogalerus* and found no trace of teeth, but in a series of *C. subrotundus* in the British Museum he found a specimen with the peristome enlarged by cutting and four glistening, enamel-like teeth projecting towards the aperture. The facts then are that *C. subrotundus* had teeth, of a type differing but little from those of *Discoidea cylindrica*, but the remaining parts of the jaw apparatus were either uncalcified or too delicate for preservation. But in *Conulus albogalerus*, developing along a somewhat different line, the teeth have been lost, and only the pyramids of the jaws retained, modified to form buccal teeth.

West Indian Holothuroids.‡—C. Ph. Sluiter reports on a collection of twenty-six species from the West Indies. It includes a new species of *Stichopus*, two of *Cucumaria*, and three of *Thyone*. The other twenty are well-known forms, and there is little that is of interest as regards distribution. It is noted, however, that *Stichopus maculatus* Greeff, hitherto known only from the West African island of Rolas, has been found at the Tortugas.

Holothuroids from the Indian Ocean.§—Joseph Pearson reports on a collection made by Jas. J. Simpson in the Kerimba Archipelago, Portuguese East Africa. There are twenty-one species. One of these, *Cucumaria turbinata* Hutton, is recorded for the third time. For *Colochirus violaceus* Théel, Pearson establishes a new genus *Pseudocolochirus*, for the form in question does not possess any of the outstanding features of *Colochirus*. The author also reports ¶ on a collection made in the Mergui Archipelago by Jas. J. Simpson and R. N. Rudmose-Brown. It comprises fourteen species, of which the most interesting is *Thyone fusus*, var. *papuensis*, for the species is distinctly northern in its distribution, and occurs in the cold waters of N.W. Europe.

Studies on Holothurians.¶—S. Becher deals with *Leptosynapta bergensis* (Östergren) and *L. inhærens* (O. F. Müller), especially as regards their calcareous bodies, the sensory buds on the tentacles, the

* Bull. U.S. Nat. Mus., lxxiv. (1910) pp. 1-31 (16 pls.).

† Geol. Mag., viii. (1911) pp. 70-4 (1 pl.).

‡ Zool. Jahrb. (1910) Supp. xi., Heft 2, pp. 331-42 (6 figs.).

§ Proc. Zool. Soc., 1910, pp. 167-82 (5 figs.).

¶ Tom. cit., pp. 183-94 (4 figs.).

¶ Zool. Jahrb., xxix. (1910) pp. 315-66 (5 pls. and 2 figs.).

position of the genital aperture near the tip of a tentacle, the calcareous ring, the pulsating peritoneal sacculs or contractile rosettes, the statocysts, the touch-papillæ, the genital sinus. He also discusses, with reference to *L. minuta*, the derivation of the anchor from the primary cross, and the alleged homology between Synaptid and Molpadid anchors. Some other interesting points are discussed, such as the viviparity of this species.

New Starfishes.*—R. Koehler describes *Pentaceros bedoti* sp. n., characterized by the complete absence of spines on the marginal dorsal plates, by the presence of a few small spines on the last marginal ventral plates, and by the weak development of pedicellariæ; *Goniodon angustus* sp. n., from New Zealand, which is nearly related to *G. dilatatus*; *Luidia marginata* sp. n.; and *Asterias spinigera* sp. n., from Singapore, which has a characteristic appearance due to a number of large and prominent regularly arranged dorsal plates, bearing tufts of strong spines.

Remarkable Permian Echinoderm.†—J. Wanner describes *Timorechianus* g. n. from Permian deposits in the island of Timor, a remarkable type with some affinities with Cystoids, Blastoids, and Echinoids. In the position of the Blastoid stalk there is the mouth, and if this be taken as the under surface then the position of the mouth and anus is identical with that of many irregular Echinoids. Perhaps it may be regarded as a Blastoid form, making an attempt, as it were, towards an irregular Echinoid type.

Coelentera.

New Octoradiate Coral.‡—Sydney J. Hickson describes *Pyrophyllia inflata* g. et sp. n. from a depth of 150 fathoms in the Gulf of Oman (Persian Gulf). It is a solitary unattached form, with some characters reminiscent of the extinct Rugosa, but with a closer approach to *Guynia annulata* Duncan. The author considers that *Guynia* and *Pyrophyllia* should be placed in a distinct family of Zoantharia, the Guyniidae, and that this family should be placed next to the family Turbinolidae.

History of the Study of Hydrozoa.§—M. Bedot has brought up his laborious history, which will save future workers much time, to the date 1871.

Regeneration in Corymorpha.||—H. B. Torrey describes the regeneration of the hydranth and holdfast in this hydroid. The plasticity which is so conspicuous a characteristic of the normal development of *Corymorpha* is also a striking feature of the regenerative development. The latter approximates to the former, in fact, at every possible point, varying from it in detail only with the advancing differentiation of the regenerating piece. Tissues in larval stages of differentiation will produce larval structures in the larval way, whether in regeneration or normal development. Adult structures arising on an adult stem vary from this early normal type in the details of their development. The rootlets of the holdfast show the least difference in this respect, de-

* Rev. Suisse Zool., xix. (1911) No. 1, pp. 1-22 (1 pl.).

† Zeitschr. Induk. Abstam., iv. (1910) pp. 123-42 (2 pls. and 3 figs.).

‡ Mem. Proc. Manchester Lit. Phil. Soc., liv. (1910), No. 12, pp. 1-7 (4 figs.).

§ Rev. Suisse Zool., xviii. (1910) pp. 189-490.

|| Publications Univ. California (Zoology), vi. (1910) pp. 205-21 (16 figs.).

veloping essentially as in the embryo throughout the life of the polyp. Yet they arise from larger primordia involving larger numbers of cells. This is true of the tentacles also. "It would appear that the phenomena of regeneration are controlled primarily neither by considerations of future significance nor geometrical relations, but by the differentiation of the physiological mechanism in the region of development."

Studies of Actinians.*—Ferdinand Pax gives an account of the Actinian fauna of the West Indies, describing a large number of forms, including the following new species: *Gyrostoma sancti-thomæ*, *Bumodosoma kükenhali*, *Zoanthus poriticola*, *Palythoa hartwegeri*, *Aiptasia leoductyla*, *Cystiactis koellikeri*.

He discusses the geographical distribution and the question of bipolarity. It has not been proved for littoral forms, it may hold for a small minority of deep-sea forms, but on the whole it is very improbable. The facts as regards Actinians do not support the Pendulation theory.

The author's views as to the phylogeny of Actinians may be summed up in a schema.

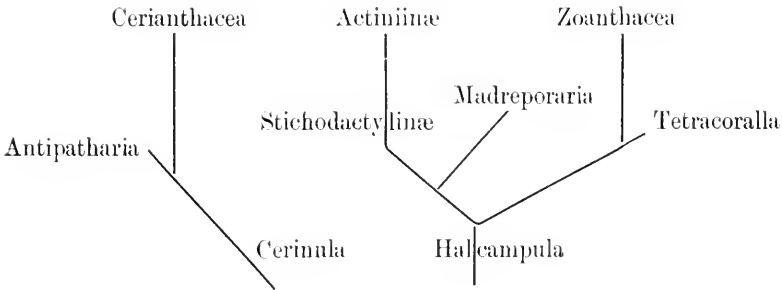

The fine memoir is illustrated by a series of exceedingly beautiful photographs.

Geotropism in Corymorpha.†—H. B. Torrey has made observations on the development of frustules that show gravity to be a factor controlling the direction of their locomotion. Glass plates carrying several hundred freshly laid eggs were fixed at angles of about 85° to the horizontal. Gravity appeared to play no definite part in determining the emergence of the embryos above or below the horizontal. The frustules arose on the embryo always opposite the point of emergence. But with elongation the clavate end of each frustule showed a distinct tendency to migrate downwards, a positive geotropism of definite mechanical value in the establishment of a holdfast firmly anchored over a considerable area.

Senescence in Hydroids.‡—H. B. Torrey and A. L. Martin call attention to progressive serial differentiation or senescence in some hydroid skeletons. Successive hydrothecæ differ gradually in shape, size, and sculpturing; or the pedicels, when present, differ in the

* Zool. Jahrb., xi. (1910) pp. 157-330 (10 pls., 46 figs. and 1 map).

† Publications Univ. California, (Zoology) vi. (1910) pp. 223-4 (1 fig.).

‡ Advance print, Proc. 7th Internat. Zool. Congress, Boston 1907 (published 1910), 2 pp.

number and size of their annuli. The type of differentiation represents essentially a type of colonial senescence.

In aquaria in which intact colonies of *Clytia bakeri* developed as in nature, it was found that stems cut at given levels regenerated in certain respects not according to the original type for that level, but according to the type characteristic of the distal or youngest member of the stem. This result indicated a general physiological change throughout the stem correlated with advancing age.

Effect of Light on Obelia.*—H. B. Torrey and A. L. Martin find that a given stem of *Obelia* regenerates from a distal cut two or three hydranths in the time required for the production of one hydranth by a similar stem under similar conditions, except that it develops in daylight. The annuli on the pedicels supporting the hydrothecæ are more numerous in the darkness specimen. The effect of light on *Obelia* is to retard growth and differentiation—the opposite to what Loeb found in *Eudendrium*.

Porifera.

Hexactinellid Spicules.†—R. Kirkpatrick, in a continuation of his classification of these spicules, points out that clavulæ and scopulæ are holactine micromonactins, and suggests that their spines and disks should be termed centropines and centrodiskis, to distinguish them from the true end-spines and end-disks at the distal end of the actines of astral spicules. He also notes that microhexactins, which he spoke of as absent in Hexasterophora, occur in certain dictyonine species, but appear to be entirely absent from most of the Hexasterophora.

Protozoa.

New Species of Cassidulina.‡—Henry Sidebottom describes and figures *Cassidulina elegans* sp. n., and *C. decorata* sp. n., both from the S.W. Pacific.

Fat in Ciliated Infusorians.§—Witold Staniewicz has made experiments on *Paramacium*, *Stentor*, and other Infusorians in regard to the use they make of fat. He shows that the Infusorians are able to ingest fat, but they do not break it up or emulsify it. The fat found in the cells of Infusorians is due to substances which they can digest, especially proteids and carbohydrates. It seems that no Protozoa can digest fat, whereas all Metazoa can.

New Flagellate in Pelagic Copepod.||—E. Chatton describes *Paradinium poucheti* g. et sp. n., found in the general cavity of *Acartia clausi* Giesbrecht. There is a massive plasmodium, fragments of which pass out by the gut of the host, forming cysts which sporulate. Before the spores acquire their flagellate form they are amœboid, and these

* Advance print, Proc. 7th Internat. Zool. Congress, Boston 1907, published (1910) 1 p. † Ann. Nat. Hist., v. (1910) pp. 347-50 (5 figs.).

‡ Journ. Quekett Micr. Club, 1910, pp. 103-8 (1 pl.).

§ Bull. Acad. Sci. Cracovie, 1910, pp. 199-214 (1 pl.).

|| C.R. Soc. Biol. Paris, lxi. (1910) pp. 341-3.

occur united in chains by elongated filiform pseudopodia, recalling Labyrinthulids. The new genus seems to be allied to *Syndinium*, a plasmodial Dinoflagellate also found in pelagic Copepods.

Astomatous Infusorians.*—C. Cépède gives a beautiful illustrated account of the mouthless parasitic Infusorians which occur in most types of animals in the alimentary canal, the gastrovascular cavity, the cœlome, the liver, the mantle-cavity, the uterus, and the gonads. Numerous new genera are established: *Kofoidella*, *Intoshellina*, *Maupasella*, *Anoplophrya*, *Schultzellina*, *Perezella*, *Isselina*; and ten families are recognized. The action of these Infusorians on their hosts is carefully discussed, including parasitic castration and teratogeny.

The group is heterogeneous and due to convergence, in adaptation to parasitism, from several distinct stocks of Ciliata. The author has especially studied the process of division and the developmental cycle in *Orchitophrya stellarum*.

Studies on Trypanosomes.—C. Mathis† and M. Leger discuss *Trypanosoma clarix* Montel found in the blood of *Clarias macrocephalus*, a common Silurid fish in Cochinchina. It does not seem to be pathogenic. In the same fish they found ‡ a common form of *Trypanoplasma*, which they provisionally rank as *Trypanosoma clarix*. It is apparently the first record of a species of *Trypanoplasma* from a Silurid.

Cnidosporidia.§—M. Auerbach has done a useful piece of work in presenting a monographic account of Myxosporidia, Actinomyxidia, and Microsporidia, which he unites, following Doflein, in the order Cnidosporidia. The spores are enclosed in multivalve shells, which arise in the sporoblast from special cells. Inside the spores there is a variable number of pole-capsules with a rolled-up thread. The monograph includes a general introduction, a morphological account of the vegetative forms and spores, an ecological chapter dealing with the parasitism, a discussion of the life-histories, a systematic chapter, and an account of the literature.

Selenococcidium and the Relationships of the Sporozoa.||—L. Léger and O. Duboscq discuss *Selenococcidium intermedium*, which they found in the lobster in 1908, and which has the particular interest of uniting characters of Coccidians and Schizogregarines. They give an account of the life-history, and discuss its relations. They also describe from the lobster *Toxocystis homari* g. et sp. n., which seems always present in the posterior intestinal cæcum, sometimes as an intracellular, sometimes as an extra-cellular parasite. Its position is doubtful. The authors divide Sporozoa into four classes:—(1) Sporozoa sensu stricto (Gregarines, Coccidians, etc.); (2) Cnidosporidia; (3) Flagellates (Cercomonads, Plasmodids, Bodonids, etc.); and (4) Haplosporidia. They also give an interesting tentative genealogical tree.

* Arch. Zool. Expér., iii. (1910) pp. 341-609 (9 pls.).

† C.R. Soc. Biol. Paris, lxi. (1910) pp. 349-51.

‡ Tom. cit., pp. 351-3.

§ Die Cnidosporidien. Eine Monographische Studie: Leipzig, 1910, 261 pp. (83 figs.).

|| Arch. Zool. Expér., v. (1910) pp. 187-233 (2 pls. and 7 figs.).

Hæmogregarines.* A. Laveran and A. Pettit have studied the Hæmogregarines of the wall-lizard, distinguishing *H. bicapsulata* França and *H. nobrei* França, but the latter seems almost identical with *H. lacertæ* Danilewsky.

Hæmatozoa from the Congo.†—A. Lebaeuf and Ringenbach describe *Trypanosoma simondi* sp. n. and *T. synodontis* sp. n. from Silurid fishes from Stanley Pool. They also report *Hæmogregarina canis* from a dog, and three species of minute Nematodes (*Microfilaria*) from the blood of toad, lizard, and chimpanzee. One of these, *M. martini*, is new.

* C.R. Soc. Biol. Paris, lxi. (1910) pp. 303-5.

† Ann. Inst. Pasteur, xxiv. (1910) pp. 945-54 (2 pls.).



BOTANY.

GENERAL,

Including the Anatomy and Physiology of Seed Plants.

Structure and Development.

Vegetative.

Observations on Primary Leaves.*—Léon Dufour arrives at the following conclusions. Certain species produce primary leaves of a simpler form than the adult leaves, and as a rule the leaves pass by progressive stages from the simpler to the more complex form. Comparison shows that the primary leaves of one species resemble the adult leaves of an allied species. In other cases the primary leaves also are somewhat complex, the degree of complexity varying in different species. Many authorities hold that these simple forms have a genealogical signification, and that a species with complex leaves will reproduce in its primary leaves the form of the adult leaf of an ancestor. This is a striking illustration of the law that the evolution of the individual (ontogeny) reproduces the evolution of the race (phylogeny). The author's investigations confirm this opinion. It is reasonable to suppose that a species whose leaves stop at a certain degree of complexity, is more nearly allied to an ancestor with simple leaves than another which bears complex primary leaves and still more complex adult ones.

In the case of the Anemones studied, while it would be too much to assume that *A. palmata* is descended directly from *A. hortensis* and the latter from *A. Pulsatilla*, it is admissible that these species arise from a common ancestor with simple leaves, and that they exhibit different stages of evolution, culminating in *A. Pulsatilla*.

Primary leaves possess, therefore, two striking peculiarities: (1) they reproduce ancient forms; (2) this reproduction is very faithful. The conditions under which they are produced ensure them against modification by external influences. The instances of Anemones and of Umbelliferae bearing complex primary leaves do not disprove this theory. Individual development can only reproduce that of the race by a contraction of time and by the omission of certain stages—a phenomenon known as "meta-genetic acceleration."

Plants which from the outset bear complex leaves are then higher in the evolutionary scale than those which bear simple primary leaves, and in their more rapid development, certain stages known to their ancestors are omitted. It is evident, therefore, that the study of primary leaves will be of use in the discovery of the affinity of species. It suggests connecting links that would not be suspected from observation limited to adult plants.

* Rev. Gén. Bot., xxii. (1910) pp. 369-84 (pls.).

Anatomical Researches on Sea-side Plants.*—H. Chermeson finds that the littoral flora is composed chiefly of a xerophilous and a halophilous flora. The xerophilous characteristics consist mainly of epidermic protection. The leaves and even the stalks of halophilous plants are more or less fleshy, and epidermic protection is rare. Both floras exhibit a radial habit and a somewhat dense mesophyll. Certain dune plants present a slight fleshiness and certain salt-marsh plants epidermic protection. Xerophilous plants occur frequently on the rocky shores of the Mediterranean; the fleshiness of the halophiles varies with the degree of saltiness and is greatest in the salt marshes. The resemblance between the two floras has caused Schimper to confuse them, but as a rule halophiles do not present xerophilous characteristics, which could hardly be accounted for, especially in salt marshes; on the other hand several salt-marsh species possess hygrophilous peculiarities. The sole characteristic of halophiles is, in fact, the fleshy form, caused either by the number of layers or by the size of the cells; the fact that fleshy plants are found other than on sea-beaches simply proves that fleshiness may result from other causes than the presence of salt. The fleshy habit appears to aid the plant in resisting the action of sea-salt, but some plants found in very salt districts (*Frankenia*, *Statice*, etc.) are not fleshy; therefore ability to withstand saltiness must be something entirely specific. As to the action of salt in the distribution of species, it is clear that a certain degree of saltiness eliminates many plants; several authors have thought that the localization of various species on the sea-shore is due to the fact that they found less competition there; but a flora such as that of the salt marshes can hardly be considered as refugees, seeking a field for expansion; some of its species are not dependent on salt, but so far the majority of them may be included among the true halophiles.

Transitory Tissues in Vascular Plants.†—G. Chauveaud gives an account of these tissues, which fall under the two heads of Secretory and Conducting; the former confined to a few, the latter found in plants generally.

Transitory Secretory Tissue.—The Gymnosperms are especially concerned, and of them the yew, in which typical secretory canals are absent. The secretory tubes with which the present paper deals keep their secretion products, instead of passing them into neighbouring canals.

The distribution and development of these tissues in the seedling of *Taxus baccata* is described at length. The case of young organs on adult parts is then dealt with. The arrangement in the case of a rootlet is the same as in the radicle. At the growing-point of a stem the hypodermal secretory system found in the hypocotyl is absent, and the same distinction obtains between cotyledon and young leaf. For the rest, the disposition of the transitory secretory tissue is substantially the same for hypocotyl and young stem, and for cotyledon and developing leaf, respectively—namely, in arcs abutting on the phloem. The secretory tubes ultimately become septate, and in adult parts are, save in rare cases, indistinguishable from ordinary parenchyma. They are thus essentially transitory in structure and function.

* Ann. Sci. Nat. ser. 9, xii. (1911) pp. 117–313 (figs.).

† Tom. cit., pp. 1–70.

Transitory Conducting Tissue.—The account opens with a general discussion of sieve-tube tissue, which hints at the deep phyletic interest attaching to this line of research. In the Ferns, a relatively primitive group, we find an advanced type of sieve-tube; and the author is inclined to regard the simpler type of phloem found in certain Lycopods as the result of reduction in descent. The sharp distinction often made between the phloem of Angiosperms and that of other groups is not altogether justified—e.g., the case of companion-cells in *Equisetum*, etc. The problem before us is the search in the ontogeny of plants for simple organs which function as sieve-tubes temporarily in meristematic regions; this may afford a guide in the wider phylogenetic problem.

It is in the Gymnosperms that the author finds such organs, and from this standpoint the group is to be regarded as primitive. In Gymnosperms the first true sieve-tube elements appear further from the growing-point than the first xylem elements, in contrast with other groups in which the reverse obtains. This results from the presence of the transitory tissue (*phloème précurseur*), the tubes (*tubes précurseurs*) comprising which show all stages of differentiation from very simple types (radicle of *Thuja orientalis*) to complex (*Abies Pinsapo*). In all cases, however, the tissue is essentially transitory, and, excepting in the root, it exists only in the earliest stages of the ontogeny; the degradation of the tissue is initiated by loss of turgidity in the cells, which finally become completely absorbed. The details of the nature and arrangements of the *phloème précurseur* are given for radicle, hypocotyl, and cotyledons, for *Thuja orientalis* and *Abies Pinsapo*. It is unrepresented elsewhere in the life-history, excepting in the meristem of the developing rootlets, in which the arrangement is the same as in the radicle. The primary phloem proper may also be transitory in the seedling, as is well seen in *Cryptomeria japonica*. Transitory xylem is described in the seedling of *Lycopersicon esculentum*; in this plant the primary sieve-tubes persist. The occurrence of transitory xylem and phloem in the adult plant is investigated in very young leaves of *Abies bracteata*, in which first the earliest phloem elements, then the xylem vessels, disappear. Their place is taken by conjunctive parenchyma, so that the vascular bundle, originally single, becomes divided into two by this parenchymatous invasion. The author urges that in all Firs which have a double bundle in the adult leaf the double condition is produced in this same way; and this is demonstrated in detail also for *Pinus Pinea* and *P. sylvestris*, in which the two bundles are widely separated.

The author then discusses the frequency of transitory conducting tissue in Angiosperms, referring to his previous work on the subject, and citing the cases of *Raphanus sativus*, *Phaseolus vulgaris*, Labiatae, Chenopodiaceae, *Triglochin palustris*, Liliaceae, Zingiberaceae—in fact, in the most diverse groups of Phanerogams. Finally, he examines in detail the arrangements of the vascular system in the seedling of *Mercurialis annua*, tracing its course from root-meristem to the tip of the cotyledon. He connects the manifold transitions in disposition of the bundles in this course by the existence and disappearance of transitory xylem and phloem, which thus play an important part in the distinction, hitherto regarded as essential, between the vascular structures of root and stem; and he points out that the same investigation holds good in the case of numberless other plants, whether Angiosperms or Gymnosperms.

Reproductive.

Embryo-sac Development in *Hybanthus concolor*.*—Frank M. Andrews publishes a brief account of this, with eight figures. The embryo-sac originates from a hypodermal cell. This divides into an upper tapetal cell and a lower, the embryo-sac mother-cell. The active division of the former results in the more or less deep embedding of the latter in tissue. The mother-cell divides normally into four, often irregularly arranged, and the embryo-sac is formed, it is stated, by the destruction of the tetrad as well as some of the surrounding cells; it is very large in size, and the egg-aperture and antipodal cells are unusually so, often extending nearly across the embryo-sac lengthwise. The polar nucleus, however, is generally rather small.

Seeds of European *Papaveraceæ*.†—Louis Capitaine publishes an interesting study showing the value of the seeds of this order in determining not only the genera but the species also. The account is accompanied by excellent reproductions of photographs, from which the distinctive characters of nearly all the seeds dealt with may be readily appreciated. Claves of the species are given for every genus; the six genera themselves fall into the following scheme:—

Seeds with well-marked concave hilum.

Seeds very small (about $\frac{1}{2}$ mm.), crescent- or comma-shaped or globular; or as much as 1 mm., but then globular and with secondary reticulum (*P. setigerum*)

Papaver.

Seeds crescent-shaped, about 1 mm., no obvious secondary reticulum

Ranunculus.

Seeds with hilum feebly developed.

Seeds oval, with pergamaceous aril

Chelidonium.

Seeds without papyraceous aril.

Seeds not D-shaped.

Seeds gently curved at the hilum, shaped like a bent club, very convex on the back

Meconopsis.

Seeds large as a millet, shaped like a 'quarter' of an orange

Glaucium.

Seeds almost square, D-shaped, but feebly marked

Hypocoum.

Physiology.

Nutrition and Growth.

Absorption by Plants of Alkaline Earth Salts.‡—H. Colin and I. de Ruzf Lavison publish a continuation of previous work upon this subject, extending their experiments with the nitrate of barium to salts of strontium and calcium. Using pea plants, they find that salts of calcium penetrate to a considerable extent into the stem; salts of strontium

* Bull. Torrey Bot. Club, xxxvii. (1910) pp. 477-8 (figs.).

† Rev. Gén. Bot., xxii. (1910) pp. 432-45 (pls.).

‡ Tom. cit., pp. 337-44.

to a far less, but appreciable extent; while absorbed salts of barium do not reach the stem at all. It follows that the less the molecular weight of the base the further the salts mount into the stem. The barium salts, on the other hand, accumulate in the root much more considerably than the others.

Cryoscopic Determination of Osmotic Pressure in certain Plant-organs.*—W. R. Gelston Atkins draws attention to the importance of osmotic pressure in relation to the vital functions of the living cell, emphasizing the evolutionary aspect, the earliest organisms being water-dwellers. The present paper forms one of a series of records aimed at discovering the relation between the osmotic pressure and the general metabolism in selected plants, and deals with fleshy organs—fruits, rhubarb stalks, artichoke tuber, etc. The osmotic pressure P is calculated from observation of depression Δ in the freezing-point of the sap, from the equation $P = 12.03 \Delta$, the temperature being 0°C . The predominating substances in the sap, further, may be ascertained roughly from the mean molecular weight (M); and this has been ascertained in many cases by evaporating a weighed quantity (not more than 3 gm.) of filtered sap in a steam-oven until a constant weight is obtained. The weight of the solvent being l —viz. weight of sap less weight of solids, s , and k being the constant for the molecular lowering of the freezing-point of the solvent, we have $M = \frac{s}{l} \times \frac{k}{\Delta}$.

The pressures recorded range from 5.94 atm. (fruit of *Lycopersicum esculentum*) to 29.53 atm. (fruit of *Pyrus communis*). *Rubus Idaeus*, with pressure of 9.26 atm., represents a mean of pressure for many ripe berries.

Interesting details and a table of results are given. As the result of over fifty measurements, the author concludes that similar plant-organs of the same species have approximately equal osmotic pressures; but this does not apply to leaves. The mean molecular weights in the case of fruit ranged from 110 (*Lycopersicum esculentum*) to 231 (*Citrus Aurantium*). In the case of underground organs the pressure ranged from 6.5 atm. (*Solanum tuberosum*) to 18.7 atm. (*Helianthus tuberosus*), and the mean molecular weight from 101 (*Brassica Rapa* root) to 394 (*Helianthus tuberosus*), the highest figure determined. The red stem of rhubarb gave the lowest recorded mean molecular weight 76, with osmotic pressure of 6.52 atm.

Regeneration and Polarity of Plant-organs.†—J. Döposcheg-Uhlár's account is well illustrated by reproductions from photographs. Dealing first with Ferns, it is established that the shoots regenerated from a seedling, from which the growing-point has been removed, develop in the same way as young plants arising from a fertilized archegonium. The shoots usually arise exogenously, but exceptionally endogenously. "Regenerates" from internodes in the Ferns display a similar development. They may arise exogenously below the epidermis, or near the surface of the callus formed on the cut surface. If bud-shoots be

* Sci. Proc. Roy. Dublin Soc., xii. (1910) pp. 463-9.

† Flora, cii. (1911) pp. 24-86 (figs.).

induced upon the stem of *Lycium halimifolium* in a moist place, and the roots removed therefrom, a shoot may arise from the root-stump so formed. If bud-shoots be initiated on the "primary" leaves of *Begonia caroliniaefolia*, which are undivided, several undivided leaves are first produced by these shoots before a divided one appears; but in the case of one of the shoots induced upon the ordinary digitately divided leaves, a divided leaf is developed at an early stage. It is suggested that the principle of this difference depends upon available food-material. Shoots induced upon an internode without growing-point appear usually arbitrarily, in no fixed order, and only exceptionally are they produced in regular (polar) succession. With root-shoots the reverse is usually the case. Internodes were partially isolated from axes of *B. discolor* by two cuts made in opposite directions. As a result, roots appeared on the side of the internode left connected with the apical part of the axis and shoots on the opposite side—i.e., the side left connected with the basal or root portion. At the same time roots appeared on that part of the axis above the internode, and shoots on the lower part. Shoots so induced upon the root portion bear, in the autumn, an internodal tuber. This is abnormal, for such are borne normally only upon underground parts, although shoot-tubers may appear in the leaf-axils. Shoots produced similarly by wounding upon *Gesnera graciosa* revealed no polarity in the order of their appearance. A notable fact was the development of tracheids in the wound-callus, which replaced the severed normal water channels. The number of leaf "regenerates" in Gesneraceae was found to depend on the degree of nutrition in the parent plant. Shoots of plants which have already begun to form subterranean tubers may be caused to bear subaerial tubers at the stem-apex and in the leaf-axils. The continued removal of leaf-bulbils acts as a stimulus both to the production of fresh bulbils and to the duration of the life of the leaf.

General.

Cratægus: Some Theories concerning the Origin of its Species.*

H. B. Brown points out that former systematists conceived of species as being much more composite than they are at present regarded; the Linnean conception prevailed. Recent workers who have been studying species closely, especially students using the culture method, find that many systematic species are made up of a number of distinct forms, or elementary species that breed true when propagated by seed. The author is inclined to think that a great many of the *Cratægus* forms are hybrids. European species are known to hybridize, and species in several other genera of the rose family hybridize freely.

Within the past few decades, since the primitive forests have been cleared away, there has been an immense increase in the number of *Cratægus* plants growing. Being low trees or shrubs, they cannot thrive in dense forests, but spread freely over open pastures and along fence rows. The increase in number of plants makes cross-pollination easier and more probable. Irregularity in the number of stamens and pistils,

* Bull. Torrey Bot. Club, xxxvii. (1910) pp. 251-50.

variation in the shape of the leaves on the plant, variation in the colour of the anthers, and the occurrence of plants possessing characters found in two distinct species growing near by, may all be taken as evidence of hybridity, or progressive species.

The fact that *Cratægus* plants seem to come true to type when grown from seed is a stumbling block in the way of a hybridity theory. However, it is possible that *Cratægus* hybrids are stable, and come true to type when grown from seed. It cannot be said that they have been tested thoroughly until many mature plants have been grown.

Some of the points just made may be taken as evidence of mutations, but the best known mutants are not as irregular in characters as many of the species of *Cratægus*.

CRYPTOGAMS.

Pteridophyta.

(By A. GEPP, M.A., F.L.S.)

Pteridophytal Origin of so-called Algal Coals.*—E. C. Jeffrey has investigated the nature of some supposed algal coals. By means of the slow action of concentrated acids, alkalis, etc., applied for weeks at a time, he has succeeded in softening the coal sufficiently to admit of microtome-sections, and even of serial sections, being cut. He gives the following summary of his conclusions. 1. The organisms found in abundance in boghead coals are not of the nature of colonial gelatinous algae, as has been asserted by Renault, Bertrand and Potonie, on the basis of the examination of a small number of insufficiently thin sections of such coals. 2. The bodies in question, as revealed in thin serial sections, made by improved technique on the microtome, are spores of vascular cryptogams. 3. The proof that the constituent micro-organisms of boghead coals are not algae but spores, overthrows the algal hypothesis of the origin of petroleum and similar substances. 4. It appears clear that petroleum products have been derived, mainly at any rate, from the waxy and resinous spores of vascular cryptogams laid down on the bottoms of the shallow lakes of the Coal Period. These lacustrine layers, either as cannels, bogheads or bituminous shales, according to the sporal composition and the admixture of earthy matter, are the mother-substance of petroleum. Pressure and temperature either separately or combined, in the presence of permeable strata, have brought about the distillation of petroleum from such deposits.

Nomenclature of Nephrodium.†—W. N. Clute calls attention to another revolutionary change which threatens the nomenclature of the large group of ferns ranged till a few years ago under the well-known generic names *Nephrodium* or *Lastræa*, but latterly transferred to the revived and prior name *Dryopteris*. It now appears that all the species will have to be renamed once more, since J. A. Niewland has shown in the June number of the American Midland Naturalist that before

* Proc. Amer. Acad. Arts and Sciences, xli. (1910) pp. 273-90 (5 pls.).

† Fern Bull., xviii. (1910) pp. 82-92.

Adanson published the name *Dryopteris*, Schmidel had already put forward the name *Thelypteris* for the same group of ferns, and in connexion therewith published an illustration of the marsh-fern *Nephrodium Thelypteris* which is unmistakable. W. N. Clute protests strongly against these wholesale changes of nomenclature, and questions whether according to American rules a still earlier use may not be found for *Thelypteris* in replacing *Pteris* rather than *Dryopteris*.

Fern-flora of Spain and Portugal.*—R. de Litardière publishes a contribution to the study of the fern-flora of the Iberian Peninsula. A total of 70 native species and sub-species is known in Spain and Portugal, 65 occurring in Spain and 42 in Portugal; thus five of them are not found in Spain and 28 not found in Portugal; and they are indicated in lists. The fern-flora is very varied, ranging from the Arctic-alpine species of the high mountains to the Canarian species scattered along the shores; there is a good representation of the ferns of Central Europe, and all the Mediterranean species are found; also three endemic species and several endemic forms occur. The author gives analytical lists under the following headings:—(1) Element of the forest region of the northern hemisphere; (2) Atlantic element; (3) Mediterranean element; (4) Arctic-alpine element; (5) Alpine element; (6) Cosmopolitan element; (7) Sub-tropical element; (8) Endemic element. The author then adds a series of notes on the more interesting species and forms, especially the new *Asplenium majoricum* from the Balearic Islands, and *Dryopteris africana* which with *D. æmula*, *Cystopteris diaphana*, *Asplenium hemionitis*, *Davallia canariensis*, and *Woodwardia radicans*, forms a vestige of the rich Canarian vegetation which prevailed in Pliocene times.

Ferns of South Croatia.†—L. Rossi gives an account of the Pteridophytes of South Croatia, the results of many years of collecting. In all there are 43 species and many varieties and forms. Some of the forms are new. The local distribution of the plants is recorded.

Ferns of North America.—E. J. Hill‡ publishes some notes on American ferns: (1) *Woodwardia virginica*, a rare plant, always grows associated with Sphagnaceae, especially with *S. recurvum* in the wettest part of a swamp; (2) *Nephrodium spinulosum*; (3) *Dicksonia punctilobula* and its distribution in the United States; (4) *Botrychium obliquum* and *B. ternatum* var. *intermedium*, their distribution and their difference in time of spore-ripening.

W. N. Clute§ writes of the genus *Hemionitis* and gives a figure of *H. arifolia*, a Philippine species. He also shows|| how *Pellæa atropurpurea* may be recognized even in quite a juvenile stage. Under the heading¶ Pteridographia he has put together some notes on *Nephrolepis*; *Azolla* and mosquitos; Apospory in ferns; an evergreen *Cystopteris*; *Botrychium*; a fragrant marsh-fern.

* Bull. Géogr. Bot., xxi. (1911) pp. 12-30.

† Magyar Bot. Lapok., x. (1911) pp. 22-38.

‡ Fern Bull., xviii. (1910) pp. 65-76.

§ Tom. cit., pp. 76-8.

¶ Tom. cit., pp. 79-80.

§ Tom. cit., pp. 76-8.

¶ Tom. cit., pp. 83-7.

A. Prescott* gives a short account of the boulder-fern, *Dicksonia pilosiuscula*.

Ferns of Temperate South America.†—C. Christensen gives an account of a collection of ferns made by C. Skottsberg in temperate South America, namely, in the Falkland Islands, Tierra del Fuego, West and East Patagonia, Chiloe, Juan Fernandez. In all he enumerates 67 species. Additions to the flora of Juan Fernandez and of the Falklands are recorded; and three new species are described, namely, *Polypodium* (*Grammitis*) *patagonicum*, *Hymenophyllum Skottsbergii*, and the curious *Blechnum longicauda*, which previously had been confused with the Malayan *Asplenium longissimum* Bl.; the proliferous fronds may be two metres long, and hitherto have been found in the sterile state only. Van den Bosch's genus *Serpyllopsis* is revised for the species *Trichomanes cæspitosum*, which is intermediate between *Hymenophyllum* and *Trichomanes* in some respects, but is distinguished from both by the indeterminate growth of its fronds and the red pubescence of the rachis and midribs.

Ferns of Argentina.‡ — C. M. Hicken publishes a new scheme of classification of the Polypodiaceæ, dependent on the position of the sorus, whether covering the whole under-surface, or on the nerves only, the whole nerves or particular portions of the nerves, with or without an involucre. The Gymnogrammeæ are kept separate from the Pterideæ; the Woodsiæ and Oleandreae are united with the Aspidiæ. He also publishes § some artificial keys of the Argentine species of Acrosticheæ. He describes || *Elaphoglossum Porteri*, a new species from the frontier of Argentina and Chile; and records six species which are additions to the Argentine flora. He publishes ¶ an artificial key to the Argentine species of Vittariæ, and adds two new records to the Argentine flora. He publishes ** artificial keys of the genera and species of the Gymnogrammeæ, and †† of the Pterideæ found in Argentina.

Ferns of German Central Africa.‡‡—G. Brause and G. Hieronymus give an account of the ferns gathered by J. Mildbraed during the expedition of Herzog Adolph Friedrich von Mecklenburg in tropical Africa. In all there are 121 Pteridophyta, fourteen of which are new species or varieties. The specimens were collected in the following localities:—Bukoba-Bezirk, Ruanda, Rugege-Wald, Vulcan-Gebiet, Ruwenzori, Beni, Gr. Kamerunberg.

New Japanese Ferns.§§—J. Matsumura publishes Latin descriptions of seven new species and three new varieties of Japanese ferns, collected in Liukin, Formosa, Nippon, etc., and determined by H. Christ.

* Fern Bulletin, xviii. (1910) pp. 81-2.

† Arkiv Botanik, x. No. 2 (1910) 32 pp. (1 pl. and figs.).

‡ Apuntes de Historia Natural. Buenos Aires, i. (1909) pp. 5-8.

§ Tom. cit., pp. 17-20.

|| Tom. cit., pp. 34-7.

¶ Tom. cit., pp. 49-51.

** Tom. cit., pp. 81-3.

†† Tom. cit., pp. 113-22.

‡‡ Wiss. Ergebn. Deutsch. Zentral-Africa Exped., ii. (1910) pp. 1-40 (2 pls.).

§§ Tokyo Bot. Mag., xxiv. (1910) pp. 239-42.

Bryophyta.

(BY A. GEPP.)

Inter-relationships of the Bryophyta.*—F. Cavers discusses the Anthocerotales. He gives an account of the morphology and anatomy of *Anthoceros*, and describes the development of the reproductive organs and of the sporogonium, and the characters of the mature sporogonium. He then shows in what respect the allied genera, *Dendroceros*, *Notothylas*, and *Megaceros*, differ from *Anthoceros* and from one another. As to the systematic position which the Anthocerotales should occupy, he cites M. A. Howe's summary of the characters which are held to mark off the Anthocerotales from the remaining hepaticæ; but he considers that the significance of these characters has been much exaggerated, leading to a deal of doubtful speculation regarding the relationships of the Archeogoniata and the origin of the Pteridophyta. He discusses the said characters one by one, and shows them to be less distinctive than they at first appear to be. The Anthocerotales probably have arisen from forms like the Sphærocarpales; they have retained a meristematic zone at the base of the sporogonium, and their antheridia, originally exogenous, have become endogenous; the formation of antheridial groups is of secondary importance. The characters which distinguish the Anthocerotean sporogonium are more or less definitely correlated with the persistence of the basal meristematic tissue, and are connected with the nutrition of the spores. The maturing spore-tissue situated above the meristem is cut off from the mother-plant: hence supplies have to be manufactured by the sporogonium itself, and this latter is therefore elaborately equipped for a sub-independent life.

Amphigastrial Antheridia in some Ptilidioid Hepaticæ.†—V. Schiffner publishes the results of his investigations of amphigastrial antheridia and of the structure of the andrœcia of the Ptilidioideæ. He takes exception to Leitgeb's dictum that in the foliose Jungermanniæ the formation of antheridia is exclusively confined to the lateral segments; that it is always the dorsal half of the segment which forms the antheridia. Schiffner finds that:—1. In the Ptilidioideæ nearly all the species are diœcious (the exception being *Anthelia Juratzkana*). 2. The andrœcia of the group show great morphological variability, but in a given genus there is a certain uniformity which affords a good systematic character, a very important point in this group of rather ill-defined genera. 3. The andrœcia mostly occupy an intercalary position on the shoot, that is, typically the male branch bears at its base sterile leaf-organs and continues its apical growth vegetatively. 4. The perigonal leaves and amphigastria resemble the sterile leaves, but differ in the larger undivided limb and in the hollowed pocket in which the antheridia are sheltered. 5. In many species with filamentous leaf-segments protection against desiccation is provided by the hair-like felt which gathers moisture by capillary attraction; but even in such cases as *Trichocolea* and *Blepharostoma* the limb of the perigonal bracts is more strongly developed than in the sterile leaves.

* New Phytologist, ix. (1910) pp. 341-53.

† Hedwigia, l. (1911) pp. 146-62 (figs.).

6. With the protection of the antheridia is associated also the presence of paraphyllia in the axils of the antheridial bracts; the presence of paraphyllia is constant for a given species, and seems to be connected with a sub-xerophilous adaptation (*Chandonanthus*, *Mastigophora diclados*). 7. The perigonal amphigastria are always well developed, and are very similar to the sterile; they are strongly developed throughout some genera, somewhat reduced throughout others. 8. The number of antheridia in each perigonal bract is within certain limits constant in each genus. In some genera the antheridia are always solitary, viz. in *Anthelia*, *Lepicolea*, *Chætocollea*, *Lepilolæna*; in others they are either one or two, viz. in *Blepharostoma*, *Ptilidium*; and they are more than two in *Isotachis*, *Trichocolea*, *Chandonanthus*, *Mastigophora*, *Herberta*. 9. Amphigastrial antheridia are known to Schiffner in two genera only, *Herberta* and *Mastigophora*, and though rare occur probably in every species of those genera, thus affording a sound generic character. 10. The amphigastrial antheridia are in every way similar to ordinary antheridia. 11. The presence of amphigastrial antheridia is only possible in such genera as have very large unreduced perigonal bracts; and besides that, also in the axil of each perigonal bract a larger number of antheridia develop. They are therefore out of the question in all plants with solitary antheridia. 12. The plants with amphigastrial antheridia break through Leitgeb's rule, hitherto regarded as universal, that only the dorsal segments form antheridia. 13. *Herberta* and other genera show also clearly that not only the dorsally situated half of the dorsal segment, but also, in certain circumstances, the ventrally situated part has the power of forming antheridia—whereby also the second part of Leitgeb's dictum loses its universal validity. 14. *Senftnera filiformis* Schiff. is cleared up: it is *Blepharostoma quadripartitum* (Hook.) Steph. var. *filiforme* Schiff.; *B. quadripartitum* of the Dusén collection is *B. pilosum* Evans; *Lepicolea quadrilaciniata* Sull. belongs to the genus *Blepharostoma*.

Structure of *Riccia Bischoffii*.*—O. Juel gives an account of the anatomical structure of *Riccia Bischoffii* Hüben., collected near Upsala. In the middle of its thallus it has the normal structure of a *Eu-riccia*, that is, it has the usual vertical single rows or columns of assimilatory cells, each four surrounding a narrow vertical air-canal; the chloroplasts of the assimilatory cells are arranged in those portions of the cells which abut on the canals. In the wings of the thallus, however, the assimilatory tissue is peculiar in being modified; the air-canals are stretched out obliquely, and are each surrounded, not by four columns of cells, but by a cylindrical group of six to fifteen cells (as seen in horizontal section), and the surface appears reticulate. This wing-structure resembles that of the Australian *R. vesiculosa*, and is of importance as forming a transition from the structure of *Eu-riccia* to that of *Ricciella* with its wide air-chambers.

Critical Forms of *Aplozia*.†—V. Schiffner publishes notes on some critical forms of *Aplozia* of the very intricate group of the paroicous

* Svensk. Botanisk Tidskrift., iv. (1910) pp. 160-6 (1 pl. and figs.).

† Oesterr. Bot. Zeitschr., lx. (1910) pp. 451-5.

round-leaved species. He does not approve of K. Müller's recent treatment of the group in Rabenhorst's *Kryptogamenflora*, because it is incomplete and misleading as to some of the rarer and forgotten species. Schiffner has examined the type-specimens of these species, and now publishes his results. 1. *Jungermannia scalariformis* Nees was so badly described by Nees as to give the impression that the plant was dioicous and allied to *Aplozia cæspiticia*. Limpricht found it to be paroicous and regarded it as identical with *Jungermannia nana* Nees. Later Breidler separated *Aplozia lurida* from *A. nana*, and K. Müller gave to *A. lurida* the new binomial *Haplozia Breidleri*—and it is to this latter that *Jungermannia scalariformis* Nees is to be referred. But Schiffner shows that according to the rule of priority the name must be *Aplozia scalariformis*. The plant has nothing to do with *A. sphærocarpa*. 2. *Jungermannia tersa* Nees was endowed with three varieties by Nees. Schiffner has carefully examined all the material of the species in Nees' herbarium, and gives the corrected determination of each plant. As a result he condemns Nees' varieties as untenable. 3. *Jungermannia Goulardi* Husnot is in Schiffner's opinion to be regarded as *Aplozia nana* var. *Goulardi*. 4. *Jungermannia confertissima* Nees is shown by an examination of the original specimens to be *Aplozia nana* var. *confertissima*, and to differ from *A. nana* in having a very compact, closely felted, upright habit, with profuse long rhizoids and small close adpressed leaves. It is very near to the above-mentioned var. *Goulardi*.

Grimmia pilosissima.*—T. Herzog publishes a description and figures of *Grimmia pilosissima*, a new species gathered on rocks on the crest of Monte Gennargentu in Sardinia, at an altitude of nearly 6000 ft. It is distinguished at sight by its bright yellowish colour and its arachnoid system of long white hair-points.

Rare Species of Bryum.—E. Bauer † publishes notes on some of the more critical species recently issued in his *Exsiccati*, for instance *Bryum ammophilum* Ruthe, *B. arvernense* Donin, *B. cæspitium* var. *transiens* Podp., *B. oratum* Jur., *B. sagittifolium* Culm.

T. Suse ‡ gives a description of *Scorpiurium leskeoides*, a new species collected at Riva on the Garda See. It is a plant of the Mediterranean type, and was found in a protected situation.

J. Banngartner § states his views about the position of *Hypnum Schimperianum* Lorentz from its original locality, Windisch Matrei in Tyrol. He regards it as conspecific with the true *Hypnum molle* Dicks. and as distinct from *H. molle* var. *Schimperianum* of Juratzka's herbarium and of Schimper's Synopsis.

Figures of Hepatic Genera.||—C. Laconture, before his death, prepared for publication an illustrated synoptic key to all known genera of the Hepaticæ. These are now published. The Lejeuneæ were previously treated in the same way and were published in the *Revue Bryologique* in 1908.

* *Rev. Bryolog.*, xxxviii. (1911) pp. 12-13 (figs.).

† *Deutsche Botan. Monatschr.*, xxii. (1910), pp. 7-8.

‡ *Tom. cit.*, pp. 2-3.

§ *Tom. cit.* (1911) pp. 46-47.

|| Dijon: Libr. Venot, 1910, 46 pp. (pls.).

Species Hepaticarum.*—F. Stephani has published further instalments of his *Species Hepaticarum*, that is to say, he has provided new descriptions of the following genera and their species:—*Schistochila* (83), *Balantiopsis* (15), *Diplophyllum* (24), *Delavayella* (1), *Scapania* (78), *Rudula* (220), *Pleurozia* (10), *Mulotheca* (153), *Frullania*. The last named genus is unfinished, but its subgenus *Chonanthelia* contains 82 species, *Galeiloba* 230 species, and *Thiopsiella* 190 species. The sheets are issued as a supplement to the *Bulletin de l'Herbier Boissier* which became defunct at the end of 1909. Many of the species are described for the first time.

Bryological Index.†—E. G. Paris has published a supplement to his *Index Bryologicus*, in which he cites the moss-names employed by V. F. Brotherus in Engler's *Pflanzenfamilien* and gives cross-references to the synonyms in the *Index Bryologicus*—a convenience much needed by moss-students.

Illustrations of Exotic Mosses.‡—G. Roth has published two more parts of his *Die Aussereuropäischen Laubmoose*, in which he gives figures and new descriptions of exotic mosses. The first volume is to contain the *Andreaeaceae*, *Archidiaceae*, *Cleistocarpæ*, and *Trematodontæ*. Part I. contained *Andreaea* with 102 species. Parts II. and III. contain descriptions of 25 species of *Archidium*, 147 species of *Cleistocarpæ*, and a portion (17 species) of the *Trematodontæ*. The *Cleistocarpæ* are an artificial group, being the indehiscent members of several families brought together for convenience of treatment. The families concerned are as follows:—*Trematodontæ*, *Ditrichiæ*, *Trichostomeæ*, *Pottiæ*, *Voitiæ*, *Gigaspermeæ*, *Ephemereæ*, *Fumariæ*. Keys to the species are provided, and in many genera keys to the European species are also provided—a feature omitted by the author in his previous work, *Die Europäischen Laubmoose*.

New or Rare European Mosses.§—G. Roth publishes descriptions and figures of 22 new or rare European mosses which are additional to the species included in his *Europäischen Laubmoose* (1904–5). The plants treated belong to the following genera: *Tetraplodon*, *Splachnum*, *Pohlia*, and especially *Bryum* (sections *Ptychostomum*, *Hemisynapsium*, *Areodictyon*, *Eucladodium*, *Eubryum*); also *Philonotis* and *Timmia*. *Bryum splachnoides*, described and figured as a *Brachymerium* by Harvey in 1840 from a Himalayan specimen, has been recorded from Nepal and Yunnan; but its distribution was remarkably extended in 1906 by its discovery at Knossos in Crete by W. E. Nicholson.

British Mosses and Liverworts.||—T. H. Russell publishes a second edition of his *Introduction to the study of mosses and liverworts*. The first edition appeared in 1908. Some alterations are now

* Geneva, iv. (1909–10) pp. 65–528.

† *Collatio nominum Brotherianorum et Indicis Bryologici*, Paris: Baillière, 1911, 37 pp.

‡ Dresden: Heidrich, 1910–11, Band i. lief. 2–3, pp. 97–272 (pls. 9–24).

§ Hedwigia, l. (1910) pp. 163–80 (2 pls.)

|| London: Sampson Low, Marston & Co., 1910, new edit., xvi. and 211 pp. (11 pls.).

introduced, four new plates being added, and the terminology being somewhat improved. The book provides, in popular language, an account of the main facts of the life-history of the Bryophytes and of their various modes of reproduction. It treats of the collection, examination, and preservation of specimens, of the best sort of apparatus to use, and of the home-manufacture of apparatus. Explicit instructions for the preparation of Microscope slides are given, and also hints for the avoidance of the many pitfalls which beset the beginner.

Introduction to British Liverworts.*—Sir Edward and Agnes Fry have published a simplified account of the Hepaticæ. Beginning with a description of two typical forms, the thalloid *Pellia epiphylla* and the foliose *Diplophyllum albicans*, they pass on to consider the four groups, Riccieæ, Monocleæ, Anthocerotæ, Jungermanniæ, indicating the main points of their morphology and anatomy. They discuss the various modes of reproduction which prevail among the hepaticæ, giving two tables in which are displayed a number of British Jungermanniæ that are characterized by the possession of unicellular and of multicellular gemmæ respectively. The form of these gemmæ and their place of production on the plants are indicated. The concluding chapters are concerned with odour, water supply, alternation of generations, classification, distribution.

British Mosses.—W. Ingham † reports on the work done by the bryological section of the Yorkshire Naturalists' Union during 1910 and records the discovery of some score of interesting species or varieties of mosses and hepatics in divers localities by sundry collectors.

E. A. Richards ‡ records the finding of *Campylopus flexuosus* var. *paradoxus* at Helsby Hill in Cheshire. Strictly speaking, the plant is intermediate between *C. flexuosus* and the var. *paradoxus*, showing that the latter has rightly been reduced from specific rank.

E. Armitage § publishes a note on some mosses which are new records for the counties of Westmorland and Ayr. They were gathered in Mardale and Riggindale in the former county, and at Craig Lure and Balbeg in Ayrshire.

New Scottish Mosses.||—J. Stirton publishes descriptions of the following six new species: two of them collected on Ben Lawers in 1855, *Timmia scotica*, *Climacium epigæum*; two found near Fort William in 1908, *Orthotrichum prasinellum* and *O. prænubilum*; and two from Arisaig, *Plagiothecium rufovirescens* and *Hypnum deflectens*. The *Climacium* has close affinities to *C. americanum*, and leads to the question why should plants, which are found on the higher altitudes of Ben Lawers and scarcely anywhere else in Great Britain, show such close relationships to those occurring near the eastern shores of the more northern parts of North America—as, for instance, *Mollia fragilis* (Drum.), *Hypnum hispidulum* (Brid.), *Climacium epigæum*, and several lichens.

* The Liverworts, British and Foreign. London: Witherby & Co. 1911, viii+ and 74 pp. (49 figs.).

† Naturalist, No. 648 (1911) pp. 60-1.

‡ Lancashire Naturalist, iii. (1910) p. 177.

§ Journ. of Bot., xlix. (1911) p. 36.

|| Ann. Scot. Nat. Hist., No. 76 (1910) pp. 238-44.

Mosses of the Haute-Saône.*—A. Coppey publishes another instalment of his paper on a phytogeographic study of the mosses of the Haute-Saône, giving the distribution of the species of Dicranaceæ, of *Fissidens*, *Hymenostomum*, etc., with remarks interspersed here and there.

Hungarian Bryophytes.—V. Schiffner † publishes a list of thirty-three hepaticæ collected by I. Györfly in Hungary, and especially in the Hohen-Tátra. A previous list appeared in 1909 in the same periodical.

M. Péterfi ‡ publishes some critical notes on Hungarian mosses collected in the south-eastern part of the kingdom. He writes at considerable length about *Philonotis alpica*.

I. Györfly § gives an account of the morphology, anatomy, and ecology of *Molendoa tenuinervis* Limpr., a rare Alpine moss recently found on the Hohen-Tátra.

I. Györfly || records the discovery of *Orthotrichum perforatum* Limpr., and of *Dicranum groenlandicum* Brid. in the Hohen-Tátra. They are both additions to the Hungarian flora, and are very rare in Europe. He also calls attention to the occurrence of polycarpophory (two sporogonia in one perichaetium) in *Dialytrichia Brebissoni* Limpr.

South Russian Mosses.¶—A. A. Sapehin publishes a list of forty-six species of mosses collected in the Governments of Cherson, Taurida, and Bessarabia by J. K. Paczosky. An interesting record is the presence of *Sphagnum squarrosum* in a forest lake near Snamenka on the South Russian Railway.

Northern Mosses.—H. W. Arnell and C. Jensen ** have prepared a catalogue of the mosses gathered on the Sarek Mountains in Swedish Lapland by A. Hamberg's Expedition. They describe and figure as new two species and three varieties, and also figure other interesting species, and add a chapter on the vegetation of mosses, their frequency, habits, etc.

V. F. Brotherus †† gives an account of the mosses of the Arctic coastlands of Siberia, gathered by the Russian North Pole Expedition (1900-3). He enumerates 45 mosses, 3 sphagna and 9 hepatics, and describes and figures a new species of *Bryum*.

Thallophyta.

Algæ.

(By MRS. E. S. GEPP.)

Japanese Marine Algæ.††—K. Okamura issues two further parts of his *Icones of Japanese Algæ*, in one of which he figures *Champia parvula*, *Constantinea rosa-marina*, *Dasyopsis plumosa*, *Camplæphora*

* Rev. Bryolog., xxxviii. (1911) pp. 13-19.

† Magyar Bot. Lapok., ix. (1909) pp. 313-20. ‡ Tom. cit., pp. 320-33.

§ Tom. cit., pp. 360-374 (2 pls.). See also Rev. Bryolog., xxxviii. (1911) pp. 20-21. || Op. cit., x. (1910) pp. 83-5.

¶ Bull. Jard. Impér. Bot. St. Pétersbourg, x. (1910) pp. 186-91.

** Naturw. Unters. Sarekgeb. in Schwed. Lapland, iii. lief. 3 (1910) pp. 133-268 (figs.). †† Acad. Impér. Sci. St. Pétersbourg (1910) 15 pp. (fig.).

‡‡ *Icones of Japanese Algæ*. II. Nos. 6, 7 (1910) pls. 76-85.

hymæoides, *Cladophora rugulosa*, and *Microdictyon pseudolapteron*. The second of the two parts includes figures of a new species, *Botryocarpa japonica* Okam., as well as of *Delesseria fimbriata* De la Pyl., *D. Müllendorffii* Rup., and *Chordaria abietina* Rup. The figures are as usual of the very best.

Marine Algæ from the Kermadecs.*—A. and E. S. Gepp publish a short list of marine algæ from the Kermadec Islands, collected by R. B. Oliver in 1908. The list includes thirty-seven species and represents the first published record of algæ from the islands. None of the species are described as new, though possibly one may prove to be so, when more is known of the genus to which it belongs, *Galaxaura*. A new combination is made, *Cystophora elongata* Dickie being placed in *Carpophyllum*, with a short explanatory note. *C. elongatum* was not among the collection from Oliver, but it had been previously recorded from the ocean thirty miles off the Kermadecs by the 'Challenger' Expedition. In some short introductory remarks, quotations are made from Oliver's own report on the Vegetation of the Kermadecs. †

Algæ of the Sheffield District.‡—M. H. Stiles gives a list of the Algæ and Diatomaceæ of that portion of the West Riding of Yorkshire which extends from Sheffield to Thorne, with Doncaster as the natural centre. The list comprises about 100 species, and is followed by short notes on various localities in the district.

Algæ and their Study.§—This is the title of a popular lecture given by F. L. M'Keever in Edinburgh, in which a short sketch is given of the general outlines of classification of algæ, followed by a list of forty-one fresh-water species found by the author in Midlothian. The most interesting of these is *Desmonema Wrangelli* B. & F., which is described by West as being one of the rarest blue-green algæ in the European flora.

Algæ of the Elf Loch.||—F. L. M'Keever enumerates seven new records of algæ from the Elf Loch, the flora of which had been already published.

African Fresh-water Algæ.¶—E. Lemmermann gives a list of the fresh-water algæ collected during the German Expedition to Central Africa in 1907-8. The collection includes eighty-one species, of which two are new, *Phormidium africanum*, and *Peridinium bidens*, as well as two new varieties of known species. The localities were Mohasi Lake, Ruanda, Kiwu Lake, and Rugege forest.

Algal Flora of the Missouri Botanical Garden.**—A. Hayden writes a report on the algæ found in the pools, ponds, and streams of the

* Journ. of Bot., xlix. (1910) pp. 17-23.

† Trans. New Zealand Inst., xlii. (1909) pp. 118-75.

‡ Handbook and Guide of the British Association, Sheffield, 1910, pp. 443-7.

§ Trans. Edinburgh Field Nat. and Micr. Soc., 1909-10, pp. 232-41.

|| Tom. cit., pp. 242.

¶ Wiss. Ergebnis. Deutsch. Zentral-Africa Exped., 1907-8. II. Bot. (1911) pp. 89-94.

** Missouri Botanical Garden. Annual Report, xxi. (1910) pp. 25-48 (figs.).

Missouri Botanical Garden. After a discussion of the habitats, stability of habitat characters, and analysis of habitats, she gives a systematic enumeration of the 116 species recorded, together with some critical notes. One species, *Pithophora Mooreana* Collins, is new. The paper is illustrated by good photographs of the various habitats in the garden.

Analysis of Seaweeds.*—W. H. Barlow has drawn up some analytical results made by him on dry plants of *Fucus serratus*, *F. vesiculosus*, and *Ascophyllum nodosum*, collected at Padstow. In the case of *F. serratus* the phosphoric acid was considerably higher than that found in a Thanet specimen previously reported on by other investigators. The total alkalis in the three species examined were found to be nearly uniform.

Saprophytism of Enteromorpha.†—E. Häyren writes on the saprophytism of certain species of *Enteromorpha*. He has examined species in the harbour of Helsingfors, and finds that *E. clathrata* and certain forms of *E. intestinalis* may be regarded as "oligosaprob," while *E. flexuosa*, *E. crinita*, and certain other forms of *E. intestinalis*, are weakly "mesosaprob." The presence of *Enteromorpha* in brackish or salt water leads to the inference that the water is foul, an inference which is strengthened by the fact that A. Steuer finds *Enteromorpha* growing near the entrance of sewers. The author further discusses other "saprob" species in the harbour of Helsingfors, which have been found there by Bergmann and Klingstedt.

Periodicity in Spirogyra.‡—C. H. Danforth writes on the periodicity of *Spirogyra*, with special reference to the work of Benecke. After a short introduction dealing with previous work on periodicity in algæ, he gives an account of his own experiments, comparing them with those of Benecke. That author worked with *Spirogyra communis*, and the experiments of Danforth were made with *S. setiformis*, *S. longata*, *S. Grevilleana*, *S. dubia*, and *S. porticalis*. The result has been almost a complete lack of conformity in so far as the question of zygospore formation is concerned. After describing in detail the experiments carried out, the author summarizes his results as follows: It appears that there are specific differences as regards the reactions of filaments and zygospores in the species studied, and that Benecke's conclusions, based on the reactions of *S. communis*, are probably not of general application, or are applicable only under very special conditions. Of the five species investigated three failed entirely to give the expected results, and a fourth failed in every case but one. The remaining species, *S. Grevilleana*, seems to agree more closely with *S. communis*, but even here the agreement is not complete. The existence of sexual strains, such as occur in some of the moulds, seems to be suggested, but evidence on this point is lacking. It is still possible that *Spirogyra*, like *Dictyota*, is inherently periodic in its functions, although its periodicity may be extensively influenced by the environment.

* Journ. Board of Agric., xvii. (1911) p. 832.

† Meddel. Soc. Fauna et Flora Fennica, xxvi. (1909-10) pp. 157-61; and Hedwigia, Beibl. 1. (1910) p. (150).

‡ Missouri Botanical Garden. Annual Report, xxi. (1910) pp. 49-59.

Navicula rhomboides.*—E. M. Nelson discusses the old question of *Navicula rhomboides* and the Amician test, and points out the differences between the diatoms regarded as *N. rhomboides* in England and America respectively. Two other varieties of the species are discussed. The author suggests that the minute variations of the various forms might be expressed in numbers, and the numerical index of each would be a great aid to identification and comparison. The economic value of Diatoms is alluded to, and the fact that they form the food of Copepods which in turn are devoured by fish.

Desmidiaceæ of Bohemia.†—J. Lütkenmüller gives a list of about 280 species of Desmids found in Bohemia, including new species and varieties. Remarks are made on *Penium* and *Roya*. Some of the species of *Penium* are here placed under *Cosmarium* as being more closely allied with that genus. *Roya* has hitherto been considered as belonging to Closterieæ, on the strength of the shape of its cells, since details as to the cell-membrane and cell-division were wanting. Lütkenmüller has, however, been able to procure material, and to make the following observations: 1. The cell-membrane is hyaline, slightly refractive and entirely without structure; under the highest magnification, neither in stained nor unstained preparations is any segmentation to be observed, and it is also free of pores. 2. Cupric ammonium hydrate causes an immediate fading of the cell-membrane, which becomes flaccid and in a few minutes dissolves away. 3. During cell-division a transverse wall is formed which takes its origin solely from the membrane of the mother-cell; there is no previous separation of the halves of the cell-membrane, nor any intercalation of a newly formed membranous ring. After the splitting of the dividing wall into two sheets, there follows speedily the separation of the daughter-cells, when the young halves of the cell have hardly taken on a hemispherical form. Even at this stage it is impossible to demonstrate a dividing line between the young and the old halves. It is thus to be seen that the genus *Roya* must be transferred from the Closterieæ, and placed with the Saccoderm Desmidiaceæ in the tribe Spirotænicæ. The nearest ally to *Roya* is *Mesotænium* Naeg. As regards the pores in the cell-membrane of *Closterium*, the author has re-examined species which he had previously declared to be without pores, and also a series of the smallest species in the tribe Cosmarieæ, and he finds that every one of them possesses pores. He believes now that there are no species of Cosmarieæ without pores.

New African Species of Volvox.‡—G. S. West describes two new species of *Volvox* collected respectively in Rhodesia and from the Albert Nyanza. Two species are also recorded from Australia, one of which, though probably new, cannot be described for want of adequate material. The author gives some interesting notes on the two European species, *V. globator* and *V. aureus*, and contrasts the respective characters of each species in tabular form.

* Journ. Quekett Micr. Club, ser. 2, xi. (1910), pp. 93-8.

† Verh. k. Zool.-Bot. Ges. Wien, lx. (1910) pp. 478-503 (2 pls., figs. in text).

‡ Journ. Quekett Micr. Club, ser. 2, xi. (1910) pp. 99-104 (1 pl.).

Phæothamnion confervicolum.*—F. L. M'Keever records this alga for the first time in the British Isles. He found it among algæ collected from the Elf Loch on the Braid Hills, Edinburgh, growing on *Lemma minor* and other aquatic Phanerogams.

Myxophyceæ.†—J. E. Tilden publishes a book in which she brings together the specific descriptions of all the blue-green algæ so far known to exist in North America and the adjacent regions (including the Arctic regions, Alaska, Greenland, Canada, Newfoundland, Labrador, the United States, Lower California, Mexico, Central America, the Bermudas, the Bahamas, the West Indies, and the Hawaiian Islands). Simple keys are furnished for the families, genera and species, and many of the species are figured. Specimens from exsiccatae are quoted and localities given. Finally there is a glossary and a list of hosts and associates.

Symbiotic Alga.—J. Horejsi has investigated the alga which grows in the dichotomous branches of the roots of *Cycas revoluta*, *Anabæna cycadeorum* Reinke. According to the author, the alga is the cause of the abnormal dichotomous growths of certain roots. It shows a regular annual periodicity, the symbiosis lasting from the beginning of autumn to the end of spring. The alga enters through the lenticels of the roots and penetrates into the meristematic apical tissue, stops further growth and causes dichotomy to take place. Only the vegetative apices are free from the alga, which is strongly heliotropic and belongs probably to *Anabæna*. A detailed description is given of the alga and its life-history. The author considers that the alga probably takes up a certain amount of the products of assimilation from the host and that the roots in return take from the alga their products of nitrification. The alga is able to maintain, and even to form, its chlorophyll in very feeble light. The author has succeeded in cultivating the alga in soil extract, in alkaline fluid, and in agar.

LOEW, O. **Über die Wirkung von Strontiumsalzen auf Algen.** (On the effect of strontium salts on algæ.) *Flora, neue Folge*, cii. (1911) pp. 96–112.

Fungi.

(By A. LORRAIN SMITH, F.L.S.)

Research on Cladochytriaceæ.‡—René Maire and Adrien Tison followed the development of *Urophlyctis hemisphærica* on *Carum incrassatum*, and describe it fully. The point where the cell of the host has been infected by a zoospore remains in contact with the exterior; a small vesicle is formed in the cell which buds and forms other vesicles; the final terminal vesicle becomes the chronisporocyst. The authors noted no case of nuclear fusion; the reproduction is entirely asexual. They found the same course of development in *Physoderma Gerhartii* on *Glyceria fluitans*. The three genera *Urophlyctis*, *Physoderma*, and *Cladochytrium*, form, they find, a homogeneous group with asexual reproduction by the formation of chronisporocysts.

* *Ann. Scot. Nat. Hist.*, No. 77 (1911) pp. 57–8.

† *Minnesota Algæ*, vol. i. Report of the Survey Bot., ser. 8 (1910) iv. and 328 pp. (20 pls.)

‡ *Bull. Int. Acad. Sci. Bohême* (1910) 10 pp. (24 figs.).

§ *Comptes Rendus*, clii. (1911) pp. 106–7.

Biology of Sclerospora.*—Two species of this genus, *Sclerospora graminicola* on *Setaria viridis* and *Sclerospora macrospora* on a number of grasses and cereals, are very prevalent in the valley of the Po, where they have been collected by Vittorio Peglion, the author of the paper. He notes that the spores of the first species are not congregated, but lie in loose masses between the fibro-vascular bundles and the outer cortex; they are thus easily scattered by the wind. *S. macrospora* has also a wide distribution, but it occurs somewhat rarely. The oospores are congregated and less liable to be dispersed. No conidia have been observed in the genus. The primary effect of the fungus on the host-plant is to increase the vegetative development, and the plants attacked have a brighter green colour than the normal plants. The relation between host and parasite is thus of a somewhat mutualistic nature at the beginning. When seed-time arrives the damage done by the parasite becomes more apparent; the seeds are deformed and incapable of germination. Cattle eat the grasses infected with *Sclerospora* very readily and without any bad results. Figures are given of deformed ears of cereals and of the abnormally developed leaves of *Glyceria festucæformis*, a witches'-broom being formed by the parasite.

Notes on Saprolegnia.†—A. E. Lechmere claims to have produced on one and the same pure culture of *Saprolegnia* the non-sexual types of fructification of a series of closely related genera. Lechmere describes his cultures and the different growths.

Fungus of House-fly.‡—G. Gordon Hewitt discusses this fungus, *Empusa Muscæ*, along with the parasites that attack *Musca domestica* in his paper on the structure, development and bionomics of the House-fly. A large proportion of the flies that have survived till the autumn are killed off by this fungus, of which the sporophores bud off and ejaculate terminal conidia; these conidia alight on another insect, penetrate the body and produce mycelium with further conidia. Resting spores that would carry the fungus over the winter have been described, but some doubt still exists as to their occurrence.

Ascocarp of Leotia.§—William H. Brown has made a microscopical study of the ascocarp of *L. lubrica* and *L. chlorocephala*, more especially of the ascus-formation. In the youngest specimen of *L. lubrica* that the writer found, the supposed ascogonium—a large cell of which the contents were vacuolated and degenerated—gave rise to a number of large hyphæ which extended upwards towards the tip of the ascocarp. At the tips of these ascogonous hyphæ, asci are formed in several different ways. In some cases a typical hook is formed in which the two nuclei of the penultimate cell may fuse to form the nucleus of an ascus, or they may divide and give rise to the nuclei of another hook. The terminal cell grows down and fuses with the antepenultimate cell, and the fused cell may form an ascus or give rise to still another hook. Other hook formations are also described.

* Centrabl. Bakt., xxviii. (1910) pp. 580-9 (6 figs.).

† New Phytologist, ix. (1910) pp. 305-19 (2 pls.).

‡ Quart. Journ. Micr. Sci., liv. (1910) pp. 371-4 (pl. 22 and figs. 15-17).

§ Bot. Gaz., l. (1910) pp. 443-59 (47 figs.).

Brown considers that there is no evidence of any fusion of nuclei in the ascogonium. The nuclei of the ascogenous hyphæ probably arise from a single nucleus with the haploid number of chromosomes, and their relationship to each other is therefore of no significance. The vegetative hyphæ form large storage cells in the hymenium; the nuclei in these cells frequently fuse to form a single large nucleus.

The development of the ascocarp indicates that all of its structures are homologous with those of the Pezizineæ, and that *Leotia* is closely related to that group.

Uredineæ.—P. and H. Sydow* have issued the section of their monograph dealing with the genus *Uromyces*. They give a short historical sketch of *Uromyces*, and a general description of its occurrence and development. It is like *Puccinia* except in the teleutospore stage, the spores being only one-celled and possessing one apical germinating pore. Many of the species live on one host, others alternate on different hosts. The authors include in *Uromyces* the genera *Trachyspora* and *Pileolaria*, and they reject the numerous genera established by Arthur, based as they often are on our as yet imperfect knowledge of the different life stages of the species.

Laszlo Hollos† publishes a list of 171 species of Uredineæ from Hungary, some of them very rare forms, and most of them new for that region.

F. Zach‡ describes researches he has made on the relation between host and parasite in the Uredineæ. He demonstrated phagocytose bodies in the cells invaded by the parasite both in root and leaf. These bodies are larger or smaller, the latter are Eriksson's Plasmanukleolen. In many cases there seems to be a symbiotic relationship between host and parasite, the host being uninjured by the presence of the fungus. Finally, he concludes that new outbreaks of rust are due to spore-infection.

F. C. Arthur§ describes a number of new species of Uredineæ from various regions of the United States. They belong to the genera *Puccinia*, *Uromyces*, *Uropyxis*, *Uredo*, *Peridermium*, and *Æcidium*. Many of them were collected in the preparation of the North American flora.

Y. Orishimo|| has established a genetic connexion between *Coleosporium* on *Aster scaber* and *Peridermium Pini-densifloræ* by means of infection experiments; both forms are now included under *Coleosporium Pini-Asteris*. The author gives a list of *Coleosporium* species in Japan.

Study of Smut-infection.¶—Fr. Honecamp and H. Zimmermann have tested smut spores that had passed through the bodies of various animals. It has been generally held that feeding animals with smutted

* Monographia Uredinarum, II. 2 (Leipzig, 1910) xix. and 396 pp. (9 pls.).

† Magyar Bot. Közlem., ix. 2 (Budapest, 1910) pp. 161-9. See also Hedwigia, l. (1910) Beibl., p. 164.

‡ SB. k. Akad. Wiss. Wien, Math.-Nat. Kl., cxix. (1910) pp. 307-30. See also Bot. Centralbl., cxvi. (1911) pp. 17-18.

§ Bull. Torrey Bot. Club, xxxvii. (1910) pp. 569-80.

|| Bot. Mag. Tokyo, xxiv. (1910) pp. 1-5. See also Bot. Centralbl., cxvi. (1911), pp. 94-5.

¶ Centralbl. Bakt., xxviii. (1910) pp. 590-607.

corn and then using their dung for manure is responsible for spreading the smut fungus. The authors find that the spores are mostly killed, only a negligible number remain capable of germination. The most serious danger arises from infected seed, and that can be met by soaking the seeds in some fungicide. Smut spores survive two years; they only germinate in suitable conditions of moisture.

Culture of an Edible Fungus.*—L. Matruchot succeeded in developing *Pleurotus cornucopioides*, a lignicolous agaric, on artificial cultures in the laboratory. He also took sections of an elm tree invaded by the same fungus and buried them in soil which he kept moist. Each piece of wood furnished two or more harvests of *Pleurotus*. The author emphasizes the economic importance of these methods of obtaining relays of fresh fungi.

Poisonous Mushrooms.—W. A. Murrill † has written a paper on the noxious forms of fungi in America. The two deadly Agarics there, as in Europe, are *Amanita muscaria* and *A. phalloides*. The poisons in both these fungi are alkaloids. Murrill reckons that the deaths due to mistaking poisonous species for edible ones are probably fifty or more each year in the United States; many of the cases are not reported. A list of species is given with notes as to poisons.

Gillot ‡ records several cases, due presumably to eating *Amanita phalloides*, as the fungi had been gathered in a wood where this species was very abundant. Gillot insists on the importance of botanical characters in determining fungi, and warns people against trusting to the "silver test" or to the presence of slugs. He also insists on the necessity of eating fungi in a fresh condition.

Gallois § also records a fatal case of poisoning due to eating fungi, though it was impossible to find out which species had been taken. The symptoms and course of the attack are described.

Notes on the Larger Fungi.||—A. Lingelsheim calls attention to a specimen of the *Rhizomorpha* of *Armillaria mellea* on maple roots which had pushed back the woody tissues and forced its way for about a metre between the wood and the cork; the cells of the periderm were entirely uninjured. In another case the wood had been penetrated and the *Rhizomorpha* showed on cross-section an irregular black ring.

New Species of Bresadolia.¶—P. Magnus has had submitted to him a fungus collected by Mikita Schaposchikoff on roots of beech in North Caucasus and named by N. Schestunoff of Riga, *Bresadolia caucasica*. Magnus does not dispute its affinity to other species of the genus, but he holds that it is none the less only a monstrous form of *Polyporus squamosus*. It differs from the latter only in the form of the pores, which are intricately lamelliform.

* Comptes Rendus, cli. (1910) pp. 1776-7.

† Mycologia, ii. (1910) pp. 255-64 (2 figs.).

‡ Bull. Soc. Mycol. France, xxvi. (1910) pp. 408-14.

§ Tom. cit., pp. 415-18.

|| Jabresb. Schles. Ges. Zool.-bot. Sekt., lxxxvii. (1909) pp. 34-5.

¶ Hedwigia, l. (1910) pp. 100-4 (1 pl.).

Wood-destroying Fungi.*—Josef Schorstein publishes notes on the fungi that are found on roofs. He states that the occurrence of white strings or cushions of white colour on infected wood indicates the presence of *Poria Vaillantii* or *Polyporus vaporarius*. If soft, like kid leather, the mycelial strands belong to the first-named; if brittle, they belong to the latter. Schorstein has found that *Coniophora cerebella* and *Parillius pannuoides* only occur in cellars. *Polyporus destructor* quickly forms fruiting bodies, and never entirely destroys the wood. Membranaceous coatings point to *Merulius lacrymans* or *M. pulverulentus*. The former makes its appearance soon after the wood is built into position. If cultures prove that the mycelium is living, the wood should be entirely destroyed. Mouldy wood is quite safe, as moulds never penetrate into the wood tissues.

Notes on Geaster.†—J. Rick accepts the work of C. G. Lloyd on this genus. He is inclined to replace species by types, the latter more truly representing the grouping of forms. Rick enumerates the characters that are of systematic value: the form of the "mouth" and columella, and the consistency of the peridium; and he compares the different species, marking the points of difference or resemblance.

Dictyophora and Ithyphallus.‡—G. F. Atkinson has made a comparative study of these genera, with special reference to the development and importance of the veil, and a comparison is made with *Phallus Ravenelii*, in which a true indusium, so conspicuous in *Dictyophora*, is wanting. In *Ithyphallus* there is a rudimentary indusium only, but Atkinson considers that *I. impudicus* and *Phallus Ravenelii* belong to one genus.

Mycogeography.§—F. Theissen comments on Schröter's statement that, for fungi, there is a geographical distribution, as there is for Phanerogams. So far, the experience of mycologists does not support this view, though, as Theissen remarks, much more detailed work is still necessary, and the work of earlier mycologists needs thorough revision. A list is made of *Xylariæ* from Brazil, which shows how wide the distribution is for these fungi; but, he concludes, much examination of existing material must be undertaken before we can attempt accurate geographical distribution lists.

Fungus Root-tubercles.||—E. G. Arzberger has studied the fungus that causes root-tubercles in *Ceanothus*, *Eleagnus*, and *Myrica*. In the two former the fungus is placed in the genus *Frankia*; infection takes place by root-hairs near the tip, and as the fungus develops the host-cells become hypertrophied, the fungus secretes an enzyme that destroys the cell-walls, and the nucleus increases in volume. The fungus forms sporangia from which probably the spores escape, but the fungus itself is finally absorbed by the host. Symbiosis exists, which is quite apparent

* Oesterr. Forst. Jagdzeit., xxviii. No. 31 (1910) pp. 231-2. See also Hedwigia, l. (1910) Beibl., p. 119.

† Beih. Bot. Centralbl., xxvii. (1910) pp. 375-83.

‡ Bot. Gaz., li. (1911) pp. 1-20 (7 pls. and 1 fig.).

§ Beih. Bot. Centralbl., xxvii. (1910) pp. 359-74.

|| Rept. Missouri Bot. Garden, xxi. (1910) pp. 60-102 (9 pls.).

in the early stages. In *Eleagnus* there are several differences in the developments noted. In *Myrica* it has been determined as a species of *Actinomyces*; it is confined to one or two layers of cells, and is to be regarded as a parasite.

Origin of Parasitism in Fungi.*—G. Masee discusses this question at some length, giving results of experiments with various forms. He holds that fungi normally saprophytic may be educated to prey on living tissues. He took spores of the saprophytic mould *Trichothecium roseum* along with some of the culture medium and injected them into an orchid leaf, wounding the leaf to allow the egress of the fungus. It grew, and the spores produced were sown in a similar way. Finally, after several generations, they were sown with distilled water only on the orchid leaf, when they germinated and pierced the leaf, living as true parasites on the living tissue. The author holds that the earliest fungi were aquatic, and that "the great wave of parasitism set in when the fungi commenced to adapt themselves to dry land conditions."

Plant-diseases in Russia.†—Helene v. Diakonoff communicates the substance of a Russian paper on this subject in A. v. Jaczewski's Year-book of Fungal Diseases in Cultivated Plants. On cereals the most important is *Tilletia Tritici*, causing smut in wheat. *Cladosporium herbarum* is also reckoned a very serious disease of the grains. Among Uredineæ *Puccinia triticina* is the most widespread. *Urocystis occulta* and *Claviceps purpurea* attacked the rye plants; other less important moulds are also listed. Maize was attacked by *Ustilago Maydis*, and potato plants by *Phytophthora infestans*; finger-and-toe was recorded as destroying cabbages in several districts. Tobacco suffered from *Pythium de Baryanum* and hops from *Sphærotheca*. The diseases of orchard and garden are also passed in review, and a careful account of fungicides is supplied.

Diseases of Plants.—Griffon and Maublanc‡ publish some notes and observations on the black stain disease of chestnuts which attacks the trunks and branches. Briosi and Farnetti had diagnosed the disease as due to a parasitic fungus, *Melanconis perniciosa* and its conidial form *Coryneum*. Griffon and Maublanc have also found these fungi, and recognize the former as a synonym of *Melanconis modonia*. They are not convinced that the disease is caused by them, and they suggest that it may be due to some disturbance of the *Mycorrhiza* of the roots.

T. G. B. Osborn§ gives a somewhat popular account of potato scab. He describes the harmless superficial scabbing caused by abrasion of the surface, often found in potatoes, grown on ash or rough soil; he then describes more particularly corky scab, which is caused by *Spongospora subterranea*. It does great damage to the crops, and has been especially prevalent in Ireland. Black scab, due to *Chrysophlyctis endobiotica*, is also described by the author.

* Naturalist (1910) pp. 289-92.

† Zeitschr. Pflanzenkr., xx. (1910) pp. 460-73.

‡ Comptes Rendus, cli. (1910) pp. 1149-51. See also Bull. Soc. Mycol. France, xxvi. (1910) pp. 371-81 (3 pls.).

§ Manchester Micr. Soc. (1910) pp. 61-9.

Ernesto Marchand* communicates a note on new attacks of *Plasmiodiophora Brassicæ*, the destructive parasite of plants belonging to the Cruciferae. Marchand has found it deforming and destroying the roots of melons, parsley, etc. He remarks that the plants grown in forced conditions suffer most from the parasite, the excessive humidity and high temperature being favourable to its growth.

A leaflet † has been issued by the Board of Agriculture and Fisheries dealing with a disease of strawberry leaves due to *Sphærella Fragariæ*. It causes brown spots on the leaves, the centre of each becoming greyish white, and is seen to be studded first with the tufts of *Ramularia*, and later with the perithecia of *Sphærella*. The leaves should be mown after the fruit is gathered, and then burnt. This does not injure the strawberry plants.

Stoykowitch and Brocq-Roussou ‡ have studied the effect of fungi on plums: they find a white deformation caused by *Torula* moulds; a red caused by *Monilia*, and others due to various moulds, such as *Aspergillus*, *Penicillium*, and *Rhizopus*. In the presence of these moulds the sugars diminish, while nitrogen increases.

G. Arnaud§ describes a fungus *Trabutia quercina* parasitic on oaks. It was previously confined to *Quercus Ilex*, but is now found on *Q. coccifera*. The perithecia grow on stromata on the under surface of the leaves; the pycnidial form was also found and described; the mycelium develops a crust under the cuticle from which suckers grow out between the cells of the palisade tissue.

J. Vanha || has studied the "leaf-rolling" disease of potatoes, one of the chief causes of which he finds is an Ascomycete *Solanella rosea* g. et sp. n. The details given are somewhat incomplete.

The scientific committee of the Royal Horticultural Society ¶ report on bitter-rot of pears caused by the fungus *Glaosporium fructigenum*. The disease begins as small rounded brown patches on the outside. These may develop and give a bitter taste to the whole fruit. Diseased fruits should be destroyed.

T. Brooks** has contributed a paper dealing generally with the subject of plant-diseases. He points out how necessary it is to understand the life-history of the fungus causing the disease in order to control or to exterminate it, and he strongly advises the cultivation of immune plants. He also touches on the question of diseases due to bacteria—the first authenticated case was discovered by Burrill in 1878, who found blight of pear trees was due to a species of Bacterium. Notes are added on the different text-books of plant-diseases recently published.

G. Lindau †† writes on the spread of parasitic fungi causing disease

* La Viticultura Argentina, i. (1910) pp. 289-90.

† Leaflet No. 243, 2 pp. (1 fig.).

‡ Rev. Gén. Bot., xxii. (1910) pp. 70-9. See also Bot. Centralbl., cxvi. (1911) p. 17.

§ Ann. Nat. Agric. Montpellier, ser. 2, ix. (1910) pp. 278-87 (1 pl.). See also Bot. Centralbl., cxvi. (1911) pp. 14-15.

|| Monatsh. Landwirtschaft, iii. (1910) p. 268. See also Bot. Centralbl., cxvi. (1911) pp. 18-19. ¶ Journ. Roy. Hort. Soc., xxxv. (1910) p. cexxxi.

** New Phytologist, ix. (1910) pp. 374-9.

†† Nat.-wiss. Wochenschr., xl. (1910) pp. 625-9. See also Hedwigia, l. (1910) Beibl., pp. 161-2.

of plants. He ascribes the widespread epidemics to the action of the wind which scatters the light spores. Following that, the fungus requires for growth a period of moisture and a still atmosphere. In Hungary it was found that an *Oidium* year on the vine was preceded by south-west and south winds with low temperature. *Peronospora* was more prevalent in the absence of these conditions.

E. J. Butler has studied * the wilt disease of pigeon-pea. He found on the roots perithecia of *Neo-cosmospora vasinfecta*, but they were purely saprophytic on wilted plants. The disease is due to a *Fusarium* of which the perfect fruits have not yet been found.

F. C. von Faber † records a disease of coffee plants which is caused by a fungus *Ascospora Coffeæ* sp. n. It causes the leaves to wither and fall off. By cultures he found the pycnidial and perithecial stages of the fungus.

Perley Spaulding ‡ describes a number of cases in a greenhouse where plants were damaged by *Botrytis vulgaris*. On *Chrysanthemum* plants it attacked the petals at the tips, which soon died down to the base. The disease spread very rapidly on any and all of the flowers. Other attacks in the following years occurred. Two years after the first appearance, *Poinsettia* leaves were destroyed, and finally a number of plants of *Primula*. The lower leaves, which lay flat on the ground, were infected and finally killed by the fungus. There has been little or no previous mention of disease caused by *Botrytis* in the United States.

ARNAUD, G.—**Contribution à l'Etude des Fumagines.** (Contribution to the study of Fumagines.)

[By "Fumagines" the author understands fungi belonging to the life-cycle of Sphæriaceæ.]

Ann. Éc. Nat. Agric. Montp., ser. 2, ix. (1910) pp. 239-77 (3 pls.).
See also *Bot. Centralbl.*, cxvi. (1911) p. 14.

BERTRAND, GABRIEL, & M. JAVILLIER—**Influence du Manganèse sur le Développement de l'*Aspergillus niger*.** (Influence of manganese on the development of *Aspergillus niger*.)

[Description of cultural experiments.]

Comptes Rendus, clii. (1911) pp. 225-8.

BUCHANAN, R. E.—**A New Species of *Thyrococcum*.**

[The species *T. humicola* was isolated from humus and cultivated on agar plates.]

Mycologia, iii. (1911) pp. 1-4 (2 pls.).

GARRETT, A. O.—**Smuts and Rusts of Utah.**

[Ustilaginæ and Uredinæ collected by the author, the results of eight years of field-work. 142 specimens.]

Mycologia, ii. (1910) pp. 265-304.

GUÉGUEN, FERNAND—**Sur la Non-Specificité botanique des Champignons des Teignes.** (On the non-specific character of scurf fungi.)

[The author considers them as sterile mycelia of Gymnoasceæ.]

C.R. Soc. Biol. Paris, lxxix. (1910) pp. 495-7.

* Mem. Dept. Agric. India, Bot. Ser. ii. 9 (1910) pp. 1-60. See also *Bot. Centralbl.*, cxvi. (1911) pp. 45-6.

† *Teysmannia*, xxi. p. 548. See also *Bot. Centralbl.*, cxvi. (1911) p. 46.

‡ *Rept. Missouri Bot. Garden*, xxi. (1910) pp. 185-8 (1 pl.).

- GUÉGUEN, FERNAND—**Conseils pratiques relatifs à l'Étude des Champignons.** (Practical advice on the study of fungi.)
[Advice as to collection, preservation, and determination of species, with a list of useful books.] *Bull. Soc. Mycol. France*, xxvi. (1910) pp. 419-33.
- HEALD, F. D., & F. A. WOLF—**New Species of Texas Fungi.**
[Mostly minute parasitic species.] *Mycologia*, iii. (1911) pp. 5-22.
- HERZFELD, STEPHANIE—**Ueber eine neue Taphrina auf Polystichum Lonchitis.** (A new *Taphrina* on Ferns.)
[The parasite causes brownish blisters on the leaves.]
Oesterr. Bot. Zeitschr., lx. (1910) pp. 249-54.
See also *Hedwigia*, l. (1910) Beibl., p. 104.
- HÖHNEL, FRANZ V.—**Fragmente zur Mykologie.** (Notes on Mycology.)
[Criticisms and notes on a large number of genera and species. The author establishes as new genera *Encoeliella* (Cenangiaceæ), *Helotiopsis* (Helotiaceæ), and *Siroscyphella* (Nectrioidæ-Patellinæe).]
SB. k. Akad. wiss. Math.-Nat. Kl., cxix. (1910) pp. 617-79.
- HOLLÓS, L.—**Magyarországból ismeretlen gombák Kecskemét vidékéről.** (New fungi for Hungary from the region round Kecskemét.)
[A list of 959 species is given belonging to the Fungi Imperfecti.]
Magyar Bot. Közlemények., ix. (1910) pp. 198-221.
See also *Bot. Centralbl.*, cxvi. (1911) pp. 15-16.
- „ „ **A szarnasgombáról. A szarvasgomba története.** (On truffles. A history of truffles.) Magyar.
Természettudományi Potfüzetelek, (1910) pp. 1-14 (21 figs.).
See also *Bot. Centralbl.*, cxvi. (1911) pp. 40-1.
- JAAP, O.—**Fungi selecti exsiccati. Series xvii. and xviii., Nos. 401-50.**
[The series consists of microfungi, some of them new, many of them rare species.]
Hamburg, 25 Burggarten, 1910.
See also *Bot. Centralbl.*, cxiv. (1910) pp. 617-18.
- LENDNER, A.—**Nouvelles Contributions à la Flore cryptogamique Suisse.** (New Contributions to the cryptogamic flora of Switzerland.)
[New records and descriptions of *Mucor botryoides* sp. n.]
Bull. Soc. Bot. Genève, sér. 2, ii. (1910) pp. 78-81 (2 figs.).
See also *Bot. Centralbl.*, cxvi. (1911), p. 41.
- „ „ **Observations sur les Zygosporées des Mucorinées.** (Observations on the Zygosporées of Mucorini.)
[Notes on *Sporodinia grandis* and *Absidia spinosa*.]
Tom. cit., pp. 56-9 (4 figs.).
- LINDAU, G.—**Hyphomycetes.** (The fascicle completes Lindau's great work on Hyphomycetes.) *Rabenhorst's Krypt.-Fl.*, Abt. ix., Lief. 120 (Leipzig, 1910) pp. 945-83 and i-viii.
- LINDFORS, THORE—**Einige Uredineen aus Lule Lappmark.** (Some Uredineæ from Lule Lappmark [Swedish Lapland].)
[Species of Uredines on *Erigeron alpinus*, *Veronica alpina*, *Viola epispila* and *Saxifraga cernua*.]
Sv. Bot. Tidskr., För. iv. (1910) pp. 197-202 (4 figs.).
- MASSEÉ, G.—**Fungi exotici. X.**
[A list of new species from various tropical regions; one new genus *Hartiella* (Stilbaceæ) is described, from Trinidad.]
Kew Bull., i. (1910) pp. 1-6 (1 pl.).
- MIGULA, W.—**Krypt. Flora, v. Lief. 100-6, pp. 33-144 (34 pls. col.)**
[The fascicle deals with genera of Hymenomycetes.]
Flora von Deutschland. Reuss: F. v Gezschwitz (1910).
- MURRILL, W. A.—**The Agaricaceæ of Tropical North America. I.**
[A large number of re-named species are given. A new name *Chloroneuron* is substituted for *Chlorophyllum* Murrill, and *Lactaria* for *Lactarius*.]
Mycologia, iii. (1911) pp. 23-36.

- MURRILL, W. A.—**A New Boletus from Jamaica.**
 [The new species is called by the author *Gyroporus jamaicensis*.]
Mycologia, ii. (1910) p. 305.
- POPOVICI, A. P.—**Contribution à l'Etude de la Flore mycologique de la Roumanie.**
 (Contribution to the mycological flora of Roumania.)
 [A list of species for that country, many of them new records.]
Ann. Sci. Univ. Jassy, vi. 3 (1910) pp. 105-16.
 See also *Bot. Centralbl.*, cxvi. (1911) p. 95.
- RACIBORSKI—**Parasitische und epiphytische Pilze Javas.** (Parasitic and epiphytic fungi from Java).
 [A number of new species are included and several new genera: *Farysia*, *Goplana*, *Ordonia*, *Mohortia*, *Alina*, and *Psidania*.]
Anz. Akad. wiss. Krakau (1909) p. 346.
 See also *Bot. Centralbl.*, cxvi. (1911) pp. 16-17.
- RAYNER, J. F.—**Recent Additions to the Fungus Flora of the New Forest.**
Hampshire Field Club, Reprint (1910) 3 pp.
- SARTORY, A.—**Contribution à l'Etude de quelques Oospora pathogènes.** (Contribution to the study of some pathogenic *Oospora*.)
 [Cases of *Oospora* growths in the lungs, etc.]
Bull. Soc. Mycol. France, xxvi. (1910) pp. 394-403 (13 figs.).
- SCHAFFNIT, E., J. SWENSITZKY, & H. SCHLEMM—**Der Hauschwamm und die wichtigsten Trockenfäuleschwämme vom botanischen, bautechnischen und juristischen Standpunkte.** (Dry rot and the more important wood-destroying fungi, from the botanical, architectural and legal standpoints.)
 Berlin: P. Parey (1910) 106 pp. (1 pl. and 21 figs.).
 See also *Hedwigia*, l. (1910) Beibl., p. 162.
- STEVENS, F. L., & J. G. HALL—**Three Interesting Species of Claviceps.**
 [Two species on *Paspalum* and one on *Tripsacum*.]
N.C. Agric. Exp. Stat., West Raleigh, N.C.
 See also *Bot. Gaz.*, l. (1910) pp. 460-3.
- STRASZER, P. PIUS—**Fünfter Nachtrag zur Pilzflora des Sonntagberges (N.O.).**
 (Fifth contribution to the Fungus Flora of the Sonntagberg in North Austria.)
 [The list includes Hysteriaceæ and Pezizaceæ.]
Verh. k.k. Zool.-bot. Ges. Wien, lx. (1910) pp. 464-77.
- THEISSEN, F.—**Fungi riograndenses.**
 [One new genus *Crocosphæria* (Sphæriales) and several new species are included in a list of Dothidiales, Sphæriales, and Discomycetes.]
Beih. Bot. Centralbl., xxvii. (1910) pp. 384-411.
- TROTTER, ALEX.—**Flora Italica Cryptogama. Pars. I.—Fungi. Fasc. vii. Uredinales.**
 [The genera *Puccinia* and *Gymnosporangium* are dealt with.]
 Rocca: P. Casciano (1910) pp. 145-338.

Lichens.

(By A. LORRAIN SMITH.)

Usnea and its Linnæan Nomenclature.*—At the International Botanical Congress, held at Brussels in 1910, it was decided to accept Linnæus's Species Plantarum as the starting-point for lichenological nomenclature. R. Heber Howe has taken the genus *Usnea* and examines the specific names in the light of Linnæus's determinations. He finds that Linnæus referred constantly to the figures and descriptions of Dillenius. He gives the citations under each species, and finds that the specially Linnæan species are: *Usnea plicata* (L.) Web. (*U. ceratina* Ach.); *U. barbata* (L.) Web. (*U. dasypoga*); *U. articulata* (L.) Hoffm., and *U. florida* (L.) Web., with the synonym *Lichen hirtus* L., the latter being the sterile condition of the plant.

* Bull. Torrey Bot. Club xxxvii. (1910) pp. C05-9.

New Lancashire Lichens.*—J. A. Wheldon made an excursion to Ease Gill, a valley in Lancashire with a great variety of geological strata and an altitude varying from almost sea-level to 2000 feet high. He found *Lecanora Prevostii* on perpendicular limestone rocks in good condition, and associated with *Lecidea cupularis*. A photograph of the locality has been published showing the character of the rocks where these lichens grow. *L. excentrica* was also collected during the day on limestone boulders. Wheldon notes the abundance of lichens that occur in Silverdale, perhaps owing to its proximity to the sea.

HASSE, H. E.—**Additions to the Lichen Flora of Southern California, No. 5.**

[A list with diagnoses of three species previously known, and three new to science.]

Bryologist, xiv. (1911) p. 2-4.

JATTA, A.—**Flora Italica Cryptogama. Pars. III. Lichens. Fasc. iv. Enterolicheni.**

[Cladoniaceae and Lecideaceae are described.]

Rocca: S. Casciano (1910) pp. 461-694 (5 figs.).

LESDAIN, BOULY DE—**Notes Lichenologiques, Nos. xi., xii., xiii.**

[Notes on species from various localities, some of them new to science.]

Bull. Soc. Bot. France, lvii. (1910) pp. 31-5, 236-40, 460-8.

SERVIT, M.—**Zur Flechtenflora Norddalmatiens.** (The Lichen Flora of North Dalmatia.)

Ung. Bot. Blätter, ix. (1910) pp. 164-93.

See also *Bot. Centralbl.*, cxvi. (1910) p. 19.

SMITH, A. LORRAIN—**New Lichens.**

[A list of British species new to science, with diagnoses and notes.]

Journ. of Bot., xlix. (1911) pp. 41-4 (1 pl.).

ZAHLBRUCKNER, A.—**Lichens rariores exsiccati, Dec. xiii.-xiv.**

[Forty specimens of Lichens are issued.]

Wien, 1910. See also *Bot. Centralbl.*, cxiv. (1910) p. 650.

Mycetozoa.

(By A. LORRAIN SMITH.)

New Genus of Plasmodiophoraceae.†—René Maire and Adrien Tison found the organism on the roots of *Veronica arvensis* in the cortical tissues. The parasite is unlike all other allied forms in the absence of any action causing hypertrophy. A uninucleate myxamoeba is found in the host-cell near the tip of the root; it becomes plurinucleate, and finally breaks up into spores. It has evidently no hurtful effect on the host-cell. The authors consider that they are dealing with a new genus *Ligniera* allied to *Rhizomyxa*; they found a second species of the genus on the roots of *Callitriche stagnali*.

LISTER, G.—**Two New Species of Mycetozoa.**

[A species of *Licca* from Aberdeenshire, and of *Hemitrichia* from Japan.]

Journ. Bot., xlix. (1911) pp. 61-2.

MACBRIDE, T. H.—**A New Genus of Myxomycetes.**

[*Schenella simplex* g. et sp. n., probably referable to *Dianemea*. Collected on a pine log in the Yosemite valley.]

Mycologia, iii. (1911) pp. 39-40 (1 pl.).

RAYNER, J. F.—**Recent Additions to the Mycetozoa of the New Forest.**

Hampshire Field Club, Reprint (1910) 1 p.

* Lancashire Naturalist, iii. (1910) pp. 192-4 (1 pl.)

† Comptes Rendus, clii. (1911) pp. 206-8.

Schizophyta.**Schizomycetes.**

Oxidizing and Reducing Properties of Bacteria.*—W. H. Schultze has devised tests for investigating these properties. To show reduction, he uses a mixture of 1 p.c. solution of α -naphthol and paranitroso-dimethylamine. This is mixed with nutrient agar, and the mixture is plated. The medium is of a yellow colour. Now by means of a platinum loop inoculated with a suitable organism strokes are made over the surface of this plate, and in a few minutes blue or bluish-green lines appear. *Staphylococcus pyogenes aureus* gives the reaction in one minute.

Similarly, to demonstrate oxidation, agar plates are used to which have been added a mixture of α -naphthol and dimethyl-paraphenylenediamine, one part of the mixture to three of agar. If strokes from cultures of a suitable bacterium be made on this plate, a deep-blue colour will appear very rapidly. With *Bacillus pyocyaneus* a reaction is obtained in ten seconds. *B. fluorescens capsulatus* gives a reaction in fifteen seconds. If the organisms which give this reaction are examined microscopically, it is found that vital staining of bacterial granules has taken place.

Chlorine Method of Water-purification.†—L. C. Walker, in a paper read before the Association of Water Engineers, advocates the use of a new system of purifying water by means of chlorine. This process involves the automatic addition of chlorine to the water, a contact period between water and chlorine, and lastly the total elimination of the chlorine after it has fulfilled its functions of destroying the bacteria. After some preliminary treatment, the water is pumped into a De-Clor filter. The upper part of this filter serves as contact chamber for water and chlorine. The chlorine, in the form of a weak suspension of chloride of lime, is pumped in from a tank. After thirty minutes contact, the water passes to the filter proper, the lower part of the structure. This is composed of three layers, a layer of granulated carbon 20 in. thick between two layers of specially graded silica. The carbon acts upon the free chlorine, converting it into fixed and innocuous compounds. Bacteriological tests show that *Bacillus coli communis* may be present in 1 c.cm. or even 0.1 c.cm. of river water, in 10 c.cm. or less of water after preliminary treatment, and not present in 100 c.cm. of the water after treatment. Chemical tests show the absence of free chlorine from the treated water.

Bacteriology of Landry's Paralysis.‡—A. Bevacqua gives an account of the pathology and bacteriology of acute ascending paralysis. In sections of the spinal cord he found an organism, which he was subsequently able to demonstrate also in the pons and the medulla oblongata, as well as in the kidneys, liver, and spleen. He is of opinion that this is the causal agent of the disease, and not a chance post-mortem infection. The organism is a bacillus assuming at times a filamentous form, which grows only under anaerobic conditions. On the ground of its cultural and morphological appearance, and also of the gelatinous form of inflamma-

* Centralbl. Bakt., 1te Abt. Orig., lvi. (1910) pp. 544-51.

† English Mechanic, xcii. (1910) pp. 449-50.

‡ Centralbl. Bakt., 1te Abt. Orig., lvi. (1910) pp. 470-87.

tory œdema found in the spinal cord, the author considers that it is closely allied to the *Bacillus œdematis maligni* and the *B. phlegmonis emphysematosæ* Fränkel.

Bacillus Nenckii: New Agar-liquefying Organism.*—The property of liquefying agar media has hitherto only been met with in two types of micro-organism, viz. *Bacterium betæ viscosum*, isolated by K. Panek from beets, and *Bacillus gelaticus* Grau. W. Biernacki now describes a small bacillus, isolated from Malaga raisins, which also possesses this peculiarity. The organism is usually $1.25-2 \mu$ in length, and has a breadth of 0.8μ . The shape and size vary upon different media, coccid forms being found on acid media, whereas on potato longer forms are met with. The bacilli lie naturally in pairs, occasionally in short chains. A facultative anaerobe, non-motile, non-sporing, it takes up the ordinary stains, but does not retain the colour with Gram's method. On gelatin, which is not liquefied, small yellowish white granular colonies appear. The addition of glucose renders growth more luxuriant. Agar is liquefied. Inoculation of a deep agar stab in an hermetically sealed test-tube results in much gas-formation, tearing up the medium, and in rapid liquefaction. Further investigations upon the various fermentation reactions are now being carried out. This organism has received the name *Bacterium Nenckii*.

Bacteriology of Chorea.†—G. Camisa gives an account of a diplo-streptococcus isolated from the blood of chorea patients. The number of cases investigated was nine, of which six were found to have this organism in their blood. Simultaneous blood examinations of healthy persons and patients suffering from other diseases were performed as control experiments; in none of these cases were any organisms obtained from the blood. The chorea patients were then treated with intravenous injections of sublimate in small doses. This caused complete cure, and it was found that as the cases improved the blood became free from micro-organisms.

The organism isolated from all these cases is a small, Gram-positive non-motile coccus, which occurs paired and in short chains. It grows upon ordinary media, not liquefying gelatin, forming small punctate colonies upon agar. A few animal inoculations gave negative results. A series of agglutination experiments were made with serum obtained from healthy persons, chorea patients, and patients suffering from infectious diseases. Control experiments with *Streptococcus pyogenes* were performed. It was found that with serum from chorea patients agglutination was obtained in somewhat higher dilutions than with serum from others, although two typhoid sera give positive results in higher dilutions than any of the chorea patients. As the cases improved, this reaction became less marked.

Virulence of Pneumococcus and Streptococcus.‡—E. L. Lo Monaco has made a study of the action of various immune sera upon these organisms by inoculation of cultures grown in media containing serum

* Centralbl. Bakt., 2te Abt., xxix, (1911) pp. 166-9.

† Tom. cit., pp. 99-107.

‡ Tom. cit., pp. 108-48.

into animals, and observation of the lethal dose. He finds that the pneumococcus grows as well in the presence of immune sera, active or inactivated, as in normal serum, the organisms are agglutinated, so that the broth remains almost clear. Grown in broth containing immune serum, the pneumococcus rapidly loses its virulence. This loss does not appear to be proportional to the immunising power of the serum. Subcultures from a pneumococcus, thus deprived of virulence, act also avirulent. The immune bodies have no catalytic action, but appear to cause paralysis of those vital processes of the organism which render it virulent. Immune bodies from sera of such different animals as the rabbit and the ass, appear in relation to the pneumococcus to be indistinguishable. The streptococcus does not lose its virulence in the presence of immune sera, but otherwise its behaviour is similar to that of the pneumococcus.

The active principles of anti-pneumococcic and anti-streptococcic sera lose their individuality after contact with these organisms. The bacteriotropic function of these sera consists probably in a lesser degree of an antitoxic action and in a greater degree in an action upon the bacteria, which inhibits the formation of those toxic substances upon which the pathogenicity depends. The organism, thus reduced to the state of an ordinary saprophyte, is taken up by a phagocyte and destroyed.

Mouse Epizootic due to a Coliform Bacillus.*—G. Sangiorgi describes a spontaneous epizootic among the white mice at the Hygienic Institute of Turin, which killed 20 p.c. of these animals. The principal symptoms were subnormal temperature, distressed breathing, great weakness of the hind legs, profuse diarrhoea, and emaciation. The autopsy revealed patches of necrosis on the surface of the liver, enlargement of the spleen, and marked pallor of the kidneys. From spleen and heart-blood an organism was obtained, which corresponded culturally and morphologically with *Bacillus coli communis* in every point but one, viz. that it did not clot milk before 7 or 8 days at 37°, and no clotting occurred at room-temperature. Rats and mice fed with cultures died, the latter in 5 to 6 days, the former in 8 to 11 days. Cats suffered from profuse diarrhoea as long as the administration continued, but did not usually succumb. Intraperitoneal inoculations killed mice, rats, rabbits, and guinea-pigs very quickly.

Characters of Cholera and Cholera-like Organisms.†—This study has been carried out by A. J. McLaughlin and E. R. Whitmore with a view to settling some points concerning certain vibrios encountered in the Philippine Islands. The first point was whether any cholera-like vibrios might agglutinate in a low dilution of a specific anti-cholera serum and thus lead to error. The second point was whether cholera vibrios lose their morphological character or agglutinability under any circumstances, but especially in mixed cultures sent on a long journey for diagnosis. Every vibrio examined by the authors which agglutinated in a 1:200

* Centralbl. Bakt., 1te Abt. Orig., lvii. (1910) pp. 57-9.

† Philippine Journ. Sc., v. B., pp. 403-32.

dilution of a specific anti-cholera serum was found to be a true cholera vibrio, whereas no other vibrios agglutinated in a weaker dilution than 1:10. Four cholera vibrios did not agglutinate in certain sera in higher dilution than 1:200, and three of these, as it happened, had been travelling for seven days in mixed cultures.

The third point was whether El Tor vibrios were to be found in the Philippines. For this purpose Ruffer's hæmolytic test was used. Ruffer found that El Tor vibrios had the power of lysing suspensions of red corpuscles, and that cholera vibrios had not this property. The authors found that none of their agglutinating strains were hæmolytic, and so report that they have not discovered El Tor vibrios in these islands.

In settlement of the fourth point, they found that none of the cholera-like strains which did not agglutinate with a specific serum could be made to acquire such agglutinability.

Fifthly, they found Diendoné's medium satisfactory as a means of isolating cholera vibrios from the stools, but it could not be used for differentiating cholera-like vibrios from true vibrios.

Lastly, they performed a few experiments in order to find whether the hog might be a cholera carrier. The results were negative.

Bacterial Disease of Potato-plant.*—G. H. Pethybridge and P. A. Murphy give an account of a disease occurring among potatoes in Ireland, from which a specific organism has been isolated. The most obvious features of the disease consist in discoloration and drying of the foliage, browning of the principal vascular bundles of the stem, decay of the underground part of the stalk, and rotting of the tubers. An organism was isolated, which was inoculated into healthy plants, and thus shown capable of reproducing the disease. It is a multiflagellate, peritrichous bacillus, liquefying gelatin, practically non-chromogenic, and evidently allied to, but not identical with, certain other organisms which have been described in other countries as causing a similar disease in potatoes. The name *Bacillus melanogenes* has been suggested. Preventive measures should aim at the destruction of diseased plants, the exclusion of affected tubers from the pits, and the procuring of tubers for seed purposes from crops in which the disease has not appeared.

* Proc. Roy. Irish Acad., xxix. (1911) pp. 1-37.



MICROSCOPY.

A. Instruments, Accessories, etc.*

(1) Stands.

Winkel's Stand No. 1†—This stand (fig. 31) has been specially designed for photomicrographic work and visual observations demanding the greatest precision.

It has rack-and-pinion, coarse- and new form of fine-adjustment, one division of the drum of which represents a vertical movement of 0.002 mm., centring rotating mechanical stage, the lateral mechanism of which can be removed; the rotation can also be clamped by means of a milled head on the left-hand side of the instrument; iris-diaphragm mounted beneath the stage; substage illuminator No. 1, body-tube 6 cm. in diameter, thus permitting the use of the low-power micro-luminars without cutting down the field, after removing the draw-tube, which is of the usual standard gauge graduated to millimetres.

The whole is mounted on a heavy horseshoe foot with hinged up-right-hand clamp; the instrument can thus be set at any convenient inclination from vertical to horizontal; the fitting carrying the plane and concave mirror can be removed when the instrument is required for use in the latter position.

Winkel's Travelling Microscope‡—This instrument (fig. 32) which is of medium size, can, by hinging stage and foot, be fitted into a case $11\frac{1}{2} \times 8 \times 3\frac{1}{2}$ in., thus rendering it much more portable than our laboratory models of similar size.

It has rack-and-pinion, coarse- and micrometer screw fine-adjustment, square stage fitted with iris-diaphragm, substage illuminating apparatus, with screw focusing adjustment, graduated draw-tube, double nose-piece, and joint for inclination.

The method of packing will be obvious from the illustration. Before rotating the stage to pack the instrument, the mirror, which slides in a groove, must be lowered, and on again setting up the instrument care must be taken to see that the stage is brought right over to the stop

* This subdivision contains (1) Stands; (2) Eye-pieces and Objectives; (3) Illuminating and other Apparatus; (4) Photomicrography; (5) Microscopical Optics and Manipulation; (6) Miscellaneous.

† R. Winkel, Göttingen Catalogue, 1911, pp. 22-3 (1 fig.).

‡ Tom. cit., p. 45 (1 fig.).

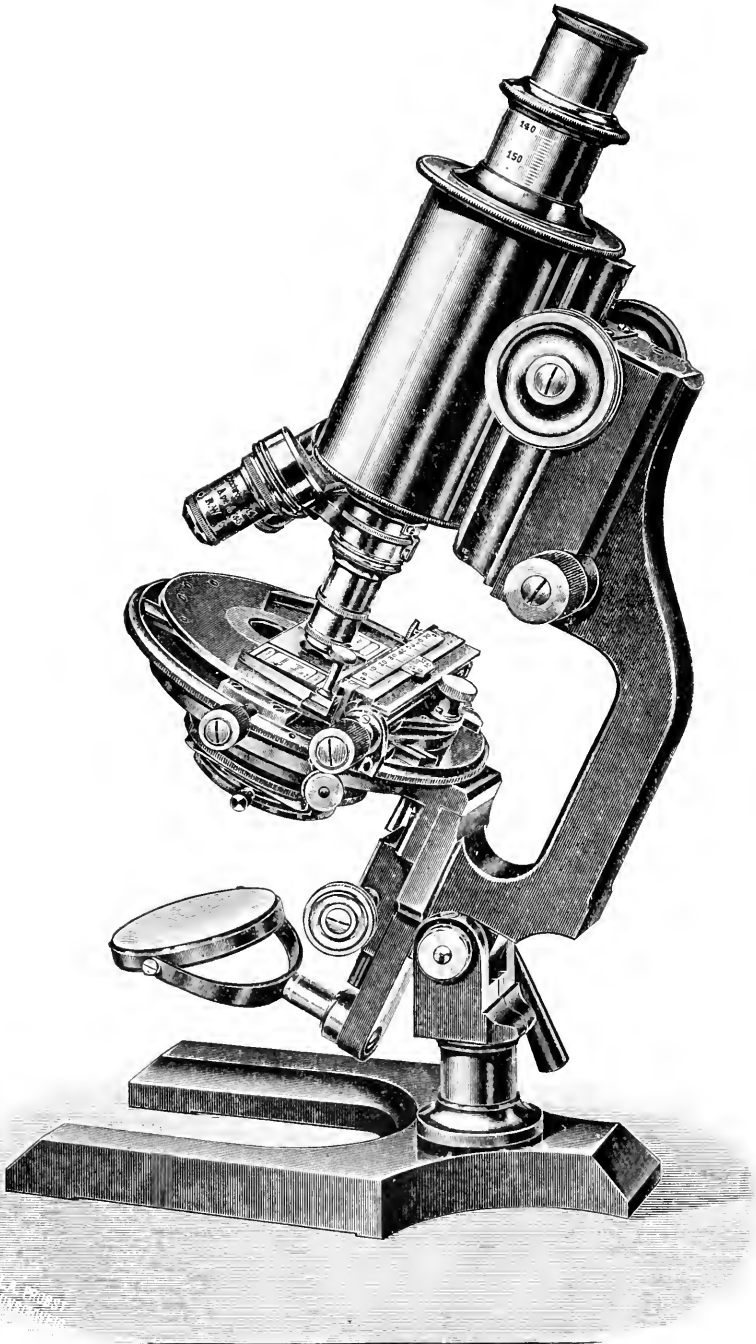

FIG. 31.

provided, thus assuming a truly horizontal position before clamping, otherwise the optic axis will not be perpendicular to it.

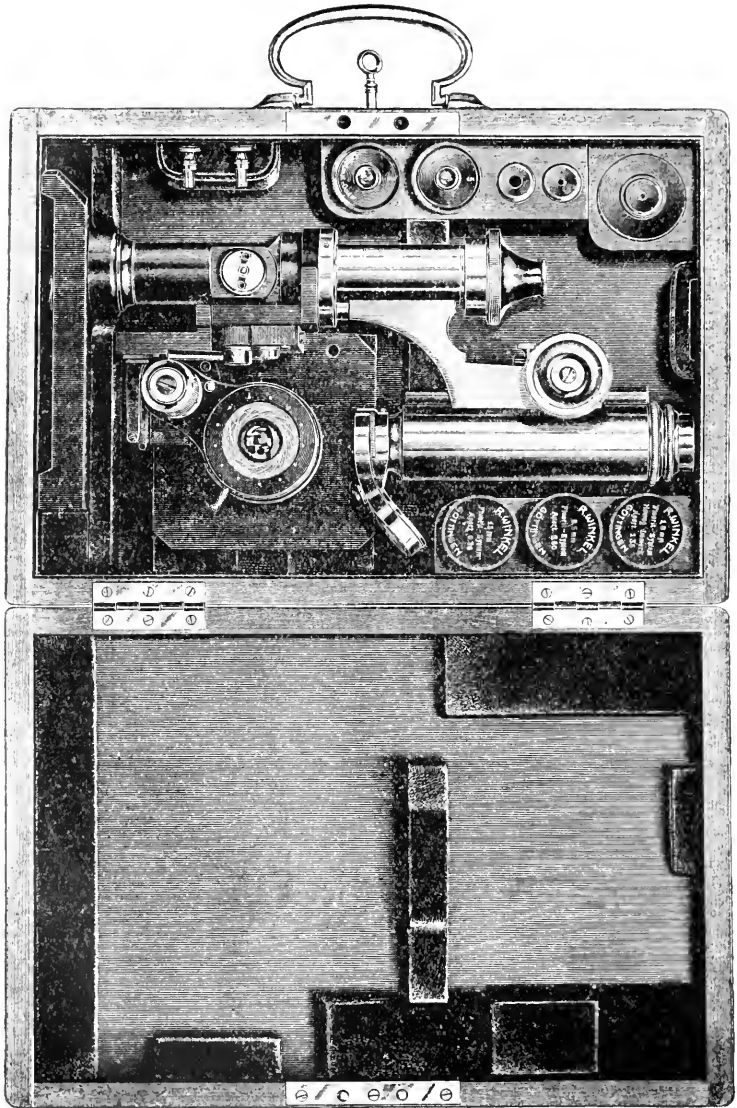

FIG. 32.

Winkel's Dissecting Microscope.*—This instrument (fig. 33) gives greater working surface than most dissecting Microscopes. As will be seen from the illustration, it has rack-and-pinion focusing adjustment and also a rack-and-pinion movement for adjusting the optical system in a horizontal plane, which, together with a rotary movement in the

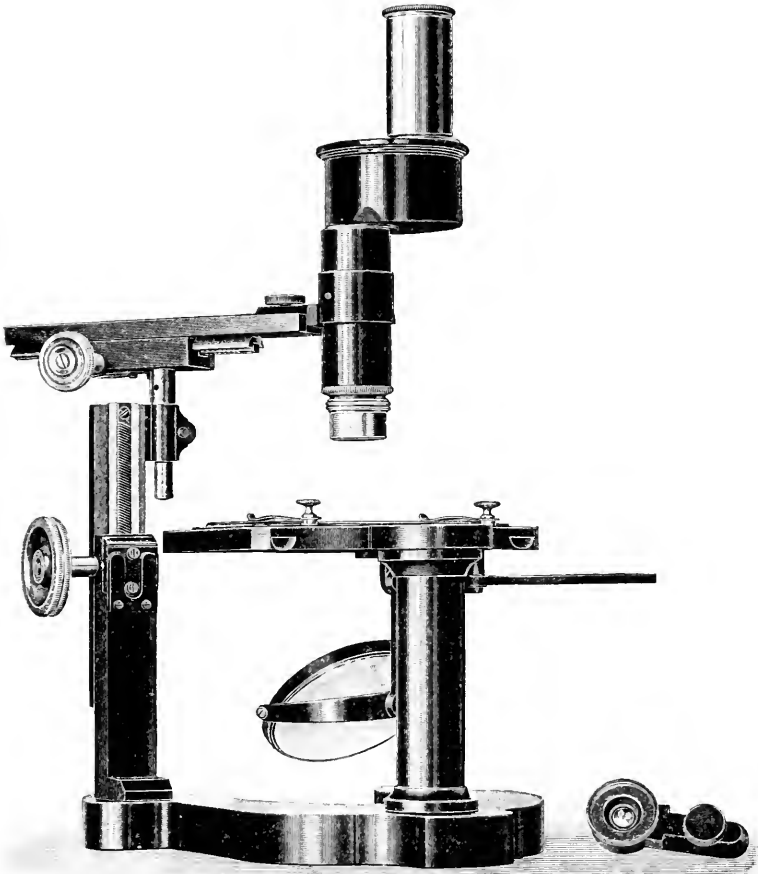

FIG. 33.

same plane, permits of its use over any desired portion of the stage. The arm carrying the optical system is slotted to receive either the Porro erector, which can be used with ordinary objectives and eyepieces, or a ring to carry single lenses, both of which are provided, together with silvered and opal reflectors for illuminating transparent objects, and a plate with black and white surfaces—shown in the illustration swung aside—as a contrast background for opaque objects.

* R. Winkel, Gottingen Catalogue, 1911, p. 50.

(2) Eye-pieces and Objectives.

Edinger's Pointer-Double-Ocular.*—In spite of the advantages of the pointer-ocular, L. Edinger has long felt that an eye-piece which would allow of simultaneous observation by two persons, and which would at the same time preserve the principle of the pointer, was a great desideratum. The applicability of such an auxiliary to teaching purposes needs no demonstration. The apparatus shown in fig. 34 has been made by the Leitz firm to the designs of C. Metz, and is found to answer its purpose completely. The name Pointer-double-ocular (*Zeigerdoppel-ocular*) has been given to it. Between the collective-lens and the eye-lens of an ordinary ocular and exactly over the ocular diaphragm a double prism, i. ii., is inserted. Prism i. is an isosceles prism of angles 35° , 35° , 110° . Prism ii. is right-angled, with angles 35° , 55° and 90° . The prisms are placed so that their larger sides (i.e. those opposite 110° and 90°) are in juxtaposition, and in such a manner that they are separated by an exceedingly thin layer of air. At this air-space, inclined at 35° to the optic axis, a partial reflexion of the light-beam takes place.

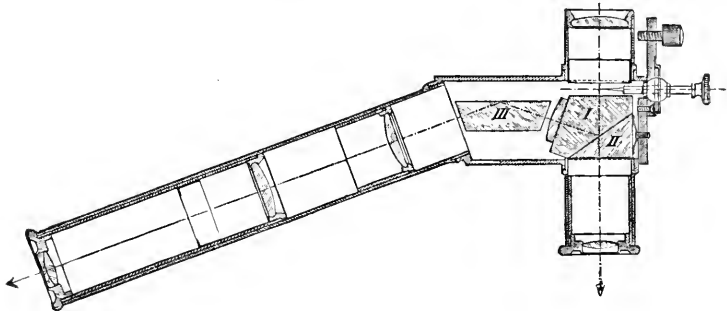

FIG. 34.

About two-thirds of the beam passes on and about one-third is reflected. The image formed in the main optic axis is therefore somewhat brighter than that formed by reflexion. The images formed are of equal value, because in both the full aperture of the objective is utilized. The axis of the reflected image forms with the axis of the Microscope an angle of 70° . Lateral observation would be quite possible if an eye-lens, the same as for the vertical observation, were applied at a suitable distance. But this would bring the lateral observer too near to the tube and to the first observer. Therefore a lens combination is applied somewhat similar to a terrestrial ocular. The tube of this telescope has a downwards inclination which imparts some difficulty to its use until the observer's head has found the right position. But the Leitz firm also deliver the apparatus with an upwards-inclined tube, and for this purpose prism iii. is introduced. This, however, has the effect of weakening the light, and the author prefers the first method. Adjustment is made at the vertical eye-lens, and this is simultaneously effected through the bent tube at the second eye-lens. If the second observer's eyes are not normal

* *Zeitschr. wiss. Mikrosk.*, xxvii. (1910) pp. 336-8 (1 fig.).

he must correct them by spectacles. The two images are then identical and the pointer appears in each. The slight difference in brightness is not found to be a detriment. The author has, after a year's experience, found the instrument a very valuable help in his demonstrations.

BOEGEHOLD, H.—*Eine neue Konstruktion von Korrektionslinsen.*

[Chiefly relates to telescopes]

Zeit. f. Instrumentenkunde, xxx. (1910) pp. 302-7 (1 fig.).

(3) Illuminating and other Apparatus.

New Method for Microscopical Metallography.*—E. Sommerfeldt describes J. Königsberger's apparatus and method. If natural light be allowed to fall by means of a vertical illuminator on an isotropic surface the reflected light does not exhibit polarization. But if the reflexion occurs at an anisotropic surface a separation of the light takes place into two components vibrating perpendicularly to each other, and these components are of unequal intensity, so that a partial polarization follows. Two arrangements serve for realizing this polarizing effect on well-polished surfaces. The simpler arrangement—not serviceable, however, for quantitative measurements—consists of a Klein quartz plate, in combination with a nicol prism (polarizer), placed in front of the vertical illuminator; the analyser (inner nicol) remaining in the usual place. The Klein plate gives violet effects with isotropic substances; but with anisotropic substances it furnishes a coloured field which changes during rotation (red and blue; with strong anisotropy, bright yellow or green). The second arrangement involves the use of a Savart's double plate, which, observed with a telescope adjusted for infinity, must reveal between crossed nicols two deep black quite sharp bands, surrounded by coloured bands. If unpolarized light is reflected (i.e. if the preparation is isotropic) no bands appear. The more complete the polarization of the reflected light the clearer appear the bands, and therefore the deeper the anisotropy of the preparation. By means of a contrast plate, prepared out of two smoke-quartz plates cut perpendicularly to the axis, the bands become intensified. The preparation must be very accurately set perpendicular to the incident light rays, and this is effected by the adjusting apparatus J seen in fig. 35.

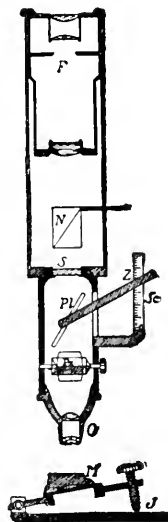

FIG. 35.

Application of Mercury Light to Microscopical Works.†—A. Köhler describes a Hageh Microscope lamp which the Zeiss firm have made for him and which he has found very useful in his microscopical work. The light source is furnished by one of Messrs. Schott's Hageh lamps, in which the mercury column has a special length of 20 cm. A special

* *Metallurgie*, vi. (1909) pp. 605-7 (1 pl. and 1 fig.). See also *Zentralbl. f. Min., Geol. u. Paläont.*, 1908, p. 565; 1909, p. 245; and *Zeitschr. wiss. Mikrosk.*, xxvii. (1910) p. 445 (1 fig.).

† *Zeitschr. wiss. Mikrosk.*, xxvii. (1910) pp. 329-35 (1 fig.).

resistance coil is supplied for use with currents of 65 to 220 volts. A current strength of about 3.5 amperes is necessary. As seen in fig. 36, the tube is placed in an inclined position in a U-shaped holder and secured with springs. The lower end of the lamp where the mercury accumulates is connected with the negative pole of the circuit. The lamp is shielded from the observer by an iron shade, so as to shut off the superfluous light; the shade has an opening opposite the middle of the lamp for transmitting the light, which then impinges upon the flask filled with a solution and acting as an engraver's globe. The holder of this flask (see figure) also acts as a handle for lifting the whole apparatus. The effect of the entire arrangement is to throw an image of the illuminating mercury column on the iris diaphragm of the Microscope, and hence on to the plane of the object. The fluid in the flask not only

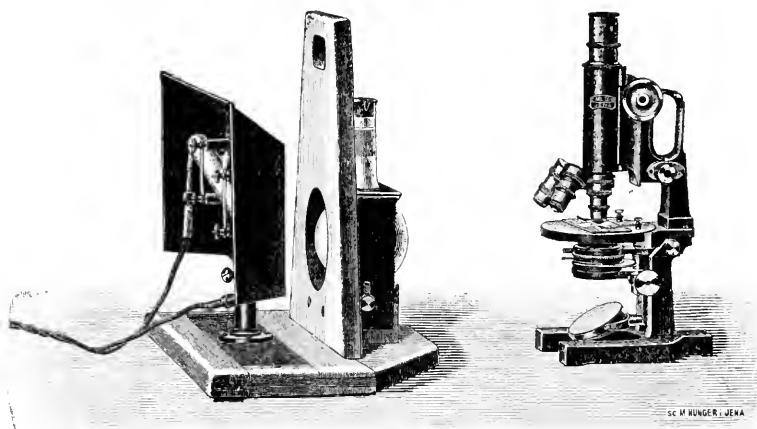

FIG. 36.

provides light for the lenses but also acts as a light filter. For clear green light of wave-length $546 \mu\mu$ (this is the brightest line of the mercury vapour lamp) the filter should have the following composition:—distilled water, 300 c.cm.; picric acid, 0.4 gm.; copper sulphate, 3.5 gm.; didymium nitrate, 15.0 gm. If this didymium nitrate be omitted no light is transmitted beyond the line $\lambda = 546 \mu\mu$; the yellow lines $\lambda = 576 \mu\mu$ and $579 \mu\mu$ also disappear. These two yellow lines are, however, obtained with great brightness with the following solution:—distilled water, 300 c.cm.; potassium bichromate, 15 gm.; copper sulphate, 3.5 gm.; sulphuric acid, 1 c.cm. The blue and violet lines $\lambda = 436 \mu\mu$, $407 \mu\mu$ and $405 \mu\mu$ are obtained with:—distilled water, 225 c.cm.; copper sulphate, 1 gm.; ammonium hydrate, 75 c.cm. With subjective observation only the line $436 \mu\mu$ is effective, as it is much more intensive than the two violet lines; the light in this case is, therefore, practically monochromatic. Flasks can be filled with the respective solutions and secured with well paraffined corks; they are then always available for obtaining light of their corresponding colours. For the

finest subjective observation the green light is usually the most useful. Its wave-length almost exactly corresponds with that for which the eye has the greatest adaptability, so that the finest details are seen in the clearest way. So great is the brightness that it suffices for the strongest magnifications. The yellow and the blue light filters will be more useful for studying changes in resolving power.

The lamp is very simple in management, and can be used for photomicrography.

New Microscope Lamp.—This lamp (fig. 37) was exhibited and described at the December Meeting.* By the kindness of the designer,

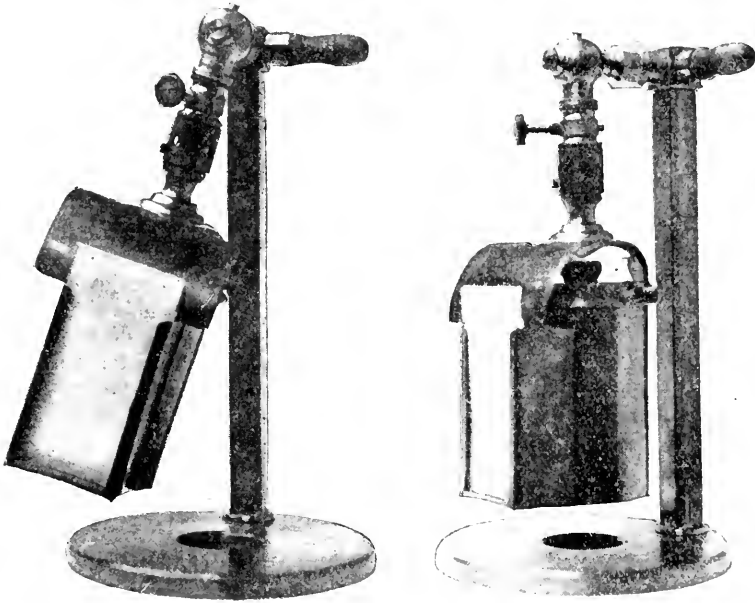

FIG. 37.

C. E. Heath, we are able to add some important particulars and give an illustration. Although not designed for critical work, he suggests that the lamp might be used for that purpose if a ground glass slip were inserted in the lamp, the surface of the ground glass being utilized as the source of light and focused upon the object by the sub-stage condenser. As it is difficult to focus the ground glass, a slip having lines ruled on the ground surface is used for focusing, and when the lines are sharply focused, a slip of ground glass without lines is substituted for it, care being taken that it faces the same way round as the ruled slip, so that the ground surfaces will be in the same plane, and therefore exactly in focus. The ground glass is kept from shifting by the pressure of the curved metal sheet seen in both figures.

* See this Journal, 1911, pp. 128-9.

Microspectroscope.*—This microspectroscope (fig. 38), made by Adam Hilger, can be substituted for the eye-piece in any form of Microscope. It has an adjustable slit, comparison prism, and clip for test-tube to hold comparison liquid, condensing lens, collimating lens, and compound prism. A photographic scale and screen adjustment for setting the same to the fiducial reading, and mirror for illuminating the scale from any source of light, are also supplied.

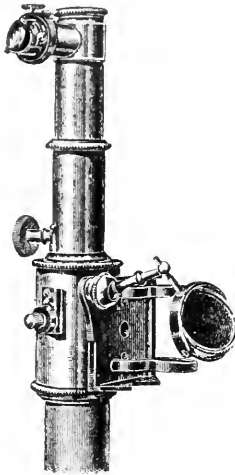

FIG. 38.

Plug Micrometer.†—H. Hipple describes a plug micrometer (fig. 39), having a hardened bushing, H, with three holes to receive the balls K. The bushing H is inserted in the barrel B. The holes in the barrel are bored rather small, so that at most only one-third of the diameter of the ball can project. The barrel B is graduated longitudinally, and threaded inside to receive the pin S. This pin is provided at one end with the cone C, and is fixed in the sleeve M, which is graduated. By turning the sleeve M, the pin will screw forward or backward, its cone C forcing the balls K outward or letting them come inward. In measuring a hole the pin S is screwed out so far that the balls do not project

through the barrel B, therefore resting on the smallest diameter of the cone C. Then the instrument is inserted in the hole that is to be measured, and the pin S is screwed in so far that the ball touch the side of the holes.

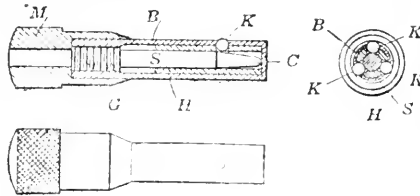

FIG. 39.

The diameter is then quickly read on the scale. The accuracy of the instrument is dependent on (1) the thread, (2) the cone, and (3) the balls. The smallest instrument is made for a hole from 6–7 mm. (0.25 in.) in diameter. It is therefore necessary to have a number of instruments in order to measure holes of greatly varying diameters.

GAIDUKOV, N.—*Dunkelfeld-beleuchtung und Ultra-mikroskopie in der Biologie und in der Medizin.*

Jena: Gustav Fischer (1910) 83 pp. (5 pls. and 13 figs.).

LÖWE, F.—*Ein tragbares Interferometer für Flüssigkeiten und Gase.*

Zeit. f. Instrumentenkunde, xxx. (1910) pp. 321–9 (7 figs.).

* Adam Hilger, Ltd., Catalogue, 1911, Section J, p. 3, fig. 4.

† American Machinist, through Eng. Mechanic, xcii. (1911) p. 581.

(4) Photomicrography.

Photographing Fossils by Reflected Light.*—L. D. Burling describes a method of photographing fossils by reflected light. The scheme seems to yield excellent results, and may be generally valuable in photographic reproduction. The back of an ordinary enlarging and reducing camera was pivoted so that it would revolve about a vertical line passing through the centre of the ground glass plate, and the rack upon which the specimens are mounted was made to revolve about a vertical line passing through the centre of the specimen. Suitable scales were so attached to both the specimen rack and the back of the camera, that each might be clamped at any desired angle. In practice the specimen is placed in position, the lens is removed, and the relative position of the light and the angular position of the specimen are manipulated to secure the most favourable illumination. (Experience has shown that variations in the intensity of light are necessary to bring

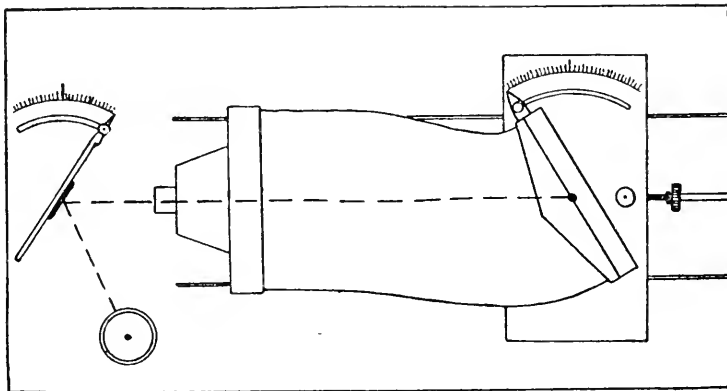

FIG. 40.

out the particular features of different specimens, and that the degree of illumination required can best be determined by direct observation through the camera rather than upon the ground glass.)

In order to eliminate distortion, the back of the camera is then revolved through an angle corresponding to that indicated by the scale on the specimen rack, the lens is replaced, and the specimen is focused and photographed. The best results have been obtained with lenses having a focal length of at least 6 or 7 inches, or long enough to eliminate any errors arising in the adjustment of the camera.

Fig. 40 is a plan of the camera showing its arrangement. The light used is a screened arc lamp, suspended by a pulley from the ceiling; the camera stand is movable, and the specimen rack and the back of the camera are each free to move through an arc of 60° . The box-like projection into which the bellows may be compressed has been cut away, to increase the angle through which the back of the camera may be revolved.

* Amer. Journ. Sci., xxxi. (1911) pp. 99-100 (1 fig.).

(6) *Miscellaneous.*

Microscopic Structure of Uric Acid Calculi.*—S. G. Shattock divides uric acid calculi into two classes, the cancellous and the compact, according as there are or are not lacunæ to be found in the sections. In the course of his remarks, the author compares the crystals forming calculi with uric acid sediments in urine, and discusses the nature of the nucleus of uric acid calculi. He finds that the nucleus is almost invariably of the same chemical composition as the rest of the stone, but that its structure varies, consisting of loosely arranged crystals resembling "crystalline rubble" in the cancellous variety, while in the compact one it is a dense mass of crystals arranged in radiating columns, and often starting from a small collection of cuboidal crystals. He points out that the essential condition for the formation of crystals must be supersaturation of the urine with uric acid. The paper is copiously illustrated.

Coloured Plates of Microscopical Preparations.†—Y. Sobotta describes a two-colour autotype process, by means of which the majority of histological preparations may be faithfully reproduced at a comparatively small cost. In preparing a plate of a section stained with hæmatoxylin and eosin, the stains may be represented by violet and red. A drawing is made first of all of the hæmatoxylin stained portion alone. This is executed in black with Chinese ink. By means of the autotype process, prints of this are prepared in black, in violet, and in a pale shadowy ground colour. Upon this last print, a drawing is made of the eosin-staining portion alone. This is also done in black. From this are prepared a plate in black and a plate in red. Then a combined print of the violet and the red plate will give a tint two-colour reproduction of the preparation.

Microchemical Demonstration of Guanin.‡—A. de Giacomo describes a method, by which the presence of guanin may be demonstrated in microscopical sections of birds' kidneys. This process depends upon Burian's reaction. The reagents employed must be carefully prepared at the time of use. The section, fixed in alcohol and adherent to a cover-slip, is washed in distilled water and dried. Two drops of a solution of diazobenzolsulphonic acid are added. After half a minute, a further quantity of the reagent is added, and then a small quantity of a sodium hydrate solution. The reagents may also be used in the reverse order. Yellowish-red points appear. The section may be mounted on a slide in the excess of sodium hydrate, or in glycerin. In a section so treated, an orange-red colour shows the presence of guanin in many of the cells of the tubular epithelium and in the connective tissue. The guanin-free portions have a pale yellow colour. Particulars of the stock solutions required and the methods of preparation are given.

Histological Changes in Infantile Paralysis.§—In the spinal cord of an old standing case of infantile paralysis, V. Jonnesco has found a

* Proc. Roy. Soc. Med., Pathol. Section iv. (1911) pp. 110-46 (26 figs.).

† Zeitschr. wiss. Mikrosk., xxvii. (1910) pp. 209-13.

‡ Tom. cit., pp. 257-9.

§ C.R. Soc. Biol. Paris, lxx. (1911) pp. 109-10.

remarkable formation. The case was of the monoplegic type. In the cells of the cervical ganglia, on the side corresponding to the affected limb, there appeared rosette bodies staining deeply with iron-hæmatoxylin. They are stained blue by the methods of Giemsa and Mallory. A low magnification shows six or eight axially-disposed filaments surrounded by a hyaline zone. High magnification shows that these filaments consist of a large number of small spherical granules linked together. The formation is placed in the ganglion cell, usually at some distance from the nucleus. The author considers various possible explanations, and regards as most probable the hypothesis that this is a crystalloid formation in the ganglion cell, which only becomes visible on account of the chromatolysis of the chromatophil substance of Nissl.

Quekett Microscopical Club.—At the 471st Ordinary Meeting, held on February 28, 1910, which was also the 45th Annual General Meeting, the President, Professor E. A. Minchin, M.A., F.Z.S., delivered an address on "Some Problems of Evolution in the Simplest Forms of Life." The principal points dealt with were popular classifications of living things, scientific methods to the same end, and the need in the latter case to draw distinctions and institute comparisons undreamt of by the ordinary person. The Microscope, relatively a thing of yesterday, is not yet adequate for our needs, but is growing and daily becoming more efficient. Different types of metabolism were observed in the Protista. In some cases a Protist organism can be at one time a plant, at another an animal. In Protista there are two well-marked types. One, more primitive and in which chromatin occurs only in scattered granules, "chromidia." The second, higher and leading on to the ordinary plants and animals, and in which the greater part of the chromatin is aggregated into a nucleus, and which, further, has a distinct protoplasmic zone—the cytoplasm. The first is the bacterial type, the second the cellular type. The existence in all forms of higher life of sex and sex-phenomena was then briefly dealt with. Sex-phenomena are also observed in the cellular type of Protista. In the visible world of living things it is found universally that organisms are divisible more or less easily into groups which are termed "species." Some species are sharply marked off from others, some are less so, but no one now considers a species as a fixed and immutable entity. The fact, however, remains that the tendency of living things to separate themselves into species more or less distinct, is one of the most constant and universal peculiarities of the organic world. In so far as the Protista are concerned it was thought that syngamy was the bond which unites the individuals comprising a species and separates them from those of another, though closely allied, species. Without syngamy a species would tend to break up into distinct races or strains, either under the influence of environment or by innate variations. Syngamy tends to reduce the individual differences to a common level, by mixing together the characters of divergent strains. It therefore follows that there are no true species amongst organisms of the bacterial grade, if it be true that syngamy does not occur amongst them, and the so-called species of bacteria are to be regarded as mere strains capable of modification in any direction by environmental influences. From these considerations it was thought to be evident that

the passage from the bacterial to the cellular grade was perhaps the most important advance in the evolution of living beings, as the cellular type was the starting point for the evolution, not only of the Protozoa, but through them of the whole visible everyday world of animals and plants, in all of which the cell is the unit of structure. Further, with the cellular type were initiated, in the President's opinion, two of the most universal and characteristic peculiarities of living beings, namely, the phenomena of sex and the tendency to form species.

B. Technique.*

(1) Collecting Objects, including Culture Processes.

Selective Action of Dieudonné's Medium.†—E. Glaser and Y. Hachla have carried out an investigation upon Dieudonné's alkaline blood-agar medium, devised for the isolation of cholera vibrios, with a view to ascertaining whether the growth of certain organisms other than cholera was permitted. They found that *Bacillus fæcalis alkaligenes*, an organism often present in normal fæces, grew on this medium as luxuriantly as *Vibrio cholerae*, and suggested that a ready means is thus afforded for the separation of *B. typhosus* and *B. fæcalis alkaligenes*. *B. fluorescens* and *B. fluorescens non liquefaciens* both grow well upon this medium at 22° C, but show little growth at 37° C. *Proteus vulgaris* grows well at both room temperature and blood heat, but *Proteus piscicidas versicolor*, while showing good growth at room temperature, is restrained at a temperature of 37° C.

New Method for Studying Movements of Bacteria.‡—M. Liachowetzky gives the following account of his method: Melted agar is poured into a small Petri dish, which must be perfectly horizontal. Upon the surface of the solidified agar is laid a sterile Swedish filter-paper, marked with three intersecting millimetre scales. The paper is moistened by the condensation-water of the medium. Should this prove insufficient, a small quantity of saline may be added. By means of a special platinum needle, the paper and agar are inoculated, from a culture of the organism to be investigated, at the point of intersection of the millimetre scales. Small pieces of sterile silk, from 2–5 mm. in length, are placed in various positions upon the scales. The plate is then placed in the incubator, the horizontal position being exactly maintained. After a suitable time, according to the nature of the investigation, and of the organism that is being studied, these silk threads are transferred to broth tubes, which are then incubated for one to three days. If the organisms, starting from the point of intersection, travel far enough to reach one of these threads, they will infect it, so that subsequent cultivation from this thread will yield a growth of the organism. Thus, if the broth tubes, inoculated with the nearer threads, give a growth, while

* This division contains (1) Collecting Objects, including Culture Processes; (2) Preparing Objects; (3) Cutting, including Embedding and Microtomes; (4) Staining and Injecting; (5) Mounting, including Slides, preservative fluids, etc.; (6) Miscellaneous.

† Centralbl. Bakt., 1te Abt., Orig., lvii. (1911) pp. 371–84.

‡ Tcm. cit., pp. 180–91.

cultivations from those more remote remain sterile, an accurate expression for the powers of locomotion of the organism may be obtained.

The author gives tables showing marked differences between the figures obtained in observations of non-motile and motile organisms. He shows that, by his method, the influence of abnormal chemical and physical conditions upon the motility of organisms may be demonstrated. As contrasted with procedures which depend upon continuous observations and eye-pieces bearing scales, he claims that his plan is suited for observations extending over several hours, and further, that by it, error consequent upon variations in the energy of individual organisms are obviated. In conclusion, it is stated that, by this means, pure cultures of organisms, differing in their powers of movement, may readily be obtained.

Methods of Investigating Oriental Sore.*—C. Nicolle and L. Manceaux give an account of their researches upon some cases of this condition occurring at Gafsa. The experiments were carried out at the Pasteur Institute at Tunis. *Leishmania tropica*, the causal organism, was isolated by puncture of some of these sores in the non-ulcerated stage, by means of a syringe needle or a capillary glass pipette. The material was inoculated into Novy-MacNeal tubes of the classical formula. At other times a simplified formula was used. These cultures were put into an incubator at 19°–23°, improvised from two biscuit boxes. After seven days, they were transported across the desert to the laboratory.

In order to obtain a pure culture it was necessary to paint the surface of the lesion with several applications of tincture of iodine. The organism grows at 20°–22°, rather more rapidly than the parasite of Kala-Azar. On the fourth day, flagellate forms appear, which begin at once to divide. There is luxuriant growth on the eighth to the tenth day. Soon the rosettes appear, and form masses just visible to the naked eye. Then the infusoria tend more and more to agglutination and immobilization, and the culture is dead at the end of two months. It was found possible, however, to keep the organisms alive by repeated subculturing. Cultivations were made on other media, but no important results were obtained. The microscopical appearances of this parasite differ in no way from that of Kala-Azar.

Rearing Sterile Flies.†—Eng. Wollman, in a contribution to the knowledge of the part played by microbes in the alimentary canal, gives the technique he adopted in rearing flies under sterile conditions. The eggs of *Calliphora vomitoria* sterilized in from 1–4 per 1000 sublimate, were placed on damped tufts of glass-wool, and then spread out by means of brushes. The glass-wool was then rolled up cylinder-wise, and the ends turned in. The whole was then tied up and placed in a tube, wherein it was exposed to alternate currents of sublimate and sterile water. The glass-wool was next placed in a Petri's capsule, the ligature was removed, and the mass unrolled. This done, the eggs were transferred one by one to tubes containing sterilized meat. Three kinds of controls were used. The cultivation tubes were tested from time to time, and those that were contaminated at once rejected.

* Ann. Inst. Pasteur, xxiv. (1910) pp. 673–80.

† Op. cit. xxv. (1911) pp. 79–88 (2 figs.).

Bacillus of Acne.*—H. F. Hartwell and E. C. Strecker find that *Bacillus acnes* is essentially an anaerobe. Under anaerobic conditions it grows well in all common media, but best on glycerin, agar. Slants inoculated by smearing pus on the surface show fair-sized colonies in from three to five days; the colonies are raised, greyish white, opaque. The bacillus is Gram-positive, and often has an irregular or beaded appearance: it is moderately wide; its length is variable, especially in cultures, where it frequently shows branching forms. It does not form spores.

(2) **Preparing Objects.**

Demonstrating the Structure of the Yeast-cell.†—H. Wager states that the best fixatives are Gram's iodine solution, Flemming's weak chromic acid solution, and Perenyi's fluid. The best stain is Heidenhain's iron-haematoxylin. The structure of the yeast-cell is best determined by means of sections, and the method is perfectly simple. A quantity of yeast is put into a tube about half an inch in diameter; it is then fixed and stained, and allowed to settle at the bottom of the tube; the supernatant liquid is decanted, and is replaced by up-graded alcohols and finally by turpentine or xylol. After a short time the xylol or turpentine is poured off; soft paraffin wax is added, keeping it melted at as low a temperature as possible until the yeast is impregnated with it. Then wax of a higher temperature is added, and finally the tube is cooled as quickly as possible. It is then broken gently, and the paraffin block with the contained yeast-cells removed. The block is then cut up, and the sections mounted in balsam for microscopical examination. In this way three sections of a single cell may be obtained.

Investigating Nature of Supposed Algal Coals.‡—E. C. Jeffrey worked with material softened by various treatments. In the case of cannel, or cannelard coal, the material was immersed in 70 p.c. alcohol saturated with caustic alkali, and incubated at 60°–70° C. The alkali was then removed by frequent treatment with hot alcohol, after which it was generally found expedient to treat for two or three weeks with strongest hydrofluoric acid. After washing out the acid, the material was embedded in the usual way in celloidin. Sections of about 5 micra thick were made. In the more resistant cannels, especially bogheads and oilshales, it was necessary to treat with aqua regia, and in some cases to replace the hydrochloric by hydrofluoric acid. It was sometimes advantageous to return the material to alkaline alcohol after treatment with acids; in such cases all the acid must be removed before the pieces are placed in alkaline alcohol, as otherwise they suffer disastrous swelling. After the sections are cut they are dehydrated in a mixture of alcohol and chloroform, in order to avoid softening the celloidin matrix; after clearing in benzol or xylol they are mounted in balsam. In a few instances it was found advantageous to mount in glycerin jelly. In dealing with serial sections, the best procedure is to lay the sections on a slide as they come off the knife, and then dehydrate and clear them in their order.

* Publications Massachusetts Gen. Hosp., iii. (1910) pp. 200–4 (4 figs.).

† Journ. Inst. Brewing, xvii. (1911) pp. 2–22 (3 figs.).

‡ Proc. Amer. Acad. Arts. and Sci., xlvi. (1910) pp. 273–90 (5 pls.).

(3) Cutting, including Embedding and Microtomes.

Injection Preparations of Petromyzon.*—B. Mozejko gives an account of his methods. The living fish is divided in two by a cut through the region of the abdomen. Most of the blood escapes through the cut ends of the large vessels, and gentle pressure is used to expel as much blood as possible. Cannulae with slightly enlarged extremities are introduced into the aorta, and into one of the great veins. A broad ligature is then placed near the cut surface, in order to keep the cannulae in position. The ligature must not be employed in such a way as to damage the tissues. By an injection into the aorta, so that the material is forced through to the veins, a single-coloured injection of the vascular system is effected. A two-colour preparation may be obtained by first injecting the veins. When the material so injected has solidified, the arteries may be injected. By means of another modification, a three-colour injection, distinguishing arteries, veins, and sinuses, may be obtained. After injection is complete, the preparations are placed, without removing the ligatures, into a fixing fluid which contains formalin. After fixation the ligatures are removed, and the preparations preserved. Portions may be embedded in celloidin, and serial sections cut. In previous communications, † particulars as to the materials suitable for injection have been given.

The author has combined these injections with the clearing methods recommended by Lundvall, by means of which semi-transparent preparations are obtained. In the application of this latter process to *Petromyzon fluviatilis*, it is necessary to bleach the highly-resistant pigment by means of prolonged application of free chlorine. This precludes the use of carmine or ultramarine in the injection material. Faint colours such as chrome-yellow are the most suitable.

Demonstrating Presence of Starch in a Leaf.‡—O. H. Latter exposes the leaf to sunlight for some hours, then boils in water for a few moments, and afterwards dissolves out the chlorophyll with methylated spirit. The alcohol is removed by means of water, and then the leaf is treated with iodine solution. The leaf is next immersed in benzol, which dissolves out the iodine from all parts except the blue starch-iodine compound. Hence the blue colour shows up plainly, being no longer masked by the yellow-browns of the cellulose and protoplasm.

Method of obtaining Sections of Urinary Calculi.§—S. G. Shattock, in his communication on the microscopic structure of uric acid calculi, gives the following account of the technique adopted.

The method consists in rubbing away half of the calculus on a file or on glass-paper, the final part of the grinding being carried out on a wet hone. In some calculi the nucleus is so differentiated as to readily allow of identification. This is, however, not always the case; one has to guard against the fallacy of mistaking the section of a zone around the proper nucleus for the nucleus itself, since both will present an

* Zeitschr. wiss. Mikrosk., xxvii. (1910) pp. 248-56.

† See this Journal, 1910, p. 257; Zeitschr. wiss. Mikrosk., xxvi. (1909) pp. 353-77, and 382; 1910, pp. 542-7.

‡ Knowledge, xxxiv. (1911) p. 59.

§ Proc. Roy. Soc. Med., Pathol. Section, iv. (1911. p. 111-12.

equally circular figure. This difficulty is usually surmountable by examining the wet surface of the grinding at intervals with a hand lens. When doubt still exists the only sure method is to grind the calculus in two planes, at right angles to each other, so as to obtain a sector consisting of a fourth of the whole; the centre can then be determined by its exposure in both planes.

After the process is completed, the ground surface is carefully washed and cleared of débris by allowing water to drop from a height through a cone of filter paper; the half of the calculus so prepared is excluded from dust and allowed to dry. It is, in the next place, cemented to a slide with solid Canada balsam, a fragment of which is heated on the slide over a spirit lamp until it melts; and in order to diminish the brittleness of the balsam, a small quantity of the ordinary mounting solution in xylol is first placed on the slide, the materials being mixed after heating by rocking the latter to and fro. The half of the calculus is now placed on the slide, the central portion of which is already covered with the melted balsam. A copious effervescence takes place from the under side of the calculus, owing to the expansion of the air in its interstices. The slide must now be turned over, so that the ground surface can be viewed, the calculus being moved about and gently pressed until no trace of air remains between the specimen and the glass. As soon as the balsam has set, the material is ground away from the convex side until the chief bulk has been removed. The last and most delicate part of the process is the grinding of the section to such a degree of thinness as to allow the light to pass through it. This is done, first on fine glass-paper, but completed on the hone with water. When the requisite thinness is reached, the surface is washed by allowing water to drop on to it through a cone of filter paper; lastly, when the section is dry, a xylol solution of balsam is placed on it and the cover-glass applied.

CAFFEYN, C. H.—**A Rock-grinding Machine for Amateurs.**

[Describes how to adapt a sewing-machine for making petrological sections and the method of preparation of a rock section.]

Knowledge, xxxiv. (1911) pp. 10-11 (3 figs.); pp. 74-5.

(4) Staining and Injecting.

Staining Blood-films.* — J. Sabrazès uses an aqueous solution of medicinal methylen-blue in dilutions of from 1:300 to 1:1000, customarily 1:500. Only the supernatant fluid is employed, and this is removed by means of a capillary pipette. The film must be well dried and fixed with osmic acid paper. The films may be counterstained with eosin. The eosin solution is made by mixing 5 c.cm. of a saturated solution of eosin (française pure) in 95 p.c. alcohol with 10 c.cm. of 95 p.c. alcohol.

Demonstrating the Presence of Mitochondria in Cartilage-cells.†
J. Renaut removes cartilage from the long bones of fœtal sheep as soon

* C.R. Soc. Biol. Paris, lxx. (1911) pp. 247-8.

† Comptes Rendus, clii. (1911) pp. 536-8 (2 figs.).

as possible after the ewe's death. The slice is placed in saline (0.8 p.c.) on a slide; at a short distance therefrom is made a mixture of artificial serum and of saturated aqueous solution of methyl-violet 5 B. The mixture is then run on to the cartilage. As soon as the slice of cartilage becomes violet, a cover-glass is imposed and ringed round with paraffin. In this way a preparation is obtained wherein the mitochondria are stained deep violet. When a cell is non-vacuolated the mitochondria are massed around the nucleus; if vacuolated they are scattered and isolated.

New and Quick Method for Staining Spirochætes in Smear Preparations.*—A. A. W. Ghoreyeb uses the following solutions: (1) 1 p.c. osmic acid; (2) Liq. plumbi subacetatis diluted one hundred times with distilled water; must be freshly prepared; (3) 10 p.c. aqueous solution of sodium sulphide. The smear is stained as follows: (1) cover with osmic acid solution for 30 seconds; (2) wash in water; (3) cover with lead subacetate for 10 seconds; (4) wash in water; (5) cover with sodium sulphide solution for 10 seconds; (6) wash in water. This process is gone through three times. Following this, the osmic acid solution is applied for thirty seconds, and then the specimen is washed in water, dried, and mounted in balsam. After the application of each solution the washing with water must be thorough. The illustrations are both good and instructive.

(5) **Mounting, including Slides, Preservative Fluids, etc.**

New Mounting Medium for Botanical Preparations.†—S. Bálint has devised a medium for mounting botanical specimens which has a refractivity equal to that of glycerin, or with glycerin-gelatin. It does not crumple up sections of soft vegetable tissue, and finally becomes so hard that ringing is unnecessary. It is composed of gum arabic 40 gm., loaf-sugar 60 gm., distilled water ad lib., glycerin 10 c.cm., acetate of potash 10 gm., lacto-phenol 10 c.cm., glacial acetic acid 10 c.cm. The gum arabic must be finely powdered, and a solution made which will filter easily; the loaf-sugar must be melted to prevent its tendency to crystallization; a thin solution is then made which is mixed with the filtered gum-solution, the acetate of potash is then added, and the mixture is then thickened in a water-bath. When the required inspissation is attained, the glycerin, lacto-phenol and glacial acetic acid are added. After the ingredients are thoroughly mixed, the medium is distributed into flasks, and these are immersed up to the neck in warm water and kept warm in a water-bath for some hours and then allowed to cool gradually. This procedure is necessary in order to get rid of air-bubbles, and it should be repeated on the following day. Finally, to every 200 c.cm. of the medium 6 drops of lacto-phenol and 10 drops of acetic acid must be added. The medium must be preserved in stoppered bottles. One of the recommendations of this new mounting medium is

* Publications Massachusetts Gen. Hosp., iii. (1910) pp. 367-9 (3 figs.).

† Zeitschr. wiss. Mikrosk., xxvii. (1910) pp. 245-7.

that it facilitates microscopical examination of unstained preparations even when quite thick, and in this respect is superior to glycerin or glycerin-gelatin.

(6) **Miscellaneous.**

Immobilizing Flies for Microscopic Investigation.*—In his investigation of Diptera, particularly of the genus *Drosophila*, A. Delcourt has made use of some simple devices (fig. 41), by which the activities of the animals may be arrested. For rapid identification he uses a glass tube flattened towards the middle (1, 2). The alteration in the lumen is shown by the diagrams of cross-sections. A small fly, sucked into this tube, becomes immobilized in the narrow part, and may then be examined under the binocular microscope. When identified, it may be blown out into the appropriate receptacle. The second piece of apparatus, which

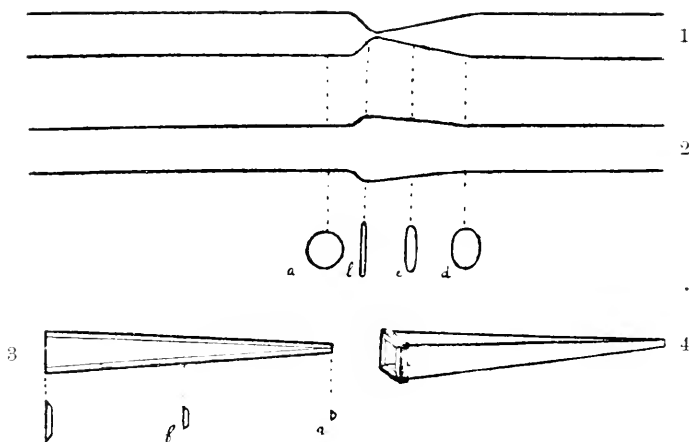

FIG. 41.

permits of a more detailed examination, consists of four glass plates (3), exactly alike, the apposition of which (4) forms a long, narrow, hollow pyramid. The fly is placed within this pyramid, at a level determined by its size, and while thus fixed may be examined from each side under a fairly high power. The plates are simply placed in juxtaposition, and secured by an elastic band. This is readily effected by the use of a metal matrix, which is withdrawn when the band is placed in position.

Anthrax Sterilization Process applied to Hides in Dry State.†—This process, devised by A. Seymour-Jones, is reported to be both very effective and innocuous to the hides. It consists in immersing the hides for 24 hours in a mixture of formic acid (1 p.c. of 90 p.c. strength), and

* C.R. Soc. Biol. Paris, lxx. (1911) pp. 97-8.

† Pamphlet printed for the author by Bradbury, Agnew and Co., Ltd. (Dec. 1910) 31 pp.

1 part mercuric chloride to every 5000 parts of water. On removal the hides are drained, and then transferred to a pit containing a saturated solution of common salt for about one hour, after which they are drained. For goat- and sheep-skins the quantity of formic-acid is less.

Self-regulating Siphon.*—W. H. Tait describes a self-regulating siphon which is simple in construction and very efficient in use. The U-tube bent out of ordinary $\frac{1}{4}$ -in. quill tubing, as shown in the illustration (fig. 42), is narrowed at the point A, and the small piece of glass rod C is drawn out so as to fit this constriction. The bulb B, sealed on to the top of this rod, floats on the surface of the water. The U-tube must be so fixed, that when the water is at the desired level the rod just fits into A, and so closes the exit. If the level of the water in the vessel D rises at all, the bulb is raised and the excess of water flows out through the siphon. A useful apparatus for laboratories when it is required to keep a continuous flow of water through a vessel in which the level must remain constant.

Filtering by Aid of the Centrifuge.†—R. Sabouraud and A. Vernes state that the difficulties of filtration are easily overcome by means of a centrifuge. They place porcelain bougie filters in the cups or buckets of a centrifuge; presumably within some glass vessel; as the authors remark that the apparatus is easily sterilizable. The bougies will stand 6000 revolutions a minute without breaking, and filtration is effected in a few minutes. For filtering organic fluids, a collodion sac is easily made by coating the internal surface of the bougie with collodion.

Polishing Metallic Preparations for Microscopical Examination.‡
In the final polishing of delicate metallic specimens for microscopic examination, it has been found impossible entirely to obliterate the scratches without destroying crystalline structure. If, however, the following methods are adopted, there will be few, if any, objectionable marks visible under a power of less than 800 to 1000 diameters, and all the perfection of structure will be preserved. After polishing with

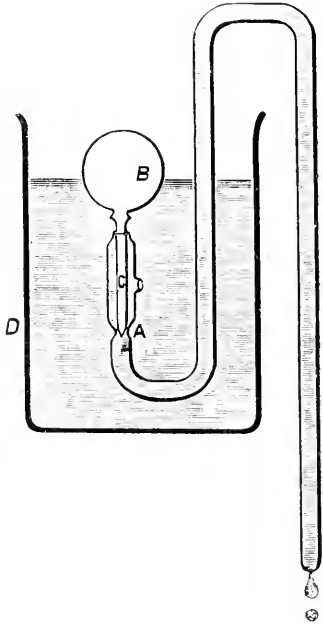

FIG. 42.

* Nature, lxxxvi. (1911) p. 45 (1 fig.).

† C.R. Soc. Biol. Paris, lxxix. (1910) pp. 620-1.

‡ Communicated by John Mastin, F.R.M.S.

various grades of emery, etc., with selvyt or other method, friction should be given with the ball of the thumb, following which rice-starch, previously ground to a very fine powder, should be rubbed on with medical (but not medicated) wool—such as the pure wool sold by the chemist. Where this is not practicable, a piece of soft razor-strop leather, or a strip of selvyt glued on a piece of smooth hard wood, may be employed, using the starch plentifully. The starch must be used so plentifully that it does not get heated. The writer has used both processes for a long time past in metallography with the greatest success.

Metallography, etc.

Aluminium-silver Alloys.*—W. Broniewski has determined the electrical conductivity, the temperature-coefficient of electrical resistance, the thermo-electric properties, and the E.M.F. of solution, of a series of aluminium-silver alloys. The curves expressing the results indicate the existence of the compounds Al_2Ag_3 and AlAg_3 . Confirmation was obtained by microscopical examination of the alloys.

Quenching of Bronzes.†—The softening effect of quenching cast-bronze from a suitable temperature appears to be due to the suppression of the decomposition of a solid solution. L. Grenet points out that if this explanation holds, subsequent re-heating of such softened material should cause an increase in hardness by bringing about the decomposition of the solid solution. Two tin-copper alloys, containing respectively 15 and 20 p.c. tin, were softened by quenching from 750°C ., and, as anticipated, the hardness was restored by subsequent re-heating at temperatures 100° to 400°C .

Bearing Metals.‡—A. Hague discusses the qualities desirable in bearing metals, and classifies the alloys used for this purpose as : (1) rigid bronzes ; (2) plastic white metals ; (3) plastic bronzes. The plastic white metals consist of hard grains embedded in a plastic matrix. In the third class, plasticity is imparted to the bronzes by the addition of 15 to 30 p.c. of lead.* The lead does not appear to alloy with the bronze, but to be held mechanically ; it exists in the bearing metal as veins of lead. The composition and properties of numerous anti-friction alloys are given, with much information on the best methods of employing them.

Behaviour of Copper towards Gases.§—A. Sieverts and W. Krumhaar have investigated the solubility, in solid and in molten copper, of oxygen, nitrogen, carbon monoxide, carbon dioxide, hydrogen, and sulphur dioxide. The behaviour of hydrogen points to the existence of a solid solution of hydrogen in copper.

* Comptes Rendus, cl. (1910) pp. 1754-7 (4 figs.).

† Op. cit., cli. (1910) pp. 870-1.

‡ Engineering, lxxxix. (1910) pp. 826-9.

§ Zeitschr. Phys. Chem., lxxiv. (1910) pp. 277-307 (4 figs.).

Ternary Systems.*—E. Jänecke deals with the theory of ternary systems, in which the equilibrium diagram shows a ternary transition-point. The lead-cadmium-mercury system is considered as an example, and photomicrographs are given to illustrate the author's conclusions.

Cementation by Gases.†—A. Portevin opens a general review of this subject, by pointing out that in industrial cementation the part played by solid carbon is probably quite insignificant, the cementation being effected almost wholly by gaseous carbon compounds. The study of the laws governing cementation by gases should therefore precede the investigation of the much more complex mechanism of cementation by solid materials. Gaseous cementation agents may all be regarded as following one of the three types: (1) carbon monoxide; (2) cyanogen; (3) the hydrocarbons. Each one of these, in presence of iron at a high temperature, is capable of decomposing into carbon and another gas. The laws governing the phenomena are the same in each case, and the author proceeds to work out in some detail the theory of the system $CO - CO_2 - C$, as a representative case.

A full account is then given of the extensive experimental work on cementation by gases carried out by Giolitti and his pupils.‡

Cementation of Steel.§—F. Giolitti and F. Carnevali record the results of experiments on the cementation of two steels, containing respectively 0.18 p.c. and 0.94 p.c. carbon, at different temperatures, the cementation media being ethylene, methane, carbon-monoxide, and other gases.

F. Giolitti and G. Tavanti|| describe a method of cementation by means of a mixture of carbon-monoxide and dioxide in equilibrium with carbon at the cementation temperature. By this method the sharp transition from a region of high-carbon content to a region of low-carbon content is avoided.

Cementation in a Vacuum.¶—F. Weyl summarizes previous work on cementation, and describes the experiments by which he has demonstrated the possibility of the cementation of iron by pure carbon. Small cubes of iron, prepared in an electric furnace, and containing 0.09 p.c. carbon, 0.3 p.c. manganese, were heated in a high vacuum at temperatures between 750° C. and 1050° C., in contact with one of the following varieties of carbon: sugar charcoal, Ceylon graphite, kish, and diamond powder. These materials had been previously carefully purified and heated for some time in a vacuum. Microscopical examination of the specimens showed that cementation had occurred when a sufficiently high temperature had been attained, but the smallness of the amount of

* Zeitschr. Phys. Chem., lxxiii. (1910) pp. 328-42 (24 figs.).

† Rev. Métallurgie, vii. (1910) pp. 859-85 (23 figs.).

‡ See this Journal, 1909, 1910, 1911.

§ Atti R. Accad. Sci. Torino, xlv. (1910) pp. 376-87, through Journ. Chem. Soc., xcvi. (1910) p. 616.

|| Tom. cit., pp. 539-63, through Journ. Chem. Soc., xcvi. (1910) pp. 780-1.

¶ Metallurgie, vii. (1910) pp. 440-56 (39 figs.).

carbon absorbed by the iron indicates that industrial cementation proceeds chiefly through the agency of gases.

Influence of Segregation on the Strength of Mild Steel.*—F. Wüst and H. L. Felsler have studied, in a very thorough manner, the segregation in basic Bessemer and open hearth steel containing about 0·07 p.c. carbon. Large and small ingots of each description of steel, weighing respectively 1000 kg. and 250 kg., were sectioned longitudinally, polished, and etched with copper-ammonium chloride; drillings for analysis were taken from sixty positions in each. Sulphur and phosphorus were found to segregate most; carbon, manganese, and copper to a lesser degree. While in the segregated regions the static tensile tests were little worse than those from the lower unsegregated parts, the impact bending tests gave much inferior results.

Gases in Commercial Steel and Iron.†—P. Goerens describes the method he has used for the extraction of occluded gas from steel. Fine drillings are heated in a vacuum at 900°–950° C. The results of numerous analyses of the gases extracted from basic Bessemer, open-hearth, and other steels, at different stages in their manufacture, are given.

Grain-size in Iron.‡—By heating pieces of steel wire containing 0·07 p.c. carbon at different temperatures for various lengths of time, A Joisten has confirmed Stead's statement that the greatest increase of grain-size in low-carbon steel takes place in the neighbourhood of 700° C. Curves are given showing the relation of dimensions of grain to length of time of heating at 400°, 500°, 600°, 700°, and 850° C.

Magnetic Properties of the Modifications of Iron.§—S. Hilpert questions the separate existence of β -iron, and also suggests that γ -iron may be magnetic at ordinary temperatures. The change in magnetic properties with temperature is continuous, and the thermal phenomena which are regarded as evidence of the existence of allotropic modifications of iron may be due to changes in specific heat accompanying loss of magnetic properties.

Iron-nickel Meteorite.||—W. Guertler combats the view taken by Fraenkel and Tammann,¶ that the iron-nickel alloy of which meteorites are composed is metastable. The peculiar structure of meteorites is held to be due to the extremely slow cooling they have undergone.

Historical Note on Recalescence.**—W. F. Barrett gives an account of the discovery of the recalescence points in iron and steel. The observation by G. Gore, in 1868, of the momentary elongation of an iron wire during cooling from bright incandescence, led the author to investigate the subject, and in 1873 the afterglow or recalescence was discovered.

* Metallurgie, vii. (1910) pp. 363–84 (59 figs.).

† Tom. cit., pp. 384–95 (2 figs.).

‡ Tom. cit., pp. 456–8 (14 figs.).

§ Zeitschr. Electrochem., xvi. (1910) pp. 390–4, through Journ. Soc. Chem. Ind., xxix. (1910) p. 760.

|| Zeitschr. Phys. Chem., lxxiv. (1910) pp. 428–42 (3 figs.).

¶ See this Journal, 1909, p. 785.

** Nature, lxxxv. (1910) pp. 235–6.

Theory of Hardening Carbon Steels.*—C. A. Edwards examines the available data relating to the hardening of carbon steels by quenching, in the light of the phase rule and the theory of alloys, and concludes that the hardening is due to the retention of the solid solution of carbide of iron in γ -iron. The theory that the hardening is the result of the retention of β -iron is held to be untenable. The suggestion is made that there is no constitutional difference between the so-called austenite and martensite, and that the apparent difference is due to the twinning of the γ solid solution crystals, caused by the mechanical pressure absorbed in suppressing the decomposition of this solution into α -iron and carbide of iron. The author's views met with both support and criticism in the discussion.

Hardening of Carbon and Low-tungsten Tool-steels.†—S. N. Brayshaw has submitted two varieties of steel to a lengthy series of experiments, the results of which are chiefly of workshop interest. Both steels contained about 1.15 p.c. carbon; one contained 0.5 p.c. tungsten, the other no tungsten. Heating and cooling curves, with different rates of change of temperature and different maximum temperatures, were taken; the effect of each variable is considered. The range of temperature within which the best results could be obtained in hardening, was determined. The effect upon physical properties of variations in temperature of the steel before quenching and of the quenching medium was investigated, as well as the effect of length of time of heating.

Slag in Steel.‡—Matweieff, continuing on the lines of his previous work,§ has investigated the metallographical characteristics of the phosphates of calcium, magnesium, manganese, and iron, and calcium ferrite. All these bodies may occur in basic Bessemer steel as intermixed slag. The compounds, either singly, or mixed with each other or with oxides, were enclosed in small hollow cylinders of steel closed with steel plugs; the cylinders were then heated to 1300° C. After cooling, transverse sections were cut and polished, so that both the envelope and the juxtaposed contained matter could be examined. Calcium phosphate did not melt, and had no action on the steel envelope. The other three phosphates were reduced by the iron, and some phosphide of iron was formed. As a result of this work, three new etching reagents are recommended: 1. A 2 p.c. solution of ammonium oxalate, which slowly attacks cementite in the cold, giving a red coloration after 30 minutes. 2. A boiling solution of neutral sodium picrate, which colours phosphide of iron after 30 minutes, leaving cementite, ferrite, the solid solution of phosphide of iron in iron, and pearlite, unaffected. 3. A 2 p.c. solution of ammonium carbonate; in specimens heated in this reagent for 20 minutes on a water-bath, the slags formed in dephosphorizing are disintegrated, while the metallic surface is

* Journ. Iron and Steel Inst., lxxxii. (1910) pp. 147-96 (17 figs.).

† Proc. Inst. Mech. Eng. (1910) 2, pp. 517-710 (62 figs.).

‡ Rev. Métallurgie, vii. (1910) pp. 848-58 (27 figs.).

§ See this Journal, 1910, p. 794.

unaffected. A scheme for the metallographical identification of the compounds occurring in slags found in iron and steel, is outlined, the appropriate reagents being given in tabular form.

Action of Mercury on Steel at High Pressures.*—In the course of an investigation of the thermal properties of mercury and water under high pressure, P. W. Bridgman found that hollow cylinders of hardened steel burst at very much lower than the natural bursting pressure when the fluid exerting the pressure was mercury. That this rupture was due to the amalgamation of the steel was evident from the appearance of the fracture. It was found that the fractured surface of steel broken under mercury was amalgamated. Any exposure to air before contact with mercury completely prevents amalgamation. The explanation advanced to explain the bursting of the pressure cylinders, involves the initial amalgamation of the steel permitted by its state of elastic strain. The rapidity with which the amalgamation spreads is greatly increased by the action of hydrostatic pressure.

Influence of Silicon on Cast Iron.†—A. Hague and T. Turner have studied seventeen alloys containing 2.3 to 2.9 p.c. total carbon, the silicon content increasing from 0.03 to 4.83 p.c. The molten alloy was cast in a mould giving a bar of circular section, and simultaneous observations were made of time, temperature, and change in length. Sections of the bars were examined microscopically, and mechanical tests were made. The pearlite arrest-point was gradually raised from 700° to 800° C. by the silicon additions, which also raised to a smaller extent the temperature of final solidification, from 1130° to 1160° C. The temperature of commencing solidification appears to be lowered by increasing silicon.

Manganese in Cast Iron.‡—H. I. Coe has measured the changes in length which occur in cast bars of iron-manganese-carbon alloys during cooling from the molten state. Simultaneously with these measurements, time-temperature cooling curves were taken. Hardness measurements were made on the cast bars, which were also microscopically examined. The forty-eight alloys studied are divided into two series, the first being prepared from pure white cast iron, the second from grey cast iron containing 2.45 p.c. silicon. Manganese increased from 0 to nearly 40 p.c. In the white iron series the temperature of commencing solidification was lowered by manganese, but the eutectic freezing point was not affected up to 20 p.c. manganese. An alloy containing 4 p.c. carbon, 26 to 28 p.c. manganese, 68 p.c. iron, appeared to be a pure eutectic, with its freezing point 15° C. below that of the eutectic of the pure iron-carbon system. The Ar1 temperature was lowered by about 20° C. for each 1 p.c. of manganese; this arrest gradually diminished in intensity, disappearing at about 10 p.c. manganese. In the grey iron

* Proc. Amer. Acad. Arts and Sciences, xlv. (1911) pp. 325-41 (9 figs.).

† Journ. Iron and Steel Inst., lxxxii. (1910) pp. 72-104 (25 figs.).

‡ Tom. cit., pp. 105-46 (25 figs.).

series the results obtained were somewhat different. The manganese had no appreciable effect on the relative proportions of graphitic and combined carbon until 3 per cent. was present. With higher percentages the combined carbon increased at the expense of the graphitic; some graphitic carbon remained, however, with 17.5 p.c. manganese.

Fixing Objects to Stage.*—O. Wawrzyniak describes a clamp for holding specimens. The clamp is screwed to the microscope stage, has a levelling arrangement for adjusting the level of the polished surface, and has been found useful for holding large objects such as ancient gun-barrels.

Photomicrographic Apparatus.†—F. Robin describes a number of modifications which he has introduced into the Le Chatelier apparatus. The objective is pointed downwards, and below it on the stage is placed the section with its polished face uppermost. The stage has movements vertically, and in two directions horizontally; its level may also be adjusted through large angles, and it is capable of carrying large and heavy pieces of metal. The apparatus rests on felt, which is more effective than rubber in deadening vibrations. The source of light is an arc, with carbons set at right angles; the positive carbon remains in the optical axis, and the crater does not alter its position. All examination is carried out upon the image projected on the ground glass screen of the camera. The focusing movements, as well as the other stage movements, are controlled by means of four horizontal rods, the free ends of which are below the focusing screen. Oblique illumination may be secured by moving the condenser and using a small mirror; transparent objects may be viewed by transmitted light. The author points out that examination by oblique light supplements most usefully the usual examination with vertical illumination; examples illustrated with photomicrographs are given. The application of micro-chemical analysis in metallography is discussed; methods and examples are given. A minute quantity of a solution, obtained by placing a drop of an acid or other reagent on a clean surface of the substance to be examined, is treated with reagents on a glass slip; the products of the reactions are observed microscopically.

Sulphurous Acid as an Etching Medium.‡—S. Hilpert and E. Colver-Glauert, in searching for an etching reagent having a purely chemical action on iron and steel, have found that sulphurous acid may be used with highly satisfactory results instead of the numerous diverse etching media proposed for developing the structure of hardened steel. The action of these reagents, many of which are complex mixtures of organic bodies, is little understood. A useful strength is a 3 to 4 p.c. solution in water of a saturated solution of sulphur dioxide in water, free from sulphuric acid. Etching is complete in from 7 seconds to 1 minute.

* Metallurgie, vii. (1910) pp. 312-13 (4 figs.).

† Rev. Métallurgie, vii. (1910) pp. 903-20 (23 figs.).

‡ Journ. Iron and Steel Inst., lxxxii. (1910) pp. 54-64 (9 figs.) See also Zeitschr. Anorg. Chem., lxxviii. (1910) pp. 63-8.

An alcoholic solution may be used, but is slower in action. The action of the reagent appears to be essentially the formation of films of sulphide of iron, and as different constituents are acted upon with varying rapidity, they become coated with sulphide films of different thickness. Photomicrographs of steel, in which the authors claim to have developed the structure better with their new reagent than with any other, are given. Sulphurous acid is not suitable for steels composed of ferrite and pearlite, but is an excellent reagent for all other steels and pig irons.

Fatigue of Metals.*—J. H. Smith describes a method for determining a series of yield ranges by experiment on a single specimen. Numerous results obtained on different classes of steels, lead him to conclude that if a material be subjected to stress alternations of high periodicity and of fixed range, and compressive or tensile mean stress be gradually applied, a yielding condition will be found at a definite value of the applied mean stress.

Measurement of Hardness.†—G. Baume describes a dynamic method of applying the Brinell test. The apparatus consists of a weighted rod, suitably guided, holding at its lower end a hardened steel ball. The impression made by a known weight of rod and height of fall on a polished specimen is measured.

Viscous Flow in Metals.‡—E. N. da C. Andrade has devised a method of loading a wire in tension in such a manner that the stress remains constant however the wire may contract laterally on stretching. By loading wires of lead, a lead-tin alloy, and copper in this way, the author has demonstrated that, beyond the elastic limit, the extension after some time becomes proportional to the time, or the flow becomes viscous in character. The flow is purely viscous right up to breaking.

Electrical Conductivity of Molten Alloys.§—K. Bornemann and P. Müller have determined the electrical conductivity, at different temperatures, of numerous alloys belonging to the binary systems sodium-potassium, tin-lead, mercury-sodium, mercury-potassium, and others. It is shown that indications of the presence of compounds in molten alloys, and of the degree of dissociation of such compounds, may be obtained from concentration-conductivity curves. The temperature at which the separation of a homogeneous liquid alloy into two phases takes place is characterized by a change in direction of the conductivity-temperature curve, and may accordingly be determined by measurements of conductivity at different temperatures.

Temperature Co-efficients of Electrical Resistance.||—A. A. Somerville gives curves showing the variation of resistance of nickel, tungsten, molybdenum, and an alloy named nichrome, in the range of temperature 0°–1060° C.

* Journ. Iron and Steel Inst., lxxxii. (1910) pp. 246–318 (37 figs.).

† Archives des Sciences Physiques et Naturelles (Geneva) xxx. (1910) pp. 418–20.

‡ Proc. Roy. Soc., Series A, lxxxiv. (1910) pp. 1–12 (7 figs.).

§ Metallurgie, vii. (1910) pp. 396–402 (5 figs.).

|| Physical Review, xxx. (1910) pp. 532–4, through Science Abstracts, Sect. A, xiii. (1910) pp. 448–9.

Microscopical Examination of Blast-furnace Slag.* — H. Passow indicates the great value of microscopical examination of blast-furnace slag for determining its suitability for making Portland cement. Vitreous slag is required for this purpose, and while chemical analysis fails to distinguish between vitreous and non-vitreous slags, microscopical examination of crushed particles gives the required information.

DUCELLIEZ, F.—**Cobalt-silver Alloys.**

Procès-verbaux des séances de la Société des Sciences physiques et naturelles de Bordeaux, 1909-10,
pp. 46-8.

„ „ **Cobalt-zinc Alloys.**

Tom. cit., pp. 102-11 (1 fig.).

PEIRCE, B.O.—**The Resistivity of Hardened Cast-iron as a measure of its Temper and of its Fitness for use in Permanent Magnets.**

Proc. Amer. Acad. Arts and Sciences, xlv. (1910)
pp. 185-204 (10 figs.).

„ „ **The Magnetic Permeabilities at low Excitations of two kinds of very pure soft Iron.**

Tom. cit., pp. 207-12.

VIGOUROUX, E.—**Nickel-silver System.**

Procès-verbaux des séances de la Société des Sciences physiques et naturelles de Bordeaux, 1909-10, pp. 44-5.

VIGOUROUX, E., & A. BOURBON—**Mutual Action of Nickel and Zinc.**

Tom. cit., pp. 95-102 (1 fig.).

* *Stahl und Eisen, xxx. (1910) pp. 989-93 (3 figs.).*

PROCEEDINGS OF THE SOCIETY.

MEETING

HELD ON THE 15TH OF FEBRUARY, 1911, AT 20 HANOVER SQUARE, W.,
H. G. PLIMMER, ESQ., F.R.S., ETC., PRESIDENT, IN THE CHAIR.

Before calling upon the Secretary to read the Minutes, the President expressed his desire to thank the Council and Fellows of the Microscopical Society for doing him the honour of electing him as their President. The dynasty of the Presidency had been changed from Zoology to that of Pathology, and he would use his best endeavours to see that the high position of the Society should suffer no loss from the change. It would be his very great privilege to do all that lay in his power to advance the welfare of the Society.

The Minutes of the Meeting of January 18 were read and confirmed, and were signed by the President.

The List of Donations received since the last Meeting was read as follows, and the thanks of the Society voted to the donors :—

S. O. Mast, Light and the Behaviour of Organisms ..	<i>The Publishers.</i>
Old Microscope by J. Simons	<i>The late Council.</i>

In presenting the Microscope, Mr. Rousselet, Curator of instruments, stated that it was made by J. Simons. The date of the Microscope was about 1790 to 1800, and it bore a very close resemblance to instruments made by George Adams about the year 1780. The body was large, and the limb was a triangular bar hinged to a pillar with folding tripod foot. The whole Microscope was made of brass, and was very massive. The stage was rectangular and carried a lens below, mounted in a tube. The Microscope would be a very useful addition to the Society's collection of old instruments.

The thanks of the Society were accorded to Mr. Rousselet for his description.

Mr. Lees Curties then exhibited a new dark-ground illuminator which he had recently made for Mr. Nelson, and said that Mr. Nelson, who in 1884 * strongly recommended the Fellows of this Society to use a dark ground for viewing bacilli, had frequently told him that he had

* See this Journal, 1884, p. 497.

always found a dark ground produced by a condenser and stop preferable to that obtained by any paraboloid or similar apparatus. He attributed this to the more perfect concentration of rays, that is the aplanatism of the condenser.

A short time ago he also pointed out that there was considerable difficulty in the employment of any of the condensers he had owing to the different thicknesses of the glass slips now in use; building them up by means of slip equalizers being an intolerable nuisance; and he asked Mr. Curties if he would undertake to construct a new illuminator if he worked out the formula. This Mr. Curties consented to do, and the one exhibited that evening had just been made in strict accordance with the formula Mr. Nelson had sent him. He supplied Mr. Nelson with the measurements of a large number of slips as now used by mounters, and the condenser was constructed so that it would work with those ranging from 0·8 to 1·2 mm. He had tested it upon diatoms and bacteria, and found that it gave a perfectly dark field with a Zeiss Apo. 4 mm. of 0·95 N.A. Bacilli were brightly shown with great sharpness on a velvety dark ground, and they were sufficiently well illuminated for deep eye-pieces to be used. It was fitted with a fixed central stop, but if wished a slot could also be used, and this turned the apparatus into a very oblique illuminator suitable for resolving the finest ruled bands or diatomic striæ: *Amphipleura pellucida* was quite easily resolved with a $\frac{1}{2}$ th of N.A. 1·30. A small dot had been placed upon the front lens for the purpose of centring the condenser to the optical axis of the objective; without some such plan there would be trouble in getting it centred. It was fitted with the Society's screw, so that it would readily fit the usual substage adapters.

The President said that the lenses did not seem to him to be achromatic.

Mr. Curties replied that they were not, but merely two single lenses.

The thanks of the Society were accorded to Mr. Curties for his communication.

The President then called upon Messrs. Heron-Allen and Earland for their paper, and also referred to the microscopical preparations of Foraminifera exhibited in the room.

Mr. Heron-Allen in his preliminary remarks said that some poet had said that "the best of friends must part." He was now in the hard position of one about to take a formal leave of the Fellows of the Society prior to his embarking with Mr. Earland upon some years of research work upon the 'Goldseeker' dredgings from the North Sea, and it was his desire to express their joint thanks for all the favours they had received in the past. There were several, he felt, to whom their most heartfelt thanks were due: first of all he wished to thank the Council for always having allowed them practically unlimited space in the Journal for the publication of their papers; then the Treasurer for his liberality in the matter of printing their plates. He considered that more than an ordinarily wide latitude had been allowed them in the matter of illustrations; he had often after handing in the MS. and

plates of their papers, avoided the eye of the Treasurer for some time. He had, however, always been met with a smile, and so had taken heart of grace.

He wished to thank Mr. Herbert R. Lilley for the enormous amount of care he had taken in making the drawings which had appeared in the Journal, and to Mr. A. E. Smith who had made the photographs for the lantern slides prepared by Mr. J. A. Lovegrove. Also to Mr. H. F. Angus, who had taken charge of the exhibitions, and supplied Microscopes and superintended the exhibitions of lantern slides. This last expression of gratitude was really very heartfelt, for he fully realized that nothing could be more disconcerting to a lecturer, after announcing a slide of a particular species of Foraminifer, than to be confronted with a slide, say of the Crystal Palace upside-down; this, in principle, did not uncommonly happen to lecturers, but it had never happened at the meetings of the Royal Microscopical Society.

He might say that the study of this branch of Rhizopod life was never ending. He remembered many years ago he had been in the studio of the late Lord Leighton, and he had asked him when a certain picture, then in process of being painted, would be finished. The answer had been "No picture worth painting was ever *finished*." He had over and over again been reminded of this remark in the course of his present enquiry—it could never be finished. Only last Saturday he and Mr. Earland had said (without any desire to be slangy), "We will now put the lid on this study," and there were already two shells upon a query slide to which they could assign no place at present, and which were awaiting determination.

He might observe that two years ago they had received from Mr. E. Heath a couple of tubes of dredgings from the Somali coast, containing recent *Fronidicularia*, which they had not yet looked at; it would be realized from this with what heart-whole ecstasy they had devoted themselves to the shore-sands of Selsey Bill, in which they had now discovered no less than 399 different species. In quoting this number he was reminded of the story of the man who said he had killed 399 wild duck at one shot, and when he was asked why he did not make it 400, had answered, "Shall I imperil my immortal soul for the sake of one miserable duck?" He might make the same answer in regard to their 400th species—they had not found it.

They were that evening exhibiting the most striking species to be included in a supplement of the rarer types that had been found in the sands since they had first commenced their researches. As would be readily understood, a great many had been found out of their proper order, and they were now included in this supplement. There were also, besides the Selsey Foraminifera, one or two other slides of exceptional interest to which he would draw attention in due course. When too, the specimens found at Selsey were etiolated or had been damaged, or were in other respects inferior, a point had been made of showing specimens *on the screen* from other localities which gave a typical representation of the perfect species, so that the necessity of explaining what parts were missing and what parts were imperfectly demonstrated might be avoided.

The authors called attention to the identity of the fossil Foraminifera

of the Bracklesham beds with the living species found in Australian shore-sands. Recent specimens of *Bolivina Durrandii* (Millett) and *Pulvinulina vermiculata* (Brady) were shown, the only other known records being, as regards the former, from the Malay Archipelago, and as regards the latter, from tropical and sub-tropical seas. In addition to these, *Miliolina suborbicularis* and *rotunda*; *Tertularia inconspicua* var. *jugosa*; *Uvigerina asperula*; and *Sagrina dimorpha* were recorded as new to Britain. Schlumberger's hitherto unique genus and species, *Linderina brugesii*, was recorded from the Eocene clays of Selsey. Also the fossil records of *Bulimina subteres* and *Discorbina polystomelloides*. The new species recorded were *Pulvinulina haliotulea* (H.-A. and E.) and *Nonionina quadriloculata* (H.-A. and E.). Specimens of these were exhibited under Microscopes on the table.

On the conclusion of the lecture and demonstration the President said that it was hardly a subject that lent itself to discussion, and as no remarks were forthcoming on this most interesting paper, it only remained for him to congratulate Mr. Heron-Allen and Mr. Earland on the extent and importance and beauty of their work.

He gathered that they were giving up Selsey Bill for the North Sea, and he hoped that they would there be equally successful in the result of their researches. He was sure that all would wish to return a very hearty vote of thanks for the interesting paper and for the beautiful specimens exhibited and lantern slides shown, which had helped to render the lecture so clear to those who, like himself, knew but little of its particular subject.

The vote of thanks was carried with acclamation.

Mr. Heron-Allen thanked the Fellows of the Society for the way in which they had listened to him, and hoped that in years to come, when they had to some extent completed the North Sea investigations, the same kindly attention would be accorded them.

Owing to the late hour the paper by Mr. E. M. Nelson on "Some New Objectives and Eye-pieces, by R. Winkel, of Göttingen," was postponed till the next Meeting.

The next Meeting was announced for March 15, when Dr. Ralph Vincent would give a demonstration on the "Morphology of the Organisms concerned in the Production of Acute Intestinal Toxæmia in Infants," and Mr. F. W. Watson-Baker would read a paper, entitled "Anomalies in Objective Screw Threads."

The following Instruments, Objects, etc., were exhibited:—

Messrs. Heron-Allen and Earland exhibited a number of rare and interesting species of Foraminifera from the Shore-sands of Selsey Bill, Sussex.

Mr. Lees Curties:—A New Dark-ground Illuminator, made for Mr. Nelson.

MEETING

HELD ON THE 15TH OF MARCH, 1911, AT 20 HANOVER SQUARE, W.,
H. G. PLIMMER, Esq., F.R.S., ETC., PRESIDENT, IN THE CHAIR.

The **Minutes** of the Meeting of February 15th were read and confirmed, and signed by the President.

The following Donation received since the last Meeting was announced, and the thanks of the Society voted to the donor:—

From

T. H. Blakesley, Geometrical Optics. (Svo, London, 1903) .. *Mr. E. M. Nelson.*

Dr. Ralph Vincent, in his preliminary remarks to his demonstration on "The Morphology of the Organisms concerned in the Production of Acute Intestinal Toxæmia in Infants," said that he felt considerable diffidence in giving this demonstration before the Society. But a member of the Council had urged him to do so, and he had accordingly yielded. Before dealing with the main subject of his demonstration, he wished to acknowledge his great indebtedness to his friend and colleague, Mr Robert Mond, Treasurer of the Infants Hospital. The Research Laboratories at this Hospital had been established and maintained entirely at Mr. Mond's expense, and when he said that practically all his work in connexion with this particular research had been carried on in these laboratories, his reference to Mr. Mond would be readily understood.

Before showing the series of lantern-slides illustrating the various organisms concerned in the production of acute intestinal toxæmia in infants, he wished briefly to explain the nature of the disease so produced, referring those who desired a fuller and more detailed account to his address given on the subject before the Glasgow Obstetrical and Gynæcological Society in November of last year.* Those who had had experience in dealing with the diseases of infants were only too familiar with the high rate of mortality occurring in hot summer weather among babies. In the year 1904 (the extreme example in recent years of a hot and dry summer) there were many towns where in the three months, July, August, and September, nearly one half of the babies died. Of 1000 infants living on June 1, nearly 500 had died by October 1. If the breast-fed infants were eliminated, and the enquiry was confined to bottle-fed babies, the mortality was found to be appalling. The difficulties in grappling with the problems of this disease arose largely from the fact that it was officially described as "epidemic

* On Acute Intestinal Toxæmia in Infants: an Experimental Investigation of the Etiology and Pathology of Epidemic or Summer Diarrhœa. London, 1911.

diarrhœa," and erroneously regarded as an infectious disease. It was not an infectious disease, and it could not be spread by contagion. It had been ascertained that no breast-fed infant, even amid the most insanitary surroundings, ever contracted the disease. At the Infants Hospital no attempt at isolation was made in the case of an infant suffering from the disease, nor had any infant contracted the disease there, the simple reason for this being that all the babies were fed on raw milk. The organisms producing the disease could not live in raw milk—nor in any acid medium. They were the ordinary organisms of putrefaction, capable of living on any protein matter, and by their metabolic processes speedily produced powerful poisons—the alkaloids. The history of the disease in infancy would be found to be that the baby had been fed on cooked milk, so that the lactic organisms had been destroyed. The typical raw milk organism—the *Streptococcus lacticus*—was extremely delicate. Growing in pure culture in its most favourable medium, it will die in the course of about a fortnight. The *Bacillus acidi lactici* behaves in the same manner. The *B. bulgaricus* would live for a little longer—about a month.

Dr. Vincent then showed photographs of the various organisms stained, unstained, and taken during life. The organisms included the *B. subtilis*, the *B. mesentericus*, "No. 7," the *B. mesentericus vulgatus*, and the *B. proteus vulgaris*. Photographs were also shown of the *Streptococcus lacticus*, the *Bacillus acidi lactici*, and the *B. bulgaricus*.

Dr. Vincent then proceeded with the main subject of his lecture.

Dr. E. J. Spitta said he would like to congratulate the lecturer on his beautiful photomicrographs, let alone his extremely interesting lecture. The essence of success in taking this type of photograph was in correctly suiting your screen to the dye employed as a stain for the bacteria. If too contrasting a screen were employed, then too hard results were obtained, whilst with too little contrast in your filter flat and dirty negatives resulted. He did not know if the lecturer happened to employ the screens made by Dr. Mees—they were sold by Wratten and Wainwright, of Croydon—for with these any class of monochromatic light could be obtained from one end of the spectrum to the other, and any depth of contrast also. If he did not happen to know of these filters he felt sure he would be pleased with their use.

The only point at which he found himself at variance with Dr. Vincent was in the advantage gained by the employment of the extremely high magnifications he both showed and recommended. Directly magnification, when using an objective of N.A. 1.40, exceeded 1000 diameters there was necessarily a gradual falling off of defining power, owing to the presence of diffraction phenomena, the circle of confusion slowly becoming greater than $\frac{1}{100}$ in., and the more the magnification was increased the greater the fuzziness obtained. The reason of this was not far to seek, but as he had dwelt upon that subject at some length elsewhere he would not say more about it. If, however, the primary magnification did not render the image sufficiently large for seeing with comfort—that is to say, without the use of a magnifying glass—then it was very profitable to enlarge the negative, for by so doing the details, although not increased in number or refinement, would be rendered more easily seen

and hence the better appreciated, as indeed obtained in every-day practice when using the projecting lantern (see footnote).

He could not conclude, however, without once more expressing his congratulation to the lecturer, not only upon his photographs, but quite as much if not more upon his neat and explicit way of rendering a somewhat recondite subject both interesting and intelligible, he felt sure, to those present, many of whom were not doctors as they were themselves.

Mr. Shillington Scales said he had found Dr. Vincent's paper of exceeding interest, especially as it had been somewhat off the beaten track of microscopic work such as they had at their usual meetings. There were many points of clinical interest which had struck him, a discussion on which, however, did not come within the scope of the Microscopical Society.

Without reflecting in any way on the beautiful photographs which they had seen, he wished to endorse in every way Dr. Spitta's remarks on high magnification. In his experience high power magnification most emphatically proved to be a loss and not a gain to all photographs. He did not consider that there was any use for a magnification of 8000 diameters in skilled microscopy, and it was with some surprise he had heard a murmur of applause follow the exhibition of a photograph taken with this enlargement. Every objective possessed a certain resolving power, and needed a certain magnification to make this resolution visible, but beyond this no advantage was to be gained from mere empty magnification, but rather loss. He thought in this statement he would be supported by every photomicrographer present.

Dr. Vincent thanked the members of the Microscopical Society for the kind manner in which they had received his demonstration. He quite agreed that magnifications at more than 2000 diameters were seldom required. In some exceptional cases a magnification of 4000 diameters

Footnote by Dr. Spitta added after the Lecture.

The diameter of the disk of confusion is quite easily obtained; only two things are necessary: (1) to find the resolution, and (2) to multiply such by the magnification. Take the first. This is obtained by Abbe's law, "Multiply twice the number of waves to the inch of the light employed by the numerical aperture of the objective." As, for example, say the light used has 47,500 waves to the inch; twice that is 95,000; and so if the N.A. be 1.40, the resolution is 133,000, which means that any two lines $\frac{1}{133000}$ in. apart can theoretically be separated if oblique illumination be employed. Presuming our 1000 diameter magnification, the circle of confusion is obviously $\frac{1}{133000}$, equal to $\frac{1}{133}$ in. less than the conventional limit. Make the magnification 2000, and immediately the circle of confusion rises to double the size, and so on. Raise the magnification (of course, this presumes the N.A. is not added to), and the fuzziness becomes intolerable. Careful enlargement of the primary negative, however, with equally careful development, will be of service because, although the image is enlarged, the diffraction effects remain the same; but no further details are added, although perhaps one may be able to see more on account of their increase of size.

was indicated. His photographs of the *Bacillus proteus vulgaris* showed clearly that the tangle of flagella at a certain point was not resolved till this magnification had been reached. He had expressly stated, before showing the photographs at 8000 and 24,000 diameters, that they were of no use as photographs. He quite agreed that they showed nothing that the lower magnification did not show. He would go further and say that they certainly did not show so much. But these photographs had been taken from an entirely different point of view. In his opinion, the most practical test that could be applied to an objective was photomicrography at extremely high magnifications. The indifferent objective would break down under this test altogether. According to the degree of success obtained the objectives could be appraised in regard to their accuracy. From this point of view, the testing of the objective, he considered photography at high magnifications of great value. He could not accept Dr. Spitta's suggestion in regard to enlargement. That, in his opinion, was not photomicrography.

The President said he desired to add his congratulations to those of Dr. Spitta and Mr. Scales to Dr. Vincent for his valuable paper. Knowing, as he did, the other side of the work for which the specimens were made, he could say that the beautiful preparations shown to them formed the least important part of Dr. Vincent's work. He returned him a most hearty vote of thanks for his excellent paper, which was carried with acclamation.

Mr. F. W. Watson Baker read a paper on "Anomalies in Objective Screw Threads."

Mr. Shillington Scales said they were greatly indebted to Mr. Watson Baker for his paper. The Microscopical Society not infrequently had been blamed in connexion with its gauges, he thought in the main undeservedly, and at the present time certain points dealt with by Mr. Watson Baker were under discussion. But Mr. Baker had shown how exceedingly erratic various makes of objective screw-threads were, and his paper would prove a most valuable object-lesson to those workers who, in using various makes of objectives, found themselves held up by a screw thread which would not fit the Microscope. Mr. Baker's suggestions deserved most careful consideration.

The President thanked Mr. Baker, in the name of the Society, for his paper, and hoped that some practical use would be made of his valuable suggestions.

The thanks of the Society were accorded to Mr. Baker for his paper.

Mr. Shillington Scales read a paper by Mr. E. M. Nelson on "An Objective Mount with an Iris."

Mr. Shillington Scales said that it was difficult to take in all the subject matter of a paper read rapidly, but he would like to call attention to two points which had struck him. Mr. Nelson had apparently suggested the measuring of objects by shutting down the numerical aperture until the object became invisible. To him this seemed a startling proposition. Though an objective of a given aperture was theoretically capable of dividing a certain number of lines, this was not the same thing as seeing more widely separated objects of minute size,

and even if we had a means of telling how far the aperture of the objective had been reduced by stopping down, there would be a considerable margin of error in endeavouring to determine the size of objects by such means.

The other point which had struck him was in connexion with Mr. Nelson's remarks on the dark-ground illuminator: "Owing to defects in some dark-ground illuminators it is not possible to obtain a dark field when the objective has a wide angle."

He considered that this statement might be criticized. The whole principle of the dark-ground illuminator was that the total aperture of the illuminator should exceed that of the objective, a central cone being blocked out, so that with annular illumination of wide angle from the illuminator refracted rays from the object would alone enter the objective.

A second paper by Mr. E. M. Nelson on "Some New Objectives and Eye-pieces by R. Winkel of Göttingen," as well as another by the same author on "The Variable Microscope," were read by Mr. Shillington Scales.

No remarks being offered on these communications, the President returned the thanks of the Society to Mr. Nelson for his papers.

Owing to the lateness of the hour the paper by Señor Dominga de Orueta on "Apparatus for Photomicrography with the Microscope standing in any Position, especially in Inclined Position," was postponed till the next Meeting, and Mr. James Murray's paper on "Australian Rotifers, collected by the British Antarctic Expedition, 1909," was taken as read.

A letter from Mr. F. W. Gordon was read by Mr. Shillington Scales, enclosing a cheque for £5 as an expression of his sympathy with the proposal which had been made by their Ex-President to supply the Microscopical Society with a fitting number of show cases for their exhibits, and promising a further subscription if the late President's other suggestion, to acquire a really typical collection of slides that can be used by those desiring information, be carried into effect.

Mr. Shillington Scales hoped that Mr. Gordon's donation would have the effect of stimulating other Members of the Society to follow his excellent example.

The next Meeting was announced for April 19, when a paper would be read by Mr. E. J. Sheppard, on "The Reappearance of the Nucleolus in Mitosis," and Mr. E. J. Spitta would give a demonstration of "Low-power Photomicrography with Special Relation to Colouring Methods."

The following Instruments, Objects, etc., were exhibited:—

Mr. W. R. Traviss:—Two Objectives, $\frac{1}{2}$ in. and $\frac{1}{4}$ in. with iris, described in Mr. Nelson's paper.

New Fellows:—The following were elected *Ordinary* Fellows of the Society:—Sidney Howard Browning, Francis Martin Duncan, Robert Ludwig Mond, H. E. Ranken, Alfred J. Sewell, Mrs. Rose Haig Thomas, Dr. Ralph Vincent, Professor German Sims Woodhead.



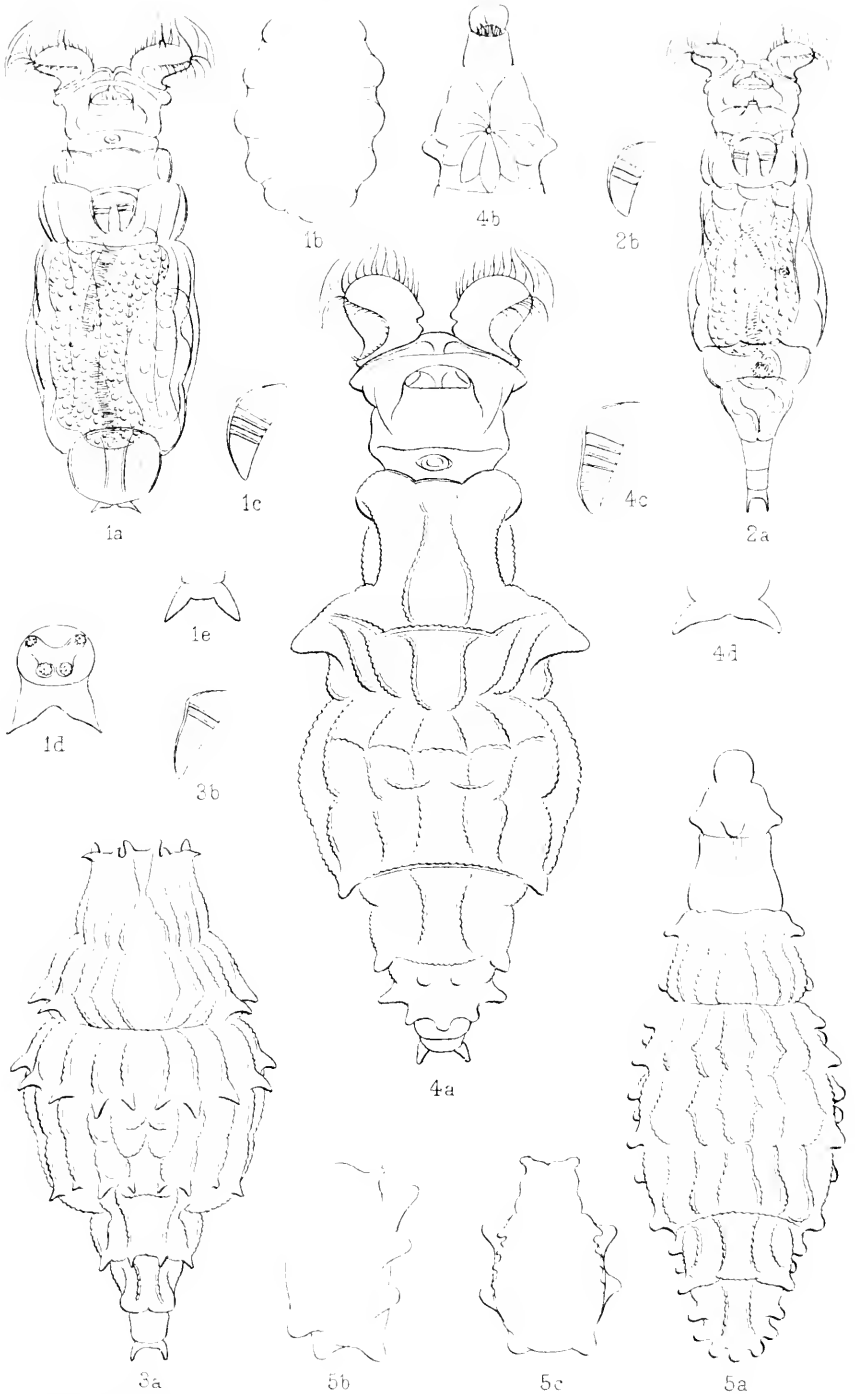

J Murray del ad nat

West, Newman photo-lith

CANADIAN ROTIFERA

JOURNAL
OF THE
ROYAL MICROSCOPICAL SOCIETY.

JUNE, 1911.

TRANSACTIONS OF THE SOCIETY.

XI.—*Canadian Rotifera: Collected by the Shackleton Antarctic Expedition, 1909.*

By J. MURRAY, F.R.S.E.

(Read April 19, 1911.)

PLATES VI.-VIII.

THE opportunities for collecting in Canada occurred on a journey across the continent in June 1909. At Victoria there was a stay of a few hours, and in Vancouver of a whole day. Afterwards the only time available was when the train stopped at stations for half an hour or so to allow time for meals. Twice we were delayed

EXPLANATION OF PLATE VI.

- Fig. 1a.—*Philodina plena* (Bryce), variety.
,, 1b. Ditto. Egg.
,, 1c. Ditto. Jaw.
,, 1d. Ditto. Spurs and toes.
,, 1e. Ditto. Another variety of spurs
,, 2a.—*Philodina* sp.(?)
,, 2b. Ditto. Jaw.
,, 3a.—*Pleuretra brycei* (Weber) variety.
,, 3b. Ditto. Jaw.
,, 4a.—*Callidina canadensis* sp. n.
,, 4b. Ditto. Head, showing rosette.
,, 4c. Ditto. Jaw.
,, 4d. Ditto. Spurs.
,, 5a.—*Callidina papillosa* (Thomp.), variety.
,, 5b. Ditto. Egg, side view.
,, 5c. Ditto. Egg, front view.

by accidents to the railway, once for about two days, and again for a few hours. Both delays happened beside lakes; and there would have been opportunity to collect plankton Rotifera, but my last plankton-net had been torn at Honolulu. The moss-dwelling Rotifera were studied to some extent, but the train did not offer great facilities for microscoping, the Microscope having to stand on a yielding cushioned seat. At Ottawa and Montreal I had a few hours in the public parks, and found plenty of moss at Ottawa, but none at Montreal.

Historical Sketch.—Canadian Rotifera have no history. I know but two works where they are even mentioned: Richters, 1908 (35),* notes *Callidina* in Vancouver, but no species were identified; Rousselet, 1909 (37), says that the Rotifera of the Dominion are quite unknown. I have made no search through the publications of Canadian scientific societies, relying on the statement of Rousselet, who knows the Rotifer literature so well.

Over the border, a great deal has been written about the Rotifera of the U.S.A. As none but Bdelloida were collected in Canada, only those works are noted which deal with that order.

I have notes of about fifty works in which Bdelloida are mentioned. Less than a dozen of these are of any importance as faunistic studies; the others are either studies of development or notes of pond-life and exhibits of species (generally *R. vulgaris*) at the meetings of microscopical societies. The most important works are those of Kellicott and Jennings. All the works are included in the Bibliography, but only those are referred to in this sketch which add something to the knowledge of the American Rotifer fauna.

The first record of a Rotifer in America is by Bose, 1802 (3). As Ehrenberg identified Bose's animal, first as *R. vulgaris*, then as *C. rediviva*, we may reasonably entertain doubt as to what it was.

Bailey, 1850 (2), noted six species, two of them new species, badly described.

Kellicott, in 1888 (22), recorded seven species (one new, *C. socialis*); in 1892 (23) he added *R. elongatus*, and in 1896 (24) gave a list of nine species.

Jennings, in 1894 (18), gave a list of eleven species; in 1896 (19), fourteen species; in 1900 (20), twenty-two species; and in 1901 (21), twenty-one species.

Craig, 1896 (6), is stated in the key by H. S. M., 1902 (29), to have found a *Philodina socialis*, which may be meant as a synonym for *C. socialis* Kell.

The latest addition to the American Bdelloid fauna is Bryce's *Scaphanotrocha rubra*, 1910 (4), collected by Dr. Latham of Chicago.

* The figures in brackets refer to the Bibliography at the end of paper.

LIST OF SPECIES COLLECTED.

	British Columbia.				Ontario.	
	Victoria.	Vancouver.	Sicamous.	Rockles.	Lake of the Woods.	Ottawa.
<i>Philodina citrina</i> Ehr.				×		
<i>P. australis</i> Murray		×				
<i>P. acuticornis</i> Murray					×	
<i>P. nemoralis</i> Bryce				×		
<i>P. rugosa</i> Bryce						×
<i>P. vorax</i> (Janson)						×
<i>P. plena</i> (Bryce)	×					×
<i>Pleuretra alpium</i> (Ehr.)	×				×	
<i>P. humerosa</i> (Murray)					×	×
<i>P. brycei</i> (Weber)	×					
<i>Callidina habita</i> Bryce	×	×		×	×	
<i>C. plicata</i> Bryce	×	×		×	×	
<i>C. quadricornifera</i> (Milne)	×	×	×	×	×	
<i>C. ehrenbergii</i> Janson		×				
<i>C. musculosa</i> (Milne)		×				
<i>C. speciosa</i> Murray			×			
<i>C. asperula</i> sp. n.	×	×				
<i>C. papillosa</i> (Thomp.)	×	×	×	×	×	
<i>C. canadensis</i> sp. n.	×					
<i>C. aculeata</i> (Milne)						×
<i>C. multispinosa</i> (Thomp.)					×	
<i>C. zickendrahti</i> (Richters)					×	
<i>Mniobia tetraodon</i> (Ehr.)	×	×		×	×	
<i>M. magna</i> (Plate)	×	×				
<i>M. russcola</i> (Zel.)	×			×	×	×
<i>M. symbiotica</i> (Zel.)		×				
<i>M. obtusicornis</i> sp. n.		×				×
<i>M. montium</i> sp. n.				×		
<i>Rotifer longirostris</i> (Janson)	×					×
<i>Habrotrocha pusilla</i> (Bryce)		×			×	
<i>H. angusticollis</i> (Murray)					×	
<i>H. ornata</i> (Murray)		×				
<i>H. pulchra</i> (Murray)	×			×		×
<i>H. aspera</i> (Bryce)	×			×	×	
<i>H. constricta</i> (Duj.)		×				×
<i>H. microcephala</i> (Murray)					×	
<i>H. maculata</i> sp. n.						×
<i>Ceratotrocha cornigera</i> (Bryce)				×		×
<i>Adineta vaga</i> (Davis)	×		×	×	×	×
<i>A. gracilis</i> Janson	×	×		×		×
<i>A. barbata</i> Janson		×		×	×	
<i>A. longicornis</i> Murray				×		

NOTES ON THE SPECIES.

Philodina citrina Ehr.

Examples from the Rocky Mountains, 3000–5000 ft., were quite colourless.

Philodina australis Murray.

Discovered earlier on the same voyage, in Australia.

Philodina plena (Bryce). Plate VI. figs. 1a–1c.

A small variety from Ottawa is figured. With it were associated eggs (fig. 1b) of a very unusual form. They resemble those attributed to the species by Mr. Bryce in having a series of rounded knobs round the circumference. They are much flattened, and the apparent knobs are really rounded ridges, which are highest on the edge, and die out on to each of the flattened surfaces.

Philodina sp. ? Plate VI. figs. 2a, 2b.

A small animal, 250 μ in length, most like *P. nemoralis*, but smaller and without eyes. The spurs are small and slender, and are usually held nearly parallel.

Habitu.—Victoria, B.C.; several.

Pleuretra brycei (Weber). Plate VI. figs. 3a, 3b.

Variety.—Spines on anterior margin of trunk very small; lateral spines two at each side; chief dorsal series, ten spines; second dorsal series, eight; series on pre-anal segment, four; no ridge on first foot-segment.

The chief peculiarities are: the reduction of all the anterior spines; the second series of eight spicules on the trunk; the series of four spicules on the rump. The last character is only shared by a New Zealand variety, and a South African species (*P. africana*).

Callidina habita Bryce.

Besides the type, there was a variety having the lobes of the upper lip more or less widely separated. This variety is now known in many countries.

Callidina speciosa Murray (32).

Previously known only in South America—still confined to the Western hemisphere.

EXPLANATION OF PLATE VII.

- Fig. 6.—*Callidina multispinosa* (Thomp.) variety.
 .. 7. Ditto. Variety.
 .. 8. Ditto. Ditto.
 .. 9. Ditto. Ditto.
 .. 10a.—*Callidina zickendrahti* Richters.
 .. 10b. Ditto. Jaw.

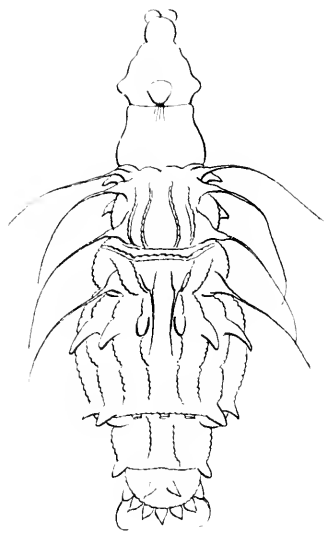

6



10b

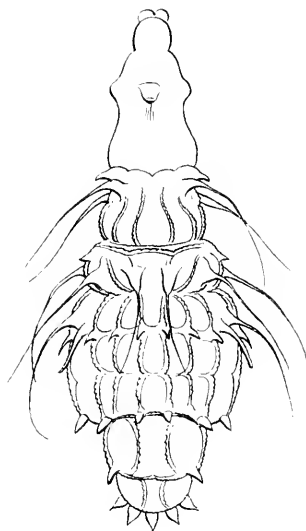

7

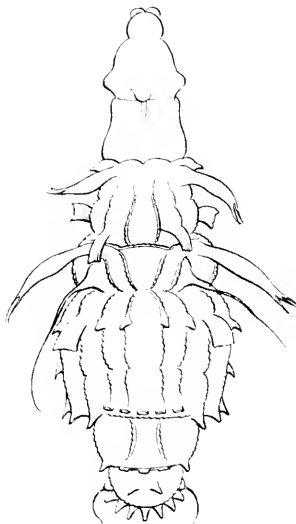

10a

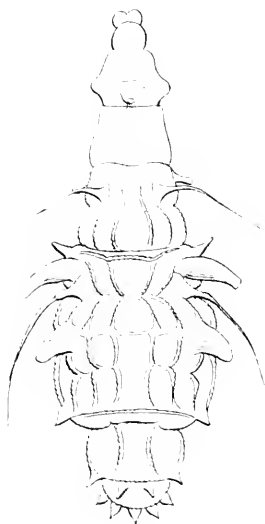

8

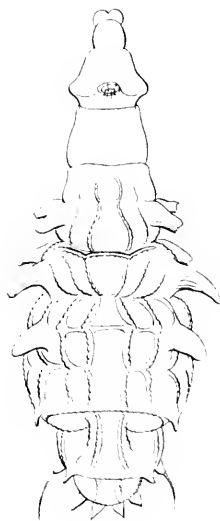

9

J. Murray del ad nat

West, Newman photo lith

Callidina asperula sp. n. Plate VIII. figs 11a-11f.

Specific characters.—Small; trunk papillose. Corona less than trunk, collar not prominent, upper lip showing two fine points in the sulcus between the discs. Antenna short, rostrum very short. Teeth 3 or 4 + 1. Foot 4-jointed; spurs short, divergent, acuminate, interspace small; last foot-joint very short, widely expanded into a sort of collar surrounding the toes. Egg oval, with large rounded knobs.

Length 250 μ when feeding, width of corona 60 μ , neck 36 μ , trunk 80 μ , across spurs 18 μ , egg 110 μ by 90 μ over the knobs. Sulcus less than width of disc; the sharp points are the ends of the collar folds. Rostrum broader than long, lamellæ never seen. Antenna $\frac{1}{2}$ to $\frac{3}{5}$ of neck width. First trunk segment not papillose, of a constant and peculiar shape (see fig. 11a). Second trunk segment, central trunk, and rump regularly papillose; foot smooth. Jaws constricted below the broadest part.

Habitat.—British Columbia; abundant.

Readily distinguished from all other Bdelloids by the papillose trunk, number of teeth, points on the upper lip, and peculiar foot. *Mniobia obtusicornis*, also described in this paper, has the last joint of the foot similarly expanded. No doubt the expansion is a support to the toes, and probably acts as a sucker.

Callidina aculeata (Milne).

The Canadian form is almost identical with a South African variety, which is figured in a paper in the Annals of the Transvaal Museum (now in press). There are five dorsal transverse rows of spicules on the trunk, many spicules on the rump, and an annular thickening on the first foot-joint.

Callidina papillosa (Thomp.). Plate VI. figs. 5a-5c.

Variety.—Small, lateral warts, more numerous than in the type. Teeth 4 or 5. The egg is oval, with prominent knobs. The example figured (figs. 5b, 5c) shows external characters both of the egg and of the contracted animal, but whether the parent had died and its skin shrivelled on to the egg, or the young had partly burst the egg and then died, could not be made out.

Variety (not figured).—The warts are almost obsolete. Rocky Mountains.

Variety.—Small, like that figured, but teeth 2.

Callidina canadensis sp. n. Plate VI. figs. 4a-4d.

Specific Characters.—Large, stout, papillose; sulcus deep, collar prominent: second anterior trunk segment with very large lateral protuberances; central trunk with warts at posterior angles;

several warts on pre-anal and anal segments; foot 4-jointed; spurs divergent, acuminate, obtuse. Teeth 4. Rosette at mouth.

Length 350 μ , ereeping; contracted 225 μ by 130 μ . The prominent collar is as wide as the corona, its lobes on the upper lip not as high as the bridge; neck also prominent, antenna as long as neck width. First trunk segment of characteristic and constant shape; whole integument of trunk leathery, prettily wrinkled, and scarcely altering in shape as the animal moves. Warts on the foot as in *C. papillosa*.

Related to *C. papillosa*, the chief difference lies in the great lateral projections of the second trunk segment, which make this part often wider than the central trunk. These projections are hollow, but the skin is thickened at the summit, forming a wart. There are no other warts on the anterior or central trunk, except two at the posterior angles of the central. Very abundant in British Columbia, it appeared constant in these characters.

Callidina multispinosa (Thomp.). Plate VII, figs. 6-9.

Several forms occurred, some of which would be considered as distinct species, were they not linked by intermediate forms.

Variety (Plate VII., fig. 6).—Bearing very long setæ with bulbous bases, and large stout curved spines. On each side five long setæ on the anterior trunk, one pair near the median line of the second segment. At widest part of central trunk a transverse dorsal series of stout curved horn-like spines, in three pairs. Thick knobs at posterior angles of central trunk and pre-anal segment. On the foot two short lateral setæ with bulbous bases, and a number of dorsal conical processes.

Variety (Plate VII., fig. 7).—Bearing very long setæ and short spicules. Five pairs of setæ on the anterior trunk, as in the last variety. Two lateral setæ, with thick bases, on each side of central trunk, and a thick sublateral spine. Dorsal row of spicules (four pairs) at widest part of central trunk, and row of three pairs at posterior border. No lateral setæ on foot.

The long lateral setæ on the central trunk are the most unusual feature of this variety.

Variety (Plate VII., fig. 8).—Bearing long setæ and ligular processes. On the first trunk segment one small ligular process and one long seta at each side. On the second segment, at each side one long seta with thick base, one large curved ligular process, and one conical process (almost in the angle between first and second segments). On central trunk, at each side one long seta, one large ligular process, and one knob at posterior angle. No dorsal transverse series, no lateral setæ on foot. Conical processes on foot.

The peculiarity of the variety is the intermixture of ligular and setiform processes.

Variety.—Processes mostly ligular (Plate VII. fig. 9). On first

and second segments of trunk at each side, two ligular rounded processes; on central trunk at each side, one similar sublateral process at broadest part; conical processes at posterior angles of central trunk and on rump; on the foot, a curved lateral seta with bulbose base. No transverse dorsal series.

This variety is peculiar in having only ligular processes in front of the widest part of the body.

All these varieties figured occurred together near the Lake of the Woods, and the intermediate forms are too numerous to figure.

Callidina zickenkrahti Richters. Plate VII. figs. 10a, 10b.

Sufficiently near Richters' type, yet with some differences. There is the same number (five pairs) of ligular processes, mostly forked at the ends. In the figure several appear broken off. They are not all in the same positions. The pair on the central trunk form part of the dorsal transverse series. There is a long seta on the second trunk segment. Teeth 2.

Examples from Russia, which I have been enabled by the kindness of Dr. Penard to see, differ more from Richters' type, having the dorsal transverse series of large thick knobs (as in fig. 6, Plate VII).

Found at the Lake of the Woods, with the series of forms of *C. multispinosu* figured on the same plate.

Mniobia obtusicornis sp. n. Plate VIII. figs. 13a-13d.

Specific characters.—Large, stout; corona less than trunk; antenna short; jaw with thick coloured border, teeth 3/3 or 3 + 1. Foot 4-jointed; spurs small, rounded, separated by broad convex interspace; last joint expanded into a broad collar surrounding the reniform disc which represents the toes.

Length, when feeding, 500 μ , width of corona 120 μ , neck 75 μ , trunk 150 μ , across spurs 30 μ . Sulcus as wide as disc. Collar not very prominent; lobes on upper lip not reaching as high as bridge. Antenna half of neck width. Trunk broadly plicate; pale yellow. Stomach wall with yellow globules of moderate size. Spurs stippled. In certain positions the interspace is obliterated, and they have the appearance shown in fig. 13d.

The form of spurs and the expanded last segment of the foot distinguish this from all other species of *Mniobia*. The foot is similarly expanded in a Canadian *Callidina*, *C. asperula*, described in this paper. Doubtless it is used as a sucker, to give support to the foot-disc.

Habitat.—Victoria, B.C.; very abundant.

Mniobia montium sp. n. Plate VIII. figs. 14a, 14b.

Specific characters.—Large, slender, hyaline. Corona narrow with small deep sulcus. Collar very prominent; lobes on upper

lip high, meeting in middle. Antenna short. Jaw with very thick border, teeth 3 3. Rump usually wider than central trunk, rounded posteriorly. Foot short, spurs small, acuminate, divergent, no interspace.

Length, when feeding, 450μ , width of corona and collar about 70μ , neck 55μ , trunk 90μ , rump 70μ , across spurs 25μ . The characteristic form of the head is that shown, but the discs are sometimes held further apart, and the lobes of the upper lip slightly separated. The bulging anterior trunk and contracted central trunk are habitual, though I am unwilling to make such things specific characters. Central trunk and pre-anal closely plicate; pre-anal and anal not distinguishable in the outline, but perhaps separated by dorsal fold.

Nearest *M. symbiotica*, it differs more in general form than in detail. It lacks the red colour of *symbiotica*. The rump and upper lip are of different form. It is not stout. It often swims free.

Habitat.—Rocky Mountains; abundant.

Habrotrocha microcephala (Murray).

Habitat.—Lake of the Woods. The first time the species has been found outside of Britain.

Habrotrocha maculata sp. n. Plate VIII, figs. 12*a*–12*d*.

Specific characters.—Small, whitish; trunk stippled with large pellucid dots; corona small, less than collar and neck; prominent flaps at side of mouth; lamellæ large; antenna very short; teeth three or four in each jaw; foot short, 3-jointed; spurs small, acuminate, divergent, no interspace.

Length, when feeding, 250μ , width of corona 28μ , mouth flaps 40μ , neck 30μ , trunk 90μ , across spurs 24μ . Discs close together;

EXPLANATION OF PLATE VIII.

- Fig. 11*a*.—*Callidina asperula* sp. n. Feeding.
 „ 11*b*. Ditto. Creeping.
 „ 11*c*. Ditto. Jaw.
 „ 11*d*. Ditto. Egg.
 „ 11*e*. Ditto. Side view of foot.
 „ 11*f*. Ditto. End view of foot.
 „ 12*a*.—*Habrotrocha maculata* sp. n. Feeding.
 „ 12*b*. Ditto. Creeping.
 „ 12*c*. Ditto. Side view of head.
 „ 12*d*. Ditto. Jaw.
 „ 13*a*.—*Mniobia obtusicornis* sp. n.
 „ 13*b*. Ditto. Jaw.
 „ 13*c*. Ditto. Foot.
 „ 13*d*. Ditto. Spurs and disk.
 „ 14*a*.—*Mniobia montium* sp. n.
 „ 14*b*. Ditto. Jaw.

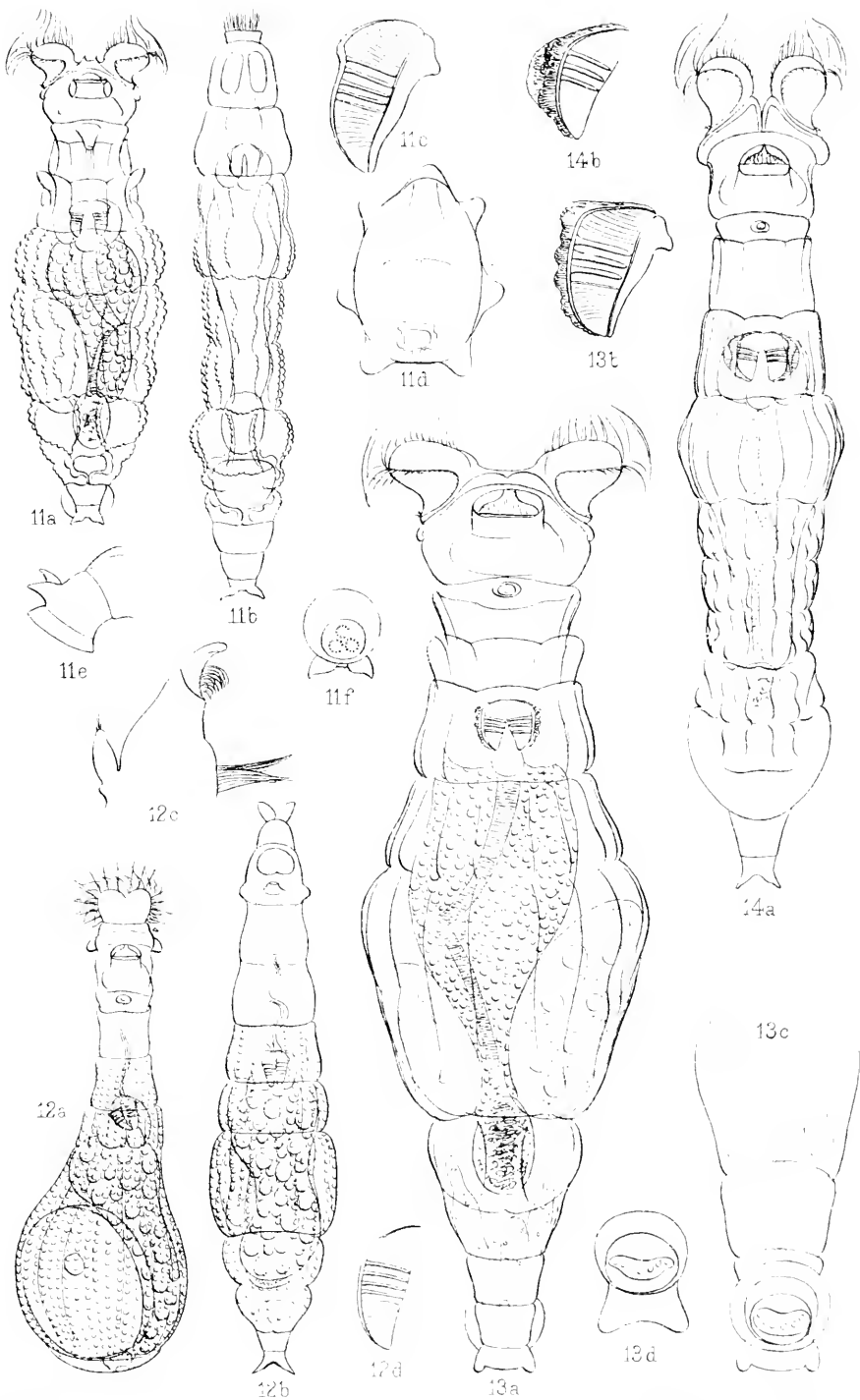

J Murray del. ad nat

Wes. Newman photo lith

CANADIAN ROTIFERA.

cilia long, usually projecting from mouth as two pencils when the animal is creeping; antenna one-quarter to one-third of neck width.

When feeding, the trunk has the flask shape common to tubedwellers, the foot being quite hidden. No doubt it is a tubedweller, though it has never been seen in a tube. The pellucid dots on the trunk are exceptionally large and regular; they do not extend on to the neck. Egg of 75μ by 55μ .

It is not necessary to compare it in detail with other species. The elongate head, prominent mouth-margin and dotted skin are sufficient to distinguish it from those species which come nearest to it.

Habitat.—Ottawa; very abundant.

Ceratotrocha cornigera (Bryce).

The known range of this remarkable species is rapidly extending. It is now known in Spitsbergen, Scotland, Ireland, Australia, and Canada. It appears to have a preference for mountains: in Scotland it is commonest on mountain-tops, and in Australia and Canada it occurred at high levels.

Adineta longicornis Murray.

The range of this species is proving extensive, chiefly in warm countries, but now recorded for New Zealand, the Antarctic, and Canada.

DOUBTFUL SPECIES.

Marked with an asterisk (*) in the list.

Philodina socialis H. S. M.—diagnosis extracted from key: "not colourless, white; antenna, 2-jointed; foot, 6-jointed; toes, 4; spurs, large, stout; eyes 2, cervical. In flocculent colonies."†

Judging from the name it might be supposed that this was an attempt to put Kellicott's *Callidina socialis* in its proper genus with a fuller description; but it is not said to be parasitic, and it has cervical eyes. Unfortunately, this description, fairly good as far as it goes, is not accompanied by a figure. There is nothing to suggest that it might not be *Philodina commensalis*!

P. (Dissotrocha) pannosa Bailey. The figure leaves little doubt that this is *D. macrostyla*, the "tubercled" form.

Callidina rediciva Ehr. Ehrenberg's diagnosis was sufficiently vague, and he appears to have been willing to identify the species from contracted examples showing nothing distinctive.

C. socialis Kell. Unfortunately Kellicott gives no figure, and his description is not full enough to enable us to assign it to a genus, now that the genus *Embata* has been separated, and the Callidine distinguished from the Philodinae primarily by the number of toes. The parasitic habit and the characters given

† Craig, Proc. Nat. Sci. Assoc., Staten Island, xviii. (1896).

make it highly probable that it is an *Embato*, and that Janson was wrong in uniting with it *Rotifer (Callidina) magnicalcarata* Parsons.

Rotifer mento Anderson. Anderson's description and figures seem to me to indicate no points of distinction from *R. macroceros*. The tube-making habit appears to have caused the resemblance to be overlooked. In Scotland I find *R. macroceros* usually inhabiting lax tubes of flocculent material.

R. vestitus Bailey. The figures and description indicate a sufficiently strange animal, but they are not good enough to inspire confidence or leave much hope of identifying it.

Habrotrocha eremita (Bryce). Jennings's figure (21) shows that the animal he observed is not *eremita*, which is remarkable for the length of the pedicels bearing the disks.

LIST OF ALL BDELOIDS RECORDED FOR NORTH AMERICA.

	Canada.	United States.		Canada.	United States.
<i>Phacelina citrina</i> Ehr.	×	×	<i>Mniobia tetraodon</i> (Ehr.)	×	
<i>P. erythrophthalma</i> Ehr.		×	<i>M. magna</i> (Plate)		×
<i>P. roscola</i> Ehr.		×	<i>M. russeola</i> (Zel.)	×	×
<i>P. megalothrocha</i> Ehr.		×	<i>M. symbiotica</i> (Zel.)	×	
<i>P. australis</i> Murray	×		<i>M. obtusicornis</i> sp. n.	×	×
<i>P. acuticornis</i> Murray	×		<i>M. montium</i> sp. n.	×	
<i>P. nemoralis</i> Bryce	×		<i>Rotifer vulgaris</i> Schrank		×
<i>P. rigosa</i> Bryce	×		<i>R. macrourus</i> (Müller)		×
<i>P. coraa</i> (Janson)	×		<i>R. macroceros</i> Gosse		×
<i>P. plona</i> (Bryce)	×		* <i>R. mento</i> Anderson		×
* <i>P. socialis</i> M.		×	<i>R. elongatus</i> Weber		×
<i>Pleurotra alpinum</i> (Ehr.)	×		<i>R. triseatus</i> Weber		×
<i>P. numerosa</i> (Murray)	×		<i>R. septimius</i> (Ehr.)		×
<i>P. trajeci</i> (Weber)	×		* <i>R. vestitus</i> Bailey		×
<i>Dissotrocha aculeata</i> (Ehr.)		×	<i>R. tardigradus</i> Ehr.		×
<i>D. macrostyla</i> (Ehr.)	×	×	<i>R. longirostris</i> (Janson)	×	
* <i>D. panosa</i> (Bailey)		×	<i>Habrotrocha pusilla</i> (Bryce)	×	
<i>Callanina elegans</i> Ehr.		×	* <i>H. eremita</i> (Bryce)		×
* <i>C. ochraria</i> Ehr.		×	<i>H. angusticollis</i> (Murray)	×	
<i>C. nitida</i> Bryce	×		<i>H. crenata</i> (Murray)	×	
<i>C. pacida</i> Bryce	×		<i>H. pulchra</i> (Murray)	×	
<i>C. padricorufera</i> (Milne)	×		<i>H. aspera</i> (Bryce)	×	
<i>C. schubertii</i> Janson	×		<i>H. constricta</i> (Duj.)	×	×
<i>C. maculosa</i> (Milne)	×	×	<i>H. microcephala</i> (Murray)	×	
* <i>C. socialis</i> Kell.		×	<i>H. maculata</i> sp. n.	×	
<i>C. speciosa</i> Murray	×		<i>Scephanotrocha rubra</i> Bryce		×
<i>C. asperula</i> sp. n.	×		<i>Ceratotrocha cornigera</i> (Bryce)	×	
<i>C. papillosa</i> (Thomp.)	×	×	<i>Adianta raga</i> (Davis)	×	×
<i>C. canadensis</i> sp. n.	×		<i>A. gracilis</i> Janson	×	
<i>C. avellana</i> (Milne)	×		<i>A. barbata</i> Janson	×	
<i>C. multispinosa</i> (Thomp.)	×		<i>A. longicornis</i> Murray	×	
<i>C. zschoubrahti</i> Richters	×				

SUMMARY.

Forty-two species were collected, all moss-dwellers except *Philodina australis*, which may have come in the water with which the mosses were washed (while in British Columbia). Five new species are described. I know of no previous records for Canada, so that they are all additions to the Canadian Rotifer fauna.

I find 27 species of Bdelloida recorded for the United States. Half-a-dozen, at least, of these species are considered doubtful, for reasons given above. Including the doubtful species there are 63 Bdelloida known in North America.

Only six of our species were previously recorded for North America. No doubt the reason for the number being so small is that our species are all moss-dwellers, while most earlier naturalists examined only ponds, lakes, and streams.

The great majority of the species are common or widely-distributed—only about a dozen species are so limited in range as to call for remark. The five new species are as yet only known in Canada*—*P. australis* is known on both sides of the Pacific (Australia and Vancouver), and not elsewhere. *C. speciosa* is limited to North and South America; *C. zickendrahti* to Russia and Canada; *H. microcephala* to Scotland and Canada. *S. rubra*, *C. cornigera*, and *A. longicornis* are species hitherto supposed to be rare, which are proving to be widely distributed. *P. socialis*, if it is not meant as a synonym for *C. socialis* Kell., is only known in the United States.

There are only 12 species in the list for North America which are not known in Europe; 14 which are not known in Britain.

Besides the 42 species in our list, several others were seen, distinct from any yet noted for North America, but some of them were already known to Mr. Bryce, though not yet described, and others were not studied sufficiently.

BIBLIOGRAPHY.

1. ATTWOOD, H. F.—*Volvox globator* (supposed *B. vulgare* in *Volvox*). Amer. Journ. Micr. and Pop. Sci., iii. (1878) p. 116.
2. BAILEY, J. W.—Microscopical Observations made in South Carolina, Georgia, and Florida. Smithson. Contrib. to Knowledge, ii. (1850) Art. 8.
3. BOSC.—Le Rotifère de Carolina. Hist. nat. de vers. suite de Buffon (1802) pp. 176, 184 (not seen, reference from Mandl, 1839).
4. BRYCE, D.—A New Classification of the Bdelloid Rotifera. Journ. Quekett Micr. Club (Dec. 1910, for Nov. 1910) p. 61.
5. COX, C. F.—Reproduction of *Rotifer vulgaris*. Amer. Journ. Micr. and Pop. Sci. (1877) p. 44.

* *Callidina asperula* has since been found in Ireland by the Clare Island Survey.

6. CRAIG—*Philodina socialis*. Proc. Nat. Sci. Assoc. Staten Island, xviii. 1896 (reference in H.S.M., 1902).
7. DANA—Systematic Position of the Rotifera. Amer. Journ. Arts and Sci., xxii. (1857) p. 25 (reference in Zelinka, 1886).
8. EHRENBURG, C. G.—Die Infusionsthierchen (Leipzig, 1838).
9. " " Verbreit. u. Einfluss, d. Mikr. Lebens, in Süd- u. Nord-Amerika. Ber. Ver. k. Akad. Berl. (1843, for 1841) p. 39.
10. " " Mikro Leben als Flussträubung u. Humusland in Florida. Verh. k. Akad. Berl. (1853) p. 252.
11. " " Mikrogeologie. II. North America (Leipzig, 1856).
12. GISSLER, C. F.—Fauna of the New York Croton Water (New York, 1872).
13. HELM, S.—(*R. vulgaris* exhibited.) Journ. New York Micr. Soc., v. (1889) pp. 40 et seq.
14. HEMPEL, A.—Rotifera found in the Illinois River, etc. Bull. Illinois State Lab. Nat. Hist., v. (1898) p. 301.
15. HITCHCOCK, R.—*Rotifer* and *Philodina*. Amer. Mon. Micr. Journ. (1883) p. 35.
16. JACOBS, H.—Effects of Desiccation on *Philodina vaseola*. Journ. Exper. Zool. vi. (Philadelphia, 1909) p. 207.
17. JELLIFFE, S. E.—Chicago Water Supply in the World's Fair Grounds. Amer. Mon. Micr. Journ., xiv. (1893).
18. JENNINGS, H. S.—Rotatoria of the Great Lakes, etc. Bull. Mich. Fish. Comm., No. 3 (May, 1894).
19. " " Report on the Rotatoria (of Lake Michigan). Op.cit., No. 6 (1896) p. 85.
20. " " Rotatoria of the United States. U.S. Fish. Comm. Bull. for 1899 (1900) p. 67.
21. " " Synopsis of North American Invertebrata. XVII. The Rotatoria. Amer. Nat., xxxv. (1901) p. 725.
22. KELLICOTT, D. S.—Rotifera of Shiawassee River, Michigan. Proc. Amer. Soc. Micr., x. (1888) p. 84.
23. " " Rotifer Notes. Amer. Mon. Micr. Journ., xiii. (1892) p. 12.
24. " " The Rotifera of Sandusky Bay. Proc. Amer. Soc. Micr., 1896, p. 155.
25. KOFOID, C. A.—The Plankton of Echo River, Mammoth Cave. Op. cit., 1900, p. 113.
26. LEIDY, J.—Revivification of *Rotifer vulgaris*. Proc. Acad. Nat. Sci. Philad., 1874, p. 88.
27. " Rhizopods in the Mosses of the summit of Roan Mountain. Op. cit., 1881 (for 1880) p. 334.
28. LOGAN—Microscopical Life in the Philippine Conservatory Tanks, Allegheny. Amer. Mon. Micr. Journ. (Jan. 1895) p. 1.
29. M. (H.S.M.)—A Key to the Rotifera. (American species not distinguished, except *P. socialis* Craig.) Op. cit. xiii. (1902) p. 89.
30. MELLOR, C. C.—*Aetideurus neptunius*. The Microscope, viii. (1885) p. 53.
31. MITCHELL, W. R.—(*R. vulgaris* exhibited.) Journ. New York Micr. Soc., ii. (1886) p. 55.
32. MURRAY, J. Some South American Rotifers. Amer. Nat., xli. (1907) p. 97.
33. RAFTER, S. W. Micro-organisms of Hemlock Water. Rochester Acad. Sci., 1888.
34. RICHTERS, F. Neue Moosbewohner. Ber. Senckbg. nat. Ges. Frankfurt-a-M., 1902.
35. " " Moosfauna Australiens, etc. Zool. Jahrb. Abt. für Syst., xxvi. (1908) p. 196.

36. ROUSSELET, C. F.—Rotatorian Fauna of Boston. Journ. Quekett Micr. Club (Nov. 1908) p. 335.
37. " " Geographical Distribution of the Rotifera. Op. cit. (Nov. 1909) p. 465.
38. S. (J.C.S.)—Pond Life in Winter. Amer. Mon. Micr. Journ., iv. (1883) p. 62.
39. STEVENS, T. S.—A Key to the Rotifera. (American species not indicated.) Journ. Trenton Nat. Hist. Soc., 1887, p. 26.
40. STOKES, A. C.—Leaves from a Summer Note-book. Amer. Journ. Micr. and Pop. Sci., vi. (1881) p. 189.
41. " " Structural Features in American Rotifers. Sci. Gossip, Nos. 29, 30 (1896) pp. 121 and 148.
42. TURNER, C. H.—Rotifera, etc., of Cincinnati. Bull. Lab. Denison Univ., vi. (1892) p. 58.
43. VORCE, C. M.—Microscopical Forms observed in the waters of Lake Erie. Proc. Amer. Soc. Micr., 5th Ann. Meeting (1882) p. 187.
44. WHITNEY, D. D.—Desiccation of Rotifers. Amer. Nat., xlii. (Oct 1908) p. 665.
45. WOLLE, F.—Rotifer Nests. Amer. Mon. Micr. Journ., iii. (1882) p. 101.

XII —On the Recent and Fossil Foraminifera of the Shore-sands of
Selsey Bill, Sussex.—VII. Supplement (*Addenda et Corrigenda*).

By EDWARD HERON-ALLEN, F.L.S., F.R.M.S.,
 and ARTHUR EARLAND, F.R.M.S.

(Read February 15, 1911.)

PLATES IX.—XIII.

THE series of papers, of which this forms, for the present, the conclusion, has now been in process of publication for three years. During the whole of this time the work of making gatherings, and the examination of the material collected, has been in progress, and this has naturally resulted in the discovery of a great number of additional species, of which some are new. Such additional species are described in the pages which follow, and after allowing for corrections and the withdrawal of one or two species from the list, bring the total of forms described up to 390, or, including varietal forms, 399.

We have been obliged, by engagements entered into by us with regard to other material, to relegate to some future occasion the publication of the results of examination and study of the living Foraminifera which have occupied us concurrently with the examination of the shore-gatherings, and also the geological study of the forms found in the material derived from the artesian borings at "Large Acres."

We take this opportunity of recording our sense of obligation to the Council of the Society for the liberal manner in which they have afforded us scope for the publication of our report. We also

EXPLANATION OF PLATE IX.

- Fig. 1.—*Gromia Dujardini* Schulze (?). Side view. × 100.
 .. 2. Ditto. Oral view. × 100.
 .. 3.—*Nubecularia tibia* Jones and Parker. × 100.
 .. 4.—*Articulina foreolata* H.A. and E. Early or Milioline stage. × 100.
 .. 5.—*Cornuspira foliacea* Philippi sp. Abnormal. × 100.
 .. 6. Ditto.
 .. 7.—*Reophar ampullacea* Brady. Side view. × 100.
 .. 8. Ditto. Oral view. × 100.
 .. 9.—*Hyplophragmium nanum* Brady. Superior view. × 100.
 .. 10. Ditto. Inferior view. × 100.
 .. 11. Ditto. Lateral view. × 100.
 .. 12.—*Tertularia inconspicua* (Brady) var. *jugosa* Brady. × 100.
 .. 13.—*Bulimina Terquemiana* sp. n. × 100.
 .. 14. Ditto.

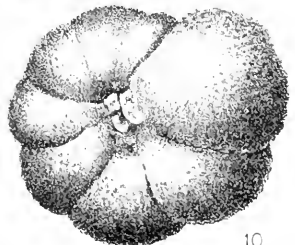
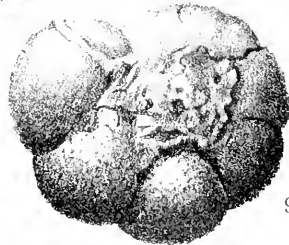
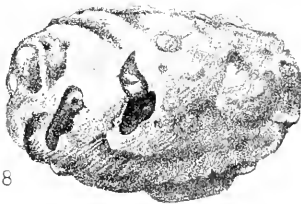
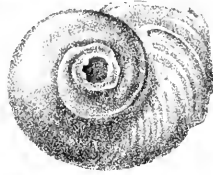
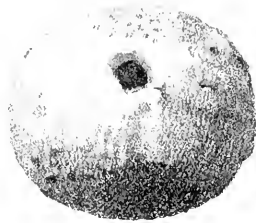

desire to express our indebtedness to Mr. Herbert R. Lilley, of Belfast, who has made the drawings which have illustrated our work, and to Mr. F. W. Millett and Mr. Joseph Wright for assistance and advice ungrudgingly given us on all occasions when it was sought.

The following must be added to the list of chalk-fossil forms (Art. V.):—

52. (H-A) *Ammodiscus incertus* d'Orbigny.
 123. (H-A) *Polymorphina gibba* d'Orbigny.
 127. (H-A) " *compressa* d'Orbigny.
 360. *Uvigerina asprula* Brady.
 210. *Nonionina pompilioides* Fichtel and Moll sp.
 325. *Textularia rugosa* Reuss.
 160. *Discorbina orbicularis* Terquem.
 352. *Nodosaria calomorpha* Reuss.

GROMIA Dujardin.

299. *Gromia oviformis* Dujardin.
 299A. *Gromia Dujardini* Schulze.

For a year now past we have been keeping under observation in the tanks which we have described at some length in 'Knowledge' * and in this Journal,† a large number of living specimens of these two species of *Gromia*, both of which occur in abundance in washings of algæ from the Mixon Reef. We do not propose to enter into any description of the observations which we have made, reserving these for a future paper.

Among the Mixon Reef gatherings we have met with many specimens of the organism figured on Plate IX. figs. 1, 2. Of its rhizopodal nature there can be no doubt, as sarcode is often found adherent round its orifice. Beyond this we do not at present feel disposed to form any conjecture. Its external form and size agree very well with *G. Dujardini*, and that species in the living state frequently covers its natural chitinous envelope with a loose crust of sandy mud, but the sandy envelope of *Gromia* is not apparently cemented together with any durable medium; it can be removed with a camel-hair brush without injuring the living animal, which will proceed at once to form a second covering, which appears to us to consist of mud separated by the pseudopodia from the surrounding water during the assimilation of nutriment. Moreover, such incrustated *Gromiæ*, when dried in the same manner as the shore-gatherings are dried, shrivel up into amorphous crinkled sacs, the nature of which could not be ascertained from a mere casual inspection of the dried specimens.

The specimens which we figure, however, are firm though somewhat flexible. They consist of a spherical chitinous envelope covered with a uniform layer of very fine sand-grains, which are so closely adherent to the envelope that they resist any attempt at

* Knowledge, xxxiii. No. 504 (1910) pp. 285-6.

† See this Journal, 1910, p. 695. Paper No. VI. of this series.

disintegration. At one pole of the sac a large roughly circular aperture is situated; in the immediate neighbourhood of the aperture the sandy covering thins out, so that the chitinous sac becomes visible. A few somewhat similar specimens have been obtained from muddy dredgings by the 'Goldseeker' in the Moray Firth and in the Norwegian fiords.

Pending the discovery of additional specimens, we are figuring the Selsey individuals under the genus *Fromia*, but it appears to us not improbable that further investigations may result in its transference to *Hippocrepina*, with the general characteristics of which genus it appears to conform, though differing entirely in shape.

Diameter 0·3-0·4 mm.

300. *Nubecularia Bradyi* Millett.

Nubecularia inflata Brady, 1884, Foram. 'Challenger,' p. 135, pl. i. figs. 5-5.

Nubecularia Bradyi Millett, 1898, Malay Foraminifera, Journ. R. Micr. Soc. p. 261, pl. v. fig. 6 *a, b*.

Nubecularia Bradyi (Millett) Sidelbottom, 1904, Mem. Manchester Lit. and Phil. Soc. vol. xlviii. No. 5, p. 3.

Brady's specific name "*inflata*," having been previously used by Terquem (1876) for another *Nubecularia*, had to be abandoned.

A single specimen, consisting of one, or perhaps two, chambers. As the specimen is somewhat worn it is difficult to decide whether it is fossil or recent. Brady's specimens, which were recent, were principally from tropical shallow waters, but he also reports its occurrence at Balfour Bay, Kerguelen Island (which is far from the tropics) in 20 to 50 fathoms. Brady also refers to the fact that on the British coasts wild growing specimens of *Miliolina subrotunda* were to be found possessing some Nubecularine characteristics, but that the Milioline affinities of such specimens could always be identified by the nature of the aperture. The aperture of our specimen has no Milioline character, being distinctly, but irregularly, circular, and without sign of tooth.

301. *Nubecularia tibia* Jones and Parker.

(Plate IX. fig. 3.)

Nubecularia tibia Jones and Parker, 1860, Quart. Journ. Geol. Soc., vol. xvi. p. 455, pl. xx. figs. 48-51.

Ditto. (Jones and Parker), Brady, 1879, Quart. Journ. Micr. Sci., vol. xix., N.S., p. 52, pl. viii. figs. 1, 2.

Ditto. (Jones and Parker) Brady, 1884, Foram. 'Challenger,' p. 135, pl. i. figs. 1-4.

Ditto. (Jones and Parker) Millett, 1898, Foram. Malay Archipelago, Journ. Micr. Soc., p. 261, pl. v. fig. 3.

One or two specimens have been found which we think should be attributed to this species, although perhaps they are more

flattened in appearance than any of the published figures. They are, as is almost invariably the case with this species, fragments of the original organism. *Nuberularia tibia* has hitherto been known in the recent condition only from tropical and sub-tropical shallow seas; it occurs, however, among Earland's list of specimens from one of the 'Goldseeker' Stations in the Moray Firth, Scotland (Noss Head, N. by W. $\frac{1}{2}$ W., 3 miles, 43 fms.), and probably is a widely diffused species, although owing to its fragility and small size, it is liable to be overlooked. It occurs in the fossil state as far back as the Trias and Upper Lias, but, according to Brady, there are no records of its occurrence in beds between these strata and recent times.

302. *Biloculina elongata* d'Orbigny.

- Biloculina elongata* d'Orbigny, 1826, Ann. Sci. Nat., vol. vii. p. 298, No. 4.
Biloculina ringens var. *patagonica* Williamson, 1858, Recent Foram. Great Britain, p. 80, pl. vii. figs. 175, 176.
Miliola (*Biloculina*) *elongata* (d'Orbigny) Parker and Jones, 1865, Phil. Trans., vol. clv., p. 409, pl. xvii. figs. 88, 90, 91.
Biloculina elongata (d'Orbigny) Brady, 1884, Foram. 'Challenger,' p. 144, pl. ii. fig. 9.
Ditto. (d'Orbigny) Brady, 1887, Synopsis British Recent Foraminifera.
Ditto. (d'Orbigny) Goës, 1894, Arctic and Scandinavian Foram., p. 119, pl. xxiv. figs. 906-13.

Fossil specimens only have been found, and this is the more noteworthy as the species is not uncommon as a recent shell, in many shallow water gatherings round the British Islands.

303. *Spiroloculina antillarum* d'Orbigny.

- Spiroloculina antillarum* d'Orbigny, 1839, Foram. Cuba, p. 149, pl. xi. figs. 3, 4.
Ditto. (d'Orbigny) Brady, 1884, Foram. 'Challenger,' p. 155, pl. x. fig. 21 a, b.
Ditto. (d'Orbigny) Earland, 1905, Journ. Quekett Micr. Club, ser. 2, vol. ix., No. 57, p. 193.

Fossil only; doubtless derived from some of the Eocene deposits characterized by the presence of warm water fauna. This is one of the species recorded by Earland from Bognor. "One specimen found, weak, but identifiable. Not previously recorded from Great Britain. The species is at home in the shallow water of warm seas." In view of the occurrence of fossils at Selsey, in the immediate neighbourhood of Bognor, the recent condition of the Bognor specimen must be regarded as doubtful, and the species should, therefore, be removed from the list of recent British Foraminifera until specimens are found to occur in localities far removed from Tertiary deposits.

301. *Spiroloculina nitida* d'Orbigny.

- Spiroloculina nitida* d'Orbigny, 1826, Ann. Sci. Nat., vol. vii. p. 298, No. 1.
 Ditto. (d'Orbigny) Parker and Jones, 1871, Ann. Mag. Nat. Hist., ser. 4, vol. viii. p. 218, pl. viii. fig. 24.
 Ditto. (d'Orbigny) Brady, 1881, Foram. 'Challenger,' p. 149, pl. ix. figs. 9, 10.
 Ditto. (d'Orbigny) T. Rupert Jones, 1895, Crag Foram. Palaeont. Soc., p. 112, pl. v. fig. 3, and woodcut fig. 5.
 Ditto. (d'Orbigny) Millett, 1898, Malay Foraminifera, Journ. R. Micr. Soc., p. 265, pl. v. figs. 9-13 *a, b*.

Frequent in the recent condition. No fossil specimens found. There is a considerable range of variation in the specimens of this simplest of the Spiroloculine types, and they serve to link it up with other Milioline species. Many of the specimens are somewhat rugose, and show a tendency to adopt a subarenaceous type of shell. This type of shell closely approaches *Miliolina sclerotica* in texture and general appearance.

Millett (*supra*) gives many interesting notes as to the morphology of this species, which, under various names, appears to have a very extensive geological record, ranging back to the Lias at least.

305. *Spiroloculina planulata* Lamarek sp.

- Miliolites planulata* Lamarek, 1805, Ann. du Muséum, vol. v. p. 352, No. 4; 1822, Anim. sans Vertéb., vol. vii. p. 613, No. 4.
Spiroloculina depressa d'Orbigny, 1826, Ann. Sci. Nat., vol. vii. p. 298, No. 1; Modèle No. 92.
Spiroloculina badensis d'Orbigny, 1846, Foram. Foss. Vienne, p. 270, pl. xvi. figs. 13-15.
Spiroloculina depressa var. *rotundata* Williamson, 1858, Recent Foram. Great Britain, p. 82, pl. vii. fig. 178.
Spiroloculina planulata (Lamarek) Brady, 1884, Foram. 'Challenger,' p. 148, pl. ix. fig. 11 *a, b*.
 Ditto. (Lamarek) Brady, 1887, Synopsis British Recent Foraminifera.
 Ditto. (Lamarek) Göes, 1894, Arctic and Scandinavian Foram., p. 107, pl. xviii. figs. 836 *a-c*.

Fossil, with one exception. The fossil specimens display a considerable variety of form. The recent one is typical. It is a common species on British coasts, and in temperate seas all over the world, and its geological range extends back at least as far as the Lias.

306. *Spiroloculina Terquemiana* sp. n.

- Spiroloculina ornata* Terquem, 1882, Mém. Soc. Géol. France, sér. 3, vol. ii. pt. iii. p. 159, pl. xvi. (xxiv.) fig. 23 *a, b*.

As the specific name "*ornata*" has been previously used by d'Orbigny for a different organism,* it becomes necessary to re-

* *Spiroloculina ornata* (d'Orbigny), 1839, Foram. Cuba, p. 167, pl. xii. figs. 7-7a = *Miliolina ornata* (d'Orbigny) Möbius, 1880, Beitrag. Meeresfauna Insel Mauritius, etc., p. 76, pl. ii. figs. 4-7.

name Terquem's very distinctive little form, and we therefore propose to associate it with Terquem's name.

A considerable number of specimens, all more or less eroded or waterworn, which we have no hesitation in ascribing to Terquem's species, which was described from specimens obtained from the Eocene of Septeuil. Terquem describes it as follows: "Shell oval, obtuse at each end, bounded by a leaf-like carination, formed of curved and depressed chambers, the inner ones smooth, the two outer chambers ornamented with fine and short striae running parallel to each other, but obliquely to the axis, regularly spaced. Aperture oval, and rimmed, without any tooth."

307. *Miliolina boucana* d'Orbigny sp.

Quinqueloculina boucana d'Orbigny, 1846, Foram. Foss. Vienne, p. 293, pl. xix figs 7-9.

Quinqueloculina nussdorfensis d'Orbigny, 1846, Foram. Foss. Vienne, p. 295, pl. xix. figs. 13-15.

Quinqueloculina costata Terquem, 1878, Mém. Soc. Géol. France, sér. 3, vol. iii. p. 63, pl. vi. figs. 3-5.

Miliolina boucana (d'Orbigny) Brady, 1884, Foram. 'Challenger,' p. 173, pl. vii. fig. 13a, b, c.

Ditto. (d'Orbigny) Brady, 1887, Synopsis British Recent Foraminifera.

Ditto. (d'Orbigny) Goës, 1894, Arctic and Scandinavian Foram., p. 114, pl. xxi. fig. 865.

A single fossil specimen. *Miliolina boucana*, according to Brady, is nothing more than a compact and regular variety of *M. bicornis*, with distinct and neatly rounded segments. He further remarks that its distribution is probably co-extensive with that of *M. bicornis*, but in our Selsey gatherings *M. bicornis* is of frequent occurrence in the recent condition, whilst *M. boucana* is represented by this unique fossil.

308. *Miliolina insignis* Brady.

Miliolina insignis Brady, 1881, Quart. Journ. Micr. Sci., vol. xxi. N.S. p. 45.

Ditto. Brady, 1884, Foram. 'Challenger,' p. 165, pl. iv. figs. 8-10.

Ditto. (Brady), 1886, J. Wright, Proc. Belfast Nat. Field Club (1885-1886), Appendix, p. 319, pl. xxvi. fig. 4.

Ditto. (Brady), 1887, Brady, Synopsis British Recent Foraminifera.

Ditto *trigonula* (Lamarck sp.), striate variety, Millett, 1898, Malay Foram., Journ. R. Micr. Soc., p. 503. •

This is merely a striate form of the ubiquitous species *Miliolina trigonula* (Lamarck sp.), but it is of rare occurrence compared with the type, although it is not infrequent in some Australian shore-sands. A few small specimens distinctly fossil.

309. *Miliolina rotunda* d'Orbigny sp.

Tritoloculina rotunda d'Orbigny, 1826, Ann. Sci. Nat., vol. vii. No. 4, p. 299.

Ditto (d'Orbigny) Schlumberger, 1893, Mém. Soc. Zool. de France, vol. iv. p. 206, pl. i. figs. 48-50.

Miliolina rotunda (d'Orbigny) Millett, 1898, Malay Foram., Journ. R. Micr. Soc., p. 267, pl. v. figs. 15, 16.

A few small specimens, recent and fossil, of this little type. The inflated chambers and circular aperture are well marked. This species is very variable in appearance, and links up the genera *Biloculina* and *Miliolina*. It is very common in many tropical and Mediterranean gatherings, but does not appear to have been previously recorded as a British species in the recent condition, although Millett mentions that it occurs of large size in the clay of St. Erth, Cornwall (? Pliocene).

310. *Miliolina sclerotica* KARRER sp.

- Quinqueloculina sclerotica* KARRER, 1868, Sitz. k. Ak. Wiss. Wien, vol. lviii. Abth. i. p. 152, pl. iii. fig. 5.
Miliolina sclerotica (KARRER) BALKWILL and MILLETT, 1884, Jour. Micr. and Nat. Sci. vol. iii. p. 24, pl. i. fig. 2.
 Ditto. (KARRER) BRADY, 1887, Synopsis British Recent Foraminifera.

There are a number of fossil specimens which appear to be referable to KARRER'S species, but the identification is made with some reserve, as the specimens are somewhat longer in contour than the type, and a few of them show a tendency to bear sulci on the external edges.

This form is, as pointed out by BRADY (*supra*), closely allied to, if not identical with, *M. contorta* d'ORB. sp.

311. *Miliolina suborbicularis* d'ORBIGNY sp.

- Tritoculina suborbicularis* d'ORBIGNY, 1839, Foram. Cuba, p. 156, pl. x. figs. 9-11.
Tritoculina fichteliana d'ORBIGNY, 1839, Foram. Cuba, p. 152, pl. ix. figs. 8-10.
Miliolina fichteliana (d'ORBIGNY) BRADY, 1884, Foram. 'Challenger,' p. 169, pl. iv. fig. 9 a,b,c.
Quinqueloculina suborbicularis (d'ORBIGNY) SCHLUMBERGER, 1893, Mém. Soc. Zool. France, vol. vi. p. 73, pl. ii. figs. 63, 64; pl. iii. fig. 67 and woodcuts figs. 26-28.
Miliolina suborbicularis (d'ORBIGNY) MILLETT, 1898, Malay Foram., Journ. R. Micr. Soc. p. 502, pl. xi. fig. 13.

One specimen, which has every appearance of recent origin, although the published records of the species do not, so far as we are aware, extend north of the Mediterranean. It is not uncommon in tropical and sub-tropical sands.

312. *Miliolina undosa* KARRER sp.

- Quinqueloculina undosa* KARRER, 1867, Sitzungsab. d. k. Akad. Wiss. Wien, vol. lv. p. 361, pl. iii. fig. 3.
Miliolina undosa (KARRER) BRADY, 1884, Foram. 'Challenger,' p. 176, pl. vi. figs. 6-8
 Ditto. (KARRER) EGGER, 1893, Abhandl. Bayer. Akad. Wiss. ch. ii. vol. xviii. p. 237, pl. ii. figs. 41, 42.
 Ditto. (KARRER) MILLETT, 1898, Malay Foram., Journ. R. Micr. Soc. p. 506, pl. xii. fig. 5 a-c.

Several specimens, all apparently recent, varying considerably in appearance, and forming a series connecting *M. contorta* and *M. ferrusacii* with the extreme development of the type as figured by Brady.

313. *Vertebralina striata* d'Orbigny.

Vertebralina striata d'Orbigny, 1826, Ann. Sci. Nat. vol. vii. p. 283, No. 1
Modèle No. 81.

Ditto. (d'Orbigny) Parker, Jones and Brady, 1865, Ann. and Mag. Nat. Hist. ser. 3, vol. xvi. p. 32, pl. i. fig. 1.

Ditto. (d'Orbigny) Brady, 1884, Foram. 'Challenger,' p. 187, pl. xii. figs. 14-16.

Ditto. (d'Orbigny) Millett, 1898, Malay Foram., Journ. R. Micr. Soc. p. 607, pl. xiii. fig. 1.

One small fossil specimen, representing an early stage of the shell, and doubtless derived from an Eocene clay.

33. *Articulina foreolata* Heron-Allen and Earland.

(Plate IX. fig. 4.)

Articulina foreolata Heron-Allen and Earland, 1909, Journ. R. Micr. Soc. p. 317, pl. xv. fig. 8.

The pretty little fossil specimen which we figure is apparently the early Milioline stage of *Articulina foreolata*. It possesses a characteristic circular Articuline aperture without sign of tooth.

The markings are much more regular and pronounced than in the type specimen of the species, which was in a poor state of preservation.

314. *Articulina sagra* d'Orbigny.

Articulina sagra d'Orbigny, 1839, Foram. Cuba, p. 160, pl. ix. figs. 23-26.

Vertebralina cassis d'Orbigny, 1839, Foram. Cuba, p. 72, pl. vii. figs. 14, 15.

Vertebralina mucronata d'Orbigny, 1839, Foram. Cuba, p. 72, pl. vii. figs. 16-19.

Ditto. (d'Orbigny) d'Orbigny, 1846, Foram. Foss. Vienne, p. 120, pl. xxi. figs. 18, 19.

Articulina sagra (d'Orbigny) Brady, 1884, Foram. 'Challenger,' p. 184, pl. xii. figs. 22-24.

A single fossil specimen, broken, but showing sufficient post-Milioline development for the identification of the species.

This is a somewhat infrequent constituent of coral sands all over the world, but not uncommon in the West Indian seas.

As a fossil d'Orbigny records it from the Miocene of Vienna.

35. *Crauspira foliacea* Philippi sp.

(Plate IX. figs. 5, 6.)

Since our original note was written we have found the elegant little specimen which we figure. The shell is semi-transparent, and instead of the normal flatness it presents a curious curvature which is well brought out in the drawing.

315. *Orbitolites complanata* Lamarek.

- Orbitolites complanata* Lamarek, 1801, Syst. Anim. sans Vertéb., p. 376.
 Ditto. Lamarek, 1816, Nat. Hist. Anim. sans Vertéb., vol. ii., p. 196, No. 2.
 Ditto. (Lamarek) Carpenter, 1850, Quart. Journ. Geol. Soc., vol. vi., p. 30,
 pl. vii. figs. 24-30.
 Ditto. Lamarek (Carpenter, 1856, Phil. Trans., p. 224, pls. iv.-ix., etc.
 Ditto. Lamarek) Carpenter, 1883, Report on Genus *Orbitolites*, Zool.
 'Challenger' Expedition, part xxi., p. 29, pl. v. figs. 14-18, pls. vi.,
 vii., viii.
 Ditto. (Lamarek) Brady, 1881, Foram. 'Challenger,' p. 218, pl. xvi. figs. 1-6,
 pl. xvii. figs. 1-6.

Fragments of this species are not uncommonly met with among the coarser siftings, and we have one or two almost perfect specimens representing early stages of the shell. They are doubtless all derived from Eocene strata. According to Brady, the species has been recorded by Fisher from the Bracklesham Beds of Hampshire, but we have been unable to trace the record to which he refers. It occurs in many continental Tertiary deposits.

316. *Pelosina variabilis* Brady.

- Pelosina variabilis* Brady, 1879, Quart. Journ. Mier. Sci., vol. xix., N.S. p. 30,
 pl. iii. figs. 1-3.
 Ditto. (Brady) Robertson, 1881, Proc. Nat. Hist. Soc., Glasgow, vol. v., p. 163.
 Ditto. (Brady) Brady, 1884, Foram. 'Challenger,' p. 235, pl. xxvi. figs. 7-9.
 Ditto. (Brady) Brady, 1887, Synopsis British Recent Foraminifera.
 Ditto. (Brady) Flint, 1899, Report U.S. Nat. Museum (1897) p. 266, pl. iv.
 fig. 1.

Among the washings of mud from the Mixon Reef we have found many specimens, more or less fragmentary, referable to this species. Individual fragments also occur in some of the shore gatherings. This is one of the lowest types of the Foraminifera, the organism consisting merely of a single chamber of irregular shape, bounded by thick walls of fine mud upon a chitinous tube or layer. The chitinous envelope frequently extends without an external covering of mud at the oral end of the shell. It often attains to a considerable size. In some of the 'Goldseeker' dredgings from the North Sea, specimens half to three-quarters of an inch in length are found.

44. *Psammospira fusca* Schulze.

45. *Saccammina sphaerica* M. Sars.

Since our original note upon these species was published we have found a considerable number of specimens of both at various points of the shore.

317. *Hypocammmina vagans* Brady.

- Hypocammmina vagans* Brady, 1879, Quart. Journ. Mier. Sci., vol. xix., N.S.,
 p. 33, pl. v. fig. 3.
 Ditto. Brady Haensler, 1883, Quart. Journ. Geol. Soc., vol. xxxix., p. 26,
 pl. ii. figs. 2-6.

- Hyperammina vagans* (Brady) Brady, 1884, Foram. 'Challenger,' p. 260, pl. xxiv. figs. 1-9.
 Ditto. (Brady) Goës, 1894, Arctic and Scandinavian Foraminifera. p. 17, pl. iv. fig. 60.
 Ditto. (Brady) Earland, 1905, Journ. Quekett Mic. Club, ser. 2, vol. ix., No. 57, p. 199.

This organism, which represents one of the simplest conceivable types of Rhizopod life, occurs quite frequently in washings of algae from the Mixon Reef, usually in a more or less fragmentary condition. Fragments are also found in the shore-sands. There is considerable variety in the texture of individual specimens, some only utilizing the finest sand-grains mixed with a considerable amount of cement, while in others the sand utilized is much coarser and the cement is inconspicuous. Under favourable conditions the species, which grows attached to other organisms, probably attains to a considerable size, as many of the fragments appear to have been broken from quite large patches of labyrinthic tubes.

Until Earland (*supra*) recorded this species from the neighbouring locality of Bognor, where it is equally abundant, the only British record was Canon Norman's from a dredging off Oban, quoted by Brady (*supra*). The species is of world wide distribution, but normally a deep water type, often occurring in enormous abundance in deep dredgings.

318. *Reophax ampullacea* Brady.

(Plate IX. figs. 7, 8.)

- Reophax ampullacea* Brady, 1881, Quart. Journ. Mic. Sci., vol. xxi., N.S., p. 49.
 Ditto. Brady, 1884, Foram. 'Challenger,' p. 290, pl. xxx. fig. 6.
 Ditto. (Brady) Chapman, 1892, Journ. R. Mic. Soc., p. 320, pl. v. fig. 2.
 Ditto. (Brady) Millett, 1899, Journ. R. Mic. Soc., p. 253, pl. iv. fig. 9.

One recent specimen, which presents the same curious selective habits as we have remarked upon in dealing with *Verneuilina polystropha* and *Haplophragmium agglutinans*, grains of garnet and magnetite entering largely into the construction of the test. The species may be considered as an arenaceous isomorph of *Lagena marginata*. *Reophax difflugiformis* being an equivalent isomorph of the rotund species *Lagena globosa*.

319. *Reophax fusiformis* Williamson sp.

- Proteonina fusiformis* Williamson, 1858, Recent Foram. Gt. Britain, pl. 1, fig. 1
Reophax fusiformis (Williamson) Siddall, 1879, Cat. Recent British Foram., p. 4.
 Ditto. (Williamson) Brady, 1884, Foram. 'Challenger,' p. 290, pl. xxx. figs. 7-11.
 Ditto. (Williamson) Brady, 1887, Synopsis British Recent Foraminifera.

We have a record of this species, but the slide having been mislaid or lost we cannot give any further information respecting it. It was, however, of recent origin, the species being widely distributed round our coasts.

320. *Haplophragmium latidorsatum* Bornemann sp.

- Nonionina latidorsata* Bornemann, 1855, Zeitschr. d. deutsch. geol. Gesell., vol. vii. p. 333, pl. xvi. fig. 4*a, b*.
Haplophragmium crassum Reuss, 1867, Sitzungsber. d. k. Akad. Wiss. Wien, vol. lv. p. 46, pl. i. figs. 1, 2.
Lituola subglobosa M. Sars, 1868, Vidensk.-Selsk. Forhandling, p. 250.
 Ditto. (M. Sars) G. O. Sars, 1871, Vidensk.-Selsk. Forhandling, p. 253.
Haplophragmium rotundidorsatum Hautken, 1875, Mittheil. Jahrb. d. k. ung. geol. Anstalt., vol. iv. p. 12, pl. i. fig. 2.
Haplophragmium latidorsatum (Bornemann) Brady, 1884, Foram. 'Challenger,' p. 307, pl. xxxiv. figs. 7-10, 14.
 Ditto. (Bornemann) Goss, 1894, Arctic and Scandinavian Foram., p. 21, pl. v. figs. 102-120.

We have one minute specimen derived from the rarely-visible band of clays, named by Mr. Clement Reid "the Selsey Beds," which appears to be referable to this species. If so, its presence in our gatherings is certainly noteworthy, as *H. latidorsatum* is one of the most typical of deep-water and cold-area forms. In the cold area of the Shetland-Faeroe channel and in the Norwegian Deep to the north of this channel the species occurs in such enormous numbers as to form a true deposit or ooze, in which the presence of other organisms is completely masked by the preponderance of this species, which also attains to a considerable size. Apart from this area, the records of *H. latidorsatum* are almost confined to very deep water, except in the Arctic and Antarctic seas. As a fossil it has been recorded from several Eocene clays in Germany and Hungary.

EXPLANATION OF PLATE X.

- Fig. 1.—*Bulimina selseyensis* sp. n. × 100.
 .. 2. Ditto. Ditto.
 .. 3.—*Bolivina tortuosa* Brady. × 100.
 .. 4. Ditto. Ditto.
 .. 5.—*Bolivina Durrandii* Millett. × 100.
 .. 6.—*Bolivina cocænica* Terquem. × 100.
 .. 7. Ditto. Ditto.
 .. 8.—*Bolivina lævigata* Williamson sp. × 100.
 .. 9. Ditto. Ditto.
 .. 10. *Bolivina textularioides* Reuss. × 100.
 .. 11. Ditto. Ditto.
 .. 12. Ditto. Ditto.
 .. 13.—*Lagena perlucida* Williamson. × 100.
 .. 14.—*Lagena squamosa* var. *Montagui* Alcock sp. Base view. × 100.
 .. 15. Ditto. Oral view. × 100.
 .. 16.—*Lagena lucida* Williamson sp. Double shell. × 100.
 .. 17.—*Polymorphina acuminata* d'Orbigny sp. × 100.
 .. 18. Ditto. Ditto.
 .. 19.—*Dimerphina longicollis* Brady sp. × 100.
 .. 20.—*Discorbina rosacea* var. *selseyensis* var. nov. Superior side. × 100.
 .. 21. Ditto. Inferior side. × 100.
 .. 22. *D. patelliformis* var. *corrugata* var. nov. Inferior side. × 100.
 .. 23. Ditto. Superior side. × 100.
 .. 24. Ditto. Edge view. × 100.

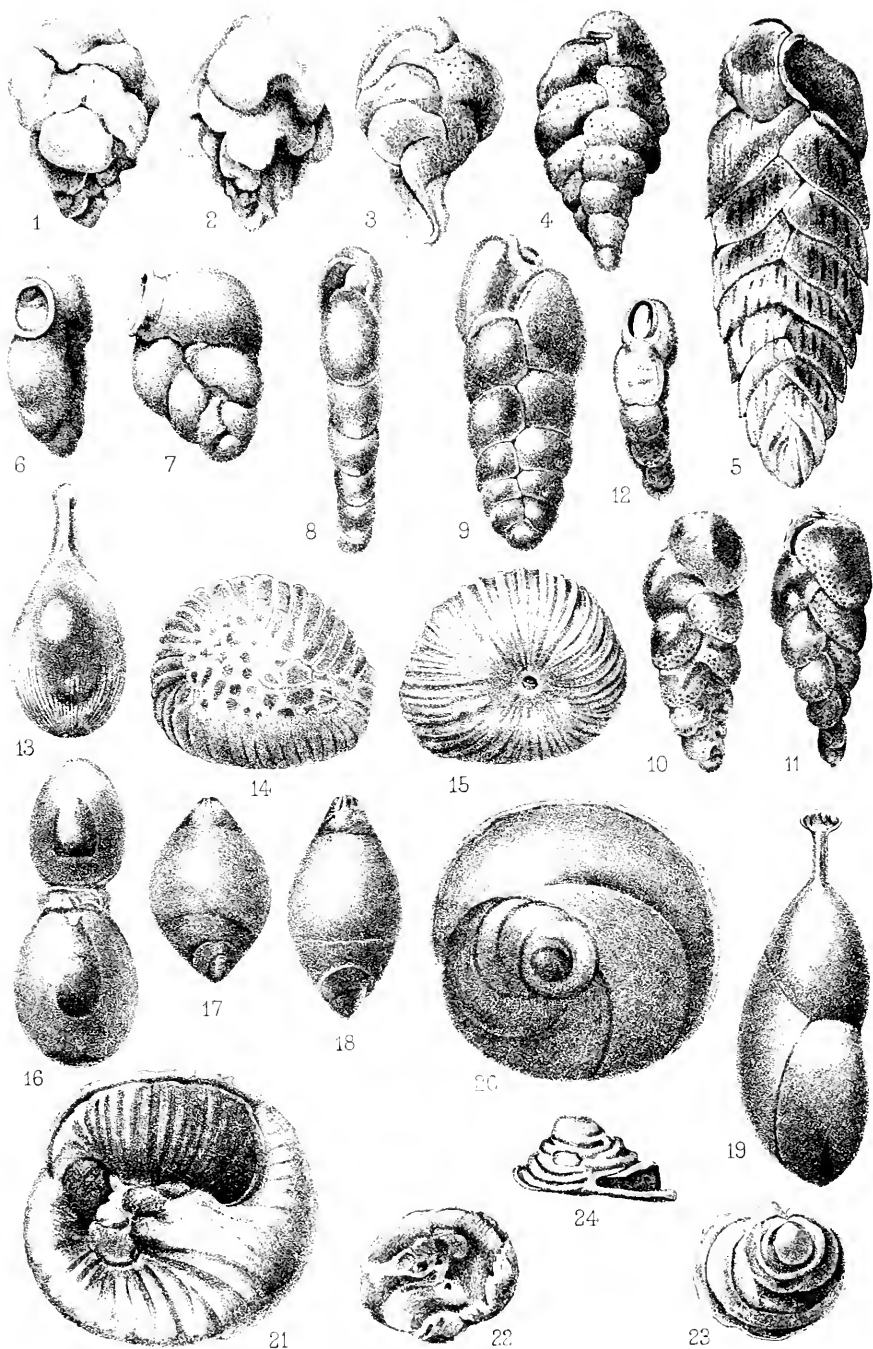

321. *Haplophragmium nanum* Brady.

(Plate IX. figs. 9-11.)

Haplophragmium nanum Brady, 1881, Quart. Journ. Micr. Sci., vol. xxi., N.S. p. 50.

Ditto. Brady, 1881, Denkschr. d. k. Akad. Wiss. Wien, vol. xliii. p. 99, pl. ii. fig. 1.

Ditto. Brady, 1884, Foram. 'Challenger,' p. 311, pl. xxxv. figs. 6-8.

Ditto. Brady, 1894, Goës, Arctic and Scandinavian Foram., p. 22, pl. v. figs. 124-127.

One very typical specimen, to all appearances recent, which presents the usual rotaliform character of the species. It presents a somewhat curious feature, inasmuch as the sutures are marked by a sort of thickening of the sandy deposit, giving them a limbate appearance. Most of the records of this form are from Arctic seas; otherwise it appears to be purely a deep-water form.

50. *Trochammina papillata* Brady.

A few further fragments have been found of the organism we described as referable to this species, but not in such a condition as to enable us to modify or amplify the views that we originally expressed.

322. *Trochammina rotaliformis* J. Wright MS.*Trochammina inflata* (Montagu) var. Balkwill and Wright, 1885, Trans. R. Irish Acad., vol. xxviii. (Science) p. 331, pl. xiii. figs. 11, 12.

Ditto. (Montagu) var. Balkwill and Wright, 1892, Chaster, First Rep. Southport Soc. Nat. Sci. (1890-1), p. 58.

A single well-developed recent specimen, which has been submitted to Mr. J. Wright and identified by him. As Mr. Wright will, we understand, describe and figure the variety shortly under the name *rotaliformis*, we refrain from further particulars of the variety, which has not hitherto been accorded a distinctive name, although presenting well-marked characteristics.

Chaster describes it as "rather rare" in most of his Southport gatherings. The same remarks apply to its distribution in Earland's North Sea dredgings, in many of which an occasional specimen may be found. It is of more frequent occurrence in the dredgings taken near the Norwegian coast.

323. *Testalucia concava* Karrer sp.*Plectanium concavum* Karrer, 1868, Sitzungsber. d. k. Akad. Wiss. Wien., vol. lviii. pt. i. p. 129, pl. i. fig. 3.*Testalucia concava* (Karrer) Brady, 1884, Foram. 'Challenger,' p. 360, pl. xlii. figs. 13, 14; pl. xliii. fig. 11.*Testalucia* (?) *concava* (Reuss) Egger, 1893, Abhandl. k. bayer. Akad. Wiss., Cl. II. vol. xviii. p. 271, pl. vi. figs. 3, 4.

Ditto. (Karrer) Millett, 1899, Journ. R. Micr. Soc., p. 559, pl. vii. fig. 5.

Two specimens which we think should be attributed to this species have been found. They are fossils, somewhat pyritized,

and probably derived from a Tertiary clay. They differ somewhat from Karrer's specimens in respect of the rapidly increasing breadth of the shell, which is also of practically uniform thickness from the initial to the final chambers, i.e. the opposite faces of the shell are practically parallel. Karrer's specimens were from the Miocene of Kostej in the Banat. As a recent species it occurs in all the great oceans, most of the records being from deep water.

324. *Tectularia inconspicua* (Brady) var. *jugosa* Brady.

(Plate IX. fig. 12.)

Tectularia jugosa Brady, 1884, Foram. 'Challenger,' p. 358, pl. xlii. fig. 7.
Ditto. (Brady) Egger, 1893, Abhandl. k. bayer. Akad. Wiss., Cl. II. vol. xviii. p. 273, pl. vi. figs. 19-21.

Tectularia inconspicua var. *jugosa* (Brady) Millett, 1899, Malay Foram., Journ. R. Micr. Soc., p. 558, pl. vii. fig. 2.

A single, well preserved, and typical fossil specimen which agrees perfectly with Brady's type figure (*supra*). The shell is hyaline and the sutures very strikingly limbate.

Millett (*supra*) goes at some length into the relationship of this variety with other species.

The variety is at the present day confined to tropical and sub-tropical seas. Our knowledge of its geological range is somewhat doubtful, for reasons explained by Millett.

325. *Tectularia rugosa* Reuss sp.

Plecanium rugosum Reuss, 1869, Sitzungsab. d. k. Akad. Wiss. Wien., vol. lix. p. 453, pl. i. fig. 3 *a, b*.

Tectularia rugosa (Reuss) Brady, 1884, Foram. 'Challenger,' p. 363, pl. xlii. figs. 23, 24.

A few small fossil specimens which present the characteristic plications of the chambers which mark this species. At the present day this is a tropical shallow-water species and under favourable circumstances reaches a very large size. We have specimens from the Philippine Islands $\frac{1}{8}$ inch in length. The original record by Reuss was from the Oligocene of the south of France.

326. *Spiroplecta bifurmis* Parker and Jones sp.

Tectularia agglutinans var. *bifurmis* Parker and Jones, 1865, Phil. Trans., vol. clv. p. 370, pl. xv. figs. 23, 24.

Tectularia bifurmis (Parker and Jones) Brady, 1878, Ann. and Mag. Nat. Hist., ser. 5, vol. i. p. 436, pl. xx. fig. 8.

Spiroplecta bifurmis (Parker and Jones) Brady, 1884, Foram. 'Challenger,' p. 376, pl. xlv. figs. 25-27.

Ditto. (Parker and Jones) Balkwill and Wright, 1885, Trans. R. Irish Acad., vol. xxviii. Sci. p. 333, pl. xiii. fig. 21 and woodcut fig. 2.

Ditto. (Parker and Jones) Brady, 1887, Synopsis British Recent Foraminifera.

Ditto. (Parker and Jones) Millett, 1900, Malay Foram., Journ. R. Micr. Soc., p. 8, pl. i. fig. 8.

One small fossil specimen of cretaceous origin. The species has been recorded as far back as the Gault, and as a recent species it

seems to be principally confined to cold areas in high latitudes, although the 'Challenger' report records it from the South Atlantic and South Pacific in depths from 1900 to 2375 fathoms.

69. *Spiroplecta fusca* Earland.

Many typical specimens of this species have been found in the shore-sand opposite Mednerry Farm.

327. *Gaudryina filiformis* Berthelin.

Gaudryina filiformis Berthelin, 1880, Mem. Soc. Géol. France, ser. 3, vol. i. No. 5, p. 25, pl. i. fig. 8.

Ditto. (Berthelin) Wright, 1882, Proc. Belfast Nat. Field Club (1880-1), App. p. 180, pl. viii. fig. 3.

Ditto. (Berthelin) Brady, 1884, Foram. 'Challenger,' p. 380, pl. xlvi. fig. 12.

Ditto. (Berthelin) Brady, 1887, Synopsis British Recent Foraminifera.

Ditto. (Berthelin) Brady, Parker and Jones, 1888, Trans. Zool. Soc., vol. xii. p. 219, pl. xlii. fig. 6.

Ditto. (Berthelin) Millett, 1900, Malay Foram., Journ. R. Micr. Soc., p. 9.

A few very fine and perfect specimens, probably Cretaceous. The triserial portion is very indistinct, the initial chamber is markedly megalospheric, the apex of the shells in fact terminating in a little spherical bulb. The largest specimen has no less than sixteen series of chambers. *G. filiformis* was originally described from Gault fossils from the north of France. It is fairly widely distributed in the recent condition, and small specimens are not uncommon in dredgings from the Shetland-Faeroe area.

328. *Clavulina obscura* Chaster.

Verrucilina polystropha Reuss sp., dimorphous form, Wright, 1886, Proc. Belfast Nat. Field Club (1885-6), App. p. 320, pl. xxvi. fig. 2.

Clavulina obscura Chaster, 1892, First Rep. Southport Soc. Nat. Sci. (1890-1), p. 58, pl. i. fig. 4.

Ditto. (Chaster) Earland, 1905, Journ. Quekett Micr. Club, ser. 2, vol. ix. No. 57, p. 206.

Recent specimens. This little species, originally described by Chaster from shore-mud and shallow dredgings at Southport (Lancs.), may be nothing more than a starved form of *Clavulina parisiensis* (d'Orb.), with which it agrees in the general formation of the test and the triangulation of the earlier chambers. It is probably widely distributed, although owing to its small size the records are few. Wright has recorded it from shallow water off Ireland, and Earland has records from anchor-mud, Valetta (Malta), and several of the 'Goldseeker' dredgings in the North Sea.

329. *Bulimina elegantissima* (d'Orbigny) var. *seminuda* Terquem.

Bulimina seminuda Terquem, 1882, Mém. Soc. Géol. France, sér. 3, vol. ii. Mém. 3, p. 117, pl. xii. fig. 21.

Bulimina elegantissima var. *seminuda* (Terquem) Brady, 1884, Foram. 'Challenger,' p. 403, pl. l. figs. 23, 24.

Many specimens, fossils from an Eocene sand. Terquem's specimens were from the Eocene beds of Paris. Ours show a con-

siderable variation in the relative length and breadth of the shell, which may indicate two different sources of origin, especially as the texture of the shell differs in the two forms.

330. *Balinina fusiformis* Williamson.

Balinina papoïdes (d'Orbigny) var. *fusiformis* Williamson, 1858, Recent British Foraminifera, p. 63, figs. 129, 130.

Balinina presti var. *ovata* (d'Orbigny) Parker and Jones, 1862, Carpenter's Introduction to the Foraminifera, p. 311.

Balinina fusiformis (Williamson) Brady, 1887, Synopsis British Recent Foraminifera.

Ditto. (Williamson) Wright, 1900, Geol. Mag., ser. 4, vol. vii. p. 100, pl. v. fig. 5.

Ditto. (Williamson) Millett, 1900, Malay Foram., Journ. R. Micr. Soc., p. 275, pl. ii. fig. 2.

With one or two exceptions the specimens are pyritized fossils. Parker and Jones (*supra*) in their identification of Williamson's figures, ascribed this species to *B. ovata* d'Orbigny, but, as pointed out by Brady (*supra*), Williamson's type is very distinct, and we do not see any grounds for suppressing it. It is not very frequently met with in shore gatherings, but it is very abundant in most muddy dredgings made round the British Islands, and we have observed it in many similar gatherings from nearly all parts of the world. Millett's record is from the Malay Seas, where he states that the specimens, "although neither numerous nor widely distributed, are sufficiently characteristic."

Joseph Wright (*supra*) states that it is common in the Post-Glacial beds of Cheshire.

331. *Balinina marginata* d'Orbigny.

Balinina marginata d'Orbigny, 1826, Ann. Sci. Nat., vol. vii. p. 269, No. 4, pl. xii. figs. 10-12.

Balinina papoïdes var. *marginata* (d'Orbigny) Williamson, 1858, Recent Foram. Great Britain, p. 62, pl. v. figs. 126, 127.

Balinina presti var. *marginata* (d'Orbigny) Parker and Jones, 1865, Phil. Trans., vol. clv. p. 372, pl. xv. fig. 10; pl. xvii. fig. 70.

Balinina marginata (d'Orbigny) Brady, 1884, Foram. Challenger, p. 405, pl. li. figs. 3-5.

Ditto. (d'Orbigny) Brady, 1887, Synopsis British Recent Foraminifera.

Ditto. (d'Orbigny) Goës, 1894, Arctic and Scandinavian Foram., p. 46, pl. ix. figs. 439-444.

Numerous specimens, the majority recent, the others fossil. As usual, the specimens show a tendency to vary in the direction of *B. aculeata*. *B. marginata* is very abundant in the recent condition in the Atlantic, as far north as the Norwegian Fiords, although Brady states that there is no certain record farther north than the Faeroe Channel. It has been recorded in the fossil state from the Tertiaries of Italy and from post-Tertiary deposits in Norway, Scotland, and Ireland.

332. *Bulimina papa* Terquem.

Bulimina papa Terquem, 1882, Mém. Soc. Géol. France, ser. 3, vol. ii. Mém. 3, p. 116, pl. xii. fig. 18.

One specimen only. Fossil. Terquem's species, although obviously closely allied to *B. elegantissima* d'Orbigny, is yet sufficiently distinctive to merit separation. His figure differs from *B. elegantissima* in its more regular contour and neatness. The shell is almost cylindrical in shape with rounded extremities, and only one series of chambers is visible, externally wound in an elongate spiral round the central axis. The sutures are flush with the surface of the shell and the "comma" shaped aperture is set on the flat face of the final segment.

Terquem's specimens were fossils from the Eocene of Vaudancourt, "very rare."

333. *Bulimina selseyensis* sp. n.

(Plate X. figs. 1, 2.)

The specimen figured is a fossil, and was at first regarded as an abnormal specimen of *Uvigerina selseyensis* (Heron-Allen and Earland), but closer examination having determined the entire absence of Uvigerine aperture and the presence of a distinctly Bulimine opening on the side of the shell, we can only regard it as a Bulimine isomorph of that species, from which it differs externally in its broader and stouter build. It consists of four or five convolutions of heart-shaped chambers arranged round a spiral axis, the narrow ends being disposed towards the oral end of the shell. The sutural lines were deeply undercut as in *U. selseyensis*. The species is possibly of much more frequent occurrence than is apparent, as specimens would be readily confused with *U. selseyensis*, which is very common.

Length, 0.25 mm. Greatest breadth, nearly 0.2 mm.

Bulimina striato-punctata Terquem.

Bulimina striato-punctata Terquem, 1882, Mém. Soc. Géol. France, sér. 3, vol. ii. Mém. 3, p. 116, pl. xii. fig. 19.

This form is also obviously near to *B. elegantissima* (d'Orbigny), but is characterized by the foramina being placed in regular lines, so that there is a superficial appearance of external striation. The sutures are flush and the sides of the shell are almost parallel, the aboral end being a blunt cone and the aperture set on the flattened face of the terminal chamber.

Terquem's specimens were Eocene fossils from Septeuil, near Paris; "very rare."

We have several specimens, obviously fossil, which may be referred to this species, as they possess the linear punctation characteristic of Terquem's form.

335. *Bulimina subteres* Brady.

Bulimina pestis var. *deputatissima* (d'Orbigny) Parker and Jones, 1865, Phil. Trans., vol. clv. p. 371, pl. xv. figs. 12-17.

Bulimina deputatissima (d'Orbigny) var. Brady, 1878, Ann. and Mag. Nat. Hist., ser. 5, vol. i. p. 136, pl. xxi. fig. 12.

Bulimina subteres Brady, 1881, Quart. Journ. Micr. Sci., vol. xxi. N.S. p. 55.
Ditto. (Brady) Wright, 1882, Proc. Belfast Nat. Field Club (1880-1), Appx. p. 180, pl. viii. fig. 2.

Ditto. (Brady) Brady, 1884, Forum. 'Challenger,' p. 403, pl. l. figs. 17-18.

Ditto. (Brady) Goss, 1891, Arctic and Scandinavian Foraminifera, p. 46, pl. ix. figs. 445-453.

One specimen from the general shore sand, a pyritized fossil. In the recent condition *B. subteres* is widely distributed, especially in high latitudes, but so far as we are aware it has not previously been recorded as a fossil. If its distribution at the present day may be regarded as any clue to the origin of our specimen, it points to its derivation from a Glacial, or post-Glacial deposit.

336. *Bulimina Terquemiana* sp. n.

(Plate IX. figs. 13, 14.)

Bulimina obliqua Terquem, 1882, Mém. Soc. Géol. France, sér. 3, vol. ii. Mém. 3, p. 118, pl. xii. fig. 23.

We have two specimens of the pretty little form figured and described by Terquem under the name of *B. obliqua*. As, however, the specific name *obliqua* has already been used by d'Orbigny for a distinct form, we have associated Terquem's specimens with the name of the author. His description is as follows: "Shell irregular, more developed on one side than the other; sub-rotund, enlarged anteriorly, domed posteriorly, and furnished with a small spur. Domed on one side and incurved on the other; ornamented with very fine and curved sulci. Formed of three whorls of prominent spiral layers, oblique, elongated, chambers indistinct, the last whorl highly developed, aperture round, situated in a very large lateral depression of a pointed oval shape furnished with a thickened rim. Terquem's specimens were from the Eocene of Septeuil, near Paris—very rare—and ours are doubtless fossils derived from a similar formation.

Length, 0·27 mm. Breadth, 0·18 mm.

82. *Virgulina subsquamosa* Egger.

Many further specimens have been found, both recent and fossil.

337. *Bulimina Durrandii* Millett.

(Plate X. fig. 5.)

Bulimina Durrandii Millett, 1900, Malay Forum., Journ. R. Micr. Soc., p. 544, pl. iv. fig. 7.

One large and very fine specimen of unquestionably recent origin.

The finding in an English shore gathering of this unique and well developed specimen of a species known hitherto only from the Malay Archipelago, represents possibly the greatest surprise of the whole collection, and illustrates the glorious uncertainty of work among the Foraminifera. The specimen has been submitted to Mr. Millett, who agrees with our identification. Similar abnormal occurrences are well known to all rhizopodists, and have sometimes been regarded as due to the use of sieves which had not been effectually cleaned after use with other material, but such an objection is discounted in this instance by the fact that the sieves used for the Selsey material were new when first taken into use and have been religiously preserved for Selsey gatherings only.

Millett's specimens were from various localities in the Malay Archipelago, where it is one of the most typical and abundant species. We have met with it in anchor mud from Singapore, but the specimens were much smaller than our Selsey find.

338. *Bolivina coccaenica* Terquem.

(Plate X. figs. 6, 7).

Bolivina coccaenica Terquem, 1882, Mém. Soc. Géol. France, sér. 3, vol. ii. Mém. 3, p. 148, pl. xv. fig. 18 *a, b*.

Bolivina gibbera Millett, 1894, Trans. R. Geol. Soc. of Cornwall, p. 2, figs. 1, 2.

We have one perfect fossil specimen, which agrees very closely with Millett's figure and description except in one or two minor points. The sutures in our specimen are not so deeply sunk as in Millett's figures, with the result that the chambers appear less inflated than in the St. Erth specimens. The aperture in ours is circular, as in Millett's fig. 2.

Millett's record was from the Pliocene beds of St. Erth in Cornwall—"frequent." His description of the test is as follows: "Test ovoid, compressed, margin obtuse, lobulated, segments few and inflated, sutures deeply sunk, surface minutely punctate, aperture panduriform, sometimes circular, surrounded by a thickened lip, and situated in a more or less produced neck. This species is nearly allied to *B. textuarioides*."

Terquem in 'Les Foraminifères de l'Eocène de Paris' has figured under the name of *Bolivina coccaenica* a form which we take to be identical with Millett's species. His description is as follows: "Shell oval, compressed, smooth, not perforate, anteriorly broadened, posteriorly narrowed and obtuse, rounded as to the periphery and furnished with a blunt keel, composed of few chambers, rounded, increasing regularly, the last two being triangular; aperture at the side of the last chamber, occupying its entire breadth, funnel shaped ("panduriform"—Millett) with a thick lip, at the bottom of which is an oval opening."

It will thus be seen that the principal difference between the

two descriptions lies in the fact that Terquem's species had a more or less carinated edge: this, however, is a feature of practically no more than varietal importance. The constriction of the last chamber in front of the oral aperture is much more pronounced in Millett's figures than in Terquem's, and this gives an air of greater refinement and symmetry to the contour of the St. Erth specimen as compared with Terquem's somewhat clumsy figure. Terquem does not note it as being rare; according to Millett the species is frequent in the Pliocene of St. Erth in Cornwall.

Length, 0·27 mm. Breadth, 0·19 mm.

339. *Bolivina robusta* Brady.

- Bolivina robusta* Brady, 1881, Quart. Journ. Micr. Sci., vol. xxi. N.S. p. 57.
 Ditto. (Brady) 1884, Foram. 'Challenger,' p. 421, pl. liii. figs. 7-9.
 Ditto. (Brady) Egger, 1893, Abhandl. k. bayer. Akad. Wiss., Cl. II. vol. xviii. p. 291, pl. viii. figs. 31, 32.
 Ditto. (Brady) Millett, 1900, Malay Foraminifera, Journ. R. Micr. Soc., p. 543.

A few specimens, apparently fossil, from a Tertiary shell-sand.

340. *Bolivina testularioides* Reuss.

(Plate X. figs 10-12.)

- Bolivina testularioides* Reuss, 1862, Sitzungsber. d. k. Akad. Wiss. Wien., vol. xlvi. p. 81, pl. x. fig. 1.
 Ditto. (Reuss) Brady, 1884, Foram. 'Challenger,' p. 419, pl. lii. figs. 23-25.
 Ditto. (Brady) Millett, 1900, Malay Foraminifera, p. 542, pl. iv. fig. 5.
Bolivina lavigata (Williamson) Heron-Allen and Earland, 1909, Journ. R. Micr. Soc., p. 335.

In the second number of our series of papers we described our specimens with reservations under the name *Bolivina lavigata* Williamson sp. After fuller consideration, and after examining a considerable series of specimens of Williamson's type dredged in

EXPLANATION OF PLATE XI.

- Fig. 1.—*Discorbina pilvulus* d'Orbigny sp. Superior view. × 100.
 .. 2. Ditto. Inferior view. × 100.
 .. 3.—*Discorbina inæquilateralis* sp. n. Superior view. × 100.
 .. 4. Ditto. Inferior view. × 100.
 .. 5. Ditto. Edge view. × 100.
 .. 6.—*Pulvinulina haliolidea* sp. n. Inferior view. × 100. Selsey specimen.
 .. 7. Ditto. Ditto.
 .. 8. Ditto. Ditto.
 .. 9. Ditto. Edge view. × 100.
 .. 10. Ditto. Superior view. × 100.
 .. 11. Ditto. Ditto.
 .. 12.—*Nonionina quadriloculata* sp. n. Oral view. × 100.
 .. 13. Ditto. Side view. × 100.
 .. 14. Ditto. Ditto.
 .. 15. Ditto. Ditto.
 .. 16.—*Nonionina pumperata* Balkwill and Wright. Side view. × 100.
 .. 17. Ditto. Oral view. × 100.

(Figs. 7-11 are drawn from North Sea specimens.)



1

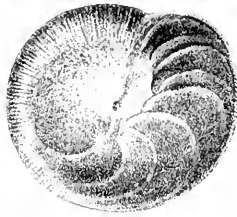

2



3

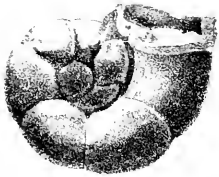

6



5

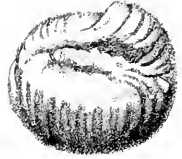

4



9



7



8



10



11



12

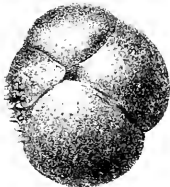

13

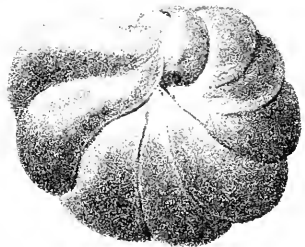

16

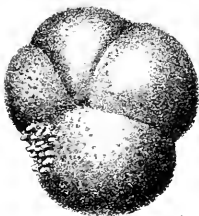

14

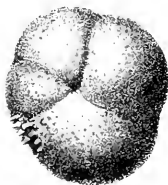

15



17

the North Sea, we are no longer able to agree with Balkwill, Millett and Brady in the identification of *B. levigata* with *B. textilarioides*. Williamson's species, which has a peculiarly characteristic initial portion and an entire absence of that roughened granular deposit in the neighbourhood of the sutures which is so characteristic of the type commonly referred to *B. textilarioides* Reuss, exists side by side with Reuss' type in many of Earland's North Sea dredgings, but we have failed to trace any specimens showing characters intermediate between the two species.

Our Selsey gatherings afford abundant instances of Reuss' type as figured by Brady, but none resembling Williamson's species, and we therefore withdraw *B. levigata* from the list and substitute *B. textilarioides*. We have figured both forms in order to show the differences to which we refer. The Selsey specimens are mostly fossils, but there are several which to all appearance are of recent origin.

341. *Bolivina tortuosa* Brady.

(Plate X. figs. 3, 4.)

- Bolivina tortuosa* Brady, 1881, Quart. Journ. Micr. Sci., vol. xxi. N.S. p. 57.
 Ditto. (Brady) Brady, 1884, Foram. 'Challenger,' p. 420, pl. lii. figs. 31-34.
 Ditto. (Brady) Egger, 1893, Abhandl. k. bayer. Akad. Wiss., Cl. II. vol. xviii. p. 298, pl. viii. figs. 43, 44.
 Ditto. (Brady) Millett, 1900, Malay Foraminifera, p. 543.
 Ditto. (Brady) Earland, 1905, Journ. Quekett Micr. Club, ser. 2, vol. ix. No. 57, p. 209.

A few good and typical recent specimens.

The species, which is of fairly frequent occurrence in warm seas, was first recorded in Britain by Earland (*supra*) from the neighbouring locality of Bognor. It does not appear to have been met with otherwise in Great Britain.

248. *Ellipsoidella pleurostomelloides* (H.-A. and E.).

Since the publication of our description and figures of *Ellipsoidella*, Mr. F. W. Millett has drawn our attention to two papers by Sig. Alfredo Silvestri,* in which that eminent and industrious rhizopodist has already adumbrated the presence of the peculiar internal tube or siphon (which characterizes our genus), in connexion with other allied forms; cf. *Pleurostomella*, *Bulimina*, *Glandulina*, *Polymorphina*, etc. Dr. Silvestri's papers, to which we have devoted considerable and careful attention, are extremely interesting and suggestive, but a good deal of the matter seems to be of a theoretical nature. It appears to us somewhat doubtful whether his conclusions were arrived at as the result of a sufficiently ex-

* I. A. Silvestri, Atti R. Accad. Sci. di Torino, vol. xxxviii. 1902-3, p. 206 "Alcune osservazioni sui Protozoi fossili piemontesi." 2. Mem. Pontif. Accad. Rom. dei Nuovi Lincei, vol. xxiii. p. 235. "Ricerche strutturali su alcune forme dei Trubi di Bonfornello (Palermo)." Rome, 1904.

tended examination of the material in which these phenomena are to be observed, and whether the creation of new genera (*Ellipsoglandulina*, *Ellipsobulimina*, *Ellipsopolymorphina*) would be valid in the absence of specific forms for which such generic names would appear to be required. All these "Ellipsoidiniform" types are so rare, and so highly localized, that it occurs to us that the whole problem of their structure, and still more of their affinities, is still a matter of conjecture, and one requiring more extended and particular research; and it appears to us that the creation of such genera, pending such research, is likely to tend to confusion, and to increase the difficulties which already beset the enquiry.

Since reading Dr. Silvestri's papers we have made a further study of considerable minuteness of such material as is available to us, including transparent preparations of particularly well preserved specimens, with the result that we find that the internal siphon is not by any means a constant feature in *Pleurostomella alternans* Schwager. It is sometimes entirely absent, although a superficial observer might be misled by the refraction of the inner walls of the chambers so far as to conclude that the inward siphon, as figured by Beïssel and Silvestri, is uniformly present.

As to whether there are two distinct but isomorphic types, viz. *Pleurostomella* devoid of siphon, and *Ellipsopleurostomella*, Silvestri, (= *Ellipsoidella* Heron-Allen and Earland), in which the siphon is normally present, or whether these two apparently distinct forms are identical, i.e., that the siphon is a growth accessory to the full development of the shell, we are not at present in a position to express an opinion. We can only hope that the further researches promised by Dr. Silvestri will clear up this uncertainty, and throw additional light on this interesting group of Rhizopods. Pending such further investigations, it appears that our generic name must be withdrawn in favour of Dr. Silvestri's earlier but, in our opinion, less felicitous, title, *Ellipsopleurostomella*.

104. *Lagena lucida* Williamson sp.

(Plate X. fig. 16.)

We figure a particularly fine double specimen which we have found. Twin *Lagenæ* are very uncommon, and, so far as our experience goes, double specimens are always joined mouth to base, as in the figure, and not mouth to mouth as usual in plastogamic specimens in other genera. The abnormality is therefore probably due to budding, and not to true plastogamy.

342. *Lagena bicarinata* Terquem sp.

Fissurina bicarinata Terquem, 1882, Mém. Soc. Géol. France, sér. 3, vol. ii. Mém. 3, p. 31, pl. i. fig. 24.

Lagena bicarinata (Terquem) Balkwill and Millett, 1884, Journ. Micr. vol. iii. p. 82, pl. ii. fig. 4, and trifacial pl. iii. fig. 9.

- Lagena bicarinata* (Terquem) Balkwill and Wright, 1885, Trans. R. Irish Acad., vol. xxviii. (Science) p. 312, pl. xii. fig. 30.
 Ditto. (Terquem) Wright, 1886, Proc. Belfast Nat. Field Club, Appx. ix. p. 320, pl. xxvi. fig. 8.
 Ditto. (Terquem) Brady, 1887, Synopsis British Recent Foraminifera.
 Ditto. (Terquem) Millett, 1901, Malay Foraminifera, Journ. R. Micr. Soc., p. 624, pl. xiv. fig. 13.

Two specimens, both clearly fossil, but from different deposits. One apparently Cretaceous, the other probably from a Tertiary sand. Both the specimens are quite plain on the surface, and devoid of the peculiar thickened and concentric ring of shell-substance which Terquem figures in his fossil specimens from the Eocene of Paris. We have not observed this concentric thickening in any of the numerous recent specimens from various localities which have come under our observation. The species, though never very abundant, has a practically world-wide distribution.

343. *Lagena gracillima* Seguenza sp.

- Amphorina gracilis* Costa, 1856, Atti dell' Accad. Pont., p. 121, pl. xi. fig. 11.
Amphorina gracillima Seguenza, 1862, Forum. Monotal. Mess., p. 51, pl. i. fig. 37.
Lagena gracillima (Seguenza) Jones, Parker and Brady, 1866, Monogr. Forum. Crag, p. 45, pl. i. figs. 36, 37.
 Ditto. (Seguenza) Brady, 1870, Edinburgh Catalogue, p. 4.
 Ditto. (Seguenza) Brady, 1884, Forum. 'Challenger,' p. 456, pl. lvi. figs. 19-28.
 Ditto. (Seguenza) Brady, 1887, Synopsis British Recent Foraminifera.
 Ditto. (Seguenza) Millett, 1901, Malay Foraminifera, Journ. R. Micr. Soc., p. 491.

One or two specimens, recent, rather weak, representing passage forms between *L. clarata* and *L. gracillima*.

344. *Lagena hispida* Reuss.

- Lagena hispida* Reuss, 1858, Zeitschr. d. deutsch. geol. Gesellsch., vol. x. p. 434.
 Ditto. Reuss, 1863, Sitzungsber. d. k. Akad. Wiss. Wien., vol. xlvi. p. 335, pl. vi. figs. 77-79.
Lagena Jeffreyssi Brady, 1866, Report Brit. Assoc., Trans. Sections, p. 70.
Lagena hispida (Reuss) Jones, Parker and Brady, 1866, Monogr. Forum. Crag, p. 30, No. 15.
 Ditto. (Reuss) Brady, 1884, Forum. 'Challenger,' p. 459, pl. lviii. figs. 1-4; pl. lix. figs. 2, 5.
 Ditto. (Reuss) Brady, 1887, Synopsis British Recent Foraminifera.
 Ditto. (Reuss) Millett, 1901, Malay Foraminifera, Journ. R. Micr. Soc., p. 6.

The specimens are perfect and characteristic, and probably fossil. The fine spines with which the specimens were originally covered have been worn down, leaving nothing but a shagreen-like texture of the shell. The specimens are probably derived from Tertiary sands, as they have the appearance characteristic of such fossils.

One of them has a long neck devoid of external ornament, another is entosolenian with a small produced external aperture. The affinities between the rugose *Lagena* have been recently made the subject of an ingenious study by Signor Fornasini.*

315. *Lagena lineata* Williamson sp.

Entosolenia lineata Williamson, 1848, Ann. and Mag. Nat. Hist., ser. 2, vol. i. p. 18, pl. ii. fig. 18.

Entosolenia globosa var. *lineata* Williamson, 1858, Recent Foraminifera of Great Britain, p. 9, pl. i. fig. 17.

Lagena caudata (d'Orbigny) Parker and Jones, 1862, Carpenter's Introduction to the Foraminifera, Appx. p. 309.

Lagena lineata (Williamson) Reuss, 1863, Sitzungsab. d. k. Akad. Wiss. Wien, vol. xlvi. p. 328, pl. iv. fig. 48.

Ditto. (Williamson) Brady, 1884, Foram. 'Challenger,' p. 461, pl. lvii. fig. 13.

Ditto. (Williamson) Brady, 1887, Synopsis British Recent Foraminifera.

Ditto. (Williamson) Millett, 1901, Malay Foraminifera, Journ. R. Micr. Soc., p. 7.

Numerous specimens, the majority recent, a few pyritized fossils. The species is common in recent British shore-gatherings and has been recorded from Post-Tertiary deposits in Scotland and Ireland.

316. *Lagena orbignyana* var. *walleriana* J. Wright.

Lagena orbignyana var. *walleriana* Wright, 1886, Proc. R. Irish Acad., ser. 2, vol. iv. p. 611; and *ibid.* 1891, ser. 3, vol. i. p. 481, pl. xx. fig. 8.

Ditto. (Wright) Millett, 1901, Malay Foraminifera, Journ. R. Micr. Soc., p. 627, pl. xiv. fig. 19.

One specimen, fossil, probably from an Eocene shell sand. This variety, which has the centre of the convex faces ornamented with a solid boss of shell-substance, was recorded by Wright from dredgings at various depths off the south coast of Ireland, but does not appear to have been noticed previously in the fossil condition, although its fossil distribution probably coincides more or less with that of the type, i.e. from the commencement of Tertiary times.

317. *Lagena perlucida* Williamson.

(Plate X. fig. 13.)

Lagena vulgaris var. *perlucida* Williamson, 1858, British Recent Foraminifera, p. 5, figs. 7, 8.

Many typical examples, all recent.

Williamson's figures represent transition types between *L. lewis* Montagu sp. and *L. semistriata* Will sp. and *L. sulcata* W. & J. sp., but hardly referable to any of these three species.

As such they are perhaps worth recording under their original name, although having no specific value.

* C. Fornasini, Revisione delle *Lagena* scabre fossili in Italia. R. Accad. Sci. dell' Ist. di Bologna, 27 Feb. 1910.

348. *Lagena quadrata* Williamson sp.

Entosolenia marginata var. *quadrata* Williamson, 1858, Rec. Foram. of Gt. Britain, p. 11, pl. i. figs. 27, 28.

Lagena lucida var. *quadrata* (Williamson) Reuss, 1862, Sitz. k. Akad. Wiss. Wien, vol. xlvi. p. 324, pl. ii. fig. 26.

Lagena quadrata (Williamson) Balkwill and Millett, 1884, Jour. Micr., vol. iii. p. 81, pl. ii. fig. 8.

Ditto. (Williamson) Brady, 1884, Foram. 'Challenger,' p. 475, pl. lix. figs. 3, 16; pl. lx. fig. 5.

Ditto. (Williamson) Brady, 1887, Synopsis British Recent Foraminifera.

Ditto. (Williamson) Millett, 1901, Malay Foraminifera, Journ. R. Micr. Soc., p. 496, pl. viii. fig. 18.

One specimen, probably fossil, belonging to the carinate division. There are two distinct forms commonly referred to *L. quadrata*; one, with rounded edges, the other with a carinate margin. The two forms serve to bridge the interval separating *L. lorigata* from *L. marginata*.

349. *Lagena squamosa* var. *Montaguï* Alcock sp.

(Plate X. figs. 14, 15.)

Entosolenia Montaguï Alcock, 1865, Proc. Lit. and Phil. Soc. Manchester, vol. iv. No. 15.

Lagena squamosa var. *Montaguï* (Alcock) J. Wright, 1900, Irish Naturalist, vol. ix. No. 3, p. 54, pl. ii. fig. 2.

Ditto. (Alcock) Earland, 1905, Journ. Quekett Micr. Club, ser. 2, vol. ix. No. 57, p. 212.

The large wild-growing variety of *L. squamosa* originally described by Alcock under the name *Entosolenia Montaguï* occurs at Selsey occasionally, as elsewhere whenever the type is abundant. We figure a specimen, however, which is rather noticeable owing to the fact that it combines the typical reticulate areolations with irregular costæ.

The specific name *Montaguï** has recently been employed by Silvestri for spherical ento-ecto-solenian varieties of *L. hexagona* (Williamson sp.). The employment of a specific name which has already been allocated to a distinctive variety of a closely allied species seems to us likely to tend to confusion, and is greatly to be deplored.

350. *Lagena costata* Williamson sp.

Entosolenia costata Williamson, 1858, Recent Foram. of Great Britain, p. 9, pl. i. fig. 18.

Lagena costata (Williamson) Wright, 1877, Proc. Belfast Nat. Field Club (1876-77), Appendix, p. 103, pl. iv. figs. 11-13.

Lagena salcata (Walker and Jacob) *pars* Brady, 1884, Foram. 'Challenger,' p. 462, pl. lviii. fig. 34.

* *Lagena Montaguï*, Silvestri, 1902, "Lageninae del Mare Tirreno," Mem. Pont. Acc. dei Nuovi Lincei, vol. xix. p. 153, figs. 40-43.

- Lagena costata* (Williamson) Balkwill and Wright, 1885, Trans. R. Irish Acad., vol. xxviii. (Science) p. 338, pl. xiv. figs. 3-5.
 Ditto. (Williamson) Brady, 1887, Synopsis British Recent Foraminifera.
 Ditto. (Williamson) Millett, 1901, Malay Foraminifera, Journ. R. Micr. Soc., p. 7, pl. i. fig. 8.

One fossil specimen. Although frequently regarded and figured as an entosolenian variety of *L. sulcata* (Walker and Jacob) this type has sufficiently well marked characters to deserve separation. The grooves between the prominent sulci are usually neatly rounded off and the edges of the sulci are also smooth and finished.

351. *Nodosaria arundinea* Schwager.

- Nodosaria arundinea* Schwager, 1866, Novara Exped. Geol., vol. ii. p. 211, pl. v. figs. 43-45.
 Ditto. (Schwager) Sherborn and Chapman, 1886, Journ. R. Micr. Soc., vol. vi. p. 747, pl. xiv. figs. 28, 29.

A few typical fragments of this fragile species, fossils, apparently derived from a shell-sand. The species has been recorded from the London Clay by Sherborn and Chapman (*supra*).

352. *Nodosaria calomorpha* Reuss.

- Nodosaria calomorpha* Reuss, 1865, Denkschr. d. k. Akad. Wiss. Wien, vol. xxv. p. 129, pl. i. figs. 15-19.
Nodosaria (Dentalina) consobrina (d'Orbigny) Parker and Jones, 1865, Phil. Trans., vol. clv. p. 342, pl. xvi. fig. 3.
Nodosaria calomorpha (Reuss) Brady, 1884, Foram. 'Challenger,' p. 497, pl. lxi. figs. 23-27.
 Ditto. (Reuss) Chaster, 1892, First Report Southport Soc. Nat. Sci. (1890-1891), p. 63, pl. i. fig. 12.
 Ditto. (Reuss) Goës, 1894, Arctic and Scandinavian Foraminifera, p. 72, pl. xiii. figs. 712-713.
 Ditto. (Reuss) Millett, 1902, Malay Foraminifera, Journ. R. Micr. Soc., p. 513.

One Cretaceous fossil. The fossil records are apparently confined to the Tertiary, but owing to its small size this species might be easily overlooked, and its very simple structure would lead one to expect a far greater geological age for the form.

353. *Nodosaria scalaris* Batsch sp.

- Nautilus (Orthoceras) scalaris* Batsch, 1791, Conchyl. des Seesandes, No. 4, pl. ii. fig. 4.
Nodosaria radicata (Montagu) Williamson, 1858, Recent Foram. of Great Britain, p. 15, pl. ii. figs. 36-38.
Nodosaria scalaris (Batsch) Parker and Jones, 1865, Phil. Trans., vol. clv. p. 340, pl. xvi. fig. 2.
 Ditto. (Batsch) Brady, 1884, Foram. 'Challenger,' p. 510, pl. lxiii. figs. 28-31.
 Ditto. (Batsch) Brady, 1887, Synopsis British Recent Foraminifera.
 Ditto. (Batsch) Goës, 1894, Arctic and Scandinavian Foraminifera, p. 73, pl. xiii. figs. 716-718.
 Ditto. (Batsch) Millett, 1902, Malay Foraminifera, Journ. R. Micr. Soc., p. 520, pl. xi. fig. 10.

One typical recent specimen of the type usually found in British dredgings, in which all the chambers are of practically the same diameter. This appears to be due to the large size of the primordial chamber, and may possibly represent the megalospheric form of the shell. So far as our experience goes, the species is very rarely found in shore-sands, though frequent in shallow water dredgings in temperate and tropical seas all over the world. With increasing depth the shell displays a tendency to a rapid increase in the diameter of the successive chambers, which thus become more or less spherical in shape. This again is probably due to the initial chamber being of the microspheric type, but it would require a long series of careful measurements to verify this observation, which we record without further comment.

354. *Marginalina glabra* d'Orbigny.

- Marginalina glabra* d'Orbigny, 1826, Ann. Sci. Nat., vol. vii. p. 259, No. 6;
Modèle, No. 55
Ditto. (d'Orbigny) Brady, 1870, Ann. and Mag. Nat. Hist., ser. 4, vol. vi.
p. 296, pl. xii. fig. 3.
Ditto. (d'Orbigny) Brady, 1884, Foram. 'Challenger,' p. 527, pl. lxxv. figs. 5, 6.
Ditto. (d'Orbigny) Burrows, Suerborn and Baily, 1890, Journ. R. Micr. Soc.,
p. 10, pl. x. fig. 1.
Vaginulina glabra (d'Orbigny) Goës, 1894, Arctic and Scandinavian Foraminifera, pl. xi. figs. 659-661.
Marginalina glabra (d'Orbigny) Flint, 1899, Report U.S. Nat. Museum for
1897, p. 313, pl. ix. fig. 1.
Ditto. (d'Orbigny) Millett, 1902, Malay Foraminifera, Journ. R. Micr. Soc.,
p. 526.

Several specimens, all fossil, and apparently from Tertiary shell-sands. They represent the two most widely divergent types of this extremely variable species, namely, those in which the initial spiral portion is reduced to a minimum, and is followed by a series of nodosarian chambers (compare *M. attenuata* Neugeboren, 1851, Berh. Mittl. Siebenbürgen Ver. Nat. Jahrg. ii, p. 121, pl. iv. figs. 3-6) and those in which there is a distinct spiral portion, followed by a few swollen and embracing Glanduline chambers. This variable type has been recorded as far back as the Lias, and is of frequent occurrence in the present day in dredgings at all moderate depths.

355. *Polymorphina acuminata* d'Orbigny sp.

(Plate X. figs. 17, 18.)

- Pyralina acuminata* d'Orbigny, 1840, Mém. Soc. Géol. France, vol. iv. p. 43,
pl. iv. figs. 18, 19. Facsimile in Science Gossip, 1870, p. 157,
fig. 150.
Ditto. (d'Orbigny) Reuss, 1845-6, in Geinitz, Grund. Verstein., p. 670,
pl. xxiv. fig. 64.

- Atractolina* sp. Von Schlicht, 1869, Foram. Septar. Pietzpuhl, p. 70, No. 397, pl. xxv. figs. 9, 10.
Pyralina sp. Von Schlicht, 1869, Foram. Septar. Pietzpuhl, No. 442, pl. xxv. fig. 53.
Polymorphina acuminata (d'Orbigny) Brady, Parker and Jones, 1870, Trans. Linn. Soc. Lond., vol. xxvii. p. 219, pl. xxxix. fig. 4, *a b*.

Frequent, all fossil, and from various sources.

This pretty little fusiform variety of the *lactea* type might easily be passed for a *Glandulina*, but for the oblique direction of the flush sutural lines.

It occurs in the Chalk and subsequent Eocene deposits, but is apparently an extinct variety.

356. *Polymorphina lactea* var. *amygdaloides* Reuss.

- Globulina amygdaloides* (?) Reuss, 1851, Zeitschr. d. deutsch. geol. Gesellsch., vol. iii. p. 82, pl. vi. fig. 47.
Polymorphina amygdaloides Reuss, 1855, Sitzungsber. d. k. Akad. Wiss. Wien, vol. xviii. p. 250, pl. viii. fig. 84.
Polymorphina lactea var. *amygdaloides* (Reuss) Brady, Parker and Jones, 1870, Trans. Linn. Soc. Lond., vol. xxvii. p. 214, woodcuts.
Polymorphina amygdaloides (Reuss) Brady, 1884, Foram. 'Challenger,' p. 560, pl. lxxi. fig. 13.
 Ditto. (Reuss) Millett, 1903, Malay Foraminifera, Journ. R. Micr. Soc., p. 261.

One specimen, infiltrated with pyrites, probably derived from a Tertiary clay. The variety, like the type, has a very wide range in time, and probably extends back to the Jurassic epoch. It is merely a compressed variety of *P. lactea* W. and J. sp.

132. *Polymorphina myristiformis* Williamson.

This is a frequent species in the shore-sands.

357. *Polymorphina problema* d'Orbigny.

- Polymorphina* (*Guttulina*) *problema* d'Orbigny, 1826, Ann. Sci. Nat., vol. vii. p. 266, No. 14; Module, No. 61.
Guttulina problema (d'Orbigny) d'Orbigny, 1846, Foram. Foss. Vienne, p. 224, pl. xii. figs. 26-28.
Guttulina austriaca (d'Orbigny) d'Orbigny, 1846, Foram. Foss. Vienne, p. 223, pl. xii. figs. 23-25.

EXPLANATION OF PLATE XII.

Linderina brugesii Schlumberger.

- Fig. 1.—Early stage. Side view.
 .. 2. Ditto. Ditto.
 .. 3. Ditto. Edge view.
 .. 4.—Adult stage.
 .. 5. Ditto.
 .. 6.—Horizontal section of a large specimen.
 .. 7.—Vertical section of a large specimen.

(All figures drawn to a magnification of 100 diameters.)

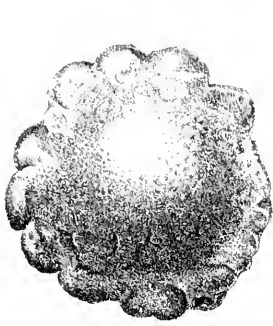

4



3

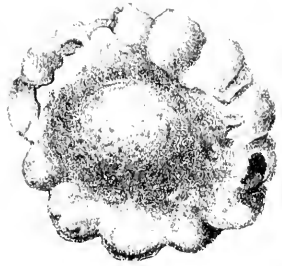

5

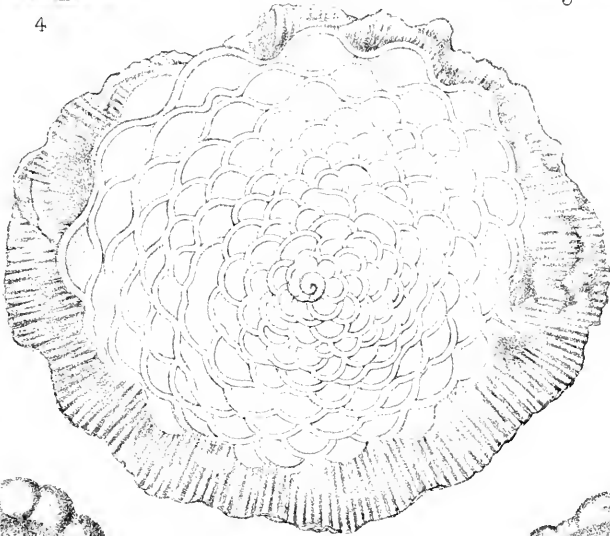

6

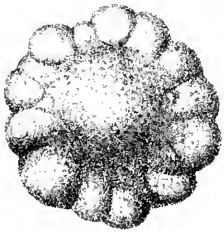

1

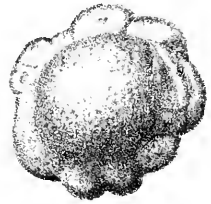

2

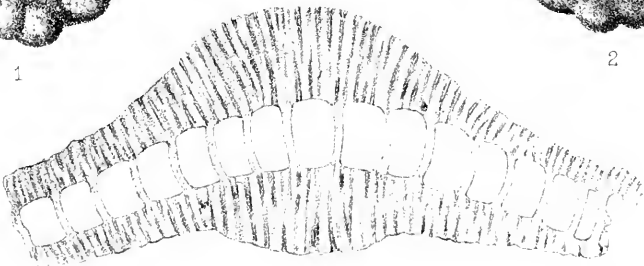

7

- Polymorphina problema* (d'Orbigny) Brady, Parker and Jones, 1870, Trans. Linn. Soc. Lond., vol. xxvii. p. 225, pl. xxxix. fig. 11.
 Ditto. (d'Orbigny) Brady, 1870, Edinburgh Catalogue, p. 5.
 Ditto. (d'Orbigny) Brady, 1884, Foram. 'Challenger,' p. 568, pl. lxxii. fig. 20, pl. lxxiii. fig. 1.
 Ditto. (d'Orbigny) Brady, 1887, Synopsis British Recent Foraminifera.
 Ditto. (d'Orbigny) Millett, 1903, Malay Foraminifera, Journ. R. Micr. Soc., p. 264.

Most of our specimens are fossils, and judging from appearances, have been derived from various sources. The species extends back as far as the Lias, and is of world-wide distribution in shallow waters at the present day. The difference between *P. problema* and *P. communis* is so slight as scarcely to merit separation.

358. *Polymorphina thoutini* d'Orbigny.

- Polymorphina thoutini* d'Orbigny, 1826, Ann. Sci. Nat., vol. vii. p. 265, No. 8; Modèle, No. 23.
 Ditto. (d'Orbigny) Brady, Parker and Jones, 1870, Trans. Linn. Soc. Lond., vol. xxvii. p. 232, pl. xl. fig. 17.
 Ditto. (d'Orbigny) Brady, 1884, Foram. 'Challenger,' p. 567, pl. lxxii. fig. 18.

A single pyritized fossil, extremely attenuated. According to Brady this is an extremely rare form in the recent condition. As a fossil it occurs in the Eocene of the Paris Basin and subsequently.

359. *Dimorphina longicollis* Brady sp.

(Plate X. fig. 19.)

- Polymorphina lanceolata* (pars) Reuss, 1870, Sitz. d. k. Akad. Wiss. Wien, vol. lxii. p. 487, No. 12. Von Schlicht, 1870, Foram. Pietzpuhl, pl. xxxi. figs. 25-28.
Polymorphina longicollis Brady, 1881, Quart. Journ. Micr. Sci., vol. xxi. (n.s.) p. 64.
 Ditto. (Brady) Brady, 1884, Foram. 'Challenger,' p. 572, pl. lxxiii. figs. 18-19.

We have a single perfectly preserved fossil specimen which, if Brady's identification of Von Schlicht's figures is correct, is referable to Brady's species. Our specimen, as will be seen from the drawing, agrees exactly with Von Schlicht's figure. The surface is quite smooth, whereas the recent specimens of *P. longicollis* are always, or nearly always, hispid.

The question of the necessity of allocating dimorphous types of *Polymorphina* to the sub-genus *Dimorphina* is one which is open to very great doubt, but if the sub-genus *Dimorphina* is to be retained at all it cannot be used to greater advantage than for the recording of such abnormal species as Brady's *P. longicollis*, which in the dimorphous arrangement of the chambers and produced Uvigerine neck differs widely from the accepted definition of *Polymorphina*. In the recent state *D. longicollis* is extremely rare, and

according to Brady essentially a deep-water species, ranging from 1100 to 2435 fathoms. Von Schlicht's specimens were from the Tertiaries of Pietzpuhl.

360. *Uvigerina asperula* Czjzek.

- Uvigerina asperula* Czjzek, 1847, Haidinger's Naturw. Abhandl., vol. ii. p. 146, pl. xiii. figs. 14, 15.
Uvigerina hispida Schwager, 1866, Novara Exped. geol. Theil, vol. ii. p. 249, pl. vii. fig. 95.
Uvigerina asperula (Czjzek) Brady, 1884, Foram. 'Challenger,' p. 578, pl. lxxv. figs. 6-8.
 Ditto. Czjzek) Flint, 1899, Report U.S. Nat. Museum for 1897, p. 320, pl. lxxviii. fig. 4.

Many excellent specimens, some of which are apparently recent. The species is common round our coasts in comparatively deep water, i.e., at depths from 100 fathoms downward, but so far as we are aware it has not been recorded in shore-sands, except from the neighbouring locality of Bognor, where Earland found a single very weak specimen. As a fossil it is common in many Miocene and later Tertiary beds.

361. *Sagrina asperula* Chapman.

- Sagrina asperula* Chapman, 1896, Foram. of Gault of Folkestone, Journ. R. Micr. Soc., p. 581, pl. xii. fig. 1.

We have a few specimens of this little species, which was described from the Gault of Folkestone. Ours are apparently Cretaceous fossils.

362. *Sagrina dimorpha* Parker and Jones.

- Uvigerina* (*Sagrina*) *dimorpha* Parker and Jones, 1865, Phil. Trans., vol. clv. p. 420, pl. xviii. fig. 18.
Sagrina dimorpha (Parker and Jones) Brady, 1884, Foram. 'Challenger,' p. 582, pl. lxxvi. figs. 1-3.
 Ditto. (Parker and Jones) Brady, 1887, Synopsis British Recent Foraminifera.
 Ditto. (Parker and Jones) Goës, 1894, Arctic and Scandinavian Foram., p. 52, pl. ix. figs. 510-11.

A few small specimens, one apparently fossil, the others recent.

Sagrina dimorpha has a world-wide range, occurring at moderate depths in all the oceans. It is the only species of the genus which has a northern as well as a tropical distribution, for it occurs in many of the Norwegian fiords at least as far north as the Søgne Fiord, in which it has been dredged by Earland at a depth of 260 metres. It has been recorded by Robertson from low water at Girvan, Scotland, but otherwise we know of no British record, nor of any fossil record.

146. *Globigerina pachyderma* Ehrenberg.

We have found very typical specimens of this boreal form, but the figures we gave in Plate XVIII, figs. 4 and 5 (1909) were of a new species of *Nonionina*, which we describe and figure again *post* No. 390 and Plate XI, figs. 12-15.

363. *Spirillina lucida* Sidebottom.

Spirillina lucida Sidebottom, 1908, Foraminifera from Delos, Mem. Manchester Lit. and Phil. Soc., vol. lii. No. 13, p. 9, pl. ii. fig. 9.

We have several specimens, apparently derived fossils, which answer to Sidebottom's description and figures. The structure, however, is very obscure, and in the absence of any visible aperture we do not feel satisfied that the specimens may not represent the superior external shell of some species of *Discorbina* in which the septal divisions and base have been dissolved during a process of plastogamy.

364. *Discorbina araucana* d'Orbigny sp.

Rosalina araucana d'Orbigny, 1839, Foram. Amér. Merid., p. 44, pl. vi. figs. 16-18.

Discorbina araucana (d'Orbigny) Parker and Jones, 1872, Quart. Journ. Geol. Soc., vol. xxviii. p. 115.

Ditto. (d'Orbigny) Brady, 1884, Foram. 'Challenger,' p. 645, pl. lxxxvi. figs. 10-11.

Ditto. (d'Orbigny) Sidebottom (1908), Foram. from Delos, Mem. Manchester Lit. and Phil. Soc., vol. lii. No. 13, p. 12.

One small well preserved specimen; a pyritized fossil. The geological distribution of *D. araucana* is probably identical with the more typical form *D. rosacea*, but the records are few.

365. *Discorbina bertheloti* d'Orbigny.

Discorbina bertheloti d'Orbigny, 1839, Foram. Canaries, p. 135, pl. i. figs. 28-30.

Ditto. (d'Orbigny) Brady, 1864, Trans. Linn. Soc. Lond., vol. xxiv. p. 469, pl. xlviii. fig. 10.

Ditto. (d'Orbigny) Brady, 1884, Foram. 'Challenger,' p. 650, pl. lxxxix. figs. 10-12.

Ditto. (d'Orbigny) Brady, 1887, Synopsis British Recent Foraminifera.

Ditto. (d'Orbigny) Flint, 1899, Rep. U.S. Nat. Museum for 1897, p. 327, pl. lxxii. fig. 4.

Ditto. (d'Orbigny) Earland, 1905, Journ. Quekett Micr. Club, ser. 2, vol. ix. No. 57, p. 223.

A few examples, typical and apparently all fossil, some of them highly pyritized. In the recent condition *D. bertheloti* has practically a world-wide distribution and ranges down to considerable depths. It is more typically an arctic or, at any rate, a northern form. Brady gives no information as to its occurrence in the fossil condition.

366. *Discorbina eximia* Hantken.

Discorbina eximia Hantken, 1875, Mittheil. Jahrb. d. k. ung. geol. Anstalt., vol. iv. p. 76, pl. xv. fig. 8.

Discorbina elegans Hantken, 1875. Id., p. 76, pl. ix. fig. 3.

Discorbina eximia (Hantken) Brady, 1884, Foram. 'Challenger,' p. 616, pl. lxxxviii. fig. 9.

One small specimen, fossil, which appears to be referable to this species, originally described from the Tertiaries of Hungary. In the recent condition it appears to be confined to shallow water in the tropics.

367. *Discorbina inaequalateralis* sp. n.

(Plate XI. figs. 3-5.)

The curious little specimen which we figure is so very distinctive in its appearance that it seems to merit a specific name, although its occurrence is so far limited to a single well preserved fossil specimen. The marked distinctive feature of the shell is the dissimilarity between its upper and under surfaces. The superior surface is in one plane and consists of about two convolutions, six or seven chambers in the outer whorl. The inferior surface is smaller, so that the shell when viewed on edge presents the appearance of a horizontal conic section. The superior surface is rough, owing to the fact that the perforations are abnormally large for such a small species, the sutural lines somewhat depressed, giving a "puckered" appearance to the surface of the shell. Viewed sidewise, the chambers are observed to be coarsely corrugated from edge to edge. The inferior surface is depressed, sinking away from the corrugated edge to a median line, running across the axis of the shell; this causes the central depression to be oval or elliptic, and not circular, as is usually the case. The perforations on the sides and base are very minute when compared with those on the apex of the shell; the septal divisions are not visible on the sides or inferior surface, and the general appearance of the inferior surface resembles *Spirillina* rather than *Discorbina*.

Length, 0.23 mm. Breadth, 0.2 mm.

368. *Discorbina nitida* Williamson sp.

Rotalina nitida Williamson, 1858, Recent Foram. of Gt. Britain, p. 54, pl. iv. figs. 106-108.

Ditto. (Williamson) Terquem, 1875, Ess. Anim. Plage Dunkerque, pt. i. p. 26, pl. ii. fig. 9.

Rotalia nitida (Williamson) Brady, 1884, Foram. 'Challenger,' pp. 627, 705.

Ditto. (Williamson) Brady, 1887, Synopsis British Recent Foraminifera.

Discorbina nitida (Williamson) Wright, 1891, Proc. R. Irish Acad., ser. 3, vol. i. No. 1, p. 140.

Ditto. (Williamson) Sibley, 1908, Foram. from Delos, Mem. Manchester Lit. and Phil. Soc., vol. lii. No. 13, p. 13, pl. iv. fig. 6.

Fossil and recent specimens. The fossils are not in a good state of preservation, having been apparently obtained from some disintegrated crystalline deposit, probably a limestone of Tertiary age. Some of the recent specimens are exceptionally large and fine.

This is a very well marked type, and possesses certain characteristic features in the shape of a flat depressed shell with broad straplike sutures, which render it easy of identification. There is also a characteristic glassiness about the texture due to the extremely minute size of the perforations which separates it from other species of *Discorbina*, most of which are rather coarsely perforate.

Brady (*suprà*), for some reason not very apparent, placed the species in the genus *Rotalia*, and considered it to be an isomorph of *Discorbina turbo* (d'Orbigny). He regarded it as a starved modification of *Rotalia beccarii* (Linné sp.), but it appears to us to have nothing in common with that species. On the other hand, it is evidently very closely allied to *Discorbina rosacca* d'Orb. sp., of which it may perhaps be regarded as a simple and original variety.

369. *Discorbina patelliformis* Brady var. *carinifata* var. n.

(Plate X. figs. 22-24.)

Discorbina patelliformis Brady, 1884, Foram. 'Challenger,' p. 647, pl. lxxxviii. fig. 3; lxxxix. fig. 1.

The curious little shell which we figure should, we think, be referred to this species, although it differs from the type in its sutures. These, instead of being broad but flush bands of clear shell-substance as in the type, are strongly limbate, some of them projecting almost as *carinæ*. The under surface of the shell is broken, and has somewhat the appearance of having once been joined in plastogamy with another shell.

The specimen is apparently a fossil. Brady's specimens were from the Pacific. It is generally distributed in warm seas.

Breadth, 0·2 mm. Height, 0·14 mm.

370. *Discorbina pileolus* d'Orbigny sp.

(Plate XI. figs. 1, 2.)

Valvulina pileolus d'Orbigny, 1839, Foram. Amér. Mérid., p. 47, pl. i. figs. 15-17.

Discorbina pileolus (d'Orbigny) Parker and Jones, 1865, Phil. Trans., vol. clv. p. 385.

Ditto. (d'Orbigny) Brady, 1884, Foram. 'Challenger,' p. 649, pl. lxxxix. figs. 2-4.

Ditto. (d'Orbigny) Chapman, 1900, Journ. Linn. Soc. Lond. Zool., vol. xxviii. p. 191.

A few minute and very weakly developed specimens have been found, which we refer to this species. The shells, which are in

excellent preservation but are doubtless fossils, are extremely compressed, the relation of their height to the breadth being less than one quarter of the usual dimensions. The typical curve of the chambers is, however, present, as is also the customary radial line of beaded markings on the base, although these are remarkably delicate.

At the present day this species appears to be confined to the Pacific and Australian seas, where it is often fairly abundant. It is one of the few species of Foraminifera in which "plastogamy" appears to occur with any frequency, twin specimens being nearly always present in any gathering which contains many specimens of the form. It has been recorded from the Eocene of Paris and some later deposits.

Breadth, 0.37 mm. Height, 0.05 mm.

371. *Discorbina polystomelloides* Parker and Jones.

Discorbina polystomelloides Parker and Jones, 1865, Phil. Trans., vol. clv. p. 421, pl. xix. fig. 8.

Ditto. (Parker and Jones) Brady, 1884, Foram. 'Challenger,' p. 652, pl. xci. fig. 1.

A few well preserved specimens, all fossil, and, judging from their condition, derived from at least two and perhaps three different deposits. At the present day the species is of fairly common occurrence in the coral sands of the Australian and Pacific seas. We have no knowledge of any previous occurrence as a fossil, but our specimens are doubtless derived from some of the Tertiary deposits, characterized by tropical and sub-tropical fauna.

372. *Discorbina rosacea* d'Orbigny sp. var. *Selscyensis* var. n.

(Plate X. figs. 20, 21.)

We figure a curious little *Discorbina* which we think should be attributed to this species, or which perhaps may form a link connecting *D. rosacea*, *D. nitida*, and *D. orbicularis*. Two or three specimens only have been observed, all recent, and all characterized by the same constant features.

The shell, which seen from above is almost exactly circular in outline, consists of about two or three convolutions of chambers. The shell is dome-shaped on the superior surface, concave below: sutures flush, clear bands of shell-substance as in *D. nitida*; the outer margin of the shell presents a similar band of shell-substance. On the inferior side the surface of the chambers is covered with weak corrugations diverging from the central axis of the shell; texture glassy (hyaline); perforations extremely minute. Apart from the under surface of the shell this variety might readily be mistaken for a dome-shaped specimen of *D. nitida*, but the markings on the inferior surface are peculiarly distinctive. The tangential

curve of the chambers as seen on the superior face, and the arrangement of the chambers on the inferior face (apart from the superficial markings), approach more nearly to *D. orbicularis* than to either *D. rosacea* or *D. nitida*.

Diameter, 0.4 mm.

373. *Discorbina tabernacularis* Brady.

Discorbina tabernacularis Brady, 1881, Quart. Journ. Micr. Sci., vol. xxi. (n.s.) p. 65.

Ditto. (Brady) 1884, Foram. 'Challenger,' p. 618, pl. lxxxix. figs. 5-7.

Ditto. (Brady) Egger, 1893, Abhandl. k. bayer. Akad. Wiss., Cl. II. vol. xviii. p. 390, pl. xv. figs. 58-60, 79.

Ditto. (Brady) Millett, 1903, Malay Foram., Journ. R. Micr. Soc., p. 700.

Ditto. (Brady) Sidebottom, 1908, Foram. from Delos, Mem. Manchester Lit. and Phil. Soc., vol. lii. No. 13, p. 15.

A few specimens, apparently recent. This has usually been regarded as a warm-water species, the 'Challenger' localities being tropical, the northernmost being Cape Verde. We have, however, met with it in many localities in the Mediterranean, so that its occurrence on our southern coasts is rendered not improbable. We are not aware of records of its occurrence in the fossil condition.

374. *Discorbina ventricosa* Brady.

Discorbina ventricosa Brady, 1884, Foram. 'Challenger,' p. 654, pl. xci. fig. 7.

Many specimens, fossil, in good preservation. The umbilical depression on the inferior surface typical of the species is particularly marked, more so even than in Brady's figure. The superior surface is smooth, not hispid, and in this respect our specimens may perhaps be regarded as connecting Brady's *D. ventricosa* with *D. saulcii* of d'Orbigny. Brady's specimens were obtained from several localities in different parts of the world at depths from 155 to 620 fathoms. We do not know of any other record of the species as a fossil.

172. *Cycloloculina annulata* H.-A. and E.

173. *Cycloloculina polygyra* H.-A. and E.

During the three years which have intervened since we commenced this series of papers nothing has transpired to modify the views which we expressed as to the affinities of this interesting type. Although an enormous number of specimens in all stages of growth has now been picked out from every part of the shore between the point of Selsey Bill and Chichester Harbour, we are still in complete ignorance as to the exact deposit from which these fossils have been derived. An examination of all the various zones and beds exposed in the same area has not yielded any definite evidence of origin. Found principally in elutriated material from the shore-sand, occasional specimens are found in many samples of

the Eocene Clays exposed on the shore, but whether as derived fossils or not it has been impossible to determine. As, however, with three exceptions all the specimens present the same superficial appearance, we are still inclined to think that the original home of the species is in some early Tertiary deposit which has been denuded to such an extent that it now exists only below the sea level. This theory would account for the presence of the isolated specimens which we have obtained from later Tertiary beds still *in situ* on the shore, and also for the very large number of specimens continually washed up upon the sands.

The exceptional specimens to which we have referred above are of a very much whiter appearance and calcareous texture. Apart from their surroundings they might easily be mistaken for Cretaceous fossils. This is, however, no doubt due to some accidental conditions of preservation or weathering. We do not suppose that *Cycloloculina* ranges back to the Cretaceous period. In spite of the considerable amount of work which is now being done on the Continent with the fossil Foraminifera, especially those of the Tertiary period, no further records of the genus have been published.

We may take this opportunity of acknowledging a suggestion which we have received from Mr. J. J. Lister, F.R.S., to the effect that *C. polygyra* may probably be the microspheric form of the genus, *C. annulata* being the megalospheric form. There seems every reason to believe that this may be the case, as the relative proportions to one another of the specimens appear to carry out this theory. In the absence of definite micrometric observations, we are not at present prepared to go into this, but the great profusion of the shells found in our sands supplies us with material of which we hope shortly to avail ourselves, with a view to going into this matter, to some extent at any rate, on the lines on which Lister, Carpenter and others have dealt with the *Nummulites*.

Linderina Schlumberger.

375. *Linderina brugesii* (Schlumberger).

(Plate XII. figs. 1-7.)

Linderina brugesii Schlumberger, 1893, Bull. Soc. Géol. France, s. iii. vol. 21, p. 118, and figs. 3-5.

Among the fossil specimens commonly found in the shore-sands of Selsey Bill were many of a shell which very early attracted our

EXPLANATION OF PLATE XIII.

Pulvinulina vermiculata d'Orbigny sp.

- Fig. 1. —Superior surface.
 „ 2. —Inferior surface of same specimen.
 „ 3. —Superior view of a small specimen.
 „ 4. —Inferior view of same specimen.

(All figures on this plate are magnified 50 diameters only.)

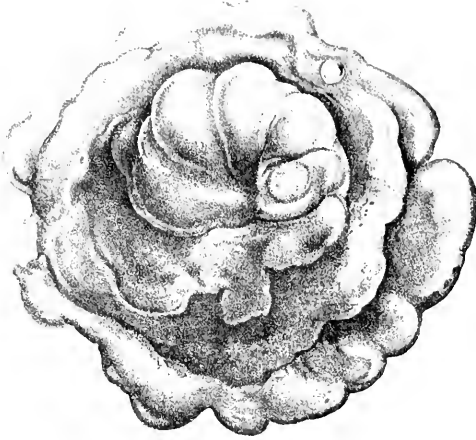

1

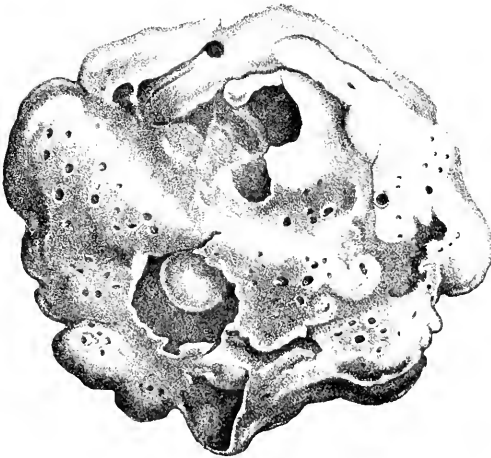

2



3



4

attention, but which, in the earlier stages of our examination, were set aside and regarded as probably referable to the genus *Planorbulina*. After a considerable number of specimens in all stages of growth had been collected, we found that they presented features which could not be correlated with that genus, and as a result of careful examination, including the cutting of sections of the test in various planes, we are enabled definitely to identify our specimens with an interesting type, of which the first, and we believe only, record appears as above from the pen of the late Charles Schlumberger. As his paper has received little or no notice, we cannot do better than quote its essential parts, which are as follows:—

“The species was discovered by “mon ami M. Linder, Inspecteur Général des Mines,” in the rubbish from borings in the Dept. of the Gironde.

“Test discoidal, thickened in the centre, composed of a single layer of numerous chamberlets disposed circularly around a central chamber and on the same plane. The partition-walls of each circle of chambers extend towards the centre above the already formed chambers. This calcareous envelope is traversed by coarse perforations which communicate directly with the inner chambers. He describes two forms, A and B.

Linderina Brugesii Schlumb. sp. n.

“Form A.—A transverse section made perpendicularly to the circumference, shows in the centre a large primordial chamber, spherical, and accompanied on the right and left, and on a more or less curved line, by a series of chambers which grow gradually taller. They are invested above and below by a calcareous deposit which is thicker at the centre than at the periphery; this massive formation is produced as is seen by the sutural lines, by the prolongation, towards the centre, of the walls of the chambers.

“These walls are coarsely perforated, and these perforations are continued in a straight line, increasing slightly in diameter, across the whole thickness of the calcareous envelope to reach the surface of the test, and thus establish a communication between all the chambers and the exterior. The section being rather thick, one sees in the outermost chambers unevenly distributed openings by which the adjoining chambers of the same ring communicate with one another.

“In a section at right angles to the last (horizontal) it is impossible to see all the chambers from the megalosphere outwards, because they are generally situated on a concave surface. One sees by a higher magnification that the wall of all the chambers is continuous right round the test without any sutures, and forms the chambers by its waviness.

“Form B only differs from Form A in that it is microspheric.

“Test discoidal, thicker in the centre than at the edges, where one sees only two annular rows of chamberlets. Test rough by reason of little prominences which stand up between the perforations.

“Habitat.—Upper Eocene of Bruges (Gironde). Rather rare.

“Observations.—In its exterior aspect this fossil closely resembles an *Orbitoides* or a *Cycloclypeus*. It differs from the former in the absence of chambers in the thickness of the central boss, and from the latter in the absence of the system of partitional canals and the compact pillars which traverse the test.”

There are several points in M. Schlumberger's description with which we cannot agree. As seen in horizontal section, our specimens commence with a regular Rotaline spiral of about 2 to 3 whorls. There are 8 to 10 chambers in the last convolution, and up to this point the chambers are fairly regular in size. Subsequent chambers are added in more or less regular annuli and vary considerably in size and shape. The earlier annuli have apparently simple walls, i.e., each chamber consists of a semicircular wall secreted over the outer surface of a bead of protoplasm, which had been protruded through the tubuli of an earlier chamber. Later on the chamberlets appear to have compound walls, i.e., the protruded bead of protoplasm secreted a basal wall of its own, separating it from the wall of the preceding annulus. This double cell-wall gives the appearance of a wavy line of chambers, referred to by Schlumberger and illustrated by him diagrammatically.

We have been unable to trace any direct communication between adjacent chamberlets of the same or adjacent convolutions. The horizontal sections show no trace of any tubuli in the partition walls or any definite oral aperture. If any tubuli are present in the side walls of the chambers they must be extremely minute, as they are not visible under $\frac{1}{4}$ -in. objective. Vertical sections, however, show that the top and bottom walls of every chamber were perforated with coarse tubuli, extending right through the thick deposit of shell-substance to the external surface. It would, therefore appear that each chamberlet was a separate and self-contained unit so far as nutrition was concerned, and that the growth of the shell depended on extrusions of protoplasm through these apertures, which formed at first isolated chambers round the rim and subsequently a tube with constrictions at intervals. The whole question is, however, so difficult to follow owing to the friability of the test and the trouble of preparing sections, that we put forward our conjectures with some diffidence.

We are unable to confirm Schlumberger's statement that “the partition walls of each circle of chambers extend towards the centre above the already formed chambers.” If this were the case a vertical section would show strong bands of clear shell-substance cutting

the coarse vertical tubuli at an angle. Nothing of the kind is visible in our sections, and it is possible that Schlumberger was confused by the pillar-like appearance of the shell-substance of the boss caused by the coarse perforations of the tubuli. The central boss appears to be a simple deposit of shell-substance, such as occurs in *Cycloloculina*, and is in no way connected with "the prolongation towards the centre of the walls of the chambers."

Schlumberger gives no clue to the position to which he intended to relegate his genus *Linderina*, beyond pointing out certain points of external resemblance to *Orbitoides* and *Cycloclypeus*. In the doubling of the shell wall of the later chambers it certainly shows a tendency towards the Cycloclypeine, but on the whole we are disposed to regard it of much simpler type, closely allied to *Cycloloculina* and *Planorbulina*, and perhaps as a transition type between these and the more highly developed Cycloclypeine.

The specimens are of very frequent occurrence in the elutriated material from the shore-sands all round the Selsey peninsula, and vary from young specimens in which only the central boss is apparent, surrounded by a ring of deeply sutured and bead-like chamberlets (which led Mr. Millett, to whom we submitted some of the earliest found tests, to suggest that they were *Planorbulina larvata*), to large specimens in which many rings of chamberlets surround the central boss, thus producing a shell suggestive of *Cycloclypeus*, as noted by Schlumberger. This was before we had made the sections, which we found to conform to the descriptions given by Schlumberger, as set forth above.

From the external appearance of the shells and the micro-structure of their material, there seems every reason to suppose that they reach the Selsey shore-sands from the same geological deposit as *Cycloloculina*. M. Schlumberger, as is seen above, gives no very definite clue to the precise formation from which his specimens were derived, and in the absence of further and better evidence we are constrained to suppose that our specimens are, like *Cycloloculina*, derived from an exposure of Eocene clay, which, so far, we have failed to discover between or above tide-marks at Selsey Bill.

It would be interesting if more definite information as to the locality of the original specimens could be obtained, and if it could be ascertained whether any deposit of similar age is known among the Tertiary deposits of Great Britain.

376. *Truncatulina refulgens* Montfort sp.

Cibicides refulgens Montfort, 1808, Conchyl. Systém., vol. i. p. 122, 31e Genre.
Truncatulina refulgens (Montfort) d'Orbigny, 1826, Ann. Sci. Nat., vol. vii.
p. 279, pl. xiii. figs. 8-11; Modèle, No. 77.

Ditto. (Montfort) Parker and Jones, 1865, Phil. Trans., vol. clv. p. 382,
pl. xvi. fig. 19.

Ditto. (Montfort) Brady, 1865, Nat. Hist. Trans. Northd. and Durham
vol. i. p. 105, pl. xii. fig. 9.

- Truncatulina vulgata* (Montfort) Brady, 1884, Foram. 'Challenger,' p. 659, pl. xcii. figs. 7-9.
 Ditto. (Montfort) Brady, 1887, Synopsis British Recent Foraminifera.
 Ditto. (Montfort) Millett, 1904, Malay Foraminifera, Journ. R. Micr. Soc., p. 491.

A few small specimens, recent, from the shore-sands, and, perhaps, fossil from the Chalk flints. According to Brady, this is not uncommon in coarse rough sands from 20 fathoms downwards on the Atlantic coasts of Scotland and Ireland, rare on the east coast, but the species occurs in very great profusion and also attains a maximum size in shallow-water dredgings on the east coast of Scotland.

377. *Truncatulina reticulata* Czjzek sp.

- Rotulina reticulata* Czjzek, 1848, Haidinger's Naturw. Abhandl., vol. ii. p. 145, pl. xiii. figs. 7-9.
Siphonina fimbriata Reuss, 1849, Denkschr. d. k. Akad. Wiss. Wien, p. 372, pl. xlvii. fig. 6.
Planorbulina reticulata (Czjzek) Parker and Jones, 1865, Phil. Trans., vol. clv. p. 379.
Truncatulina reticulata (Czjzek) Brady, 1884, Foram. 'Challenger,' p. 669, pl. xevi. figs. 5-8.
 Ditto. (Czjzek) Chaster, 1892, First Rep. Southport Soc. Nat. Sci. (1890-91), p. 66, pl. i. fig. 16.
 Ditto. (Czjzek) Flint, 1899, Rep. U.S. Nat. Museum for 1897, p. 334, pl. lxxviii. fig. 3.
 Ditto. (Czjzek) Millett, 1904, Malay Foram., Journ. R. Micr. Soc., p. 490.
 Ditto. (Czjzek) Earland, 1905, Journ. Quekett Micr. Club, ser. 2, vol. ix. No. 57, p. 226.

A few fossil specimens referable to this species, which is widely distributed throughout the Tertiary period. Our specimens, judging from their appearance, are derived from a clay; some of them show the tubulation of the peripheral edge with great distinctness. The species has been recorded from the London Clay of the Isle of Wight by Brady.

378. *Anomalina ariminensis* d'Orbigny sp.

- Planulina ariminensis* d'Orbigny, 1826, Ann. Sci. Nat., vol. vii. p. 280, pl. v. figs. 1-3; Musée, No. 49.
Planorbulina ariminensis (d'Orbigny) Parker, Jones and Brady, Ann. and Mag. Nat. Hist., ser. 3, vol. xvi. p. 26, pl. iii. fig. 78.
Anomalina ariminensis (d'Orbigny) Brady, 1884, Foram. 'Challenger,' p. 674, pl. xciii. figs. 10, 11.
Planorbulina ariminensis (d'Orbigny) Göss, 1894, Arctic and Scandinavian Foraminifera, p. 91, pl. xv. figs. 784, 785.
Anomalina ariminensis (d'Orbigny) Flint, 1899, Rep. U.S. Nat. Museum for 1897, p. 335, pl. lxxix. fig. 1.
 Ditto. (d'Orbigny) Millett, 1904, Malay Foram., Journ. R. Micr. Soc., p. 495.

Common; pyritized fossils, probably derived from the London Clay to the east of Selsey Bill. This species, which is commonly

distributed in moderately deep water at the present time, occurs in the fossil state as far back as the Cretaceous period, where it is not uncommon, and is subsequently found in many late Tertiary deposits all over the world.

186. *Anomalina coronata* Parker and Jones.

(Additional Note.)

Anomalina coronata (Parker and Jones) Brady, 1887, Synopsis British Recent Foraminifera.

Planorbulina coronata (Parker and Jones) Flint, 1899, Rep. U.S. Nat. Museum for 1897, p. 335, pl. lxxix. fig. 2.

A few more fairly typical though small examples of this interesting species. The specimens are fossils, from two different sources, a clay and apparently a shell-sand. They are of small size compared with recent specimens from North British seas, but in other respects are quite characteristic. At the present day *A. coronata* has a very wide distribution, but it only occurs in any abundance in certain localities, favouring high latitudes and low temperatures. In many of the 'Goldseeker' dredgings in the Shetland-Faeroe area the species occurs in enormous profusion, so as to form an almost typical deposit, and the specimens attain a comparatively large size and robust character.

379. *Palvulinina auricula* Fichtel and Moll sp.

Nautilus auricula var. *a* Fichtel and Moll, 1803, Test. Micr., p. 108, pl. xx. figs. *a, b, c*.

Valvulina excavata d'Orbigny, 1839, Foram. Canaries, p. 137, pl. i. figs. 43-45.

Palvulinina auricula (Fichtel and Moll) Parker and Jones, 1865, Phil. Trans., vol. clv. p. 393.

Ditto. (Fichtel and Moll) Brady, 1884, Foram. 'Challenger,' p. 688, pl. cvi. fig. 5.

Ditto. (Fichtel and Moll) Brady, 1887, Synopsis British Recent Foraminifera.

Ditto. (Fichtel and Moll) Flint, 1899, Rep. U.S. Nat. Museum for 1897, p. 329, pl. lxxiii. fig. 2.

A few fossil specimens have been observed, but, curiously enough, no recent ones. They are well preserved, probably from a Tertiary shell-sand. It has already been recorded from the Eocene of the Paris basin and later Tertiary deposits.

380. *Palvulinina bronquartii* d'Orbigny sp.

Rotalia bronquartii d'Orbigny, 1826, Ann. Sci. Nat., vol. vii. p. 273, No. 27.

Rotalina bronquartii (d'Orbigny) d'Orbigny, 1846, Foram. Foss. Vienne, p. 158, pl. viii. figs. 22-24.

Palvulinina auricula (Fichtel and Moll) Parker, Jones and Brady, 1871, Ann. and Mag. Nat. Hist., ser. 4, vol. viii. p. 173, pl. xii. fig. 143.

Paltriuolina auricula (Fichtel and Moll) Brady, 1881, Foram. 'Challenger,' p. 688.

Paltriuolina bougainvillii (d'Orbigny) Millett, 1901, Malay Foram., Journ. R. Micr. Soc., p. 498, pl. x. fig. 4.

Abundant and well preserved specimens, all fossil. D'Orbigny's original specimens were from the Miocene of Vienna: "common." He also records it as living in the Adriatic. Millett figures a variety from the Malay seas which differs from d'Orbigny's type considerably, in that the shell is more compressed and has a tendency to form a carina on the outer edge. The sutures also are limbate, whereas in d'Orbigny's type they are flush or simple. Our specimens agree with d'Orbigny's, though there is some tendency towards a thickening of the sutures on the inferior surface.

Brady (*supra*) regards this type as an intermediate between *Paltriuolina auricula* (F. and M. sp.) and *Paltriuolina hauerii* (d'Orb. sp.).

381. *Paltriuolina crassa* d'Orbigny sp.

Rotulina crassa d'Orbigny, 1840, Mém. Soc. Géol. France, vol. iv. p. 32, pl. iii. figs. 7, 8.

Paltriuolina crassa (d'Orbigny) Owen, 1867, Journ. Linn. Soc. Lond., vol. ix. Zool. p. 148, pl. v. figs. 8(?), 9.

Ditto. (d'Orbigny) Brady, 1881, Foram. 'Challenger,' p. 694, pl. ciii. figs. 11, 12.

Ditto. (d'Orbigny) Egger, 1893, Abhandl. k. bayer. Akad. Wiss., Cl. II. vol. xviii. p. 416, pl. xviii. figs. 7-12.

Ditto. (d'Orbigny) Flint, 1899, Rep. U.S. Nat. Museum for 1897, p. 329, pl. lxxiv. fig. 1.

Ditto. (d'Orbigny) Rhumbler, 1900, Nordisches Plankton, Heft xiv. p. 17, figs. 12, 14, 15.

Many specimens, well preserved fossils, from clays and shell-sands. At the present time *P. crassa* is recorded only from deep water in the great oceans, the records ranging from 150 to 2740 fathoms. Brady states that it is not uncommon from Chalk in the neighbourhood of Paris and from Kent, but adds that there is no mention of its occurrence in other formations.

382. *Paltriuolina haliolidea* sp. n.

Plate XI. figs. 6-11.

We have a single imperfect specimen, which we figure, of a little Foraminifer which Earland has found in some quantity at practically all the shallow-water stations worked by the 'Gold-seeker' round the north and east of Scotland. It may be regarded as an extreme variation of the type *P. auricula* (F. and M.) in the direction of compression of the test and evolution of the spiral. Our description is based upon the general characteristics of the North Sea specimens.

Test compressed, ear-shaped, consisting of about two convolutions and six to ten chambers, rapidly increasing in size, the whole usually visible on both sides of the shell. Superior surface, rounded; periphery more or less acute; the earliest chambers usually project above the curved surface of the superior face, in a low mammillate spire. The appearance of the inferior surface varies greatly, according to the degree of evolution of the spiral. In some specimens the central portion presents a sunken umbilicus, the later chambers being turgid and attached to the previous convolution; in others the whole series of chambers of the final convolution and some of those of the previous convolution are seen to form an evolute spire, which is only held together by an extension of the superior wall connecting it with the previous convolution. This is fairly well shown in the drawing, fig. 6, representing the inferior side of the Selsey specimen. Some of the North Sea examples present this depauperate stage in an even more striking degree; the whole shell viewed both from above and below presents a somewhat significant resemblance to the human ear; hence the specific name which we have given to this shell.

In the North Sea the species is most frequent in the muddy sands of the Moray Firth and analogous areas, but it also extends to the Faeroe Channel and the west coast of Scotland. We have seen specimens probably referable to this species in its less extreme type in some of Mr. Joseph Wright's dredgings from the west of Ireland.

It may be remarked that all the specimens appear to have a somewhat large primordial chamber. It is not improbable that our species may represent the megaspheric type of some other form, perhaps of *P. auricula* or *P. oblonga*.

Length, 0·15–0·25 mm. Breadth, 0·1 to 0·2 mm.

383. *Pulvinulina lateralis* Terquem sp.

Rosalina lateralis Terquem, 1878, Mém. Soc. Géol. France, sér. 3, vol. i. Mém. 3, p. 25, pl. ii. fig. 11.

Pulvinulina lateralis (Terquem) Brady, 1884, Foram. 'Challenger,' p. 689, pl. evi. figs. 2, 3.

Ditto. (Terquem) Egger, 1893, Abhandl. k. bayer. Akad. Wiss. Cl. II. vol. xviii. p. 413, pl. xviii. figs. 48–50.

Ditto. (Terquem) Millett, 1904, Malay Foraminifera, Journ. R. Micr. Soc., p. 497.

Ditto. (Terquem) Sidebottom, 1909, Foram. from Delos, Mem. Manchester Lit. and Phil. Soc., No. 21, p. 5, pl. ii. fig. 6, pl. iii. figs. 1, 2 (?)

A few specimens, probably fossil. The recent records of this species appear to be confined to tropical warm seas in shallow water. Terquem's original specimens were from the Pliocene of Rhodes.

384. *Pulvinulina repanda* Fichtel and Moll sp.

- Nautilus repandus* Fichtel and Moll, 1803, Test. Micr., p. 35, pl. iii. figs. *a-d*.
Rotalina concamerata (mature) (Montagu) Williamson, 1858, Recent Foram. Great Britain, p. 52, pl. iv. figs. 101-3.
Rotalia repanda (Montagu) (Williamson) Parker and Jones, 1860, Ann. and Mag. Nat. Hist., ser. 3, vol. v. p. 175, No. 25.
Pulvinulina repanda (Montagu) (Williamson) Brady, 1884, Foram. 'Challenger,' p. 684, pl. civ. fig. 18.
 Ditto. (Montagu) (Williamson) Brady, 1887, Synopsis British Recent Foraminifera.
 Ditto. (Montagu) (Williamson) Egger, 1893, Abhandl. k. bayer. Akad. Wiss. Cl. II. vol. xviii. p. 405, pl. xviii. figs. 28, 30, 34, 35.
 Ditto. (Montagu) (Williamson) Goës, 1894, Arctic and Scandinavian Foraminifera, p. 95, pl. xvi. fig. 801.
 Ditto. (Montagu) (Williamson) Flint, 1899, Rep. U.S. Nat. Museum for 1897, p. 328, pl. lxxii. fig. 8.

Recent and fossil. This is a fairly common shallow-water type, in most parts of the world, and occurs as a fossil as far back as the Middle Tertiaries.

385. *Pulvinulina repanda* var. *concamerata* Montagu var.

- Serpula concamerata* Montagu, 1808, Test. Brit., Suppl., p. 160 (*vide* Williamson).
Rotalina concamerata "mature" (Montagu) Williamson, 1858, Recent. Foram. Great Britain, p. 52, pl. iv. figs. 102, 103.
Pulvinulina repanda var. *concamerata* (Montagu) Brady, 1884, Foram. 'Challenger,' p. 685, pl. civ. fig. 19.

Recent and fossil. The specimens are small compared with those found on many parts of our coast.

199. *Pulvinulina semi-marginata* d'Orbigny sp.

In our description of this form we regret that we should have overlooked the description and figures published by our friend Mr. F. W. Millett in the Journal of this Society.* Mr. Millett has also drawn our attention to the fact that Signor Fornasini has in his series of papers reproducing the "Planches inédites" of d'Orbigny, figured d'Orbigny's original drawing.† According to Mr. Millett, the species occurs in great profusion at some stations in the Malay Archipelago. He describes it under the name *Discorbina semi-marginata*, and his figure, and the Malay specimens with which he has been kind enough to supply us, are of markedly Discorbine growth. Our specimens, on the other hand—and we have found a very large number—are distinctly Pulvinuline, and we can only conclude that this is one of those species which bridges the gap between the allied genera *Discorbina* and *Pulvinulina*. The characteristic feature of the species, the subsidiary asterigerine chambers, are equally well marked in both types.

* See this Journal, 1903, p. 703, pl. vii. fig. 8.

† C. Fornasini, 1906, Mem. R. Acc. Scienze dell' Istituto di Bologna, ser. vi. tom. iii. p. 36, pl. iv. fig. 5.

386. *Pulvinulina reticulata* Reuss sp.

- Rotalina reticulata* Reuss, 1862, Sitzungsber. d. k. Akad. Wiss. Wien, vol. xvi. Abth. i. p. 83, pl. x. figs. 4 a-c.
Epistominia reticulata (Reuss) Uhlig, 1883, Jahrb. k. k. geol. Reichsanst., vol. xxxiii., p. 768, p. vii. figs. 8, 9.
Pulvinulina reticulata (Reuss) Chapman, 1898, Journ. R. Micr. Soc., p. 8, pl. i. figs. 10 a-c.

A single specimen, fossil. This may be derived from Gault or lower Cretaceous formations, to which zones the species appears to be confined.

387. *Pulvinulina tumida* Brady.

- Pulvinulina menardii* var. *tumida* Brady, 1877, Geol. Mag., Dec. II. vol. iv. p. 294.
 Ditto. Brady, 1879, Quart. Journ. Micr. Sci., vol. xix. (s) p. 80.
Pulvinulina tumida (Brady) Brady, 1884, Forum. 'Challenger,' p. 692, pl. ciii. figs. 4-6.
 Ditto. (Brady) Eger, 1893, Abhandl. k. bayer. Akad. Wiss., Cl. II. vol. xviii. p. 414, pl. xvii. figs. 4-6, 35-37, 44.
 Ditto. (Brady) Flint, 1899, Rep. U.S. Nat. Museum for 1897, p. 329, pl. lxxiii. fig. 5.

Many fossil specimens, well preserved, and apparently from a shell-sand. The specimens are small compared with those commonly found in recent deposits. It is widely distributed at the present day within the tropics and at all depths down to 2750 fathoms. Of its fossil distribution, Brady only records its occurrence in the limestone from New Britain, in the Pacific, as of unknown geological age, but its records may very possibly be confused with those of its older and better known ally, *Pulvinulina menardii*, of which it is merely a turgid and solid form, and which has been recorded as far back as the Cretaceous period.

388. *Pulvinulina umbonata* Reuss.

- Rotalina umbonata* Reuss, 1851, Zeitschr. d. deutsch. geol. Gesellsch., vol. iii. p. 75, pl. v. fig. 35.
Pulvinulina umbonata (Reuss) Reuss, 1886, Denkschr. d. k. Akad. Wiss. Wien., vol. xxv. p. 206.
 Ditto. (Reuss) Brady, 1884, Forum. 'Challenger,' p. 695, pl. cv. fig. 2.
 Ditto. (Reuss) Flint, 1899, Rep. U.S. Nat. Museum for 1897, p. 330, pl. lxxiv. fig. 1.

One fossil specimen from above the Selsey beds, opposite West^t Street. This species, now known only from deep water in the great oceans, occurs in many Tertiary deposits on the continent of Europe.

190. *Pulvinulina vermiculata* d'Orbigny sp.

Plate XIII. figs. 1-4.

Since we described the single small specimen of *Pulvinulina vermiculata*, which we had found when this species was dealt with

in Paper No. 4 of our series,* we have had the good fortune to discover the specimen now figured, which in itself is ample confirmation of those affinities referred to by Brady, which we had previously seen reason to doubt. The specimen was found on the shore to the N.W. of New Road, and to all external appearances is a recent one, although the occurrence of such a remarkably fine and well developed southern form on British shores must, in a neighbourhood like Selsey Bill, where fossil forms predominate, certainly remain open to question. The test, however, shows no sign of fossilization or staining. The earlier chambers are remarkably well developed, and taken apart from the ensuing growth would be assigned without hesitation to *P. lateralis* Terquem sp. Subsequently to our finding of this specimen, an extended series of this species, showing all gradations from *P. lateralis*, was gathered by Heron-Allen on the shore of the Lido, at Venice: there is no doubt that upon such a series as this the late H. P. Brady based his observations on the affinities of the species.

We take this opportunity of figuring the small specimen on which our original record was based.

389. *Nonionina pauperata* Balkwill and Wright.

Plate XI. figs. 16, 17.

Nonionina quadriloculata Balkwill and Wright, 1885, Trans. R. Irish Acad., vol. xxviii. (Science) p. 353, pl. xiii. figs. 25, 26.

Ditto. (Balkwill and Wright) Brady, 1887, Synopsis British Recent Foraminifera.

Several recent and typical specimens of this interesting form.

390. *Nonionina quadriloculata* sp. n.

Plate XI. figs. 12-15.

Globigerina pachyderma (Ehrenberg) Heron-Allen and Earland, 1909, Journ. R. Micr. Soc., p. 438, pl. xviii. figs. 4, 5. (*Figures only.*)

By an oversight in illustrating the species *Globigerina bulloides* Ehrenberg sp. in a previous number of this paper, the artist selected specimens which had been inadvertently associated with our examples of *G. pachyderma* without sufficient care in determining their affinities. *G. pachyderma* remains on our list as we have good typical specimens, and the printed remarks which we published (*vide supra*) remain unqualified. On a more protracted examination of our material we have found a very large number of the specimens such as were figured as *G. pachyderma*, and a minute examination of these, both by reflected and transmitted light, has proved them to be a Nonionine isomorph of the species *Globigerina pachyderma*, to which they were at first referred.

* See this Journal, 1909, p. 684.

The test is almost spherical, slightly flattened at right angles to the axis, consisting of eight or nine chambers coiled in an involute spiral, the last four chambers only being visible externally. There is a slight umbilical depression on either side, and the neighbourhood of the aperture of the final chamber is surrounded with stout but short tubercles which almost entirely conceal the actual aperture. This apparently consists of the usual Nonionine series of fine pores at the extreme line of junction of the last and previous whorls.

The specimens, which are all fossil, are generally well preserved; a few are pyritized, the remainder, as a rule, deeply stained. The perforations of the shell are extremely minute.

We publish two further figures of the species in which the position and nature of the tubercles are better shown than in the previous drawings.

Breadth, 0·2–0·27 mm. Thickness, 0·1–0·15 mm.

SUMMARY OF CURRENT RESEARCHES
RELATING TO
ZOOLOGY AND BOTANY
(PRINCIPALLY INVERTEBRATA AND CRYPTOGAMIA),
MICROSCOPY, ETC.*

ZOOLOGY.

VERTEBRATA.

a. Embryology.†

Oogenesis in Mammals.‡—A. Louise McIlroy has studied the development of the germ-cells in the mammalian ovary, with special reference to the early phases of maturation. Her material was based on human embryos, puppies, kittens, and rabbits. The same plan of development is followed in the varied types, but differences arise in the rate of development ante- and post-natal, the cells maturing from the periphery inwards.

The capsular epithelium is derived from the oogonia, and is differentiated at a very early stage. It has only a protective function.

Mitosis occurs among the oogonia, and also among the primary oocytes of the reticular stage. It ceases at a given stage in the development of the ovary.

Large cells—giant or resting cells—occur in the reticular stage of the primary oocyte. "Pflüger's tubules" are columns or clusters of cells derived from the oogonia, separated off by means of the stroma cells. The growth of the stroma and germ-cells is mutually correlated throughout the development of the ovary. The follicle cells, which form the cells of the stratum granulosum, are derived from the oogonia, and not from the stroma cells. The latter are only supporting and vascular.

The reserve cells (oogonia and regressive oocytes scattered throughout the ovarian tissue) may function as follicle or as interstitial cells; they may become absorbed as pabulum for the developing oocyte. The primary oocytes undergo transformations in their early maturation stages.

* The Society are not intended to be denoted by the editorial "we," and they do not hold themselves responsible for the views of the authors of the papers noted, nor for any claim to novelty or otherwise made by them. The object of this part of the *Journal* is to present a summary of the papers *as actually published*, and to describe and illustrate Instruments, Apparatus, etc., which are either new or have not been previously described in this country.

† This section includes not only papers relating to Embryology properly so called, but also those dealing with Evolution, Development, Reproduction, and allied subjects.

‡ Proc. R. Soc. Edinburgh, xxxi. (1910) pp. 151-78 (6 pls.).

which correspond to the prophase of the heterotypical divisions occurring in plants and animals.

The stage of synapsis is the most prolonged and of most importance. The chromatin filaments undergo a pseudo-reduction during this stage, and they undergo apparent longitudinal division in the stage following the formation of the thick spireme. The nucleolus persists during all the stages of transition of the nucleus, although its staining capacity may vary.

No evidence was found in the medullary cords of the presence of cells that might lead to the formation of primary oocytes. The glandular structures in the hilum are the remains of the Wolffian and rete tubules.

Development of the Extremities in Birds.*—F. Sieglbauer publishes an account of his researches on the development of the skeleton of the extremities in birds, showing especially the parallelism in the early stages of the development of the widely different wing and foot, and the relation of this to phylogenetic evolution. The development of the wing and foot of the penguin, *Pygoscelys papua*, and of the duck, *Anas boschas*, is described in detail, special emphasis being laid on the phenomenon of heterochrony, which the author regards as of great importance in the developmental history. The general results of the paper may be stated as follows:—The skeleton of the foot of *Pygoscelys* arises in the same way as that of the duck's foot. In the fifth toe of the duck the lizard-character persists: while in the penguin, as in the domestic fowl, only a blunt knob can be recognized in the later stages. The first tibial toe, on the other hand, is much more highly developed in the penguin than in the duck. The development of the skeleton of the bird's wing and foot shows, in addition to the heterochronous characteristic of the development of extremities in general, many points of agreement with that of reptilian extremities. Since in the bird "hand" the first finger, as in *Seps tridactyla*, no longer attains to development, and the second, fourth, and especially the fifth, remain rudimentary, the third becomes the wing-bearing digit, and may be regarded as analogous to the axis of the steering fin. The whole function of the wing-skeleton is to form an articulated yet firm basis for the quills, and therefore the bird hand is rudimentary and very unlike that of its ancestors. The skeleton of the foot has changed much less in the course of phylogeny, although the reptilian character has become blurred by the degeneration of the first toe, by the complete disappearance of the fifth toe in the ontogeny, and, above all, by the lengthening of the bones of the lower leg and the metatarsals, and the fusion of the latter with the distal tarsals. It is, above all, this lengthening of the leg-bones, and the consequent raising of the body from the ground, that distinguishes the birds from the creeping reptiles. This character is of advantage not only in running but in taking flight from a flat surface.

Development of the Limbs in Grebes.†—The late F. T. Rosenberg made a study of the development of the limbs and bill in grebes. The material used was chiefly the eggs of the black-necked grebe, the only

* Zeitschr. wiss. Zool., xevii. (1911) pp. 262-311 (2 pls. and 16 figs.).

† Tom. cit., pp. 119-217 (1 pl. and 13 figs.).

species which nests in colonies in Germany. The eggs were artificially incubated to secure a continuous series. It was found that the intermediate and centrale are not present in the grebe embryo. The transitory metacarpal iv. regularly occurs, and attains its greatest development on the 15th day. The transitory metacarpal v. appears only on the 11-12th day, and then atrophies. The grebes now living are descended from ancestors which had bills of a pronounced *Larus* type.

Origin of White Blood-corpuses and Spleen in *Bufo vulgaris*.*

H. Mictens has investigated embryos of the common toad, *Bufo vulgaris*, with a view to determining the origin of the white blood-corpuses and the spleen. The white blood-corpuses arise in three different ways: (1) through differentiation from the primitive indifferent blood-cells, which also give rise to erythrocytes, and perhaps to connective-tissue elements; (2) through a rounding off of mesenchyme-cells; (3) through the liberation of endocardial cells. In the larvæ white and red blood-corpuses do not pass into one another. Myelocytes and lymphocytes are modifications of the same lymphocyte-like original cells. The developed liver does not play an important part in blood-making during larval life. Leucocytes arise only from the mesenchyme around the bile-duct. After metamorphosis, blood-production increases greatly. The blood-cells, both red and white, arise from foci lying mainly between the large veins and the bile-duct. There is no intra-vascular blood-production. The sinus-like blood-spaces of the liver offer favourable conditions for the increase and development of the leucocytes. The red blood-corpuses of the larvæ correspond phylogenetically to the pigment-elements which function in the earlier developmental stages in the higher classes. The thymus arises through the migration of lymphocytes into an originally epithelial rudiment, and a multiplication of these within it. There is no production of white blood-corpuses. The mesenteric leucocyte-focus is an important seat of development of the leucocytes. The white blood-corpuses are differentiated from originally indifferent mesenchyme elements. The leucocyte focus is localized round the branchings of the intestinal vessels. It attains its greatest development at the time of the metamorphosis. Multiplication of the white blood-corpuses takes place in the mesenchyme of the pronephros. The spleen arises from a congregation of primitive migratory cells in the sheath of the mesenteric artery near the place of its origin. The coelom epithelium plays a limited part in its origin. In the glomerulus of the pronephros it was possible to detect elements which showed great similarity to nerve-cells.

Structure and Development of Posterior Lymph-hearts of Turtles.†

Frank A. Stromsten has studied the lymph-hearts of loggerhead turtles. The development is initiated by the vacuolation of the post-iliac mesenchyme-tissue in the second week. The spongy tissue thus formed is invaded by capillaries from the caudal portion of the post-cardinal veins. Near the close of the third week, parallel veno-lymphatic channels are formed by the confluence of the mesenchymal spaces with each other and with the invading capillaries. These channels anastomose freely and

* Jena. Zeitschr. f. Naturw., lxiv. (1910) pp. 301-56 (2 pls.).

† Publications Carnegie Inst. Washington, No. 132 (1910) pp. 77-87 (2 pls.).

communicate, by means of two or three openings, with the vein running along their mesial borders.

At the beginning of the fourth week, the mesenchymal tissue condenses about the veno-lymphatic channels to form definite walls. These cardiac walls are then invaded by muscle-cells from the adjacent muscle plates.

The final stage in the development of the posterior lymph-hearts is reached by the dilatation and confluence of these veno-lymphatic sinuses, from before backward, forming a pair of sac-like organs, each with a single central cavity.

It appears from the investigation that the mesenchymal spaces play a much greater part in the development of the lymphatics in general than is usually supposed.

Blastopore Closure in Amphibia.*—H. W. Goodale finds that it is possible to make a definite relatively permanent mark with Nile blue sulphate on the eggs of *Spelerpes bilineatus*. The dye stains the yolk-granules. Among other experiments a series of spots was made about the equator shortly before gastrulation. During gastrulation the spots elongated into bands, which, when the blastopore is nearly closed, extend from the equator to the edge of the blastopore. The extension into bands is due to the division and subsequent migration of part of the daughter-cells of the equatorial cells. The stained yolk-granules record their path. In *Spelerpes* the mode of blastopore closure is very unusual. The lateral lips extend so as to cover half of a circumference, and then further progress ceases. The blastopore gradually contracts into a straight line, which shortens until at last only a minute median portion remains as the anus. The blastopore never becomes circular, nor is there a definitive ventral lip.

Inheritance of Complex Growth-forms.†—J. Brownlee discusses the interesting question of the inheritance of complex growth-forms, such as stature, on Mendel's theory. He submits two conclusions: (1) If the inheritance of stature depends upon a Mendelian mechanism, then the distribution of the population as regards height will be that which is actually found, namely, a distribution closely represented by the normal curve; (2) there is nothing in the values of coefficients of inheritance found by Galton and Pearson which cannot be explained on the basis of Mendelian inheritance.

Castration by X-Rays.‡—Cl. Regaud and Th. Nogier find that it is possible to sterilize, totally and finally, the testis of an adult cat by use of X-rays, and without lesion of the skin. There are oviform cells which survive the irradiation, but they do not continue the spermatid lineage. They diminish in number gradually, and the seminal epithelium remains sterile.

Sterilization by X-Rays.§—Th. Nogier and Cl. Regaud describe the complete and definitive sterilization of the dog by means of X-rays. As

* Anat. Anzeig., xxxviii. (1911) pp. 275-9 (2 figs.).

† Proc. R. Soc. Edinburgh, xxxi. (1911) p. 251-6.

‡ C.R. Soc. Biol. Paris, lxx. (1911) pp. 5-7.

§ Tom. cit., pp. 30-32.

in some other mammals, the seminal cells disappear from the testes. As in the cat, there are some refractory oviform cells, but they are not able to repopulate the seminal epithelium. The sterilization can be effected without radio-dermitis by taking certain precautions.

Interstitial Testicular Cells and Secondary Sex Characters.*

L. Mazzetti has studied these cells in various Vertebrate types. He finds that they arise from a transformation of connective cells between the testicular tubules and in lymphatic lacunae. They do not seem to have any importance, or not more than a minimal importance, in connexion with the development of the secondary sex characters. This is affected, however, by the re-absorption of seminal fluid, seminal cells, and their secreted products.

Injection of Testis-extract into Hens.†—Geoffrey Smith has found that the injection had an entirely negative effect on the increase of the comb in adult and young hens when compared with the fluctuations of growth observed in control birds. The injections had no observable effect on the health, body-weight, fertility, blood-properties, or any other features, although very large quantities were administered over periods varying from 15 to 75 days. C. E. Walker observed increase of the comb in hens similarly treated, but Smith believes this was not due to the injection. There is "no evidence," he concludes, "that the testis contains an internal secretion which, when injected into the female, can call forth the production of any of the male secondary sexual characters."

Mammalian Sports.‡—Ernest Warren describes three interesting abnormalities, "striking examples of those curious sports or large variations which occur in a spontaneous manner, and to which we are at present quite unable to assign any definite cause. In all three cases the same abnormality occurred more than once, and the fact of this recurrence adds considerably to the interest of the observations." The first is a duiker (*Cephalophus grimmii*), with a black skin almost devoid of hair. Normally the skin is white with speckled yellow and brown hair, but there is considerable variation in the general colour of the coat. The next offspring by the same parents had also a black skin and had considerably more hair than in the first case.

Warren describes in the second place a hairless black fox terrier, one of a litter of six or seven, otherwise normal. The hairless dog was paired with a pure white terrier, and two of the litter were hairless. The third sport was a bulldog-headed calf.

b. Histology.

Direct Connexion between Muscle-fibrils and Tendon-fibrils.§

Oskar Schultze refers to the general view that the connexion between muscle and tendon is only by the perimysium, and brings forward evidence to show that it is incorrect. A study of embryo mammals and amphibian larvae has convinced him that each muscle-fibre in a bundle

* Anat. Anzeig., xxxviii. (1911) pp. 361-87 (14 figs.).

† Quart. Journ. Micr. Sci., lvi. (1911) pp. 591-612.

‡ Ann. Natal Museum, ii. (1910) pp. 235-52 (4 pls.).

§ Verh. Phys.-Med. Ges. Würzburg, xli. (1911) No. 2, pp. 33-8 (1 pl.).

comes into direct connexion with a bundle of tendon-fibrils, and each myofibril is connected with a tendon-fibril.

Tracheal Epithelium in Domestic Mammals.*—W. J. Loginoff points out that the structural peculiarities of the ciliated cells in the trachea of various mammals, e.g. horse, ox, sheep, are so characteristic that it is not particularly difficult to tell from a preparation what animal it came from. He gives an account of those peculiarities. Attention is also directed to the occurrence (in horse, ox, and dog) of mucus cells branched at the proximal end.

Structure of Spleen Capillaries.†—S. Mollier gives a detailed account of the venous capillaries in the spleen, and adds a general discussion of the problems involved. The spleen is a differentiation of primary mesenchyme. The capillaries arise from an arrangement and differentiation of these primary mesenchyme-cells, and this seems to be a general fact for other vessels. The reticular character of the capillary wall is probably adaptive in connexion with the circulation. If from the mesenchyme cellular reticulum there be derived endothelium, blood-cells, and supporting tissue, it should be recognized that the endothelium retains, by its power of again forming indifferent reticulum, the old developmental value of its parent-tissue which gave rise to mesenchyme. The same may be said for the supporting tissue and blood-cells.

New kind of Cell in Brunner's Glands.‡—Albert Oppel has found a second kind of glandular cell in Brunner's glands in man. They contain large regularly arranged granules, and are something like Paneth's cells in Lieberkühn's glands. They are quite specific glandular cells, probably secreting a digestive ferment.

Mitochondria of Adipose Cells.§—G. Dubreuil calls attention to the remarkable chondriome in adipose cells, and describes the changes in the chondriome in the course of the transformation from fixed connective-tissue cells to fat cells.

Origin of Granules in Gland Cells.||—Oskar Schultze maintains that a filar structure in gland cells is of very widespread occurrence, and that as a general rule the glandular granules arise from plasmosomes which appear from within the filar mass (chondriokonts).

Mitotic Figures in Isolated Tissues.¶—J. Jolly discusses the mitotic figures in isolated marrow and the like. Some represent cells killed in the act of dividing, at variable intervals after the death of the body. Others represent cells which had begun to divide, and are slowly continuing to do so, or are aborting. Others, again—a less important category—represent true divisions in the isolated tissue. Careful criticism is imperative in every case before it can be inferred that the presence of mitotic figures is a proof of genuine growth.

* Anat. Anzeig., xxxviii. (1911) pp. 353-61 (1 pl.).

† Arch. Mikr. Anat., lxxvii. (1911) pp. 608-57 (1 pl. and 42 figs.).

‡ Op. cit., lxxvi. (1911) pp. 525-42 (1 pl.).

§ C.R. Soc. Biol. Paris, lxx. (1911) pp. 48-50.

|| Anat. Anzeig., xxxviii. (1911) pp. 257-65 (2 pls.).

¶ C.R. Soc. Biol. Paris, lxi. (1910) pp. 603-10 (2 figs.).} {

Mitosis in Grafted Tissue.*—A. Pettit observed, in a thyroid and parathyroid engrafted in a dog, that among the obviously degenerated cells there were many instances of normal mitosis.

Survival of Excised Cornea.†—A. Magitat calls attention to recent work on the survival of leucocytes *in vitro*, on the recovery of motion in spermatozoa after eight days, and so on. These investigations led him to experiment with the cornea of the rabbit. The eye was excised, sterilized, and put in blood serum at a low temperature. After 10 to 12 days the cornea was still almost quite translucent, and grafting experiments seemed to show that it was alive.

c. General.

Converse Relation between Ciliary and Neuro-muscular Movements.‡—A. G. Mayer finds that the effects of the ions sodium, magnesium, calcium, ammonium, and potassium upon neuro-muscular movements are in each case the exact opposite of their effects upon the ciliary movements of animals. (Various species of motile fungi and algae react diversely to these ions, and the above statement applies only to animals.)

Ordinary ciliated epithelium, such as that covering the external surface of "Trematodes" (does not the author mean Turbellarians?), is not wholly under the control of the nervous or muscular system of the animal, and the cilia continue to beat even when the muscles underlying them contract.

The more highly specialized cilia, however, such as those of the meridional combs of Ctenophores, the lobes of Veliger larvæ, the peristomial ring of trochophores, or the longitudinal band of Semper's Actinian larva, cease to beat when the muscles underlying them contract, and resume their rhythmic movement only when the muscles relax. Thus an electrical stimulus which causes the muscles to contract stops the cilia; but if the muscles be anesthetized with magnesium so that they cannot contract, an electrical stimulus does not stop the cilia. The stopping of the cilia is therefore dependent upon the contraction of the muscles. It appears, then, that the stimulus which produces ciliary movement tends to cause muscular relaxation, but is too weak to prevent muscular movement; but the stimulus which produces muscular contraction is of an opposite nature, and is more energetic than that required to maintain ciliary movement, and completely overpowers it, stopping the cilia when the muscles contract.

Considering all things which normally affect the animal, whatever stimulates the neuro-muscular system inhibits ciliary movement, and whatever stimulates cilia depresses neuro-muscular activity.

Among the cations of sea-water, sodium is the most potent inhibitor of ciliary activity and the most powerful neuro-muscular stimulant. On the other hand, magnesium is the most potent in maintaining ciliary movement and the most powerful inhibitor of neuro-muscular movement.

Ammonium at first stops, and finally permits the recovery of ciliary

* C.R. Soc. Biol. Paris, lxx. (1911) p. 2.

† Tom. cit., pp. 46-8.

‡ Publications Carnegie Inst. Washington, No. 132 (1910) pp. 1-25 (8 figs.)

movement, but it at first stimulates and afterwards inhibits neuromuscular movements. Weak acids (H ion) at first depress and afterwards permit recovery of ciliary movement, but they at first stimulate and afterwards depress neuromuscular movement. The discovery of this converse relation makes apparent the incompleteness of existing theories of animal locomotion.

Cutaneous Scent-glands of Ruminants.*—R. I. Pocock gives a careful description of the various types of cutaneous scent-glands—pedal, carpal, tarsal, metatarsal, pre-orbital, inguinal, and some others of less common occurrence. He discusses the structure of the glands and the systematic results to be derived from them. The interpretation of the use of the glands in keeping the individuals of a species together is corroborated. There is a good deal of evidence that the pre-orbital gland has a sexual significance, at all events in part. That each scent tells its own tale to other members of the species seems almost beyond doubt.

It is probable that all the pre-orbital glands arose from simple integumental thickenings, with enlarged sebaceous and sweat glands, and the same may be said of many others. The inguinal glands are closely connected with the mammary glands, and the secretion appears to be actually derived from the mammary glands.

Evidence is brought forward in support of the view that the glandular pedal pockets are the remnants, specialized for the secretion of scented material, of a primitive anterior interdigital cleft. The reduction or disappearance of the interdigital clefts is interpreted in relation to strengthening the feet, and the retention or loss of the pedal glands is interpreted in an interesting way in relation to varieties of habit.

Descent of Cattle.†—J. Cossar Ewart has investigated skulls of oxen from the Roman Station at Newstead, Melrose. The examination lent support neither to the descent of all European cattle from the Urus (*Bos primigenius*) nor to the descent of all European, Indian, and African breeds from the Asiatic Urus (*B. nomadicus*).

The Celtic shorthorn (*B. longifrons*) is probably more intimately related to the zebu of India (*B. indicus*) than to the European Urus.

Long premaxillæ are usually correlated with an occiput of the *B. primigenius* type, while short premaxillæ are usually correlated with an occiput of the *B. acutifrons* type.

Polled black Galloway cattle and polled white "wild" Cadzow cattle are intimately related to the Urus. Flat-polled Aberdeen-Angus cattle probably include amongst their ancestors an ancient Oriental race now represented by, amongst others, a Syrian breed with rudimentary horns. Round-polled cattle may belong to a still more ancient Oriental race descended from *B. acutifrons* of the Punjab Sivaliks.

Head of Kogia Breviceps.‡—Ed. Davis gives an account of the structure of the head in this curious Odontocete, a specimen of which was stranded near Roseoff in 1905. He calls attention to such features

* Proc. Zool. Soc., 1910, pp. 840-986 (62 figs.).

† Zoological Soc. Rep. (Feb. 7, 1911). See Geol. Mag., viii. (1911) pp. 141-2.

‡ Arch. Zool. Exper., vi. (1910) pp. 149-74 (4 pls. and 5 figs.).

as the much reduced right olfactory canal, the spermaceti reservoirs, and the structure of the tongue.

Food of Shrew-mole.*—James A. West has examined the stomachs of many shrew-moles (*Scalopus aquaticus*) in Illinois. The contents showed perhaps a greater amount of insect food and somewhat smaller ratios of earthworms than those examined by others, but there is substantial agreement to the effect that half or more of the food consists of insects and their larvae, most of them noxious. To this extent, therefore, it is certain that shrew-moles are beneficial. There is no direct evidence that they attack potatoes or other tubers, but they eat large quantities of corn, and sometimes do considerable damage in fields of newly-planted corn.

Habits of Shrew-mole.†—F. E. Wood has made a study of *Scalopus aquaticus*, the common mole of Illinois. The burrows are usually made without bringing earth to the surface. There seems to be one litter in the year, probably with three to six young ones. There is certain evidence of their eating corn. Little is known of their natural enemies. Numbers are often found lying dead, but un mutilated. Many are badly infested with intestinal parasites, e.g. species of *Filaria* and *Spiroptera*.

Directive Markings of Passerine Birds.‡—H. C. Tracy has made a study of the significance of the white markings in birds of the order Passeriformes. His investigations were directed mainly towards testing the validity of the older interpretation of white markings in birds—as serving rather as a clue to the direction of the disappearing bird than as an aid to recognition of the species—by analyzing their mode of occurrence in a single Order. He finds that there is good ground for believing that markings exposed in flight, whatever their mode of evolution, are of actual utility to birds as sight clues. This is true both of the comparatively uniform rear markings of open ground species, and of the varied top pattern of arboreal forms. There is a decided correlation of the markings with the habit of flocking, as well as with that of open ranging. He shows that sexual selection can only have operated in producing a more sharply defined pattern in the male, but cannot account for the pattern itself. The newer view (Thayer, 1909) as to the concealing effect of white markings, the author finds to be in perfect accord with the older theory of directive markings, though it limits the application of the latter to patterns that can be shown to be conspicuous.

The author considers that the interpretation of diverse coloration as having developed under conditions of comparative immunity from attack needs much greater emphasis than has yet been given to it.

Size of Spleen in Birds.§—Magnan and De la Riboisière have measured the spleen in a large number of birds. They distinguish two main shapes—ovoid and elongated, and they find that large birds have relatively smaller spleens, and small birds relatively larger spleens. La Riboisière previously came to the same conclusion as regards weight.

* Bull. Illinois State Lab. Nat. Hist., ix. (1910) pp. 14-22.

† Tom. cit., ix. (1910) pp. 1-13.

‡ Univ. California Publications (Zool.) vi. (1910) pp. 285-312.

§ Ann. Sci. Nat. (Zool.) xiii. (1911) pp. 269-85 (2 figs.).

Penis of Drake and Gander.*—A. Trawinski gives an account of the macroscopic and microscopic structure of the penis in these birds, and calls attention to a vestigial representation of a penis in the cock.

Linnet of Hawaiian Islands.†—Joseph Grinnell discusses "a problem in speciation" in connexion with the Hawaiian representatives of *Carpodacus frontalis*. This bird was introduced into the Hawaiian islands from California less than forty years ago.

In all available specimens of the linnet from the United States range the usual colour (in the parts of the plumage which are coloured) of males after the post-juvénal moult, is red. There occur rather infrequently, irrespective of locality, individuals of three other colours—yellow (most rarely), orange, and red with yellow or orange feathers intermixed. In California the common red type has prevailed for at least sixty years.

A series of male linnets collected in the Hawaiian islands are all of the yellow or orange type of coloration. The author argues that the peculiarities are not to be considered manifestations of ordinary individual variation, nor as seasonal changes, nor as the result of individual senescence. They must be due in some way to change of habitat.

Evidence is brought forward to eliminate the more obvious environmental factors (temperature, humidity, change of food, reduction of enemies). The off-colour character is somehow associated with insularity of habitat, but the prime stimulus is unknown. "A deficiency in capacity, of the germ, for the formation of the appropriate enzyme may have been intensified through close breeding until the condition was reached where the amount of enzyme produced in the feather-anlage is insufficient to carry on oxidation of tyrosin beyond the yellow, or at farthest the orange stage."

Changes of Plumage in Red Grouse.‡—E. A. Wilson has gone carefully into this question, describing and figuring the plumage changes in cock and hen, and the local variations in both. In the cock the two periods, November to June, and June to November, mark the two seasonal changes of plumage. The first is a plumage worn throughout the winter, as well as during the courting and breeding season of the spring. The second is a plumage worn throughout the summer and autumn. In the hen the two changes of the plumage are completed, in the one case by the end of April or the beginning of May, and in the other case by July and August. The actual feather-changes in the cock and the hen are very comparable in character, notwithstanding the discrepancy as to season, the moults being asynchronous by about two months. Very beautiful plates illustrate the paper.

New Burmese Frog.§—N. Annandale describes a new species of frog used as food in Burmah, and hitherto confused with *Rana tigrina*. The new species *R. burkilli*, frequents the same localities as *R. tigrina*, but buries itself in the embankments of rice-fields in dry weather, while

* Bull. Internat. Acad. Sci. Cracovie (1910) pp. 720-7 (2 pls.).

† Univ. California Publications (Zool.) vii. (1911) pp. 175-95.

‡ Proc. Zool. Soc. (1910) pp. 1000-33 (24 pls. and 1 fig.).

§ Records, Indian Museum, v. (1910) p. 79.

R. tigrina remains active throughout the year. It is distinguished by the following characters: The snout is less pointed than in *R. tigrina* and does not project so far beyond the mouth, the tibio-tarsal joint falls short of the ear, the internal metatarsal tubercle is feebly developed, and the skin of the back is more warty than in the allied species. The dorsal surface is of a dull brownish colour spotted with black, the ventral surface also marked with black sometimes in a reticulate pattern.

Electric Eels.*—G. Schlesinger points out that the Gymnnoti include two entirely distinct families, the eel-shaped *Electrophoridae* and the laterally compressed *Gymnnotidae*. The latter are derived from a common primitive stock which has diverged upon three lines, the primitive *Giton*, the *Sternarchinae* (with dorsal filament and caudal fin), and the *Gymnotinae* (without dorsal filament and caudal fin). There is a very striking parallelism and convergence between *Gymnnoti* and *Mormyridae*, showing how similar conditions evoke similar results. The author shows that the characteristic mode of locomotion in *Electrophorus*—solely by undulations of the anal fin while the body is kept stiff—occurs in the *Gymnnotidae*. In another interesting paper † he concludes that the same is true of the *Notopteridae*.

Study of Species of *Gadus*.‡—Louis Fage has made a rather interesting study of *Gadus luscus* Linné, *G. capelanus* (Risso), and *G. minutus* O. Fr. Müller. He first shows that the three species are distinct. He then considers the phylogenetic value of the differentiating characters, and finds that the three species may be ranked in a phyletic series illustrating progressive adaptation to nektic life, *G. capelanus* being intermediate between the less evolved *G. luscus* and the more evolved *G. minutus*.

Synopsis of Lampreys.§—C. Tate Regan has prepared a synopsis of the order *Hyperoartii*. He gives the following definition: Marsipobranchs with the nasal aperture on the upper surface of the head and the naso-palatine canal ending blindly posteriorly. Eyes well developed (in the adult). Two semicircular canals. Mouth with expanded toothed lips; tongue with a single anterior, and a pair of posterior cuspidate laminae (compound teeth). Branchial sacs seven on each side, not far behind the head, communicating internally with a suboesophageal canal which opens anteriorly into the pharynx; an extra-branchial skeleton forming a basket-work. Eggs small, numerous; segmentation holoblastic; a metamorphosis. A caudal and two dorsal fins, sometimes united.

The larvae (*Ammocetes*) appear to be extremely similar in all the northern genera. They are toothless, with a small transverse lower lip and a hood-like upper lip; a circle of fringed barbels surrounds the mouth. The eyes are rudimentary and subcutaneous, the small gill-openings lie in a groove and the vertical fins are confluent. The branchial pouches communicate directly with the oesophagus.

Eight genera are recognized—*Mordavia*, *Geotria*, *Petromyzon*, *Ichthyomyzon*, *Caspionomyzon*, *Eudontomyzon* g. n., *Entosphenus*, and *Lampetra*.

* Zool. Jahrb., xxix. (1910) pp. 613-40 (3 pls. and 4 figs.).

† *Tom. cit.*, pp. 681-8 (1 pl.).

‡ Arch. Zool. Exper., vi. (1911) pp. 257-82 (2 pls.).

§ Ann. Nat. Hist., vii. (1911) pp. 193-204.

Photogenic Function in Marine Organisms.*—F. Alex. McDermott uses the argument from analogy (colour and luminescence in beetles) to support the view that the coloration and luminescence of marine organisms must be of use. The absence of definite organs for the reception of radiations of light (as in *Salpa*, the author says!) may not necessarily indicate that the forms from which they are absent are insensible to these radiations. "The photogenic functions in certain simple marine forms may replace the olfactory function" (or rather the odoriferous function?) "of terrestrial forms, to some extent," indicating location.

Sense of Light in Animals.†—C. Hess finds that fishes react like totally colour-blind men, while Amphibians are like normal men. For birds and reptiles the short-wave end of the spectrum is much shortened; fowls see up to blue-green, tortoises only to about the green. He finds that caterpillars, midges, flies, seek out the yellow-green part of the spectrum. So do two Crustaceans, *Podopsis* and *Atylus*. Cuttlefishes react like totally colour-blind men—indeed, the same may be said of all Invertebrates. Experiments on the siphons of eyeless bivalves showed that red and orange had almost no effect; the contraction of the siphons was greatest in yellow-green and green, somewhat less in blue and violet. After a period of darkness the adaptive sensitiveness of the siphon is markedly increased.

INVERTEBRATA.

Scottish and Irish Plankton.‡—W. A. Herdman makes a comparison of the summer plankton on the west coast of Scotland with that in the Irish Sea, and shows the curious differences between them. For instance, while the abundant vernal phyto-plankton dies away in the Irish Sea in early summer, a similar micro-flora is present in quantity in some part of the sea on the west of Scotland (e.g. the Sound of Mull, and the sea round Canna, Eigg, etc.) until July, and possibly later.

Micro-fauna of the Nile.§—E. von Daday continues his report on the micro-fauna of the Nile. He deals with Protozoa (8), Rotifers (8), Copepods (7), Phyllo-pods (5), Ostracods (6). Among the last is *Aglaiella stagnalis* g. et sp. n., which may be regarded as transitional between *Aglaiia* Brady, on the one hand, and *Pontoparta* Vavra and *Paracypris* Sars, on the other hand.

Mollusca.

Molluscs of Portuguese East Africa.||—A. Nobre gives a list of the Molluscs collected by Welwitsch, Anchieta, Newton, and others, in Portuguese East Africa, and now deposited in the Bocage Museum, in Lisbon, and elsewhere.

* Amer. Nat., xlv. (1911) pp. 118-22.

† SB. Phys. Med. Ges. Würzburg (1910) pp. 41-3.

‡ Journ. Linn. Soc. (Zool.) xxxii. (1911) pp. 23-38 (8 figs.).

§ SB. k. Akad. Wiss. Wien, cxix. (1910) pp. 537-89 (3 pls.).

|| Bull. Soc. Portugaise Sci. Nat. iii. (1909, received 1911) supp. 2, pp. 1-108.

Molluscs of Ireland.*—A. W. Stelfox gives a list of the land and fresh-water molluscs of Ireland, with an account of the distribution of each species, about 130 in all. Introduced species are also dealt with, and there is a careful bibliography. Fourteen land and fifteen fresh-water species which are known to live in Britain are still unrecorded for Ireland.

γ. Gastropoda.

Cavernicolous Gastropods.†—L. Germain discusses numerous species of *Hyalinia*, *Pyramidula*, *Helix*, *Pupa*, *Ferussacia*, *Cæcilioides*, *Physa*, *Ancylus*, *Bythinella*, and *Lartertia*. While the genera *Zospeum* and *Spelæoconcha* are the only terrestrial Molluscs which are exclusively cavernicolous, there are many species of other genera, such as those named above, which are found oftener in caves than elsewhere.

Phylogeny of Cerithiidae.‡—Elvira Wood traces the probable evolution of some of the Cerithiidae—*Cerithium*, *VulgoCerithium*, *Tympanonotus*, *Potamides*, and *Potamidopsis*. It appears that the Jurassic species, *Cerithium corallense*, may represent the earliest known species of the genus. It has a primitive type of shell of small size, with rounded whorls, and having on its adult volutions three spirals crossed by ribs. The ancestor of this probably possessed a bicarinate ornamentation crossed by ribs and a very slightly developed canal. The genus *Cerithium* includes a great variety of forms; but notwithstanding the wide differences in adults, relationship may be traced by similarity in the young stages, pointing out the path of evolution which all have travelled.

δ. Lamellibranchiata.

Reaction of Tissues of Pecten to Implantation of Foreign Bodies.§ G. H. Drew and W. De Morgan found that the implantation of a piece of gill or gland, or of sterile agar jelly, into the muscle of *Pecten maximus* was followed by multiplication and migration of fibroblasts in the vicinity. In the case of the piece of gill, a layer of typical "scar" fibrous tissue is formed, enclosing the chitinous skeletons of the gill-bars (all that remains after a thorough cleaning up by phagocytes). No permanent layer was formed round the piece of gland, as the migrated fibroblasts are dissolved in the course of the extension of the sphere of action of the digestive ferments. In the case of the agar jelly there is a slow and often mitotic division of the neighbouring fibroblasts: they migrate and rearrange themselves to form a thin layer of fibrous tissue around the agar. The whole process of fibrous tissue formation is essentially like that which takes place in Vertebrates, though the tissues and the blood and its manner of forming a "clot" are so different.

Arthropoda.

α. Insecta.

Mimicry of Ant by Larval Mantis.||—R. I. Pocock describes the larvæ of a species of mantis from the Gold Coast. They were 4 mm. or

* Proc. Irish Acad., xxix. (1911) pp. 65-164 (1 pl.).

† Arch. Zool. Exper., vi. (1911) pp. 229-56 (2 pls.).

‡ Ann. New York Acad. Sci., xx. (1910) pp. 1-92 (9 pls.).

§ Quart. Journ. Micr. Sci., lv. (1910) pp. 595-610 (1 pl.).

|| Proc. Zool. Soc. (1910) pp. 837-40 (2 figs.).

less in length, and when crawling about the case looked exactly like a case of black ants, their rapid darts and pauses recalling irresistibly the way ants go about. When at rest they assumed the attitude of watching mantises, and appeared to be procryptically coloured. Two factors were in the main concerned in effecting the likeness to an ant, namely, the blackness of the underside of the abdomen, and the habit of the mantis when in motion of curling the posterior half of the abdomen up like a scorpion's tail. On attaining a length of 7 mm., the larvæ lost their ant-like look. An apparently similar case has been described by de Nicéville. Attention is drawn also to larvæ of a Ceylonese species of *Phyllium* which resemble a distasteful beetle, also mimicked by two bugs and a moth.

North American Species of Camponotus.*—W. M. Wheeler has revised the North American species of this genus of ants, and deals with 21 species, 17 sub-species, and 27 varieties. The genus includes the largest and most conspicuous North American ants, and also some of the most abundant. It may be divided into two sections, one of which, the *maculatus* group, contains species that nest in the ground under stones or logs, or, more rarely, in obscure crater nests, whereas the other section embraces all the other groups, and contains species that usually nest in dead wood or oak-galls. These wood-inhabiting species, however, exhibit considerable diversity of habit. Apart from the circum-polar *C. herculeanus* and *C. fallax*, all the species are decidedly local.

Study of Sphegidae.†—A. Popovici-Bazosanu has studied *Trypoxylon figulus* and *Pseudulula atratus*, both common insects in the Roumanian rose-gardens. They have specialized predatory habits and insinuate themselves into narrow tubes. The abdomen has a very narrow waist and is very mobile, well adapted for stinging the victims.

The nests of *Trypoxylon* in the rose-stems have partitions of earth, just as in those of *Osmia*, which they closely resemble. There is always a cocoon, and the provisions consist of spiders.

The nests of *Pseudulula* have parchment partitions; there is rarely a true cocoon. The provisions consist of aphides. The carnivorous larva has four sharp teeth on the mandibles; the adult has two blunt teeth, suited for building. Similarly, the larva of *Trypoxylon* has five sharp teeth and the adult only two.

Spermatogenesis in Currant-moth.‡—L. Doncaster has investigated the spermatogenesis in the two forms *Abraeus grossulariata* and *A. lacticolor* and in the heterozygote. He has already shown that in this moth the *grossulariata* character is a Mendelian dominant, and, further, is not borne by eggs which contain the female determiner.

There are two kinds of primary spermatocytes, one set leading to smaller spermatids. As these become converted into spermatozoa there is evidence of nuclear degeneration.

“From the fact that the same process occurs in both varieties, and that usually the expected sexual and Mendelian ratios are found in

* Ann. New York Acad. Sci., xx. (1910) pp. 295-354.

† Arch. Zool. Exper., vi. (1911) Notes et Revue, No. 3, pp. xciii-ciii.

‡ Proc. Cambridge Phil. Soc., xvi. (1911) pp. 44-5.

breeding experiments, it is to be concluded that two types of spermatozoa are not correlated with different heritable characters, and probably those of the second type are not functional in fertilization."

Carnivorous Mosquito Larvæ.*—C. A. Paiva gives some notes on the larvæ of *Toxorhynchites immisericors* Wlk., which are abundant about Calcutta, and were found frequently in earthen pots. These larvæ are carnivorous and, as the experiments here reported have shown, exceedingly voracious. In a vessel with *Stegomyia* larvæ, *T. immisericors* was observed to lie quietly in a vertical position until one of the actively swimming *Stegomyia* larvæ came within reach, when, with a sharp side-ward jerky movement of the head, it seized its prey. Sometimes it only sucks its victim and rejects the skin, which is then greedily devoured by other *Stegomyia* larvæ, but more frequently the whole larva is eaten. In the course of one night over one hundred *Stegomyia* larvæ were eaten up by three larvæ of *T. immisericors*. These carnivorous larvæ will eat any mosquito larvæ without discrimination, except that apparently they do not begin to eat one another until other supplies are running short.

S. fasciata, the yellow fever mosquito, is common in earthen vessels about Calcutta: and the observer considers that the part played by *T. immisericors* in its destruction might be of great moment in the event of yellow fever being introduced into the country.

Apple Red Bugs.†—C. R. Crosby gives an account of two species of Hemiptera, *Heterocordylus malinus* and *Lygida mendax*, which have done much injury since 1908 among the apple-trees of New York State. Their presence is indicated by minute red spots on the leaf, caused by their feeding punctures. The two species are very similar in habit. The eggs of *H. malinus* are inserted in a slit at the base of the fruit spurs, and they hatch soon after the fruit buds begin to unfold. The larvæ pass through five stages, and attain wings at the fifth moult. A technical description of all the stages of both species is given. The larvæ feed at first on the foliage, but attack the young fruit as soon as it is set. The plant-tissue round each puncture hardens and becomes discoloured, and many of the apples fall to the ground or wither on the tree, while many more are so deformed as to be unmarketable. Experiments to control the pest are still being tried.

Both bugs appear to be native to America, and probably fed originally on wild thorn. A closely related species, *H. flavipes* Matsumura, is related from Japan.

Secretion of Ghost Bug.‡—David Hooper discusses the white sugary secretion of *Phromnia marginella*. It is said to be secreted in a liquid state by the larvæ; it drops on to the leaves and hardens; it probably comes from large gland-like organs on each side at the end of the abdomen. The manna-like or wax-like material, found as an encrustation on the leaves, consists in part of dulcitol (dulcitol), an isomeride of

* Records Indian Museum, v. (1910) pp. 187-90.

† Bull. Cornell Univ. No. 291 (1911) pp. 213-25.

‡ Journ. and Proc. Asiatic Society Bengal, v. (1910) pp. 363-6.

mannitol (mannite), $C_6H_{14}O_6$. This also occurs in the sap of the plants on which the insects feed. It is taken up by the insects and re-deposited on the leaves and the bark in an almost pure condition.

o. Arachnida.

Ear Mite of Cattle.*—Ludwig Freund gives some account of *Raillietia auris* Tronessart (= *Gamasus* sp. Leidy = *G. auris* of others) which occurs as a parasite in the external auditory meatus of cattle and sometimes causes disease.

False Scorpions of British Isles.†—H. Wallis Kew has made a useful synopsis of Pseudoscorpiones. The following genera are represented: *Chernes* (9 species, one new), *Chelifer* (2 sp.), *Withius* sub-g. n. (1 sp.), *Cheiridium* (1 sp.), *Ideoroncus* (*Obisium*) (1 sp.), *Roncus* (*Obisium*) (1 sp.), *Obisium* s. str. (3 sp.), *Chthonius* (4 sp.).

New Species of Linguatula.‡—E. A. Johnston describes *L. dingo-philu* sp. n. from a dingo, which differs in many respects from *L. rhinaria* of the dog.

Antarctic and other Tardigrada.§—James Murray gives an account of Tardigrada from the Antarctic (Sir E. H. Shackleton's Expedition), from New Zealand, Australia, some Pacific Islands, and Canada. The memoir also includes a useful discussion of the structure of Tardigrada, of the nomenclature, and of the value of species of Tardigrada. Many of the specific characters are not of any obvious value to their possessors.

The author deals with fifty species, distributed in five genera—*Macrobiotus*, *Echiniscus*, *Diphyscon*, *Milnesium*, and *Orcella* g. n. These fifty species are about half of the known Tardigrada. About twenty-three other forms were obtained, which are not sufficiently known to be identified or named as new. Seventeen species are new, and one new generic type (*Orcella*) is included in the Australian list.

It is noted that the continental areas are much richer than the islands, both in the number of species and in the proportion of peculiar species. The Australian Tardigrade fauna has most peculiarity about it. Specimens of *Macrobiotus arcticus* endured repeated freezing and thawing at weekly intervals, for months, and the eggs retained their vitality after the adults had been kept dry for a year, and conveyed on a voyage through the tropics to England.

e. Crustacea.

Schizopods from North-east Atlantic Slope.||—W. M. Tattersall describes eight new species, two of which required new genera—*Metamblyops* and *Bathymysis*. Four bottom-living species are added to the British and Irish list, two of them previously known only from the West Coast of Greenland. Attention is directed to the striking form and

* Zool. Jahrb., xxix. (1910) pp. 313-32 (11 figs.).

† Proc. R. Irish Acad., xxiv. (1911) pp. 38-64 (3 pls.).

‡ Trans. Proc. R. Soc. S. Australia, xxxiv. (1910) pp. 248-50 (1 pl.).

§ Rep. Sci. Invest. British Antarc. Exped., 1907-9 (Biology) i. pt. 5 (1910) pp. 83-185 (8 pls.).

¶ Sci. Invest. Fisheries Ireland, ii. (1910, published 1911) pp. 1-77 (8 pls.).

remarkable diversity of structure in the eyes of the deep-water Mysidæ. Material for interesting speculation may be found in the possible functions of the processes of the eyes in the genera *Dactylerythrops* and *Peramblyops*, or the curious equatorial membranous ridge of the eye in *Dactylamblyops thauumatops*.

Annulata.

Pelagic Polychæts of Irish Seas.*—R. Southern reports on five Alcioپیnæ, four Tomopteridæ, and four Typhloscolecidæ found as part of the pelagic fauna off the coasts of Ireland—in the warm and comparatively highly saline waters of the European branch of the Gulf Stream. They rarely cross the 200-fathom line. With the exception of two species of *Tomopteris*, the recorded species are all new to British marine area.

Notes on Polychæts.†—W. C. McIntosh discusses *Syllides verrilli* Moore which presents interesting features of relationship with Staurocephalidæ as well as with Syllids; *Neraya whiteavesi* g. et sp. n., from the Gulf of St. Lawrence, a form with certain relationships to *Sclerocheilus* Grube; and a number of Cirratulids, e.g. species of *Chætozone*, from Canada, Norway, and Britain.

Polychæt from the Delta of the Volga.‡—A. Dershawin reports the interesting occurrence of a species of *Hypatina* (probably *invalida*) in the Delta of the Volga. It has hitherto been known only from the Caspian Sea, where it has an extraordinarily varied distribution, from 5·5–264 m. in depth, in diverse conditions of salinity, pressure, and temperature.

Development of Trochophore of Hydroides.§—Creswell Shearer describes the segmentation and gastrulation, the origin of the ectomesoblast and celomesoblast, and the early trochophoral stages in *Hydroides uncinatus* (*Eupomatius*). There is a round blastula with a much reduced blastocel. Invagination produces at first an almost spherical gastrula, which soon begins to assume the conical shape of the early trochophore. The blastopore closes from behind forwards, the anterior portion remaining as the mouth. The anus breaks through at the point where the posterior end of the blastopore closes.

At a time when gastrulation is about half completed, some cells appear on either side of the endoderm; they probably represent ectomesoblast; they form the head-kidneys, which open into the proctodæum. At the same time two conspicuous cells are usually distinguishable in the ventral lip of the blastopore—the celomesoblast. At a considerably later stage they give rise to the mesoderm bands.

Parasitic Castration of Earthworms.||—Igerma B. J. Sollas found a marked bacterial infection in a number of full-sized earthworms

* Sci. Invest. Fisheries Ireland, iii. (1910, published 1911) pp. 1–37 (3 pls.).

† Ann. Nat. Hist., vii. (1911) pp. 145–73 (3 pls.).

‡ Zool. Anzeig., xxxvi. (1910) pp. 408–10.

§ Quart. Journ. Micr. Sci., lvi. (1911) pp. 543–90 (3 pls. and 29 figs.).

Ann. Nat. Hist., vii. (1911) pp. 335–7.

(*Lumbricus herruleus*), which showed either no clitellum or a poorly-developed one, small seminal vesicles without sperms or more or less normal seminal vesicles with chiefly immature sperm-cells, empty spermathecae, and normal ovaries. The cytophores and the spermatocytes themselves were crowded with minute spherical bacteria in active movement. Amœbocytes were conspicuous in the seminal vesicles, and were crowded with ingested and now motionless individuals of the bacterium in question. That these bacteria are a serious and constant enemy of the earthworm seems to be shown by the comparative frequency with which worms devoid of clitellum and normal sperm occur, and also by observations upon earthworms found travelling over the surface of paths after rain.

Extra-enteric Aperture in a Leech.*—L. Johannson describes in an African leech, *Salifu perspicar* Blanch., a dorsal opening between the fourth and fifth ring of the thirteenth segment. It occurred in all the specimens examined, and was as large as the male aperture. In 1892 Horst noted a similar aperture in a species of *Nepheleis* from Sumatra, but did not regard it as normal.

Nematohelminthes.

Ascarids of Carnivores.†—A. Railliet and A. Henry recognize two genera—*Belascaris* Leiper, including *B. mystax*, *B. marginata*, *B. vulpis* and *B. masculior* sp. n.; and *Torascaris* Leiper, including *T. leonina*, *T. limbata* sp. n., and *T. microptera*. They have gone into the question of synonymy and revised the characters of the previously described species.

Anguillulidæ of the White Slime of Oaks.‡—J. G. de Man has inquired into the Anguillulidæ which are found in the white flow that comes from diseased oaks in summer (June–August). The flow is associated with fungi which cause alcoholic fermentation and subsequent acetic fermentation. In this there is found what must be regarded as a free-living variety (var. *dryophila*) of *Anguillula aceti* (Müller). This is the first recognition of a free-living form of this well-known species. Besides this, however, the author recognizes an equally abundant new species which he calls *A. ludwigii*. There is some discussion of the distinctive features of the genus *Anguillula*.

Microfilarie in Tonkin Birds.§—C. Mathis and M. Leger report on the Microfilarie in the blood of a quail, a marabout stork, and two Chinese Passerine birds (*Garrular perspicillatus* and *Copsychus saularis*). All were young forms, but apparently new species.

Platyhelminthes.

Life-cycle of *Dicrocœlium lanceatum*.||—B. Zarnik describes the cercariæ of the Trematode which is otherwise known as *Distomum*

* Zool. Anzeig., xxxvi, (1910) pp. 105–8 (3 figs.).

† C.R. Soc. Biol. Paris, lxx, (1911) pp. 12–15.

‡ Zool. Jahrb., xxix, (1910) pp. 359–94 (3 pls.).

§ C.R. Soc. Biol. Paris, lxx, (1911) pp. 60–62 (1 fig.).

|| SB. Phys. Med. Ges. Würzburg (1910) pp. 27–31 (1 fig.).

lancoletum. He found cercariæ in the liver of a badly infected sheep. They are very minute, only 570μ in length, of which the tail forms 250μ . They showed no oral differentiations and no skin-glands. From the absence of glands, as well as from the persistent tail, the author infers that the cyst stage, on grass or the like, has been wholly suppressed, and that the cercariæ are taken into the sheep with the water. The intermediate host is probably a snail. Zarnik also refers to the development of the gonads, and notes that the ovary is always ripe before the testes.

Stilesia and its Relatives.*—L. H. Gough gives an account of the tapeworms of the sub-family Avitellinæ, which includes *Stilesia* and a new genus *Avitellina*. He also describes the minute structure of *Avitellina centripunctata* (Riv.). The name *Avitellina* denotes the absence of a vitelline gland, and it may be noted that in *Avitellina* the uterus is single, there is a single paruterine organ, the testicles are in four groups, the genital canals pass dorsally of the dorsal canal, whereas in *Stilesia* the uterus is double, there are two paruterine organs, the testicles are in two groups, and the genital canals pass ventrally of the dorsal canal.

Incertæ Sedis.

Irish Polyzoa.†—A. R. Nichols reports on a collection of Polyzoa, mostly Cheilostomata, made off the Irish coasts. It consists of 101 species, 80 of which were obtained off the west coast at a greater depth than 50 fathoms. Twenty-three species are recorded for the first time from the Irish coast, and six of these, *Filisparsa irregularis*, *Menipea smittii*, *Scrupocellaria intermedia*, *Kinetoskias smittii*, *Hemicyclopora multispinata*, *Pasythea eburnea*, do not appear to have been previously obtained on any part of the British coasts. On some fragments of a species of *Brettia*, probably a new variety of *B. pellucida* Dyster, oöcia were found for the first time for this genus.

Rotifera.

Histology of Rotifera.‡—Gustav Hirschfelder contributes a detailed account of the histology of various organs of *Eosphora*, *Hydatina*, *Euchlanis*, and *Notommata*. The organs of which the finer structure is more particularly described are the following:—the rotatory organ and cilia; central nervous system and peripheral nerves; sense-organs; retro-cerebral apparatus and subcerebral gland; eye; digestive tract; mastax and jaws; and the muscles. The clear account of the retro-cerebral sac and subcerebral gland, overlying the brain, with their respective forked frontal ducts, is a substantial advance in the understanding of these two organs, which formerly were confounded with the brain. The use of the secretion of these two glands still remains a mystery. The description of the jaws of *Eosphora digitata* and their mode of action is most instructive, and reveals a wonderfully ingenious and delicate apparatus confined within the very small space of the mastax.

* Quart. Journ. Micr. Sci., lvi, (1911) pp. 317-85 (3 pls. and 6 figs.).

† Scient. Invest. Fisheries Ireland, i, (1910, published 1911) pp. 1-37 (1 pl.).

‡ Zeitschr. wiss. Zool., xcvi, (1910) pp. 209-35 (5 pls.).

Dipleuchlanis, a new Sub-genus for **Euchlanis** (Diplois) **propatula** Gosse.*—P. de Beauchamp having found in material collected in Syria, by H. G. de Kerville, a specimen of this aberrant Rotifer, proposes to place it in this new sub-genus.

Echinoderma.

Extra-ovate Experiments on Sea-urchin Ova.†—Naohide Yatsu obtained extra-ovates in *Arbacia* and *Strongylocentrotus*, by treating the fertilized ova with diluted sea-water and then replacing them. An extra-ovate was extruded at the height of turgor, the cleavage of the egg was more or less abnormal. The abnormality is not due to the diluted sea-water, as is shown by the fact that under the same treatment all other eggs (without an extra-ovate) in the same vessel cleaved normally, and by the fact that the disturbance in cleavage is found at the spot where the extraovate is situated. The disturbance is due to the deprivation of a portion of the cytoplasm as an extra-ovate. Thus we may say that the cleavage pattern is already established in the fertilized egg of *Arbacia* and *Strongylocentrotus*, as Driesch has shown in *Echinus*. It may be noted that an egg with an extra-ovate gives rise to a perfect pluteus.

Echinoderm Hybridization.‡—D. H. Tenment has made numerous experiments in Echinoderm hybridization, and gives a careful discussion of the problems involved. The *Toxopneustes* ♀ × *Hipponoë* ♂ cross, and the reciprocal were easily made after allowing the eggs to stand in sea-water for some hours after fertilization. In the embryos of both crosses made in ordinary sea-water, which was alkaline, the *Hipponoë* influence showed a tendency to predominate. In the embryos of both crosses made in sea-water of increased alkalinity, there was evidence of an increase in *Hipponoë* influence. In the embryos of both crosses made in sea-water of decreased alkalinity, a tendency toward *Toxopneustes* dominance was evident. The results thus show *Hipponoë* dominance in sea-water of a higher OH ion concentration, and *Toxopneustes* dominance in sea-water of a lower OH ion concentration.

It is suggested that these variations in the alkalinity of sea-water, brought about artificially in the laboratory, may correspond to normal seasonal changes. If this be true, the winter (paternal) embryos and the summer (maternal) plutei of the combination *Sphærechinus* × *Strongylocentrotus* of other investigators had their origin in such normal seasonal changes of OH ion concentration.

The results of this and other investigations show species tendencies towards different grades of temperature and alkalinity. The explanation of the preponderance of one character over another in Echinoderm hybrids seems to be in the reaction of the species towards a complex of factors.

Early Stages of Development in Echinoderms.§—Julius Schaxel describes the structure of the ovary, the maturation, the cleavage, the

* Bull. Soc. Zool. France, xxxv. (1910) pp. 122.

† Annot. Zool. Japon, vii. (1910) pp. 213-18 (8 figs.).

‡ Publications Carnegie Inst. Washington, No. 132 (1910) pp. 117-51 (6 pls.).

§ Arch. Mikr. Anat., lxxvi. (1911) pp. 543-607 (5 pls. and 8 figs.).

formation of the larval skeleton, in examples of all the divisions of Echinodermata, and discusses the general import of his results, with particular reference to the co-operation of the various components of the cell. The author enters into an analytical discussion of the relations of nucleus and protoplasm, and of the role of the chromatin. His general view is that the chromatin functions as a regulative substance, by which the formative processes going on in the cytoplasm are determined.

Structure of *Pentaceros reticulatus*.*—D. H. Tennent and V. H. Keiller describe this common West Indian starfish. Of the organs described and figured, those which seem of most interest are the intestinal caeca. They were sometimes found greatly distended, and stimulation caused contraction. When individuals from which the aboral wall was removed were allowed to remain undisturbed in sea-water, the organs again became distended. Later on they contracted of their own accord. This supports the view, based in the main upon the similarity of position, that these caeca of the starfish are analogous with the respiratory trees of the Holothurian.

Cœlentera.

Australian Alcyonarians.†—J. Arthur Thomson and Doris L. Mackinnon report on a collection of thirty-five species made by H.M.C.S. 'Thetis' off the coast of New South Wales. The collection has a very definite character, due to the proportionately large number of Isidæ (e.g. six species of *Mopsea*, four new) and of Primnoidæ (e.g. five new species of *Plumarella*). These Isid and Primnoid colonies are extraordinarily beautiful, and their superficial resemblance to large fronds of Sertularians is very striking. Another feature of the collection is the frequent occurrence of encrusting colonies of *Alcyonium* (*Erythropodium*) *membranaceum* and *A. reptans*, which grow over Gorgonid axis in a very misleading fashion.

Keroëididæ.‡—Kumao Kinoshita proposes to erect a new family, Keroëididæ, within the order Gorgonacea. He has convinced himself that *Keroëides* is no true Scleraxonian, and must be removed from the Suberogorgiidae. Perhaps the same must be said of Simpson's new genus, *Dendrogorgia*. The new family, Keroëididæ, is defined as follows: Colony erect; axis rigid, consisting of a central cord and of a cortical layer composed of smooth spicules conglomerated together by a horny matrix; the axis epithelium remains only at the tips of the branches; polyps retractile into more or less well-developed calyces; spicules not scaly.

Excluding *Keroëides* (and *Dendrogorgia* provisionally) the family Suberogorgiidae may be characterized as follows: Scleraxonians with distinct axis, which is not jointed, formed of fused spicules and horny matrix, with a rudimentary central cord composed of cortex spicules;

* Publications Carnegie Inst. Washington, No. 132 (1910) pp. 111-16 (3 pls. and 2 figs.).

† Scientific Results of the Trawling Expedition of H.M.C.S. 'Thetis,' Part 13, Alcyonaria (Sydney, 1911) pp. 661-95 (22 pls.).

‡ Annot. Zool. Japon., vii. (1910) pp. 223-30 (1 pl. and 1 fig.).

cortex with some main longitudinal solenia and smaller reticulated ones; polyps retractile within more or less developed calyces; spicules spindle-shaped.

Australian Pennatulids.*—Hjalmar Broch describes *Sarcophyllum roseum* sp. n. from Middleton Beach, Albany, and distinguishes it from *S. grande* (Gray) Kölliker. He also describes *Pteröides hymenocaulon* Bleeker from Shark's Bay. Emphasis is laid on the fact that the spicules of Pennatulids, which have been generally regarded as on the whole uniform, show minute distinctive features.

Regeneration in Corymorpha.†—H. B. Torrey shows that this hydroid is extremely plastic in its regeneration, as also in its development. The amount of plasticity exhibited depends upon the differentiation of the regenerating piece, particularly upon its degree of organization into a whole, or the degree to which the original interrelations of its parts have been disturbed by experimental conditions. He discusses experiments bearing on the effect of old parts upon regeneration; the effect of the position of the wound on the development of pre-existing root-like processes; retrograde changes in small pieces; regeneration at oblique wounds; and so on.

Hydroids of Drobak.‡—Hjalmar Broch gives an account of the Hydroids of Drobak Fjord, with a clearly written introduction which will be useful to collectors and students, and a well worked out diagnostic key to the genera.

Polypodium hydriforme.§—A. Dershawin reports the discovery in the Delta of the Volga of a free-living phase of the Hydroid *Polypodium hydriforme*, which has hitherto been known as a parasite on the eggs of the sturgeon.

New Plumularid Genus.||—A. Billard describes *Sibogella erecta* g. et sp. n., a new Plumularid collected by the 'Siboga.' The stems are canaliculate and bear numerous branches, rarely in verticils, more frequently arising irregularly all round. They are sometimes so thickly crowded that an appearance of verticils is produced. The hydroclads are borne by the branches and lie in different planes. The genus is adjacent to *Nemertesia* (*Antennularia*), but the hydroclads in the latter are borne by the stem directly.

Porifera.

Remarkable Pharetronid Sponge.¶—R. Kirkpatrick describes *Murrayona phanolepis* g. et sp. n. from Christmas Island. It differs greatly from any previously described Pharetronid sponge. There is a firm main skeletal network entirely devoid of spicules. The surface of the sponge is covered with a dermal armour of large calcareous scales. The poral and sub-dermal spicules are triradiate. The poral area is

* Fauna Süd-west Australiens, iii. lief. 2 (1910) pp. 111-21 (1 pl. and 9 figs.).

† Advance Print from Proc. 7th Internat. Zool. Congress, 1907 (1910) pp. 1-2.

‡ Nyt. Mag. Naturvidensk., xlix. (1911) pp. 1-31 (2 pls.).

§ Zool. Anzeig., xxxvi. (1910) pp. 408-10.

|| Arch. Zool. Exper., vi. (1911) Notes et Revue, No. 3, pp. cviii-cix. (1 fig.).

¶ Proc. Roy. Soc., Series B, lxxxiii. (1911) pp. 124-33 (2 pls.).

limited to a semicircular equatorial groove. It is obvious that the new type is of unusual interest.

Protozoa.

Studies on British Foraminifera.*—E. Heron-Allen and Arthur Earland contribute interesting and beautifully illustrated studies of *Massilina secans* d'Orbigny and *Polystomella crispa* L., the two commonest Foraminifera in English shore-gatherings.

Antarctic Rhizopods.†—Eugène Penard reports on the Sarcodina collected by James Murray in the 'Nimrod' expedition. They were obtained from among moss. There are no fewer than seventy-nine species, mostly cosmopolitan, but some of considerable interest.

Reactions of Amœba to Light.‡—S. O. Mast has made a study of the reactions of *Amœba* to light. He found that a sudden and sharp increase of light causes retardation or cessation of movement in *Amœba proteus*. This effect may be local if the increase is local. If the intensity is very gradually increased it produces no response, showing that the reaction of *Amœba* is dependent primarily on the change of intensity. *A. proteus* is negative in strong light, and orients fairly accurately. Orientation is brought about by the inhibition of the formation of pseudopods on the more highly illuminated side. This is probably due to local changes of intensity, owing to the movement of the protoplasm and the resulting shadows of one part passing over others. There is no evidence that the direction of the rays, or the absolute intensity of light on the whole organism, has any effect apart from producing changes of intensity. The blue (430–490 $\mu\mu$) in the solar prismatic spectrum is nearly as effective in causing reactions in *A. proteus* as white light. Violet, green, yellow, and red are only very slightly active. The author considers it highly probable that different photochemical changes are associated with the reactions to light in different organisms.

Experiments on Paramœcium.§—K. R. Lewin has been able to divide living specimens of *Paramœcium caudatum*, so that each fragment has a piece of meganucleus, but only one has the micronucleus. The "amicronucleate" forms were able to propagate by normal fission. The animals seem quite normal, though the culture was not very vigorous. A race was produced without visible micronuclei. It is possible that the micronucleus exerts some influence on the rate of division.

The experiments show, as regards *P. caudatum*, that Le Dantec's statement as to the regeneration of the micronucleus from the meganucleus after merotomy, is incorrect. They also demonstrate that the interaction of cytoplasm and meganucleus is sufficient to maintain the discontinuous growth of the cell during a considerable period.

Effect of Inanition on Paramœcium.||—Irene Lipska has studied the effects of inanition on *Paramœcium caudatum*. The duration of

* Knowledge, xxxiii. (1910) pp. 285–6; 304–6 (3 figs.); 376–9 (7 figs.).

† Rep. Sci. Invest. Brit. Antarc. Exped., 1907–9, i. (1911) pp. 203–62 (2 pls.).

‡ Journ. Exper. Zool. ix. (1910) pp. 265–77 (2 figs.).

§ Proc. Cambridge Phil. Soc., xvi. (1911) pp. 31–41 (1 fig.).

|| Rev. Suisse Zool., xviii. (1910) pp. 591–643.

life varies with the individual and according to the rigour of the starvation. It is on an average 5 to 7 days, but, in rare cases, it may be prolonged for 20 days. On the fourth day of starvation the *Paramecium* begins to become deformed, first showing a dorso-ventral flattening, and finally taking the form of a crescent, with the convexity dorsal. There is a progressive diminution in size, especially as regards breadth, so that the animal becomes relatively longer than in the normal state. It dies when it has lost about half its original volume. The ectoplasm undergoes no change, and the cilia and trichocysts remain intact, but the endoplasm gradually loses all its digestive vacuoles and some of its crystals, thus becoming extremely transparent. The macronucleus increases in size, elongates, and divides into two halves, which move away from each other. This breaking up has no relation to amitotic division, and its products persist till death without undergoing digestion. The micronucleus moves away from the macronucleus, but, as a rule, it undergoes no alteration in form or structure, whatever may be the duration of life. Individuals in which starvation is not pushed to an extreme are able to recuperate all their normal characters if they are placed in a medium of weak but gradually improving nutritive capacity. Death is preceded by a progressive slowing of all the functions, including the play of the cilia and the contractions of the vacuoles. The degenerative process in a starved *Paramecium* is thus, in a general way, similar to that which takes place in individuals that have been poisoned by the excretions of butyric or other putrefactive bacteria. The vacuolization of the endoplasm, which has been attributed by some authors to inanition, is apparently a result of the chemical action of the ammoniacal products always present in infusions in which putrefaction is going on.

Two Thousand Generations of *Paramecium*.*—Following up his earlier papers on the life-cycle of *Paramecium*, L. L. Woodruff describes an attempt to eliminate the cyclical character of the rate of production by constantly subjecting the Infusoria to a varied environment. The pedigree culture was started with a "wild" *Paramecium aurelia*, and when it had divided twice the four individuals were isolated on other slides. A specimen of each of these four lines was isolated daily, so as to preclude the possibility of conjugation between sister-cells. The culture medium was made from materials collected practically at random, the infusion being thoroughly boiled to prevent contamination by wild individuals. In the 41 months during which the culture has been under observation it has not completed a "cycle," though there has been a rhythmic rise and fall in the division-rate. The rate of fission is graphically plotted in a series of charts. The author believes that this culture shows clearly that *P. aurelia*, under suitable culture conditions, has the power of unlimited reproduction by division, without conjugation or artificial stimulation.

Leptomonad in *Euphorbias*.†—G. Bonet and E. Roubaud confirm Lafont's discovery of *Leptomonas davidi* in *Euphorbia*. The infection is local; it does not seem to last; it does not seem to have any bad effects. They were led to regard a small Hemipteron, *Dieuches humilis*, as the

* Arch. f. Protistenkunde, xxi. (1911) pp. 264-6.

† C.R. Soc. Biol. Paris, lxx. (1911) pp. 55-7 (1 fig.).

infecting agent. In the case of *Euphorbia pilulifera*, fresh experiments by Lafont * lead him to regard the Hemipteron *Nysius euphorbiæ* as the transmitting agent.

Trypanosome and Leptomonad in *Drosophila*.†—E. Chatton and A. Leger give reasons for regarding as specifically distinct two related parasites known to occur in the Muscid *Drosophila confusa*, viz. a *Trypanosome* (of the *T. dimorphon* type), in the Malpighian tubes, and an aciculate *Leptomonas* (*L. drosophilæ*) in the intestine.

Structure of *Euplotes*.‡—L. E. Griffin has given a well worked out and beautifully illustrated account of the structure of *Euplotes worcesteri* sp. n., which was found in some water taken from Manila Bay. The broad, considerably excavated peristome, extending two-thirds the length of the body, contains 45 to 70 wide membranelle; the mouth is irregularly oval and large; the pharynx is long, recurved, containing 20 to 30 membranelle, several oblique rows of endoral cilia, and a group of suboral membranelle; there are 7 frontal cirri, 3 abdominal cirri, 5 anal cirri, 2 left marginal cirri, 0 to 3 right marginal or caudal cirri; the sensory bristles on the dorsal surface are usually in eight longitudinal rows; on the ventral surface there are paroral, exoral, and lateral rows of sensory bristles, and two to four bristles at the base of each cirrus; the meganucleus is long and horseshoe-shaped, with a fluke-like enlargement at the posterior end, and a considerable thickening where it bends across the anterior part of the cell; the single micronucleus lies in a slight depression of the meganucleus, on the left side near the anterior end of the body.

Division of *Euplotes worcesteri*.§—L. E. Griffin describes the process of division in this Infusorian, and emphasizes the fact that "many of the Protozoa are not simple but extremely complex animals." The process includes two stages, one of preparation, the other of actual division of the body and meganucleus. During each stage a definite series of changes occurs in nearly every organ.

The stage of preparation for division includes the reconstruction and concentration of the meganucleus, the invagination of the rudiment of the new peristome, the division of the micronucleus, and the appearance of the new cirri.

That of division includes the constriction of the body and separation of its halves, the drawing of the new peristome to the surface of the body and into its final shape and position, completion of the new pharynx, division of the meganucleus, absorption of the old cirri, and the shifting of the new cirri from the places of their origins to their ultimate positions.

Species of *Leucocytozoon*.||—C. Mathis and M. Leger describe what appear to be three new species of this genus from the blood of the wild peacock, of *Ardetta sinensis* and of *Munia topela*.

* C.R. Soc. Biol. Paris, lxx. (1911) pp. 58-9.

† Tom. cit., pp. 34-6 (1 fig.).

‡ Philippine Journ. Sci., v. (1909) pp. 291-312 (3 pls. and 13 figs.).

§ Tom. cit., pp. 315-36 (4 pls.).

|| C.R. Soc. Biol. Paris, lxx. (1911) pp. 211-12.

Intestinal Flagellates of Marine Fishes.*—A. Alexeieff describes *Urophagus intestinalis* Moroff in *Motella*, and notes that it may require a new genus (*Trichomitus*). He reports *Trichomonas prokazeki* Alexeieff from *Box salpa*, *Trichomastix motella* sp. n. from *Motella tricirrata*, *Tetramitus mesnili* (Wenyon) from *Box salpa*, *Trypanoplasma intestinalis* Leger in *Box* (it also occurs in lumpsucker, conger, etc.).

Spirochæt from the Rabbit.†—C. Mathis and M. Leger describe from rabbits at Tonkin a species of Spirochæt which seems to be new, which they name *S. railletii*.

Parasites of Biliary Fever in Horses.‡—G. H. F. Nuttall and C. Strickland find that there are two parasites in the blood of horses suffering from "piroplasmosis," viz. *Nuttallia equi* (Laveran) and a true *Piroplasma* (*P. caballii* Nuttall).

Affinities of Spirochæts.§—C. Clifford Dobell gives an account of *Cristispira veneris* sp. n., and summarizes his view of the position of Spirochæts. They may be conveniently collected as a distinct group of Protists—Spirochætoidea—which seems to stand alone. They have no definite relations with Protozoa, Bacteria, or Cyanophyceæ. The group comprises three different sets of forms, which may be conveniently classified in three different genera, *Spirochæta*, *Treponema*, and *Cristispira*.

Spirochæts of the Mouth.||—P. Gerber calls attention to the abundant occurrence of various kinds of Spirochæts in the upper parts of the respiratory and alimentary tracts, such as the mouth itself. He deals with *S. buccalis*, *S. dentium*, *S. vincenti*, and other forms. The teeth, the tonsils, and the tongue are the chief localities for Spirochæts in the buccal region; they do not occur in other parts of the buccal mucus membrane unless these are in a pathological state.

Hæmatozoa of Australian Birds.¶—J. Burton Cleland and T. Harvey Johnston report five apparently new species of *Halteridium*, a new Trypanosome, and various larval forms of *Microfilaria*.

Coccidiosis in Sparrows and other Wild Birds.**—P. B. Hadley calls attention to the common occurrence of the coccidium of "black-head" (entero-hepatitis in the intestine of sparrows (*Passer domesticus*) in America. The parasites were also found in the field-sparrow (*Spizella pusilla*), white-throated sparrow (*Zonotrichia albicollis*), junco (*Junco hyemalis*), hermit thrush, and robin (*Merula migratoria*). Severe coccidiosis was observed in the quail (*Colinus virginianus*) and in the grouse (*Bonasa umbellus*). The appearance was like that seen in the coccidiosis of turkeys, fowls, pheasants, guinea-hens, ducks, geese, and pigeons. The sparrow seems partly to blame for the diffusion of the coccidiosis, which is now a severe menace to the poultry-raising industry in all parts of the United States.

* Arch. Zool. Exper., xlvi. (1910) Notes et Revue, No. 1 pp. i-xx (12 figs.).

† C.R. Soc. Biol. Paris, lxx. (1911) pp. 212-14.

‡ Centralbl. Bakt. Parasitenk., lvi. (1910) pp. 524-5.

§ Quart. Journ. Micr. Sci., lvi. (1911) pp. 507-41 (1 plate and 2 figs.).

|| Centralbl. Bakt. Parasitenk., lvi. (1910) pp. 508-21 (3 pls.).

¶ Trans. Proc. R. Soc. S. Australia, xxxiv. (1910) pp. 100-14 (2 pls.).

** Centralbl. Bakt. Parasitenk., lvi. (1910) pp. 522-3.

BOTANY.

GENERAL,

Including the Anatomy and Physiology of Seed Plants.

Cytology,

Including Cell-Contents.

Chromosome-reduction in *Oenothera*.* — R. R. Gates publishes a brief review of the work of B. M. Davis on *Oenothera grandiflora*. After reference to the importance of the latter work in confirming two fundamental points, viz. the absence of pairing of separate threads during synapsis, and the subsequent end-to-end pairing (telosynapsis), the reviewer points out the differences in the account of reduction in *O. grandiflora* and in *O. Lamarckiana*. The first difference, viz. the existence of prochromosomes, is regarded as insufficiently proved, but the description of the heterotypic chromosomes is regarded as showing a greater attraction of the individual chromosomes to pair than is found in *O. Lamarckiana*. This may possibly be connected with the mutation of the latter.

Chromosomes of *Oenothera* Mutants and Hybrids.†—R. R. Gates publishes a brief summary of his work dealing with the cytology of *Oenothera*. The experiments were begun in 1905, and up to the present time have yielded the following results: In *O. Lamarckiana* the number of chromosomes is fourteen, the reduced number being seven. When this species is crossed with *O. lutea* the number of chromosomes found is twenty, with ten as the reduced number, but a subsequent cross gave the same number as in *O. Lamarckiana*. In telophase the chromosomes of the heterotypic mitosis look like tetrads but appear to be really bivalent. In *O. rubrinervis* the chromosomes number fourteen and are of the usual size, although the pollen-mother-cells are large and have protoplasmic connexions. In *O. nanella* the chromosomes are also fourteen in number. In *O. biennis cruciata* (a mutant of *O. Lamarckiana*) in the synapsis of the pollen-mother-cells there is an additional body resembling a small nucleolus, but it persists after the latter has broken down. This is probably the same body as is seen at the side of the spindle in both *O. lutea* and *O. Lamarckiana*, also in hybrids between *O. lutea* and *O. Lamarckiana* and in *O. rubrinervis*. These bodies may be termed heterochromosomes provisionally, but their full history and origin are unknown. The writer hopes to publish further results before long.

* Bot. Gaz., xlix. (1910) pp. 65-6.

† Advance print from Proc. 7th Internat. Zool. Congress, Boston, 1907 (1910) pp. 1-4.

Structure and Development.

Vegetative.

Anatomy and Morphology of Roots of Conifers.*—W. Noelle publishes the results of his investigations upon the anatomy and morphology of the roots of the Coniferae. The present paper deals with the primary and secondary cortex and central cylinder of various species representing the important genera, while two sections are devoted to mycorrhiza and heterorhizy.

The chief results are embodied in a comprehensive table of classification in which the author divides the Coniferae into two main groups. In the first group bands of thickening are absent in the primary cortex and there is no hypodermis, but endotrichia (i.e. root-hairs formed from cells lying in the second and third row below the surface) may develop. In the secondary cortex suberized crystal-cells and sclerenchyma are found; layers of cork form the outer surface. Subdivision is based upon the character of the roots, position and formation of resin-canals, and upon the crystal-cells and tannin-sacs. This group includes all the Abietineae.

In the second group there are bands of thickening in all except the outermost layers of the primary cortex. Both root-hairs and resin-canals are absent. Subdivision is based upon the character of the thickened bands, the presence or absence of hypodermis and primary resin-canals, etc. This group includes the Araucariaceae, Taxodiaceae, and Cupressinaceae.

In conclusion, the author describes three kinds of roots (heterorhizia) and points out that mycorrhiza are found in connexion with the roots of all the Coniferae, but that only in the Abietineae are they typically ectotropic; in the Araucariaceae, Taxodiaceae and Cupressinaceae the mycelium is endotropic. The presence of an ectotropic mycelium appears to influence not only the structure of the cortex but also that of the central cylinder.

Origin and Development of Bulbs in the Genus Erythronium.—M. Blodgett draws the following conclusions from his study. The delayed development of the embryo is associated with a large store of endosperm, which is drawn upon by the germinating embryo during the season when vegetative activity is low; the young seedling is established in the soil early in the spring, the endosperm furnishing the needed materials for its development. With the exhaustion of the reserve material of the seed, the primary root is developed, and the cotyledon is elevated into the air and light; the cotyledon is the only leaf exposed to the light by the seedling. The stem apex, located in a narrow cavity in the base of the cotyledon, is carried forward by the elongation of the embryo, and after elevation of the cotyledon, is carried farther into the soil by the elongation of the walls of the cavity. The short period of vegetative activity, and the prompt descent of the stem apex in the dropper, would indicate adjustment to short growing seasons; the brevity of the active season is a feature of the life-cycle. The tendency on the

* Bot. Zeit. lxxviii. (1910) pp. 169-266 (50 figs.).

† Bot. Gaz., I. (1910) pp. 340-73 (3 pls. and figs. in text).

part of the seedling to bury the stem apex deeply is continued by the immature plants in the production of runners, which are more or less comparable to the dropper in structure.

The persistence of the original stem apex until the establishment of the flower axis allows for the repetition of an indefinite series of immature bulbs, formed from runners or in situ, but introducing no new structures during the whole period of immature development. With the formation of the flowering shoot, the vegetative structures become secondary in importance, and the renewal bulb is developed from an axillary, bred at the base of the shoot. The continuation of the individual is thereafter without vegetative multiplication normally, the increase being secured by the seeds.

In the development of means of vegetative multiplication elongation of the structure immediately about the stem apex (in seedlings the base of the cotyledon, in the western forms the base of the petiole) was followed by the elongation of the scales of axillary buds, thus forming additional descending axes, each of which developed an additional bulb from its terminal bud.

The general development in the genus would confirm the assumption that it is related to *Tulipa*, especially through *T. sylvestris*.

Reproductive.

Embryology in Euphorbiaceæ.*—J. Modilewski has made further investigations concerning the development of the embryo-sac in *Euphorbia procera* Bieb., in order to show its relationship with other species of *Euphorbia*. This investigator finds that during the early stages of seed-formation archesporial cells arise, which divide into suspensor cells and embryo-sac mother-cells. All the mother-cells give rise to four nuclei, but there is no subsequent cell-division. Only one of these mother-cells ripens into an embryo-sac containing sixteen nuclei; the remaining mother-cells degenerate.

In the other Euphorbiaceæ there is only a single archesporial cell; the embryo-sac mother-cell divides into four daughter-cells, from the lowest of which develops a typical embryo-sac containing eight nuclei.

Gnetales as Apetalous Angiosperms.†—As a result of anatomical research, O. Lignier and A. Tison come to the following conclusions as to the value of the flowers of Gnetales, and the systematic position of the family. The type of flower is similar in the three genera—*Welwitschia*, *Ephedra*, and *Gnetum*—and in both sexes, and consists of an axis rising from the axil of a bract, and bearing four verticils, of which two may represent the perianth. The third forms the andrœcium with terminal sori 1-, 2-, or 3-locular; and the fourth, a closed ovary, with style and stigma, containing an ovule reduced to the nucellus. The ovary is basilar, and seems to be a continuation of the floral axis, but is very probably foliar. The male flower of *W. mirabilis* is the only one in which the four verticils are represented; in other cases one at least is

* Ber. Deutsch. Bot. Gesell., xxviii. (1910) pp. 413-18 (1 pl.).

† Comptes Rendus, clii. (1911) pp. 201-3.

absent. Each of the four verticils is served by a well-marked wood and bast system.

The unisexuality of Gnetales arises from an original hermaphroditism by abortion, and, as Hooker remarks, the male flower (pseudo-hermaphrodite) of *H. mirabilis* is an evidence of this. The verticils show two divisions, except in the female flowers of *Ephedra*, which shows three. This suggests that there has been a change in the floral symmetry of the Gnetales.

The authors conclude that these flowers are Angiospermous, and in a state of retrogressive development. By reason of the many gymnospermic characteristics which they retain, they are primitive Angiosperms. They have nearly the same floral organization as is found in Amentales, and so would form a side group parallel with this family, and belonging to a lateral branch from the base of the Angiosperm trunk. Amentales may possibly have arisen from the base of this branch.

Physiology.

Nutrition and Growth.

Removal of Starch through the Petiole.*—N. T. Deleano has experimented with *Vitis vinifera* in order to discover the method of conduction in the petiole of the products of assimilation of the leaf. The author applied the iodine-test under very varied conditions. In some cases the leaves were left intact until the application of the test; in others they were placed in the dark with either the upper or lower surface resting upon water. Sometimes the petioles were immersed in water or portions of them cut away; they were also treated with chloroform-water or plasmolyzed. The results show that leaves left on the stem lose their starch most quickly; but this loss is retarded when the upper surface of the leaf, and still more when the lower surface is laid on the surface of water. When the petiole is split longitudinally, the starch disappears at the same rate from both halves of the leaf. If, however, a transverse cut is made in the petiole so as to pass through half of the vascular strands, the starch disappears more slowly in that half of the leaf in which these strands are cut. Starch is apparently removed from the leaf chiefly through the vascular tissues, but it is still uncertain whether the wood or the bast is the more important factor. In a scalded stem the starch was conducted more slowly than in an uninjured one. Petioles placed in saltpetre solution were unaffected in 44 hours when the solution was of 5 to 10 p.c. concentration. In 52 hours, with a concentration of 10 p.c., plasmolysis occurred, but the petioles died. Chloroform-water retards the passage of starch through the petiole.

The author is of the opinion that no definite conclusion can be formed as to the amount of conduction that takes place in the cortex.

Irrigability.

Effect of Longitudinal Compression upon the Production of Mechanical Tissue in Stems.†—L. H. Pennington reports that the woody

* Jahrb. wiss. Bot., xlix. (1911) pp. 129-86 (7 figs.).

† Bot. Gaz., l. (1910) pp. 257-84.

stems of *Robinia Pseudo-Acacia*, *Rhus glabra*, *Populus tremuloides*, and *Vicinus communis* show no increase in mechanical strength, or in the amount or kind of mechanical tissue under the influence of longitudinal compression. In the young herbaceous stems of *Helianthus annuus*, *Vicia Faba*, and *Phaseolus vulgaris*, the development of mechanical strength in the tissues is somewhat retarded by a longitudinal compression caused by comparatively heavy weights. Neither light nor heavy weights have any appreciable effect upon the growth and strength of herbaceous stems which have already formed a cylinder of mechanical or woody tissue. Continuous longitudinal compression causes no marked differences in size or form of any part of the stem which is subjected to the compression, excepting, of course, mechanical changes which might be caused by excessive compression.

Mechanism of Movement in Gramineæ.*—Z. Woycicki has investigated the movement-mechanism of the flowering branches of the Gramineæ. After reference to the swollen bases of the leaf-sheaths and the swelling of the lodicules, the author gives special attention to the masses of tissue found on one or both sides of the angle, made by the flowering branch and axis, through which movement takes place, and shows that these last structures must be regarded as differentiated portions of the stem for a special function. The epidermis of these cushions is sometimes thickly covered with hairs, and the epidermal cells differ in form and arrangement from those of the ordinary epidermis. The outer part of the cushions is composed either of thick or thin-walled parenchyma, with more or less numerous intercellular spaces, while the interior is of a collenchymatous character. Most frequently the sclerenchymatous ring of the stem is replaced in the neighbourhood of the cushion by a patch (often horse-shoe shaped) of sclerenchymatous and conducting tissue, upon which the movement-mechanism rests. In other cases the supporting structure is a wedge-shaped mass of sclerenchyma and collenchyma. The power of movement depends almost exclusively upon the turgidity of the cells of the cushion, which is due to the presence of nitrates or nitrites, although the swelling of the cell-walls frequently plays an important part. At the time of movement the cells of the cushions increase in size in the radio-horizontal direction. This movement can take place even after growth of the tissues has ceased owing to the turgor of the intracellular spaces, provided that the cell-walls have not lost their elasticity.

General.

Pollination Experiments with Anonas in South Florida.†—P. G. Wester draws attention to *A. squamosa* L. (sugar apple), *A. reticulata* L. (custard apple), and *A. Cherimolia* Mill. (cherimoya), and *A. glabra*, the last named being indigenous. The two first named species have fruited fairly well, but never abundantly. The failure of

* Bot. Centralbl., xxvi, 2 (1910) pp. 188-340 (151 figs.).

† Bull. Torrey Bot. Club, xxxvii, (1910) pp. 529-39 (figs. in text)

cherimoya to set fruit after several years of bloom led the author to investigate the matter. The construction and fragrance of the flowers of all three species shows that they are entomophilous, and the author finds that they are proterogynous. The petals are almost vertical until the shedding of the pollen, leaving a small opening for the entrance of insects. As the flowers develop a viscid fluid is secreted, covering the syncarpium and apparently most abundant about twenty-four hours before the pollen is shed. As the time approaches for the discharge of pollen, the petals spread outward and upward very rapidly; at the same time a strong fragrance is exhaled. The stigma can now be approached by large insects, and, were the flower synchronous, self-pollination might be effected. A small beetle, *Colastus truncatus*, has been found acting as pollinating agent in sugar apple and cherimoya flowers. Another small insect found in flowers of sugar apple was identified as probably belonging to the *Phararonothi*. A small thrips also frequents the flowers of these *Anonas*.

A series of pollination experiments was carried out on these three species. Pollen was applied to the stigmas of twenty-seven cherimoya flowers at the time of the discharge of the pollen in the flower; all these flowers dropped. Thirty-four flowers were pollinated twenty-four hours or more before the shedding of the pollen, and all set. Experiments with sugar apple and custard apple flowers gave similar results.

The flowers of the pond apple, which belong to a different section of this genus, have similar arrangements of androecium and gynoecium. The flowers open to admit small insects about twenty-four hours before the pollen is shed, exhaling a strong odour. Practically all the flowers shed their pollen before sunrise, and are probably pollinated by nocturnal insects, though the agent has not been detected.

Since these investigations began, the cherimoya has, without artificial pollination, set fruit sparingly in Florida, less than 20 ft. above sea level. In Hawaii it fruits only at an elevation of many hundred feet. This may be due to the presence there of certain insects not found at lower altitudes. The sterility of cherimoya in Florida has doubtless been due to the scarcity of blooms and to an insufficient number of insects to assist in pollination.

It has been proved that sugar apple hybridizes readily with cherimoya, custard apple, and pond apple; cherimoya has also been successfully crossed with pond apple; but so far, attempts to cross sour-sop, *A. muricata* L., with these species, have failed. The extraordinary productivity of a few individual trees suggests a change in regard to the pollination of the flowers of these trees, possibly due to synecy and self-pollination. Should this be confirmed, such trees would be of inestimable value in the creation of varieties independent of outside agencies for fructification.

COMES, O.—*Del Fagiuolo comune (Phaseolus vulgaris L.)*

[An account of the history, properties, and cultivated races and forms of the scarlet runner.]

Atti R. Istit. Incoraggiamento Napoli, 1909 (1910) pp. 73-183.

Cryptogams.

Pteridophyta.

(By A. GEPP, M.A., F.L.S.)

Evolution of the Filicinean Leaf-trace.* — E. W. Sinnott writes about the evolution of the filicinean leaf-trace, a question round which centre some of the most fundamental problems of plant morphology, such as those concerning the retention of primitive characters by the leaf, the inter-relations of the foliar vascular supply and that of the axis, and the general questions of stelar theory and the origin and differentiation of plant tissues. The conclusions reached by the author after the examination of much material are summed up as follows: 1. The base of the leaf-trace in living ferns presents three main types of structure: the primitively monarch, with one group of protoxylem; the primitively diarch, with two; and the primitively triarch, with three. 2. The first type is characteristic of the Osmundaceæ and the Ophioglossaceæ, where the base of the leaf-trace is a single monarch strand, which is often mesarch as well. It is more strikingly so in the fossil ancestors of the former family. This single strand becomes in the petiole a broad arch, which is continuous in the Osmundaceæ and broken up in the Ophioglossaceæ. The primitive condition of this type of trace is an elliptical concentric strand with one mesarch protoxylem. 3. The second type is characteristic of the Marattiaceæ. In all the members of this family, save *Angiopteris*, and in young plants of this genus, the base of the leaf-trace consists of two bundles, each of which has a single protoxylem. This is endarch in all except *Dunæa*, where it is often mesarch. A complicated arch of bundles in the petiole develops from these two early ones. The primitive condition of this type of trace is two circular concentric bundles, each with one mesarch protoxylem. 4. The third type is characteristic of all remaining ferns, and its primitive condition is a single, roughly triangular, concentric bundle, with its base towards the stem-axis, and with three mesarch protoxylems, one near each corner. In the Schizeaceæ, Gleicheniaceæ, and primitive Matonineæ among the Simplicies, the strand is single throughout, and at its base is always triarch and often mesarch. *Lygodium* alone among the Filicales shows a petiolar structure which is neither endarch nor arched, and which is doubtless very primitive. In the simpler Gradateæ, the trace becomes broadened into a tetrarch, flat-topped arch, which becomes separated into many strands in the Dicksonieæ and Cyatheaceæ. The Hymenophyllaceæ form a reduction series from the Simplicies. In the lower Mixtæ, the undivided tetrarch trace persists, but in the bulk of the smaller and simpler forms it becomes divided into two equal diarch bundles. The complicated petiolar system of the higher Polypodiaceæ is always referable to this simpler type. 5. The monarch trace may be considered as the persistence of a very primitive condition. The diarch type has perhaps been derived from the constriction and separation into two of such a primitive diarch bundle as that of Clepsy-

* Annals of Botany, xxv. (1911) pp. 167-191 (1 pl. and figs.).

dropsis among the Zygopterideae, while the triarch condition may have arisen by the amplification of a similar bundle into a tetrarch strand, a slight reduction of this, and the fusion of the two median protoxylem groups. 6. The constant endarch and concentric structure of the leaf-bundle, as opposed to the varying conditions in the stele, point to the former as a conservative organ. 7. The petiole at its attachment is in many cases very slender, and the base of the leaf-trace presents always its smallest and most compact condition. Structures are often retained here which are undoubtedly very primitive. The petiole is largest at the point where it first becomes free, probably for mechanical reasons, and the bundle here is in its most complex form. 8. Since the transpiration current seems to be accommodated equally by the slender trace and by the large petiolar bundle of the same leaf, it is improbable that it has had much influence in producing the complications of the foliar vascular system. The stele and the leaf-trace have developed almost independently, and the latter has had little influence in moulding the former. 9. The condition found in the base of the trace in any fern was probably once present throughout the whole leaf-bundle. 10. The simple condition in the upper part of the leaf may possibly be regarded as primitive. 11. The histological influence of the stele is sometimes carried up into the base of the petiole, especially in cases of reduction, where the petiolar bundle, better than the lower part of the leaf-trace, retains conditions which may be regarded as primitive. 12. In the Filicales, as in all other vascular plants, the leaf-trace is the seat of ancestral characters.

Anatomy of *Marattia*.*—G. M. Charles describes the anatomy of the sporangium of *Marattia alata*. In brief her work is summarized as follows: 1. The transition from protostele to solenostele is sudden, without any definite medullated monostelic stage. 2. The medullary system of *Marattia* differs from that of solenostelic ferns in origin, course of bundles, and development into a cylinder. It resembles that of *Psaronius* in its relation to leaf-traces. 3. Elongation of the stem causes the union of the bundles into broad bands, and a reduction of the medullary system. This emphasizes the close relation between the compact habit and crowded leaves of *Marattia*, and the number of concentric cycles and leaf-gaps in the dictyostele. 4. The occurrence and position of protoxylem varies. It may be inconspicuous or may consist of spiral or modified reticulate tracheids. It may be in an exarch or mesarch position in the cotyledonary node, mesarch in the protostele above the cotyledonary node, and usually endarch in the strands of the older parts of the stem. Similar variations occur in the leaf traces. 5. Apical meristems vary from a triangular apical cell in young sporangia to meristematic groups in older stems and roots. Such variation during the course of development occurs in the gametophytes of Pteridophytes and in some liverworts, but is not recorded for the sporophyte of other ferns. 6. The cotyledonary trace is collateral during most of its course. Later leaf-traces start collateral and develop adaxial sieve-tubes in their course through the cortex. 7. Secondary roots originate from vascular tissue

* Bot. Gaz., li. (1911) pp. 81-101 (4 pls. and figs.).

before differentiation into regions has begun. The cortex shares in forming the cortex of the root. 8. Mucilage ducts originate both schizogenously and lysigenously, generally the former.

Marattia is characterized by a marked instability. Such an instability is found in the root structure of Ophioglossaceæ, the protoxylem position of Dicksonia, and in the variable apical meristem of fern gametophytes. Combined with this instability in *Marattia* is the indefiniteness of the medullated monostelic stage. The Marattiaceæ have retained many characters of the stock from which branched off the Ophioglossaceæ, then the Psaroniaceæ and Cyatheaceæ.

Mechanism by which Fern Fronds roll up.*—W. Schmidt discusses the question of the means by which certain ferns roll up their fronds: whether it be a hygroscopic phenomenon, due to changes in the hygroscopic condition of the cell-wall, or whether it be a cohesion phenomenon, due to changes in the quantity of the cell-sap. The cohesion theory was invented by Kamerling, and the name refers to the strong cohesion of the primordial utricle to the cell-wall. As the cell-sap is reduced by evaporation, the cell-wall is dragged in owing to atmospheric pressure and does not separate from the contracted primordial utricle. The author adopts the second theory, and summarizes his conclusions as follows:—
1. The rolling up of the desiccated fronds of *Ceterach officinarum*, *Polypodium vulgare*, *Asplenium Trichomanes* and *A. ruta-muraria* is due to cohesion and not to hygroscopic mechanism. 2. Steinbrinck's methods were very successful in proving the existence of cohesion-mechanism. 3. Very satisfactory results were obtained by a new method which permitted the making of observations not only on sections but also on intact fronds by such dehydrating agents as strong glycerin, etc. 4. The influence of turgor on curling fronds must not be overlooked. 5. The curling movement of the fronds is in keeping with the anatomical structure.

Pteropsida.†—E. C. Jeffrey replies to criticisms which have been levelled at the great group of vascular plants defined as Pteropsida, and gives the following summary of his views. 1. The Pteropsida represent a great natural phylum of vascular plants characterized by dorsisporangiate sporophylls and by palingenetically large leaves, as inferred from their anatomical relations. 2. The pith of the Vasculares, in all cases where definite evidence is available, is an inclusion of the fundamental tissue of the cortex on the part of the stele. 3. The concentric type of tubular central cylinder is more ancient than the collateral and antedates the latter, as is shown by the persistence of the concentric condition in many leaf-traces, where it has become obsolete in the stem. 4. So far as the primary bundle system of the Vasculares is concerned they present a reduction series, in which the ferns and lower Gymnosperms (Archigymnospermæ) represent the earlier and more complex stages, and the higher Gymnosperms (Metagymnospermæ) and dicotyledons the phases which are more recent and more simplified.

* Beih. Bot. Centralbl., xxvi., Abt. 1 (1910) pp. 476-508.

† Bot. Gaz., 1. (1910) pp. 401-14 (1 pl.).

Fossil Osmundaceæ.*—R. Kidston and D. T. Gwynne-Vaughan publish the fourth and final instalment of their studies of the fossil Osmundaceæ. They describe the anatomy of the stem of the new species, *Osmundites Kolbei*, from the Wealden in Cape Colony. In summarizing their studies they present a table of all the Osmundaceæ investigated by them, showing that the protostelic representatives are of more ancient origin than those with a developed pith. Their hypothesis, that the pith of the Osmundaceæ is of stelar origin is, inter alia, criticised by E. C. Jeffrey.†

Chemotaxis of Fern-spermatozoids.‡—K. Shibata gives an account of his researches on the chemotaxis of the spermatozoids of Pteridophytes. His experiments are set forth in innumerable tables. There are at least three categories of chemotactic sensibilities: 1. That for the anions of malic acid and allied chemotactically active dicarbonic acids. 2. That for OH-ions (only found in *Isoetes*). 3. That for the kations (metallic- and H-ions) and alkaloids.

Mutations of *Asplenium ruta-muraria*.§ F. von Tavel writes of the mutations of *Asplenium ruta-muraria*. H. Christ, in 1903,|| classified them in four sections and seventeen varieties, according to the form of the ultimate leaf-segments. Von Tavel discusses the causes of this variability, namely, ecological conditions, such as light, shade, etc.; regular heterophyly on one and the same plant, perhaps due to seasonal changes; sports, where one or more leaves of a plant-rosette are quite of an aberrant type. Local forms are apt to be constant; for instance, the form prevalent on the Lake of Geneva is quite different from that of the Lake of Lucerne. There is usually a predominant form in a given locality, accompanied by variants.

North American Ferns.¶—W. N. Clute describes *Polypodium prolongilobum* and *P. vulgare* var. *perpusillum*, two novelties gathered by J. H. Ferriss on Mount Lemmon in the Santa Catalina range, Arizona.

He discusses** *Asplenium Glenniei*, one of the rarest ferns in the United States, and recorded only from the Huachuca Mountains of Arizona, but it is not uncommon in Mexico.

He cites †† J. H. Ferriss's record of *Nephrodium mexicanum*, and considers the question whether the plant is not better kept distinct from *N. patulum*.

He gives an account ‡‡ of *Oncoclea sensibilis* f. *obtusilata*, and some other rare forms.

He also describes §§ a difficult excursion through a dense mountain-forest in Jamaica in search of the rare *Loucheitis aurita*.

Ö E. Jennings ||| publishes some notes on the distribution of certain plants in Western Pennsylvania, treating especially of *Woodwardia virginica*.

* Trans. Roy. Soc. Edinburgh, xlvi. (1910) pp. 455-77 (4 pls.).

† Bot. Gaz., l. (1910) pp. 476-7.

‡ Pringsheim's Jahrb. wiss. Bot., xlix. (1911) pp. 1-60.

§ Verh. Schweiz. Naturf. Ges. 93 Jahresversam. (1911) pp. 260-2.

|| Hedwigia, xlii. (1903) pp. 153-77 (4 pls.).

¶ Fern Bull., xviii. (1911) pp. 97-8 (1 pl.). ** Tom. cit., pp. 101-4 (figs.).

†† Tom. cit., pp. 104-5. ‡‡ Tom. cit., pp. 106-11 (figs.).

§§ Tom. cit., pp. 111-15.

||| Tom. cit., pp. 99-101.

E. S. Reynolds* publishes notes on species of *Botrychium* from Tennessee, and includes a description of a peculiar teratological specimen of *B. obliquum*, a species which is rare in Tennessee. *B. virginianum* is more common.

Bryophyta.

(BY A. GEPP.)

Inter-relationships of the Bryophyta.†—F. Cavers continues his studies of the inter-relationships of the Bryophyta. Chapter VI. treats of the morphology, anatomy, reproduction, and development of the Sphagnales, and is followed by a list of sixty-two papers which bear upon the subject. Chapter VII. gives a similar, but briefer, account of the Andreaeales. In Chapter VIII. the Bryales are contrasted with the Sphagnales and the Andreaeales on their sporophyte characters; and the classification of the Bryales is discussed from the point of view of the development of the peristome. There are four sharply-marked types of peristome, which permit the Bryales to be separated into the four following independent groups: Tetrarhizales, Polytrichales, Buxbaumiales, Eu-Bryales. The latter group is divided into Haplolepidaceae, Heterolepidaceae, and Diplolepidaceae; and these again are sub-divided into cohorts. In Chapter IX. are discussed the inter-relationships of the higher Bryophyta enumerated above; and the author's views as to their phylogeny are expressed diagrammatically in a pedigree table. Also an ingenious argument is developed that there probably is a definite correlation between the form of the archesporium and the sterile apical portion of the sporogonium. Where the archesporium is dome-shaped, the sterile apical tissue is practically cut off from the stream of food-material passing up through the seta and columella, the nutritive material becoming almost entirely used up by the developing spores. In the higher mosses the archesporium is almost cylindrical, and is open above and below, allowing ready passage of nutritive material to the apex of the capsule, and permitting of considerable growth in that region; thus arise annulus, operculum, and peristome. Chapter X. contains a classification of the Bryophyta in ten orders, with their families. It contains also a discussion of the old-established primary division of the Bryophyta into two classes, Hepaticae and Musci, and of the question whether the Anthocerotales ought not to be excluded from the Hepaticae, and the Sphagnales to be excluded from the Musci.

In Chapter XI. the author points out that he has assumed, as a working hypothesis, that the Bryophyta in the outlined scheme of classification form an ascending series, in which the sporogonium represents an interpolated generation arising from the segmented oospore, and is characterized by a gradually increasing sterilization of potentially sporogenous tissue. In *Riccia* is found the most primitive stage, the sterilization being confined to the formation of a unilamellate capsular wall. Further, he discusses‡ Goebel's view as to the Marchantiales constituting a descending series of reduction forms, and finds it but partially accept-

* Rhodora, xiii. (1911) pp. 14-15.

† New Phytologist, x. (1911) pp. 1-46.

‡ Tom. cit., pp. 84-6.

able. If the theory of the ascending development of the Bryophyta is accepted, with *Riccia* presenting the most primitive form of sporogonium, the conclusion is natural that the Bryophyte sporogonium had an anti-thetic origin, and has never been anything but a sporogonium. As to the vascular plants, and the suggestion that the starting-point of the Pteridophyta may be sought in the sporogonium of *Anthoceros*, there are very great difficulties in the way of an explanation of how roots and leaves originated. It is much easier to infer that the Bryophyta and Pteridophyta had a collateral origin.

Desiccation-phenomena in Mosses.*—C. Steinbrinck discusses the cause of the crumpling of certain axile organs as a result of the loss of water, principally in the case of the mosses *Leptodon Smithii*, *Leucodon sciuroides*, and *Orthotrichum Lyellii*. As on previous occasions, he finds himself in strong opposition to W. Lorch.

Illustrations of Exotic Mosses.†—G. Roth publishes the fourth and concluding part of his *Die aussereuropäischen Laubmoose*, Band I. It contains descriptions of 52 species of *Trematodon*, and 7 of *Wilsoniella*, together with figures of each species, analytical keys, and the indexes, title-pages, etc., to the volume.

European Hepaticæ.‡—K. Müller publishes a further instalment of his monograph of the European hepaticæ in Rabenhorst's *Kryptogamenflora*. He finishes the genus *Plagiochila*, the seven species of which are all found in our islands; and treats of *Pedinophyllum* (2 species), *Leptoscyphus* (4), *Lophocolea* (5), *Chiloscyphus* (4), and begins *Harpanthus*.

British Bryophyta.§—B. Kaalaas publishes a description of *Cephalozia macrantha* Kaal. et Nicholson, a new species found in a Sussex *Sphagnum*-bog by W. E. Nicholson, in June 1908. It differs from *Cephalozia media* Lindb. in size, in the more frequent presence of underleaves, in the much larger leaf-cells, and especially in the large perianth.

H. N. Dixon || gives an account of *Tortula canescens* Mont., which was first recorded for this country by Griffiths in 1869. It was refound last year in its original locality, Meadfoot Cliffs, Torquay, by Larter. In February of this year C. E. Larter sent young specimens of it to H. N. Dixon: these were remarkable as often having the calyptra rough, as in *Pottia*. Dixon explains the structure of the leaf-nerve as seen in transverse section.

Moss-remains in Scottish Peat.¶—F. J. Lewis, in an appendix to Part IV. of his report on the plant-remains in the Scottish peat mosses, gives an account of the moss-fragments determined by H. N. Dixon, some eighteen or twenty species. They were collected partly in West Shetland, partly in Havnafjord, near Reykjavik, in Iceland.

* Ber. Deutsch. Bot. Gesell., xxviii. (1911) pp. 549-62 (figs.).

† Dresden: Heinrich (1911) i. lief. 4, pp. 273-331 (pls. 25-33).

‡ Die Lebermoose. Leipzig: Kummer, 1911, lief. 13, pp. 769-832 (figs. 341-357).

§ Journ. of Bot., xlix. (1911) pp. 105-6 (1 pl.).

¶ Tom. cit., pp. 127-8.

|| Trans. R. Soc. Edinburgh, xlvii. (1911) pp. 793-833 (5 pls.).

Moss-flora of the Haute-Saône.*—A. Coppey publishes a further instalment of his phytogeographic studies on the mosses of the Haute-Saône, and gives records of forty-four species of Tortulaceæ and Pottiaceæ.

Sphagnaceæ of the Rhöngebirge.†—J. Röhl writes on the Sphagnaceæ of the Rhöngebirge, and gives a list of seventeen species and several varieties, many of them being new records for the district.

Mosses of the Crimea.‡—A. A. Sapelin gives an account of the ecology and plant-geography of the Mosses of the Crimea mountains. He first discusses such external conditions as temperature, moisture, light, substratum, wind, etc., in relation to various species; and then he treats of moss-associations in three classes, namely xerophytes, hygrophytes, and hydrophytes, subdivided according to the nature of the soil and forest.

Mosses of Ceylon.§—T. Herzog gives an ecological account of the moss-flora of Ceylon, and endeavours to describe the way in which the species fit into the landscape. The plains are almost bare of mosses, but in the lower hills there is some richness of species, especially Calymperaceæ and Leucobryaceæ, endemic or of Malayan affinity. In the upper hills there is a wonderful display of mosses, conspicuous by their colours and abundant in their variety; many of these also are endemic. His enumeration contains 200 species, 15 of which are new.

Moss-flora of the Atlantic Islands.||—A. Geheeb at his death left an unfinished account of the moss-flora of the Atlantic Islands, which has been completed by T. Herzog and published in Luerssen's *Bibliotheca Botanica*. It is divided into three parts:—1. Lists of species (with localities) of mosses of the Azores (108), Madeira (176), Canaries (212), Cape de Verd (20), Ascension (20), St. Helena (32), Tristan d'Acunha (36). 2. Descriptions of 35 new and critical species, 6 of them being created by Geheeb. 3. An account of the geographical conditions of the various islands, with lists of their endemic species. The total enumeration amounts to 476 species and 7 varieties. The 19 coloured plates are reproductions of water-colour drawings by Frau Geheeb.

Teneriffe Mosses.¶—H. N. Dixon gives an account of a collection of mosses gathered by J. H. Salter in Teneriffe, mostly in the very dry neighbourhood of Guimarães on the southern side of the island, between December 1908 and February 1910. About 53 species and varieties are recorded; 8 of these are additions to the flora of the Canaries, 3 of them being new to science. Critical notes are added to several of the species.

Moss-flora of Tunis.**—J. Pitard and L. Corbière give a list of additions to the moss-flora of Tunis. Previous records are to be found

* *Rev. Bryolog.*, xxxviii. (1911) pp. 45-8.

† *Allgem. Bot. Zeitschr.*, xvii. (1911) pp. 18-21.

‡ *Engl. Bot. Jahrb.*, xlv. (1911) pp. 62-83.

§ *Hedwigia*, l. (1910) pp. 115-45.

|| *Bibliotheca botanica*, Heft 73, Stuttgart, 1910, 74 pp. (20 pls.). See also *Hedwigia*, l. (1910) Beibl., pp. 157-8.

¶ *Journ. of Bot.*, xlix. (1911) pp. 1-8 (1 pl.).

** *Bull. Soc. Bot. de France*, lvi. Session extraord. 1910, pp. lv-lviii.

in papers published by Bescherelle, Corbière, Thériot, Camus, and amount to ninety-nine mosses and six hepatics. The additions bring the totals up 137 mosses and forty-four hepatics. The new specimens were gathered mostly in the neighbourhood of Aïn-Draham (Khourmirie). One species is new.

In a subsequent paper* they give a complete enumeration of the moss-flora, indicating the distribution, attitudes, moss-associations, etc.; and they raise the totals to 152 mosses and forty-eight hepatics.

Hepaticæ of New Caledonia.†—E. G. Paris publishes a list of 250 hepaticæ collected in New Caledonia by Le Rat, and determined by F. Stephani. Some 100 of these are new, but their descriptions are not likely to be published before the appearance of the Supplement of Stephani's Species Hepaticarum.

Polytrichaceæ of North America.‡—T. C. Frye publishes an illustrated account of the Polytrichaceæ of western North America. Starting with a synoptical key of the world's genera of Polytrichaceæ, he adds a key to the genera native to western North America, and then proceeds to give a systematic treatment of each genus, supplying descriptions and figures of the species. The genera concerned are *Catharinea*, *Oligotrichum*, *Psilopilum*, *Bartramioopsis*, *Polytrichadelphus*, *Pogonatum*, *Polytrichum*.

Mexican Mosses.§—J. Cardot publishes the eighth instalment of his preliminary diagnoses of Mexican mosses, in which are described a new genus, *Anomobryopsis*, fourteen new species, and a new variety. Critical notes are appended. The specimens were collected by Pringle, Purpus, Barnes and Land, and others.

In his ninth instalment|| he treats of thirty-four species and varieties.

Splachnobryum in Greenhouses.¶—E. G. Britton gives an account of a *Splachnobryum* found in greenhouses near Philadelphia. She states it to be identical with *S. delicatulum* Broth. described by H. N. Dixon in 1907, and found in a Yorkshire hot-house. Both plants have the preperistome described by Dixon. A similar preperistome or binding membrane is shown by Fleischer to be present in *S. Geheebii*; and E. G. Britton finds it also in *S. Wrightii*, *S. Mariei*, *S. Wullschægelii* and *S. Bernouillii*; and traces of it in *S. flaccidum* and *S. Boivini*.

Fissidens tequendamensis Mitten.**—H. N. Dixon supplements some remarks which he published about *Fissidens tequendamensis* †† recently when describing the new Irish species, *F. ersul*. At his request E. G. Britton examined the type of *F. tequendamensis* in Mitten's herbarium and found it to be identical with *F. Lindigii* Hampe, both plants having come from the same type-locality, the Falls of Tequen-

* Bull. Soc. Bot. de France, lvi. Session extraord. 1910, pp. cexv-cexlii.

† Rev. Bryolog., xxxvii. (1910) pp. 128-32.

‡ Proc. Washington Acad. Sci., xii. (1910) pp. 271-328 (30 figs.).

§ Rev. Bryolog., xxxviii. (1911) pp. 1-9.

|| Tom. cit., pp. 33-43.

¶ Bryologist, xiii. (1910) pp. 116-119 (pl.).

** Journ. of Bot., xlvi. (1910) pp. 280-1.

†† Tom. cit. p. 147.

dama in New Granada. Both plants have the same cristate internal lamellæ at the base of the peristome teeth. Such variations of structure as occur are of less than varietal importance. Haube's name antedates Mitten's by seven years. Included in the synonymy is *Schistophyllum Orrii*, a Dublin alien described by S. O. Lindberg twenty years ago.

Adalbert Geheeb.* T. Herzog writes some reminiscences of the bryologist A. Geheeb (b. 1842; d. 1909), for many years a chemist at Geisa. He made innumerable visits to the Rhöngebirge, and devoted much time to the investigation of its moss-flora. He also made his mark as an authority on exotic mosses, working out Puiggari's Brazilian collection, as well as collections of Australian and Papuan mosses belonging to Melbourne herbarium. One of his best known publications is his *Neue Beiträge zur Mossflora von Neu-Guinea* (1889 and 1898), illustrated with fine plates. His *Bryologia Atlantica*, begun in 1891, has recently been completed and published by T. Herzog.

Nils Conrad Kindberg.†—This bryologist is the subject of a brief obituary notice. He died in August 1910, at Upsala, being 78 years of age. By profession a lecturer at Linköping, he devoted the last thirty years of his life to North American bryology. His moss-herbarium, containing 4000 species, is offered for sale.

Thallophyta.

Algæ.

(By MRS. E. S. GEPP.)

Locomotion in *Surirella*.‡—T. C. Palmer writes an able account of the apparatus of locomotion in *Surirella*, founded on his own careful observations. He criticizes the views and arguments of Lauterborn, and goes minutely into the differences between that author's results and his own. Palmer's material was taken from a pool of pure water, on the bottom of which are patches of diatoms, including *Navicula iridis* Ehr., *N. dactylus*, *N. socialis*, and *Surirella elegans*. A layer of these diatoms kept in good condition for weeks at a time in a bottle, and was available for study. A number of significant observations were made on all the species, but the apparently conclusive facts have to do with *Surirella*. The results are summed up by the author as follows:—1. Bütschli granules, or bodies of the same deportment in life, circulate into the keel and run along its base. 2. Staining the living diatom with Bismarck brown and tannic acid fails to indicate coleoderm within the keel, though revealing it in the same preparation upon *Eunotia* and *Pinnularia*. 3. After rapid killing and fixing, both eosin and iron-alum-hæmatoxylin show the keel-canal more or less full of a substance continuous with the protoplasm of the rib-canal, and staining like it, and showing the same granular constitution. The author considers it demonstrated, therefore, that the protoplasm of *Surirella* extends through the ribs into the keels, wherein it runs from end to end of the diatom and occupies most of the

* Verh. Bot. Ver. Prov. Brandenburg, 51 Jahrg. (1910) pp. (150)–(152).

† Bryologist, xiv. (1910) p. 13.

‡ Proc. Delaware County Inst. Sci., v. (1910) pp. 11 (figs.).

tube-like canals. Altogether it is, he says, quite evident that this hyaline protoplasm, and not any hypothetical "gallerte," flows back and forth in these keels, and operating upon the surroundings through the minute clefts propels the diatom, rolls it over, and stands it upon its end. This is a kind of apparatus for diatom locomotion easily understood; and besides being in comfortable agreement with the nature and peculiarities of the phenomena to be explained, it has the not inconsiderable advantage of being demonstrable.

Behaviour of *Chlorella* in White and Coloured Lights.*—P. A. Dangeard publishes a note on the photographic properties of *Chlorella vulgaris*. A culture of this alga, in a cylindrical glass jar containing Knop's liquid, developed itself on the sides of the jar in fine parallel lines, recalling Fraunhofer's lines in the spectrum. Upon investigation it appeared that these lines corresponded with the shadows of the window-bars of the laboratory focused on the sides of the jar. The *Chlorella* preferred a situation not strongly illuminated. This sensitiveness of *Chlorella* may serve usefully in laboratory experiments.

In a subsequent paper † Dangeard describes further experiments, and shows that it is not the case that *Chlorella* moves into the position best suited for it, but that being distributed equally over all the wall-surface of the jar it develops most abundantly at those spots where the illumination is best suited to it. By the use of monochromatic screens and of three-coloured screens as used in photography, he found *Chlorella* to develop best in red and orange light, feebly in violet, and not at all in green. If a quick result is required, the number of oxygen bubbles evolved in the different zones of coloured light in a given time may be compared. One interesting experiment was the placing of a *Chlorella* culture behind three three-colour screens and a large screen of thick black paper; strangely enough, in bright sunshine the evolution of oxygen-bubbles took place almost as freely under the black screen as under the three-colour screens. Some non-luminous rays presumably passed through the black screen.

Study of Diatoms in Sedimentary Deposits.‡—A. Lanby, in describing a new technical method for a paleophytologic study of ancient sedimentary deposits, has plenty to say about the Diatomaceæ and the important evidence which they yield. They have, however, in the past led careless workers into error. The employment of impure water in washing the material has made some modern diatoms appear to have been in existence in the Coal-period. Again, a modern deposit may have been derived by denudation from an older deposit, and the same diatoms naturally appear in both. The author gives practical instructions as to how the study should be pursued, what methods adopted, what precautions observed.

Classification of Algæ.§—J. Comère writes a short essay on the classification of algæ. He begins by a résumé of the various treatments,

* Bull. Soc. Bot. de France, lvi. (1909) pp. 368-70 (1 pl.).

† Tom. cit., 503-8.

‡ Bull. Soc. Bot. France, lvi. Mém. 15 (1910) 110 pp.

§ Mem. Acad. Sci. Toulouse, ser. 10, ix. (1909) pp. 219-26.

from Duchartre, in 1877, up to the great work of Oltmanns, in 1904. He is of opinion that too much stress has been laid by some botanists on the coloration of algae, and points out instances where this has led to the absurdity of placing certain genera sometimes among the Rhodophyceæ and sometimes in Cyanophyceæ. He shows the greater value in classification of such characters as are furnished by structure or general methods of reproduction for the division into large systematic groups; and for the secondary groups the peculiarities offered by the different modes of multiplication, the reproductive organs, or, if necessary, certain details of the thallus in connexion with the biological conditions of their existence. The Characeæ are of course definitely excluded from the algae, and their connexion with the Coleochaetaceæ, asserted by some authors, is declared to be illusory. The author groups the algae as follows:—1. Florideæ. 2. Fucaeæ. 3. Confervæ, including Edogoniales, Chaetophorales, Chroolepoidales, Ulvales, Schizogoniales, Cladophorales, and Protococcoideæ. 4. Siphoneæ, divided into Bryopsidæ, Codicæ, and Vaucherieæ. 5. Conjugatæ, including Zygnemææ, Desmidiææ, and Bacillariææ. 6. Myxophyceæ. All these groups are of equal value.

Epiphytes of the Laminariæ.*—F. Tobler publishes studies on the morphology and biology of the Laminariæ. He finds that the epiphyte-flora is formed of small annuals, and that the number of these on plants of *Laminaria* is a considerable factor in the enumeration of local species. They disregard the ordinary zonal limits and other external conditions, being dependent only on the main requirement of a suitable host, which allows of points to which they can attach themselves. Wounds in the host-plant provide suitable points for the starting of the epiphyte. Some of these may be regarded as semi-parasites and even entire parasites.

Algological Notes.†—G. S. West begins a series of notes on fresh-water algae, which will include critical remarks upon little-known species, discussions upon the validity of certain species, and the systematic position of others, as well as short reports on small collections from various parts of the world. The first of these notes contains a list of thirty-three species of algae collected from running water near Rivadeo, in north-west Spain, by W. Fawcett in 1909. Most of the species were diatoms. In the second note the author describes a diatomaceous earth from Lewis, Outer Hebrides. It is fairly pure and of fresh-water origin, consisting of a number of species, two of which stand out conspicuously from the rest, viz. *Surirella robusta* Ehr. and *Navicula nobilis* Ehr. var. *Dactylus* V. Heurck. A list of the species is given. The third note contains remarks on twelve new or rare British algae, among which is a new species, *Aulicostodesmus spirotaenia*. In the fourth note the author discusses the genera *Diplochæte* Collins and *Polychætophora* W. and G. S. West. He gives his reasons for separating his own species, *P. simplex*, from that genus, and making it the type of a new genus, *Oligochætophora*. The differences between the genera are pointed out.

* Bot. Jahrb. f. System, Pflanzengesch. u. Pflanzengeogr., xliv. (1909) pp. 51-90. See also Centralbl. Bakt. Parasitenk. u. Infekt., 2^{te} Abt. xxix. (1911) p. 147.

† Journ. Bot., xlix. (1911) pp. 82-9 (figs. in text).

Vegetable Protistology.*—J. Pavillard gives a careful review of the discoveries made in the field of protistology, and discusses work done on Cyanophyceæ, Phylomonadinae, Dinoflagellata, and Bacillariales, by numerous authors.

Black Sea Algæ.†—A. Henckel briefly describes the anatomical structure of *Cystoseira barbata*, which undergoes considerable modification when growing in the concentrated waters of the Gulf of Karkenit, in the Black Sea. It loses its rigidity, becomes more cartilaginous, the intercellular spaces become larger, and the parenchyma more lax. On the other hand, the cavity (Hohlraum) is less differentiated. The colour of such plants is light yellow to light brown; and they might easily be mistaken for a totally different species, were it not for the complete series of intermediate forms. The author finds between the typical assimilating tissue and the inner mechanical tissue a transitional layer like that which is demonstrated in *Chordaria flajelliformis*, having the same characteristic pores and many Fucosan-grains. These latter stain deep black with osmic acid, and are usually congregated round the nucleus. These fat-bodies have clearly been misunderstood by some authors. Another peculiarity of the strongly saline waters of the Gulf of Karkenit is the abundance of *Chara tomentosa*.

Stichococcus bacillaris.‡—S. M. Wislouch describes his experiments in the cultivation of *S. bacillaris* under different conditions. He submitted plants grown on four different nutritive media to the action of intense cold, the temperature in one experiment sinking to -75°C . The following conclusions were arrived at: 1. The resisting power of *S. bacillaris* towards cold depends on the age of the culture, very young cultures, 5–8 days old, showed much less resistance than those which were 34–148 days old. The reason for this is said to arise from the number of cells which are in the act of dividing or are still young, and are therefore very sensitive to cold. 2. Winter cultures, which had been raised during the dark months, showed far more power of resistance than spring cultures, which had been grown in the lighter months, since in the latter the number of dividing and of young cells was larger, and the cultures were therefore more sensitive. 3. On the assumption that cells grown on the usual Beijerinck's agar may be regarded as normal, the author comes to the conclusion that the further a cell diverges from the normal type the more easily is it destroyed by cold. 4. Cells of the same age and belonging to the same culture are not equally resistant to cold: a few cells can resist a temperature of -75°C ., while about 50 p.c. of the cells are destroyed by a temperature of -24°C .

Effect of Coloured Light on Stichococcus bacillaris.§—G. A. Nadson cultivated this alga in $1\frac{1}{2}$ p.c. agar in Beijerinck's nutritive solution, in a red-yellow light passing through a solution of potassium bichromate, and in a blue light passing through cupric-ammonium

* *Progressus Rei Botanicae*, iii. (1910) pp. 474–544.

† *Förhandl. Nordisk. Naturf. och Lakaremöt. Helsingfors* (1903) Sect. vii. Bot., pp. 6–7.

‡ *Bull. Jard. Imp. Bot. St. Pétersbourg*, x. (1910) pp. 166–80.

§ *Bull. Jard. Imp. Bot. St. Pétersbourg*, x. (1910) pp. 137–50.

hydrate solution. As controls he employed cultures in white light. In the dark they did not develop. The results of the experiments are described in detail. The cultures in the red-yellow light showed most unfavourable development and organization: the cells lose their form and the chromatophores become disorganized and drop to pieces. In blue light the cultures are at first considerably behind those grown in white light in strength of development and mass of production. But the older cultures (3 to 6 months) are but little behind the control cultures. Qualitatively, as regards the morphology of the cell, its form, structure, the colour of the chromatophore, the cultures in blue and in white light show a great similarity to one another, and differ entirely from those grown in red-yellow light. Continued culture in a blue light shows a progressive improvement in the succeeding generations, while the succeeding generations in red-yellow light show progressive degeneration.

Phytoplankton of the Zeller See.*—K. von Keissler reports on the phytoplankton of the Zeller See in Salzburg, collected from June to August 1909. After an introduction dealing with the shore-vegetation he gives a list of the species observed in the plankton, which he designates as of a general type. The phytoplankton plays a much greater part than the zooplankton, and increases continuously during the months named in the number of individuals, while the zooplankton decreases. The former contained twenty-two species. In August the number of species became greatly reduced. Details of the composition are given. Comparison with the results of Brehm and Zederbauer show that the composition of the plankton of different years at the same time is not the same. The amount of the plankton in the Zeller See seems to be larger in June to August than that in other Alpine lakes, the maximum occurring in June; after which time the quantity declines slowly.

Plankton from the Julischen Alps.†—K. von Keissler has examined plankton from several lakes in the Julischen Alps, and reports on it. The phytoplankton of the Veldes See is comparatively rich, but qualitatively plays no more important part than the zooplankton. It is very poor in species, despite the relatively high temperature. The absence of *Ceratium* and *Dinobryon* is remarkable, as well as the very scarce occurrence of diatoms. The composition of the plankton in June and July 1907 was different from that in the same months in 1908. The Wocheiner See showed very little plankton, the zooplankton being qualitatively greater than the phytoplankton. *Ceratium hirundinella* was found. In the Lower Weissenfelder See the samples showed hardly any but phytoplankton, which is, however, not rich and consists almost entirely of diatoms. *Dinobryon*, *Fragillaria*, and *Ceratium* are almost wholly wanting. The Upper Weissenfelder See is very cold, and has but a poor plankton. *Nostoc curuleum* was found, but is probably to be reckoned as a chance escape from the bank flora.

* Archiv Hydrobiol. und Planktonkunde, v. (1910) pp. 339-50; see also Hedwigia, l. (1910) Beibl., pp. (149)-(150).

† Tom. cit., pp. 351-64; see also Hedwigia, l. (1910) Beibl., pp. (150)-(151).

Oscillatoria rubescens.*—H. Bachman describes a water-bloom of *Oscillatoria rubescens* in the Rotsee, in the neighbourhood of Lucerne. It occurred in 1909-10, reaching such intensity in May 1910 that the lake was of a deep copper-red colour. The principal mass of the alga was in the topmost 3 m., and at the banks it was caked into great masses. Towards the middle of June the quantity had begun to decrease, and continued to do so. A rising temperature did not drive the alga into lower layers of water, as had been the case in the Zürchersee and the Baldeggersee, though it was also found plentifully in the water some distance down. The vast quantity of *Oscillatoria* caused a diminution of the other plankton-organisms, and at the same time a large development of Rotatoria. The water was found to contain an enormous amount of sulphuretted hydrogen, possibly from the decay of the *Oscillatoria*.

Polymorphism and Life-history in the Desmidiaceæ.†—G. I. Playfair writes an interesting account of the real conditions of life and development among the Desmidiaceæ, the result of fifteen years continued observations of the same species from the same localities, at different times and under a variety of circumstances. He finds that in Desmidiaceæ, as in other groups of the lower alga, something like 90 p.c. of the "species" are polymorphic forms of the other ten; and it is only by careful tracing out of their life-histories that the specific connexions of their innumerable variations can be established. He refutes the criticisms of West on some of his previous observations. The polymorphism of *Docidium trabecula* is dealt with, and notes on and descriptions of various forms are given.

Spirogyra from the neighbourhood of Besançon.‡—J. Virieux gives a list of about fifteen species of *Spirogyra* gathered by him in the neighbourhood of Besançon. Among them is *S. Spreenii* Petit, which has as yet only been recorded from three localities: Bokhorst (in Holland), Bondy (near Paris), and Islava (in Roumania). The author will publish later a catalogue of the alga of the Doubs.

Codiaceæ.§—A. and E. S. Gepp publish an account of the Codiaceæ of the 'Siboga' Expedition, including a monograph of Flabellariæ and Udoteæ. The paper is founded on the collection of Codiaceæ made by Weber van Bosse in the East Indian Archipelago in 1899 and 1900, and supplemented by other collections in the British Museum and elsewhere. Thirteen of the genera of Codiaceæ are monographed in detail, and of these three are new, while another, *Tydemania* found by Weber had heretofore been only briefly described by her. The genus *Flabellaria* is revived for the reception of *Udotea Desfontainii* and *U. minima*; and *Rhipilia* is not only revived, but receives two new species. Other new species belong to *Chlorodesmis*, *Arrainvillea*, and *Udotea*. The relationship of the various genera is treated in the introduction, and the views of the authors are set forth in tabular form. Hitherto the genera of Codiaceæ have been divided into Codiæ and Udoteæ; but the

* Verh. Schweiz. Naturf. Gesell., i. (1910) pp. 254-5.

† Proc. Linn. Soc. New South Wales, xxxv. (1910) pp. 459-95 (4 pls.).

‡ Bull. Soc. Hist. Nat. du Doubs, No. 16 (Mai-Décembre, 1908).

§ 'Siboga' Expeditie, Monog. Ixii. Leiden: Brill, 1911, 150 pp. (22 pls.).

authors of this paper introduce a third sub-genus, Flabellarieæ, into which they gather all the uncalcified genera which had formerly been included in Udoteæ, while in Udoteæ they place calcified genera only. These sub-families are regarded by them as fundamentally distinct. A synopsis of genera is followed by a full treatment of each genus, with keys to the species, list of synonymy, geographical distribution, and critical remarks. The species of *Codium* found by the 'Siboga' are merely enumerated, together with a list of their localities, and two new species are described. Original types of the species, both old and new, are figured in twenty-two plates.

Fresh-water Algæ of Greenland.*—H. Bachmann publishes some information on the fresh-water algæ of Greenland, the result of collections made by himself and others. He finds that the Flagellatæ are much commoner and more widely distributed than has been supposed, and he adds new records. Of the Peridinieæ, *Ceratium* is entirely absent. The typical plankton-diatoms (*Asterionella*, *Fragilaria*, *Cyclotella*, *Rhizosolenia*) are absent, and other diatoms are sparsely represented. *Nostoc* and *Anabaena* are common, and seven genera of the Schizophyceæ are recorded there for the first time. Desmids appear in every fresh-water pool, and the author adds to the list of records. Chlorophyceæ are not large in quantity, but they are widely distributed. The predominant developments are: November to January, Diatoms and Peridinieæ; May to July, *Dinobryon* and second Diatom-development; July to September, Desmids. A comparison with other regions shows a similarity to Scotland and Switzerland.

Algæ of Andritz.†—F. Wonisch writes a short account of the flora of the "Quellengebiet" of Andritz, which includes thirty-five species. The commonest of these were *Conferva bombycina* and *Closterium macilentum*, the latter being a new record for Styria.

Fresh-water Algæ from Macedonia.‡—S. Petkoff enumerates some algæ collected by him in the lakes, ponds, and marshes in different parts of Macedonia. Twenty-five species and forms are recorded as new to science. Information is also given with regard to the Thallophytes, Muscineæ, and Vascular Cryptogams.

M. A. Gomont.§—E. Bornet writes an interesting account of the late Maurice Augustin Gomont. He was born at Rouen on May 11, 1839, the descendant of an ancient Norman family. He had a brilliant career at the Collège Bonaparte, where he was a fellow-student of Sully, Prudhomme, Carnot, and other distinguished men. In 1858 Gomont entered the school of forestry at Nancy, and was subsequently appointed to be Garde-général of the forests round Rouen. However, the administrative duties of his post becoming irksome to him, he gave up the appointment. He then gave himself to a serious study of painting, a taste he had inherited from his mother, and was successful enough to win several

* Verh. Schweiz. Naturf. Gesell., i. (1910) pp. 255-7.

† Mitt. Naturwiss. Ver. Steiermark, xlvii. (1910) pp. 3-10.

‡ La flore aquatique et algologique de la Macedoine du S.-O., etc. Philippopoli: Danoff, 1910.

§ Bull. Soc. Bot. France, lvi. (1909) pp. 440-9 (portrait).

medals. During this time, however, he continued his botanical studies, and began to mount slides for the Microscope. The desire to find a satisfactory medium for the preservation of the form of microscopic algae brought Gomont into contact with the botanists of the Paris Museum, and the friendship began between Gomont and Bornet which lasted till Gomont's death. At Bornet's suggestion Gomont began his study of the Nostocacées homocystées, which resulted in the very valuable monograph on the subject published by him in 1893. During the years of the preparation of that important work, and afterwards, he published several other smaller papers on other members of the Cyanophyceae, which have been valuable additions to botanical literature. Besides these, Gomont published a study of *Actinococcus*, and a contribution to the algological flora of the Haute-Auvergne. His last paper was a preliminary note of the marine algae of Lorraine, and he was engaged on a larger work on the subject when death overtook him, at the age of seventy-one, at Rouen, in 1909. His old friend describes his work thus: "A little slow, never hurrying himself, persevering in his researches, Gomont was never satisfied until he had obtained from a specimen everything that could be extracted from it." His work also gives the impression of unflinching care and accuracy.

MAZZA, A.—Saggio di Algologia oceanica. (Marine algology.)

[A continuation.]

Nuov. Notar., xxii. (1911) pp. 7-25.

DE TONI, G. B.—Il R. Comitato talassografico e gli studi della Flora dei nostri mari. (The Royal Thalassographic Committee and the study of the flora of our seas.)

[On the work which will be undertaken by this new committee, formed under the auspices of the Italian Government.] *Tom. cit.*, pp. 26-30.

Fungi.

(By A. LORRAIN SMITH, F.L.S.)

Ergot on Oats.*—C. W. Warburton records the finding of ergot (*Claviceps purpurea*) on oats at Ames, in Iowa. The parasite is common on oats in Algeria, but has not previously been reported in the United States. The sclerotia were all formed near the base of the panicle and were most common on the Burt oat, a variety which is entirely resistant to smut.

New Host for Claviceps.†—Herbert Groh found the sclerotia of *Claviceps* on spikes of *Carex* among hay from near Quebec, Canada. The sedge was identified as *C. stellulata* var. *angustata*. The sclerotia are similar in appearance to those found on grasses, but all attempts to induce germination failed. There seems to be no previous record of *Claviceps* on a sedge.

Study of Hypocrea rufa.‡—It has been proved that the conidia of this Pyrenomycete are sometimes green and sometimes yellow, according

* *Bot. Gaz.*, li. (1911) p. 64 (1 fig.).

† *Mycologia*, iii. (1911) pp. 37-8 (1 fig.).

‡ *Jahrb. Wiss. Bot.*, xlviii. (1910) pp. 591-631.

to the acidity or alkalinity of the substratum. Marc Medisch has therefore conducted a series of culture experiments to obtain physiological data concerning the growth of fungi. In a solution of weak glyucose the solution itself became intensely yellow, owing to oxidation which the addition of various salts to the solution tended to accelerate. The colour could again be destroyed by reducing substances; reducing bacteria, however, had only a slight effect on the colour. An addition of nitrogen compounds had also a more or less strong influence on the coloration. Further details are given of the influence of ammonia salts, nitrates, and nitrites.

North American Fungi.*—F. J. Seaver contributes an account of the Nectriaceæ and Hypocreaceæ. He has drawn up synoptic tables of the genera, and in some cases of the species also. He has resuscitated some old genera such as *Typhodium* (*Epichloe*) and *Spermoedia* (*Clariceps*). Helen Letitia Palliser deals with Chatomiaceæ, and D. Griffiths, along with F. J. Seaver, describe Fimetariaceæ, a new family to take the place of Sordariaceæ, with a new genus *Fimetaria* instead of *Sordaria*. Another old genus, *Pleuraea* Fries, is also re-employed for species of *Podospora*, etc.

Mildew of Gooseberry and Oak.†—Gustav Köck reports that the American gooseberry mildew appeared in Galicia in August 1906, and that an appeal was at once made that all cases of the outbreak in Austria should be notified. It was again observed in 1907, and spread further the following years. The oak mildew appeared in 1907 on *Quercus pedunculata*, especially on scrub-oak. The steady and rapid progress of the disease is described by the author.

Copulation of Yeast-cells.‡—A. Guilliermond has already published his observations on *Debaryomyces globosus*, in which he had noted fusion of two isogamic cells before ascus formation. At the same time it was noted that the ascus was frequently formed without such fusion: so that parthenogenesis is a frequent phenomenon, and copulation is not indispensable. Guilliermond has continued the research on various forms, and he finds a retrogression towards parthenogenesis, comparable to that of *Saprolegnia*, as pointed out by De Bary.

Presence of Yeast on Tea.§—The fermentation of tea is due to a process of oxidation. Ch. Bernard thinks that possibly yeast-cells may play a part in the development of the aroma. He has found yeast-cells constantly present on tea-leaves, and they increase abundantly during the stages of tea-collecting, etc. It seems to be constant in the different plantations, and certainly is not deleterious. The presence of bacteria is disadvantageous, as they give a bad odour and make the tea viscous.

Cicinnobolus sp. parasitic on Sphærotheca mors-uvæ.||—Otto Oberstein-Breslan records the appearance of the American gooseberry mildew at Schönfeld. He also found the mildew parasite, *Cicinnobolus*,

* North American Flora, iii., 1 (1910) 88 pp.

† Zeitschr. Pflanzenkr., xx. (1910) pp. 452-5.

‡ Comptes Rendus, clii. (1911) pp. 448-50.

§ Bull. Dept. Agric. Ind. Néerl., No. 36 (1910). See also Bot. Centralbl., cxiv. (1910) p. 617.

|| Zeitschr. Pflanzenkr., xx. (1910) pp. 449-52.

very similar to *C. Vesatii*, though probably specifically distinct. The parasite has not previously been noticed on this mildew. The author gives a list of all the recorded species of *Cicinnobolus*, sixteen in all, and the mildews on which they are parasitic. He does not think it will be of great importance in the destruction of the mildew, as it does not appear until the *Oidium* generation is well over.

Cicinnobolus sp. parasitic on Oak Mildew.*—Paul Vuillemin found this parasite in the forests near Nancy. The oak mildew has spread with alarming rapidity, but Vuillemin thinks that possibly this parasite which lives on the mycelium of the mildew may act as a natural check; it appeared towards the end of a rainy season, but another year it is hoped that it may develop earlier and be more destructive to the mildew. The species has not been determined.

New Hyphomycetes.†—G. Bainier records the discovery of a new genus, *Rubraisiella* (*R. elegans*). It was found growing on dead Banana leaves, and is allied to *Botryosporium* and *Polyactis*. The fungus was cultivated easily on artificial media, but no other life-stage was formed.‡ Bainier also describes a new species of *Gliocladium* found growing on damp straw, and, associated with it, numerous perithecia very similar to those of *Eurotium*. The new species *Gliocladium prolificum* is entirely white.

Parasitic Fungi.§—C. K. Bancroft records the results obtained by artificial cultures of *Cladosporium herbarum*. He found that there were two distinct forms, one parasitic, *Hormodendron*, and one saprophytic, *Cladosporium*. The former is the summer form, and produces disease on the leaves of various plants such as *Brassica*, *Cucumis*, *Malva*, *Phlox*, etc. Conidia of *Cladosporium* when placed on living leaves gave rise to conidia of *Hormodendron*, and the latter infected the leaves. In winter *Cladosporium* exists in the form of microsclerotia, which germinate in spring, and give rise to *Cladosporium* spores. The author has also shown that *C. epiphyllum* is a form of *C. herbarum*.

Monograph of Fusarium.||—O. Appel and H. W. Wollenweber have made a thorough study of this genus of Hyphomycetes, by means largely of culture methods. They have thus been able to contrast the morphology and biology of the different systematic species. They describe those which they consider of special value, thirteen in all. As a diagnostic character, they found the form of the spores more constant and more important than the septation. The conidiophores are more complicated in the more highly-developed species of the genus. As a result of their studies, the authors are able to reduce largely the number of species. They include *Fusoma* and *Pionnotes* in *Fusarium*. Finally, they discuss the relationship of *Fusarium* to higher fruiting forms, *Neckia*, *Neocosmospora*, and *Gibberella*.

* Bull. Soc. Mycol. France, xxvi. (1910) pp. 390-3.

† Tom. cit., pp. 382-4 (1 pl.).

‡ Tom. cit., pp. 385-9 (1 pl.).

§ Ann. Bot., xxiv. (1910) pp. 359-71 (1 pl.).

|| Arb. k. Biol. Anat. Land-Forstw., viii. (1910) pp. 1-207 (3 pls. and 10 figs.).

See also Centralbl. Bakt., xxix. (1911) pp. 215-7.

Research on Uredineæ.*—E. Dittschlag has conducted a research on the various life-stages of *Puccinia Falcarie*, an autoecious Uredine. The mycelium with uninucleate cells passes the winter in the host-plant. The time of teliospore germination, and of new infection by the sporidia is not known. The spermogonia appear first in large numbers, later the aecidia are formed. These latter begin by the formation of a thick coil of mycelium from which arise hyphae towards the epidermis, the end cells becoming sexual or fertile cells. When two of these cells come into contact their walls partly disappear and they fuse together: possibly this takes the place of a previous fertilization by spermatia. The presence of the so-called sterile cells cannot always be proved. After the fusion 2-nucleate spore-mother-cells are cut off, and finally the spores and the intercalary cells degenerate. At an early stage the peridium is formed, the walls of the cells composing it become thickened, and it forms a protection for the aecidium. The spores re infect the same host or an individual of the same species. A bi-nucleate mycelium is formed, and finally teliospores. Probably the teliospores pass the winter on the decaying leaves and germinate in early spring. Dittschlag discusses very fully the results arrived at by different workers in the same field, and their views on the nature of the cell fusion. He rejects the view that any sexual differentiation can be proved in the two cells as they are frequently alike in size, though occasionally the one is larger than the other. It was not possible to prove the constant presence of sterile end-cells (the trichogyne-cells). When such were present they were found on the ends of both the copulating cells. As regards nuclear division the conjugate nuclei divide simultaneously, and the different stages were followed, but the number of chromosomes could not be accurately determined.

Conidial Fusion in *Ustilago Tragopogi-pratensis*.†—Harry Federley finds that two types of conidia are formed on the germination of the spores: (1) large conidia which join in pairs and never bud out; and (2) smaller conidia, which do not at first join in pairs, but which increase by budding. So long as nourishment is provided the budding process continues; when the medium becomes exhausted the conidia unite. In the larger paired conidia there is no distinction of size; the nucleus of the one passes over to the other and the two nuclei fuse. The protoplasm follows later than the nucleus. A previous fusion of nuclei takes place in the *Ustilago* spore, but which of these fusions is sexual has not been determined by the author.

German Agaricaceæ.‡ A. Ricken has published a German Flora of these larger fungi, in semi-popular language, so that it may be useful to the laity as well as to professional mycologists. He has provided German names for all the species in addition to the Latin names. The coloured plates represent about half of the species recorded.

* Centrallbl. Bakt., xxviii. (1910) pp. 473-92 (3 pls. and 7 figs.).

† Förh. Nordisk. Naturf.-och Läk., Helsingfors, xxi. 7 (1903) pp. 24-26.

‡ Die Blatterpilze (Agaricaceæ) Deutschlands und der angrenzender Länder. Leipzig: Weigel (1910) lief. 1, 32 pp. (8 col. pls.).

Fungi from Greenland.*—C. Ferdinandsen gives a list of the larger terrestrial fungi brought back by the Denmark Expedition from that territory. There were twenty species; one new Gasteromycete is described, *Calvatia arctica*.

J. Lind † describes the Micromycetes from the same country, chiefly parasites on the Phanerogams collected. He lists sixty-five species, of which four are new to science. Notes are given on the microscopic characters of many of the species.

Fungi from Venezuela and the West Indies.‡—C. Ferdinandsen and O. Winge describe the fungi collected on Warming's Expedition. There are thirty-six species listed with critical notes. Two new genera are described, *Myxotheca* of uncertain position, but evidently near to Plectascineæ, and *Stilbochalara* (Phæostilbeæ). The authors describe four new species.

Notes on Chilian Fungi. I.§—Roland Thaxter spent six weeks at Punta Arenas on the Straits of Magellan, and gives notes of the fungi observed by him during the summer. A great forest of the antarctic beech (*Nothofagus*) had been burned down in the district near the town, but in the woods some distance away quite a large fungus-flora was found, Agaricaceæ, Hymenogastreae, Pezizae, and Myxomycetes all flourishing and maturing in the valleys where the temperature seldom rises above 60° F., while freezing temperatures are common at night all through the short summer. The more resistant forms, such as the Pyrenomycetes, were well represented, though Polyporei were scarce.

Two new species of parasitic microfungi are described, *Taphrina entomospora* and *Uncinula Nothofagi*, both on leaves of *Nothofagus*.

German Fungus-flora.||—W. Herter is the author of the latest fascicle of this work. It treats of the Autobasidiomycetes, in which are included all Hymenomycetes and Gasteromycetes. Herter gives a general account of the history of these groups since their earliest mention by Greek writers up to the most recent works of systematists. He gives also an account of their development and of the different forms assumed by mycelial growth, fruit-bodies, etc. Notes are also given on their habitat and economic uses. The separate orders and families are then dealt with down to *Irpeæ*, one of the Hymenomycetinae.

Physical Conditions of Resistance of the Vine against Mildew.¶ Jules Laurent finds that the power of resistance in leaves and grapes depends on the molecular concentration in the cells of the host-plant. He explains his methods of work, and gives tables of the results obtained. A series of experiments was also carried out on potatoes as to their resistance to *Phytophthora infestans*, and the results obtained were exactly parallel to those observed in the vine.

* Med. om Grønland, xliii. (1910) pp. 137-45.

† Tom. cit., pp. 149-62. See also Bot. Centralbl., cxvi. (1911) pp. 121, 123.

‡ Bot. Tidsskr. xxx. (1910) pp. 208-22. See also Bot. Centralbl., cxvi. (1911) pp. 121-2.

§ Bot. Gaz., 1. (1910) pp. 430-42 (2 pls. and 1 fig.).

|| Krypt.-Flora Mark Brandenburg, vi. 1 (1910) pp. 1-192 (figs.).

¶ Comptes Rendus, clii. (1911) pp. 103-6.

Micro-organisms and Fermentation.*—The fourth edition of this book by Alfred Jørgensen has recently been issued, and has now been translated into English by S. H. Davies. It is concerned chiefly with the micro-organisms of the fermentation industry. Descriptions are given both of useful and injurious yeasts, moulds, bacteria, etc. Full accounts are given of the methods found most useful in examination and investigation of these minute plants as they occur in nature or in artificial cultures. Attention is also paid to their use in various economic processes in fermentation, etc. The book is illustrated by figures in the text, and a very full bibliography of the subject is given.

Geotropism and Phototropism in Fungi.†—A. de Jacewski cites a case of geotropism in *Polyporus fomentarius* following the cutting down of the trunk on which it grew. The original hymenophore was covered by a thick sterile layer, while two new plants, face downwards, were formed on each side of the old one. He records several other instances of unusual growth due to the influence of light.

Chemistry of the Higher Fungi.‡—Julius Zellner constantly found maltose in wood-inhabiting fungi belonging to the genera *Polyporus*, *Armillaria*, *Xypholoma*, *Dædalea*, and *Trametes*. In *Trametes suaveolens* and *Polyporus igniarius* he found a ferment that split salicin. He thought it might be similar to one that Sigmund had determined in willows and poplars that acted on salicin, but not on any other glucosides. A series of tests were made, and Zellner concluded that the two ferments must be considered as distinct.

In a second paper§ the author gives the results of his chemical examination of maize smut. He confirmed previous work as to the presence of trimethylamin and sclerotin acid. He gives a list of other substances also found in that fungus.

In a third paper|| devoted to the same subject, Zellner treats of the symbiosis of host and parasite, and tests each to see if their cell-products correspond. He found that very few cell-products pass unchanged from host to parasite. The chemical composition of the parasite is determined by its systematic position, and by the substratum, and there are also sporadic substances formed. There are no principal differences proved between the cell-products of saprophytic and parasitic fungi. The parasite acts on the host by ferments; possibly there may be other processes. Parasitic fungi excrete substances that are harmless or poisonous, and in the latter case give rise to pathological phenomena. Synthetic processes in parasites are almost totally unknown. An examination of fungi parasitic on animals might do much to enlighten us as to the chemistry of parasitism.

Ambrosia Fungus.¶—F. W. Neger has taken up again his work on the fungi that are cultivated by *Asphondylia* beetles inside the galls, as

* London: Charles Griffin & Co., Ltd., Exeter Street, Strand (1911) xi. and 189 pp. (101 figs.).

† Bull. Soc. Mycol. France, xxvi. (1910) pp. 404-8 (6 figs.).

‡ S.B. k. Akad. wiss. Wien, Math.-Nat. Kl., cxviii. (1909) pp. 439-46.

§ Anz. k. Akad. wiss. Wien, Math.-Nat. Kl., No. 10 (1910) p. 116.

¶ Tom. cit., pp. 116-17. See also Hedwigia, 1. (1910) Beibl., pp. 107-8.

¶ Rev. Deutsch. Bot. Ges., xiv. (1910) pp. 455-80 (1 pl.).

food for the young larvae. In the galls on *Sarothamnus* and *Coronilla emeroïdes*, the fungus has been determined as a species of *Macrophoma* (Sphaeropsidae); it is probable that the same species of beetle forms both the galls on these widely distributed plants, and the wide geographical range also testifies to the close connexion between the beetle and the species of fungus. In the newly-formed gall the beetle passes the winter as a larva, the fungus is also present in the form of a ball of hyphae. Occasionally there are impurities such as yeast fungi and *Coniothyrium leguminum*, the latter with small pycnidia and minute olive-green spores. A note is added on the behaviour of invading insects (Inquilines). Some of them evidently avoid it, others graze on it after having eaten the larva. Full descriptions of the fungi *Macrophoma Coronillæ* and *Coniothyrium leguminum* are given.

Termites and Fungi.*—Junnelle and Perrier de la Bathie write on the fungus-eating ants in Madagascar. There are two kinds of ants: one builds its nest in the open and does not cultivate nor eat fungi, though a new species of *Podalizon* has been found near the nests. Other ants live on trees, and their nests also are without cultures of fungi, but they contain broken up wood and galleries similar to those of the fungus-eaters. There is only one species in that class, *Termes Perrieri*, which forms nests in woods. In the abandoned nests are found rhizomorphs which produce finally conidia and stomata with perithecia. Sclerotia are also present, and a new fungus which has been determined as *Xylaria termitum*.

Fungi in Clay Mines.†—Perley Spaulding gives notes of a visit he paid to the mines near St. Louis to study the fungi on the timbers. These mines are not deep, and the timbers are placed along the horizontal galleries to prevent the soil from falling in. There is no light, a cool rather unvarying temperature, and considerable moisture. Several fungi were evidently unable to form sporophores in these conditions: others fruited more or less normally. Among those noted were: *Merulius rubellus*, very abundant in one mine, not found in the vicinity. *Fomes annosus* was found once growing abundantly on a cross-piece of pine wood. *Fomes applanatus*, *Lenzites betulina*, *Polystictes versicolor*, and *Stereum spadiceum* were found sparingly. *Hydnum erinaceus* was found hanging from the oak timbers. *H. coralloïdes* and *H. artocreas* also grew, though rather rare. *Merulius lacrymans* var. *verucifer* was abundant on oak. *Coprinus atramentarius* and the edible mushroom were more or less abundant. Masses of mycelium were found, but they did not produce sporophores even when transferred to the outer air, except in one case, when a plant of *Schizophyllum commune* was developed.

Research on Diseases of Trees.‡—Munch has studied the subject, by making pure cultures and inoculation experiments with several of the higher tree-fungi, and describes in detail the effect produced.

* Rev. Gén. Bot., xxii. (1910) pp. 30-64 (9 figs.). See also Bot. Centralbl., cxvi. (1911) p. 16.

† Rept. Missouri Bot. Garden, xxi. (1910) pp. 189-95 (1 fig.).

‡ Naturw. Zeitschr. Land-Forstw., 1910, pp. 389-408, 425-47. See also Centralbl. Bakt., xxix. (1911) pp. 259-9.

Collybia rotulipes was inoculated on red chestnut and a species of poplar. The tissues in the immediate vicinity were browned and killed, but the *Collybia* did not establish itself on the trees.

Stereum purpureum. Proof was gained that in certain conditions this fungus is a parasite of beech and poplar. It grows quickly and requires little air.

Schizophyllum commune is not a very active parasite, but in favourable conditions it may kill large portions of the tree. It often grows associated with *Polyporus hirsutus*.

Stereum rugosum is frequently found on hazel, more rarely on beech. After infection, no damage ensued.

Polyporus ignitarius, a well-recognized parasite. It attacks chiefly the vital tissues of bark and cambium, and does much damage. The experiments were very successful.

Polyporus fomentarius, one of the most deadly enemies of the beech. Infection experiments were particularly successful; the mycelium spread in an upward and downward direction, and betrayed its presence by a dark red discolouration surrounded by a still darker line.

BRESADOLA — Diagnoses novarum specierum Polyporacearum ex India occidentali et orientali. (Diagnoses of new species of *Polyporus* from East and West Indies.) *Med. Rijks Herb.*, 1910 (1911) pp. 75-6.

COLIN, H. — Hydrolyse de quelques Polysaccharides par le *Botrytis cinerea*. (Hydrolysis of some Polysaccharids by *Botrytis cinerea*.)

[Culture experiments with the fungus on various sugars: saccharose, maltose, lactose, trehalose, etc.] *Ann. Sci. Nat.*, sér. 9, xiii. (1911) pp. 1-112.

GUGÉVEN, FERNAND — Mycose cladosporienne de l'Homme. (*Cladosporium mycosis* in man.)

[Description of ulcer caused by *Cladosporium* sp.] *Comptes Rendus*, clii. (1911) pp. 412-13.

MATRUCHOT, LOUIS — Un nouveau Champignon pathogène pour l'Homme. (A new fungus pathogenic for man.)

[The fungus proved to be a member of the Hypocreaceæ, and has been named *Mastigocladium Blochii*.] *Tom. cit.*, pp. 325-7.

MURRILL, W. A. — The Agaricaceæ of Tropical North America. II.

Many new species of *Lepiota* are included.] *Mycologia*, iii. (1911) pp. 79-91.

NÖRING, J. Die den Bauhölzern und den Gebäuden gefährlichen Pilze. (Dangerous fungi of timber and building wood.)

[Descriptions of various fungi, and advice as to treatment of timber.] Königsberg i. Pr.: Grafe & Unzer, 1910, pp. vii. 71. See also *Centralbl. Bakt.*, xxix. (1911) pp. 266-8.

PAUM, B. Nye Bidrag till Stockholmstraktens Svampflora. (New contribution to the fungus-flora of the neighbourhood of Stockholm.)

[The author describes 140 parasitic species.] *Sw. bot. Tidskr.*, iv. (1910) pp. 1-8. See also *Bot. Centralbl.*, cxvi. (1911) p. 257-8.

REHM, H. — Zum Studium der Pyrenomyceten Deutschlands, Deutsch Oesterreichs und der Schweiz. (Study of the Pyrenomycetes of Germany, German Austria, and Switzerland.)

An account of Platystomaceæ.] *Ann. Mycol.*, ix. (1911) pp. 94-111.

SPAYD, F. J. Studies in Colorado Fungi. I. Discomycetes.

[Critical notes on various species, several new to science.] *Mycologia*, iii. (1911) pp. 57-66.

- STRASSER, P. PIUS — **V. Nachtrag zur Pilzflora des Sonntagberg (Nied.-Oest.).** (Contribution to the fungus-flora of the Sonntagberg, Lower Austria.)
 [The list includes the Tubercaceæ and Pyrenomycetes, Nos. 1653-1774.]
Ann. Mycol., ix. (1911) pp. 74-93.
- THEISZEN, F. — **Die Hypocreaceen von Rio Grande do Sul, Sudbrasilien.** (The Hypocreaceæ of Rio Grande do Sul, S. Brazil.)
 [Description of the family, genera, and 103 species.]
Tom. cit., pp. 40-73 (3 pls.).
- WEHMER, C. — **Notiz über Rhizopus-Arten.** (Note on species of *Rhizopus*.)
 [By culture experiments, the fungus was accurately determined.]
Ber. Deutsch. Bot. Ges., xxviii. (1911) pp. 547-9.
- WESTLING, R. — **En ny ascusbildende Penicillium-Art.** (A new ascus-forming *Penicillium*.)
 [The fruiting-form of a new species was found, and is described.]
Sc. bot. Tidskr., iv. (1910) pp. 139-45 (1 fig.).
 See also *Bot. Centralbl.*, cxvi. (1911) p. 212.
- WHELDON, H. J. — **Some Argyll and Perthshire Fungi.**
 [Fungi collected during a tour in North Scotland.]
Ann. Scot. Nat. Hist. (1911) pp. 34-8.
- WORONOW, G. — **Contribuciones ad Mycofloram Caucasi.** (Contributions to the fungus-flora of the Caucasus.)
 [A list of 368 species.] *Trud. a. d. Bot. Gart. Tiflis*, xi. (1910) pp. 133-71.
 See also *Ann. Mycol.*, ix. (1911) p. 128.

Lichens.

(By A. LORRAIN SMITH.)

Lichen Gonidia.*—F. Elfving recounts the history of the controversy as to the nature of the various elements of the lichen thallus. Schwendener, followed by Bornet, insisted that it was composed of two separate organisms—alga and fungus—living together in symbiotic relationship and without genetic connexion. Their views gradually prevailed, and are now universally accepted. Elfving considers that there is room, however, for reconsideration, and describes his research on several typical lichen thalli. In *Peltigera canina* the gonidia lie below the cortical layer. They have been identified as a species of *Polycoccus*, considered by Kirchner as a form of *Nostoc punctiforme*. They are spherical or ovate blue-green cells, and occur in groups surrounded by hyphæ. In the lower and middle parts of the gonidial zone the cells give the impression of being algal, lying free amongst the hyphæ. Towards the cortex they are embedded among the colourless cellular tissue as if they filled up hollow places. Closer observation shows that they differ from the colourless cells only by their colour, and form with the others a continuous tissue; lower in the zone they possess a gelatinous wall.

Elfving holds that the formation of new cells takes place during a short period in spring. The cortex consists of an outer layer of thick-walled cells that pass over into hair-like hyphæ. Within this layer lies

* Förh. Nordisk. Naturf. och Lak., xvi. 7 Helsingfors (1903) pp. 26-30.

metastematic parenchyma, of which the roundish cells are closely united, almost with an interspace; the upper cells remain as cortical tissue, the lower cells grow out into hyphæ. Among the cells which are to form the gonidial zone new gonidia arise, and in single cells of this tissue the blue algal colour appears. These newly-formed blue-green gonidia are at first surrounded by colourless cells, but by increase in numbers they come to live in groups among the loose hyphal tissue. Elfving decides that these coloured cells have the same origin as the colourless, and are not different organisms.

He repeats these observations on *Everina prunastri*, the gonidia of which belong to *Cystococcus*. In spring he found numerous colourless cells or gonidia which had all been transformed by the end of May into green cells; intermediate stages can be traced. Originally they were formed as the end cells of short hyphal branches, and can often be seen in situ, but they separate easily. Elfving further states that he has never seen hyphæ penetrate the gonidia. He allows that there is a gap in his observations; he is not sure that he has seen the first beginnings of a gonidium, but probably they are formed as colourless cells in late autumn or in winter. He has, however, demonstrated the occurrence of colourless gonidia in *Anapychia ciliaris*, *Ramalina purpurata*, *Usnea barbata*, and *Cladonia rangiferina*.

Culture of Lichen Gonidia.*—Ernest Häyrén, a pupil of Elfving, has also been studying the lichen thallus. He finds that the gonidia (*Cystococcus*) are smaller in *Ramalina* than in *Everina*, and divide more frequently. In *E. furfuracea* they form colonies, in *E. prunastri* they are more scattered. Häyrén cultivated small portions of the thallus as well as soredia on various culture media in damp chambers. The greater the illumination, the more cell-division occurred among the gonidia, which finally became free from hyphæ. The new cells were formed in 8 or multiples of 8 within the mother-cell, and became free by the breaking down of the enclosing cell-wall. Swarm spores were formed when any change was made in the illumination from dark to light or on any weakening of the culture solution. They are pear-shaped, with two equal cilia at the foremost end.

The colourless cortical cells of the thallus grow very slowly in culture solutions, and produce a mycelium. If grown in the dark the mycelium finally predominates over the gonidia. The hyphæ of the medulla do not develop further. The dark brown lower cortex of *E. furfuracea* developed in sugar solution a mycelium, which on being transferred to bark decoction produced spore-balls formed by repeated cell-division and interwoven growth of the hyphæ. In these balls are formed minute round spores, the whole interior of the balls finally falling into spores which germinate readily in sugar solution. Growth in this case ceases very soon, but if gonidia are added, mycelium revives quickly, and when transferred to bark decoction forms again spore-balls.

The mycelium cultivated from soredia of *E. furfuracea* also forms spore-balls in bark decoction. Mycelium from the soredia of *Ramalina tartarea* forms similar balls.

* Forh. Nordisk. Naturf. och Lak., xvi. 7 Helsingfors (1903) pp. 31-2.

Apothecial Development in Anaptychia and Physcia.*—Arth. Wahlberg publishes notes of his examination of the fruit-development in these two genera. 1. The trichogynes have no mechanical purpose. 2. The ascogenous hyphæ and the paraphyses are undoubtedly connected in *Anaptychia ciliaris*, *A. leucomelena*, and in *Physcia pulverulenta* var. *detersa*; probably also in other species, though the proof is not so convincing in these. 3. The paraphyses are at first in connexion with the upper cortical layer, becoming free later. 4. The principal new formation of paraphyses is probably from the parathecium.

HAMBLETON, J. C.—**A List of the Lichens of Ohio.**

[Compiled chiefly from the collection in the State Herbarium at the Ohio State University.] *Ohio Naturalist*, x. (1911) pp. 41-3.

LYNGE, BERNT—**De Norske busk- og bladlaver.** (Norwegian leaf and shrubby lichens.) *Bergens Museums Aarbog* 1910 (No. 9), 122 pp. (7 pls.).

Mycetozoa.

(By A. LORRAIN SMITH.)

Distribution of Mycetozoa in the South Midlands.†—J. Saunders has prepared lists of species with exact localities in Hertfordshire, Bedfordshire, Buckinghamshire, Middlesex, and Essex. The records for Middlesex are fewest in number. Hampstead Heath and Highgate Woods are now so open to the public that few species are to be found in them. Most of those recorded are from Cannons Park, near Edgware. The highest record is for Bedfordshire, 104; and only four species are absent from the list for that county that have been recorded in the others mentioned.

Spongospora subterranea.‡—T. G. B. Osborn publishes a preliminary note on the development of this organism, which causes powdery or corky scab of potatoes. It is first apparent as a multinucleate amœba, just below the surface of the tuber, which increases in size, the nucleus dividing by a method of amitosis. The amœba itself divides by fusion, and occupies new host-cells as these divide; finally a plasmodium is formed. Nuclear division was observed, and is described, as well as spore formation. The writer concludes that his observations prove the relationship of *Spongospora* with *Sorosphæra* and *Plasmodiophora*. He also was able to prove that the nuclear fusion and subsequent divisions resemble in a striking manner those described in *Arcyria* and *Trichia*.

A. S. Horne§ has also been working at *Spongospora*. He gives further details about the formation of the plasmodium. The amœboid bodies become approximated and grouped about the nucleus of the host-cell, so that the condition is somewhat similar to the pseudo-plasmodium of the Acrasieae. The pseudo-plasmodium becomes converted into a single spongy spore-ball—not hollow, as has been stated by a previous observer. Encysted individuals or groups of individuals may be found, which are similar to the microcysts of other Myxomycetes.

* Förh. Nordisk. Naturf. och Lak., xvi. 7 Helsingfors (1903) pp. 35-6.

† Trans. Hertford Nat. Hist. Soc., xiv. (1911) pp. 179-88.

‡ Ann. Bot., xxv. (1911) p. 271.

§ Tom. cit., p. 272.

Schizophyta.

Schizomycetes.

Distribution of Paratyphoid Bacilli.*—Before the year 1907, there were no differences of opinion as to the conditions under which paratyphoid bacilli were found. It was considered that these organisms were invariably pathogenic, incapable of existing as saprophytes. Since that time, however, many authorities have abandoned this position, and claim for these organisms a very wide distribution in nature. In this present paper, Anmann has made a solid contribution to the settlement of the problem. After a resumé of the work that has been done in Germany upon this class of organisms, he describes the researches carried out by himself at Hamburg and elsewhere. The material available consisted of various foodstuffs, ice, specimens of urine and feces from men and animals; in all, about nine thousand examinations were made. He concludes from these investigations that paratyphoid bacilli have no saprophytic phase of existence. These organisms are pathogenic to animals as well as to man, and are not uncommonly found in slaughtered animals. Paratyphoid carriers probably are of frequent occurrence among these animals, and more particularly among such indiscriminate feeders as swine. The isolation of these organisms from sausages and such articles of diet has therefore an importance which must be interpreted in accordance with these results. †

Acetobacter melanogenum.†—M. W. Beijerinck gives an account of this organism, one of the group of acetic bacteria, which has the property of producing a pigment, by means of which light beer is made dark. If a flask of this darkening beer is kept undisturbed for some days, a pellicle forms, from which cultivations upon beer-wort gelatin plates show the presence of peculiar brown colonies, with a clear margin and a deeply pigmented centre. This growth only takes place upon media which contain glucose or maltose. The chromogen which causes this pigmentation is an aromatic substance, which is burned black in the presence of iron salts. It also reduces alkaline silver and mercurial solutions and turns them black. It differs in some respects from true oxydases and peroxydases. Cultivation and the reaction with iron salts are best shown upon a culture medium containing agar, glucose, peptone, potassium phosphate, iron citrate, and chalk. After twenty-four hours incubation at 30°, the black pigment is clearly seen. It may also be demonstrated by omitting the iron salt from the original medium and adding it when growth has taken place.

Agglutination of Micrococcus melitensis by Normal Sera.‡—L. Negre points out that, under certain conditions, normal sera will agglutinate the organism of Malta fever, and diagnostic errors may arise in this way. In a dilution of 1:30, at 37° C., agglutination may be produced; it can always be observed after 4 or 5 hours with a Microscope, often even with the naked eye. At room-temperature agglutina-

* Centralbl. Bakt., 1te Abt., Orig., lvii. (1911) pp. 310-46.

† Op. cit., 2te Abt., xxix. (1911) pp. 169-76.

‡ C.R. Soc. Biol. Paris, lxxix. (1910) pp. 564-5.

tion also occurs, but more slowly. In dilutions of 1:50, normal sera will still cause agglutination to take place, but more slowly. No agglutination takes place if normal sera be diluted 1:100. Heating for half an hour to a temperature of 56° will destroy all the agglutinating power of a normal serum. Sera of goats, sheep, rabbits, and other animals, possess the same property. In order to avoid diagnostic errors the following conditions should be observed: dilutions of 1:30 should not be used; dilutions of 1:50 should be observed only within the first 5 hours: all errors may be avoided by heating the serum to 56° for half an hour.

Survival of Intestinal Organisms in Cooked Meats.*—E. Maurel has carried out some researches, with a view to finding the length of time for which certain bacilli retain their powers of reproduction upon the food-stuffs obtainable at a French cooked-meat shop. Only those meats which were destined for eating without further cooking were used. Samples in good condition were taken, and cultivations made in order to ascertain what micro-organisms were already present. The meat was then sterilized in an autoclave. The effectiveness of the sterilization was tested by cultivations. Then the surface of the meat was inoculated, in one series with *Bacillus coli*, in another with *B. typhosus*. It was found that the former retained its reproductive powers for twenty-four hours, probably for several days. The latter was less resistant, but appeared to retain power of reproduction for at least twenty-four hours.

Resistance of *Micrococcus melitensis* to Lactic Ferments.†—P. Darbois has made observations upon the length of time in which *Micrococcus melitensis* will survive in milk inoculated with a lactic ferment. He finds that this organism may be recovered up till the eighteenth day after inoculation. This is both of considerable theoretical interest, as this organism is in many conditions fragile; and of practical importance as showing that butter, cheese, cream, etc., prepared from a contaminated milk may continue to be infective for two or three weeks.

Thermobiosis.‡—A. Ambrož gives a comprehensive review of the literature of the subject. The first historical record of the phenomenon was published in 1774 by Somnerat, who stated that certain fish were capable of living in water at 69° C. In recent times there have accumulated numerous records of micro-organisms, which are capable of increasing and multiplying at a temperature higher than that at which albumin coagulates. In 1837, algae living in the hot springs at Carlsbad were described. Other instances of the occurrence of various micro-organisms in springs at high temperatures are recorded. Recently bacteria have been isolated from wells at Vranje in Servia, of which the optimum temperature was found to be 72° C. From soil, faeces, spring water, milk, and other sources, organisms have been obtained, which grow best at temperatures of 60 to 70° C. Some investigations have been carried out and some hypotheses propounded, with a view to elucidating the abnormalities of metabolism in these organisms. Full references are given.

* *Compt. Rend. Soc. Biol. Paris*, lxxix, (1910) pp. 574-7. † *Op. cit.*, lxx, (1911) pp. 102-4

‡ *Zentralbl. Bakt.*, xlvi, (1910) pp. 258-70.

Bacterial Cytology.* H. Pénau, who has previously carried out researches upon the minute structure of *Endomyces albicans*, here gives an account of his application of similar methods to the study of *Bacillus megatherium*. The organisms were grown upon agar media, and examinations of the cells were made at the end of 35 hours, 62 hours, and 5 days. For the demonstration of the three fundamental elements—metachromatic granules, nucleus, and basophile formation—different methods of fixation were adopted. The two latter structures were shown well in cells fixed by the method of Perenyi, while Lavdovsky's method was found most suitable for the demonstration of the two former. In young cells the cytoplasm takes up a uniform blue basophil colour with Unna's polychrome stain. Metachromatic granules appear at the poles of the bacillus. A small structureless nucleus may be shown by means of any ordinary nuclear stain. A few bacilli are binucleate, fewer multinucleate. The nucleus appears to divide by amitosis. No karyokinetic process has been observed. The basophil formation may be seen in cells 36 hours old, which have been stained with gentian-violet, in the form of a few granules which grow into a network and then into an irregular banding, at right angles to the long axis of the bacillus. Spores are the result of exaggerated nuclear growth.

Sporotrichum beurmanni in Man.†—M. E. Pinoy gives an account of three cases of human infection with this parasite. An examination of caseous material from a gumma showed abundant organisms, some free, some ingested by leucocytes. Dominici's eosin-orange-toluidin-blue is best suited for its demonstration. One of these cases studied showed a most remarkable degree of generalized sporotrichosis. Specimens prepared from this patient showed not only the presence of small conidia undergoing phagocytosis, but also a large number of filaments in the neighbourhood of the capillaries, which penetrated the walls of these vessels and formed an interlacing network in the interior. Some of these filaments were covered with spores. It appears, therefore, that this species is capable of forming spores within human tissues.

Soured Milk.‡—R. T. Hewlett, in a review of the subject of the nature, preparation and uses of soured milk, considers, in the first place, the natural flora of the human alimentary tract. The preponderance in childhood of Gram-negative organisms of such types of *Bacillus bifidus*, lactic-acid producing bacilli, yielding in later life to an ascendancy of putrefactive forms, suggested to Metchnikoff the hypothesis that some change, incident to senility, might be due to auto-intoxication. The endeavour to restore artificially the fermentation processes found in the intestines of children constitutes the fundamental principle of all sour milk treatment. In his search for an organism that would form lactic acid when introduced into the intestines, Metchnikoff turned his attention to the milk ferments so widely used all over the East. From the Bulgarian *Yoghurt* he obtained a bacillus which has proved to be a powerful lactic-acid ferment. The bacteriology of the Oriental milk fer-

* Comptes Rendus, clii. (1911) pp. 53-6.

† Tom. cit., pp. 286-8.

‡ Nature, lxxxiii. (1910) pp. 159-61; lxxxv. (1911) pp. 338-9.

ments is a most complex subject, and it appears that in the majority of cases, e.g. *B. bulgaricus* and *Streptococcus lacticus*, more satisfactory results are obtained by the use of two organisms in symbiosis than with pure cultures. *Bacillus bulgaricus* alone may have some effect upon the fat of milk, producing a small quantity of a nauseous product.

The author gives a general account of the methods in use for preparing sour milk, and refers to its therapeutic applications. The extent to which the Bulgarian bacillus has developed can be readily observed by bacterioscopic methods, as the morphological characters of this organism are so distinctive. In conclusion, particulars are given of the comparative efficacy of a variety of preparations supplied to the author for investigation.

Bacillary Disease among Fish.*—In the summer of 1910, fish of the species *Leuciscus rutilus*, in the lake of Nantua, perished in large numbers. The epizootic attained such proportions that not only did the fishermen sustain serious loss, but it became necessary in the interests of public health to collect and destroy the dead fish. The condition was investigated by L. Mercier and R. de Drouin de Bouville. The diseased fish came to the surface of the water, tried ineffectually to dive again, struggled, lost their equilibrium, turned on one side, and remained motionless until death. Lesions of the scales were found, which suggested that the condition was one of *Lepidorthosis contagiosa*, due to the *Bacillus pestis astaci*. From one of the diseased animals an organism identical with this was recovered. The organism is flagellate, motile, Gram-negative; it produces a turbid growth in broth, liquefies gelatin, and coagulates milk. Inoculations of small doses into crayfish caused death in four days, with symptoms typical of *Pestis astaci*. The fish disease was also reproduced artificially by inoculation. It appears, therefore, that this disease is maintained in this lake in an enzootic form by the presence of these two hosts of the micro-organism.

Nitrifying Organisms in Soil.†—H. Pringsheim gives a concise general account of the micro-organisms occurring in soil, which perform a nitrogen-fixing function. The first group mentioned comprises those organisms which form root-nodules on leguminous plants. The subdivision of these into classes affords a problem which the systematist has yet to solve. It appears, however, that different varieties affect different species of plants, and it has been found difficult, in some cases, artificially to infect a plant with an organism associated normally with another species. The organisms living free in the soil fall into two classes. One type, isolated first by Winogradsky, is a sporing bacterium, of a *clostridium* form. *Azotobacter*, a rounded form, was cultivated by Beijerinck in a mannite-containing medium. The author deals further with the distribution of these organisms, and with problems connected with their metabolism. He considers the question of the decomposition of cellulose: and refers, in conclusion, to inoculation experiments performed with different types of nitrifying organisms.

* Comptes Rendus, clii. (1911) pp. 289-92.

† Biol. Centralbl., xxxi. (1911) pp. 65-81.

MICROSCOPY.

A. Instruments, Accessories, etc.*

(1) Stands.

Beck's London Microscope: Handle Model.†—This instrument (fig. 43) was described at the April Meeting.‡ The illustration shows the special feature of the new model; it is so designed that the limb forms a strong handle, by which the instrument can be conveniently grasped without danger to the adjustments. In other respects the instrument possesses all the well-known characters of the original model.

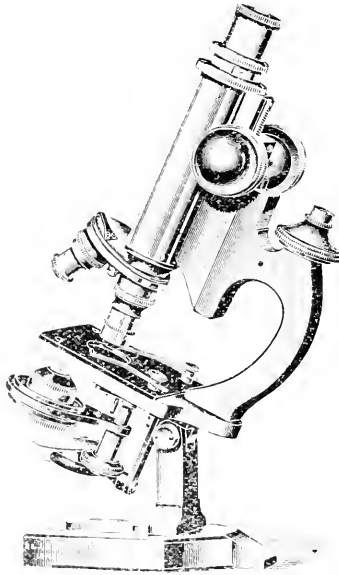

FIG. 43.

Winkel's Stand No. 1d.§ This instrument (fig. 44) is of medium size and has similar focusing adjustments, stage and substage mechanism to Stand No. 1; but is smaller, owing to the body-tube being of the ordinary diameter. Owing to the lesser weight and slightly different construction of the inclinable joint, a clamping lever is unnecessary.

The maker produces a similar instrument with centring rotating stage and stage-diaphragm, but without rectangular movements.

* This subdivision contains (1) Stands; (2) Eye-pieces and Objectives; (3) Objectives and other Apparatus; (4) Photomicrography; (5) Microscopical Technique and Manipulation; (6) Miscellaneous.

† See Beck's Special Catalogue (1911) 4 pp. (2 figs.).

‡ See this Journal, p. 419.

§ R. Winkel, Göttingen Catalogue, 1911, pp. 26-7 (1 fig.); pp. 28-9 (1 fig.).

Winkel's Demonstration Microscope with Detachable Foot.*—

This instrument is intended for use at lectures and demonstrations, when it is desired to pass specimens illustrating the various points dealt with from hand to hand. The sliding tube coarse-adjustment can

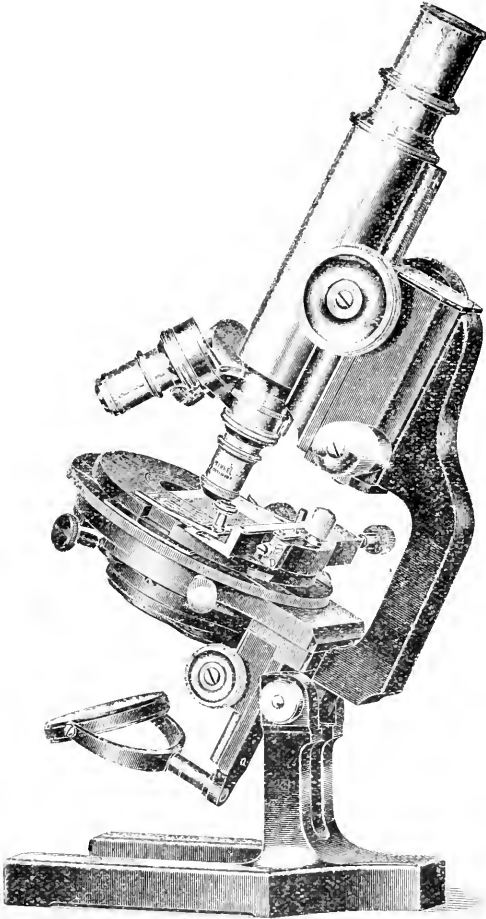

FIG. 11.

be clamped when desired. Fine-adjustment is effected by sliding the eye-piece in or out of the tube, which is sprung for holding it in the desired position.

SOUZA-BRANDÃO, V. DE - *O novo Microscópio da Comissão do Serviço Geológico. Com. do Serviço Geológico de Portugal*, v. (Lisbon, 1903) pp. 118-250 (2 pls.).

* R. Winkel, Göttingen Catalogue, 1911, p. 44 (3 figs.).

3. Illuminating and other Apparatus.

Efficiency of Metallic Filament Lamps.*—R. A. Houston has made some measurements on the radiant efficiency of carbon, osmium, tantalum and tungsten glow-lamps. By calculating the radiant efficiencies of the different filaments at their marked voltage and taking the mean he obtains the following results:

	Radiant Efficiency.	Watts per Candle.
Carbon	2.9	3.5
Osmium	5.2	1.5
Tantalum	6.5	1.7
Tungsten	7.5	1.0

Reichert's New Breath Screen.†—This breath screen (fig. 45) is found to afford complete protection from the damage arising from the

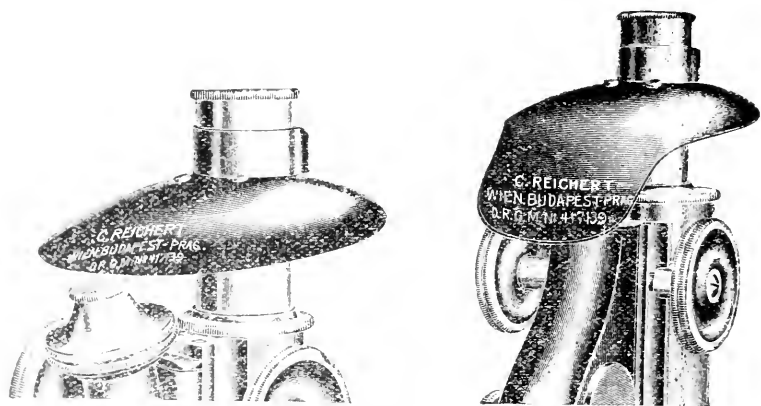

FIG. 45.

warm breath of the observer, especially during the cold seasons. It does not inconvenience the observer and is readily attached by means of a clamping screw.

Improved Micrometer.‡—The object of this improvement, which is described by M. Himoff, is to enable more accurate reading of the micrometer, so as to disclose at a glance how much above or below a given size a piece may be after the micrometer has been set to a given size.

The pin A slides on a guide, as shown in fig. 46. It is connected to the pointer B which indicates on the dial C, a spring normally holding the pointer at the low point. When the piece to be measured is placed in position the stem is screwed down, pressing the piece against the pin A until the pointer moves to zero. The reading is then taken, and when the next piece is to be measured to the same size it is placed between the pin A and the stem, and the pointer will move up or down according to

* Proc. Roy. Soc. Edinburgh, xxx. (1910) pp. 555-62.

† C. Reichert's Special Catalogue, 1910.

‡ American Machinist, through English Mechanic, xciii. (1911) p. 147 (1 fig.).

whether such piece is thicker or thinner than the standard. The scale indicates in thousandths or ten-thousandths, or whatever is desired. D is an adjusting screw and slot whereby the scale may be adjusted to compensate for the variation in the threads of the micrometer. In fig. 47 is shown the lever B connected by suitable gearing with the pin A and with the lever B' and the pointer B. The operation will be the same, only the scale or dial in this case may be more conveniently made finer than in the other case, as for ten-thousandths or above. The button at B' enables the lever B' to be operated. In either case, if the piece to be inserted should be thicker than the standard the part B' or B may be

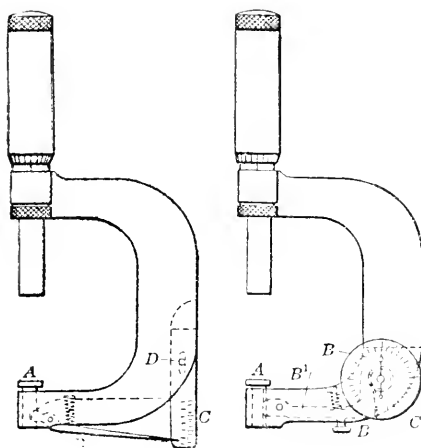

FIG. 46.

FIG. 47.

used to draw down the pin to let the piece in readily, and then when the pin is released it will move against the piece and indicate on the dial the amount the piece may be over or under the standard size.

5) Microscopical Optics and Manipulation.

Transmission of Light through Transparent Inactive Crystal Plates, with special Reference to Observations in Convergent Polarized Light.* —F. E. Wright, in his treatment of this subject, divides his treatise into two parts, viz.: Part I., Theoretical; Part II., Observations and Measurements. In the first part he develops in terms of the electromagnetic theory of light the general mathematical treatment of the transmission of light waves through a transparent inactive crystal plate, special attention being given to the rotatory effects of the boundary surfaces of the crystal plate on the plane of polarization of a transmitted wave. Both theory and the observations of Part II. show that, as a general rule, a uniaxial plane polarized light wave after trans-

* Amer. Journ. Sci., xxxi. (March, 1911) pp. 157-211 (18 figs.).

mission through a bare crystal plate is still plane polarized, but its plane of polarization has suffered a slight rotation depending on the direction of transmission, and if examined under crossed Nicols does not appear perfectly dark in consequence. In general it may be stated that from an incident plane polarized wave two refracted waves are formed which on emergence from the plate are each still plane polarized, but their planes of polarization are not precisely 90° apart.

Phenomena of Visual Inhibition which may accompany the re-association of the two Retinal Images dissociated by the Prisms of the Stereoscope. Conditions and determination of these Phenomena.*—M. A. Chauveau describes and discusses a series of experiments which tend to evaluate the function of each eye in stereoscopic vision. He arranges so that the two objects viewed differ in detail so as to produce a condition of asymmetry. When a person whose eyes are of unequal visual acuity views such objects through any ordinary stereoscopic apparatus, the effect seen is dependent on the object presented to the stronger, or dominating, eye. The phenomenon may be very strikingly illustrated by a suitable choice of asymmetrical objects. The necessary condition of asymmetry may also be produced by such means as breathing on one of the prisms.

HAVELOCK, T. H.—Optical Dispersion: an Analysis of its Actual Dependence upon Physical Conditions. *Proc. Roy. Soc., Series A*, lxxxiv, p. 492-523.

(6) Miscellaneous.

Infinitely Small Chemical Magnitudes.†—P. A. Guye gives an excellent résumé of the modern views of molecular constitution. He discusses granules, molecules, atoms and electrons. He pays justice to the useful part played by the Microscope in this important field of research. With the ultramicroscope and arc-lamp illumination Siedentopf has easily distinguished objects of diameter 0·01 μ and, with summer solar light, objects as small as 0·003 μ . As the molecules of certain albuminoids are ascertained by calculation to have a diameter of 6 μ , it follows that, under certain conditions, molecules can not only be seen, but their calculated magnitude be verified by experiment. While the molecules of gases seem at present to be beyond the reach of vision, yet Perrin by means of an enormous number of microscopic observations on emulsions has established that in an emulsion of uniform granules the distribution of such granules at various depths is subject to the same law as connects the density of the air with its pressure. In other words, Laplace's atmospheric equation

$$\frac{2}{3} w \log \frac{n_0}{n} = \phi (\Delta - \delta) g$$

is made applicable to certain solids. [w = mean granular energy; n and n_0 , the numbers of granules at depths h and h_0 ; ϕ , the volume of one granule; δ , its density; Δ , the density of the medium; and g the acceleration due to gravity.] One of the results of the observations

* Comptes Rendus, clix, (1911) pp. 481-7 (2 figs.).

† Verh. der Schweiz. Natur. Gesell., i, (1910) pp. 168-200 (6 figs.).

is the calculation of w , which is found to have the same numerical value as for the mean kinetic energy of gaseous molecules. This leads up to the calculation of Avogadro's constant, or the number of gaseous molecules contained in a molecule-gram of any gas at 0° and under a pressure of one atmosphere. This constant is found to have a probable value of 70.5×10^{22} .

Stereoscopic Illusion.*—F. G. Baily describes a stereoscopic observation which lends itself to quantitative expression and may possibly prove to be capable of practical application. It is well known that, if a finger be held vertically in front of the eyes and a distant object be looked at, two images of the finger will be seen, quite transparent if the two images do not overlap, and opaque only at overlapping parts. In place of the finger use a thin rod at a distance of some six or more feet, and focus on another vertical rod at a distance of 30 feet or more so that the second rod is seen between the two images of the first. The apparent position of the second rod will be found to be distinctly nearer than its real position. Thus, let $A_1 A_2$ (fig. 48) be the observer's eyes, B the first rod, and C the second. Then each eye

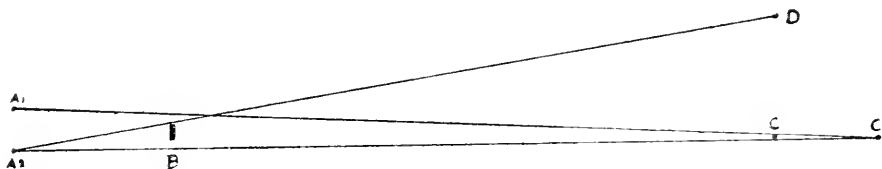

Fig. 48.

sees C without hindrance, and the observer sees a transparent image of B on each side. C then appears at C' . To observe this, B is preferably not strongly lighted, or the tendency to focus on B may be too great. C must be well away from its background, so as to stand alone with the background out of focus. The ground on which C stands must be hidden so as to prevent any other knowledge of its position. For if the actual situation on the ground is seen, the visible proof of its position will mentally outweigh the indication given by the stereoscopic effects. The apparent position of C may be determined by setting up a similar rod D near to the line A C sufficiently on one side to be visible to both eyes. D is then moved backwards and forwards until it is judged to be the same distance from the observer as C appears to be. The diagram has been drawn to correspond with the following actual figures, the vertical scale being exaggerated to twenty times the horizontal: $A_1 A_2$, $2\frac{1}{2}$ inches; B, 1 inch broad; A C, 100 feet; and C D, 1 foot. The author gives a full account of a number of out-of-door experiments tried by him. These experiments seemed to show that the displacement $C C'$ bears a definite relation to B C. The observation of the phe-

* Proc. Roy. Soc. Edinburgh, xxx. (1909-10) pp. 551-5 (2 figs).

observation, however, appears to be more or less personal, and probably depends to some extent upon the observer's power of stereoscopic perception.

Quekett Microscopical Club. The 472nd Ordinary Meeting of the Club was held on March 28, 1911, the President, Professor E. A. Munchin, in the Chair. Mr. A. C. Banfield exhibited and described a new form of mercury-vapour lamp made by the Brush Electrical Company. The usual type of lamp takes the form of a luminous cylinder about 7 feet in length, giving a great total luminosity with a relatively low specific intensity. In the new form, the use of fused quartz for the manufacture of the tube enables the length to be reduced to about 4 inches, although the candle-power, about 3000, remains the same, and the gain in the specific intensity is so enormous as to render it eminently suitable for microscopic use. The peculiarities of the mercury spectrum were referred to, and the great advantages offered by this illuminant were pointed out. A paper on "Dark-ground Illumination," by Mr. E. M. Nelson, F.R.M.S., was read by the Honorary Secretary. The author referred to the increasing use of this method of illumination. The form of lamp recommended—paraffin, with $\frac{1}{2}$ -inch wick—was referred to, and the best means of obtaining dark-grounds described in detail. Owing to the lateness of the hour, a paper on "Some New Diatomic Structure Discovered with a New Zeiss Apochromat," communicated by Mr. A. A. C. Eliot Merlin, F.R.M.S., was taken as read.* Mr. James Murray, F.R.S.E., F.Z.S., made some introductory remarks to a paper on "Water-Bears, or Tardigrada," intended to supplement the one contributed in 1907. As the name Tardigrada is already appropriated by Vertebrates, the new official name of the group is order Arctiscoida, family Xenomorphidæ. Four new genera were described, and their relationships and those of the other genera discussed at some length, and the paper concluded with a synopsis of the ten genera known and the 120 at present admitted species. A bibliography is appended.

The 473rd Ordinary Meeting of the Club was held on April 25, 1911, the President in the Chair. Mr. A. C. Coles, M.D., D.Sc.Edin., etc., sent a note describing the use of Parolein as a mounting medium. It is absolutely neutral, and, so far as is known, is entirely without action on any dyes. Its refractive index is 1.471, as against 1.530 for balsam in xylol. The President exhibited and described preparations of two species of cysticeroid of rat-tapeworms from the body-cavity of the rat-flea, *Ceratophyllus fasciatus*. These were *Hymenolepis diminuta* and probably *H. murina*. He also showed dissections of the ventral nervous system of the flea, *Ceratophyllus fasciatus*, and the salivary glands and duct of the same organism. Mr. N. E. Brown contributed "Some Odd Notes upon Seeds," describing some of the more beautiful forms he had noticed. He recommended lighting the mounts with a spot-lens and concave mirror from below, and also with a stand-condenser from above, the combined lighting being very effective. The use of coloured gelatin, say red, placed below the spot-lens, and a piece of green placed over the stand-condenser, still further increased the beauty of

* Journ. Quekett Micr. Club, April 1911, p. 131.

these objects. Mr. D. J. Scourfield, F.Z.S., F.R.M.S., made some remarks on "The Use of the Centrifuge in Pond Life Work." He used a hand-driven form, running at about 7000 r.p.m., with very small tubes holding only about $1\frac{1}{2}$ c.cm. He had observed quite a number of forms new to him, but could not yet say if they were really new; certainly some had never been named. He thought there was a considerable field for work on what had been termed the "centrifuged plankton."

BARUS, C. & M.—On an Adjustment for the Plane Grating similar to Rowland's Method for the Concave Grating.

[The authors give full particulars of a simple apparatus contrived and successfully used by them.]

Amer. Journ. Sci., xxxi. (Feb. 1911) pp. 85-95 (6 figs.).

B. Technique.*

(2) Preparing Objects.

Studying the Compound Eyes of Water-mites.†—K. Bedau fixed the material (e.g. *Notonecta glauca*, *Hydrometra palustris*, etc.) in four kinds of fluid, but found that a mixture of 15 parts of 96 p.c. alcohol, 30 parts distilled water, 6 parts formalin, and 2 parts acetic acid gave the best results. Perforations were made in thorax and abdomen to allow the fixative to penetrate more easily. After from 6 to 12 hours, the insects were removed to 70 p.c. alcohol for 6 hours, and then transferred to "Seifenspiritus," in which they remained for 24 to 48 hours: soap spirit is preferable to Eau de Javelle or Eau de Labarraque for softening the chitin, and with the exception of fatty tissue has no deleterious action. The preparations were afterwards passed through up-graded alcohols, and afterwards, using cedar-wood oil as intermediary, embedded in paraffin. The sections were stained by Heidenhain's iron method or with hæmalum. For removing the pigment two fluids were used. One consisted of 3 parts of nitric and 3 parts of muriatic acids to 150 of distilled water: the other was composed of 2 parts 96 p.c. of alcohol and 1 part glycerin with some nitric acid.

(4) Staining and Injecting.

Studying the Cytology of Bacteria.‡—C. C. Dobell obtained his material from the intestinal contents of animals, mostly frogs, toads, and lizards. He found that the usual methods of fixation may under suitable conditions and with careful procedure be made to give excellent results. Films should never be allowed to dry before fixation. When the medium containing the bacteria is too watery, gelatin or albumen should be added until a film of suitable consistence is obtained; if the medium be too

* This subdivision contains (1) Collecting Objects, including Culture Processes; (2) Preparing Objects; (3) Cutting, including Embedding and Microtomes; (4) Staining and Injecting; (5) Mounting, including slides, preservation fluids, etc.; (6) Miscellaneous.

† *Zeitschr. wiss. Zool.*, xvii. (1911) pp. 418-20.

‡ *Quart. Journ. Micr. Sci.*, lvi. (1911) pp. 395-506 (4 pls.).

quick it should be diluted with isotonic salt solutions. After trying numerous fixatives and stains the author confined himself to two methods: (1) fixation with osmic acid or formalin, followed by one of the modifications of the Romanowski stains; (2) fixation with Schaudinn's sublimate alcohol, followed by Heidenhain's iron-alum hæmatoxylin. When using the former method the author proceeds as follows. A drop of the medium containing the bacteria is placed on a slide, and then by its side a drop of 1 p.c. osmic acid or of pure formalin. The two drops are mixed together and a film made. When dry the slide or slip is placed in absolute alcohol for 10 to 15 minutes. On removal, it is allowed to dry and then stained with Giemsa or Leishman. After staining, the film is differentiated in 30 p.c. alcohol, washed in distilled water, dried with cigarette paper and mounted in cedar-wood oil or in neutral Canada balsam. Chromatin structures are coloured a bright red, the cytoplasm being blue, lilac or pink, according to the degree of differentiation.

The author adds in a footnote that beautiful preparations of small Flagellates and other protista may be obtained by the foregoing method.

Rapid Staining with Giemsa's Azur-eosin Solution.*—G. Giemsa gives the following method of using his azur-eosin mixture. Equal quantities of the stock solution and methyl-alcohol are mixed. The slide is placed coverside up on a Petri dish and then covered with the solution; this is allowed to work for half-a-minute. Distilled water is then poured in until the slide is quite covered. The dish is then tilted to and fro in order to mix the water and solution. After 3 to 5 minutes or even longer the fluid is decanted off, the slide washed in running water, dried and examined in cedar-wood oil. The author states that he has not made sufficient trials to venture an opinion as to permanence.

New Method of Chromatin Staining.†—Mentz von Krogh describes the following easy method of staining chromatin; it is specially adapted for nervous tissue; the only preparations for which it is distinctly unsuitable are blood films. Paraffin sections are stained with Unna's polychrome methylen-blue for 5 minutes, and after a short wash in tap-water are mordanted from 1 to 15 minutes (according to the object dealt with) in 2 p.c. chromic acid. After another wash the sections are differentiated with 5 p.c. tannic acid solution until they assume a pale blue or a reddish-violet hue. They are then washed anew, rapidly dehydrated with absolute alcohol, then xylol and balsam. The chromatin of the cell-nucleus should be dark blue, the protoplasm and its prolongations pale blue. Nissl's bodies are blue, but not so dark as the nucleus; axis cylinders are violet; connective tissue is of a pale greenish hue. The stain is suitable for showing up Negri's corpuscles.

Saffron in Histological Technique.‡—P. Masson has found that saffron has a remarkable affinity for collagen, staining it a brilliant golden yellow. As some samples stain the cell-protoplasm to a certain extent, it is advisable to combine it with eosin and some nuclear stain,

* Münch. med. Wochenschr., 1910, p. 2476.

† Centrallbl. Bakt., 1te Abt. Orig., lviiii. (1911) pp. 95-6.

‡ C.R. Soc. Biol. Paris, lxx. (1911) pp. 573-4.

by which means a triple staining is effected. The technique is as follows: 1 gm. of saffron is boiled in 100 c.cm. of water for half an hour and the decoction filtered. In the course of a few days the solution becomes turbid, but retains its staining properties for 2 to 3 weeks. Pieces of tissue are best fixed in Bouin's fluid, but Zenker and sublimate give fair results. The sections are first stained with Mayer's hæmalum. Should the connective tissue be stained, the section must be decolorised in HCl-alcohol. After washing in tap-water the sections are blued in lithium carbonate 1 p.c.: they are then washed freely to remove all traces of the carbonate, and afterwards stained for 10 minutes in 5 p.c. water-soluble eosin, or for 2 hours or more in 1 p.c. eosin. After a wash in water the sections are treated with the saffron solution for from 5 to 10 minutes. They are then rapidly washed with water, dehydrated, cleared up and mounted in dammar or balsam. The nuclei are blue, protoplasm red to orange red, connective tissue, bone, and cartilage yellow.

(5) **Mounting, including Slides, Preservative Fluids, etc.**

Fading of Anilin-stained Microscopical Preparations and a New Medium.*—A. C. Coles, after remarking that the greatest cause of fading in balsam-mounted preparations is acidity, whether present at the time or developing subsequently from oxidation of the mounting medium, expresses the opinion that practically all substances of the nature of balsams, oleo-resins, or cedar-oil, will sooner or later oxidize and become acid, and therefore are liable to cause fading of aniline stains. The author was advised to try paraffinum liquidum, or a pure form thereof, viz., parolein, as it was absolutely neutral and remains so. His method of use is as follows:—

“A small drop of parolein is placed on a perfectly clean cover-glass, which has been held over the flame of a spirit lamp to drive off any moisture on the glass, and this is applied to the air-dried film, which is also held for a second considerably above the flame, just long enough to make the moisture fade off. If the amount of oil is just sufficient to reach the margin of the cover-glass, so much the better. If there be too much oil the preparation is placed under a piece of blotting paper, and the excess of oil removed as much as possible. The margin of the cover-glass is then rung round with Apathy's gum syrup made as follows: picked gum arabic, cane sugar, ordinary, not candied, distilled water, of each 50 gm. Dissolve over a water bath and add 0.05 gm. thymol. I test the reaction with litmus paper, and if acid I add a little sodii carbonas. If the cover-glass is round the cement can easily be applied on a turn-table; if square, which I prefer, one paints it round with a very small brush. The gum syrup sets quickly in a warm room in about 15 to 30 minutes. When dry I apply over it a coat of Bell's cement, which also dries quickly (the latter is not acted upon by the immersion oil), and I feel I have a preparation that will keep.”

The writer points out that time alone will show whether the preparations will be permanent or not, and then remarks that while the mounting is a little more trouble, parolein is optically superior to cedar-oil or balsam.

* *Lancet* (1911) i, pp. 878-8.

Mounting Arthropoda in Amann's Chloralphenol.*—M. Langeron calls attention to chloralphenol, one of the media devised by J. Amann for mounting vegetable preparations.† The writer finds that this medium is very effective for preparing and mounting Arthropoda, as it not only softens the chitinous investment but at the same time clears up and dehydrates the specimen. The manipulation is extremely easy; the insects are killed by immersion in hot 70° alcohol; they are then treated with the chloralphenol, which may be renewed once, and when sufficiently dehydrated are removed to xylol balsam. The only preparations which failed were those of insects gorged with blood.

(6) Miscellaneous.

New Forceps.‡—M. Morosoff describes a forceps which he uses for picking up cover-glasses and slides. He has found them especially useful when dealing with highly infective material, such as plague, glanders, etc. The chief feature of the instrument is the grooved fangs.

Film Test for Crude Rubber.§—C. P. Fox, after examining 33 commercial brands of crude rubber belonging to ten distinct groups, failed to find any indication pointing towards a definite film peculiar to any particular brand of rubber. The experiments were undertaken in order to confirm or refute the observations of J. Torrey, who found that when 5 gm. of crude rubber were dissolved in 100 cc.m. of petroleum naphtha, a few drops allowed to evaporate on a white surface gave characteristic figures. If Torrey's view was correct then any crude rubber could be identified: unfortunately his observations are not confirmed.

Metallography, etc.

Nickel-sulphur System.||—K. Bornemann has made a further thermal and microscopical study of this system in the range 0–30 p.c. sulphur, and finds that his earlier equilibrium diagram can be simplified by the replacement of two series of nickel-rich mixed crystals by one series. Errors in the earlier determinations appear to have been due to supercooling of the melts.

Tellurides of Sodium and of Silver.¶—G. Pellini and E. Quercigh have made a thermal study of the sodium-tellurium system and the silver-tellurium system. The compounds found are Na_2Te , Na_3Te_2 , Na_4Te , AgTe , and Ag_2Te .

Tellurium Alloys.**—M. Kobayashi has determined the equilibrium diagrams of the tellurium-cadmium and tellurium-tin systems. One compound, having a high melting point, exists in each system. TeCd

* C. R. Soc. B. J. Paris, lxx. (1911) pp. 457-9.

† See this Journal, 1899, p. 142, sections (1) and (4).

‡ Gerzaboli, *Bull. 1^o Abt. Orig.*, lvi. (1910) pp. 131-2 (3 figs.).

§ *Jour. Nat. Hist.*, x. (1910) pp. 146-8.

|| *Metallogr.*, vi. (1910) pp. 667-74 (6 figs.).

¶ *Atti R. Accad. Lincei*, xix. (1910) pp. 350-56, 415-21, through *Journ. Chem. Soc.*, xviii. (1910) pp. 1062-3.

** *Zeitschr. Anorg. Chem.*, lxxix. (1910) pp. 1-9 (9 figs.).

melts at about 1041°C ., but exists in the melts only in equilibrium with an excess of tellurium. TeSn melts at 780°C . Mixed crystals do not occur in either system.

Gold-tellurium System.*—M. Coste has made a microscopical examination of twenty gold-tellurium alloys, prepared in minute quantities by melting together weighed portions of the two pure metals in sealed vacuous glass or silica tubes. One compound, AuTe_2 , which forms eutectics with each of the two metals, was found. The results were confirmed by measurements of E.M.F. of solution.

Alloys of the Noble Metals.†—W. Geibel has determined the electrical conductivity, temperature coefficient, and thermal E.M.F. against platinum, of several series of binary alloys of metals of the platinum group, gold, and silver. The tensile strength of wires was also determined. Complete results are given for the palladium-gold series.

Physico-chemical Studies of Lead.‡—E. Cohen and K. Inouye claim to have proved that the two apparently different kinds of lead crystals, which may be obtained by electrolysis of solutions of lead salts, are not allotropic modifications, but must be regarded as identical.

Zinc Amalgams.§—E. Cohen and P. J. H. van Ginneken have found in the 10 p.c. and other zinc amalgams transition points at 42.9° and 20°C . The equilibrium diagram of the zinc-mercury system, based on these and previous observations, is applied to the explanation of the peculiarities of the Clark standard cell.

Alloys of Cadmium, Bismuth and Lead.||—W. E. Barlow has determined the equilibrium diagrams of two binary systems, lead-cadmium and lead-bismuth, and the ternary system, by thermal methods. Supercooling was avoided by frequent inoculation of the cooling melt with fragments of the solid alloy. The composition of the ternary eutectic is given as 40.2 p.c. lead, 51.65 p.c. bismuth, 8.15 p.c. cadmium; its freezing-point is 91.5°C .

Heat-treatment of Brass.¶—G. D. Bengough and O. F. Hudson have studied the effects of heat treatment on rolled and drawn brass containing 70 p.c. copper, 30 p.c. zinc. The best combination of strength and ductility was obtained by annealing at temperatures between 600° and 700°C . Length of time of annealing has a marked effect; a bar of pure brass may be heated for half-an-hour at a temperature a few degrees below the solidus without burning, while a sufficiently long annealing at a temperature 100°C . lower may produce burning. Burning is considered to occur if the elongation in the tensile test is lowered. The atmosphere of the annealing furnace, whether oxidizing or reducing, appears to have little effect on the brass. The growth of the crystals upon annealing was studied microscopically.

* Comptes Rendus, clii. (1911) pp. 859-62 (3 figs.).

† Zeitschr. Anorg. Chem., lxi. (1910) pp. 38-46 (2 figs.).

‡ Zeitschr. Phys. Chem., lxxiv. (1910) pp. 202-6 (2 figs.).

§ Tom. cit., pp. 437-93 (8 figs.).

¶ Journ. Amer. Chem. Soc., xxxii. (1910) pp. 1390-1412 (14 figs.).

¶ Journ. Inst. Metals, iv. (1910) pp. 92-127 (28 figs.).

Metallography as an Aid to the Brassfounder.*—H. S. Primrose, discussing the use of microscopical examination for controlling the quality of brass and bronze castings, points out the importance of casting temperature in the case of gun-metal castings.

Shrinkage of the Antimony-lead Alloys.†—D. Ewen and T. Turner have determined the changes in length taking place in cast bars in cooling from the solidification temperature, for antimony-lead and aluminium-zinc alloys. Time and temperature observations were made simultaneously with the length measurements. The microstructure and hardness of the cold bars were investigated. In the antimony-lead system, where no solid solutions exist, the extensometer curves gave results apparently having no relation to the equilibrium diagram, except as indicating an expansion due to the solidification of the eutectic. In the aluminium-zinc system, which contains solid solutions, the expansion curve closely follows the liquidus curve from 0 to 50 p.c. aluminium. A general theory relating expansion in alloys to range of temperature during solidification cannot yet be propounded.

Effect of Silver, Bismuth and Aluminium upon Copper.‡—F. Johnson has determined the effect upon the properties of copper, containing small quantities of oxygen and arsenic, of additions of silver, bismuth and aluminium. The ingots were hot-rolled to bars; tensile and bending tests were made, and the microstructure was studied. Hydrofluoric acid was used as an etching re-agent for some of the specimens containing bismuth.

Occluded Gases in Copper Alloys.§—G. Guillemin and B. Delachanal have heated twelve different specimens of brass, bronze and tin in a vacuum at 1100° or 1000° C. The extracted gases were analysed, and were found to consist chiefly of hydrogen in the sound specimens, while in spongy castings notable amounts of carbon monoxide and dioxide were found in addition to the hydrogen. Phosphor bronzes yielded little gas.

Influence of Sulphur on the Iron-carbon System.||—T. Liesching has taken cooling curves of fifty melts containing 0.08 to 4.78 p.c. carbon, 0.01 to 1.11 p.c. sulphur, and has microscopically examined the solid alloys. The microsections were etched by successive immersion in an amyl-alcohol solution of picric acid, an amyl-alcohol solution of nitric acid, and a hot solution of sodium hydrate. The sulphide was coloured brown in preparations thus obtained. The temperatures of commencing solidification and of eutectic solidification are lowered by addition of sulphur; the temperature of pearlite formation (A_{r_1}) is unaffected. Melts containing more than 2 p.c. sulphur and a high carbon content separate into two layers, the upper layer being rich in sulphur and poor in carbon, the lower poor in sulphur and rich in carbon.

* Journ. Inst. Metals, iv. (1910) pp. 248-64 (16 figs.).

† *Ibid.*, pp. 128-62 (29 figs.).

‡ *Ibid.*, pp. 163-234 (24 figs.).

§ *Rev. Metallurgie*, viii. (1911) pp. 1-6 (6 figs.).

|| *Metallurgie*, vii. (1910) pp. 565-71 (19 figs.).

PROCEEDINGS OF THE SOCIETY.

MEETING

HELD ON THE 19TH APRIL, 1911, AT 20 HANOVER SQUARE, W.,
H. G. PLIMMER, ESQ., F.R.S., ETC., PRESIDENT, IN THE CHAIR.

The Minutes of the Meeting of March 15th were read and confirmed, and were signed by the President.

The following Donations received since the last Meeting were announced, and the thanks of the Society voted to the donors :—

	From
J. Arthur Thomson and J. J. Simpson, Alcyonarians of the } Indian Ocean. Part II. (4to, Calcutta, 1909) }	The Trustees of the Indian Museum.
Slide of <i>Aulacodiscus superbus</i> in Styra ^x }	Mr. J. T. Norman- Thomas.

Mr. Conrad Beck exhibited a new Microscope, which he said was of very much the same type as other instruments, except that it had a limb of such a shape as to form a handle. The slow motion, worked by a lever inside the body of the Microscope, was entirely in front of the limb, so that in lifting the instrument no alteration in the adjustments was likely to occur. The other adjustments were the same as were usually found in that particular type of Microscope.

The thanks of the Society were accorded to Mr. Conrad Beck for his communication.

Mr. Spitta gave a demonstration on "Low-Power Photomicrography, with special relation to a colouring method for tinting lantern slides." In his preliminary remarks, Mr. Spitta said that the subject of photomicrography might be divided into three different sections—namely, high power, medium power, and low power work. With high power photography, an objective having a focal length of, say a twelfth or thereabouts, was employed: in medium work one of, say a quarter or a sixth was used; but with low power, an inch, or one of still greater focal length, was usually selected. In that branch of low power work where the objective was of longer focal length than an inch, it was customary not to employ a Microscope at all, the objective being attached to an ordinary camera. In olden days the selection of objectives for this particular branch of low power work was a source of no little difficulty, for they were mostly of the ordinary photographic variety that did not work at a greater aperture than $f/8$, and their corrections were such that they did not produce very good images, the

principal reason being of a two-fold nature. Inasmuch as the N.A. of a photographic combination is ascertainable by dividing 0.5 by the f ratio, and as the f ratio of lenses of this time did not exceed $f/8$, the power of picking out details was consequently poor and ineffectual. Moreover, as the construction of objectives of this period was not of the same high order as that available in the present day—the astigmat not being then known—the whole of an insect, for example, could not be rendered in focus at one and the same time. If the body was sharp, the feet were fuzzy, or *vice versa*. The roundness of the field was very marked and annoying. All these troubles were swept away at one moment by the introduction of Zeiss's "Planar," for it has an excellent flat field, and seeing its aperture is in the region of $f/3.5$, its powers of definition are exceptionally fine and beautiful. Even this system seems to have been improved by some of the firm's later productions, where three and even two-lens systems are employed instead of four, which reduces the internal reflections from 28 to 15 and 6 respectively, a great gain being thereby effected in making the "blacks" of the object still more intensely black. Other manufacturers have risen to the occasion of later years: there is the Micro-Summar, a lens by Leitz that is much sought after; the Beck-Steinheil, by R. and J. Beck, which is a very excellent tool and a two-lens system; and lastly, a still later combination by Herr Reichert, called the "Polar," that is one of very exceeding merit, furnishing images of great perfection at almost full aperture.

In making slides for colouring purposes, it is imperative that the background should be perfectly clear and clean, and that all the transparent parts of the object should be absolutely transparent, free from fog or veil of any kind. It is necessary also that the "blacks" should be really black, and that there should not be even a trace of brown in evidence, for if so, the truth of the colour rendering in the final result would be imperilled almost for certain. An artist friend of his and himself had been for the past ten or more years engaged in trying to conquer the many difficulties connected with this colouring of lantern slides, and it would be well at once to state that she it was who had originated and discovered the several means of producing the results about to be shown. There were several difficulties, the principal being, first, to get the painting clear and transparent, that there should be no opaqueness in the slide, for if so, it would look dull and uninteresting when thrown on the screen, and would want such a powerful light to be used. Then came the great difficulty of getting rid of the paint granules, or "paint grains" as they used to be called. Then the avoidance of any running together, blending or overlapping of the colours at their point of contact, which in some instances arose apparently from irregular absorption of the colour by the gelatin of the emulsion. Lastly, came the difficulty of the paint hiding or rendering too faint the limiting markings in the specimen—as for example, the cell-walls of a piece of a leaf or similar structure. This may seem of little importance, but, if neglected, the slide loses a very large portion both of its effectiveness as well as its truthfulness. These difficulties, he thought, had at length been overcome.

Some fifty or more slides were shown. These comprised botanical

sections with both single as well as double staining, others exhibiting the "fall of a leaf" and the formation of the "abscissa" layer; insects whole or compressed, the Crustacean *Astacus longicornis*, or wood-boring animal of the ocean; different ferns and plants, showing their varied method of carrying pollen, seeds and spicules; the membrane behind and in front of the lens in the eye of the newly-born kitten; groups of flowers formed by insects' scales; and finally, examples of a moth and of a butterfly, and two groups of daffodils.

At the conclusion, Mr. Spitta said he would be only too pleased to explain to any Fellow of the Society his method of producing the slides, the plates used, and so on—in fact, anything relating to the photographic side of the subject, and that he would give Mr. Parsons the name and address of the artist, for he felt sure that some might like to avail themselves of this method of rendering contrast by colour, which gave such very superior differentiation to that obtainable by ordinary photographic methods.

The President gathered that the method used was that of painting over a specially taken photograph, and he presumed that the process employed by Mr. Spitta for colouring photographs was entirely new, and as yet unpublished. He had seen very beautiful results obtained actually with the stained specimen itself, though of course only up to a certain degree of magnification. He returned the heartiest thanks of the Society to Mr. Spitta for his demonstration.

In reply to the President's supposition that the process employed by the artist for colouring the slides was entirely new and as yet unpublished, Mr. Spitta replied that this was so, at least so far as he knew.

The vote of thanks accorded to Mr. Spitta for his demonstration was carried with acclamation.

Mr. Spitta was then asked to communicate his "Report on the Grayson's Ruling presented by Mr. Conrad Beck to the Royal Microscopical Society."

Before reading the report,

Mr. Spitta said that Mr. Beck had been kind enough to give to the Society two rulings, an inch divided into hundredths, and a millimetre with divisions of 0.25. He did not propose to read the paper in its entirety, for it was of a very dull nature, and not fit for the purpose. There were several difficulties which became apparent after commencement which did not strike him before. One was to make a suitable arrangement, one that would not shift during the somewhat protracted time occupied by making several thousand observations. The stand had to be of the most rigid kind—indeed, he had to cast aside a very large number of readings on this account, some 1500 or 1600, if not more. Then, again, owing to the size of the rulings many arrangements of objectives and oculars had to be experimented with so as to avoid errors of curvature of field, and such like troubles. The details of the examination were set forth in the paper, but he might say the rulings were in themselves most remarkably fine and perfect over the halves of the scales under observation, but that a peculiar error manifested itself

in the *absolute* values, for from the mean of all the measures the ratio of Grayson's millimetre to Grayson's inch was found to be 25·369 : 1 instead of being 25·400 : 1, which is the correct ratio, Grayson's ratio being wrong to the extent of 1 part in 800.

It would seem desirable, however, Mr. Spitta added, seeing so small a part of the ruling would be used at any time, and that the rulings were otherwise so perfect and regular, that a portion should be examined at the National Physical Laboratory, when they were prepared for the work, as he felt sure such rulings would be of great use for Fellows to have as a means of calibrating their own micrometers. He wished to acknowledge the kind assistance of Mr. Conrady, who had reduced and treated the observation mathematically, so as to obtain therefrom all the information possible.

Mr. Conrad Beck said that Mr. Grayson had, during the last year or so, been occupied in making a new screw. The difficulty in making the rulings absolutely correct lay in the fact that there was no existing standard to which it was easy to refer. The Board of Trade were at the present time conducting investigations in Westminster in regard to the measurement of the standard yard, a bar of bronze kept in Westminster, and looked at once in twenty years for the purpose of making true copies. It was extremely difficult to realize that the standard was purely arbitrary, and so far there had been nothing to refer it to, and that if that standard were by any chance destroyed, our standard yard would be lost. The object of the Board of Trade at the present time was to measure how many wave-lengths of a particular coloured light there were in our standard yard, and for this purpose they had set up an apparatus in Westminster to calibrate the standard. He thought that when a standard was subdivided into small amounts it would be extremely difficult to be certain no errors had arisen. He had himself made up a somewhat simpler form of interferometer, and after some experimenting he found that it would be quite possible for an ordinary person to measure a stage micrometer in terms of the wave-length of light. The interferometer depended upon the arrangement of two mirrors reflecting a beam of light. A beam of light was split into two, and one-half reflected from each mirror. The length of path of the two beams of light could be made identically the same. When in the neighbourhood of equality and the length of the two paths were within a few wave-lengths of light, and the light was recombined and brought back into the eye, the phenomenon of interference was produced. On the shifting of one of the mirrors, the bands produced by interference were seen to travel across the field, and could be counted. For every motion of one of these bands across the screen, the mirror had to be moved a wave-length of light. If white light were employed, the interference obtained lasted only a very short period, but in the use of monochromatic light the period over which the motion of the bands could be counted was very considerable—sufficient to measure the whole of Grayson's micrometer; if possible, cadmium light should be used. It would not be so easy to measure such long micrometers as those reported on by Dr. Spitta. He hoped at some future time to be able to show the principles of his apparatus, though the difficulties attendant upon

its exhibition as a working apparatus in the meeting hall would not show the actual calibration capacity.

Mr. Spitta said that they had just listened to a most interesting series of remarks; to him, however, the great difficulty seemed to be the enormous amount of practice required in the use of such an apparatus. It would, no doubt, appear easy enough to one who, like Mr. Beck, was *facile princeps* in the work, but there were difficulties connected with its use which to many seemed almost insurmountable; his own chief stumbling block, for instance, lay in the fact that there was no fixed standard, a difficulty which had especially appealed to him in dealing with the MacMahon micrometer. The main point, however, in all this class of work was, of course, to gain experience in the instrument which was being used, and at present they were not quite satisfied with their own experience.

Mr. Beck said that the MacMahon class of interferometer presented infinitely greater difficulties than an instrument capable of measuring a Grayson's micrometer. It was quite easy to count the number of wave-lengths in a distance of $\frac{1}{10000}$ in. or $\frac{1}{1000}$ mm., but it would obviously not be possible to count the number of wave-lengths in a yard with any success. The measurement had to be made by a step-by-step method, counting only the differences at each step. He thought that so far as calibrating a stage-micrometer went, the matter was comparatively simple so long as a sufficient amount of time were given to it.

The President said that Mr. Beck's method certainly sounded more tempting than that which entailed the enormous amount of labour spent by Mr. Spitta on this matter. He imagined that when Mr. Grayson had made his new screw, however, there would be still more work for Mr. Spitta. He considered that the very heartiest thanks of the Society should be accorded to Mr. Spitta for the great trouble he had taken over this important question.

The vote of thanks was carried with acclamation.

Mr. E. J. Sheppard read a communication on "The Re-appearance of the Nucleolus in Mitosis."

The President regretted that there was no time that evening to discuss many points of interest in Mr. Sheppard's paper, but wished to propose a very hearty vote of thanks for his communication; this was carried unanimously.

Dr. Eyre, in announcing a paper by Señor Domingo de Orueta on "Apparatus for Photomicrography with the Microscope standing in any position, especially in the Inclined Position," said that he would merely select for reading a few passages which appeared to him to present the salient features of the communication, leaving out those portions which dealt with the mechanism of the apparatus. The writer commenced by remarking on the inconvenience of having to carry the Microscope away from the working bench to the optical bench, in order to take a microphotograph, and discussed the difficulties of moving the apparatus; he then went on to describe a Microscope camera of his own design.

made by Zeiss, which would obviate these difficulties. The apparatus seemed to be a simple modification of Zeiss's vertical camera, the most important point apparently being the introduction of a reflection prism, placed over the eye-piece of the Microscope, and connected by a cylindrical collar fixed to the tube at the end of the camera. The worker apparently kept the camera on the work bench at the right-hand side of his Microscope, and the illuminating apparatus on his left, the camera pointing directly in front. As soon as he had found the object to photograph, the camera was swung round on its horizontal bar until the reflection prism approximated to the eye-piece of his Microscope. The length of the camera was small, 0·8 of a metre, so it was quite easy to reach the fine-adjustment of the Microscope even when the head of the investigator was round the corner looking at the ground-glass screen. The apparatus seemed useful for rapid work, but he (Dr. Eyre) did not think it likely to replace some of the larger pieces of apparatus, although the author stated he had obtained good results with a $\frac{1}{2}$ -in. immersion lens. The final point in favour of the apparatus seemed to be that the price was exceedingly low, as compared with that of ordinary installations.

A vote of thanks, proposed by the President, for this communication was carried unanimously.

Dr. Eyre said that the paper by Mr. James Murray on "Canadian Rotifers collected by the Shackleton Antarctic Expedition, 1909," would be taken as read, and would appear in the Journal in due course.

The next Meeting was announced for May 17, when there would be an exhibition of Pond Life. Fellows were invited to assist, and to send in their names to the Assistant-Secretary by May 10. A Meeting of the Biological Section was announced for Wednesday, May 3, to take place in the Laboratory of King's College, Strand.

With regard to the June Meeting, the President announced that as this would fall in Coronation Week, it had been suggested that it should be held either on the second or fourth Wednesday in June, instead of the third. The final date would be announced at the next Meeting.

The following Instruments, Objects, etc., were exhibited:—

- Mr. Conrad Beck: New pattern Microscope, "The Handle Microscope."
- Mr. E. J. Spitta: Microphotographs coloured by hand.
- Mr. E. J. Sheppard: The following slides in illustration of his paper:—
Chromatin Loops, Telophase Stages, *Triton*: Chromatin Loops, Telophase Stages, Hyacinth Root; Reappearance of Nucleolus in Chromatin Loop, Hyacinthus.

New Fellows. The following were elected *Ordinary* Fellows of the Society: Walter Mansfield Aders, Ernest A. Pinchin, Henry Syner, E. Wade Wilton.

MEETING

HELD ON THE 17TH OF MAY, 1911, AT 20 HANOVER SQUARE, W.
H. G. PLIMMER, ESQ., F.R.S., ETC., PRESIDENT, IN THE CHAIR.

The Minutes of the Meeting of April 19th were read and confirmed, and were signed by the President.

The following donations received since last Meeting were announced, and the thanks of the Society voted to the donors:—

	From
British Antarctic Expedition, 1907-9. Vol. I. Biology, Part VI. Rhizopodes d'Eau Douce, by Eugène Penard. (4to. London, 1911)	} <i>Sir E. H. Shackleton.</i>
J. E. Barnard, Practical Photomicrography. (8vo. London, 1911)	} <i>The Publisher.</i>
The Micrologist. Parts II.-IV. (Manchester, 1910-11), with two slides of subjects illustrated in Part IV., viz. <i>Amoeba</i> and <i>Sphaerocozium punctatum</i>	} <i>Mr. A. Flatters.</i>

Mr. Hopkinson referred to the scheme now brought forward to encroach upon the space allotted in 1899 to the Natural History Museum at South Kensington for the purpose of erecting a Science Museum. It was, he said, proposed to pull down the building containing specimens preserved in spirits, called the Spirit Room, erected at a cost of £30,000, to appropriate its site for part of the Science Museum, and to rebuild it in the Museum grounds on space which had been reserved for an extension of the zoological galleries, or, he had heard it suggested, remove it to Hendon. The Museum being already much cramped for room, the reduction of the area considered twelve years ago to be necessary for its expansion would be highly detrimental to biological science, and a Memorial against the proposal had been prepared, of which he read the two concluding paragraphs, suggesting its approval by the Society.

The President said that the point was whether the Society should sign the Memorial against this encroachment on the domain of the Natural History Museum. He thought that such a scheme as the above-mentioned would end in the probable destruction of the Natural History Museum as a scientific centre, and interfere with any scheme of enlargement, which might come under consideration, to enable students to carry on their studies there without difficulty. The relationship between the Royal Microscopical Society and the Natural History Museum was a close one; as a scientific Society their need of such a Museum was great, and he considered that any protest against a scheme likely to interfere with that relationship would be justifiable. He understood that the President and Honorary Secretaries of many other scientific societies had signed this petition on behalf of their various societies, and he desired Members of the Royal Microscopical Society to express their

views on the subject, and to say whether they also would give their sanction to its being signed on their behalf by the President and Secretaries.

Mr. Hopkinson then proposed the adoption of the Memorial by the Society, and that it be formally signed by the President and Secretaries.

Mr. Heron Allen seconded the proposal, and the motion was carried by general consent.

Mr. T. J. Smith, on behalf of Mr. F. W. Watson Baker, said he had been desired to bring to the notice of the Society models of microscopic fields of bacteria, which had been carefully prepared by Dr. Chas. Leo Birmingham, of Westport, Ireland. The models had been made with a view to their value when microscopic specimens of bacteria were not available.

Mr. E. Niemeyer said that, at the invitation of the Royal Microscopical Society, he wished to bring to their notice Mr. C. Reichert's "Dark Ground Illuminator with Arrangement for Centring on a Plain Stage"; he would not take up time by explaining all the advantages of this condenser, but would limit himself to making a few remarks only. The condenser is centred by means of a sliding clamp arrangement which fits into holes in the stage, and can be taken away and laid on one side or be replaced on the stage without having to be re-centred. It is provided with a circular diaphragm with several apertures and dark stops. The advantage is that it can be used with any kind of lamp, and be centred in a few minutes, and take no longer to exhibit a specimen under dark ground illumination than an ordinary microscopic demonstration.

The President accorded the thanks of the Society to Mr. Watson Baker and to Mr. Niemeyer for their communications.

Mr. Barnard described an apparatus for disintegrating bacteria and other organic cells.

The President remarked that it was a most ingenious instrument, but he would like to ask what really was the advantage of such an apparatus over the very old and simple method of grinding up one's material with sand? It seemed to him that so simple and efficacious a method might be preferable to the use of what appeared to be a somewhat complicated instrument.

Mr. Barnard replied that in the full communication which would appear in the Transactions of the Society he had attempted to explain the advantages of his disintegrating apparatus over any method in which sand or any similar material is used. The chief advantages are that rise of temperature is entirely obviated, as the process of disintegration is practically frictionless. Secondly, in his experience there was no apparatus in which sand was used where it was possible to avoid serious disintegration of the containing vessel itself, resulting in contamination of the cell-juice. Then, finally, the sand had to be removed, which

tended greatly to lengthen the process, and this also he considered should be avoided as far as possible. In his method the material could be inserted in the apparatus, ground without the addition of any extraneous substance, and in 20 minutes complete disintegration had taken place.

The President considered that his would-be objections had been effectually answered, and proposed that the thanks of the Society be accorded to Mr. Barnard for his communication.

The vote of thanks to Mr. Barnard was unanimously carried.

In regard to Mr. Butcher's paper on "Structural Detail of *Coscinodiscus asteromphalus*," the President said that the subject opened up so large a field for discussion from the microscopic and optical point of view that Mr. Butcher had kindly consented to postpone the paper until the October Meeting, when other opinions would be obtainable on this very important subject. He proposed that Mr. James Murray's paper on "Rotatoria of some Pacific Islands" should be taken as read, as the rest of the Meeting would be taken up in examining the exhibition of pond-life before them. He wished to express the thanks of the Society to Members who had assisted in bringing together so many beautiful and interesting specimens.

As, in the ordinary course of events, the June Meeting would fall in Coronation week, the next Meeting was announced for June 28th.

The following Instruments, Objects, etc., were exhibited :—

- Mr. J. E. Barnard :—Diagrams and photomicrographs in illustration of his paper on an apparatus for disintegrating bacteria.
- Mr. T. W. Butcher :—Photomicrographs in illustration of his paper on "Structural Detail of *Coscinodiscus asteromphalus*" to be read at the October Meeting.
- Mr. F. W. Watson Baker, Models of Microscopic Fields of Bacteria prepared by Dr. Chas. Leo Birmingham.
- Mr. E. Niemeyer :—Reichert's Dark Ground Illuminator with arrangement for centring on a plain stage.

Specimens of Pond-life, as follows :—

- Mr. F. W. Watson Baker :—*Volvox globator*.
- Mr. Jas. Barton :—*Myxomonas tenue*.
- Mr. F. W. Chippis :—*Corethra plumicornis*, Larva ; *Melicerta ringens*, *Paludicella chrenbergi*.
- Mr. E. J. E. Creese :—Floscules, etc.
- Mr. Edgar Cuzner :—*Lophopus crystallinus*, and Photomicrograph of mounted specimen.
- Mr. D. Davis :—*Volvox globator* ; *Stephanoceros cichhorni*.
- Mr. A. Downs :—*Euglena* ; *Volvox* ; *Hydra viridis*.
- Mr. J. Drinkwater :—*Quadrula symmetrica*.
- Mr. A. Hammond :—Micro drawings.

PROCEEDINGS OF THE SOCIETY.

- Mr. A. E. Hilton : Active Swarm-spores of *Reticularia lycoperdon*
500, illustrating the aquatic phase of the life-cycle of Mycetozoa.
Mr. J. Hopkinson : *Arcebia vulgaris* and other fresh-water Rhizopods.
Mr. J. Milton Offord :—*Diphata* ; *Floscularia cornuta*.
Mr. F. J. W. Plaskitt : *Fragillaria capucina*.
Mr. J. I. Pigg : Circulation of blood in tail of Tadpole.
Mr. T. H. Powell : Cyclosis in *Vallisneria*.
Mr. G. H. J. Rogers :—*Fredericella sultana* ; *Volvox globator*.
Mr. C. F. Rousselet : *Melicerta ringens*.
Mr. D. J. Scourfield : Various very minute Algæ, Flagellata, etc., ob-
tained by means of centrifuging pond water.
Mr. C. J. H. Sidwell :—*Euglena viridis* × 300.
Mr. T. J. Smith :—*Fredericella sultana*.
Mr. George Tilling :—*Hydra vulgaris* ; *H. viridis*.
Mr. W. R. Traviss :—Water Mite.

New Fellows :—The following were elected *Ordinary* Fellows of the Society :—Rev. Hilderic Friend, Mr. A. W. F. Warrington.

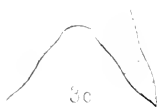
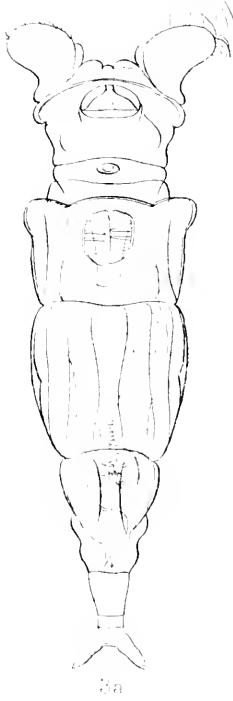

West, Newman photo-lith.

West, Newman photo-lith.

JOURNAL
OF THE
ROYAL MICROSCOPICAL SOCIETY.

AUGUST, 1911.

TRANSACTIONS OF THE SOCIETY.

XIII.—*Rotifera of some Pacific Islands: Collected by the Shackleton Antarctic Expedition, 1909.*

By JAMES MURRAY, F.R.S.E.

(Read May 17, 1911.)

PLATES XIV., XV.

Historical Sketch.—I have been able to gather very little information about the Rotifera of any Pacific islands. Ehrenberg, 1853 (1)*, notes two Bdelloids in the Galapagos Islands (*Callidina rediviva* and *C. triodon*). Semper, 1872 (3), discovered the remarkable *Trochosphaera* in the Philippines. Weber, 1906 (6), records three loricated Ploima from Honolulu. Richters, 1908 (5), among the material collected on Prof. Schauinsland's journey, found two Bdelloids, *Callidina angusticollis* and *C. perforata*, both in Samoa and in Oahu.

* The figures in brackets refer to the Bibliography at the end of paper.

EXPLANATION OF PLATE XIV.

- Fig. 1. — *Pleuretra brycei* (Weber), variety.
" 2a. Ditto. Another variety.
" 2b. Side view of ditto.
" 2c. Ditto. Foot.
" 3a.—*Callidina pacifica* sp. n.
" 3b. Ditto. Head.
" 3c. Ditto. Spurs.
" 4a.—*Philodina plena* (Bryce), variety.
" 4b. Ditto. Jaw.

Aug. 16th, 1911

2 F

FIJI: ISLAND OF VITI LEVU.

We had only a few hours for collecting in Suva, and no promising collecting ground was found in the neighbourhood of the town. In the circumstances, it is surprising that as many as twenty species of Bdelloids were distinguished, though several of them could not be identified.

LIST OF SPECIES COLLECTED.

<i>Philodina brevipes</i> Murray.	<i>Rotifer longirostris</i> (Janson).
<i>Pleureta brycei</i> (Weber).	<i>Habrotricha longiceps</i> (Murray).
<i>P. humerosa</i> (Murray).	<i>H. angusticollis</i> (Murray).
<i>Callidina habita</i> Bryce.	<i>H. constricta</i> (Duj.).
<i>C. quadricornifera</i> (Milne).	<i>H. nodosa</i> sp.n.
<i>C. pacifica</i> sp.n.	<i>Adineta vaga</i> (Davis).
<i>C. papillosa</i> (Thomp.).	<i>A. longicornis</i> Murray.
<i>C. multispinosa</i> (Thomp.)	

NOTES ON THE SPECIES.

Pleuretra brycei (Weber).

No drawing was made of the Fijian form, but it is noted that there was a second dorsal row of four spines. The number of lateral spines is not recorded.

Callidina quadricornifera (Milne).

Variety.—Very large (700 μ long), trunk thick-skinned, strongly stippled; teeth very thick. I only find the variety possessing all of these characters in warm climates.

Callidina papillosa (Thomp.)?

Variety.—Small, warts few, second trunk segment laterally prominent. It approaches *C. canadensis*, but is smaller.

Callidina multispinosa (Thomp.). Plate XV. figs. 6a, 6b.

Variety.—Short-spined, spines few except on the foot. On first trunk-segment one lateral spicule, and a broad process, dentate at the end; on second trunk-segment three short spines at each side; on central trunk no spicules except at the posterior angles: spines numerous on foot; teeth 2.

Resembling an Indian variety; remarkable for the reduction of spines on the central trunk, and the broad dentate processes on the first trunk-segment.

Callidina pacifica sp. n. Plate XIV. figs. 3a-3c.

Specific Characters.—Small, pale brown. Corona large, wider than trunk, sulcus wide, antenna very short. Trunk normally

wedge-shaped, tapering from first segment to anal. Teeth 2. Foot short, 4-jointed; spurs large, broad, with small interspace, dotted; toes large.

Length, when feeding, with the foot drawn in, $200\ \mu$; width of corona $75\ \mu$, trunk $65\ \mu$, across spurs $30\ \mu$. Sulcus about equal to disk, collar prominent, lobes on upper lip reaching to level of bridge, slightly separated by convex interspace. Rostrum short, antenna less than half of neck width. Anterior trunk generally wider than central trunk. Trunk regularly plicate. Pre-anal and anal segments distinct, of equal length. Spur broad, blade-shaped, slightly contracted midway and expanded again towards apex, which is subacute.

Not closely related to any other species. The spurs suggest a relationship to some of the *Embata* (*E. laticeps*, etc.), but there are distinctly only three toes, which are large, like those of *Rotifer*.

Habrotrocha nodosa sp. n. Plate XV. figs. 8a-8f.

Synonym *Callidina crenata* var. *nodosa* Murray.*

Specific Characters.—Small, whitish; trunk covered with large tubercles, in regular transverse and longitudinal rows; teeth many, fine; foot short, three-jointed, a boss on the first joint; spurs small, obtuse or subacute.

Length $220\ \mu$ - $250\ \mu$, width of neck $40\ \mu$, trunk $65\ \mu$, across spurs $10\ \mu$. Rostrum short, broad; antenna three-quarters of neck width; jaw triangular, number of teeth uncertain, anterior thickest, then diminishing rapidly to fine striae—seven or eight can be counted. Disks, in creeping animal, small, not separated. Neck smooth, rounded processes on each side of antenna. Tubercles about 6 - $9\ \mu$ in diameter (largest in Indian examples), about three rows in the length of each segment. Pre-anal segment tubercled; anal smooth, but with one pair of lateral tubercles (in Indian examples all tubercled).

The large tubercles appear to be constant, and sufficiently distinguish the species from all others in the genus.

Habitat.—Fiji; India; Madagascar. First found in India, and described as a variety of *H. crenata* (Murray).

Habrotrocha sp.? Plate XV. figs. 9a-9c.

Very small ($140\ \mu$ in length), rostrum and antenna short. First neck-segment the widest part of body; neck and trunk behind that of nearly uniform width. Jaw triangular, with many fine teeth, diminishing. Spurs small, incurved. An incomplete study, but certainly distinct. It is a curious paradox that the "neck" should be the widest part. I only know one smaller Bdelloid—*H. minuta* is much smaller, measuring only $77\ \mu$ in length.

* See this Journal, 1906, p. 641, pl. xix. figs. 6a-5c.

HAWAII: ISLAND OF OAHU.

A whole day was spent in Honolulu, and about half of that time was available for collecting. There was time to get a few miles out of the town and into some very dense but low bush. Everything was extremely dry, but there was a good deal of moss on the trees and rocks, and this proved fairly productive when examined some time afterwards.

LIST OF SPECIES COLLECTED.

<i>Philodina brevipes</i> Murray.	<i>M. russeola</i> (Zel.).
<i>P. rugosa</i> Bryce.	<i>Rotifer longirostris</i> (Janson).
<i>P. plena</i> (Bryce).	<i>Habrotrocha pusilla</i> (Bryce).
<i>P. vorax</i> (Janson).	<i>H. angusticollis</i> (Murray).
<i>Pleuretra brycei</i> (Weber).	<i>H. longiceps</i> (Murray).
<i>Callidina habita</i> Bryce.	<i>H. perforata</i> (Murray).
<i>C. plicata</i> Bryce.	<i>H. caudata</i> Murray.
<i>C. punctata</i> Murray.	<i>H. constricta</i> (Duj.).
<i>C. quadricornifera</i> (Milne).	<i>H. leitgebii</i> (Zel.).
<i>C. ehrenbergii</i> Janson.	<i>H. auriculata</i> Murray.
<i>C. multispinosa</i> (Thomp.).	<i>Adineta ruga</i> (Davis).
<i>Mniobia symbiotica</i> (Zel.).	<i>A. gracilis</i> Janson.

NOTES ON THE SPECIES.

Philodina plena (Bryce). Plate XIV. figs. 4a-4b.

Variety.—Differing from the type in having more numerous teeth, 3 + 1 or 4 in each jaw.

Pleuretra brycei (Weber). Plate XIV. figs. 1 and 2a-2c.

Variety (fig. 1).—Spines on the anterior margin of the trunk, forming the furca for the antenna, moderately large; the others on the anterior margin very small. Main dorsal series of ten spines;

EXPLANATION OF PLATE XV.

- Fig. 5. — *Callidina multispinosa* (Thomp.), variety.
 .. 6a. Ditto. Short-spined variety.
 .. 6b. Ditto. Jaw.
 .. 7. — *Rotifer longirostris* (Janson), var. *fimbriata* Murray.
 .. 8a. — *Habrotrocha nodosa* sp. n.
 .. 8b. Ditto. Jaw.
 .. 8c. Ditto. Side view of foot.
 .. 8d. Ditto. Spurs.
 .. 8e. Ditto. Slightly different spurs.
 .. 8f. Ditto. Contracted.
 .. 9a. — *Habrotrocha* sp. (?).
 .. 9b. Ditto. Jaw.
 .. 9c. Ditto. Spurs.

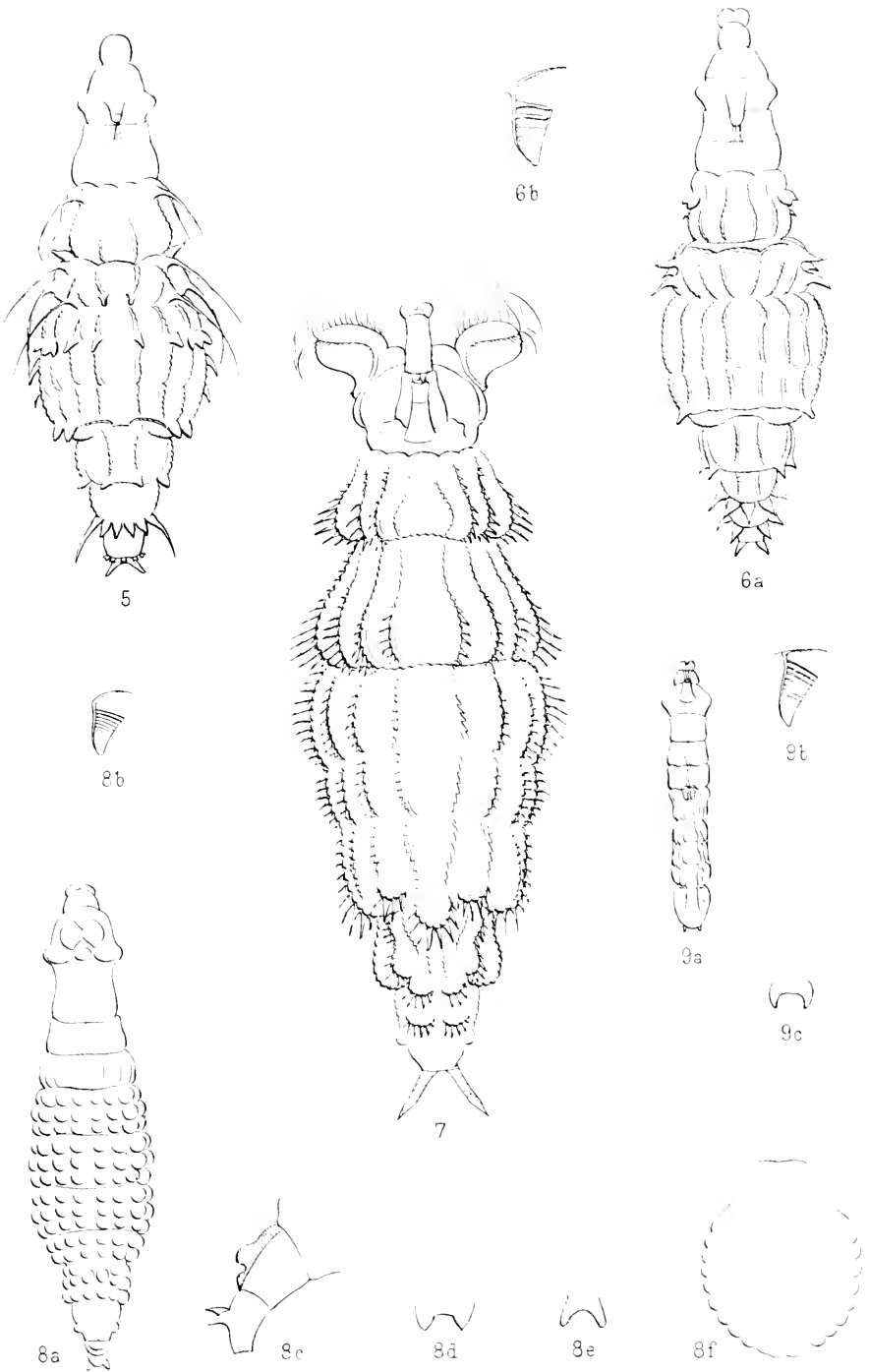

J Murray del. ad nat.

West, Newman photo-lith.

lateral spines three on each side; second dorsal series of four spines; two spines on rump.

Variety (figs. 2*a*-2*c*).—Spines on anterior border of trunk all small. Main dorsal series of ten spines; lateral spines four on each side; second dorsal series of two spines, widely separated; two spines on rump; a transverse ridge on first foot-joint.

The Hawaiian varieties are chiefly remarkable for the increase in the number of lateral spines—no other variety is known with more than two on each side. There is a variety in Scotland which has the second dorsal series of two spines widely separated, as in the second Hawaiian variety.

Callidina punctata Murray.

A rare species, apparently confined to warm countries. Discovered in Africa in 1910, and now known in Australia and Hawaii.

Callidina multispinosa (Thomp.). Plate XV. fig. 5.

Variety.—Having long setæ, short spicules, knobs, and pectinate processes. On each side five long setæ on the anterior trunk. In the angle between the first and second trunk-segments a short acuminate process. Transverse dorsal row, at widest part of trunk, of small spicules, but the processes at the ends of the row broad and pectinate or dentate. Processes at posterior angles of trunk and on rump thick conical knobs. On the foot a pair of lateral setæ, with bulbous bases, and a transverse series of small truncate or bifid processes.

The chief peculiarity is the pectinate processes on the central trunk. A short-spined variety from Fiji has similar processes on the anterior trunk.

Rotifer longirostris (Janson) var. *fimbriata* Murray.

Plate XV. fig. 7.

The Hawaiian form is remarkable for the great elongation of the processes, which suggested the name *fimbriata*. They are longest at the widest part of each segment, and there attain to a length of 10 or 12 μ .

Had this extreme form been first discovered, no doubt it would have been regarded as a distinct species. The firm sharp processes might not have been recognized as the product of secretion.

These rod-like projections appear to be of the same nature as those secreted by *Dissotrocha macrostyla* and some other species, but they show no tendency to cohere to form tubercles. This is probably because the secretion is of a kind which hardens more quickly.

The strongest arguments for this form being specifically distinct from *R. longirostris* are found in the decidedly more nodose trunk,

the first and second trunk-segments and the pre-anal being especially prominent, and in certain hemispherical processes on the rump, which have not been seen in the type.

Habrotrocha pusilla (Bryce).

The Hawaiian form is the one with very thick case of many layers.

Habrotrocha caudata Murray, and *H. auriculata* Murray.

Both these species were only recently discovered in Africa, and afterwards in Australia and Hawaii.

Habrotrocha perforata (Murray).

It is noted that in Hawaii the examples of this species were considerably larger than the type, but the exact measurements are not given.

LIST OF ALL BDELLOIDS RECORDED FOR PACIFIC ISLANDS.

	Fiji.	Hawaii.	Samoa.	Galapagos.
<i>Philodina brevipes</i> Murray	×	×		
<i>P. rugosa</i> Bryce		×		
<i>P. plena</i> (Bryce)		×		
<i>P. vorax</i> (Janson)		×		
<i>Pleuretra brycei</i> (Weber)	×	×		
<i>P. humerosa</i> (Murray)	×	×		
<i>Callidina habita</i> Bryce	×	×		
<i>C. plicata</i> Bryce		×		
<i>C. punctata</i> Murray		×		
<i>C. quadricornifera</i> (Milne)	×	×		
<i>C. chrenbergii</i> Janson		×		
<i>C. pacifica</i> sp. n.	×	×		
<i>C. papillosa</i> (Thomp.)	×	×		
<i>C. multispinosa</i> (Thomp.)	×	×		
<i>C. rufiviva</i> Ehr.				×
<i>C. triodon</i> Ehr.				×
<i>Monobu symbiotica</i> (Zel.)		×		
<i>M. ruscobla</i> (Zel.)		×		
<i>Edifier longirostris</i> (Janson)	×	×		
<i>Habrotrocha pusilla</i> (Bryce)		×		
<i>H. angusticollis</i> (Murray)	×	×	×	
<i>H. longiceps</i> (Murray)	×	×		
<i>H. perforata</i> (Murray)		×	×	
<i>H. caudata</i> Murray		×		
<i>H. constricta</i> (Daj.)	×	×		
<i>H. batyebi</i> (Zel.)		×		
<i>H. nodosa</i> sp. n.	×	×		
<i>H. auriculata</i> Murray		×		
<i>Aimeta vaua</i> (Davis)	×	×		
<i>A. gracilis</i> Janson		×		
<i>A. longicornis</i> Murray	×			

SUMMARY.

In Fiji, fifteen Bdelloids were identified; in Hawaii, twenty-four—ten were found in both groups of islands. There were very few peculiar species or varieties; Fiji has most peculiar forms. Two new species are described, but *H. nodosa* was previously known elsewhere, and described as a variety. There were also in Fiji several other undescribed species, but they were not sufficiently studied. There was a slightly peculiar form of *C. multispinosa* var. *brevispinosa*.

In Hawaii there were no peculiar species, but peculiar varieties of *P. brycei*, *C. multispinosa*, and *R. longirostris*. There was one species, evidently distinct, strongly coloured in yellow and red but the study was not completed.

The Bdelloids, even of Fiji and Hawaii, are insufficiently known to allow of their distribution in other lands being profitably discussed. The species are nearly all common. Besides the peculiar species and varieties, there are only three which are not known to be widely distributed. They are *C. punctata* *H. caudata*, and *H. auriculata*; these three have the same distribution, being only known in Africa, Australia, and Hawaii.

BIBLIOGRAPHY.

1. EHRENBERG, C. G.—Süsswasserleben der Galapagos-Inseln. Verh. k. Akad. Wiss. Berl. (1853) p. 178.
2. " " " Mikrogeologie. Leipzig (1854).
3. SEMPER, C.—Zoologische Aphorismen. Zeit. f. wiss. Zool. xxii. (1872) p. 311.
4. " " *Trochosphara equatorialis*. (A translation of the above paper.) Month. Micr. Journ. (Nov. 1875) p. 237.
5. RICHTERS, F.—Moosfauna Australiens, etc. Zool. Jahrb. Abt. für. Syst. xxvi. (1908) p. 196.
6. WEBER, E. F.—Rotateurs. (Voyage du Dr. Walter Volz.) Zool. Jahrb. Abt. für Syst. xxiv. (1906) p. 207.

XIV.—*On the Recent and Fossil Foraminifera of the Shore-sands of Selsey Bill, Sussex.*—VIII. *Tabular List of Species and Localities.*

BY EDWARD HERON-ALLEN, F.L.S., F.R.M.S.,
and ARTHUR EARLAND, F.R.M.S.

(Read February 15, 1911.)

THE examination of the material gathered from the Selsey shore-sands having occupied the whole of our available leisure for three years, it is not extraordinary that many species have come to light after we had dealt with their genera in the accepted zoological sequence. The following list is therefore appended to our series of papers by way of index to the series. The figures in the second column refer to the numbers under which each species will be found described in the pages of the Journal.

The letter E signifies that the species was recorded by Earland in 1905 from the shore-sands of the neighbouring locality, Bognor.*

It will be observed that the species found on the east shore of Selsey Bill are remarkably few. Several gatherings have been made "above the Park Beds," but on examination they have proved to contain little beyond molluscan fragments. Why this should be the case we cannot attempt to explain at present. The most exhaustive examinations have been made of the material "Opposite Bungalows," where a monthly gathering has been made for more than a year; at "S.E. Medmerry Farm," where a remarkable gathering was made in April, 1909, richer in rare forms than any other gathering made on this coast; and "Above the Housepond Beds"; whilst the Chalk Foraminifera have received especial attention. The "Blue Band," which was exposed for two days in June, 1908, has never been seen again. Fortunately, an ample supply of material was secured on this occasion; and it will be observed that though the Foraminifera were abundant, they are all referable to less than fifty species. They are, however, without exception, extraordinarily beautiful, being casts in pure pyrites of a rich golden-bronze.

The Pleistocene Mud deposit opposite Medmerry Farm, the contents of the Giant *Pholas* shells found among the Pleistocene Flints between West Street and Medmerry, and the long series of samples from the 100-ft. Artesian Well Boring at "Large Acres," present geological features and problems which must be left for discussion at a future date. We have preferred, for the present, to leave these three deposits out of the scope of the series of papers of which this is the terminal instalment.

* Journ. Quekett Micr. Club, 1905, p. 187.

New Serial Number.	Original Number.	CATALOGUE OF SPECIES.	Preliminary Examination of 1000 c.c.m.													
			1	2	3	4	5	6	7	8	9	10	11	12	13	14
		Family ASTRORHIZIDÆ.														
		Sub-family Astrorhizinæ.														
66	316	<i>Pelosina variabilis</i> Brady ..			×			×								
		Sub-family Saccammininæ.														
67	44	<i>Psammosphæra fusca</i> Schulze	×							×	×		×			
68	45	<i>Saccamina sphærica</i> M. Sars	×					×	×				×	×		
		Sub-family Rhabdammininæ.														
69	317	<i>Hyperammia vagans</i> Brady (E.)			×			×		×						
		Family LITUOLIDÆ.														
		Sub-family Lituolinæ.														
70	318	<i>Reophaz ampullacea</i> Brady..			×											
71	319	<i>R. fusiformis</i> Williamson ..			×											
72	46	<i>R. moniliforme</i> Siddall ..	×		×			×	×	×			×	×		
73	226	<i>R. scorpiurus</i> Montfort ..						×	×	×						×
74	47	<i>Haplophragmium agglutinans</i> d'Orbigny sp.	×	×	×	×	×	×	×	×	×					
75	48	<i>H. canariense</i> d'Orbigny sp. (E.)	×		×	×	×	×	×	×	×	×	×	×		
76	227	<i>H. fontinense</i> (Terquem) ..			×											×
77	228	<i>H. inflatum</i> Reuss								×						×
78	320	<i>H. latidorsatum</i> Bornemann								×						
79	321	<i>H. nanum</i> Brady			×											
80	49	<i>H. neocomianum</i> Chapman ..	×					×	×	×	×	×	×	×		×
		Sub-family Trochammininæ.														
81	50	<i>Thurammia papillata</i> Brady (E.)	×	×					×		×		×			
82	51	<i>Ammodiscus gordialis</i> Jones and Parker sp. (E.)	×				×		×	×	×		×	×		
83	52	<i>A. incertus</i> d'Orbigny sp. (E.)	×						×							×
84	53	<i>Trochammia inflata</i> Montagu sp. (E.)	×	×	×	×				×	×	×	×	×	×	
85	54	<i>T. squamata</i> Jones and Parker (E.)	×		×					×	×		×	×		
86	322	<i>T. rotaliformis</i> J. Wright (MS.)											×			
87	55	<i>Webbina hemisphærica</i> Jones, Parker, and Brady	×					×					×			
88	229	<i>W. irregularis</i> d'Orbigny ..							×							×

New Serial Number	Original Number	CATALOGUE OF SPECIES.	Preliminary Examination of 1000 c.c.m.	Above the "Park" Beds.	Mixon Rocks, Detritus and Mud.	"Kerk Arrow" Spkt.	Opposite Marine Hotel, Opposite Bungalows.	Above the "Selsey" Beds.	Opposite Thorney Coast-guard Station.	S. E. Medmerry Farm.	N. W. Medmerry Farm.	Above the "House-pond" Beds.	West Witterling to Earmley.	The "Blue Band."	Chalk from Flints and Shore-sand.	
			1	2	3	4	5	6	7	8	9	10	11	12	13	14
241	284	<i>Cristellaria vortex</i> Fichtel and Moll														X
242	286	<i>Flabellina baudouiniana</i> d'Orbigny														X
243	288	<i>F. interpunctata</i> von der Marek														X
244	285	<i>F. pulchra</i> d'Orbigny														X
245	287	<i>F. rugosa</i> d'Orbigny														X
		Sub-family Polymorphininae .														
246	355	<i>Polymorphina acuminata</i> Williamson						X	X	X		X				
247	125	<i>P. angusta</i> Egger	X													
248	130	<i>P. communis</i> d'Orbigny	X	X					X	X		X				
249	128	<i>P. complanata</i> d'Orbigny	X			X			X	X		X				
250	127	<i>P. compressa</i> d'Orbigny (E.)	X		X				X	X		X				X
251	122	<i>P. concava</i> Williamson (E.)	X								X	X				
252	129	<i>P. elegantissima</i> Parker and Jones	X			X		X	X	X		X		X		
253	123	<i>P. gibba</i> d'Orbigny	X	X	X	X	X	X	X	X		X		X	X	X
254	137	<i>P. hirsuta</i> Brady, Parker, and Jones	X					X				X				
255	120	<i>P. lactea</i> Walker and Jacob sp. (E.)	X	X		X	X	X	X	X		X		X	X	X
256	356	<i>P. lactea</i> var. <i>amygdaloides</i> Reuss										X				
257	126	<i>P. lanceolata</i> Reuss (E.)	X					X	X	X		X				
258	132	<i>P. myristiformis</i> Williamson	X				X					X				
259	121	<i>P. oblonga</i> Williamson (E.)	X					X		X		X				
260	133	<i>P. ornata</i> Karrer	X									X				
261	357	<i>P. problema</i> d'Orbigny			X							X				
262	135	<i>P. regina</i> Brady, Parker, and Jones (E.)	X		X	X	X	X	X	X		X		X		
263	131	<i>P. rotundata</i> Bornemann sp. (E.)	X		X	X	X	X	X	X		X		X		
264	124	<i>P. sororia</i> Reuss	X		X	X	X	X	X	X		X		X		X
265	136	<i>P. spinosa</i> d'Orbigny sp.	X									X				
266	358	<i>P. thoini</i> d'Orbigny			X							X				
267	134	<i>P. tuberculata</i> d'Orbigny	X		X			X	X	X		X				
268	359	<i>Dimorphina longicollis</i> Brady sp.						X				X				
269	139	<i>Urigerina angulosa</i> Williamson (E.)	X		X		X	X	X	X		X		X		
270	360	<i>U. asperula</i> Czjzek (E.)						X	X	X		X				X
271	138	<i>U. asperula</i> Czjzek var. <i>ampullacea</i> Brady										X				
272	289	<i>U. canariensis</i> d'Orbigny (E.)			X							X				X
273	140	<i>U. muralis</i> Terquem	X		X			X	X	X		X		X		X
274	290	<i>U. pygmaea</i> d'Orbigny									X	X				X
275	141	<i>U. selseyensis</i> sp. n.	X			X	X	X	X	X		X				

New Serial Number.	Original Number.	CATALOGUE OF SPECIES.	Preliminary Examination of 1000 c.cm.													
			1	2	3	4	5	6	7	8	9	10	11	12	13	14
276	361	<i>Sagrina asperula</i> Chapman . . .	×													
277	291	<i>S. cretacea</i> sp. n.														×
278	362	<i>S. dimorpha</i> Parker and Jones										×				×
		Sub-family Ramulininæ .														
279	292	<i>Ramulina aculeata</i> d'Orbigny sp.														×
		Family GLOBIGERINIDÆ .														
280	294	<i>Globigerina æquilateralis</i> Brady											×			×
281	142	<i>G. bulloides</i> d'Orbigny (E.) . .	×	×			×	×	×	×			×			×
282	143	<i>G. cretacea</i> d'Orbigny	×			×		×	×		×		×			×
283	145	<i>G. dutertrei</i> d'Orbigny													×	×
284	144	<i>G. linnæana</i> d'Orbigny sp. . .	×										×			×
285	293	<i>G. marginata</i> Reuss					×						×			×
286	146	<i>G. pachyderma</i> Ehrenberg sp.	×				×				×		×			×
287	295	<i>Orbulina universoni</i> d'Orbigny												×	×	×
288	296	<i>Sphæroidina bulloides</i> d'Orbigny (E.)												×	×	×
		Family ROTALIDÆ .														
		Sub-family Spirillinæ .														
289	148	<i>Spirillina inæqualis</i> Brady . .	×													
290	149	<i>S. limbata</i> Brady	×													×
291	363	<i>S. lucida</i> Sidebottom										×				
292	150	<i>S. margaritifera</i> Williamson . .										×				
293	151	<i>S. selseyensis</i> sp. n.	×									×				
294	147	<i>S. vivipara</i> Ehrenberg (E.) . .	×				×	×	×	×	×	×	×			
		Sub-family Rotalinæ .														
295	152	<i>Patellina corrugata</i> Williamson (E.)	×							×					×	
296	170	<i>Discorbina allomorphinoides</i> Reuss sp.	×				×							×	×	
297	364	<i>D. araucana</i> d'Orbigny	×				×							×		
298	365	<i>D. bertheloti</i> d'Orbigny (E) . .	×											×		
299	167	<i>D. biconcava</i> Parker and Jones	×											×		
300	171	<i>D. cristata</i> sp. n.	×											×		
301	166	<i>D. dimidiata</i> Jones and Parker	×		×	×	×	×	×	×	×	×	×	×	×	
302	366	<i>D. eximia</i> Hantken												×		
303	154	<i>D. globularis</i> d'Orbigny sp. (E.)	×					×	×					×		
304	367	<i>D. inæquilateralis</i> sp. n. . . .						×	×					×		
305	159	<i>D. isabelleana</i> d'Orbigny sp.	×				×	×	×	×	×	×	×	×	×	
306	368	<i>D. nitida</i> Williamson			×		×	×	×	×	×	×	×	×		

New Serial Number.	Original Number.	CATALOGUE OF SPECIES.	Preliminary Examination of 1000 c. cm.													
			1	2	3	4	5	6	7	8	9	10	11	12	13	14
346	187	<i>A. grosserugosa</i> Gümbel sp. (E.)	×													
347	379	<i>Pulvinulina auricula</i> Fichtel and Moll (E.)	×										×			
348	380	<i>P. brongniartii</i> d'Orbigny	×			×		×	×		×	×	×	×	×	
349	189	<i>P. concentrica</i> Parker and Jones (E.)	×										×			
350	381	<i>P. crassa</i> d'Orbigny	×								×		×			
351	198	<i>P. elegans</i> d'Orbigny sp.	×	×				×	×		×		×			
352	195	<i>P. exigua</i> Brady	×										×			×
353	382	<i>P. haliotidea</i> sp. n.	×										×			
354	192	<i>P. hauerii</i> d'Orbigny (E.)	×		×		×	×	×		×	×	×			×
355	197	<i>P. karsteni</i> Reuss sp. (E.)	×										×			×
356	383	<i>P. lateralis</i> Terquem	×										×			×
357	193	<i>P. menardii</i> d'Orbigny sp. (E.)	×		×			×	×		×		×	×	×	
358	191	<i>P. oblonga</i> Williamson sp.	×										×			
359	188	<i>P. punctulata</i> d'Orbigny sp.	×										×			×
360	384	<i>P. repanda</i> Fichtel and Moll	×										×			
361	385	<i>P. repanda</i> var. <i>concamerata</i> Montagu	×										×			×
362	196	<i>P. schreibersii</i> d'Orbigny sp.	×					×	×							
363	386	<i>P. reticulata</i> Reuss	×					×	×							
364	199	<i>P. semimarginata</i> d'Orbigny	×					×	×				×			
365	194	<i>P. truncatulinoides</i> (syn. <i>micHELINIANA</i> d'Orbigny)	×				×		×				×	×	×	×
366	387	<i>P. tumida</i> Brady	×										×			
367	388	<i>P. umbonata</i> Reuss	×										×			
368	190	<i>P. vermiculata</i> d'Orbigny sp.	×						×				×			
369	200	<i>Rotalia beccarii</i> Linné sp. (E.)	×	×	×		×	×	×		×		×	×	×	×
370	203	<i>R. exsculpta</i> Reuss	×										×			×
371	205	<i>R. calcar</i> d'Orbigny (E.)	×					×	×		×		×	×	×	×
372	298	<i>R. clementiana</i> d'Orbigny	×					×	×		×		×	×	×	×
373	201	<i>R. orbicularis</i> d'Orbigny	×	×					×				×	×	×	×
374	202	<i>R. soldanii</i> d'Orbigny	×					×	×		×		×			×
375	204	<i>R. suessonensis</i> d'Orbigny	×					×	×		×		×			×
Sub-family Tinorporinae.																
376	206	<i>Gypsina inhaerens</i> Schultze sp. (E.)	×		×		×	×	×		×	×	×	×	×	×
377	207	<i>Polytrema miniacum</i> Linné sp.	×					×	×		×	×	×	×	×	×
Family NUMMULINID.E.																
Sub-family Polystomellinae.																
378	212	<i>Nonionina asterizans</i> Fichtel and Moll sp. (E.)	×				×				×	×		×	×	×
379	213	<i>N. boueana</i> d'Orbigny	×										×			×
380	208	<i>N. depressula</i> Walker and Jacob sp. (E.)	×	×				×			×	×	×	×	×	×

XV.—*A Report on the Grayson's Rulings presented by Mr. C. Beck to the Royal Microscopical Society.*

By E. J. SPITTA.

(Read April 19, 1911.)

SOME months ago the Council requested me to examine and report upon two sets of rulings by Grayson—an inch divided into hundredths and a millimetre with divisions of 0·25—gifts to the Society by Mr. Conrad Beck.

The examination presented many difficulties not anticipated at the commencement, one being the selection of a suitable arrangement that could not possibly shift or change in any way whilst in use from day to day during the necessarily protracted observations. Several hundreds of experimental measures extending over a somewhat lengthy period were made before the arrangement finally adopted was perfected and accepted as satisfactory in all respects. Then, again, owing to the fact that no standard inch or millimetre scales were in existence, no comparisons with such standards could be made, and only observations of a differential nature therefore could be carried out. To make these measures as effective as possible, before settling down to obtain the final results, several preliminary experiments were tried with different objectives and oculars to ascertain what optical combination lent itself as most suitable to the subject in hand; and many suggestions and ideas were discussed with Mr. Conrady, who very kindly associated himself with the work, and who is responsible for the reductions of all the measures, so that the best possible information could be obtained therefrom.

It may be well to point out here that, owing to the actual size of the spaces, it was impossible to span (at least with a satisfactory definition at the edges of the field) more than two intervals of the scales on either side of the fixed thread of the screw micrometer used, hence in a mathematical point of view only approximate determinations of the progressive errors (about to be mentioned) in the scale could be hoped for.

It may now be at once mentioned that the probable error of one *single* setting was found to be $\pm 0\cdot124 \mu \frac{1}{250000}$ in. in the millimetre scale, and $\pm 0\cdot2 \mu \frac{1}{125000}$ in. in the case of the inch; but as in the final observations each interval was really measured six times, the results were correspondingly more accurate, having errors of $\pm 0\cdot05 \mu \frac{1}{500000}$ in. and $\pm 0\cdot08 \mu \frac{1}{312500}$ in. respectively, which compare very favourably with other published observations on scales of this type.

The general results of the examination of the half of each of the scales show that they are remarkably free from accidental errors in division, which probably do not reach $1\ \mu$ anywhere, and that they are therefore eminently fitted to become standard scales. There is, however, a very systematic and progressive error in the divisions of both scales (i.e. in the halves examined) which could not be overlooked. It consists in the graduations becoming *wider and wider apart* from the beginning of the scale in each case; and this error seems quite unmistakable, being far in excess of any conceivable error of observation, a millimetre in one instance or $\frac{1}{25}$ in. in the other, *in the centre of their respective scales*, being on an average about $1\ \mu$ (or $\frac{1}{10}$ p.c.) *longer* than a millimetre or $\frac{1}{25}$ in. at the *beginning*.

The absolute value of at least one of the scales must also be considerably in error, for from the mean of all the measures the ratio of Grayson's millimetre to Grayson's inch was found to be:—

$$25\cdot369 : 1$$

instead of being

$$25\cdot400 : 1$$

which is the correct ratio, Grayson's ratio being wrong to the extent of one part in 800.

It would appear, however, highly desirable that at least one of these scales be sent to the National Physical Laboratory, when they are ready to carry out such determinations, to be accurately standardized—anyhow over its first half of graduations, which seems sufficient for all useful purposes—after which it would be of great value and an excellent addition to the resources of the Society.

XVI.—*On some New Objectives and Eye-pieces by R. Winkel, of Gottingen.*

By EDWARD M. NELSON.

(Read March 15, 1911.)

LATELY, a packet of objectives and eye-pieces by Winkel, of Gottingen, was sent to me by Messrs. Angus and Co. for examination, and as some points that are new to "microscopy" were found, a description may be of interest.

First, Winkel divides both his object-glasses and eye-pieces into three groups; thus his objectives are achromatic, fluorite, and apochromatic, and his eye-pieces Huyghenian, complanatic, and compensating.*

The achromatic and fluorite objectives are of much interest, as they are not more or less copies of the productions of others, but have an individuality distinctly their own. To explain this it will be necessary to give a little history of the modern objective. Before the introduction of Jena glass the outstanding secondary spectrum of the old English achromat consisted of claret, or port-red, and apple-green colours. This was always looked for by experts, and its presence was thought to denote perfect correction. About 1870 (or a year or so later), Tolles, in America, altered the correction, and produced some very fine object-glasses with a flaring bright red, or crimson spectrum. I well remember seeing a *Podura* scale shown with one of these glasses, a very brilliant lens, and a strong diatom resolver; the exclamation marks shone out like rubies, whereas if they had been viewed through an English objective of that date (Lister formula) the exclamation marks would have been seen with a more purple tint, something like an amethyst.

About 1886, when Jena glass was introduced, an entirely new set of phenomena appeared, pale glasses, and those which gave decidedly bluish tints—which any expert of those days would have unhesitatingly condemned—were found to be not only strong diatom resolvers, but also to give sharp and bright pictures. For a time, experts, until they had learnt the effect of the reduction of the secondary spectrum by these new corrections, were all at sea, and did not know where they were.

To-day, there is in my cabinet one of these Jena glass semi-apochromats, which has such a violent purple secondary spectrum that it can be seen even when a peacock-green glass is used, a more

* Winkel's Catalogue (English edition).

monochromatic fluid screen being required to shut the blue part of the purple out! * Yet this lens gives particularly sharp images, and is a very strong diatom resolver. Now, however, Herr Winkel has revived the American red corrections with Jena glasses. The result is excellent, for brighter, sharper, or, for their apertures, stronger resolving object-glasses will not be found. This red correction is peculiarly suitable, because a peacock-green glass screen turns red into black, and so makes a strongly contrasted image. When the *Podura* was first examined with the $\frac{1}{7}$ of 0.85 N.A., for the moment it was difficult to exclude the idea that one of the American red objectives was not on the nose-piece.

Leaving the achromats, we come to the fluorites.† These form a beautifully corrected series of object-glasses—indeed, they might appropriately be termed $\frac{7}{8}$ apochromats, so small is the outstanding secondary colour; what there is, is of the same red tint. These glasses give exceptionally brilliant and sharp images. The 1.8 mm. fluorite oil-immersion gave an image that was only surpassed by a very superior apochromat; the 8.5 mm. is also a beautiful objective.

All these glasses are, as they ought to be, extremely sensitive to tube-length, a very little amount either one way or another is sufficient to make or mar the image; the tube-length, be it noted, is 170 mm., an increase of 10 mm. in the right direction, for which we ought to be thankful. All the object-glasses were tested both by daylight as well as by lamp-light, in order that their chromatic conditions should be thoroughly explored.

Now, as to the eye-pieces, those of the compensating series are of the usual over-corrected type, and are carefully adjusted for the corrections of the object-glasses, a condition which, it is to be feared, is not always satisfied. As regards the next series, a new word, "complanat," has been coined to denote this new eye-piece. It is of the Huyghenian type, but differs from it in being strictly achromatic, and in having a perfectly flat field. The examination of a microphotograph of printed matter under a low power will at once demonstrate the superiority of this form of eye-piece. Complanat No. 5, compensating $\times 18$ for the long tube, and compensating $\times 12$ for the short tube, have about the same power.

In conclusion, Winkel's high finish is still preserved; never has such beautifully finished brass and glass work been put into a Microscope objective; it is not only a pleasure to look through it, but, to any one taking an interest in this kind of work, it is also a pleasure to look at it. It is finish, and not polish, which is meant. It has been said that Wanschaff (alas! now no more) and Winkel hold a record against the world for their magnificent brass work.

* A delicate test for colour is the raphæ of a Cherryfield *Rhomboides*, when mounted in balsam, guinidine, or styrax.

† Winkel claims priority for the introduction of this class of objective.

SUMMARY OF CURRENT RESEARCHES
RELATING TO
ZOOLOGY AND BOTANY
(PRINCIPALLY INVERTEBRATA AND CRYPTOGAMIA),
MICROSCOPY, ETC.*

ZOOLOGY.

VERTEBRATA.

a. Embryology. †

Mendelism.‡—R. C. Punnett has revised and enlarged his well-known exposition of Mendelism. It is, indeed, almost a new book, with all the good qualities of the previous editions on a larger canvas. Within the last six years there have been many discoveries (in which the author has shared) in Mendelian investigation, and these are illustrated in this admirable book, the lucidity of which is past praise. We may refer to the parts dealing with the "interaction of factors," the new view of reversion, the re-interpretation of man's achievements in the origin of domesticated varieties, the Mendelian theory of sex. Very welcome, we should think, to many will be the chapter on "Intermediates," where the author deals with some cases that do not seem to follow the Mendelian rule. The economic and human aspects of Mendelism are discussed in the two final chapters.

Heredity and Evolution.§—L. Plate has made a large number of breeding-experiments with mice, which lead him to complete confidence in the Mendelian theory of the purity of gametes. He proposes to modify Bateson's "presence and absence" theory into a "Grundfaktor-Supplement-Theorie." He maintains that Mendelism does not lessen the importance of selection theory, and that the conception of determinants is quite consistent with the transmission of acquired characters. He distinguishes seven different modes of germinal variation and five kinds of atavism, and gives a very interesting analysis of correlation.

* The Society are not intended to be denoted by the editorial "we," and they do not hold themselves responsible for the views of the authors of the papers noted, nor for any claim to novelty or otherwise made by them. The object of this part of the Journal is to present a summary of the papers *as actually published*, and to describe and illustrate Instruments, Apparatus, etc., which are either new or have not been previously described in this country.

† This section includes not only papers relating to Embryology properly so called, but also those dealing with Evolution, Development, Reproduction, and allied subjects.

‡ Mendelism. London: 1911, 3rd ed. pp. xiv. and 176 (6 pls. and 35 figs.).

§ Festschrift Richard Hertwig, ii. (1910) pp. 535-610 (1 pl. and 3 figs.).

Experimentally Induced Parthenogenesis in Toad.*—E. Bataillon has succeeded in inducing segmentation in toads' eggs. A string of eggs is placed in a vessel with as little mucus as possible; it is bathed with blood; then the eggs are finely punctured; segmentation results. The blood of the frog will serve instead of that of the toad. If the spermatozoa of *Rana fusca* be used there is amphimixis, but the development is abortive, and does not reach gastrulation. The blood of *R. fusca* gives better results than the spermatozoa. The blood stimulus "respects the specific nuclear combination"; the inappropriate amphimixis disturbs it.

Artificial Parthenogenesis of Toad's Egg.†—E. Bataillon has induced segmentation by injecting into the eggs some Mammalian blood, or sperms, or extract of spleen, or carp blood, or extract of testis. The "accelerating principle" introduced need not be specific; the essential conditions are puncture and the introduction of some foreign cellular elements.

Artificial Parthenogenesis in Toad.‡—E. Bataillon maintains that in the parthenogenetic development that follows puncture there is more than a reaction to the wound. The stylet must introduce some foreign body; even a leucocyte will serve, and the best results are obtained by introducing some blood or the like which acts as an "accelerative and regulative agent." But it is not anything specific that requires to be introduced; the blood of a fish will do just as well as the blood of a frog.

Number of Chromosomes in Parthenogenetically produced Larvæ of the Frog.§—A. Dehorne has carefully studied eight days' old larvæ, and finds that the number of the chromosomes in the somatic cells is six, which corresponds to half the normal number.

Plasmic Reduction in Spermatogenesis.||—M. Romieu calls attention to what he calls plasmatic reduction in the spermatogenesis of *Ascaris megalocephala*. Apart from the chromatin-reduction of the nucleus, there is a reduction of cytoplasm. It is this which effects the true maturation of the spermatozoa.

Effects of One-sided Ovariectomy on Sex of Offspring.¶—L. Doncaster and F. H. A. Marshall find that in the rat it is not true that ova determining one sex are produced from one ovary, and those determining the opposite sex from the other, for each rat, with one ovary completely removed, produced young of both sexes. The "right and left ovary hypothesis" is not true for the rat at least.

Origin of Sex.**—Sydney J. Hickson directs attention to the evolution of sex as it is illustrated in Protozoa. In *Actinophrys* two similar individuals conjugate; in *Coccidium* there are ovum-like and spermatozoon-like individuals which conjugate: in *Paramecium* and

* Comptes Rendus, clii. (1911) pp. 1120-2. † Tom. cit., pp. 1271-3.

‡ C.R. Soc. Biol., lxx. (1911) pp. 562-4.

§ Comptes Rendus, clii. (1911) pp. 1123-4.

|| C.R. Soc. Biol., lxx. (1911) pp. 412-14.

¶ Journ. Genetics, i. (1910) pp. 70-2.

** Trans. Manchester Micr. Soc., 1910, pp. 34-45.

Vorticella the distinction between somatoplasm and germplasm has begun. The advantage of this is in allowing the somatic functions to continue during conjugation. The relatively large size of ova is interpreted, in part, in connection with the need for a period of incubation. The introduction of a sedentary habit may have abetted the dimorphism.

Fertility of Hybrids of American and European Bison.*—E. Iwanoff reports from experiments made at the Zoological Park of M. Falz-Fein, that the hybrids between *Bison americanus* and *Bison europæus* are fertile. In the case of a male (*Bison americanus* ♀ × *Bison europæus* ♂) the bull would not serve, but one of the testes, which was removed, showed normal spermatozoa in abundance. The hybrid females of the same origin have already borne calves. This is an interesting case, for the species concerned are very distinct.

State of Ovary in Hybrids of Goldfinch and Canary.†—A. Chapellier points out that a female bird may be infertile in various degrees. The ovary may produce no ova; the ovary may produce eggs which are not laid; the eggs may be fertilizable or non-fertilizable. He has examined twenty-five hybrids between male goldfinch and female canary, and found various degrees. Some had a rudimentary ovary; others laid eggs like those of the canary, but smaller. Between these extremes there were inter-grades, e.g. ovaries with very small eggs. Only in about a fourth of the cases did it come to egg-laying.

Webfoot Character in Pigeons.‡—J. Lewis Bonhote corroborates previous breeders in regarding the webbed character as a Mendelian recessive, but the results of mating birds of different webbed strains gave results difficult to reconcile with the Mendelian theory. Each strain by itself breeds true according to Mendel's laws: the disturbing factor is due to the intermixture of the two strains. He is driven back to the suggestion that a factor composed of two parts (cryptomeres), one of which is contained in each strain, causes the web to be suppressed or concealed.

Action of X-rays on Developing Chick.§—J. F. Gaskell finds that the action of X-rays is to lower the mitotic activity of growing tissues. If this diminution is not too great, complete recovery occurs. If the diminution is above a certain degree, recovery does not take place. The critical dose, which just prevents recovery, varies with the stage of development of the embryo, decreasing as the mitotic index decreases. No other macroscopic or microscopic changes have been observed to take place under the action of X-rays, either in the proportions or structure of the various tissues.

Lymph-hearts of Turtles.||—F. A. Stromsten has studied the development of the posterior lymph-hearts in the loggerhead turtle. They are a pair of elliptical pulsating organs situated immediately below the carapace, just behind the upper ends of the ilia. They drain the lymph-

* C.R. Soc. Biol., lxx. (1911) pp. 584-6. † Tom. cit., pp. 328-9 (8 figs.).

‡ Proc. Zool. Soc., 1911, pp. 14-19 (2 figs.).

§ Proc. Roy. Soc., Series B, lxxxiii. (1911) pp. 305-10.

|| Anat. Record, v. (1911) pp. 173-8 (3 figs.).

cavities and lymph-channels of the posterior extremities and pelvic regions, and open into tributaries of the posterior renal advehent veins. The author finds that the intercellular mesenchymal spaces have an important function in initiating the development of the posterior lymph-hearts.

Occipital Region of Urodela.*—E. S. Goodrich has studied the development of this region in the head of *Amblystoma*. There are three occipital segments. The first forms no muscle and disappears early; the second forms a myotome divided into dorsal and ventral portions, of which the former alone persists, fusing with the myotome next behind. The myotome of the third segment persists dorsally; that of the first trunk-segment combines with it to form the temporal longitudinal muscle supplied in the adult by the first spinal nerve. The glossopharyngeal nerve belongs to the first metaotic segment, and has no ventral root. To the second segment belongs the vagus root, with which seem to be combined the ganglia of the next two nerves. No ventral root was found in the second segment, but a ventral root occurs in the last metaotic segment in early stages of development. The first spinal issues from between the skull and first neural arch as a ventral root only; it joins the second spinal to form the hypoglossal nerve supplying muscles derived from ventral outgrowths of the second, third, and fourth myotomes. The basilar plate of the skull is formed from a backward growth of the trabeculae meeting a forward growth of the base of the occipital arches. It fuses with the auditory capsules and with the præoccipital arches developed in the septum between the first and second myotomes. The occipital arches arise in the septum between the second and third myotomes. There is no evidence of the disappearance of segments behind the vagus, and no valid objection to the view that the hind limit of the skull may shift backwards or forwards in the course of phylogeny. At the same time, there is no reason to suppose that the ancestors of the Amphibia had more than three occipital segments, when the occipital condyles became clearly defined.

Ovarian Ovum of Proteus.†—Max Jörgensen gives a detailed and beautifully illustrated account of the growth of the ovarian ovum in *Proteus anguineus*, describing all the changes in the nucleus and in the cytoplasm. Among the points discussed at length the following may be noticed: the share of the chromidium in the reconstruction of the chromatin after it has been "pulverized" in the second stage of growth; the formation of the curious "lamp-brush" chromosomes; the continuity of the chromosomes; the use of the nucleoli (probably reservoirs for products of metabolism and furnishing ferments useful in plasm-growth and yolk-formation); the conditions of growth in the ovum and of yolk-formation.

Development of Gonads in Frog.‡—Sergius Kuschakewitsch gives a very welcome detailed account of the development of ovary and testis in *Rana esculenta*, contrasting the two at all stages. There appears to be a

* Proc. Zool. Soc., i. (1911) pp. 101-20 (23 figs.).

† Festschrift Richard Hertwig, i. (1910) pp. 439-634 (23 pls.).

‡ Op. cit., ii. (1910) pp. 61-224 (11 pls. and 13 figs.).

very noteworthy plasticity in the details of development, which the author correlates in part with the locality from which the material came, and in part with the degree of ripeness of the fertilized ova. As Richard Hertwig has shown, over-ripe eggs produce a large preponderance of males, and the author was able to raise the percentage to one hundred. The old difficulty of a possibly differential mortality seems to have been overcome.

Development of Head in Hypogeophis.*—Harry Marcus describes the development of the occipital region, of the eye-muscles and their nerves, of the dorsal nerves and their ganglia, of the sympathetic and the sinus cephalicus. In interpreting the architecture of the head, which has a minimum of nine somites, he deals with the various sets of data derived from a study of neuromeres, mesomeres, dermatomeres, and branchiomeres. He condenses his results, somewhat unwillingly, in a provisional synoptic table of the various segments.

Development and Evolution of Lungs.†—M. Makuschok discusses the various theories: (1) that the lungs of Tetrapoda are derivable from the swim-bladder of fishes; (2) that they are organs *sui generis*, quite independent of swim-bladder; and (3) that they are derivable from the posterior gill-pouches.

He gives an account of what he has observed in the newt. The primordia are from the first paired and bilaterally symmetrical; they appear somewhat late, and not before the fifth pair of oesophageal pouches; they present for a time a certain analogy to the fifth pair of pouches. A number of details are recorded which may have a phylogenetic significance.

Evolution-centres.‡—Th. Arldt discusses critically the difficult question of deciding as to the original home and headquarters of a group. Among the positive criteria of importance he notes the occurrence of the oldest fossil form, of the most primitive fossil form, of the majority of fossil forms, of widely distributed forms as compared with local occurrence elsewhere, of primitive living forms; and so on.

b. Histology.

Trophospongia and Chromidia.§—H. Erhard has studied the so-called "trophospongia" in the cells of the "bile-duct" of the snail and in the epididymis of the white mouse. He makes a point of showing that what Holmgren described as "trophospongia" should be called chromidia. In the case of the epididymis he brings forward strong evidence that it is by the activity of the chromidia in the cytoplasm that the secreted substances are formed.

Study of Chromosomes in Salamander.||—Karl Camillo Schneider discusses the genesis of chromosomes in the larval salamander. Each

* Festschrift Richard Hertwig, ii. (1910) pp. 373-462 (2 pls. and 39 figs.).

† Anat. Anzeig., xxxix. (1911) pp. 1-13 (6 figs.).

‡ Arch. Natur., lxxvii. (1911) pp. 211-31.

§ Festschrift Richard Hertwig, i. (1910) pp. 133-66 (2 pls.).

|| Tom. cit., pp. 213-32 (3 pls.).

chromosome of the prophase is bivalent, showing two spirally coiled "elementary structures" or "mites," each of which is the starting-point of a daughter-chromosome. He follows their history, and offers a strong corroboration of Boveri's theory of the individuality of the chromosomes.

Nuclear Budding in Tumour-cells.*—W. T. Howard finds that in certain depressed cells, usually giant cells, of some tumours there occurs a special type of amitosis—a process of nuclear budding. It represents a reversion on the part of these cells to a primitive type of nuclear and cell-division common among certain Protozoa, e.g. *Podophrya*. It affords a ready and simple means of cell regulation and of rapid division and multiplication among such cells. The author suggests that the degeneration and extrusion of nuclear buds followed by mitosis of the mother-nucleus in tumour-cells is, in principle, comparable to the maturation division of egg-cells.

Physical Nature of Neuroplasm.†—N. A. Barbieri has come to the conclusion that the neuroplasm in the nerve-cells and nerve-fibres is mobile and fluid. It can be emptied out by compression. Even the extravasated neuroplasm will take on a fibrillar structure if treated with alcohol or formol and stained, but this is an artificial result. Indeed, all the appearances produced by fixatives are artefacts, according to the author.

Union of Muscle-fibre and Tendinous-fibre.‡—E. Retterer and A. Lelievre conclude that there is no special substance, neither sarcolemma nor cement, uniting the muscular-fibre to the tendinous-fibre. At the level of the junction of the two kinds of fibres the dark discs disappear, and the clear bands are continued directly into the substance of the tendon.

Involution of Bursa Fabricii.§—J. Jolly gives a precise account of the involution or degeneration of this interesting transitory organ. The essential point is the gradual disappearance of the lymphocytes and the replacement of the lymphoid tissue by fibrous tissue. The organ becomes hard, and there is sometimes an accidental necrosis.

Epidermic Fibrils in Chick.||—Jean Firket describes the occurrence of cells quite full of fibrils in certain parts of the epidermis of the chick, namely, in the primordia of the beak and the feathers. Similar epidermic fibres have been described before, but the author has studied their development, and finds that they are formed at the expense of the chondriosomes of the embryonic cells.

Innervation of Heart in Reptiles and Batrachians.¶—M. Fedele has studied this in *Lacerta muralis*, *Elaphis quadrilineatus*, *Zamenis viridiflavus*, and in newts, frogs, and toads. He describes the nerve

* Festschrift Richard Hertwig, i. (1910) pp. 1-18 (3 pls.).

† Comptes Rendus, clix. (1911) pp. 1267-9 (1 fig.).

‡ C.R. Soc. Biol., lxx. (1911) pp. 474-6.

¶ Tom. cit., pp. 564-7.

§ Anat. Anzeig., xxxviii. (1911) pp. 537-49 (3 figs.).

¶ Atti R. Accad. Sci. Fis. Napoli, 1910, pp. 1-34 (2 pls.).

branches and the fundamental plexuses, the ganglia and their position, the innervation of the truncus arteriosus in Reptiles, the secondary plexuses and networks, the networks surrounding the muscular elements, and the intimate innervation of the myocardium.

c. General.

Morphology of the Vertebrates.*—L. Vialleton has produced an interesting introduction to the study of the morphology of the Vertebrata, which has some new features. It begins with the fundamental embryological data as to the germinal layers, and the establishment of the main Vertebrate characters. The second section deals with each system of the body in turn, discussing it from the comparative and from the embryological point of view. Then follows a systematic survey of the Vertebrate phylum and a score of careful schemata summing up the facts of distribution in time, and indicating probable affinities. The concluding section deals with the evolution of Vertebrates analytically in the light of palæontological and embryological data.

Pigmentation of the Nervous Lobe of the Hypophysis.†—Ch. Livon and Peyron find that neuroglial elements in the neuro-hypophysis elaborate pigment-granules at the expense of the products of the glandular lobe. The colloid substance made by the glandular lobe may pass directly into the vessels of the glandular lobe or into those of the nervous lobe. The pigment is distinct from ferric pigments and lipochromes, but it is uncertain whether it should be regarded as a product of assimilation or of dis-assimilation.

Pelvic Bones of some Cetacea.‡—Einar Lönnberg describes and figures a number of cases—*Balæna australis*, *Balænoptera quoyi*, *B. intermedia*, *Physeter catodon*, and *Globicephalus melas*. The first of these shows ilium, ischium, and pubis, a large femur, the remains of an acetabular cavity, and a rudiment of a tibia. In connexion with the Caa'ing whale, the author gives an interesting sketch showing how the crura penis are attached to the pelvic rudiment by means of a capsule with a network of connective tissue.

Natural Immunity of White Mice to Trypanosoma lewisi.§—D. Roudsky finds that inoculations of white mice with this trypanosome are ineffective. There is a vigorous leucocytosis and a very exceptional transient presence of trypanosomes in the circulation.

Physiology of Sleep.||—R. Legendre and H. Piéron have made experiments, extending over many years, on the results of prolonged enforced insomnia in dogs. They conclude that after prolonged insomnia, the cerebral plasma, the blood, and the cephalo-rachidian fluid have a hypnotoxic property, which disappears on heating to 65°. Injection into another animal provokes strong somnolence and cellular changes in the brain.

* Elements de Morphologie des Vertébrés. Paris (1911) xiv. and 790 pp. (304 figs.). † C.R. Soc. Biol., lxx. (1911) pp. 730-2.

‡ Archiv Zool., vii. (1911) No. 10, pp. 1-15 (12 figs.).

§ C.R. Soc. Biol., lxx. (1911) pp. 693-4.

|| Comptes Rendus, clii. (1911) pp. 456-8.

Hæmopoietic Function of Spleen in Embryo Bird.*—J. Jolly finds in the embryo of the fowl convincing evidence of the formation of both granular leucocytes and red blood corpuscles. In the embryos of the duck the formation of granular leucocytes was also observed.

Function of Bursa Fabricii.†—J. Jolly finds in the embryo chick distinct evidence of the hæmopoietic function of this organ. During the second half of incubation, it gives rise to lymphocytes in its follicles, and also in its connective tissue to granular leucocytes and white blood corpuscles. Thus, like the spleen, it has to some extent and for some time, the same function as the osseous medulla.

Notes on the Robber Frog.‡—John K. Strecker, jun., discusses *Litholytes latrans*, a peculiar and little known Batrachian of Texas. It is very terrestrial, and thoroughly nocturnal except at the breeding season, which is very early in the year (February). It presents a rather unusual appearance for a frog, on account of its proportions and its peculiar method of elevating the body. As a rule it retreats into holes and fissures on the slightest alarm. Its voice is a short dog-like bark, ending in a metallic ring.

Heart of Lungless Urodela.§—E. G. Dehaut has studied the state of the heart in the species of *Euproctus*, which inhabit the mountains of Corsica and Sardinia, and are entirely lungless. In other cases it has been reported that lungless Urodela have a rudimentary left auricle, or have the two auricles united by the disappearance of the auricular septum. But in *E. rusconi*, at least, Dehaut finds that the two auricles, which are situated to the left of the ventricle, are very distinct.

Fossil Lepidosirenidæ.||—Ernst Stromer reports from the Lower Oligocene of Egypt the occurrence of teeth belonging to *Protopterus aff. æthiopicus* Heckel, to *Protopterus aff. aeneus* Owen, to *Lepidosiren aff. paradoxa* Natterer, and to *Protopterus libycus* sp. n., which helps to link the two genera. He discusses the dentition of recent Lepidosirenidæ, and the distribution and phylogeny of the Dipnoan stock.

Colour-change in Fishes.¶—Karl von Frisch has made experiments with trout and minnow as to the relation of the pigment-cells to the nervous system. As Pouchet showed long ago, the sympathetic nervous system is immediately concerned. The author has shown that the nerve-fibres which control the pigment-cells pass out at a precise spot from the spinal cord into the sympathetic, and pass with it forwards and backwards. But he has gone further. He has succeeded in showing that there is in the anterior end of the medulla a special centre whose stimulus brings on a lighter colour—i.e. contraction of the chromatophores.

* C. R. Soc. Biol., lxx. (1911) pp. 259-61. † Tom. cit., pp. 493-500.

‡ Trans. Acad. Sci. St. Louis, xix. (1910) pp. 73-82.

§ C. R. Soc. Biol., lxx. (1911) pp. 271-2.

|| Festschrift Richard Hertwig, ii. (1910) pp. 611-24 (1 p.).

¶ Op. cit., iii. (1910) pp. 15-28 (2 pls. and 3 figs.).

Swim-bladder of Teleosts.*—H. C. Tracy finds that the Clupeoid swim-bladder is like that of the carp: it consists of a posterior portion which represents the primitive swim-bladder, and an anterior secondary outgrowth. That of *Fundulus* and *Menidia* is like that in *Esoc*, but without pneumatic duct.

The epithelial lining is derived from the endoderm of the œsophagus; the splanchnic mesoderm contributes the inner and middle layers of the wall; the outer connective tissue layers originate from the somatic mesenchyme of the neighbouring body region; the longitudinal bands of striated muscle in the swim-bladder of *Opsanus* arise from the myotome of the first somite and are innervated by a branch of the first spinal nerve.

In the more primitive swim-bladders the pneumatic duct opens into the anterior end; in the derived types the embryonic pneumatic duct opens into the posterior end. The posterior chamber in *Opsanus*, *Siphonostoma*, *Tautoglabrus* and *Tautoga* develops directly from the embryonic pneumatic duct.

The pneumatic duct in the eel, the posterior chamber in *Opsanus*, etc., and the oval in the highest type of swim-bladder are probably to be regarded as homologous structures, produced as the result of the progressive reduction of the pneumatic duct and the development of a rete mirabile.

In the primitive swim-bladders the epithelial lining is undifferentiated; in the eel, the epithelium has become columnar and is thrown up into simple folds all over the internal surface. The red gland in the higher types results from a progressive increase in the complexity of the folding, accompanied by a concentration of the folds in a restricted area.

Tunicata.

Tenacity of Life in *Ciona intestinalis*.†—G. Daumézou has found it possible to keep this hardy Ascidian in good condition in artificial sea-water. His experiments led him to discover evidence of extraordinary tenacity of life. They are vigorous for hours at 20–23° C., and they survived cold till the medium froze. In a solution of saccharose of the optimum density the animals showed the heart beating for several hours. They can live out of water for hours, till they lose the water they contain.

INVERTEBRATA.

Mollusca.

Marine Molluscs of Clare Island.‡—Nathaniel Colgan deals with 246 species from this area, which has recently been the subject of a detailed regional survey. He discusses the somewhat negative characteristics of the Clare Island marine molluscan fauna and compares it with that of Dublin Bay. The western area has 5 boreal species to 31 austral; the eastern or Dublin area has 12 boreals to 37 australs.

* Anat. Anzeig., xxxviii. (1911) pp. 638–49 (10 figs.).

† C.R. Soc. Biol., lxx. (1911) pp. 721–3.

‡ Proc. R. Irish Acad., xxvi. (1911) Clare Island Survey, pt. 22, pp. 1–36.

Attention is directed to the abundance of two interesting Ascoglossans or close allies of the Nudibranchs, *Hermaea dendritica* and *Elysia viridis*, and of *Cerithium reticulatum* and *C. perversum*.

γ. Gastropoda.

Beating of the Heart in Hibernating Snail.*—Arnold Lang has studied this in *Helix pomatia*, in most cases by making a window in the shell above the heart and putting in a little pane of glass or the like. As the temperature falls the number of beats decreases: the two curves are almost parallel. There was 1 beat per minute at -0.6°C .; 2.36 at $+2.65^{\circ}$; 5.75 at 5.3° ; 8.26 at 7.7° ; and so on. There is a greatly reduced power of reaction as the winter sets in with severity. Yet after persistent low temperature the heart was observed beating slowly at even -3°C .

Reduction in the Spermatogenesis of the Snail.†—A. Bolles Lee confirms his previous conclusion that there is a conjugation of chromosomes in the course of spermatogenesis. It occurs in the anoxocyte stage, but it remains uncertain whether it is a phase of the process of numerical reduction of chromosomes.

Abnormality in Snail.‡—G. Quintaret describes a specimen of *Helix aspersa* with a supplementary penis which contained spermatophores. A double penis has been described by Rouzaud in *Bulinus detritus* and some other forms, but in these there was but one aperture, whereas in the monstrosity described there are two distinct apertures. There has been a longitudinal splitting of the penial primordium.

δ. Lamellibranchiata.

Influence of Radium on the Development of *Pholas candida*.§—Jan Tur finds that fertilized ova, beginning to develop, were not affected by the influence of radium-bromide as regards segmentation, gastrulation, or the formation of the veliger larva. In the larval stage, however, there began to be a degeneration and discharge of superficial epithelial cells. On the other hand, ova exposed to the radio-active influence for 6 to 24 hours, before fertilization, showed, instead of the unequal, a perfectly equal segmentation. The gastrulation was none the less by epibole, as usual.

Notes on Fresh-water Mussels.||—W. Israel points out that two rings are sometimes made in one year. In the Danube the young occur in the gill-chamber in April to June, and also in October to December in *Anodonta piscinalis*, in October to November in *Pseudanodonta complanata*, in May and June in *Unio pictorum*, in December and January in *U. tumidus*, and in August in *U. consentaneus*.

* Festschrift Richard Hertwig, iii. (1910) pp. 1-14 (5 pls.).

† La Cellule, xxvii. (1910) pp. 55-74 (1 pl.).

‡ C.R. Soc. Biol., lxx. (1911) pp. 55-56.

§ Tom. cit., pp. 679-81.

|| Nachrichtsb. Deutsch. Malakol. Ges., xliii. (1911) pp. 10-17. See also Zool. Zentrabl., xviii. (1911) p. 216.

Avicula and Gorgonid Association.*—T. Southwell reports finding, off Ceylon, quantities of yellow-brown *Leptogorgia lutkeni* with its branches thickly encrusted with a yellow-brown *Avicula*. The bivalves merge into the general habit and appearance of the Gorgonid, obtaining in all probability a considerable measure of immunity from enemies through this resemblance to a spicular indigestible organism.

Incubation of *Cyclas* Embryos.†—E. Poyarkoff has studied the incubation of the embryos of *Spharium corneum*. They develop in sacs between the two lamellæ of the inner gill-plate, or between the lamella and the mantle. The sacs are described in detail; they seem to be for the most part mesodermic in origin and due to leucocytes. Indeed, the formation of the incubatory sac may be compared to an inflammatory process. The ectodermic epithelium disintegrates, and its regeneration is described.

Arthropoda.

a. Insecta.

Rhythms in Termite Communities.‡—E. A. Andrews and A. R. Middleton have studied the common termite at Montego Bay, Jamaica, counting the numbers running in and out of the nest hour after hour. They show that the termites do actually work at all times of the day and night, and that there are rhythms in the activities of the entire community. In one case the number of termites going into the nest each hour varied from 1702 between 1 and 2 p.m. to 8100 between 2 and 3 a.m., while in the same case the numbers going out of the nest were 1194 between noon and 1 p.m., and 6820 between 1 and 2 a.m.

Insects as Disseminators of Ergot.§—L. Mercier has found evidence that *Sciara thomæ* distributes the conidia of the *Claviceps* that causes "ergot" in rye-grass. The conidia do not seem to be affected in the food-canal of the fly, and there are also some on the hairs of the body.

Dissemination of Disease by *Stomoxys calcitrans*.||—A. Schuberg and Ph. Kuhn have proved experimentally that this common fly can infect animals with Trypanosomes and Spirochaets. It is not, of course, the normal host of the disease germs experimented with, but it may share in the dissemination of these and of others.

Roumanian Mosquitos.¶—N. Leon gives an account of the swarms of mosquitos which infest the marshes by the shores of the Danube, and calls attention to the beneficial work of numerous spiders in checking their increase a little. He reports *Anopheles maculipennis*, *A. bifurcatus*, *Myzorhynchus pseudopictus*, *Culex pipiens*, *C. fuscus*, *Theobaldia nemorosa*, and *Tæniorhynchus richardii*.

East Indian Chironomidæ.**—J. J. Kieffer describes numerous new species in the genera *Ceratopogon*, *Culicoides*, *Palpomyia*, *Bezzia*, *Calypto-*

* Ceylon Marine Biological Reports, v. (1911) p. 207.

† Arch. Zool. Expér., v. (1910) Notes et Revue, No. 5, pp. cxxv.-cxxxviii. (7 figs.).

‡ Johns Hopkins Univ. Circ., No. 2 (1911) pp. 26-34 (2 figs.).

§ C.R. Soc. Biol. lxx. (1911) pp. 300-2.

|| Arbeit. k. Gesundheitsamte, xxxi. (1911) pp. 377-93.

¶ Centralbl. Bakt. Parasitenk., lvii. (1910) pp. 148-54.

** Mem. Indian Museum, ii. No. 4 (1910) pp. 181-242 (4 pls.).

pogon g.n., *Macropseza*, *Isoplastus*, *Procladius*, *Tanytus*, *Chironomus*, *Tanytarsus*, and *Conocladius* g.n.

Chromidia in Cells of Muscidae.*—M. Popoff has studied the formation of chromidia by the nucleus in the cytoplasm of fat cells, œnocytes, and pericardial cells in Muscidae. They correspond to ergastoplasm, mitochondria, chondriomites, chondriokonts, pseudochromosomes, and "nebenkern" in glandular cells and sex-cells. The distribution of the chromidia in the cytoplasm has a definite relation to function, e.g. to diffusion-currents. As regards chromidia, there is a close resemblance between the processes of glandular secretion and those associated with the accumulation of reserves in germ-cells.

Digestion in Wood-eating Caterpillars.†—P. Portier has studied the curious larva of *Nonagria typhæ*, which bores in the stem of *Typha latifolia*. The glandular area in the intestine is very restricted, and no ferment capable of dissolving cellulose could be found. But there are very abundant fusiform "pseudo-bacteria," probably minute moulds, which work at the vegetable tissue, pass through the walls of the gut, and are engulfed by leucocytes. In short, the micro-organisms which break down the woody tissue form the main food of the caterpillar.

Acephalous Lepidoptera.‡—A. Conte and C. Vaney ligatured caterpillars (of *Bombyx mori*, *Cheloma caju*, and *Lymantria dispar*) at the junction of head and thorax, and after the head was dry cut it off. The caterpillars did not seem much affected by the decapitation, but they moved more slowly. Chrysalids were formed, but only in the case of *L. dispar* was an imago developed. It was normal except in the absence of a head. This shows that the cephalic ganglia are not necessary for the normal development of the trunk.

Grape Moths.§—Schwangart gives an account of the two Tortricidæ (*Conchylis ambiguella* Hübn., and *Polychrosis botrana* Schiff), whose caterpillars do so much damage in the vineyards. In the Pfalz in 1906 the loss was estimated at six millions of marks. He discusses the life-history and habits, the natural enemies, the various chemical, mechanical and physical modes of dealing with attacks, and in particular the infection with a pathogenic mould, a species of *Cordyceps*.

Photogenic Organs of Lampyridæ.||—F. A. McDermott and C. G. Crane have studied the structure of these organs in *Photinus pyralis*, *P. consanguineus*, and *Photuris pennsylvanicus*, and find that it is practically the same in the three, and very similar to that previously described in other Lampyridæ. There are two distinct layers, the inner one white and opaque, and serving as a reflector (possibly also protective to the insect itself), the outer one yellowish and translucent, and containing the actual photogenic mechanism. The organs are penetrated by innumerable tracheæ; these connect near the spiracle with the tracheæ, which supply other organs, and very closely resemble these ordinary

* Festschrift Richard Hertwig, i. (1910) pp. 19-48 (3 pls. and 2 figs.).

† C.R. Soc. Biol., lxx. (1911) pp. 702-4.

‡ Comptes Rendus, clii. (1911) pp. 404-6.

§ Festschrift Richard Hertwig, ii. (1910) pp. 463-534 (3 pls.).

|| Amer. Nat., xlv. (1911) pp. 306-13 (2 figs.).

trachea. The view that the photogenic process is an oxidation is borne out by the structure of the photogenic organs.

Life-history of *Schlechtendalia chinensis*.*—C. Sasaki has cleared up most of the life-history of this Aphis, which produces galls in Japan and China on *Rhus semi-alata*. The galls are used for dyeing and tanning, and the powder of the dried galls was formerly employed by Japanese women for blackening the teeth. Sasaki has succeeded in finding the wingless mother insect (the fundatrix), which produces numerous young ones parthenogenetically and viviparously. These produce galls of various shapes, and after more viviparous wingless females have come and gone, there are winged females which lay eggs containing well-advanced embryos that soon hatch out. No males have been met with.

Degenerate Cockroach.†—F. H. Gravely describes *Alluaudella himalayensis* sp. n., a new degenerate *Embia*-like cockroach with very simple venation. The only other species known is *A. cavernicola* from German East Africa, and *Cardax willeyi* is a related form with similar simplicity of venation. Only males of the three forms have been found.

Mallophaga from Southern Birds.‡—L. G. Neumann records from albatrosses of the Southern Ocean—*Lipeurus hyalinus* sp. n. and two other species, and *Taschenbergius brevis* (Dufour). From Maccormick's Skua, *Megalestris maccormicki*, there was obtained *Lipeurus concinnus* Kellogg and Chapman, not previously recorded from this bird nor in the Antarctic. It was the only representative of the bird-lice actually found in the Antarctic region, where they seem to be exceedingly rare, but another was seen alive on the Emperor Penguin.

Larva of *Mantispa*.§—R. T. Lewis contrasts the larva of *Mantispa* (Neuroptera) with the young stages of *Mantis* (Orthoptera). The latter are, in some cases at least, like miniatures of the adult except in the absence of wings. But the larvæ of *Mantispa* bear no resemblance to the perfect insect and illustrate hyper-metamorphosis. The first larval stage is described.

Monograph on Embiidæ.||—H. A. Krauss deals with these somewhat earwig-like insects, with two-jointed cerci instead of forceps. They represent an old stock among the more primitive insects. The author attaches them to the Orthoptera, but they are as independent an order as earwigs or as termites. Four families and eleven genera are now recognized. An account is given of the structure, habits, and distribution.

Blattidæ in Amber.¶—R. Shelford reports on R. Klebs's fine collection of Blattidæ in amber (Lower Oligocene). He deals with twenty-four species in nine genera, but they present no details of structure or form which can be regarded as peculiarly primitive and archaic. A comparison of the amber-enclosed Blattidæ with the paucity of species occurring in Northern Europe at the present day is sufficiently

* Festschrift Richard Hertwig, ii. (1910) pp. 241-52 (2 pls.).

† Records Indian Museum, v. (1910) pp. 307-11 (1 pl. and 1 fig.).

‡ Rep. British Antarctic Exped., 1907-9, ii. (1911) pt. 3, pp. 19-22 (1 pl.).

§ Journ. Quekett Micr. Club, xi. (1911) pp. 213-16.

|| Zoologica, xxiii. (1911) Heft 60, pp. 1-78 (5 pls. and 7 figs.).

¶ Journ. Linn. Soc. (Zool.) xxx. (1910) pp. 336-55 (2 pls.).

indicative of the profound change of climate that has ensued within geologically recent times. The exquisite preservation of the specimen leads the author to suggest that some method should be devised by enshrining in a similar way in balsam or other resin the type-specimens of recent species of insects.

New Palæozoic Insects.*—Anton Handlirsch describes numerous new genera, chiefly Blattoid in character, and establishes a new order Sypharopteroidea for *Sypharoptera pneuma* g. et sp. n. This fossil somewhat resembles certain Megaseoptera, and has also some resemblance to Ephemeroidea. But it cannot be placed in any known order, and evidently represents an offshoot of the Palæodictyoptera without any extant descendants.

Injurious Insects.†—E. P. Felt deals with a large number of injurious insects—codling moth, juniper webworm, large aphid spruce ball, ash psylla, and so on. He gives a description of one of the gall-midges, *Miastor americana* Felt, and the remarkable pædogenesis that is exhibited.

γ. Prototracheata.

Jamaica Peripatus.‡—E. A. Andrews discusses the distribution of *Peripatus* in Jamaica. There seem to be two species—*Peripatus jamaicensis* Cockerell and Grobham and *P. juliformis* var. *swainsonæ* Cockerell. “While apparently only some 120 specimens of *Peripatus* have ever been seen in Jamaica, and all but eight or so of these from the region of Bath, it may well be that *Peripatus* exists in relatively large numbers throughout the entire length of Jamaica wherever the conditions are not inimical, since its nocturnal habits and slow moving, concealed existence, would make it difficult to observe, even if it did not prefer the chaos of irregular stones underlying the dense growths of the forests.”

δ. Arachnida.

Development of Tetrapneumones.§—Ludmila and Wladimir Schimkewitsch have studied the early stages in the development of *Ischnocolus*, one of the Tetrapneumones. Their results differ considerably from those of Kautzsch. There is on the germinal disc a gastral depression which recalls in its shape that of Pedipalpi rather than that of Dipneumones. In the inner layer of cells in the blastoderm there is a very early differentiation of endoderm cells. The yolk-cells are formed by an insinuation of blastoderm cells, by contributions from the mesoderm cells of the cumulus, and by contributions from the mesoderm of the germinal disc. In the formation of segments, the head-lobe gives rise to that bearing the chelicerae, and still earlier (according to Kautzsch) to that bearing the pedipalps.

In a subsequent paper|| the formation of the body is discussed. In general the development of *Ischnocolus* agrees with that of the older

* Amer. Journ. Sci., xxxi. (1911) pp. 353-77 (32 figs.).

† New York State Museum, Bull. 147 (1911) pp. 1-180 (35 pls.).

‡ Johns Hopkins Univ. Circular, No. 2 (1911) pp. 51-5.

§ Bull. Acad. Imp. Sci. St. Petersburg, vi. (1911) pp. 637-54 (2 pls. and 22 figs.).

|| Op. cit., ix. (1911) pp. 685-706 (1 pl. and 24 figs.).

Dipneumones such as *Pholcus*, e.g. in the bending of the caudal lobe forwards. A tubercle on the internal surface of the pedipalps and limbs recalls the masticating plates in *Limulus*, Gigantostrea, and Trilobites. The complicated dorso-lateral plate, the origin of phagocytes, and other subjects are discussed. The first cuticular envelope of the embryo differs markedly from subsequent cuticles; the chelicerae have chelae and the other cephalothoracic limbs have distinct masticatory plates, whereas the larva has no chelae and few setae. The ganglia in the cephalothorax, which are described at length, show distinct internal cavities. The development of the gut is described. The coxal gland opens behind the first pair of appendages.

Carboniferous Arachnida.*—R. I. Pocock has made an important contribution to the study of the Carboniferous Arachnida. He deals with thirty-three forms, some of which are of much morphological interest. Thus, a new scorpion, named *Eobuthus holti*, has bilobed overlapping plates on the fourth, fifth, and sixth somites of the abdomen, which have a general resemblance to the gill-bearing appendages in the same segments in the king-crab.

Male Reproductive Organs of Chelifer and Cherncs.†—J. P. Schtschelkanowzew describes the internal male organs and the external genitalia in the males of these two types, and discusses the systematic position of the Chelonethi in the system of Arachnids. His general conclusion is that they are most nearly related to the sub-order Urotricha (Holopeltidia). Among the many interesting facts brought out in the memoir is the absence of a tail in the ripe spermatozoa.

Sudanese Pycnogonids.‡—G. H. Carpenter describes *Nymphon maculatum* sp.n., marked from other species by the very elongate neck and body, together with the short abdomen, excessively long second coxal segment, and well-developed auxiliary claws; and *Pallenopsis crosslandi* sp.n., a very interesting species of a remarkable genus. There are curious finger-like processes on the first tibial segment. These, and indeed the legs generally, are beset with the prominent openings of numerous cuticular glands, provided at the edge of the orifice with small sharp spines. The elongate spines on the thigh and the first tibial segment are highly denticulate. Another noteworthy feature is the great length of the accessory claws, nearly equalling the principal claw. The variation of this character in the genus *Pallenopsis* is remarkable and instructive.

New Decapod Pycnogonid.§—E. L. Bouvier describes *Pentapycnon geayi* sp.n. from off the coast of French Guiana. It has five pairs of limbs—the first decapod Pycnogonid found outside the Antarctic region. The new form is in several ways very interesting. Thus Bouvier points

* Monograph of the Terrestrial Carboniferous Arachnida of Great Britain. Paleontographical Soc. (1911) 84 pp. (3 pls. and 42 figs.).

† Festschrift Richard Hertwig, ii. (1910) pp. 1-38 (1 pl. and 5 figs.).

‡ Journ. Linn. Soc. (Zool.) xxxi. (1910) pp. 256-8 (1 pl.).

§ Comptes Rendus, clii. (1911) pp. 491-4.

out that its surface has a reticulate pattern, while that of *P. charcoti* is shagreen-like. Thus the two types of integumentary pattern which are found in *Pycnogonum* occur also in the primitive *Pentapycnon*.

New Pentastomid.*—A. E. Shipley describes *Porocephalus kachugensis* sp.n. from the liver of a tortoise (*Kachuga lineata*), and communicates some notes on three other species, and on *Lingualula subtriquetra* Diesing, of which a good figure is given showing the characteristic lateral flaps or flanges, and the papillæ about the mouth.

Notes on Tardigrada.†—James Murray has written a supplement to a short introduction to Tardigrada, which he published in 1907. He deals with additional genera—*Tetrakeutron* Cuénot, *Halechiniscus* Richters, *Batillipes* Richters, and *Orcella* Murray. The relationships of the ten known genera are discussed, and a key is given. At present the genera cannot be put into series. Most of them have some degree of resemblance to the well-known and extensive genus *Echiniscus*. *Milnesium* and *Macrobotus*, with its dependent *Diphascoen*, are furthest removed. All the marine genera, and *Orcella*, have the head-processes traceable to modifications of the type of *Echiniscus*.

6. Crustacea.

Larval Stages of Decapods.‡—H. C. Williamson describes the zoeæ of three species of *Portunus*, of *Hyas araneus*, *Eupagurus bernhardus*, *Galathea dispersa*, *Crangon trispinosus*, and *Cancer pagurus*. He directs attention to the pigmentation which affords an important aid to specific identification. "The Zoeæ are usually well supplied with pigment, and, when alive, may in some cases be separated into species by the naked eye. The pigmentation is specific, and remains constant through all the zoea and megalops stages."

Californian Crabs.§—F. W. Weymouth gives a synopsis with fine photographs of the Brachyura of Monterey Bay, California. He deals with fifty-two species, including *Dromidia seignipes* sp.n.

New and Rare Cumacea.||—W. T. Calman describes twenty-nine species of Nannastacidae and Diastylidae from the Copenhagen Museum. All except two are regarded as new, and three new genera—*Schizotrema*, *Gynodiastylis*, and *Colurostylis*—are established. The new genera do not perceptibly extend the group towards any of the adjacent orders of the Malacostraca. "The Cumacea still remain a sharply circumscribed group, and although it is as certain as anything of the sort can well be that they have been derived from a Mysidacean-like ancestral form, and that their line of descent travelled for some little way along with that of the Tanaidacea and Isopoda (but not, probably, with that of the Amphipoda), none of the intermediate links appear to have survived.

* Parasitology, iii. (1910) pp. 275-8 (1 pl.).

† Journ. Quekett Micr. Club, xi. (1911) pp. 181-98 (1 pl.).

‡ Fisheries Scotland Sci. Invest., i. (1909, published 1911) pp. 1-20 (5 pls.).

§ Leland Stanford Junior Univ. Publications, No. 4 (1910) pp. 1-64 (14 pls.).

|| Trans. Zool. Soc., xviii. (1911) pp. 341-98 (6 pls.).

Woodlice of Ireland.*—Denis R. Pack Beresford and Nevill H. Foster record twenty-five species in twelve genera, and give an account of what is known of their distribution in Ireland. They also give a diagnostic key of the genera.

New Carboniferous Crustacean.†—W. T. Calman describes *Pleurocaris annulatus* g. et sp. n. from the English Coal-Measures near Dudley. The possession of a "tail-fan," consisting of a pair of biramous appendages on either side of a median telson, shows at once that it belongs to the Malacostracan Crustacea and to the series Eumalacostraca. The absence of a carapace practically narrows the comparison, among the existing groups of Eumalacostraca, to the Isopoda and the Syncarida. Reasons are given for referring *Pleurocaris* provisionally to the division Syncarida in the vicinity of the genus *Acanthotelson* Meek and Worthen.

Barnacles from Irish Seas.‡—N. Annandale describes the external characters of *Scalpellum (Smitium) kempi* sp. n., a peculiar species found attached to *Lophohelia*. It is apparently most nearly related to *S. gemma* and *S. grimaldi*, but has two extra valves below the rostrum and a narrower carina. The commonest species of the genus is *S. vulgare*, and *S. velutium* also occurs. In regard to the latter, the author notes that it is closely related to *S. formæ* of the Italian Miocene, that it is common on both sides of the Atlantic in northern latitudes, and has been taken as far south as Tristan d'Acunha. It also occurs in the Indian Ocean. The bathymetrical range is extraordinary—from 35 to over 1000 fathoms.

New Ascidicolous Copepod.§—E. Chatton and E. Brément describe *Ophioseüdes abdominalis* sp. n., a parasite of *Amurocium densum*, nearly related to *O. joubini* Ch. Only the female is known, a vermiform, sub-cylindrical, greenish-yellow animal with a bright red eye.

Annulata.

Oligochæt Commensals in Spongilla carteri.||—J. Stephenson reports the occurrence of numerous fresh-water worms in a fresh-water sponge. He calls the association commensalism, but does not give clear evidence of the appropriateness of this term. One specimen of *Pristina longisetu* was obtained; the others were referred to *Nais pectinata* sp. n., *N. communis* Pignet var. *punjabensis*, and *N. communis* Pignet var. *cæca* var. n. The last two are identical, except that the one has eyes and the other has not.

Bothrioneurum iris.¶—J. Stephenson re-describes this interesting earthworm from Kurseong in the Eastern Himalayas. It was first described by Beddard from the Malay Peninsula, and afterwards examined by Michaelsen from Kurseong. The pear-shaped spermatophores are

* Proc. R. Irish Acad., xxix. No. 4, pp. 165-90 (1 pl.).

† Geol. Mag., viii. (1911) pp. 156-60 (1 fig.).

‡ Ann. Nat. Hist., vii. (1911) pp. 588-90 (1 fig.).

§ Bull. Soc. Zool., xxxvi. (1911) pp. 29-33 (1 fig.).

|| Records Indian Museum, v. (1910) pp. 232-40 (1 pl.).

¶ Tom. cit., pp. 241-6 (2 figs.).

very characteristic, and there may be as many as five on one specimen, not round the male genital aperture, but on the dorsal and dorso-lateral surfaces of the clitellar segments.

New Leech from Egypt.*—W. A. Harding describes *Placobdella ægyptiaca* sp. n., ectoparasitic on the mud tortoise (*Trionyx triunguis*). "The nearly terminal mouth, the seven pairs of crop caeca, and the fact that its host is a tortoise place this leech beyond doubt in the Glossosiphonid genus *Placobdella* (R. Blanchard, 1893)." The size of the largest specimen, in a medium state of contraction, was 14.5 mm. long by 5 mm. wide.

Nematohelminthes.

Blood Filaria in Horse.†—H. Mandel gives a description of a microfilaria which he found abundantly in the blood of a Berlin horse. This is apparently the first case of the kind in a European horse. It remains to be seen whether it is a casual occurrence or whether filariæ cause some disease the ætiology of which is still unknown.

Oxyuris in the Appendix vermiformis.‡—G. Railliet reports that out of 119 appendices he found fifty-eight with *Oxyuris*. In one case there was a male *Trichocephalus*. Usually there were about ten, but not uncommonly there was only one. In five cases the number exceeded fifty, and one child had over a hundred. They usually rest on the mucous membrane, but they may penetrate into it. No blood was detected in any of them. Marked vitality is characteristic. Thus in one case there was a living *Oxyuris* in an appendix thirty hours after operation.

Nervous System of Ascaris.§—R. Goldschmidt completes his study of the nervous system of *A. lumbricoides* and *A. megalocephalu*. He describes the minute structure of the glia, the nerve-fibres, and the ganglion-cells, and devotes particular attention to the neurofibrils, which he strongly maintains are only of the nature of cellular skeleton. One of the curious individual results of a most penetrating investigation is that cell 26 of the Gangl. ceph. lat. int. is present only in males.

Platyhelminthes.

Pearl-inducing Parasite.||—T. Southwell has made a number of feeding experiments in order to determine the adult of the worm whose larvæ form pearls in the oyster. He has not yet found *Tetrarhynchus unionifactor*—the adult stage suspected—in any fish in the open sea, but thirty-eight were found in specimens of *Ginglymostoma concolor*, which had been fed on oysters in an enclosure. The experiments remain inconclusive; but the strong probability is that the adult of the worm is *T. unionifactor*, that its life-history is direct from the oyster to the fish, and that the adult may occur in all Elasmobranchs that feed on oysters.

* Ann. Nat. Hist., vii. (1911) pp. 388-9 (1 fig.).

† Centrallbl. Bakt. Parasitenk., lvii. (1910) pp. 84-7 (1 pl. and 1 fig.).

‡ C.R. Soc. Biol., lxx. (1911) pp. 310-11.

§ Festschrift Richard Hertwig, ii. (1910) pp. 253-354 (7 pls. and 29 figs.).

|| Ceylon Marine Biological Reports, v. (1911) pp. 213-15.

New Cestodes from Ceylonese Fishes.*—T. Southwell describes nine new species, two of which require new genera, which are named *Phyllobothroides* and *Cyclobothrium*. In the former the head has four simple, undivided leaf-like bothridia which are slightly concave, and overhanging the proximal part of each bothridium there is a pair of hooks. In the other new genus, the head is shaped like a daisy, with a central myzorhynchus bearing a pair of suckers, and surrounded externally by a fringe of about fourteen long, hollow, unbranched, digitate sucker-like tentacles, arising from the base of the myzorhynchus.

New Tapeworm from a Duck.†—T. B. Rosseter describes *Hymenolepis upsilon* sp. n. from a wild duck (*Anas boschas*). He compares it in detail with *Tænia microsoma* Creplin, which it resembles in some respects. In the penultimate and ultimate segments the ripe ova or hexacanth embryos are contained in a U-shaped ovarian-uterine sac, like a Greek upsilon. This form of uterine sac does not occur in any other tapeworm from birds.

Cysticercoids from Rat-flea.‡—W. Nicoll and E. A. Minchin have found two cysticercoids in the cavity of the rat-flea (*Ceratophyllus fasciatus*). One was the larval form of *Hymenolepis diminuta* Rud. (= *Tænia leptocéphala* Creplin). The other was perhaps the larval form of *Hymenolepis murina*, which may turn out to be the same as *H. nana*, a dangerous tapeworm of man.

Gasterostomum tergestinum.§—W. Nicoll gives a re-description of this species, which has not been seen since Stossich described it in 1883. The chief distinctive feature of the species is the position and arrangement of the yolk glands, two symmetrically situated masses on the level of the anterior border of the pharynx and close to it. In most *Gasterostomata* they are disposed along the margins of the body.

Horse Parasites in Cameroon.¶—Berké describes the case of a horse in Cameroon reduced to extreme emaciation by huge numbers of Trematodes (the remarkable *Gastrodiscus ægyptiacus*) and Nematodes (*Spiroptera megastoma*) in the stomach and intestine.

Non-parasitic Bdellourid.¶¶—Paul Hallez describes an interesting Antarctic Planarian, *Synsiphonium liouwilli* g. et sp. n., one of the Bdellouridæ. These interesting forms (*Bdelloura* and *Syncalidium*) are known as ectoparasites of the king-crab from the North American coast. But the form now described was found free-living, and its peculiarities make it necessary to erect a new genus.

Excretory System of Bothriomolus.**—Paul Hallez gives a careful account of the excretory system of this Turbellarian, and compares it with that of *Bothrioplana*, which it resembles closely in many points.

* Ceylon Marine Biological Reports, v. (1911) pp. 216-25 (4 pls.).

† Journ. Quakett Micr. Club, xi. (1911) pp. 147-60 (1 pl.).

‡ Proc. Zool. Soc., 1911, pp. 9-13 (2 figs.).

§ Ann. Mus. Zool. Univ. Napoli, iii. (1910) pp. 1-3 (1 fig.).

¶ Centralbl. Bakt. Parasitenk., lviii. (1911) pp. 129-34 (1 fig.).

¶¶ Comptes Rendus, clii. (1911) pp. 461-3.

** Arch. Zool. Expér., vi. (1911) pp. 441-63 (1 pl. and 1 fig.).

This furnishes an argument in favour of including *Bothriomolus* in the family Bothrioplanidae. Hallez describes the two chief vessels or collectors, the vessels of the second order, the capillaries and ciliated funnels, and other details of the intricate system.

Dalyellidæ and Umagillidæ.*—Bruno Wahl gives revised diagnoses and classification of these two families of Turbellarians, which include a number of interesting, in part parasitic, forms, such as *Graffilla*, *Anoplodium*, *Syndesmis*, *Dallyellia*, and *Umagilla*. One of the remarkable points referred to is the absence of male gonads in *Graffilla parasitica*.

Echinoderma.

Polarity of Primary Oocyte of Asterias forbesii.†—Naohide Yatsu finds that in this starfish the point of attachment of the primary oocyte coincides neither with the animal pole as in *Strongylocentrotus*, nor with the vegetal pole as in *Cerebratulus*. In this case, therefore, the longitudinal axis of the germ-epithelial cell does not correspond to the egg-axis or to the embryonal axis.

North Pacific Ophiurans.‡—H. L. Clark describes the collection in the U.S. National Museum—a huge piece of work—dealing with 189 species, 129 new. There are 12 new genera. He calls attention to the difficulty of classification, one of the reasons being our ignorance of the growth changes. The number of arm spines and oral papillæ often increases with age. Jackson's law of "localised stages" finds many illustrations, for the Ophiuran arm often reveals the characters of youth at or near the tip of the arm. Another interesting matter is variation in the extent of calcification, and in the extent of resorption of the calcareous matter. An interesting account of the distribution is given. One of the general results is that "Jordan's Law" of isolation does not seem to have much application here.

Genera of Recent Clypeastroids.§—H. L. Clark discusses these "cake-urchins" or "sand-dollars," and recognizes five families (for fifteen genera)—Clypeastridæ, Arachnoididæ, Laganidæ, Fibulariidæ, and Scutellidæ. "The Clypeastridæ are almost certainly the nearest of the families to the original stock, and it is not hard to believe that the Laganidæ have had a common ancestry with them. The Fibulariidæ seem to have been derived from the Laganidæ, or from a near ancestor, by a process of simplification. The Arachnoididæ are certainly an old stock beginning on or near the Clypeastrid branch and with no near relatives at the present day. The Scutellidæ are quite a distinct branch, though their origin is probably very near that of the Laganidæ, if not identical with it." Such simplicity as is shown by *Echinocyamus* and *Fibularia*, which cannot be considered primitive, is probably associated with their small size.

* Festschrift Richard Hertwig, ii. (1910) pp. 39-60 (2 pls. and 1 fig.).

† Annot. Zool. Japon., vii. (1910) pp. 217-21 (7 figs.).

‡ U.S. Nat. Mus. Bull. lxxv. (1910) pp. 1-302 (144 figs.).

§ Ann. Nat. Hist., vii. (1911) pp. 593-605.

New Unstalked Crinoid.*—A. H. Clark describes *Commissia pectinifer* sp. n. from Christmas Island. In this genus there are never more than ten arms, the cirri are numerous, and the distal cirrus segments (smooth in *Comatula*) always bear spines or tubercles. The new form differs somewhat abruptly from the others in the great length of the teeth of the comb on the earlier pinnules, and by the large proportion of pinnulars occupied by the comb.

Coelentera.

Oogenesis in Pelagia.†—Julius Schaxel describes the process of oogenesis in this jellyfish. The germ-cells are not at first distinguishable from the surrounding endodermic epithelium. There is no phagocytosis in the nutrition of the ovum. The processes that go on in the oocyte are minutely described, emphasis being laid on the emission of chromatin from the nucleus into the cytoplasm to form physiologically essential "kinetochromidia."

Fixation of Scyphistoma.‡—E. Hérouard finds that the pedal disc of a polyp, once detached from its substratum, cannot be re-attached. There is nothing of the nature of a sucker about the pedal disc. A chitinous lamella is first formed by the ectoderm, and fits the substratum exactly. Then very rapidly the ectoderm-cells also form numerous "tonofibrils," and disappear as these are differentiated. Finally, only tonofibrils are left between the chitinous lamella and the mesoglea.

History of Study of Coral-formations.§—Siegismund Günther gives an interesting account of pre-Darwinian studies of coral-reefs and corals; dealing with the views and observations of De Castro, Pyrad, Marsigli, Peyssonnel, Spallanzani, Chamisso, and many others.

New Genus of Antipatharia.—Kumao Kinoshita describes *Hexapathes heterosticha* g. et sp. n. from Sagami Bay. He refers it to the Cladopathinæ (= Schulze's Hexamerota), the third sub-family of Antipathidæ. The diagnosis reads:—Stem simple, with simple lateral pinnules arranged in two longitudinal rows, and with simple branchlets borne on the anterior surface of the stem; spines of the axis short, turned upwards, polyps elongated in the transverse axis; mouth situated on a high projection of the peristome; stomodæum long, reaching nearly to the axis sheath; sagittal tentacles given off from the level of the lower end of the stomodæum; mesenteries six in number.

Law of Budding in "Portuguese Man-of-war."¶—O. Steche has introduced some order into the rather perplexing "Wirrwar" of zooids in *Physalia*, and shows how the very aberrant arrangement of parts is due to the development of the huge pneumatophore. This has led to a shortening of the stem and an abandonment of the usual budding zone. Steche notices in passing that *Physalia* has what other Siphonophores do not seem to have—a power of regenerating lost appendages.

* Ann. Nat. Hist., vii (1911) pp. 644-5.

† Festschrift Richard Hertwig, i. (1910) p. 167-212 (4 pls. and 2 figs.).

‡ Bull. Soc. Zool., xxxvi. (1911) pp. 15-19 (3 figs.).

§ SB. Bayer. Akad. wiss. München, 1910, pp. 1-42.

¶ Annot. Zool. Japon., vii. (1910) pp. 231-4 (3 figs.).

¶ Festschrift Richard Hertwig, ii. (1910) pp. 355-72 (10 figs.).

Marginal Glands of Porpita.*—A. Issakowitsch describes the transformation of the epithelium of the "collar" into glandular cells. These show very distinct chromidia, and the author makes it clear that the chromidia play an essential part in the production of mucus.

Mediterranean Species of Halecium.†—S. Motz-Kossowska, in her survey of the Hydroids from the Western Mediterranean, deals with the species of *Halecium*, describing two new forms—*H. billardi* and *H. torreyi*—and giving some details in regards to others.

Hydractinia and Hermit-crab.‡—Seitaro Goto describes two species of *Hydractinia* (*H. sodalis* Stimpson, and *H. spiralis* sp.n.), very different in external appearance, which have the same habit of living always in symbiosis with a hermit-crab, *Eupagurus constantis* Stimpson, and of forming "shells" of their own entirely composed of a chitinous framework, so that in most specimens there is apparently no basis of Gastropod shell, as is the case in most other known species of *Hydractinia*. The skeleton of one of the species is totally devoid of spines, and its substance is very thin and papery, while that of the other is rich, armed with large spines, which are conical when small, but irregular in shape and branching when large.

Protozoa.

Studies on Amœbæ.§—A. Alexeieff describes two new species of *Amœba* (*A. densa* and *A. circumgranosa*), and discusses encystation and mitosis. There is no sign of any sexual process in connexion with the encystation in *A. punctata* or *A. limax*. In *A. punctata* the chromatoid bodies are so large that it is difficult to believe that they are formed from nuclear substances. In discussing the nuclear spindle the author points out that the fibres cannot be regarded as directive threads for the chromosomes. They vary greatly in their differentiation, and their significance is simply that for physical and mechanical reasons the plastin of the karyosome becomes more or less fibrillar when it is dividing.

Division in Amœba punctata.||—A. Alexeieff finds that the equatorial plate is formed at the expense of the peripheral chromatin. The formation of chromosomes is bound up with the presence of a plastin substratum which is absent in the granules forming the equatorial plate. These should not, therefore, be called chromosomes. There are no centrosomes, but their place is taken by polar bodies which may be homologous.

Division and Encystation of Amœba limax ¶—A. Alexeieff has studied one of the *limax* group of Amœbæ, *Amœba limax* Duj. (emend. Vahlkampf), which he obtains from hay infusions. The encystation has not to do with any conjugation-process. In the mitosis the

* Festschrift Richard Hertwig, i. (1910) pp. 305-22 (1 pl. and 2 figs.).

† Arch. Zool. Expér., vi. (1911) pp. 325-52 (1 pl. and 16 figs.).

‡ Journ. Exper. Zool., ix. (1910) pp. 469-96 (23 figs.).

§ C.R. Soc. Biol., lxx. (1911) pp. 588-91 (40 figs.).

|| Tom. cit., pp. 455-7.

¶ Tom. cit., pp. 534-5.

equatorial plate is formed chiefly at the expense of the peripheral chromatin, to which is added a variable quantity of chromatin coming from the karyosome.

Depression and Apogamy in *Amœba diploidea*.*—Rh. Erdmann has studied the degenerative nuclear changes and other signs of "depression" in this *Amœba* when the culture was kept at a temperature higher than the normal (25°–37° C.). The most interesting feature was the entire cessation of any sexual process. A facultative apogamy obtains, and the culture cannot be kept alive except by artificial aids. The sexual process which normally occurs has for part of its utility the counteracting of depressions and disturbances of the cell-functions.

Rhizopods from Lake District.†—James M. Brown has identified about fifty species from the English Lake District. Many are common forms; others, again, are less well known, while a few do not seem to have been recorded from this country. Among these *Paulinella chromatophora* Lauterborn, is of interest, having been found in only a few places on the Continent and in North America, and only as a single specimen from Loch Ness.

Notes on Marine Heliozoon.‡—Maurice Caullery has found at Banyuls on the fronds of a seaweed (*Peyssonotia*) an interesting Heliozoon, *Gymnosphæra albidula* Sasaki. It was previously found in the aquarium of the Zoological Institute at Munich, and probably came from Rovigno. It is about half a millimetre in diameter and easily seen with the naked eye. The nuclei are variable in number, up to twenty or thirty. The pseudopodia sometimes anastomose. Another new point is that individuals occur well-armoured with borrowed spicules of sponge and Holothurian.

Vegetative and Reproductive Processes in *Thalassicolla*.§—Th. Moroff describes what goes on in this Radiolarian during the vegetative and reproductive phases, with particular reference to the behaviour of the unusually large nucleus (0.3–0.4 mm. in diameter). He describes in detail, with very striking illustrations, the formation of isospores and anisospores, and discusses such points as the significance of nucleoli which are interpreted as forms of chromidia.

Hæmocystidium of the Gecko.||—C. C. Dobell has investigated *Hæmocystidium simondi* Castellani et Willey, a blood parasite of a Ceylon gecko (*Hemidactylus leschenaultii*). He describes the schizogony and the formation of the gametocytes. The genus *Hæmocystidium* is related to the malaria parasite *Plasmodium*, but the intracorpuseular phases are not amœboid; the schizogony takes the form of a simple bipartition, rarely a division into four; and the occurrence, so far as is known, is confined to cold-blooded animals.

* Festschrift Richard Hertwig, i. (1910) pp. 325–48 (2 pls. and 5 figs.).

† Journ. Linn. Soc. (Zool.) xxx. (1910) pp. 360–8 (1 pl.).

‡ Bull. Soc. Zool., xxxvi. (1911) pp. 3–7.

§ Festschrift Richard Hertwig, i. (1910) pp. 73–122 (65 figs.).

|| Tom. cit., pp. 123–32 (1 pl.).

New Parasite of Rat-flea.*—E. A. Minchin describes a new amoeboid parasite (*Malpighiella refringens* g. et sp. n.) which he found in the Malpighian tubes of the rat-flea (*Ceratophyllus fasciatus*), in which he was studying the transmission of *Trypanosoma lewisi*. The new parasite occurs principally in two forms, first an amoeboid form with a single nucleus, and secondly an encysted form with four nuclei. The author distinguishes *Malpighiella* from *Entamoeba*.

Inquiry into Sleeping Sickness.†—David Bruce, A. E. Hamerton and H. R. Bateman have made experiments leading to the following conclusions. Water-buck, bush-buck, and reed-buck can readily be infected with a human strain of *Trypanosoma gambiense* by the bites of infected *Glossina palpalis*. Yet careful and continued examination of the blood may fail to reveal the parasite. The antelopes mentioned, when infected as described, can transmit the infection to clean laboratory-bred flies, even eighty-one days after the last feed of the infected flies on a buck. The flies can pass on the virus to susceptible animals. It follows that antelope living in the fly-areas are "potential" reservoirs of the virus of sleeping sickness, but up to the present no antelope has been found naturally infected. In another paper ‡ it is shown that the Uganda fowl cannot act as a reservoir of the virus of sleeping sickness.

Protozoan Parasites from Trichoptera.§—Doris L. Mackinnon describes an interesting new Flagellate *Embadomonas agilis* g. et sp. n., from caddis-worms. It is a slipper-shaped form with one flagellum; the posterior end is pointed, the anterior end is blunt and rounded, and bent back at an angle with the long axis of the body. A large cytostome occupies almost all the anterior half of the body. The slender flagellum arises from a basal granule on the anterior margin of the cytostome. The nucleus is a diffuse mass containing several chromatin clumps; it lies in the extreme anterior end, in front of the cytostome. The caddis-worms also yielded *Crithidia campanulata* Léger, a species of *Entamoeba*, *Gurleya legeri*, *Trichomastix trichopterorum*, etc.

Trypanosome Studies.¶—F. K. Kleine and M. Taute have endeavoured to discover whether there is a sexual development of *Trypanosoma gambiense* within *Glossina palpalis*. There is no congenital transmission of the Trypanosome from fly to fly. Flies reared in the laboratory and once infected were studied. What the authors regard as male and female forms are carefully described. There is also a discussion of various species of Trypanosome that occur in the Tse-tse, e.g. *T. grayi*; of the unimportance of *Glossina morsitans* as a host of *T. gambiense*; of the habits of *G. palpalis*; and many other points of interest.

Trypanosoma rotatorium Gruby.¶¶—W. Lebedeff re-describes this Trypanosome of the frog, which is marked by striking polymorphism. There are four principal forms: "indifferent," "ordinary," "sterile,"

* Festschrift Richard Hertwig, i. (1910) pp. 291-302 (1 pl.).

† Proc. Roy. Soc., Series B, lxxxiii. pp. 311-27.

‡ Tom. cit., pp. 328-34.

§ Parasitology, iv. (1911) pp. 28-38 (1 pl. and 8 figs.).

¶ Arbeit. k. Gesund., xxxi. (1911) p. 1-58 (5 pls.).

¶¶ Festschrift Richard Hertwig, i. (1910) pp. 399-436 (2 pls. and 9 figs.).

and "chromidia-containing." The last become Crithidium-forms, the chromidia condensing into a nucleus. The Crithidia differentiate as males and females, conjugation occurs, and the result is a Trypanosome.

New Type of Suctoria on a Copepod.*—E. Chatton and B. Collin describe *Rhabdophrya trimorpha* g. et. sp. n., a very interesting new type of Acinetaria, which they found growing on a Harpacticid Copepod (*Cletodes longicaudatus*) at Banyuls. The new genus must find its place in the family of Trichophryidae, beside *Dendrosoma* and *Dendrosomides*, but it is very distinctive. It is trimorphic, there being tentaculate, vermiform, and reduced unicolor individuals.

New Trichonympha.†—Max Hartmann gives a fine description of *Trichonympha hertwigi* sp. n. from the hind-gut of Termites. He gives an account of the striking peculiarities of Trichonymphidae, such as the unique "head-organ," which seems to be a complicated blepharoplast. He describes young stages, the males and females, the division and the formation of gametes. The nucleus is a "poly-energid" nucleus—that is to say, it is made up of many individualized single nuclei, which have arisen by repeated division of a primarily single element within the original nuclear cavity. The author inquires whether the ordinary Metazoan nucleus is not a "poly-energid" nucleus. The Trichonymphidae are so peculiar, he says, that they may require a class like Ciliata for themselves.

Leucocytozoon in Fish-Eagle.‡—A. Laveran and L. Nattan-LARRIER describe *L. audieri* sp. n. from the fish-eagle, *Haliaeetus vocifer*. The parasites occur mainly in elements which appear to be altered red blood-corpuscles. The macrogametes and microgametes are described. Allied species occur in *Parus major*, *Syrnium aluco*, and *Melospiza gallopavo*.

New Hæmogregarine from the Horned Asp.§—A. Laveran and A. Pettit once more illustrate the common experience that when you tap a new host you find a new parasite. They describe *Hæmogregarina seurati* sp. n. from *Cerastes cornutus*.

Distribution of Myxosporidia.||—M. Anerbach gives a list of the known forms with their localities and hosts. Most of them are parasites of fishes, but one has been reported from *Nais*, and another from a butterfly (*Portrix*). Amphibians and Chelonians are also infected. The author discusses their occurrence in fresh-water and marine fishes, and their geographical distribution in general. Further investigations are urgently required.

Lankesteria.¶—B. Swarczewsky gives an account of a species of this Gregarine which he found in the gut of Turbellarians in Lake Baikal. He describes the formation of gametes, their conjugation, the formation of sporocysts, and the process of schizogony.

* Arch. Zool. Expér., v. (1910) Notes et Revue, No. 5, pp. cxxxviii-cxlv (3 figs.).

† Festschrift Richard Hertwig, i. (1910) pp. 351-96 (4 pls. and 3 figs.).

‡ C.R. Soc. Biol., lxx. (1911) pp. 686-8 (6 figs.).

§ C.R. Soc. Biol., lxx. (1911) pp. 95-6).

|| Zool. Jahrb., xxx. (1911) pp. 471-94.

¶ Festschrift Richard Hertwig, i. (1910) pp. 637-74 (4 pls.).

BOTANY.

GENERAL,

Including the Anatomy and Physiology of Seed Plants.

Cytology,

Including Cell-contents.

Life-history and Physiology of Nuclei.*—J. Schiller publishes the results of a year's study of the life-history and development of the nuclei of *Antithamnion cruciatum* f. *tenuissima* Hauck, and of *A. plumula* (Ellis) Thur. In the former the young nuclei and those of the lower cells are circular, the upper and full-grown ones elongate, bipolar or multipolar. In the side-shoots only the lowest cells have nuclei capable of division. Young nuclei have neither membrane nor network (which both develop later), but they have a large nucleolus which is extruded into the cytoplasm during nuclear division. Full-grown nuclei have no chromatin-bodies but many nucleoli, which are continually fragmenting and passing into the cytoplasm. This process ceases in the lower parts, where there is only one small nucleolus, also in darkness, where there are but a few very dark nucleoli. The basal cells of the short branches produce granules of an albuminous nature, which form building material for new short branches. The nuclei of *A. plumula* are very varied in form and of larger size, corresponding to the larger cells. As in the previous instance, there is rapid production of nucleolar material (sometimes as many as thirty-five nucleoli being formed), and a continual extrusion of it into the cytoplasm. As before, darkness causes cessation of this process, but upon re-illumination activity begins again on the second day.

All these nuclei behave in the same way as those of higher plants towards 3 p.c. HCl, conc. Na_2CO_3 , etc. The size of the nuclei, their extensive surface, and the rapid production of nucleolar substance seems to point to some special physiological activity. This activity is most marked in fertile plants at the time of fertilization.

Synopsis of the Nucleus.†—A. A. Lawson publishes the results of investigations dealing with the synopsis phase of the nucleus. The present work is mainly based upon a study of the microspore mother-cells of *Smilacina*, but is fully confirmed by observations made upon various types of Gymnosperms, Pteridophyta, Bryophyta, and Algæ. The chief conclusions are as follows. Spore-mother-cells, owing to their difference in function, are strikingly different from ordinary vegetative cells. Being stored with food materials for the benefit of the four spores, they are practically devoid of cytoplasmic vacuoles, but much sap accumulates in the nuclear cavity and causes a high osmotic pressure, which distends the nuclear membrane. The cavity expands to

* Jahrb. wiss. Bot., xlix. (1911) pp. 267-306 (2 pls. and 15 figs.).

† Trans. Roy. Soc. Edinburgh, xlvii. (1911) pp. 591-604 (2 pls.).

2-3 times its original size, and during this expansion the membrane is gradually withdrawn from the chromatin, with the result that a large clear area of nuclear sap is left, at the side of which is the mass of chromatin. This gave the appearance of a contraction of the chromatin, but actual measurements failed to show any diminution in area. Definite changes take place in the nature of the chromatin during the formation of the spireme. It appears that the number of threads forming the reticulum corresponds to the diploid number of chromosomes. The chromatin threads appear to be double even in the reticulum stage: they gradually shorten and thicken until they form definite chromosomes, but there is no evidence of their blending or fusion. Actual reduction occurs much later than the synapsis stage. The author regards synapsis as a growth-period of the nucleus during which the increasing karyolymph produces great osmotic pressure from within, resulting in an enlargement of the nuclear cavity towards the point of least resistance; the chromatin mass is left behind, and its position is a perfectly natural one.

Mycoplasma Hypothesis and Metachromatic Corpuscles.*—J. Beanverie contributes a brief note dealing with Eriksson's "mycoplasma theory" in reference to the infection of cereals by blight. The author has discovered numerous metachromatic corpuscles in the cells of the hyphæ of the parasite (on wheat), and believes that these are the so-called nuclei of former writers. Similar corpuscles are found in the cells of the host in the infected regions, but never in normal tissues. The author agrees with Marshall Ward and Klebahn in regarding Eriksson's "special corpuscles" as exogenous suckers, i.e., as simple suckers thrust by the mycelium filaments into the interior of the host-cells. The discovery of the metachromatic bodies may be the means of throwing new light upon the whole subject.

Movements of Plasmodia.†—V. Vonk publishes the results of his investigations concerning the rhythmic streaming of the protoplasm of plasmodia. The author concludes that this streaming is a rhythmic phenomenon consisting of two movements, viz., a progressive and a retrogressive movement, and as a general rule the progressive streaming is of longer duration than the retrogressive one. The duration of the rhythmic movement has a certain constant value for each particular plasmodium, but this value is only constant for the main stream; the additional side streamings at the beginning and towards the end of the phenomenon are subject to continual alterations. This fixed value increases with the growth of the plasmodium. The rhythmic movement may be disturbed by external mechanical means, e.g., shaking, the disturbance being made evident by the increase or decrease of the duration of rhythmic movement.

Chondriosomes in Plant-cells.‡—G. Lewitzky has found in the cells of the root of *Pisum sativum* and in certain meristematic tissues of *Asparagus officinalis* bodies which appear to correspond with the chondrio-

* Comptes Rendus, clii. (1911) pp. 612-15.

† SB. Akad. Wiss., cxix. (1910) pp. 853-76 (1 pl. and 3 figs.).

‡ Ber. Deutsch. Bot. Gesell., xxviii. (1911) pp. 538-46.

some of animal cells, and which appear to be an essential part of embryonic cytoplasm. With cell-development the chondriosomes are gradually converted into simple nuclei, nuclear threads, etc., the most remarkable change being their conversion into chloroplasts and leucoplasts. Pensa and others have independently made a similar discovery in certain living plant-cells, but, contrary to the present writer, regard the chondriosomes as of nuclear origin.

Heterogamic gemini in *Impatiens*.*—J. Granier and L. Bonle have studied the chromosomes of *Impatiens glanduligera* Royle, and find that, in addition to the ordinary chromosomes, the somatic cells possess two macrochromosomes, while the male and female cells possess only one. The fertilized ovum contains two macrochromosomes, so that one must be derived from the male cell and the other from the female. The authors find that by association of two double chromosomes a macrochromosomic group (gemini) is formed during the first stages of reduction-division, and in this group a chromosome of male origin always unites with one of female origin. Finally each sexual cell possesses one macrochromosome derived from the macrochromosomic group.

Carbohydrates in Seeds.†—E. Schulze and M. Pfenninger have made further experiments upon lupeose, but have been unsuccessful in proving it to be a simple substance, although there is every probability that this is the case. Numerous preparations of lupeose were made from different seeds and by different methods, but they were all of the same chemical nature, and the products resulting from hydrolysis were a glucose, galactose, and fructose, thus proving it to be a polysaccharide, probably a tetrasaccharid. All attempts to obtain crystals of it have been unsuccessful, thus indicating a difference between this body and stachyose, which it greatly resembles in many ways. Schulze and Godet have described two carbohydrates prepared from *Phaseolus vulgaris*, and experiments seem to show that they contain lupeose.

Structure and Development.

Vegetative.

Phloem of Juglandaceæ.‡—A. F. Hemenway publishes his first paper dealing with the phloem of Dicotyledons. The present work deals with six species of Juglandaceæ, and the author finds that the lateral sieve-plates have the same appearance and structure and seem to have the same function as the sieve-plates on the end-walls. The callus also appears to be identical. The large sieve-tubes have as large and numerous lateral sieve-plates as terminal ones. This is contrary to ordinary views, and it seems as though this is an ancestral character indicating that such lower Dicotyledons as the Juglandaceæ are nearly related to the Gymnosperms or Vascular Cryptogams. Possibly further study of this feature may be of use in a systematic classification from an anatomical standpoint.

* Comptes Rendus, clii. (1911) pp. 1020-22.

† Zeitschr. Phys. Chem., lxxix. (1910) p. 366. See also Bot. Centralbl., cxvi. (1911) p. 475.

‡ Bot. Gaz., li. (1911) pp. 130-5 (1 pl.).

Reproductive.

Gametophytes and Embryogeny in *Cunninghamia*.*—K. Miyake has studied the development of the gametophytes and the embryogeny in *Cunninghamia sinensis*, and the results are briefly as follows: The male cones begin to develop in the autumn preceding pollination; division of the pollen-mother-cell takes place in early spring and is quite typical, the reduced number of chromosomes being twelve. The mature pollen-grain contains a tube-cell and a smaller generative cell, and subsequent to pollination in April, the latter divides into body and stalk-cell. The pollen-cell reaches the female prothallium in June and enters the depression above the archegonium. The enlarged, spherical body-cell passes into the tip of the pollen-tube where it forms two equal sperm-cells, each containing much starch. The female cones likewise develop in the autumn and by the spring a single megaspore mother-cell is formed in each ovule. Division of the megaspore-mother-cell starts about the time of pollination with the synapsis stage when reduction apparently takes place. Of the three potential megaspores the lowest develops into the gametophyte. The female prothallium follows the same course of development as in other Conifers, and when young is surrounded by 2 to 4 layers of tapetal cells; later on the tapetum is reduced to a single layer, which is also more or less disorganized. The megaspore-membrane is double and well-developed. The archegonial complex of 13 to 16 cells is at the micropylar end of the prothallium, and is surrounded by a layer of sheath-cells; sterile prothallial tissue is found in the centre of the complex. Fertilization occurs early in July. The pro-embryo consists of three tiers of cells, the lowest of which develops into the embryo. *Cunninghamia* shows thus a close affinity with *Taxodium* and *Cryptomeria*, and the three genera are typical Cupressineae, but the sterile prothallial tissue in the archegonial complex seems to show that the first genus is the most primitive.

Significance of the Periplasmodium.†—E. Hannig continues his work upon this subject, and shows that the tapetum is characteristic and widely distributed. In the Bryophyta the Anthocerotaceae have a primitive tapetum and supporting cells, the Liverworts have a tapetum and elaters, while the Musci have a rudimentary tapetum-spore-sac. All ferns have a true tapetum. The Gymnosperms usually have a tapetum in both the micro- and megaspore, but that of the latter is often reduced. Among the Angiosperms both the Choripetalæ and the Monocotyledons have a typical tapetum in the microspore and a reduced one in the megaspore; in the Sympetalæ the male tapetum is typical, but the female tapetum has disappeared, being replaced to some extent by the "epithelium" of the integuments.

The periplasmodium is also a common feature. The tapetal cells remain distinct in the Bryophyta, but the ferns and Equisetaceae have a typical periplasmodium. In the Lycopodiaceae the tapetum remains; in the Psilotaceae the periplasmodium is doubtful, and in the Selaginaceae and Isoetaceae absent. The macrospore of the Cycadaceae retains its

* Beih. Bot. Centralbl., xxvii. (1911) pp. 1-25 (4 pls. and 2 figs.).

† Flora, ii. (1911) pp. 335-82 (3 figs.).

tapetum, the condition in the microspore is doubtful. In the Coniferæ the tapetum of the macrospore is reduced, but does not form a periplasmodium, and in the microspore it is doubtful. In the Angiosperms the tapetum, even when present, forms no periplasmodium in the macrospore, but there is usually a typical one in the microspore. The author then proceeds to trace the relations between the tapetum or periplasmodium and the spore-membranes, and shows how the membrane consisted at first of a typical exospore and epispore in the Bacteria, Fungi, and Algæ, gradually becoming modified, until in the Coniferæ and Angiosperms only the exospore remains. Finally he shows how the membrane of the embryo-sac corresponds with the similar structure of the male organ, but has gradually been modified to suit new conditions of germination, and the partially cutinized membrane of the embryo-sac of Gymnosperms finally disappears in the higher Angiosperms.

Physiology.

Nutrition and Growth.

Mineral Nutrition of Vascular Plants.*—J. de Rufz de Lavison publishes a paper describing a new theory as to the absorption of salts by vascular plants. Experiments were made with sections of stems, wounded roots, and with entire uninjured plants, and it is shown that absorption of salts in the first two cases gives no indication as to the amount absorbed by the entire, uninjured plant. This is conclusively proved by the action of such a salt as citrate of iron, which is freely diffused in the first two cases, but completely arrested by the endodermis in the last case. Further, while there is no fixed ratio between the amount of an iron salt in contact with the root and the small amount which diffuses into the aerial portion of the plant, there is a distinct ratio in the case of nitrites and chlorides of the alkaline metals and alkaline earths, probably due to some complex phenomenon of assimilation. The most important experiments are those of this class which prove that the root exercises a qualitative selection over the salts absorbed. There seems to be no anatomic cause for this, and the author believes that there is some inherent character in the protoplasm of the endodermis which brings about this result: the ordinary protoplasm does not appear to possess this property. Two main general conclusions may be formed, viz.: 1. Salts incapable of penetrating protoplasm are arrested by the endodermis and undergo a species of assimilation before passing further into the plant. 2. Salts capable of penetrating the protoplasm undergo a sort of filtration in the endodermis depending upon (*a*) the nature of the plant; (*b*) the nature of the salt; (*c*) the condition of the endodermis at the time of the experiment.

Living Cells in Relation to Transpiration and Sap-flow.†—J. B. Overton publishes the second paper dealing with his work on *Cyperus*, the following being the chief results obtained. A stem 15–60 cm. high will conduct sufficient water to preserve the turgidity of the leaves for 3 to 18 days, when a section of 5–30 cm. has been killed by steam. The

* Rév. Gén. Bot., xxiii. (1911) pp. 177–211 (2 figs.).

† Bot. Gaz., li. (1911) pp. 102–20 (2 figs.).

amount of water conducted diminishes from day to day, partly owing to a blocking of the vessels with a resinous substance formed through the disorganization of the contents of the sieve-tubes. The withering of the leaves is probably due less to lack of water than to the action of injurious substances passed into them from the dead cells. The withering leaves show all the symptoms of dying, i.e. rapid loss of water, discoloration of chloroplasts, and contraction of the mesophyll. The use of steam for killing the stem-cells is not so satisfactory as the use of wax at 110°C . : the latter causes less disorganization of the cells, less injury to the leaves, and does not cause marked decrease in transpiration. Stems, portions of which have been killed by prolonged treatment with picric acid, 95 p.c. alcohol, or CuSO_4 , conduct water for a comparatively long period, and allow new branches to develop. Picric acid, chromic acid, and HgCl_2 may increase the amount of water evaporated by poisoned plants, HgCl_2 causing the greatest loss of water.

Reduction by Roots.*—O. Schreiner and M. X. Sullivan have experimented with wheat-seedlings to determine whether roots have reducing powers, and may thus promote the fertility of the soil. It is found that when seedlings are grown in solutions of methylen-blue, etc., the colour is lightened, likewise in starch-iodide solution the colour is slowly discharged. Experiments with neutral, acid, and alkaline solutions of sulphur failed to show any hydrogenating action, and tests for the reducing SH group also failed to give results. Seedlings grown in very dilute solutions of KNO_3 reduced the nitrate to nitrite. Sodium selenite and sodium tellurite were also reduced, but reduction was retarded by the presence of free acids or alkalis or of toxic organic matters. The authors find that seedling-roots possess a power of reduction from the time of germination until the sixth or eighth day, when it is at its maximum; a gradual decrease is then perceptible. Whilst power of oxidation is retarded by acid reaction, the latter promotes reduction. The reduction-power is most marked in the parenchymatous cells, and is probably due to metabolic activity producing either an oxyorganic acid, or a complex, unsaturated compound, or an unsaturated fatty acid.

Latex Diastases of *Broussonetia*.†—M. Gerber contributes a note dealing with his work on the latex of *Broussonetia papyrifera* L. The author finds that the latex possesses properties similar to those of the pancreas of higher animals, since it contains three diastases capable of dealing with the fats, carbohydrates, and albuminoids of reserve food-materials, and rendering them fit for assimilation by young leaves and inflorescences. The activity of these diastases diminishes in autumn and more so in winter, but it never ceases entirely; in this respect the latex diastases differ from those of seeds which cease their activity while the seeds are latent, but this difference is accounted for, since *B. papyrifera* continues to live throughout the winter.

All the three diastases are not equally strong in all kinds of latex; in some cases the lipolytic diastase is most active, in others the amylolytic, and in others the proteolytic, the predominant diastase being in accordance with the nature of the food-reserve.

* Bot. Gaz., li. (1911) pp. 121-30.

† Comptes Rendus, clii. (1911) pp. 1611-14.

Liberation of Iron by Green Water-plants.*—H. Molisch has studied the action of green water-plants towards compounds of iron dissolved in water. The author finds that under the influence of light such plants can bring about the dissociation of iron from its compounds. Many of these plants give out an alkali, which, assisted by the oxygen liberated during carbon-assimilation, favours the breaking down of such compounds as iron acetate, iron citrate, etc. The liberation of iron from the sulphate and malate appears to be retarded in some cases, but this may be explained by the fact that some plants, e.g. *Elolea*, take up the iron and store it beneath their epidermis, until no further iron remains outside the plant. Iron can be stored in the form of oxide both in light and in darkness, but while the ordinary membrane of the epidermis is unaffected by light, a second membrane is found in close connexion with it on the upper surface, which is affected by light, and in this region the iron is deposited in another form.

The results obtained seem to show that submerged green water-plants (such as *Potamogeton*, *Ceratophyllum*, *Chara*, *Myriophyllum*, *Vallisneria*, *Elolea*, *Riccia*, and *Ranunculus*) and iron bacteria play an important part in nature in removing iron from water and in furnishing material for the formation of meadow iron-ore.

Irritability.

Action of Ultra-violet Rays upon Green Vanilla-pods.†—J. Pougnet has experimented with green vanilla-pods, which are odourless before they are ripe. Pods of varying degrees of greenness were exposed to the action of ultra-violet rays, and the author was able to induce the odour of vanilla in all cases, although in no case could he obtain crystals. Pods thus treated retained their softness and almost their original size for three months. Finally, they dried up, and in five months were only one-fourth of their original volume. In a second series of experiments the pods were treated with a 0.001 p.c. solution of $MnCl_2$; the effect of the ultra-violet rays was thereby much accelerated and accentuated.

Osmotic Pressure, and the Form and Structure of Plants.‡—J. Beauverie publishes a final paper in connexion with his recent work upon the alteration brought about in the form and structure of plants by variation in the osmotic pressure of the surrounding media. The investigator's first experiments were made with the lower fungi, e.g. *Aspergillus*, *Penicillium*, etc.; increased osmotic pressure in the culture-solution brought about a decrease in height of the aerial parts of the plant, together with lateral expansion of the cells, while the submerged portions became relatively of more importance. The experiments were then extended to *Phaseolus*, *Pisum*, *Lupinus*, *Zea*, and other higher plants. Seeds were grown in pure water, and in most cases hydrotropism was most marked, being more powerful than geotropism in the effect produced upon the roots. Seeds were then grown in a solution of common salt, with other conditions as before. The strength of the solution was increased each day until a concentration of 1.5 p.c. was reached.

* SB. Akad. Wiss., exix. (1910) pp. 959-84 (1 pl.).

† Comptes Rendus, clii. (1911) pp. 1184-6.

‡ Rév. Gén. Bot., xxiii. (1911) pp. 212-19 (8 figs.).

In the weaker solutions the roots endeavoured to rise out of the solution, but as the solutions were made stronger the roots appeared to adapt themselves and to plunge more deeply even than when in pure water. Internal modifications in structure, e.g. absence of pith and abnormal development of xylem, etc., correspond to external modifications.

General.

Traumatism in Relation to New Plant-forms.*—P. Bequerel contributes a note dealing with his work on *Zinnia elegans*. The author found that under the action of traumatism the floral structures undergo certain sudden modifications, e.g. in the structure of the capitula, change in colour of individual florets, and grouping of the flowers around the branches. In order to avoid errors due to insect-pollination, certain flowers were artificially pollinated and kept in muslin bags, and seeds thus produced were used for experiments. The only characters transmitted were those affecting the colour of the ligulate florets and of the bracts of hermaphrodite flowers; the author believes that the characters thus brought out in plants which, like *Zinnia*, are polyhybrids, are atavistic or teratologic ones, which these genera have exhibited sporadically for thousands of years.

Remarks on Strephonema.†—M. Dubard has examined several specimens of *Strephonema* Hook. fil., and is of the opinion that its characters are sufficiently distinct and marked to justify the formation of a new family which would form a link with the Rosaceæ (through the Amygdaleæ) on the one hand, and the Combretaceæ (through *Terminalia*) on the other. The special characters of this family would be the adherent base of the ovary, the semianatropic ovules, the peculiar structure of the seed and embryo.

Premature Fall of the Perianth.‡—H. Fitting describes a series of experiments made with the object of discovering the cause of the premature fall of the calyx and corolla. Most of the work was done in connexion with *Geranium pyrenaicum*, but other species of *Geranium* and plants like *Erodium*, *Linum*, *Verbascum*, *Veronica*, etc., which behave in a similar way, were also used. The causes of the phenomenon are many and various, and often act in a very short time. Usually the older flowers are more easily affected than the younger ones. Chemical compounds exert a striking influence. Thus the presence of coal-gas, excess of CO₂, tobacco-smoke, hydrochloric-acid vapour, chloroform, or ether vapour causes a more or less rapid fall of the sepals and petals. In *Verbascum thapsiforme* the results are seen in 30 seconds. Thermal variations produce similar results. In *Geranium pyrenaicum* response occurs at 40° C. at the end of 2½ minutes in old flowers, and 6 to 10 minutes in young ones: *Linum*, *Verbascum*, *Borago*, etc., respond in 25 to 60 seconds, while some species of *Erodium* respond at 33°–40° C. Shock, pollination, and wounding of the pistil produce similar results. That the premature fall is a vital process is evident, since it does not occur when the living

* Comptes Rendus, clii. (1911) pp. 1319–22.

† Rév. Gén. Bot., xxiii. (1911) pp. 220–3.

‡ Jahrb. wiss. Bot., xlix. (1911) pp. 187–266 (3 figs.).

tissues are rendered inactive by excess of heat or by deficiency of nitrogen. A well-defined separating tissue is found, however, at the base of the petals, and here at the time of fall there is a sudden increase in turgescence accompanied by increase in volume in response to external stimulus. This would appear to point to a phenomenon similar in character to those of sleep-movements, response to light, etc.

CRYPTOGAMS.

Pteridophyta.

(BY A. GEPP, M.A. F.L.S.)

Relation of Woodsieæ to Cyatheaceæ and Polypodiaceæ.*—O. Schlumberger gives an account of the characters of the families, Cyatheaceæ and Polypodiaceæ, and of the relation of the Woodsieæ to both families. He takes into consideration all the known characters of the gametophyte and sporophyte of the genus *Woodsia*. 1. The antheridia of *Woodsia* normally open by means of an apical lid-cell. 2. Hence the difference in this respect supposed to exist between the Cyatheaceæ and Polypodiaceæ falls through. 3. The only important difference in the antheridia of these two families lies in the structure of the lid-cell. 4. In *Diacalpe aspidioides* and *Woodsia obtusa* the antheridia have a divided lid-cell. 5. The antheridial wall-cells play an active part in the opening of the antheridium. 6. In the *Woodsia* prothallium occur transitions between the characteristic hairs of the Cyatheaceæ and the glandular hairs of the Polypodiaceæ. 7. The appearance of the prothallium when mature depends upon the conditions of nutrition during youth. Thus, moist-grown plants become crisped, while dry-grown plants form adventitious prothallia. 8. Under the influence of weak light, filiform adventitious prothallia can be made to produce branched filaments with antheridia. 9. By special conditions of culture, prothallia, which would produce normal embryos, may be induced to put out apogamous shoots. 10. In structure of sporangium and in position of annulus, the Woodsieæ examined agreed absolutely with the Polypodiaceæ type, with the exception of *Diacalpe*, which approaches Cyatheaceæ in the characters of its annulus. 11. In the Woodsieæ there is a reduction of the receptacle in the formation of the sorus. In *Peranema* the receptacle is stalked; in *Diacalpe* it is much reduced; in *Woodsia obtusa* the sporangia are formed on a slightly prominent hump; in *W. ilvensis* they are formed on the unchanged epidermal surface. 12. The indusium in *Hypoderris* arises out of a closed superficial ring; in *Woodsia obtusa* the ring is open towards the margin of the frond; in *W. ilvensis* the indusium arises out of single hairs, which later are raised upon a common base. 13. The indusium of *Cystopteris fragilis* is developmentally not to be regarded as inferior. 14. An indusium can only be inferior when it arises below the sporangia on the receptacle. 15. The Woodsieæ examined are all dictyostelous. 16. The muciferous canals of the Cyatheaceæ and Dicksonieæ arise by the mucous degeneration of the septa in a series of cells.

* Flora, cii. (1911) pp. 383-414 (figs.).

In conclusion, the Woodsieae-Woodsiiinae of Diels (namely, *Peranema*, *Diacalpe*, *Hypoderris*, *Woodsia*), with the exception of *Cystopteris*, form most probably a monophyletic series. In both gamophyte and sporophyte there is a continuous reduction. The group is certainly most nearly related to the Cyatheaceae, with closed inferior indusium, these two groups having been separated off from one another in early times. The Woodsieae, however, agree absolutely in sporangial structure with the Polypodiaceae, especially with certain species of *Polypodium*; and some of the Woodsieae with indusium open on the marginal side afford a possible transition to certain forms of the *Davallia* series.

Genera of Vittarieae.*—R. C. Benedict gives an account of the external morphology, venation, and relationships of the fern-tribe Vittarieae, under the four headings: tribal characters, genera, ontogenetic stages, general considerations. In summarizing his results he states that:—1. The Vittarieae represent a well-defined group probably related to the Pterideae and to the Aspleneae, and contain seven genera—*Monogramma*, *Hecistopteris*, *Vittaria*, *Polytaenium*, *Ananthacorus*, *Anetium*, *Antrophyum*. 2. *Monogramma dareicarpa* and *M. graminea* seem to possess the simplest leaf and stem-structure known among vascular plants. 3. The seven genera may be arranged according to their venation in a phylogenetic series, ascending from *Monogramma* to *Anetium* and *Antrophyum*. 4. The more advanced genera show in their ontogeny successive venation stages similar to those noted in the phylogenetic series. 5. They differ from most other ferns in beginning with a uninate type, but usually they show secondarily the free dichotomous venation found in other ferns. 6. The tribe illustrates clearly how one type of areolate venation may have been derived from a free dichotomous type. 7. In comparing the parallel adult and ontogenetic venation series, affirmative evidence for the theory of recapitulation is found in the inheritance in at least one primitive species of *Vittaria* of an unnecessary juvenile stage, which in another more advanced species of *Vittaria* has been eliminated.

Hymenophyllaceae in relation to Moisture.†—F. Shreve publishes some studies on Jamaican Hymenophyllaceae in relation to water-supply and atmospheric humidity. He sums his conclusions as follows:—1. The Hymenophyllaceae are most abundant at about 5070 ft. altitude. 2. The Jamaican species show differences ranging from the most pronounced hygrophily to a relative degree of drought resistance. 3. The differences of climate from floor to canopy in the rain-forest determine the local distribution of the different types of Hymenophyllaceae. 4. The low water loss from surface-dry leaves in a very moist atmosphere can be met by root-absorption in all but the most hygrophilous forms. 5. The transpiration current moves when the leaves are wholly or partly surface-dry, but is at a standstill when the leaves are thoroughly wet. 6. All but the most drought-resistant epiphytic species of Hymenophyllaceae are capable of living for considerable periods as submerged aquatics. 7. The drought-resistant species are capable of absorbing atmospheric moisture

* Bull. Torrey Bot. Club, xxxviii. (1911) pp. 153-90 (7 pls.).

† Bot. Gaz. li. (1911) pp. 184-209 (8 figs.).

when surface-dried, if kept in very moist air. 8. Continued desiccation results in the loss of the water of the sap-cavity of all mature leaf-cells, recovery depending on the duration of the desiccation. 9. The relatively xerophilous epiphytic Hymenophyllaceæ owe their ability to resist drought to the capacity of the protoplasmic utricle of the leaf-cells, both to survive the replacing of the sap-cavity by air, and also to lose a rapidly diminishing amount of water on continued desiccation. 10. The Hymenophyllaceæ (structurally and physiologically a very distinct group of ferns) have developed forms capable of growing in relatively dry situations, through possession of an intercellular or functional xerophily, much less pronounced than that possessed by many mosses and selaginellas, but like it in kind.

Significance of the Periplasmodium.*—E. Hannig has studied the origin and development of the periplasmodium in *Equisetum limosum* and in *Azolla*. In *Equisetum* the tapetal cells fuse into a multinucleate mass of protoplasm, and the individual cell-walls are replaced by a single new membranous sheath. The vacuolar substance towards the exterior of the periplasmodium gives rise to the middle lamella of each spore-membrane, and also to the elater sheath, which ultimately forms the elaters. The latter, which are of complex structure, arise at a definite part of the spore, and extend in a spiral manner towards both poles. The independent origin of the middle lamella and the elater sheath is definitely proved, and the periplasmodium must be regarded as a living protoplast, having a special formative and regulating function.

In *Azolla* the present unisexual sporangia have been evolved from a former bisexual condition. The origin of the periplasmodium is similar to that in *Equisetum*, but the subsequent developments are more complex. The periplasmodium undergoes a marked increase in volume owing to the storage and assimilation of starch. The vacuolar substance gives rise to the spores, of which each vacuole contains an equal number. In the macrosporangium thirty-one macrospores degenerate, while one develops, and under the influence of the periplasmodium the triradiate outgrowth on its surface is turned towards the micropyle. Within the periplasmodium, and derived from it, are the massulæ, with honeycomb-like walls, which eventually give rise to the swimming-body of the macrospore. The macrospore-sheath and the perispore are also derived from the periplasmodium. These results confirm those obtained with *Equisetum* as to the importance of the rôle played by the periplasmodium.

Lepidodendron Brownii.†—R. Chodat gives an account of the anatomy of a fossil stem, which he identifies as *Lepidodendron Brownii*, and which he finds to have essentially the structure of *Lepidostrabus Brownii* Schimp., as described by F. O. Bower.

Leaves of Calamites.‡—H. H. Thomas gives an account of the structure of the leaves of some species of the Calamocladus section of *Calamites*. In one, which appears to be *C. charæformis*, the leaves are very small, falcate, arranged in alternating whorls of four on slender,

* Flora, cii. (1911) pp. 209-78 (2 pls. and 24 figs.).

† Bull. Soc. Bot. Genève, iii. (1911) pp. 5-6, 8-13 (7 figs.).

‡ Proc. Roy. Soc., Series B, lxxxiii. (1911) pp. 490-1.

probably pendulous twigs—found in the Halifax Hard Bed of the Lower Coal Measures. The leaves have a concentric vascular bundle containing four to five small tracheids surrounded by thin-walled elongated cells, and by an external black sheath of melasmatic tissue. The palisade tissue contains large intercellular spaces. The epidermis is thinner on the concave side of the leaf, and here also are placed the stomata. In *C. grandis* and *C. equisetiformis* the leaves are of a xeromorphic type, having a conspicuous strand of sclerenchymatous fibres running up to the apex on the adaxial side of the leaf.

Calamostachys Ludwigii.*—A. Renier gives a careful description of some impressions of *Calamostachys Ludwigii* found in the Westphalian near Liège, in Belgium, including not only a study of the morphology of the spike, but also an idea of the habit of the spike-bearing branch. *C. Ludwigii*, like *C. Zeilleri*, is distinguished from the other species of the genus by having the sterile bracts free from the axis; but differs from *C. Zeilleri* in having but twelve to sixteen bracts in a verticil, as against twenty-eight in *C. Zeilleri*. *C. Ludwigii* of Carruthers exhibits certain variations, and is synonymous with *C. typica* of Schimper in connexion with *Asterophyllum longifolius* of Sternberg, with which it is constantly associated.

Calamites undulatus.†—W. Jongmans publishes his views about *Calamites undulatus* Sternb. He criticizes the classification originated by Weiss, and generally accepted, that the genus *Calamites* is divisible into three groups according to the position of the branch-scars:—1. *Eucalamites*, with branch-scars at every joint. 2. *Calamitina*, with branch-scars not on every joint, but on joints at regular short intervals. 3. *Stylocalamites*, branch-scars without order. He disagrees with this division, and describes several instances which fail to conform to the rule. These examples exactly correspond with *Calamites undulatus* in form and arrangement of the ribs, but differ altogether in the distribution of their branch-scars. He finds some to be of the *Calamitina*, some of the *Eucalamites* type, and some to have the characters of both groups. He believes that Weiss's division into three groups is wrong rather than that plants so similar in all their other characters should have to be placed in different groups. It is necessary to revise the genus *Calamites* on other grounds, such as the form and arrangement of the ribs.

Schizæopsis expansa, a Fossil Fern.‡—E. W. Berry gives a description of *Schizæopsis expansa*, a Lower Cretaceous species of Schizæaceæ from Eastern North America, which was formerly referred by Fontaine to the Ginkgoales under the names *Baieropsis expansa* and *B. macrophylla*. Berry shows that the genus *Baieropsis* belongs to the Filicales and not to the Ginkgoales; and that the name *Baieropsis* is not available for use. Some of the forms heretofore referred to *Baieropsis* have a Schizæaceous fructification; others belong to *Acrostichopteris*. The frond characters of the fossil *S. expansa* agree with those of certain modern species of *Schizæa*.

* Comptes Rendus. clii. (1911) pp. 1067-9.

† Meddel. van 's Rijks Herbarium, 1910. Leiden: 1911, pp. 43-59 (figs.).

‡ Annals of Botany, xxv. (1911) pp. 193-8 (1 pl.).

Anatomical Study of *Azolla filiculoides*.*—C. Queva describes the vascular anatomy of *Azolla filiculoides*. In the floating horizontal stem the vascular elements of the dorsal region are narrow tracheids, and those of the ventral region are wide vessels. The transverse section of the xylem is circular, the circle being incomplete alternately on the right and left sides in the dorsal region, corresponding to the alternating leaf traces. The wide ventral vessels are connected exclusively with the rootlets. The interpretation suggested is that the dorsal group of vessels represents a reduced bipolar group, connected at the poles with leaf traces; and that the ventral group is merely an apolar mass related to the rootlets. The amount of vascular tissue is remarkable for so hydrophytic a plant.

Spore-development in *Salvinia natans*.†—A. Kundt describes the development of the macrosporangia and microsporangia of *Salvinia natans*. The branching of the stalks of the microsporangia takes its origin in the outgrowth of any chance cell of the stem. The first divisions in the capitate end-cell lead to the formation of the sporangial wall—this wall remains one cell thick. The tapetum arises from divisions of the central cell; it remains always one cell thick; and the cells mostly contain two nuclei. The archesporium is divided up into spore-mother-cells, sixteen in the microsporangium, eight in the macrosporangium. Tetrad division is similar in both; and stages of nuclear division occur like those characteristic of the reduction in higher plants. The sporophyte has sixteen, the gametophyte eight chromosomes. The disorganization of the tapetum occurs at the time of the reduction-stage. Immediately afterwards the spore-mother-cells become free in the sporangium. In both kinds of sporangium the tetrads break up into spores. In the microsporangium all sixty-four spores ripen; in the macrosporangium one only, rarely two. The macrosore and its nucleus grow very strongly, the exospore and endospore being developed very late; and the epispore not until the spore is ripe and the tapetal nuclei have disappeared.

Aqueous Cultures of Fern Prothallia.‡—H. Fischer describes the advantages to be obtained by cultivating fern-spores on nutrient solutions rather than on sand or soil. For instance, the nutrition is under more accurate control; the results are clean from sand, etc., and do not injure the microtome knife; the cultures run no risk of drying up. Different results may be obtained by the employment of different depths of solution. Fern spores vary much in their capacity for germination. Some mature slowly after being shed, and then gradually lose the power of germination. Some are capable of germination after many years, for instance, *Ceratopteris* 20 years, *Asplenium serra* 48 years. Again, *Osmunda* and *Todea* speedily lose all power of germination. The author failed altogether to induce *Nephrodium montanum*, *Blechnum spicant*, and *Allosorus crispus* to germinate by any modification of his solutions; and he speculates as to why this should be. For general purposes he found the best nutrient solution to be K_2HPO_4 0.1 p.c., $MgSO_4$ 0.03 p.c., $CaCl_2$ 0.01 p.c., $NaCl$ 0.01 p.c., Fe_2Cl_6 0.001 p.c., NH_4NO_3 0.1 p.c.

* Mém. Soc. Hist. Nat. Autun., xxiii. (1910) 24 pp. (22 figs.).

† Beih. Bot. Centralbl., xxvii. 1^{te} Abt. (1911) pp. 26-51 (2 pls.).

‡ Beih. Bot. Centralbl., xxvii. 1^{te} Abt. (1911) pp. 54-9.

Influence of Light and Darkness on Germination of Fern-spores.*

H. Fischer discusses the germination of fern-spores in light and darkness, giving a brief résumé of the conflicting results obtained by Burgestein, Laage, and Schulze. Germination in the dark occurs in *Ceratopteris* and in the Ophioglossae. And now it is shown that the same thing can occur in *Polypodium vulgare*, but the resulting filament is etiolated. Germination in light appears to be the normal process.

Corsican Ferns.†—J. Briquet gives a list of the Pteridophytes of Corsica, amounting to forty-nine species and several varieties and forms. The distribution in the island, the synonymy and citations, are duly set forth; and some descriptive and critical notes are interspersed.

Queensland Ferns.‡—J. H. Maiden and E. Betehe publish notes on some ferns gathered by R. F. Waller in the Herberton district, Queensland. *Polypodium Walleri* and *Hymenophyllum Walleri* are described as new, and *Polypodium cucullatum* Nees and Bl., *Asplenium amannum* Presl and *A. normale* Don are recorded as new to Australia.

Malayan Ferns.§—C. R. W. K. van Alderwerelt van Rosenburgh has published a handbook to the determination of the ferns of the Malayan Islands, including those of the Malay Peninsula, the Philippines, and New Guinea. The work includes no less than 1587 species, classified mainly on the lines of Christensen's Index Filicum, and is provided with keys to the families, tribes, genera, and species. It contains about sixty new species, about half of which were published almost simultaneously, and figured, in the Bull. Départ. Agric. aux Indes Néerlandaises. The book had its origin in the task of naming the undetermined material in the Buitenzorg herbarium.

Subsequently he published || an enumeration of Malayan species of *Pleopeltis*, which is intended as a correction of the above-mentioned handbook. He accepts the view that it is better to regard *Pleopeltis* as generically distinct from *Polypodium*. He therefore separates off under *Pleopeltis* 113 species which appeared under *Polypodium* in the handbook. And he places *Selliguea* as a section of *Pleopeltis*.

He also has provided a revised list ¶ of Filices Horti Bogoriensis, ferns cultivated in the Buitenzorg Botanical Gardens, Raciborski's determinations having fallen out of date.

He gives the name *Stenolepia* to a new genus,** in which he places *Aspidium triste* Blume, a fern referred by others to *Alsophila*, *Cystopteris* and *Davallia*. He finds it to be allied to *Cystopteris*, and to have a superficial resemblance to *Diocalpe aspidioides*.

Chinese Ferns.††—H. Christ publishes a list of forty ferns collected in the province of Hupeh, and forty-three collected in the province of Szech'uan, by E. H. Wilson during the years 1907-1908. Descriptions

* Beih. Bot. Centralbl., xxvii. 1^{te} Abt. (1911) pp. 60-2.

† Prodroine de la Flore Corse. I. Genève: Georg, 1910, pp. 1-36.

‡ Proc. Linn. Soc., N.S.W., xxxv. (1911) pp. 799-802.

§ Batavia: (1909) xl. 899, and 11 pp. See also Bull. Soc. Bot. France, lvi. (1909) pp. 415-16.

|| Bull. Depart. Agric. Indes Néerlandaises, Buitenzorg, xxvii. (1909) pp. 1-12 (4 pls.).

¶ Tom. cit., pp. 13-44 (2 pls.).

** Tom. cit., pp. 45-6 (1 pl.).

†† Bot. Gaz., li. (1911) pp. 345-59 (figs.).

of the novelties are added—a new genus *Sorolepidium* (allied to *Polystichum*), eleven species and a variety. And a report by Prof. Sehn on the starch prepared from the rhizome of *Pteridium* at Ichang on the Yang-tze is included.

Bryophyta.

(By A. GEPP.)

Variable Leaf-border in Fissidens.*—J. Röhl writes on the leaf-border of *Fissidens Arnollii* Ruthe, which he states to be a variable character. On the same stem he finds leaves with and without a border, though as previously known the species was without any bordered leaves. The plant may be included in *Scutimbidium* just as readily as in *Aloma*. He discusses several other species which show a similar variability of leaf-border. This has led to an unnecessary multiplication of species. Limpricht regarded the leaf-border as so unstable a character that he forebore to describe it at all in the case of some of the European species.

Hepaticæ Infected by Fungi.†—A. J. M. Garjeanne gives an account of some fungi which infest the rhizoids of hepaticæ, and which in his opinion are not necessary to the life of the hepatics, and which do neither harm nor good to the host-plants. If there is a symbiosis, it is of a very ill-developed nature, unless in the case of *Calyptogeia trichomanis* and *Jungermannia barbata*. He gives a list of thirty-two hepaticæ which he examined, indicating opposite each species the extent to which it was observed to be invaded by fungi. All the species mentioned are as often found free from fungi, as invaded by them. In *Calyptogeia trichomanis* and *Lophozia inflata* the fungi are provided with haustoria which penetrate into the green cells. Various fungi take part in this infection; and among them is the new species, *Muror rhizophilus*, described by the author.

Inflorescence of Funaria.‡—J. M. Speer publishes some notes on *Funaria hygrometrica*, in which it is shown that not only is the species not "strictly dioecious," but when large quantities of it were examined, cases were repeatedly found where two to three antheridia occurred mixed with as many mature archegonia in the same inflorescence, rendered conspicuous by its size. Usually eight to twelve neck canal cells are found in the archegonium; an instance with twenty-two such cells is figured. Archegonia with two eggs and their proper rows of neck canal cells are figured.

Lesquerenxia.§—L. Loeske publishes critical remarks on *Lesquerenxia* and other allied genera. He sums up his views as follows: 1. Lindberg's *Lesquerenxia*, which can be maintained as a composite genus, includes nearly allied forms which may be grouped round *Lesqueræa sarxvola*, *Pseudoleskea atrovirens*, and *Ptychodium plicatum*. 2. The forms cannot however be separated into genera on the ground of single characters.

* Hedwigia, l. (1911) pp. 261-2.

† Flora, cii. (1911) pp. 147-85 (2 pls. and figs.).

‡ Bot. Gaz., li. (1911) pp. 225-7 (figs.).

§ Hedwigia, l. (1911) pp. 311-28.

such as the peristome, the central strand, etc., for then the result is apt to be too artificial. 3. If, however, the sum total of the characters is considered, then *Pt. decipiens* is at once seen to be a *Lescurea*, *Ptychodium affine* is a form of *Pt. plicatum*, while *Pt. Pfundtneri* and *Pt. oligocladium* are near allies of *Pseudoleskea atrovirens*. 4. The relations of *Lescurea saricola* and *L. decipiens* to one another, as well as of *Pseudoleskea oligocladium* and *Ps. Pfundtneri* to one another and to *Ps. atrovirens* are not yet explained. For this end they must be studied in their habitats.

Cratoneuron and Hygramblystegium.*—W. Mönkemeyer publishes his researches on *Cratoneuron* and *Hygramblystegium*. He recalls that V. F. Brotherus in Engler's *Planzenfamilien* kept *Cratoneuron* distinct from *Hygramblystegium*, on account of the numerous polymorphous paraphyllia and the second falcate leaves with long deep plicæ of the former species, as contrasted with the almost entire absence of paraphyllia (except in *H. filicinum*) and smooth leaves of *Hygramblystegium*. Mönkemeyer disapproves of the inclusion of *H. filicinum* in *Hygramblystegium*, and very fully states his reasons for transferring it to *Cratoneuron*. Also as to *Hygramblystegium commutatum*, he places it for similar reasons in *Cratoneuron*. He gives a full account of the varieties and forms of both these species, and discusses various other species.

Hygrohypnum ochraceum.†—M. Spindler discusses the great variability of *Hygrohypnum ochraceum*, a widely distributed species. Limpricht ascribed to it four varieties. Spindler adds another, var. *obtusifolium*. He says that the species is extraordinarily capable of adaptation to environment, and hence is very rich in forms. In it must be included *H. simplicinerve* (Lindb.), as has been indicated recently by L. Loeske.

Buxbaumia viridis.‡—I. Györfly publishes a third article on bryological rarities, and describes some diseased specimens of *Buxbaumia viridis* (*B. inclusata*), collected by him on rotting fir-trunks at certain places in the Hohen Tatra. The specimens were conspicuous owing to the fungal spots on the deformed capsules. He gives an account of the fungus (*Cladosporium herbarum*) and of the manner in which it attacks the moss. He enumerates twenty different localities at which the moss has now been found in the Hohen Tatra, where previously it had been regarded as exceedingly rare.

European Hepaticæ.§—K. Müller publishes another instalment of his monograph of Die Lebermoose in Rabenhorst's *Kryptogamen-flora*, and brings to a close the first volume of his work. He gives an account of *Harpauthus* (2 species), *Grocalyx* (1), and *Sarcogyna* (1), and adds a chapter on the development of the fruit-sac (marsupium) in the Jungermanniæ, using the following genera in illustration:—*Schistochila*, *Alicularia geoscypha*, *Tylimanthus*, *Mesoptychia*, *Balantiopsis*, *Calypogeia*, *Isotachis*. There are three types of fruit-sac: 1. Where the embryo bores its way down into the nutrient tissue (*Tylimanthus* type). 2.

* Hedwigia, l. (1911) pp. 263-78.

† Hedwigia, l. (1911) pp. 181-4 (1 pl.).

‡ Hedwigia, l. (1911) pp. 287-93.

§ Leipzig: Kummer, 1911, lief. 14, pp. vii. and 833-71 (figs. 358-63).

Where the archegonial inflorescence is carried down to the bottom of the developing sac, which is situated at right angles with the main axis of the plant (*Calyptogeia* type). 3. Where the archegonial inflorescence becomes enclosed in a cylindrical sac, a direct continuation of the axis of the stem (*Isotaris* type). These three types are connected by transitions. Title-pages, preface, and index to the volume are supplied.

New and Rare European Mosses.*—G. Roth gives descriptions and drawings of some mosses which, for lack of authentic material, he had been compelled to omit from his book, *Europäische Laubmoose* (1904-5). Twelve species and varieties belonging to various genera are fully treated.

British Bryophytes.†—W. Evans publishes a list of seventeen mosses and two hepatics, collected by him on the Isle of May, and forming a supplement to his previous list (1908). He found a curious *Pottia*, which H. N. Dixon refers to *P. asperula*.

Philonotis seriata with Fruit.‡—E. A. Richards records the finding of a fruit-bearing tuft of *Philonotis seriata* near Glen Isla and Glen Doll, Forfarshire, at the end of July 1909, at an altitude of 3000 ft.

Mosses of Spitzbergen.§—H. N. Dixon gives a list of eight mosses collected on Prince Charles Foreland, Spitzbergen, during W. S. Bruce's expedition in 1906-7. Their interest consists mainly in the fact that three of them do not happen to occur in I. Hagen's account|| of the mosses gathered by the expedition.

Muscineæ of Bornholm.¶—W. Mönkemeyer gives a list of the mosses and hepatics of Bornholm, with a résumé of the work of previous collectors, and notes on the physical geography of the island. He adds forty-five species and several varieties to the previous records of Jensen and others, and brings the totals up to fourteen Sphagnaceæ, 238 mosses, and fifty-eight hepatics. He figures a plant of *Pohlia nutans* with a double capsule, the columella having proliferated, so that it terminates in a subsidiary capsule.

Moss-flora of the Jura.**—L. Hillier has been studying the moss-flora of the lower Jura on the French side, between the altitudes 800 ft. and 2600 ft., his purpose being to do for the lower Jura what C. Meylan is doing for the upper. His results are expressed in an enumeration of mosses and hepatics, some of which have never previously been recorded for the Jura; some are new to, or rare in, the lower Jura, but are known or common in the upper Jura; and some are common in the lower, but rare or absent in the upper Jura.

German Bryophytes.††—V. Torka gives a list of the hepatics of the north-east of the province of Posen. He and H. Miller collected forty-one species. A larger number could not be expected in such flat country. The most interesting record is *Ricciella Hübenneriana* var. *nutans*, a new

* Hedwigia, l. (1911) pp. 299-310.

† Trans. Bot. Soc. Edinburgh, xxiv. (1910) pp. 91-3.

‡ Rev. Bryolog., xxxviii. (1911) pp. 69-70.

§ Trans. Bot. Soc. Edinburgh, xxiv. (1910) pp. 93-4.

¶ Op. cit., xxiii. (1908) p. 326.

¶¶ Hedwigia, l. (1911) pp. 333-49 (fig.).

** Rev. Bryolog., xxxviii. (1911) pp. 60-6.

†† Hedwigia, l. (1911) pp. 204-9.

variety, which adopts a floating habit as soon as it becomes covered with water. It is often associated with *Ricciocarpos utans*.

L. Loeske * gives an account of the moss-flora of Füssen and Hohenschwangau, in the Algan Alps. He describes the geological formation, mainly chalk, and groups the species according to their substrata, etc.—humus, mountain-tarns, pine-forests, rocks, tree-trunks, spray of waterfalls, woodland-paths, etc. He then enumerates his results in systematic order, namely, fifty-four hepatics and 202 mosses, with many critical notes interspersed.

E. Prager † publishes some supplementary notes on the moss-flora of the Riesengebirge, of Brandenburg, and of East Prussia. He treats of varieties and forms of *Drepanocladus* and *Calliergon*.

Bryophytes of Southern Europe. ‡—C. Warnstorff gives a list of the bryophytes collected by Max Fleischer in the south of France and in Spain in April–May, 1908. He records 153 mosses, seven hepatics, and two Sphagnaceæ. Three new species of *Bryum* are described, and several new varieties. Critical notes are appended to some six of the species.

Mosses of New Guinea. §—M. Fleischer gives an account of the new species of mosses collected in Dutch New Guinea by L. S. A. M. von Römer during the second Lorentz expedition. There are seven new species, and they were collected in the primeval forests on the snow-mountains of the interior.

Mosses of Eastern Asia. ||—E. G. Paris publishes his twelfth article on the mosses of eastern Asia, and treats of three collections—one made by P. Courtois in Kang Sou and Ngan Hoi, in eastern China; one by M. Met near Lao-Kay, in Tonkin; and the third by D. Eberhardt near Hué, in Annam. Forty-seven species are enumerated, and fifteen of these are described as new.

New Japanese Mosses. ¶—S. Okamura publishes some new contributions to the moss-flora of Japan. The following species are new to science:—*Buxbaumia Minakatæ*, *Haplohypnum brachycladum*, *Isotachis Makinoi*, *Dolichomitriopsis crenulata*; *Dolichomitriopsis* being a new genus of the family Lembophyllaceæ. A description is given of the fruit of *Scapania spinosa*, previously unknown. Two European species, *Buxbaumia aphylla* and *Pleuridium subulatum*, are reported as occurring in Japan.

Moss-flora in Central Asia. **—V. F. Brotherus gives a brief sketch of the bryogeography of Central Asia which he had an opportunity of studying during an expedition, equipped by Helsingfors University in 1896, to Eastern Turkestan and the Tian-shan Mountains. On the steppes mosses are very poorly represented, save for the endemic species *Tortula desertorum* and *Grimmia anodon* and *G. orbicularis*. By the irrigation-

* Tom. cit., pp. 210–48.

† Tom. cit., pp. 255–60.

‡ Hedwigia, l. (1911) pp. 189–203.

§ Hedwigia, l. (1911) pp. 279–86.

|| Rev. Bryolog., xxxviii. (1911) pp. 53–60.

¶ Bot. Mag. Tokyo, xxv. (1911) pp. 30–4, 65–8 (figs.).

** Förhandl. Nordisk. Naturf. och Lakaremötet. Helsingfors, xxi. 7 (1903) Bot., pp. 39–41.

canals a few species are found. There is no trace of moss or lichen on tree-stems, save on old and shaded willows near water. The wooded region of the mountains, especially the pine forests, provide a number of species. The author gives lists of the species found on rotten trunks, rocks, river banks, etc. The alpine region is fairly rich in species. The total moss-flora is about 220 species, and includes no species of *Androcæa* and *Sphagnum*. Hepaticæ are rare. The moss-flora is akin to that of Europe, only two genera—*Drummondia* and *Inlusiella*—being extra-European. The number of endemic species, apart from several forms of *Bryum*, is about ten.

Bryophyta of German Central Africa.*—F. Stephani gives an account of the hepatics collected by J. Mildbraed during the expedition of Adolph Friederich von Mecklenburg in German Central Africa, principally between Victoria Nyanza and Ruwenzori. The number of species is 56, and 48 of these are described and figured as new species.

C. Warnstorff † has determined the Sphagnales of the same expedition, five species and a variety. Three of the species are new.

V. F. Brotherus ‡ treats of the mosses of the expedition. In 250 specimens he found 137 species, 57 of which are new. Also 7 varieties and the genus *Leptodontiopsis* are new. The plants were collected in the following districts:—Bukoba-Bezirk, Ruanda, Rugega-Wald, Vulkan-Gebiet, Ruwenzori, Beni, Gr. Kamerunberg.

Bryophyta of Tropical West Africa.§—E. G. Paris publishes his twelfth article on the Bryophytes of French tropical Africa, the present consignment having been collected in Fouta Djallon, in French Guinea, by Pobegnin; near Bammako, by the Lieut-Governor of Haut-Senegal-Niger; in middle Casamance, by Etesse; and at Assikasso, on the Ivory Coast, by de Gondillac. In all, forty-six species and varieties are enumerated, and fifteen of these are described as new. Also ten hepatics, one of which is new, are recorded.

Bryophyta of North America.—G. B. Kaiser ¶ gives some field-notes about sundry good collecting-grounds for Bryophytes and Lichens in the Catskill Mountains.

R. S. Williams ¶ publishes a description of *Trichodon borealis*, a new moss collected by him near Dawson, Yukon Territory, in July 1899. It appears to be allied to the Scandinavian *T. oblongus*.

E. J. Winslow,** while collecting in a Sphagnum bog in Brownington, Vermont, in July 1910, discovered the rare moss *Paludella squarrosa*, which was previously unknown in New England, though recorded several times for Canada.

E. B. Chamberlain†† describes a peculiar form of *Hylocomium pyrenaicum* from Quebec, in which the leaves, instead of being acuminate, have a fringed 2-3 lobed apex. The meaning of the fringing processes is not apparent.

* Wiss. Ergebn. Deutsch. Zentral-Africa Exped., ii. (1911) pp. 111-34 (46 figs.).

† Tom. cit., pp. 134-6.

‡ Tom. cit., pp. 136-76 (5 pls.).

§ Rev. Bryolog., xxxviii. (1911) pp. 25-33.

¶ Bryologist, xiv. (1911) pp. 1-2.

¶ Tom. cit., p. 5 (fig.).

** Tom. cit., pp. 5-6.

†† Tom. cit., pp. 8-9 (fig.).

A. Lorenz * gives an illustrated account of the New England species of *Lophozia* of the Muelleri-group, which is Müller's subgenus *Leiocolea*. Two out of the seven species occur in New England, namely *L. Kaurini* and *L. badensis*. The author describes the habitats and plant-associations of these species, and gives citations from various authors concerning their habitats, etc., in other countries.

J. M. Holzinger † describes a new *Grimmia* of the section *Schistidium*, namely *Grimmia Kindbergii*. It was collected near Catala, Alaska, and it is identical with No. 80a of Macoun's Canadian mosses, but it is not *G. Agassizii* Lesq. and James, to which Macoun's plant was referred by Kindberg.

C. C. Kingman ‡ publishes some notes on hepaticæ of Southern California, which is a very dry district except in the winter months. On the foot-hills are found *Fossoubronia longiseta*, *Riccia trichocarpa*, and *R. glauca*. In the canyons are *Porella Bolanderi*, *Cryptomitrium tenerum*, and *Turgionia hypophylla*. On banks, etc., are *Anthoceros fusiformis* and *A. Pearsoni*, *Asterella californica* and *A. Palmeri*, *Cephaloziella Starkii* and *C. divaricata*. On trees are *Frullania catalinæ* and *F. Bolanderi*. In the town of Pasadena is *Marchantia polymorpha*.

G. E. Nicholls § publishes a second series of notes on Connecticut mosses, mainly devoting himself to a discussion of ten species which have recently been found in the state, and which, through their peculiarities or their distribution, are of interest.

Panama Mosses.||—R. S. Williams publishes a list of Panama mosses gathered partly by himself and partly by M. A. Howe. They come partly from the canal, and partly from districts to the east and west. Thirty-nine species are enumerated, two of them being new to science.

Brazilian Hepatics.¶—C. Massalongo publishes a list of hepaticæ collected by V. Mazzucchelli in 1904, in the Brazilian province of S. Paulo. Thirty-three species are enumerated.

Dryptodon Hartmani.**—N. Arnaoudoff gives a description of *Dryptodon Hartmani* (Schimp.), a rare species of Europe and North America, which had only been found in fruit four times, namely in Corsica, east Switzerland, Upper Hungary, and Montenegro. The species is not rare in the mountains of Bulgaria. And the author has found it fruiting in the forest zone of Berkovska Planina in the north of Bulgaria.

F. Renauld's Moss-herbarium.††—T. Husnot announces that the exotic mosses and the European mosses of the late F. Renauld's herbarium have been purchased by the Paris Museum; and the North American mosses by the Harvard University at Cambridge, U.S.A.

* Bryologist, xiv. (1911) pp. 25-31 (2 pls.).

† Tom. cit., pp. 31-32.

‡ Tom. cit., pp. 33-34.

§ Rhodora, xiii. (1911) pp. 40-6.

|| Bull. Torrey Bot. Club, xxxviii. (1911) pp. 33-6.

¶ Rev. Bryolog., xxxviii. (1911) pp. 9-12.

** Rev. Bryolog., xxxviii. (1911) pp. 43-5.

†† Rev. Bryolog. xxxviii. (1911) p. 48.

New Antarctic Genera.*—J. Cardot gives an account of two new genera from the Magellan region, *Neurolooma* and *Hygrodicranum*, found in a collection made by C. Skottsberg and F. Halle. *Neurolooma* belongs to the Andreaeaceae, and resembles *Chasmocalyx*, a sub-genus of *Andreaea*, except in the leaves, which are nerveless, but have on each side a characteristic intramarginal limb, 2 to 3 cells thick, composed of narrow elongate thickened cells. The plant was found by F. Halle in Tierra del Fuego. *Hygrodicranum* is also characterized by the peculiar structure of its leaves, which are bistratose in the lamina, and which in the lower half of the nerve show in transverse section an arc of 3 to 4 compressed encyests covered above and below by a stratum of stereids or substereids and a distinct epidermal layer. One sterile tuft of it was found by C. Skottsberg in the Falkland Islands.

Thallophyta.

Algæ.

(By Mrs. E. S. GEPP.)

Phylogeny of Algæ.†—J. Brunthaler has made a careful study of the phylogeny of the Algæ, and points out that many illogical errors have been arrived at by authors who have made the recent forms of too much importance. He discusses the whole question, and reaches the following conclusions. 1. The chromophylls of the Rhodophytæ, Phæophytæ, Zygophytæ, and Chlorophyceæ, are adaptations to the conditions of light which obtained at the time of their origin (complementary adaptation). 2. The recent Flagellatæ are terminal members of one of the oldest series or stock of the organisms; a direct relationship with the recent Algæ is not proven. 3. The Rhodophytæ must be regarded phylogenetically as the oldest group of Algæ; their origin is in the primitive ancestors of the Flagellatæ. 4. The Phæophytæ are the next youngest group, partly a side-branch of the Rhodophytæ, partly descendants of Flagellate-like organisms. 5. The Zygophytæ arise from ancestors of the Flagellatæ. The Peridinales show comparatively the closest relationship with the recent Flagellatæ. 6. The Chlorophyceæ are the youngest stage of development, arising, like the Phæophyceæ, partly from the Rhodophytæ, and partly from the ancestors of the Flagellatæ. A table of descent explains the views of the author. He states that at present it is not possible to say which of the Chlorophyceæ and Phæophyceæ are derived from the Rhodophytæ or Flagellatæ respectively, and he thinks that possibly a study of the cells may throw light on this point. The foregoing conclusions are the outcome of an attempt to delimit the different series of Algæ as the results of external factors, principally light, on the ancestors of the Flagellatæ.

Nutriments of Algæ.‡—O. Richter gives an account of the results arrived at by himself and others in the nutrition of Algæ, so far as

* Rev. Bryolog., xxxviii. (1911) pp. 49-52 (figs.).

† Biol. Centralbl., xxxi. (1911) pp. 225-36.

‡ Internat. Rev. gesamt. Hydrobiol. u. Hydrogr., ii. (Leipzig, 1911). See also Biol. Centralbl., xxxi. (1911) pp. 316-18.

they rest on exact data. Only cultures are described which deal with pure material and are free of bacteria. Thus the results are biologically exact. Chemical exactness was also obtained. It is seen that of mineral constituents, K, Mg, S, P, and perhaps Fe, are necessary. Occasionally, as in higher plants, Ca is needed. Diatoms alone need Si and Na. None of these elements can be entirely replaced by any other similar one, though the quantities may be partially made up by the addition of a nearly allied element. The meaning of the excretion of CaCO_3 by certain species is discussed.

Coccolithophoridæ from the Adriatic.*—J. Brunnthaler has collected and studied these organisms at Rovigno, and records seven species new to the district, one of them being also new to science, *Syracosphæra Lohmanni*. In August and September the commonest forms at Rovigno were *Rhabdosphæra stylifer*, *Syracosphæra pulchra*, *S. robusta*, *S. mediterranea*, *S. spinosa*, and *Pontosphæra inermis*. Noteworthy is the absence of the genera *Scyphosphæra* and *Coccolithophora*. The shortness of the time at the author's disposal for collecting may, however, be the cause of this.

Two Russian Chryomonads.†—S. M. Wislouch records two species of Chryomonadeæ new to Russia, *Synura reticulata* Lemm. and *Palatinella cyrtophora* Lanterb. He gives the dimensions of the latter species. On account of the smaller size of the cells, the author designates his find as a new form, *P. cyrtophora* f. *minor*. He gives a figure of it.

Euglena viridis.‡—H. Wager has made some experiments on the effect of gravity upon the movements and aggregation of *Euglena viridis* and other micro-organisms. He finds that, when placed in the dark in shallow vessels or narrow tubes, a peculiar aggregation of these organisms takes place into net-like patterns or more or less well-defined circular groups. The aggregation is only visible when the Englenæ are abundant, and is more regular and pronounced in a shallow vessel than in a deep one. Each group shows clearly two distinct regions, a central denser one, consisting of cells moving downwards, and a lighter peripheral area, consisting of cells moving more or less regularly upwards. This constant cyclic movement is kept up so long as the aggregation persists, and this may be for several days. In a good light the aggregation soon disappears, but reappears again in a few seconds when placed in the dark. If it be disturbed by the shaking of the vessel, it is re-formed immediately the disturbance has ceased. The aggregation does not appear to be due to currents set up in the liquid either by heat or evaporation; nor upon the presence or absence of oxygen or carbon dioxide, except in so far as these may be necessary to maintain the motility of the organism. The downward movement appears to be a purely mechanical one. Experiments were also made with *Euglena deses*, *Chlamydomonas*, *Volvox*, *Spirillum*, and one of the fresh-water Peridiniæ, in all of which the phenomena were visible, but with considerable variation in the extent to which it was produced. The author finally points

* Internat. Rev. gesamt. Hydrobiol. u. Hydrogr., iii. (1910-11) pp. 545-7.

† Bull. Jard. Imp. Bot. St. Pétersbourg, x. (1910) pp. 181-5.

‡ Proc. Roy. Soc., ser. B., lxxxiii. (1910) pp. 94-6.

out the advantage of these movements to species which, like *Englena*, are often found in a confined space in very large numbers. A constant circulation of them in all parts of the liquid is thus kept up, and they are prevented from accumulating in such dense masses as would be detrimental to them. He suggests that some of the peculiar phenomena of plankton distribution may be explained in this way.

Mastigocoleus testarum.*—This alga, which hitherto has only been known from salt water, is now recorded by G. A. Nadson from the river Bug, not far from the town of Nikolajew in South Russia, where the water is only sometimes brackish. Later he found it again in absolutely fresh water in the rivers Msta (Gouv. Nowgorod) and Narowa (Gouv. St. Petersburg), not far from their cataracts, where the alga bores into the limestone. This fresh-water form, which the author calls *Mastigocoleus testarum* Lagerh. var. *aquæ-dulcis*, is of a blue-green colour and its filaments are $6.5-7.5 \mu$ in diameter. It is distinguished from the typical salt-water form by the size and position of its heterocysts, which barely or not at all exceed the diameter of the vegetative cells; they have an intercalary or terminal position and are very rarely lateral. Two other chalk-boring species are often found with *M. testarum*, namely *Hyella fontana* Hub. & Jad. and *Plectonema terebrans* Born. & Flahault.

Injury to Water-cress Beds by Algæ.†—The Board of Agriculture have received specimens of *Oscillatoria irrigua* Kütz., which was causing great loss in some Hampshire water-cress beds, the alga having the appearance of a black cobweb at the base of the plants, which degenerated and died off. The algæ may be eradicated by the use of copper sulphate, one part to fifty million parts of water. The Board recommends that an estimate of the amount of water in the beds be made, and then the copper sulphate, enclosed in a piece of sacking, be slowly dragged through the water until dissolved.

Red-snow.‡—J. Murray gives a short and interesting account of the phenomenon known as red-snow, which, according to Schmarida, was mentioned by Aristotle. Remarks are made on its geographical distribution, which is world-wide in suitable localities—although the alga does not appear to be of general occurrence in snowy regions. In the Antarctic it is less common than in the North Polar region. The Shackleton Expedition found no indubitable red-snow, but it found abundance of red Rotifers, which increased with prodigious rapidity, and formed conspicuous blood-red stains on stones at the margins of lakes. It is now admitted that while *Sphærella nivalis* may be the commonest cause of red-snow, animals of various kinds may take part in producing the phenomenon.

Cell-division in Lyngbya.§—W. H. Brown describes cell-division in a marine species of *Lyngbya* (probably *L. majuscula*) occurring at Cold Spring Harbor, Long Island. In a cell of this alga there is a large

* Bull. Jard. Imp. Bot. St. Pétersbourg, x. (1910) pp. 151-3.

† Journ. Board Agric., xvii. (1911) pp. 988-9.

‡ Knowledge, xxxiv. (1911) n.s. viii. pp. 109-10.

§ Bot. Gaz., li. (1911) pp. 390-1.

central body or nucleus, which in the stages between divisions is, except for the absence of a limiting membrane, much like the resting-nuclei of the higher plants. The nucleus contains a mesh of fine fibres, along which small granules are scattered. The mesh is embedded in a clear substance resembling nuclear sap. The mesh stains like linin, and the granules like chromatin with Haidenhain's hæmatoxylin or Flemming's triple; although wanting a membrane, the nucleus is quite distinct from the surrounding cytoplasm. As a cell of the *Lyngbya* approaches division, fine fibres appear around the nucleus in a plane perpendicular to the longitudinal axis of the filament. These fibres, which closely resemble the spindle fibres of other plants, are very numerous, and run from the nucleus to the outer limits of the cytoplasm. They are all in practically the same plane, and thus form a plate across the centre of the cell in the place where the cross-wall, between the daughter-cells, is to be produced. At the end of each fibre there is laid down against the cell-wall a small granule, which stains black with Haidenhain's hæmatoxylin. These granules increase in size until they coalesce to form a ring around the centre of the cell. This ring marks the place where the cross-wall is to be formed, and it can still be seen, around the edge of this wall, after the wall has grown completely across the cell. The author points out that these facts tend to show that the nuclei of the Cyanophyceæ may have functions similar to those of the nuclei of other plants. The presence of the fibres may indicate paths of conduction from the nucleus to the cell-wall.

Two Epiphytic Algæ.*—J. W. Snow describes two new genera of minute epiphytic fresh-water algæ, containing each one species. *Pirulus gemmata* is recorded from Guatemala and also from Switzerland, growing on liverworts and mosses. In its early vegetative state it shows nothing distinctive, and might be mistaken for a *Chlorella*; but in the shape of its adult cell and in its mode of reproduction it is unique among all green algæ. The mature cell is pyriform, symmetrical, or irregular; reproduction is by budding, in which the smaller end elongates and is cut off by a membrane, after which a separation may occur or not. The author compares the fragmentation of the filaments to the similar process in *Hormidium*, and discusses the possible causes.

Aeronema polymorpha, the second alga described, also grows on mosses and liverworts, and on flower-pots in greenhouses, and may assume the characteristics of a typical unicellular alga, or may take on the nature of a well-branched filament. The form assumed by the plant is greatly influenced by the concentration of the culture medium. Details are given. The alga reproduces by means of zoospores, which are described. Their mode of germination seems to be the same as that in *Stigeoclonium*. The genus *Aeronema* is placed by the author near to *Conferva* or *Bumilleria*.

Gonium pectorale.†—B. Schussnig has been successful in observing the formation of gametes in *Gonium pectorale*. The material appeared in a culture-glass, and was presumably developed from resting-spores.

* Bot. Gaz., li. (1911) pp. 360-8 (1 pl.).

† Oesterr. Bot. Zeitschr., lxi. (1911) pp. 121-6 (1 pl.).

Formation and fusion of the gametes was induced by the addition of a 2 p.c. sugar solution to the culture. The gametes arose in colonies of sixteen, of small size, one from each mother-cell. When the gametes are ripe, they become free from the enveloping gelatinous sheath. The structure resembles in the main that of the ordinary cells. They are small, bare, and pyriform. After the gametes have swarmed for about an hour, they begin to copulate, sometimes showing marked disinclination or inclination towards a special gamete. The process is described in detail. The zygote rounds itself off, and in the course of a few hours develops a thick membrane, which is not, as Chodat states, wrinkled. The author allowed these hypnospores to remain dry for about eight to ten days and then moistened them, whereupon after a few days they began to germinate. Cell-division takes place and four microspores are formed. These when ejected are bare, at first without cilia, hanging together and passively motile. The connexion is probably caused by gelatinous matter. The ejection is caused by mechanical pressure. After a time the spores develop two cilia, and begin to move about in the water. Their further course is not known. This account of the formation of gametes differs greatly from that given previously by Chodat. Finally, the author gives details of the growth of the cilia, which have never been properly described, and adds remarks on certain abnormal growths similar to those already observed and described by Migula.

New Species of *Debarya*.*—S. R. Price describes and figures a new species of *Debarya*, collected from stagnant ponds on Sheep's Green, Cambridge. Specimens were transferred to algal culture tubs, where conjugation was observed. The process is very similar to that described for *D. desmidioides* and *D. Hardyi*. The author points out that *Debarya* may be regarded as a form from which two lines of evolution diverge, the one leading to the Mesocarpaceæ, and the other to the Desmidiaceæ.

***Pleodorina californica*.**†—E. Chatton publishes an exhaustive account of *Pleodorina californica* Shaw, which he has found and studied at Banyuls-sur-mer. Other authors describe the appearance of this alga in June, but Chatton records it as occurring at the end of April at Banyuls. He has succeeded in cultivating the alga and watching the process of reproduction, which he describes for the first time. A morphological study then follows. The rest of the paper is devoted to some cytological observations, remarks on the systematic position of *P. californica*, and finally some general reflections.

Corroding Alga.‡—W. Bialosuknia has made some interesting researches on *Diplosiphæra Chodati* Bial., a plenrococous alga isolated from a lichen from the limestone of Salève, viz. *Lecanora tartarea* Aeh. Experiments on this alga have shown that it possesses a power of corroding the limestone rocks, and that this action is not the result of an organic acid, but of a carbonic acid. The experiments are described in detail, and similar work of other authors on other plants is discussed.

* New Phytologist, x. (1911) pp. 87-9 (1 pl.).

† Bull. Sci. France et Belgique, ser. 7, xliv. (1911) pp. 309-34.

‡ Bull. Soc. Bot. Genève, ser. 2, iii. (1911) pp. 6, 13-18 (figs.).

Californian Green Algæ.*—D. H. Campbell points out that two species of green algæ, *Spondylomorom quaternarium* Ehren. and *Pithophora (Edogonia) Wittr.*, are not recorded in Collins' Green Algæ of North America, and are therefore new finds for central California. The former is also a new record for America.

Diatomic Structure.†—A. A. C. Eliot Merlin writes on some new diatomic structures discovered with a new Zeiss Apochromat. In *Craspedodiscus coscinodiscus* the presence of secondaries is confirmed. The shape of the primaries in *Epithemia turpida* and *Cymbella gastroides* Kütz. is described. The secondaries of *Gomphonema geminatum* Ag. are found to resemble those of *C. gastroides*; details of other species are also given. The observations were made with working apertures varying between 1.3 and 0.95 N.A. The author considers it probable that few, if any, diatomic valves possessing medium-sized primary perforations have such passages into the interior of the organism unobstructed or unprotected by caps pierced by finer holes. The limit of this capping is at present unknown, but probably species possessing very fine primaries, such as Naviculaceæ, do not require such protection.

Algological Notes.‡—P. E. Kaiser continues his notes on Algæ. The first of the present contribution describes the finding of *Enteromorpha percursa* J. Ag. in ditches of the saline marshes at Bad Elmen near Magdeburg. The author discusses the formation of the thallus, which may consist of as many as four cells in transverse section, arranged in the form of a square. *E. percursa* (a common marine alga) has previously been found inland in saline swamps near Tenditz (between Leipzig and Magdeburg), and from the "Salzigen See" near Halle. The second note records the presence of *Homorochadia germanica* Richter on stones in the Elbe above Schönebeck. The diatoms were enclosed in long gelatinous sheaths 17–28 μ broad, unbranched and brownish green. Richter has recorded this species from Kötschau near Leipzig, and stated that in cultures it escaped from the sheath and lived free, thus showing that the sheath was merely a protection for the frustules against the flowing water. The water, both of the Elbe and that at Kötschau, is not quite devoid of salt. In the third note the author records *Fragilaria amphiceros* Schütt from the Waginger See near Traunstein in Upper Bavaria. The form approaches var. *rhombica* Grunow. It has till now only been found in salt or brackish water.

Deformation of Ascophyllum nodosum.§—L. Lutz describes a remarkable deformation of the thallus of *Ascophyllum nodosum*, which takes the form of an infundibuliform branch. The author explains this growth on the theory that for some reason the normal development of the terminal mother-cell has been arrested, and since this cell is always at the base of a small depression in *A. nodosum*, a hollow has been formed by the continued growth of the surrounding cells. The cause of the arrested development in the mother-cell cannot so far be accounted for,

* Torrey, xi. (1911) p. 17.

† Journ. Quekett Micr. Club, ser. 2, xi. (1911) p. 199–202.

‡ Hedwigia, l. (1911) pp. 329–32.

§ Bull. Soc. Bot. France, lvi. (1900) p. 606.

since no parasite, either animal or vegetable, was detected in another small branch where similar growth was just beginning.

Medulla-cells of Laminariaceæ.*—M. G. Thoday describes and figures a reticulate thickening which occurs in the walls of the cells of the medulla in Laminariaceæ. It was well-developed in the walls of both the primary pith-filaments and the hyphæ, but was not present in the much thinner walls of the secondary sieve-tubes. After various experiments she found that the thickenings depended entirely on the methods followed in preserving, staining, mounting, etc., and are due to wrinkling consequent on partial dehydration; and since they begin to appear after very slight drying, they afford a remarkable indication of the very mucilaginous nature of the longitudinal walls of the medulla-cells in their normal state. At the base of the stipes, where all the cell-walls of both cortex and medulla become much thickened and cartilaginous, this wrinkling does not occur on drying.

Fructification of *Macrocystis*.†—E. J. Hoffmann discusses the geographical distribution of *Macrocystis pyrifera*, and describes the results of her studies on the fructification. She gives a résumé of the work of previous authors, and shows that some of them have arrived at erroneous conclusions evidently through studying wrongly named material. The author states that the fructification is found, not only on newly-formed unsplit bladderless basal leaves, but also on branched leaves, with or without a bladder, such leaves occurring near the holdfast of the plant. The sori are not in furrows, but in wide patches on both sides of the leaf, and consist of paraphyses and zoosporangia.

***Ahnfeldtia gigartinoides*.‡**—A. S. McFadden discusses the nature of the carpostomes in the cystocarp of *Ahnfeldtia gigartinoides*. The cystocarp is the only form of fruit known in this species; and in each cystocarp are formed some forty carpostomes, or long narrow irregular slits which pass through the anticlinal layers of the pericarp. The carpostomes are filled with several-celled filaments, which are projections of the cells of the anticlinal rows. The origin of the carpostomes is doubtful, but there seem to be indications that these slits are formed by decomposition. She also discusses the difference between *A. gigartinoides* and *A. concinna*.

***Erythrophyllum delesserioides*.§**—W. C. Twiss writes on the structure and development of the papillæ and cystocarps of *Erythrophyllum delesserioides*, and describes them in detail. As a result of his studies, he comes to the conclusion that this alga, by virtue of the character of its fruiting proliferations, its so-called compound cystocarp, with spore-groups separated from each other by partitions of vegetative cells, and by virtue of its vegetative structure, belongs among the Gigartinaceæ, as Agardh at first stated. Furthermore, the character of the carpogenic branch, and the method of spore-formation, only strengthens the belief, which the vegetative structure at once suggests, that its place, according to the present classification, is very near to the Callymenieæ.

* New Phytologist, x. (1911) pp. 68-70 (figs. in text).

† Univ. California Publications (Bot.) iv. (1911) pp. 151-8 (1 pl.).

‡ Univ. California Publications (Bot.) iv. (1911) pp. 137-42 (1 pl.).

§ Univ. California Publications (Bot.) iv. (1911) pp. 159-76 (4 pls.).

Colacodasya.*—M. E. McFadden describes a new species of *Colacodasya*, found in southern California by Farlow, and later by Gardner. It is parasitic on *Mychodea episcopalis* J. Ag., and appears as little whitish nodules along the *Mychodea* thallus. The penetration and manner of growth both inside and outside the host are described. From the wart of tissue outside the *Mychodea* thallus arise branches which bear the organs of fructification. Antheridia, cystocarps, and tetrasporangia are found, each borne on a different plant. The structure of the branches is of the Polysiphoniæ type. The reproductive organs are described, and the reasons are given in detail for placing this plant in *Colacodasya*. The only other species of that genus is recorded from South Georgia.

Melobesiæ.†—Mme. P. Lemoine has made an important and exhaustive study of the anatomical structure of the Melobesiæ, and finds that it serves as a sure guide to the classification of both genera and species. The genera examined by her are *Lithothamnium*, *Lithophyllum*, *Archæolithothamnium* Rothpletz, *Phymatolithon* Foslie, *Clathromorphum* Foslie, and *Goniolithon* Foslie. All the many species of these genera have not been examined, but a certain number of species of each group have been examined, including in each case those from various regions warm and cold, those which form a crust, and those which branch. In those species which branch, the basal encrusting portion has also been taken into account. As a result of all this careful work, the author finds that the anatomical differences of the genera and species correspond, with but few exceptions, with the already recognized definitions of the reproductive organs. All the species examined are described in the fullest detail, and their synonymy and geographical distribution are given. Several species are found to be but forms of one another, and the importance of the presence of bipores or tetraspores respectively as a specific character is shown to be over-rated. The author regards this variation as arising rather from differences of climate, age of the spore, etc. The fossil forms are taken into consideration, and the fundamental difference of structure which exists between *Lithothamnium* and *Lithophyllum* is shown to have existed since Silurian times. A synopsis of the characters of all the species examined is given in the form of tables. The work is well illustrated, and forms a most valuable addition to algal literature.

Classification of Melobesiæ.‡—Mme. Lemoine writes an important paper on the classification of the Melobesiæ, based on anatomical structure. The Corallineæ have already been classified on similar lines by Weber van Bosse, but till now the Melobesiæ have been untouched from this side. The author of the present paper, however, places the classification of this group on a clear footing purely on anatomical characters. She divides Melobesiæ into groups according to whether the species are crust-forming or branched, the presence or absence of a hypothallus, and the respective characters of hypothallus and perithallus. She describes five types of structure, represented by (1) *Lithothamnium*; (2) *Lithophyllum*; (3) *Archæolithothamnium*; (4) *Tenarea tortuosa*; and

* Univ. California Publications (Bot.) iv. (1911) pp. 143-50 (1 pl.).

† Ann. de l'Institut. Océanogr., ii. (1911) 213 pp. (5 pls. and figs. in text.).

‡ Bull. Soc. Bot. de France, cvii. (1910) pp. 323-31, 367-72.

(5) *Porolithon onkodes*. Finally, the author divides up the genera *Lithothamnium* and *Lithophyllum* into sections according to anatomical characters, giving the species which fall into each section. A few words are given to the genera *Melobesia* and *Mastophora*. This paper is of great value to systematists, since it shows how the genera of the Melobesiæ can be distinguished in the absence of reproductive organs, hitherto deemed indispensable; indeed, by means of anatomical characters, genera which have with difficulty been distinguished even with the help of anatomical characters, can now be recognized with ease.

Lithophyllum fasciculatum.*—A. D. Cotton points out an omission in the valuable Catalogue of British Marine Algae, published in 1902 by Batters. That author there omits all mention of *Lithophyllum fasciculatum* Fosl. (= *Melobesia fasciculata* in Harvey's Phycologia Britannica), including instead its varieties under *L. Racemus*. Certain evidence shows clearly that the omission was an oversight, and in the present paper the distribution of the two species is given. *L. Racemus* Fosl.: North Atlantic, Mediterranean, Adriatic, English Channel (Falmouth, only dead specimens known), Bahamas, Red Sea, Indian Ocean (Mauritius, Rodriguez). *L. fasciculatum* Fosl.: Co. Galway, Co. Cork, Co. Waterford.

Algae of the West Coast of Norway.†—H. Kylin writes on the marine algae of the west coast of Norway, which he studied during a visit to a village near Bergen in 1908. He remarks on the different formations of the open and of the protected coast, dividing the former into the *Porphyra*, *Callithamnion*, *Corallina*, *Gigartina*, *Himanthalia*, *Alaria*, and *Laminaria* formations. In the latter the formations are *Pelvetia*, *Fucus Areschougii*, *Ascophyllum Fucus*, *Fucus serratus*, *Halidrys*, and *Chordia*. These formations he discusses shortly. Then follows a list of species found by him, to which he appends in many instances critical notes and figures. He adds thirty-five new records to the algae of that coast, of which three are new to science, *Pseudopringsheimia penetrans*, *Streblonema inclusum*, and *Asperococcus norvegius*.

Edward Perceval Wright (1834-1911).‡—E. P. Wright is the subject of an anonymous obituary notice. While a student at Trinity College, Dublin, he became for twelve years editor of the Natural History Review; and while reading for his medical degree was lecturer in zoology and botany. He qualified himself to specialize as an oculist, but, becoming appointed *locum tenens* for W. H. Harvey, he determined to abandon ophthalmological work in 1866, and to take up science as his profession. After his expedition to the Seychelles Islands in 1867, the success of which was injured by a shipwreck, he published a number of papers on his results. In 1869 he was appointed Professor of Botany in succession to Harvey, and published some important papers on the structure and development of Algae. He spent much time in putting the College Herbarium into proper order. In the bibliography appended to the notice sixty of Wright's papers are cited.

* Journ. Bot., xlix. (1911) pp. 115-17.

† Arkiv Botanik, x. (1910) pp. 1-37.

‡ Notes Bot. School Trin. Coll. Dublin, ii. (1910) pp. 91-7 (portrait);

Fungi.

(By A. LORRAIN SMITH, F.L.S.)

Homothallic Conjugation in *Rhizopus nigricans*.*—Florence A. McCormick records an undoubted case of conjugation between two closely approximate parts of the same hypha. The material was grown from spores on bread moistened with a solution of grape-sugar. Blakeslee had already admitted the possibility that a homothallic race may occur in a normally heterothallic species, such as *Rhizopus nigricans*.

Norwegian Mucorini. II.†—O. Hagem published his first paper on the Mucors of the soil in 1907. He now gives the results of culture experiments to test nutrition and growth conditions. The behaviour of these moulds in these respects differs in the various species. About thirty species in all have been isolated from the soil; the differences found to exist among them, as to the substances on which they can live, are described, but, in general, the author found that fungi are obliged to reduce all nitrogen compounds into ammonia before they can utilize them as nutriment.

These soil fungi are harmful, so far as they withdraw ammoniacal salts from the soil, changing them into fungal albumen; they are beneficial in decomposing the nitrogen compounds of decaying vegetation and in transforming them into ammoniacal compounds.

Infection of the Vine by *Plasmopara viticola*.‡—H. Muller-Thürgau has carried out a series of infection experiments on vine-leaves to study the methods by which the false mildew fungus spreads so rapidly. The longer the time given, the more infections were found on the leaves, which were kept in a damp chamber. Very rarely were any spores found to have pierced the upper epidermis; usually infection took place by the stomata of the under surface; if, however, the epidermis was scratched or wounded, the spores germinated and entered the leaf at the injured spot. The best results were obtained with young leaves. Even when older leaves were infected, the fungus failed to grow with vigour, and only a few conidiophores were formed.

Experiments with *Phytophthora*.§—G. H. Pethybridge has made a series of experiments to test the theory that potato-blight is kept alive and spread by means of dormant mycelium in the tuber. Among other experiments, he planted thirty-two diseased tubers, and though many of them rotted in the ground fifty-three plants developed, not quite so robust as those grown from healthy tubers, but perfectly free from the fungus. Later they were attacked by the disease in the ordinary fashion from wind-borne spores, the outstanding leaflets being first infected, the stalks meanwhile remaining free from the fungus. He concludes that there is no evidence at present to show that the disease is caused otherwise than by aerial spores. Diseased tubers left exposed might very well produce a crop of spores which would easily give rise to an epidemic of *Phytophthora*.

* Bot. Gaz., li. (1911) pp. 229-30 (1 fig.).

† Vid.-Selsk. Skr. I. Math.-Nat. Kl., iv. (1910) 152 pp. See also Bot. Centralbl., cxvi. (1911) pp. 256-7.

‡ Centralbl. Bakt., xxix. (1911) pp. 683-95 (fig.).

§ Sci. Proc. Roy. Dublin Soc., xiii. (1911) pp. 12-27.

Nuclear Evolution in Ascomycetes.*—A. Guilliermond reviews the whole history of nuclear discovery in the Ascomycetes, giving special attention to work done on *Humaria rutilans*, *Peziza catinus*, *Pustularia vesiculosa*, and *Galactinia succosa*, with an account of his own observations and work on these forms. He concludes that the number of chromosomes is constant in the three divisions of the spore nucleus of the ascus, and he therefore dismisses the theory of a second reduction during spore-formation.

Mildew of the Vine in Poland.†—J. Brzezinski states that the vine is not frequently cultivated in Poland on a large scale, though there are vines in most private gardens. *Oidium Tuckeri* has occurred only occasionally up to the present, and generally on plants recently imported. The author, however, records an outbreak of the mildew which re-appeared three successive years. He found also the perithecia of *Uncinula americana*, the perfect fruit form, but only in more sheltered positions. In the autumn of 1910, which was exceptionally cold, no specimen of *Uncinula* could be found. The parasite, however, had been so far acclimatized as to persist during three successive seasons.

Oak-mildew.‡—Paul Magnus discusses the question as to the affinities of this mildew. He decides that the *Oidium* belongs to the genus *Microsphaera*. The Pyrennaean oak *Quercus Tozza* was the first and the most severely attacked from western France down to Morocco, and he argues that a *Microsphaera* allied to *M. Alni* has attacked the oak as a new host, and so far has only formed oidia. Other cases of such transference from host to host are quoted. The American tree *Quercus rubra* remained untouched by the fungus side by side with European oaks that were attacked.

Pythium de Baryanum.§—L. Peters found this fungus attacking seedlings of *Pelargonium*, both before and after the roots were formed. The plants are most liable to be attacked in heavy damp soil. Spinach plants were also attacked by the same fungus, and the stems blackened at the base. The fungus was either *Pythium de Baryanum* or one nearly allied.

Monochytrium, a New Genus of the Chytridiales.||—R. F. Griggs found the new fungus on the ragweed, *Ambrosia artemisiifolia*. It inhabits the cells of the host, usually epidermal or hypodermal, but causes very little hypertrophy. It is difficult to find and is not abundant. *Monochytrium* is distinguished by the binucleate sexual resting-spores and the solitary zoosporangia. A detailed account of the development and cytology of the fungus is given so far as has been observed.

Helvella crispa.¶—D. Carruthers has followed the development of ascus and spores in *Helvellæ*, and gives an account of her observations.

* Rev. Gén. Bot., xxiii. (1911) pp. 89-120 (2 pls.).

† Bull. Int. Acad. Sci. Cracovie, 1911, pp. 1-6.

‡ Ver. Ges. Luxemburg Naturfr., 1910, pp. 108-111. See also Centralbl. Bakt., xxx. (1911) p. 114.

§ Gartenflora, lix. (1910) p. 209. See also Centralbl. Bakt., xxix. (1911) pp. 115-6.

|| Ohio Naturalist, x. (1911) pp. 44-54 (2 pls.).

¶ Ann. Bot., xxv. (1911) pp. 244-52 (2 pls.).

There is a loose tangle of hyphæ in the hypothecium, each cell containing one, two, or several nuclei. Certain of these nuclei fuse in pairs, and the cells in which they occur produce the ascogenous hyphæ. The characteristic erozier is formed with a terminal uninucleate cell and a penultimate binucleate cell, from which the ascus arises. Occasionally the end cell fuses with the stalk and forms another ascus. Evidence was obtained that mitosis shows two chromosomes in the vegetative hyphæ and four in the ascogenous hyphæ. On the formation of the ascus a second fusion takes place, the chromatin of the nuclei remaining distinct until the spore stage. Division of the ascus nucleus for spore formation takes place, and the writer holds these two constitute a meiotic phase. Extrusion of chromatin bodies was observed; the spore thread showed longitudinal duplication. A certain amount of contraction then takes place; afterwards the thread loosens out again, and finally breaks up into four gemini. A final contraction takes place when the chromosomes pass on to the spindle. In the first two divisions there are four chromosomes on the spindle; the third division is brachymeiotic; there are four chromosomes in the prophase, only two passing to each pole.

Mushroom Poisoning.*—J. Dearnness writes on the personal factor in poisoning due to eating fungi, and calls attention to the fact that many people find that certain articles of diet, wholesome usually, are more or less poisonous for them. There are these dietetic idiosyncrasies that apply to fungi as to other articles of food. Again, he states that imagination may have a good deal to do with severe poisoning, a slight indigestion being magnified to a serious illness. Besides these cases, the fungi may be too old, or too long gathered. He gives instances of poisoning to support these statements, and concludes that it is risky to recommend fungi as a diet to the uninitiated.

Yeast-cells and Fermentation.†—Harold Wager read a paper on the yeast-cell before the Institute of Brewing; he described the structure of the cell and the form of the nucleus, with its large vacuole, and explained the methods used to examine the cells under high powers of the Microscope. The yeast-cell contains glycogen, which increases as fermentation proceeds; and as a result of the great quantity of glycogen produced, fermentative activity ceases and the cell sinks to the bottom of the liquid. After a time the glycogen decreases, the cells rise to the surface, and fermentation begins again.

Study of Fungi imperfecti.‡—H. Leininger selected for culture-experiment a species of *Pestalozzia* which grew on dead branches of *Mesembryanthemum* and *Echeveria*, and which agreed with the description of *Pestalozzia palmarum* Cooke. As a result of his cultures he finds:—1. *P. palmarum* produces similar spores in pycnidia, in pseudopycnidia, in layers and singly on hyphæ. 2. The surest method of producing pycnidia is to withdraw nourishment from the mycelium developing in culture solution. 3. Pseudopycnidia are produced in the

* Mycologia, iii. (1911) pp. 75-8.

† Journ. Inst. Brewing, xvii. (1911) pp. 2-15.

‡ Centralbl. Bakt., xxix. (1911) pp. 3-35 (14 figs.).

open on solid substrata, as well as in solutions where there is lack of nutrition. 4. Mycelium, taken from a culture solution and placed in a damp chamber, forms pycnidia. 5. Layer and single spores are formed in culture solutions of maltose, cane-sugar, etc. 6. The fungus will grow in 10 p.c. citric and tartaric acid solutions, but the development is abnormal. The author calls for a revision of the fungi imperfecti on physiological lines.

Genus *Phomopsis*.*—H. Diedicke has studied V. Höhnel's genus *Phomopsis*, under which were grouped certain well-marked forms of the genus *Phoma*. He finds a large number of species with the same characteristics: perithecia with a sclerotic wall seated on a broad basis, colourless below and dark above, with thread-like or awl-shaped sporophores and narrow fusiform spores. He lists 107 species for Germany, previously included under *Phoma*, and probably all of them pycnidial forms of *Diaporthe*.

***Glæosporium Ribis*.**†—Ed. Janczewski and B. Namyslowski found a species of *Glæosporium* on the leaves of *Ribes luteum* in the Botanic Gardens at Cracovia. The fungus was also found on another species of *Ribes* in the sub-genus *Parilla*. The pustules formed on the leaves produced either macroconidia or microconidia, the latter extremely minute. Germination of the macroconidia took place easily in nutrient solutions, and secondary macroconidia or microconidia were formed. Inoculation experiments were tried without success.

Studies in North American Hyphomycetes.‡—D. R. Sumstine has made a study of numerous species of *Rhinotrichum*, a colourless Hyphomycete closely related to *Botrytis* and to *Sporotrichum*, but differentiated from the latter by the upright habit of the fertile branches. The author re-describes the species from the different American collections, and gives diagnoses of two new forms. He also gives an account of *Olpitrichum*, a genus with, so far, two species in America.

***Tilletia horrida* in Rice-meal.**§—P. Filter states that for many years the large echinulate spores of some smut had been recognized in rice-meal; he has been able finally to determine it as *Tilletia horrida*, first discovered as a parasite of rice-plants in Japan, and described by Takahashi. It was at a later date discovered in the United States. It has now been found in India over a large territory. Germination of the spores was attempted and failed.

Uredineæ.—V. Tubeuf || discusses the question of the absence of uredospores on pine-needles. He suggests that it is because the needles are infected by the sporidia of the teleutospores, which produce the *Æcidial* or *Cœoma* generation. Infection does not take place through the stomata, but on the young and tender needles through the cuticle,

* Ann. Mycol., ix. (1911) pp. 1-35 (3 pls.).

† Bull. Int. Acad. Sci. Cracovie, 1910 (1911) pp. 791-5 (3 figs.).

‡ Mycologia, iii. (1911) pp. 45-56 (2 pls.).

§ Centralbl. Bakt., xxix. (1911) pp. 342-6 (4 figs.).

|| Nat. Zeitschr. Forst.-Landwirtsch., vii. (1910). See also Centralbl. Bakt., xxix. (1911) pp. 88-9.

usually between two cells. In *Chrysomyxa Abietis* the mycelium winters in the needles, and forms new teliospore sori early in the year; these spores reinfect other newly-formed needles.

W. Tranzschel* has recorded the results of his infection experiments with Uredineæ. Among other interesting facts, he states that *Puccinia Eriophari* forms æcidia on *Ligularia sibirica* and *Senecio paluster*; *Puccinia lilobalis* on *Juncus Gerardii* forms æcidia on various species of *Sonchus*, and *Puccinia Maydis* develops pyrenidia and æcidia on *Oxalis*.

A. D. Selby† reports the appearance of the blister-rust of white pine, *Peridermium Strobi*, in the United States. It is a stage of the blister-rust of currants and gooseberries, and has been well known for some time in Europe, particularly on American white pine. The occurrence has been traced to plants imported from Germany via France. Efforts are being made to check the disease from spreading.

W. P. Fraser‡ records the results of a series of cultures of heteroecious rusts on plants in Nova Scotia. He succeeded in connecting *Melampsoropsis Cassandræ* Arthur on *Picea* with the teliospore stage on the bog-plant *Chamælapthne*. *Melampsoropsis Abietina*, also on *Picea*, produced uredospores and teliospores on *Ledum groenlandicum*. Several other species were more or less experimented with, and the different stages in the life-history almost certainly proved.

P. Dietel§ contributes a study as to the geographical distribution of the genera *Uromyces* and *Puccinia*, based on Sydow's Monographia Uredinearum. He finds in the two hemispheres 16 p.c. of *Pucciniæ* common to both; for *Uromyces* only 10 p.c. He considers that the number of species introduced by man is so small as to be negligible in such an enumeration. In Australia he finds that about 70 p.c. of the *Pucciniæ* are endemic, and 30 p.c. of *Uromyces* species.

Mikio Kasai|| has published an account of the genus *Phragmidium* in Japan, forming the third part of the "Contributions to the Mycological Flora" of that country. He lists 17 species: 1 on *Potentilla*, 6 on *Rosa*, 9 on *Rubus*, and 1 on *Sanguisorba*. Three species are new.

Th. Lindfors¶ records two new species of Uredines, *Cœoma Violæ* and *C. cernuæ* (on *Saxifraga cernua*), in Sweden, also *Puccinia albulensis* (on *Veronica alpina*), new to that country. He further states that the spores of *P. dovreensis* are seen to be warted under a very high magnification.

Germination of Ustilago Spores.**—H. Zimmerman employed for experiment ears of barley infected with *Ustilago Hordei* grown in 1907. He inoculated different kinds of barley during the following years, and publishes the names of the resisting varieties. The spores were capable of germination and of infecting fresh crops for a period of three years.

* Trav. Musée Acad. Imp. Sci. St. Petersburg, vii. (1910) pp. 1-19. See also Pot. Centralbl., cxvi. (1911) pp. 152-3.

† Ohio Naturalist, xi. (1911) pp. 285-6.

‡ Mycologia, iii. (1911) pp. 67-74. § Ann. Mycol., ix. (1911) pp. 160-5.

|| Trans. Supporo Nat. Hist. Soc., iii. (1910) pp. 27-51 (1 pl.). See also Ann. Mycol., ix. (1911) pp. 194-5.

¶ Svensk. Bot. Tidskr., iv. (1910) pp. 197-202. See also Bot. Centralbl., cxvi. (1911) p. 569. ** Zeitschr. Pflanzenkr., xxi. (1911) pp. 131-3.

Phosphorescence of *Pleurotus japonicus*.* — S. Kawamura states that this fungus is a poisonous species, found on dead beech-trunks throughout Japan. Neither the mycelium nor the stalks give out the light, which is strictly confined to the gills of the pileus. When reduced to 0° temperature the light ceased; it was strongest from 12 to 15° C. Experiments were made with poisons, etc., and results are given.

***Boletus impolitus*.**† — René Maire gives a history of this species, which was found by Fries in Sweden and described by him. It is very rare, but has been found several times throughout western Europe. Maire has decided that the Mediterranean species, *Boletus corsicus*, *B. sardons*, and *B. tlemcensis*, belong to *B. impolitus* as varieties differing in the form of the stalk. It is a good esculent species; var. *corsicus* is sold in large quantities in the towns of Corsica under the name mucchiaiolo. The var. *tlemcensis* should be very abundant in the cork woods of Algeria, and might be easily marketable.

Hypochnus Form of *Fistulina Hepatica*.‡ — Marin Molliard succeeded in growing the fungus on gelatin of carrot. A small portion of the tissue was transplanted to the culture, and formed at first a floccose mass of mycelium; later, small bodies were formed with tubes and basidiospores quite normally developed. In addition, Molliard noted that on the hyphæ spreading over the culture there were here and there basidia formed at the ends of the hyphæ, exactly like a form of *Hypochnus*.

Study of *Ithyphallus impudicus* and *Mutinus caninus*.§ — Ch. van Bambeke has examined very early stages of these fungi, especially the basal cup or volva. He cut microtome sections of the eggs when they were about 1 mm. in diameter. He finds two distinct periods of growth — one of continued expansion till the stalk is formed, and a further rest-period while the fruit-body is ripening. He describes the appearance of the hyphæ and their function in regard to the rest of the plant.

Assimilation of Nitrogen by Fungi.|| — L. H. Pennington has carried out a series of culture experiments with *Fusarium*, *Penicillium*, and *Aspergillus* in carefully controlled solutions. The results did not support the generally accepted notion that fungi assimilate atmospheric nitrogen. Further experiments are to be carried out in order to gain more accurate data.

German Fungus-flora.¶ — W. Migula has issued two more fascicles of his Flora. They deal with the genera *Phlebiu*, *Rudulum*, *Hydnium*,

* Bot. Mag. Tokyo, xxiv. (1910) pp. 281-4. (Japanese.) See also Bot. Centralbl., cxiv. (1911) p. 440.

† Bull. Soc. Bot. France, ix. (1909) pp. lix-lxiii.

‡ Bull. Soc. Bot. France, ix. (1909) pp. 553-6 (1 pl.).

§ Mém. Acad. Roy. Belg. Sci., sér. 2, ii. (1910) 26 pp. (4 pls. and 3 figs.). See also Ann. Mycol., ix. (1911) p. 19.

|| Bull. Torrey Bot. Club, xxxviii. (1911) pp. 135-9.

¶ Flora von Deutschland, v. lief. 107-8 (1911) pp. 145-76 (10 pls.).

and with the allied genera *Phæodon*, *Amaurodon*, and *Hericium*, followed by *Irpez* and *Sistotrema*. A beginning is made with Polyporaceæ, and the first genus, *Merulius*, is partly described.

Fungi in the Rhizoids of Leafy Hepatics.*—A. J. M. Garjeanne has examined a large number of these hepatics, and gives in tabular form the results of his observations. He also made cultures of the fungi and culture experiments, all of which are explained in detail. He sums up the general results thus:—1. The appearance of fungi in the roots of foliose hepatics is of common occurrence though not constant, as the same species may have hyphæ in the rhizoids, or may be free from hyphæ, and the fungi may belong to various species. 2. In some hepatics (*Calypogeia trichomanis*, *Lophozia inflata*, etc.) the fungus forms haustoria, which pierce the neighbouring green cells, in others (*Cephalozia bicuspidata* and *C. commixens*) the hyphæ form compact clumps on the tips of the rhizoids (fungus-galls). 3. In *Lophozia inflata* the fungus forms thickenings of cellulose and glycogen when it enters the rhizoids, and these thickenings tend to retard the progress of the fungus.

The author could not find that any benefit resulted from the presence of the fungus, and harm is certainly done to the host-plant. The infection takes place by way of the soil; the chlorophyll cells are not easily invaded, and one will be packed with hyphæ before the neighbouring cell is entered. Garjeanne isolated and determined a *Mucor* which occurs very frequently, nearly allied to *M. racemosus*, which he names *M. rhizophilus*. It forms large chlamydospores.

British Mycology.†—The spring and summer fungus forays of the British Mycological Society were held in the neighbourhood of Wrexham, and descriptions of the day's proceedings and more important collections of fungi are given, together with lists of all the fungi and mycetozoa observed during the forays. Harold Wager, the President of the Society for the year, gave an address on the problems which arise in connexion with the morphology and physiology of fungi.

A new fungus was sent by W. L. W. Eyre to G. Bresadola, who determined it as new, and describes it as *Poria Eyrei*.

A. D. Cotton publishes a correction, *Clavaria straminia* having been figured in a previous number of the Transactions as *C. persimilis*. A description and detailed account of *C. straminia* is given, with notes on some other *Clavariæ*.

W. N. Cheesman observed and collected fungi and mycetozoa in the Rocky Mountains, on the occasion of his visit there along with members of the British Association. He describes the localities and conditions of growth, and gives lists of the plants observed.

A. D. Cotton publishes notes on recent work done on *Coprinus*, being a summary of Buller's work on that genus published in researches on fungi. The function and importance of cystidia in connexion with spore dispersal are chiefly dealt with.

E. M. Wakefield gives some interesting and useful notes on the anatomical structure of *Grandinia*, a little-known genus. In *G. mucida* she

* Flora, cii. (1911) pp. 147-85 (2 pls. and 9 figs.).

† Trans. Brit. Mycol. Soc., iii. pt. 4 (1911) pp. 233-89.

found the tissue studded with large spherical vesicles of a yellowish colour, filled with oily contents. These vesicles form a more or less regular series parallel with the substratum. No vesicles were found in *G. granulosa*.

Lists of fungi, new or rare in Britain, are contributed by A. Lorrain Smith and Carleton Rea. They sum up the systematic discoveries of the year, and keep their readers in touch with British work. Each list contains one species new to science. The rare species of the larger fungi are illustrated in three coloured plates drawn by E. A. Rea.

Plant Diseases in the Tropics.*—G. Delacroix has published a volume dealing with the maladies to which cultivated plants are subject in warm countries. He treats these under two headings, non-parasitic and parasitic. Under the first of these are described various abnormalities, and especially gummosis, which is due to different causes. The parasitic diseases are discussed under four groups: Bacteria, Fungi, Algæ, and Phanerogams. Descriptions of parasitic fungi occupy most of the book, especially the parasites of coffee, tea, cocoa, and sugar-cane. The latter plant suffers also from Nematodes, of which an account is given. The work was interrupted by the death of the author; it has been taken up and finished by André Maublanc.

Diseases of Plants.—Fr. Bubak † describes a new fungus, *Thyrococeum Sirakoffi*, which he found infesting and damaging the branches of the mulberry; when seedling trees are attacked they are completely destroyed. The fungus, one of the Tuberculariæ, forms at first small pustules under the bark, which produce muriform brown spores when the fungus has spread to the surface. The mycelium penetrates the cortex and the host.

Stephanie Herzfeld ‡ has discovered a new species of *Taphrina* on *Polystichum Lonchitis*. It is noteworthy that the new species has no stalk-cell to the ascus, and forms hyphæ which penetrate the tissue of the host.

C. W. Edgerton § describes the more frequent diseases of sugar-cane; the most widely-spread is a red decay caused by the fungus *Colletotrichum falcatum*. It fructifies very rarely. The nodes are the chief point of attack, and in the later stages the leaves wither and decay. Plants attacked lose in sugar-content. Certain varieties of sugar-cane are immune to the disease, and the cultivation of these is recommended. Another disease of the cane—which has an odour of pine-apple, and is called pine-apple disease—is due to the fungus *Thielaviopsis ethacetica*, the mycelium of which grows through the entire stem. Treatment with Bordeaux mixture hinders the disease. A root disease due to *Marasmius plicatus* is also described.

* *Maladies des Plantes cultivées dans les pays chauds*. Paris: 1911, ix. and 595 pp. (70 text-pls.).

† *Ber. Deutsch. Bot. Gesell.*, xxviii. (1911) pp. 533-7 (1 pl.).

‡ *Oesterr. Bot. Zeitschr.*, lx. (1910) pp. 249-54 (8 figs.). See also *Centralbl. Bakt.*, xxix. (1911) p. 88.

§ *Agric. Exp. Stat. Louisiana State Univ. Bull. No. 120* (1910). See also *Centralbl. Bakt.*, xxix. (1911) pp. 94-5.

T. H. Johnston* records a severe attack by *Monilia fructigena* on peaches, plums, apricots, cherries, apples and pears. The outbreak was favoured by moist warm weather.

P. Magnus† found canker-like swellings on the stems or leaf-stalks of a species of *Zizyphus* in the Transvaal caused by a fungus. The mycelium is intercellular and forms haustoria, which pierce the cells and forms on the surface many-celled conidia. The fungus is one of the Mucedineæ Dietyosporæ and has been named by Magnus *Hyalodema Evansii* g. et sp. n.

I. Miyatare‡ has examined the rice plants of Japan, and has discovered a large number of fungi causing more or less serious diseases. Many or most of them are new species belonging to the Pyrenomycetes, or to the *Fungi imperfecti*.

E. J. Butler§ describes *Taphrina maculans* sp. n., common on turmeric (*Curcuma longa*) in the Bombay Presidency. The fungus forms spots on both sides of the leaf, though these are generally more numerous on the upper surface; they do not cause any distortion. It is remarkable for the large haustoria, which are found chiefly in the cells of the epidermis and hypodermis of the host; they are formed of densely intertwined hyphæ, which arise from a common stem and ultimately form a solid body. The fungus does not destroy, but seriously injures the leaves and weakens the vitality of the whole plant.

In a leaflet|| issued under the auspices of the Board of Agriculture and Fisheries, an account is given of scab diseases of potato, more especially of the one caused by *Oospora*. This fungus attacks the tubers while young, forming scattered rough scabs or patches on the surface. The injury is confined to the surface of the tuber. Various remedies for scab are suggested.

R. Lambert¶ describes cases of disease due to *Glaeosporium*. He found this fungus forming dark spots on bananas. The species differed from *G. musarum*, previously recorded. He also describes a disease of ivy caused by *Phyllosticta hedericola* and *Glaeosporium paradoxum*.

C. Leslie Coleman** describes a disease of arcaea nuts called "koleroga," which is caused by a *Phytophthora* similar to the species *P. omnivora*; and the view that it is a form of the species was strengthened by a successful series of inoculation cultures on a large series of plants. He does not think it is the same *Phytophthora* as the one found on cacao plants.

Insects as Fungus-carriers.††—L. Mercier considers that insects are active agents in the dissemination of ergot spores, and cites the case of

* Agric. Gaz. N.S. Wales, xxi. (1910) p. 194. See also Bot. Centralbl., xxix. (1911) p. 101.

† Ber. Deutsch. Bot. Gesell., xxviii. (1910) pp. 377-80 (1 pl.).

‡ Journ. Coll. Agric. Imp. Univ. Tokyo, ii. 4 (1910) pp. 237-76 (2 pls.). See also Bot. Centralbl., cxvi. (1911) p. 170-1.

§ Ann. Mycol., ix. (1911) pp. 36-8 (1 pl.).

|| Leaflet No. 137, 4 pp. (4 figs.)

¶ Gartenflora, lix. (1910) p. 409. See also Centralbl. Bakt., xxix. (1911) p. 248.

** Dep. Agric. Mysore State, Mycol. Ser., Bull. ii. (1910). See also Centralbl. Bakt., xxix. (1911) pp. 248-9.

†† C.R. Soc. Biol. Paris, lxx. (1911), pp. 300-2

one of the Diptera, *Sciara Thomæ*, which frequented *Lolium perenne*, a grass that is subject to attacks of the ergot fungus. He found conidia of the sphaecelia stage of the ergot attached to the hairs of the insect and also in the digestive tube. The natural inference is that these conidia are transported to other *Lolium* plants.

Notes on Mycology.*—F. von Höhnelt continues his descriptions of fungi collected in Java. He describes a great many new species, and establishes the following new genera: *Koordersiella* and *Loranthomyces* (Sphaeriaceæ); *Coccoidella* (Coccoideaceæ); *Discolothis* (Dothideaceæ); *Trichopeltopsis* (near to *Dunerosporium*); *Schiffnerula* (Englerulaceæ); *Myxasterina* and *Microporella* (Excipulaceæ); *Aranomyces* (Mucedineæ).

Notes on Fungi.†—G. Masee gave an address to the mycologists of the Yorkshire Naturalists' Union, in which he advised special study of a group or even of a single genus, not only the systematic side of the question but the ecology of fungi, and the study of the irregular occurrence of so many species.

Harold Wager ‡ in his address described the development of an Agaric from mycelium to spore-formation. There are two nuclei in the basidium at an early stage, which fuse together, and the nucleus thus formed divides twice to form the four nuclei of the spores. The origin of the binucleate mycelium has not been traced, though some spores have been found to have two nuclei before they leave the sterigmata.

Fungus Foray at Sandsend.§—C. Crossland describes the foray of the Yorkshire Naturalists' Union to Sandsend, in September last. The woods in the neighbourhood are stocked with well-grown native timber-trees and shrubs, while quantities of exotic shrubs grow freely. A number of Agarics (six) new to Britain were found; a considerable variety of species of microfungi were also collected and examined. The list of species reaches the large total of 563 species, 145 of which are new to the Mulgrave district.

Mycological Flora of Oak-tree Slime-flux.—Ludwig Rose has isolated a number of organisms from the slime that issues from wounds in the oak-tree. He made cultures from six different trees in the neighbourhood of Berlin, and in all cases he found the fungus *Endomyces Magnusii*, with which he made a series of experiments as to its physiological and fermentative properties. He found also the oak-yeast *Saccharomyces Ludwigii*, and a bacterial fungus, *Leuconostæ* (*Acteobacterium*) *Lagerheimii* sp.n.

* SB. k. Akad. Wiss. Wien, (1910) p. 813. See also Bot. Centralbl., cxvi. (1911) pp. 207-9.

† Naturalist, 1911, pp. 26-27.

‡ Tom. cit., pp. 27-8.

§ Naturalist, 1911, pp. 21-6.

|| Wochenschr. Brauerei, xxvii. (1910) Nos. 42-7 (5 pls. and 31 figs). See also Ann. Mycol., ix. (1911) pp. 131-3.

- BROILI, J.**—**Versuche mit Brand-infektion zur Erzielung brandfreier Gerstenstämme.** [Research by infection with smut-spores to arrive at immune varieties of barley.]
[So far the experiments have had very doubtful results.]
Nat. Zeitschr. Forst.-Landw., viii. (1910) pp. 335-44 (7 figs.).
See also *Ann. Mycol.*, ix. (1911) pp. 200-1.
- DIEDICKE, H.**—**Die gattung *Plenodomus* Preusz.**
[An account of the genus *Plenodomus*, with its affinities, and of the species included in it.] *Ann. Mycol.*, ix. (1911) pp. 137-41 (1 pl.).
- ERIKSSON, JAKOB**—**Mycoplasmatheorie.**
[A discussion of Zach's researches on the rusts of cereals, and on the mycoplasma theory.]
SB. Akad. Wiss. Math.-Nat. Kl., exix. (1910) pp. 1043-50.
- ENGELKE, C.**—**Eine selten Pyrenomyceten Art.** (A rare species of Pyrenomycetes.)
[A specimen of *Nummularia lutea* found on *Alnus glutinosa* near Hanover.]
Nat. Ges. Hannover Bot. Abt., 1910, pp. 39-46.
See also *Bot. Centralbl.*, cxiv. (1911) p. 439.
- FAIRMAN, CHARLES E.**—**Fungi Lyndonvillenses novi vel minus cogniti.** (Fungi new or rare from Lyndonville.)
[Eight microfungi are described, all but one new to science.]
Ann. Mycol., ix. (1911) pp. 145-52 (7 figs.).
- FRIES, R. E.**—**Gasteromyceter, discomyceter, och myxomyceter insamlade under Svenska Botaniska Föreningens excursion till Aelfkarleö, Sept. 1910.** (Gasteromycetes, Discomycetes, and Myxomycetes collected during the excursion of the Svenska Botaniska Föreningen to Alfkarleö.)
Svensk. bot. Tidskr., iv. (1910) pp. 98-99.
See also *Bot. Centralbl.*, cxvi. (1911) p. 569.
- HÖHNEL, FR. V.**—**Resultate der Revision von Paul Henning's Pilzgattungen.** (Results of the revision of Paul Henning's new genera of fungi.)
[A very large number are condemned as redundant, or imperfectly described.]
Ann. Mycol., ix. (1911) pp. 166-75.
- KAUFMANN, F.**—**Die westpreussischen Pilze der Gattungen *Phlegmacium* und *Inoloma*.** (The West Prussian fungi of the genera *Phlegmacium* and *Inoloma*.)
[There are fifty-eight species described, with synoptic tables.]
Ber. Westpreusz. Bot. Zool. Ver. (1910) 10 pp.
See also *Ann. Mycol.*, ix. (1911) p. 195.
- MAIRE, RENÉ**—**Contribution à l'étude de la flore mycologique de la Tunisie.** (Contribution to the mycological flora of Tunis.)
[Collections made during the session of the Botanical Society in Tunis in 1909.] *Bull. Soc. Bot. France*, ix. (1909) pp. cclxv-lxxxix (1 pl. and 5 figs.).
- MASSE, G.**—**Fungi exotici. XI.**
[Descriptions are given of eleven new species, one, *Eutypa caulivora*, a serious parasite on Para rubber.]
Bull. R. Bot. Gard. Kew, vii. (1910) pp. 249-53 (1 pl.).
- MIGULA, W.**—**Kryptogamen Flora.** (Cryptogamic Flora: Fungi.)
[Descriptions of *Polyporus Fomes*, etc.]
Flora von Deutschland, Oesterreich und der Schweiz, v. Lief. 109-10, pp. 177-208 (10 pls.).
- RICK**—**Fungi Austro-Americani, xi.-xviii.**
[As Rick's manuscript was lost in transmission, the species have been named by Theissen, with the assistance of Bresadola and Rehm.]
Ann. Mycol., ix. (1911) pp. 175-84.
- SYDOW, H. & P.**—**Fungi.**
[The fungi of the German Central Africa Expedition, 1907-8, under the leadership of the Duke of Mecklenburg.]
Scientific Results, ii. (1910) pp. 94-101.
See also *Ann. Mycol.*, ix. (1911) pp. 193-9.
- „ „ **Novæ Fungorum Species, vi.** (New species of fungi.)
[Species of microfungi from various localities.]
Ann. Mycol., ix. (1911) pp. 142-6 (1 pl.)

SULC, KAREL—“*Pseudovitellus*” und ähnliche gewebe der Homopteren sind Wohnstätten symbiotischer Saccharomycetea. (“*Pseudovitellus*” and similar tissues of the Homoptera as enclosures for symbiotic Saccharomycetes.)

[The fungus is determined as *Cycadomyces* g. n.; several new species of Saccharomycetes are also isolated.]

SB. k. Böhm. Ges. Wiss. Math.-Nat. Cl. (1910) 3, 39 pp. (18 figs.).

THEISZEN, F.—Fungi aliquot Bombayensis a Rev. Ed. Blatter collecti. (Fungi from Bombay, collected by Rev. Ed. Blatter.)

[A number of rare exotic species are described, several of them new.]

Ann. Mycol., ix. (1911) pp. 153-9 (1 fig.).

Lichens.

(By A. LORRAIN SMITH.)

Nutrition of Lichens.*—F. Tobler points out that certain products in the metabolism of lichens are peculiar to them alone, and only produced by fungus and alga combined. It has been held that the fungus received most benefit in the symbiotic relationship, being dependent on the alga for carbohydrates. Tobler points out that the fungus is often saprophytic on plant remains, scraps of soil, humus, etc., and in some epiphytic lichens even parasitic on the host leaf. Modern writers, who regard the fungus as parasitic on the alga, point out the dead algal cells as proof of their views. Tobler repeats that the fungus takes water and inorganic substances from the soil, and is able as a saprophyte to procure also carbohydrates without the aid of the alga.

As to the dead algal cells, he points out that assimilation is difficult in the conditions under which they live, badly lighted and deprived largely of carbonic acid gas; it has, however, been proved that algae can form carbohydrates from organic acids in the absence of light. In homoiomerous lichens the algae are in contact with the substratum, and though oxalic acid may be poisonous for the fungus, there are other sources from which it can derive carbohydrates. It is probable that the fungus often forms an abundance of calcium oxalate, which may be utilized by the alga. Tobler proves from his culture experiments that gonidia grew in certain solutions along with the fungus, but were colourless, showing that their carbohydrates were procured from some acid formed by the fungus, and proving a physiological symbiosis between the two. He proves step by step: (1) that *Xanthoria parietina* fungus constituent grown on artificial substratum (poplar bark-gelatin) forms abundant calcium oxalate crystals on the hyphae; (2) a piece of thallus grown in the same conditions produces none; (3) *Xanthoria* thallus on poplar bark is also without crystals; (4) finally, in culture solutions in which the *Xanthoria* fungus had grown, gonidia thrive, but have no colour.

Lichen Flora of Santa Cruz Peninsula, California.†—A. W. C. T. Herre has made a special study of the lichen flora of a district measuring 90 miles in length and 6 to 35 miles in breadth, rising at one point to a height of 3793 feet, the whole district presenting a great variety of rock, soil, and wood favourable to lichen growth. He found the district

* Ber. Deutsch. Bot. Gesell., xxix. (1911) pp. 3-12.

† Proc. Washington Acad. Sci., xii. (1910) pp. 27-269.

peculiarly rich in endemic species. Herre records 64 genera, one *Zahlbrucknera* new to science (Ephelbaeeae), and many new species.

Desert Lichens.*—A. W. C. T. Herre has made a list of the lichens from Reno, a desert locality at the eastern foot of the Sierra Nevada mountains. The average rainfall is about 8 in., which falls largely as snow during the winter months. He notes the small number of genera and species with the large number of individuals. In all he collected 59 different species in the locality. Few of them could be called foliose, as they closely hug the rocks. Certain species have a well-developed thallus, but are always sterile. Herre considers that these lichens derive their moisture entirely from the atmosphere, but that they thrive best in winter, and barely keep alive during the summer months.

American Lichen Notes.—Lincoln W. Riddle† reports the re-discovery of *Parmelia lophyrea*, originally collected by Archibald Menzies on the Vancouver Expedition to the Pacific and determined by Acharius. It has recently been collected again on Point Peterson (Washington). L. W. Riddle remarks that “the restricted distribution, with the small size and inconspicuousness of the species, undoubtedly accounts for its having been overlooked for a century.”

G. K. Merrill‡ publishes notes on various species and one new, *Leptogium pilosellum*, from the State of Washington. He suggests that *Lecanora frustulosa* may be a form of *Leptogium argopholis*; he establishes *Parmelia cetrata* Ach. for North America; the plant has been confused by Nylander and others with *P. perforata*. *Lecanora subtartarea* is recorded for the first time in America (eastern States).

Crocynia, a Genus of Lichens.§—Abbé Hue has revised this genus, of which there is only one European species, *Crocynia lanuginosa*, named by Nylander *Leproloma lanuginosa*, a sterile species placed in *Crocynia* on anatomical grounds. The gonidia of the genus may be chroolepoid or protococcoid, and may be scattered through the thallus or form a definite layer. Among the species revised and included in the genus is *Chrysothrix nobilitangere* Mont., a curious lichen that grows among cactus spines in Peru. It was placed by Nylander in *Arthonia*.

Systematic Position of Stereocaulon.||—This genus has commonly been associated with *Cladonia*, but Birger Kajanus points out the difference in origin between the podetia of the two genera; those of *Stereocaulon* being developed by the direct elongation of basal warts, while in *Cladonia* they rise from a group of hyphae of the primary thallus, and are true podetia or stalks of apothecia; those of *Stereocaulon* might be named pseudopodetia, as was suggested by Wainio. Kajanus is of opinion that the allies of *Stereocaulon* are to be found in *Toninia*, and to

* Bot. Gaz., li. (1911) pp. 286-97.

† Bryologist, xiv. (1911) p. 35.

‡ Tom. cit., pp. 36-8.

§ Mem. Soc. Nat. Sci. Nat. Math. Cherbourg, xxxvii. (1909) 32 pp. (3 figs.). See also Bull. Soc. Bot. France, ix. (1909) pp. 641-2.

|| Bot. Not., ii. (1911) pp. 83-90.

a remoter degree in *Catillaria*, the latter crustaceous, the former warted, squamulose, or somewhat shrubby.

HUÉ, ABBÉ—**Lichens.**

[Notes on lichens collected at Tangiers.]

Arch. Soc. Linn. Bord., lxiii. (1909) 4 pp.

See also *Bull. Soc. Bot. France*, ix. (1909) p. 641.

HULTING, T.—**Lichenes nonnulli Scandinaviæ.** (Some lichens found in Scandinavia.)

Bot. Not., 1910, pp. 303-6.

See also *Bot. Centralbl.*, cxvi. (1911) p. 570.

MALME, G. O.—**Parmelia pertusa funnen in Södermanland.**

[*Parmelia pertusa* found in Södermanland on *Alnus glutinosa*, hitherto only found there on rocks.]

Svensk. Bot. Tidskr., iv. (1910) pp. 92-6.

See also *Bot. Centralbl.*, cxvi. (1911) p. 570.

MAHEU, J.—**Notes relatives à la cryptogamie de l'Espagne. Les Lichens de Montserrat.** (Notes on the Cryptogams of Spain. Lichens of Montserrat.)

[Descriptions of seventy-seven species collected by the writer, some of them new species.]

Bull. Soc. Bot. France, ix. (1909) pp. 334-43 and 389-97 (3 figs.).

NAVAS, L.—**Sinopsis de los líquenes de las islas de Madeira.** (Synopsis of lichens of the Island of Madeira.)

[A beginning is made of a synopsis of the lichens found at Madeira.]

Brot. ser. Bot., ix. 2 (1910).

See also *Bot. Centralbl.* cxvi. (1911) p. 112

Mycetozoa.

(By A. LORRAIN SMITH.)

Streaming of Plasmodia.*—V. Vouk publishes observations on the rhythmic movements of protoplasm in the plasmodia of Myxomycetes. There is a regular progression and retrogression, the former of longer duration than the latter; also the rhythm is constant for a given species, though only in the head streams; the side streams are subject to constant change. Should there be mechanical disturbance of the plasmodium, the effect is at once felt in the lowering or raising of the rate of movement.

Notes on Myxomycetes.†—C. Engelke records an unusual form of *Fuligo varians* which he found on mosses and dried leaves; it was divided up into minute separate plasmodia and aethalia which were dark green in colour.

Engelke also gives a list of species found near Hanover. He records 66 species, some of them of great interest. He gives careful notes of locality and time of year.

Sorosphæra.‡—E. J. Schwartz has discovered another species of this genus parasitic on the roots of *Poa annua* and other grasses. The

* *Anz. k. Akad. Wiss. Wien*, xx. (1910) pp. 363-4. See also *Bot. Centralbl.*, cxvi. (1911) p. 292.

† *Natur. Ges. Hannover, Bot. Abt.* (1910) pp. 14-18. See also *Bot. Centralbl.*, cxiv. (1911) pp. 441-2.

‡ *Ann. Bot.*, xxv. (1911) p. 270.

organism forms tubercles or swellings on the roots; the amœbæ, he finds, send out protoplasmic threads, which penetrate through the cell-wall from one cell into another. The means by which infection takes place is by the entrance of air amœba into a root hair.

HEDBORN, K.—*Nagra nyare fynd af svenska myxomyceter.* (New records of Myxomycetes.)
Svensk. Bot. Tidskr., iv. (1910) pp. 94-5.
 See also *Bot. Centralbl.*, cxvi. (1911) p. 593.

Schizophyta.

Schizomycetes.

Absorption Phenomenon in Microbes.*—M. W. Beijerinck has shown that when *Oidium lactis* is sown on an agar plate containing glucose and mono-potassium phosphate, no growth occurs. If a crystal of urea be then placed on the surface of the medium, a growth of *Oidium* appears all round it. The urea supplies the element necessary for the growth of the organism. The auxanogram obtained does not show an ordinary diffusion picture with gradual tailing off at the margins, but is almost sharply cut, a slight thinning at the edge being only with difficulty perceptible. A similar result is obtained by interchanging the glucose and the urea. There are three phases in this phenomenon: a period of diffusion of the urea through the medium, a period of absorption by the micro-organisms, and a period of growth during which the urea rapidly disappears.

Fermentation of Sugars by Bacteria.†—Y. Mendel has carried out researches upon the conditions under which bacteria cause fermentation of sugars, and gives in tabular form the results of an extensive series of estimations, for various sugars and various organisms, of the amount of gas produced, the proportion of carbon dioxide to hydrogen in this gas, the amount of acid, and the ratio of fixed to volatile acid. The sugars selected for investigation were glucose, maltose, and lactose. Most of the experiments were performed with *Bacillus coli* and allied organisms. The author found that fermentation was most active in solutions containing 6-10 p.c. of sugar, a rather higher degree of concentration than that in favour with previous workers.

Methods of Agricultural Bacteriology.‡—Th. Remy and G. Rösing have investigated a number of important matters in connexion with the bacteriological examination of soil. They set themselves to determine the degree to which a soil is capable of destroying peptone, and the power which it possesses of splitting up complex nitrogenous substances. They found that peptone was more readily broken up than blood-albumin or gelatin. They then investigated the effect which the chemical composition of the soil had upon the course of peptone disintegration, and their experiments showed that the addition to the soil of salts containing potassium, magnesium, phosphoric and sulphuric acids, greatly increases the peptone-disintegrating power of the bacteria. A similar, though less

* *Centralbl. Bakt.*, 2^{te} Abt., xxix. (1911) pp. 161-6.

† *Centralbl. Bakt.*, 2^{te} Abt., xxix. (1911) pp. 290-330.

‡ *Centralbl. Bakt.*, 2^{te} Abt., xxix. (1911) pp. 36-77.

well-marked effect was obtained by adding sterile soil or a watery extract of sterile soil to the experimental sample. A variety of other experiments were performed, which led the authors to the conclusions that the influence of the soil in peptone destruction is unmistakable, and that this influence is aided not only by ordinary plant foods, but by other substances, such as silicates and acid derivatives of humus. There appear, however, to be certain soluble compounds in the soil, which have an inhibiting effect, but this point requires further investigation. The influences of aeration, temperature, and moisture were also studied in some detail.

Change of Biological Characters in Bacteria.*—H. Stromberg, using the agglutination reaction, was able to distinguish sharply between the Gaertner and Paratyphoid B groups. Some enteritis strains giving the usual cultural characteristics were difficult or impossible to identify by agglutination, and these probably represent degenerated strains which were originally typical. This affords indirect evidence of the possibility of alteration in biological characters, but no direct evidence of this could be obtained, as, for instance, alteration in the typical strains, or further alteration in the atypical ones. No connexion could be determined between the form of the colonies on agar and the biological characters, and there appears to be no characteristic type of colony formation either in the Gaertner group or in the Paratyphoid B. The occurrence of different colony formations in the same culture seems to indicate the beginning of a change, as is evidenced by the fact that some of these colonies show slight change in the agglutination reaction.

Strict Anaerobic Bacillus causing Purulent Pleurisy.†—F. Niosi has discovered and described a strict anaerobe causing pleurisy with putrefaction, and considers that the pathogenic anaerobes are probably much more numerous than has hitherto been believed. The organism is a short, plump, non-motile bacillus, frequently in pairs and chains, without capsule, and non-sporing. It is Gram-positive in fresh preparations, but almost negative from cultures.

Verruga peruana.‡—B. Galli-Valerio has found, in a case of Verruga peruana or Maladie de Carrion, an acid-fast bacillus. In the blood of a second case he found bodies in the erythrocytes like those observed by Biffi, Basset Smith, and others, while in a third he met with bodies, surrounded by a clear halo, resembling *Piroplasma marginale* of cattle.

Trypanotoxin of Bacillus subtilis.§—C. Levaditi and C. Twort state in a preliminary note that the toxin of *B. subtilis* is lethal to the Trypanosomes of Nagana, and also to the spirilla of tick fever and to *Leishmania*, while it is inactive to *Spirillum gallinarum*.

Presence of Streptothricæ in Tuberculous sputum.||—L. Darwacki isolated a streptothrix thrice out of twenty examinations. The medium was potato with 4 p.c. glycerin. One is identified as *Oospora pulmonalis*

* Centralbl. Bakt., 1^{te} Abt., lviii. pp. 401-45.

† Centralbl. Bakt., 1^{te} Abt., lviii. (1911) pp. 193-228 (4 figs.).

‡ Centralbl. Bakt., 1^{te} Abt., lviii. (1911).

§ C.R. Soc. Biol. Paris, lxx. (1911) pp. 645-7.

|| C.R. Soc. Biol. Paris, lxx. (1911) pp. 180-1.

Roger; another is designated *Streptothrix fusca*; the third is identified as the *S. candida gedanensis* H. Petruschsky. The author expresses the opinion that Streptotricheæ are an important feature of tuberculous sputum.

Cytology of the Bacteria.*—C. C. Dobell in a contribution to the cytology of the bacteria, draws the following conclusions: All bacteria which have been adequately investigated are—like other Protista—nucleate cells. The form of the nucleus is variable not only in different bacteria but also at different periods in the life-cycle of the same species. The nucleus may be in the form of a discrete system of granules (chromidia); in the form of a filament of variable configuration; in the form of one or more relatively large aggregated masses of nuclear substance; in the form of a system of irregularly branched or bent short strands, rods, or networks; and probably also in the vesicular form characteristic of the nuclei of many animals, plants, and protists. There is no evidence that enucleate bacteria exist. The bacteria are in no way a group of simple organisms, but rather a group displaying a high degree of morphological differentiation coupled in many cases with a life-cycle of considerable complexity.

Bacterium Briosii.†—G. L. Pavarino gives a preliminary account of a new species of bacterium which attacks the tomato. *B. Briosii* differs in many respects from *B. solanacearum* Smith, which also causes tomato rot. The rodlets are short and stumpy. The optimum temperature is 15–16° C. A yellow pigment is formed. Pure cultures reproduce the disease in healthy plants.

Action of Wax-solvents and the Presence of Thermolabile Bacterio-toxins on Soil.‡—R. Greig-Smith thus summarizes his experiences: Water extracts from soil a substance which is filtrable through porcelain and which is toxic to bacteria. The toxicity is made evident by the retardation of growth or by the destruction of the bacteria. The toxin is destroyed by heat, by sunlight, and by storage. It slowly disappears from air-dried soil and rapidly decays in aqueous solution. It is not destroyed by salts, such as sodium chloride, potassium or magnesium sulphate. Soils vary in the amount of toxin they contain; good soils contain less, poor soils more. The particles of soil are covered or “waterproofed” with soil-wax or “agricere,” which consists of a mixture of saponifiable and unsaponifiable bodies. The wax-solvents (volatile disinfectants) alter the distribution of the agricere by carrying it to the surface of the soil and causing it to be segregated on the points of the soil particles. With the removal of the “waterproofing” the soil-nutrients are more easily dissolved by soil-water and attacked by bacteria.

Tuberculosis.—W. Bulloch, in the Horace Dobell Lecture, delivered before the Royal College of Physicians in November 1910, draws the following conclusions: Pulmonary tuberculosis is produced almost, if not exclusively, by bacilli of the *typus humanus*; it is essentially an

* Quart. Journ. Micr. Sci., lvi. (1911) pp. 395–506 (4 pls.).

† Atti R. Accad. Lincei, xx. (1911) pp. 355–8.

‡ Proc. Linn. Soc. N.S.W., xxxv. (1910) pp. 808–22.

inhalation disease: bovine tubercle bacilli play a relatively unimportant role in the production of tuberculosis in man.

Bacteriology of Baltimore City Water.*—W. W. Ford enumerates six types of organisms met with in this water. (1) *Bacillus coli*; (2) *B. proteus vulgaris*; (3) *B. cloacæ*; (4) Paratyphoid or Paracolon; (5) liquefying organisms resembling *B. coli*; (6) *B. fecalis alkaligenes*. The author expresses the opinion that the presence of non-pigmented, non-spore-bearing, sugar-splitting bacteria indicates a serious and permanent pollution of the supply.

Minute Structure of Bacillus anthracis.†—The methods employed by H. Péneau for the investigation of the cytology of bacteria have been described in a previous paper. In the present communication he deals with the bacillus of anthrax. In the development of this micro-organism the author recognized five stages. In the earliest stage there is little differentiation of structure, the cell being occupied with dense basophil cytoplasm. In the second stage, found after 12 to 20 hours' growth, the nucleus is seen usually at one of the poles. It is a well defined structure, staining well with any of the nuclear dyes. This nucleus, in the succeeding phase of development, becomes replaced by a basophil reticulum, which gives the organism a vacuolated appearance. After 60 hours the basophil tracts break up and give way to moniliform structures, which collect together to form a morula. The margins of this morula become well defined, and the body assumes an ovoid or circular form. This structure develops into the adult spore. It appears that the spore is developed from the nucleus, which, however, passes through an intermediate reticular phase.

Experimental Typhoid Fever.‡—The experimental infection of laboratory animals with typhoid fever has always presented a problem difficult of solution to the bacteriologist. It is possible, by inoculations of typhoid cultures, to produce peritonitis in a guinea-pig; but the animal shows none of the lesions characteristic of the disease. Grünbaum tried to produce the disease in the chimpanzee, with moderate success. In consequence of this difficulty, an idea has arisen that the causal organism of the disease is not Eberth's bacillus, but a filter-passer. The recent history of the bacillus of hog cholera has stimulated the supporters of this view.

In the present paper E. Metchnikoff and A. Besredka, after a résumé of the foregoing considerations, give a preliminary account of their researches. By the oral administration to chimpanzees of typhoid cultures which had passed through a chimpanzee, and in other cases of typhoid cultures mixed with typhoid stools, they produced a disease which presented all the typical lesions of typhoid fever. Only in exceptional cases, however, could they produce the disease in the lower apes. Their experiments all showed that the typhoid bacillus is the causal organism, and all the evidence was against the existence of a filter-

* Johns Hopkins Hosp. Bull., xxii. (1911) pp. 53-6.

† Comptes Rendus, clii. (1911) pp. 617-19.

‡ Ann. Inst. Pasteur, xxv. (1911) pp. 193-221.

passer. They found that the administration of vaccines did not protect against experimental typhoid.

Variability of Intestinal Bacteria.*—W. J. Penfold describes his investigations upon the influence of monochloroacetic acid upon the gas-producing power of certain intestinal organisms. This research was suggested by the observation of the effect of certain constituents entering into the production of glycocoll upon these organisms. The gas-producing power of *Bacillus coli*, *B. enteritidis* (Gærtner), and *B. Grünthal* on certain sugars was found to be reduced or completely removed by growth on monochloroacetic-acid agar. This was true in the case of nearly all sugar media, but did not hold for the alcohols, such as mannite and dulcitol. When these organisms were grown upon monochloroacetic-acid agar, a marked variability in the size of the colonies was observed, and secondary colonies or papillæ were formed. The new varieties retained their power of producing gas from formates. The identity of these variant strains with the typical strains from which they were derived was established by the application of complement-fixation methods.

Capsule-formation of Typhoid Bacilli.—In the course of his investigations of the agglutination of typhoid bacilli by certain sera, G. Kühnemann found that, under certain conditions, the organisms, after being in contact with serum, became capsulated. This was demonstrated by staining films of centrifugalized bacteria by means of a modification of Loeffler's flagella stain. The phenomenon was observed when the serum employed was derived from young animals. In one case it was observed with a serum obtained from a child eighteen months old. The dilution of 1 in five or 1 in ten of serum appeared to be the most favourable for capsule formation. The presence or absence of agglutination appeared to possess no influence in this respect. The author considers that capsule-formation forms part of the protective mechanism of the bacillus, and that its occurrence affords an index of its virulence and the ratio between the protective powers of the organism and of the host.

Etiology of Rhinoscleroma.‡—B. Galli-Valerio, after a short review of the clinical features of this condition, mentions the earlier hypotheses that the disease was due to tubercle or syphilis. The bacillus discovered by v. Frisch in 1882, and named by him *Bacillus rhinoscleromatis*, is now generally considered to be the causal organism. Babes, however, described cases of the disease in which this organism could not be found. The bacillus is a non-motile, Gram-negative rod, which does not liquefy gelatin. Culturally and morphologically, it is indistinguishable from *B. pneumoniæ* and *B. ozaenæ*. The author has performed experiments using the method of complement binding, and concludes that the three organisms are identical. He considers that the disease is undoubtedly due to this bacillus, developing probably where there is an hereditary predisposition, or in the presence of such a condition as atrophic rhinitis.

* Proc. Roy. Soc. Med. (Pathol. section) iv. (1911) pp. 97-109.

† Centralbl. Bakt., 1te Abt. Orig., lvii. (1911) pp. 497-8.

‡ Centralbl. Bakt., 1te Abt., Orig., lvii. (1911) pp. 481-90.

Nitrite-formation by various Bacteria.*—E. Pelz has investigated the amount of nitrites which is formed by various organisms, particularly intestinal organisms, in the presence of nitrates. This research was suggested by Emmerich's theory that the toxic symptoms of cholera are due to extensive formation of nitrites in the intestinal canal. The author has used the method of Griess, finding it more satisfactory than other complicated gravimetric methods. According to the amount of nitrite produced, the organisms investigated were assigned to three groups. Very small quantities were produced by Shiga's bacillus and the streptococcus. In the intermediate class are placed typhoid, paratyphoid A, *B. coli*, and some allied organisms. The class of good nitrite-formers comprises all the vibrios, Flexner's dysentery bacillus, and paratyphoid B. *Vibrio cholerae* does not stand out from the rest of this group, either in respect of the total quantity of nitrites produced or of the rate at which they are formed.

Action of *Bacillus Lactis Aerogenes* upon Glucose.†—G. S. Walpole has investigated the "crude glycol" formed by this action, and finds that it is largely composed of two optically inactive 2:3 butanediols. Small quantities of the phenylarethanes of other glycols were also obtained. In the presence of oxygen, acetylmethylcarbinol is also produced from 2:3 butanediol by this organism. Fructose is decomposed in a similar manner.

Variations of Typhoid and Dysentery Bacilli.‡—Reiner Müller discusses the mutations exhibited by these organisms when grown upon media containing isodulcitate. Under these conditions, the growth shows the formation of papillae and of daughter-colonies. The phenomenon is very constant, and may be produced when only a small trace of the sugar is present. Isodulcitate is structurally a methyl-pentose, but the author has been unable to obtain the other methyl-pentoses, fukose and rhodose, for investigation. This mutation, which appears to possess a diagnostic value, is explained by the author upon the side-chain theory. Mutations have also been observed in old cultures of typhoid upon gelatin.

Cultivation of Leprosy Bacillus.§—E. Bertarelli gives a review of recent advances in the knowledge of this organism. Two problems have of late years been solved. The organism has been successfully cultivated. The disease has been communicated to animals. The cultivation of the leprosy bacillus has occupied the attention of many, whose names are recorded in this paper. The first undoubted culture of the bacillus was obtained in 1905 by E. Weil, who made use of a medium containing yolk of egg. Cley, more recently, has obtained cultures by growing the organism upon agar in symbiosis with amœbæ. The most important work upon this subject has been done by Kedrowski, who succeeded in cultivating the bacillus upon ordinary media, and in transmitting the disease to rabbits by means of cultures so obtained. This

* Centralbl. Bakt., 1te Abt. Orig., lvii. (1910) pp. 1-16.

† Proc. Roy. Soc., Series B, lxxxiii. (1911) pp. 272-86.

‡ Centralbl. Bakt., 1te Abt. Orig., lviii. (1911) pp. 97-106.

§ Centralbl. Bakt., 1te Abt. Ref., xlix. (1911) pp. 65-73.

observer found that the organism showed considerable pleomorphism when artificially cultivated. Sugai and other Japanese workers have performed successful inoculation experiments.

DACHNOWSKI, A.—**The Bacterial Flora as a Factor in the Unproductiveness of Soils.**
Ohio Naturalist, x. (1910) pp. 137-45 (2 figs.).

GREIG-SMITH, R.—**Permanency of the Characters of Bacillus coli group.**
Proc. Linn. Soc. N.S.W., xxxv. (1910) pp. 806-7.

GUILLEMARD, A.—**Nouvelle conception de l'Anaérobiose. Culture des Bactéries anaérobies à l'air libre en présence du fer.**
C.R. Soc. Biol. Paris, lxx. (1911) p. 685.

MAGNAN & DE LA RIBOISIÈRE—**Sur la présence constante d'un bacille particulier dans les vésicules de la varicelle.**
Tom. cit., pp. 309-10.

MERCIER, L., & P. LASSEUR—**Variation expérimentale du pouvoir chromogène d'une Bactérie (Bacillus chlororaphis).**
Comptes Rendus, clii. (1911) pp. 1415-18.

RAPPIN & A. VANNEY—**Sur l'Identité des Diphtéries aviaires et humaines.**
[The authors record observations which lead them to believe that avian and human diphtheria are one and the same disease.]
C.R. Soc. Biol. Paris, lxx. (1911) pp. 162-3.

REMLINGER, P.—**Sur un Bacille liquéfiant rapidement le sérum coagulé.**
Tom. cit., pp. 168-9.

MICROSCOPY.

A. Instruments, Accessories, etc.*

(1) Stands.

Old Microscope by J. Simons: presented by Members of the Council.—The name of J. Simons (*Invent. et fecit*), engraved on the

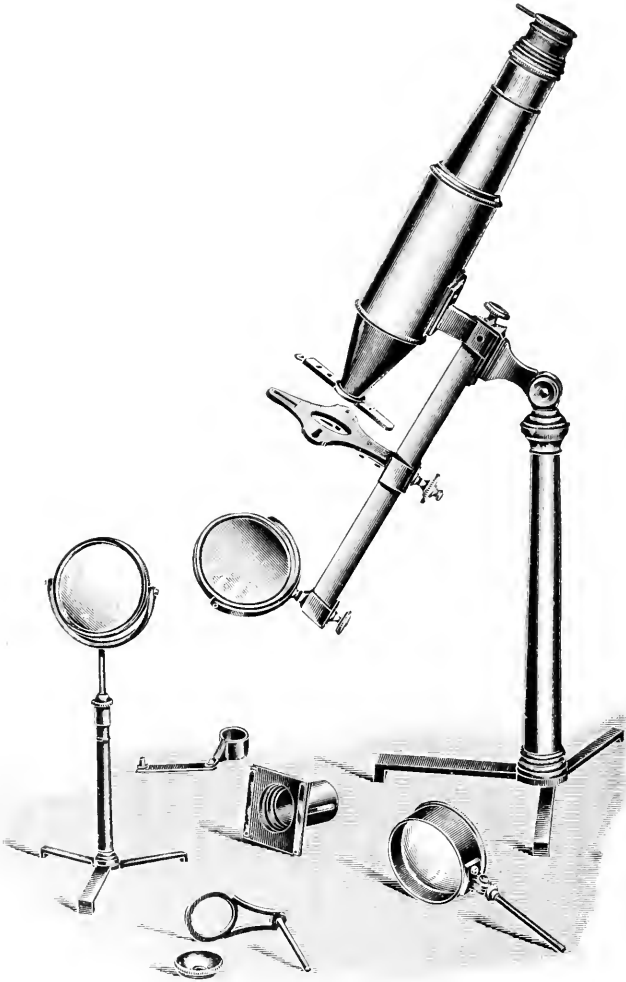

FIG. 49.

* This subdivision contains (1) Stands; (2) Eye-pieces and Objectives; (3) Illuminating and other Apparatus; (4) Photomicrography; (5) Microscopical Optics and Manipulation; (6) Miscellaneous.

stage of this old Microscope, does not appear to have been known, so far, as an optician of the latter part of the eighteenth century. The Microscope which bears this name has a close resemblance to instruments made by George Adams about 1780, though it possesses some features and variations of interest.

The body is very large, tapering towards both ends, and fastened to

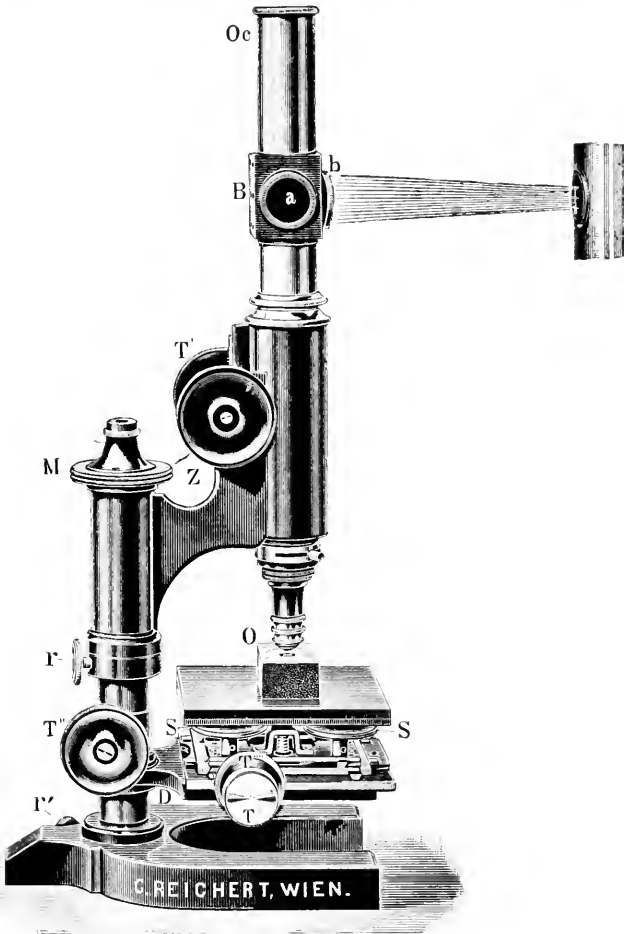

FIG. 50.

the limb by means of a dovetailed slot. The limb is a triangular bar with the rack cut inside, after Benjamin Martin's plan; it is joined by means of a compass joint to a tall pillar raised on a folding tripod base. The whole Microscope is made of brass, and very massive.

The object-glasses, six in number, and consisting of single lenses, are mounted on a sliding bar, which is a feature of earlier Microscopes. The stage is triangular, and carries below a lens mounted in a tube,

which acts as a substage condenser. A bullseye on separate folding tripod-stand is provided, and another much thicker bullseye is fitted to the stage. The date of this old Microscope may approximately be given as 1790 to 1800.

Fig. 49 shows the stand with the body set at an angle. To the extreme left is a bullseye condenser on a stand having a tripod base; a stage bullseye condenser is also shown in the foreground to the right; it is excessively heavy, so heavy that its hinged joint fails to hold

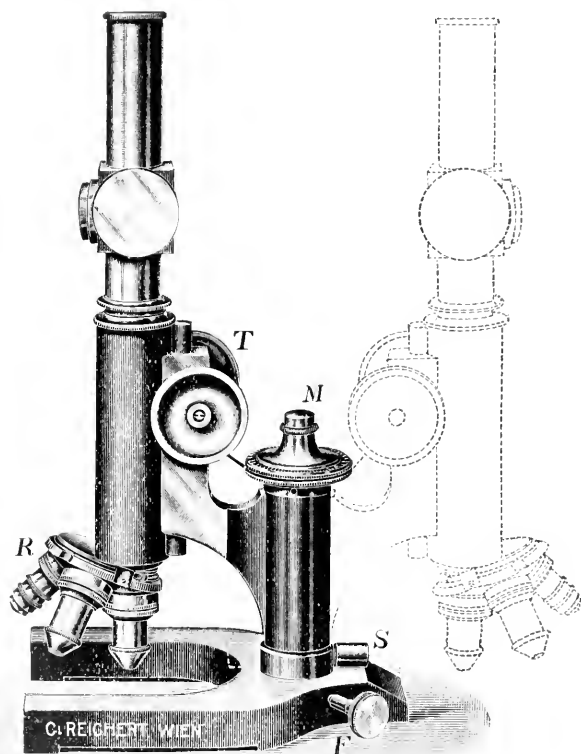

FIG. 51.

it in any required position. A Lieberkühn with its holder are seen in the foreground, and in the centre lies a spring stage for carrying "sliders" containing objects mounted between discs of talc: attached to this is a tube containing a substage condenser which slides in it for focusing; the tube is dropped through the opening in the stage-plate, the spring-stage resting thereon. The use of the piece of apparatus lying in the background is unknown, but it may have been intended to hold a candle.

Rejtös Metal-Microscope.*—This instrument is made by Messrs. Reichert from Professor Rejtös's designs. It is represented in fig. 50 as a Laboratory Microscope. Fig. 51 shows it, however, in a simplified form, the middle parts, including the stage, having been removed to facilitate application of the instrument to the direct examination of large-sized objects. For the weaker magnifications, daylight or lamp-light incident on the metal surface will suffice. But for stronger powers illumination of the object must be performed with the special apparatus inserted in the drawn-out tube. This apparatus can be inserted, or removed, as an ordinary ocular. It consists of a cylindrical

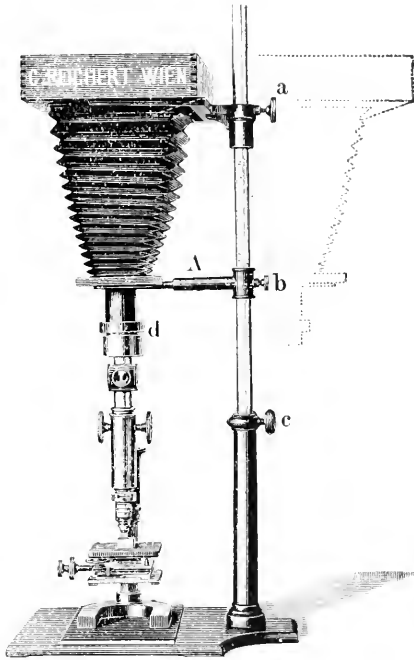

FIG. 52.

sleeve carrying a plane-parallel glass plate, inclined at 15° to the tube axis, and an illuminating lens. The focal distance of this lens equals the sum of the distances from the lens to the glass plate, and from the glass plate to the objective. The light is set, preferably, at a distance of 1 m. from the apparatus. An incandescent gas-mantle or a triple burner will be found the most suitable, and must be placed on a special stand adjustable as to height. It is desirable to enclose the light-source in an iron or asbestos cylinder, with a lateral aperture of suitable size. This aperture must be fitted with an illuminating lens of parallelized light as required. In making the adjustments the light-source must be first brought to the level of the illuminating apparatus B.

* Special Catalogue, Em 3, "Metall-Mikroskope," C. Reichert, Vienna, pp. 1-7.

The observer, having removed the ocular, then looks down the tube, and will probably find that the interior of the tube is not uniformly illuminated: small adjustments, in elevation, of the light-source will correct this defect. The function of the lens *b* is to make the light-rays convergent, so that after incidence on the inclined glass plate (not shown in figure) they may focus on the objective-focus and thence reach the object. Thence they are reflected upwards through the objective to the ocular. The object to be examined (fig. 50) should be provided with two plane-parallel surfaces so that it may lie horizontally on the stage, small differences of level being compensated by the screws *SS*. The object-stage is provided with two slides, so that the stage may be moved north-south, east-west, by means of the milled-heads *T'' T'''*. The stage is raised and lowered by means of *T''*. If the object is too thick for the stage, the stage can be removed, and either the object be placed on the horse-shoe foot, or the instrument, by relaxation of the screws *r r'*, be swung round and brought (fig. 51, dotted lines) directly over the object. If photomicrographs be desired, the vertical arrangement shown in fig. 52 is adopted, a picric-acid filter having been placed in front of the light-source.

Reichert's New Metal-Microscope.*—This instrument (figs. 53–59) is distinguished from Rejtö's Metal-Microscope chiefly in the following

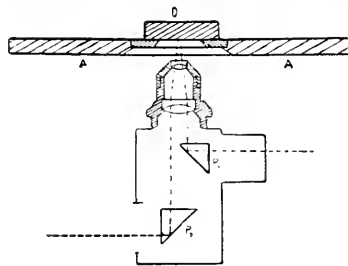

Fig. 53.

respects:—1. By a different mode of light application and by a more complete illumination of the object. 2. By the necessity of preparing only one plane-surface; this plane-surface being set in contact with the stage. 3. By a specially convenient arrangement for photomicrography. 4. By a new fine-adjustment and a lateral screw for oblique inclination. In fig. 53 a schematic representation of the ray-path is shown. The light issuing from the source is brought to the object by means of the prism P_1 and the objective—this objective thus acting as a condenser. The light reflected from the object reaches the prism P_2 , and thence it is deviated through the horizontal tube to the observer's eye. To change over from subjective observation to the photographic fixation of the image, the last-named prism P_2 is rotated 90° about an axis perpendicular to the stage-plane. It will be seen from fig. 56 that the photographic camera is perpendicular to the optical bench carrying the axis of illumination. For convenient observation of the image, an

* Special Catalogue, Em 3, "Metall-Mikroskope," C. Reichert, Vienna, pp. 1–14.

ocular of approximately right-angled shape can be applied to the instrument; it is placed in the sleeve of the horizontal tube (fig. 54, *b*). A prism suitably placed deflects the rays to the ocular, and the operator

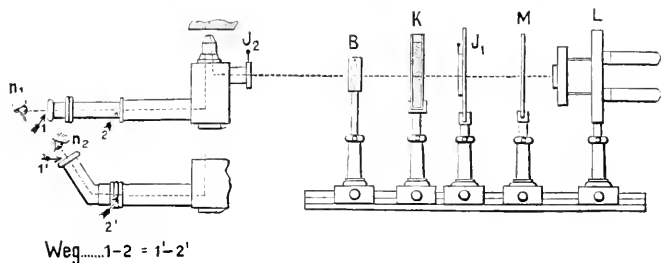

Fig. 54.

can therefore make his observations in the ordinary microscopical attitude. For the light-source either the incandescent gas-mantle, the Nernst lamp, the linelight, or the electric arc-light may be used; but for photomicrography only the three last can be recommended. The arrange-

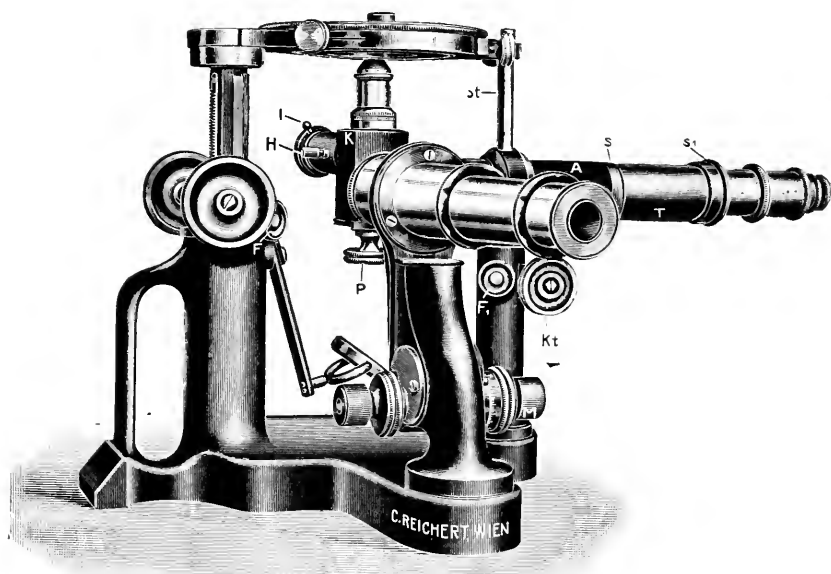

FIG. 55.

ment of the parts of the illuminating apparatus will be understood from figs. 54 and 56. At a slight distance from the light-source L a revolver diaphragm J_1 limits the illuminating area. If the filter-screen K is used it will be placed between J_1 and the illuminating lens B. The

external appearance of the Metal-Microscope is shown in fig. 55. A strong handle-shaped pillar for convenient transport of the instrument rises out of the stout cast-iron base-plate. This pillar carries the rack-and-pinion coarse-adjustment of the stage; it also carries the universal mirror. The fine-adjustment is similar to that adopted in Reichert's stands A i. and A ii. The Microscope-stage can be centred and is rotatory.

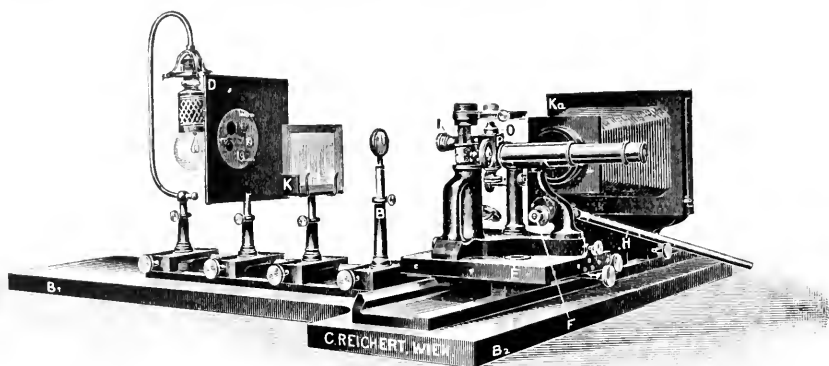

FIG. 56.

It has two lateral position-screws, which permit a movement of several millimetres; larger movements must be done free-hand, or with the sliding-stage (fig. 56). The camera (fig. 56) is on heavy metal feet, and moves on an optical bench. The tube of the Microscope is applied to the camera with light-tight connexion. Movement of the eye-lens of the projection ocular throws a sharp image on the matt-glass screen of the camera without requiring any alteration in the instrument as ar-

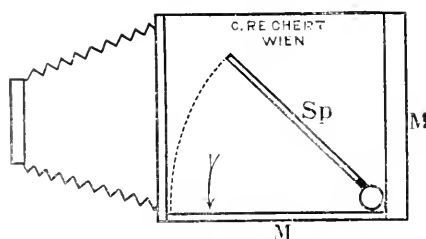

FIG. 57.

ranged for visual observation. It may, however, be necessary, especially in the use of filters, to perfect the image by the camera fine-adjustment—this is done by a Hook key.

New Mirror Reflex-camera.—In order to enable the operator to control the photographic image without rising from his seat, this camera (fig. 57) has been contrived. It has the matt-glass M parallel to the camera-axis, the shutter-box K in the usual place. Between them is a vertical mirror Sp, worked from outside by a knob, and rotatory

about a vertical axis. The mirror is rotated in the direction of the arrow, and at an angle less than 45° throws the image on to M. Another view of it is seen in fig. 58. Fig. 59 gives a general view of the whole instrument.

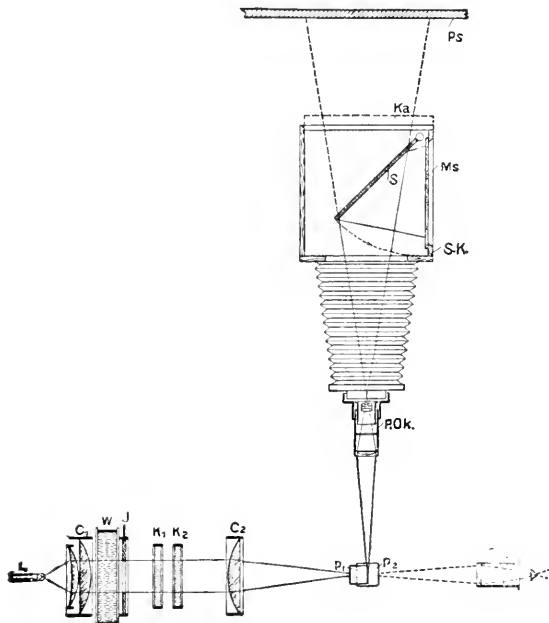

FIG. 58.

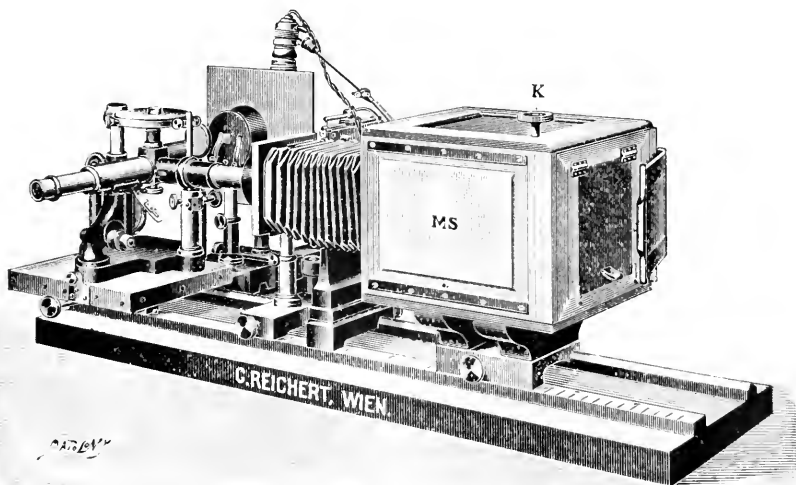

FIG. 59.

(2) Eye-pieces and Objectives.

Winkel's Eye-piece with Screw Micrometer and Graduated Glass Diaphragm.*—Fig. 60 gives a general view of this eye-piece, which can be used for approximate measurements as well as for readings of great precision. It is provided with a clamping screw to fix it firmly to the tube of the Microscope, and an adjustable eye-lens for focusing the scale. The scale itself is mounted on a plate (fig. 61), which is movable in a lateral direction by a screw, the spring serving to keep the plate always in contact with the screw, which has five threads to the millimetre and

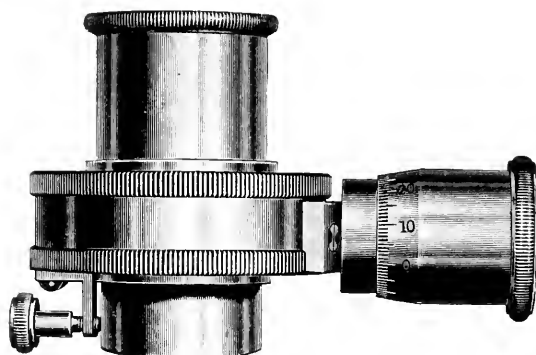

FIG. 60.

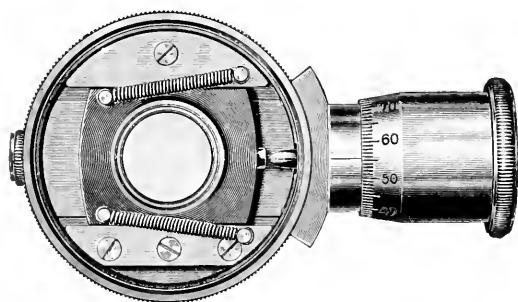

Fig. 61.

is fitted with a drum divided into 100 parts; each interval of the drum is equal, therefore, to a lateral displacement of the scale of $\frac{1}{100}$ mm.

This combination of scale and screw micrometer has been chosen (at the suggestion of the late A. Koch†) in preference to screw and web usually employed, as it gives a ready means of obtaining the exact measurement of objects subtending a number of divisions of the eye-piece's scale, the fractional part only of an interval having to be determined by means of the screw.

* R. Winkel, Gottingen Catalogue, 1911, p. 14 (2 figs.).

† Zeitschr. wiss. Mikrosk., vi. pp. 33-35.

The Society's Standard Thread.*—E. M. Nelson makes the following communication :—

“Mr. Watson Baker, in the *Journal of the Royal Microscopical Society*, 1911, p. 175, has called attention to ‘the great diversity which exists in the objective screw-threads made by the various makers, and described as of the Royal Microscopical Society’s standard size.’ Possibly a few remarks from one of the members of the sub-committee appointed by the Council of the Royal Microscopical Society to report upon this very question may not be out of place, the more so as Mr. Watson Baker’s paper deals only with the facts which, apart from the history of the subject, may cause very erroneous ideas to be formed.

The Society's Screw.—Fifty-four years ago this screw was adopted by the Microscopical Society of London, upon a report from a sub-committee composed of George Jackson, Charles Brooke, and H. Perigal, jun. The multiplicity of adapters had even then become such a nuisance that the Society standardized a screw with a view to stopping it, and the thanks of everyone using a Microscope is due to them for so doing. This standard screw was at once adopted by the three leading London Microscope makers—viz. Messrs. Powell, Ross, and Smith and Beck. (The size of the screw was that used by Messrs. Smith and Beck, Mr. Smith having brought it with him from Messrs. Tulley, of Islington; he had previously used it in making the celebrated Lister-Tulley Microscope. The Tulleys had taken this screw from the “Pipe” of Benjamin Martin’s Microscope † (1760–70). When it was standardized it was altered to a Whitworth thread; but, notwithstanding, a Benjamin Martin’s “pipe,” or a Tulley-Lister objective, will screw readily into any R.M.S. standard nose-piece; but an objective with a standard thread is the merest trifle too large to enter either a Benjamin Martin or Tulley nose-piece).

Six months after the adoption of the report Mr. Richard Beck published an account, with six figures, of the screw-gauges and tools. Two plug and ring-gauges for the tops of the threads of the inside and outside screws, and pairs of sizing-tools, were made by Whitworth, the sizing-tools being supplied to the trade at cost price. At first there was, it seems, a little grumbling and fault-finding, as was inevitable upon a reform of this kind; but soon things shook down and settled themselves, with the result that, in my own experience, I have never seen an objective by Powell, Ross, or Beck, that was not interchangeable in either of their nose-pieces, and I very much doubt if anyone else has.

In the eighties, German object-glasses, by Messrs. Zeiss, Leitz, and others, were largely imported, and at the end of that decade there was a demand for sizing-gauges. One of the secretaries of the Royal Microscopical Society, not finding any in stock, took an old tap he happened to see in a drawer, and, without comparing it with the standard gauges, and at a considerable expense, had it precisely reproduced, and distributed the facsimile copies on the Continent. All this was done quietly, and no one knew anything about it.

Some objectives I had purchased from Messrs. Zeiss had been sized

* *English Mechanic*, xciii. (1911) p. 290.

† See this *Journal*, 1898, p. 474, fig. 81.

under the conditions specified: (1) Those showing absorption bands, by these new tools, and when I received them I found, to my astonishment, that they would enter none of the eight Microscopes I had. The experience of others was similar, and as representations were frequently made to the Royal Microscopical Society upon the subject, the Council, in 1896, appointed another sub-committee to report upon the whole question. This sub-committee, of which I had the honour of being a member, found that the tap which had been copied was a very badly-cut screw, which, when tested by the Society's standard gauges, was not of the Society's standard size. We ordered that it and its copies should be destroyed. We recommended that new sizing-tools should be made in accordance with our standard gauges, and we suggested that limiting gauges should be added to our standards. Our recommendations* were adopted by the Council, and the new gauges and sizing tools were ordered from Messrs. Whitworth. These were supplied, and, so far as these sizing-gauges are concerned, I personally tested every one, and I am quite sure that all objectives and nose-pieces sized by any one of those will be interchangeable. I purchased a set (now on the table as I write). The legend on it is "R.Mic.So., London, 1897. Whitworth, Manchester, .8015 36ths," and on the die is .7967.

Mr. T. Powell, also a member of the sub-committee, exhibited the original sizing-tool his father had bought. He said it was the one he had always used. After all these years it was in as good a condition as it was when new; it was made and hardened in one piece, and was without the three adjustable blocks which are fitted to the new dies.

The Continental manufacturers to whom the Society had supplied the wrong screw were very indignant, and rightly, too. At first they refused to accept the new tools, but after Mr. C. Beck had pointed out to them the confusion that must inevitably arise, they chivalrously waived the matter, and adopted the true standard screw. Mr. C. Beck deserves the warmest thanks of all microscopists for his good offices in this matter.

So far as my own experience goes, I have not seen a single objective that has been sized by these new tools that is not interchangeable. If a new standard, or any alteration in the Society's present standard, is proposed to the Continental manufacturers, I think, after what has already occurred, there will be some difficulty in persuading them to accept the change.

Personally, I prefer an objective that screws very loosely into a nose-piece, and fixes into position by facing up on its flanges; so, looking at the question from every point of view, my counsel would be to leave things as they are."

(3) Illuminating and other Apparatus.

Directions for using Glass Micrometers.—Messrs. Carl Zeiss have published, under the above title, a very clear and complete pamphlet of 8 pages, dealing with microscopic magnifications. Eye-piece micrometers, Plagge projection micrometer eye-pieces, stage-micrometers, and methods of determining magnifying powers, are all dealt with.

* See this Journal, 1896, p. 389.

Interferometer.—This instrument (fig. 62) was shown at the June Meeting and was described fully by C. Beck (see Proceedings, p. 565, of the present number).

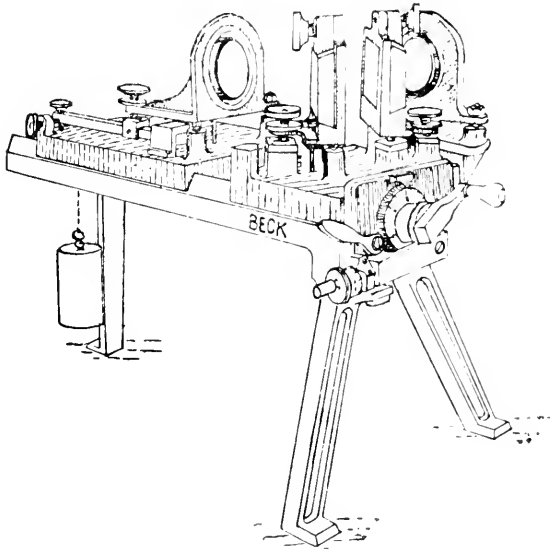

FIG. 62.

Micro-spectroscopic Observation.*—F. J. Keeley points out that while micro-spectroscopy has been largely used with transmitted light, very little application of it has been made with reflected light. Yet with reflected light it is not only suitable for use with small quantities, but has a number of additional advantages. Thus he finds that absorption bands are usually more distinct; a small crystal on a mineral specimen or a gem embedded in an opaque setting may be examined without disturbing or damaging it; and phenomena such as iridescence on opaque substances may be studied.

The Microscope used for this purpose should always be a binocular, which permits the object to be examined through one tube, while the spectroscopic ocular is applied to the other. The illumination should preferably be rather brighter and whiter than is generally necessary for the examination of opaque objects, and is best concentrated by means of a parabolic silvered reflector attached to the objective. For preliminary examination, the older form of micro-spectroscope, as made by Browning or Beck, is preferable, as very faint bands are more readily noted in its short, bright spectrum; but for further study and for recording the spectra, the Zeiss model with photographed scale is more desirable.

There are two classes of spectra which can be advantageously studied

* Proc. Acad. Nat. Sci. Philadelphia (Feb. 1911) pp. 106-16.

thus permitting the identification of certain minerals and gems: (2) interference spectra, thus assisting in determining the cause of lustre and iridescence. In the first class the method is very effective in dealing with minerals of the didymium and zircon groups, garnets, rubies, spinels, emeralds. The spectra are frequently so characteristic as to give infallible means of identification. For reference all spectra should be recorded diagrammatically on paper ruled with lines corresponding to the scale showing width of band: it should also be noted whether edges are sharp or misty, and whether the darkest part of band is central or eccentric.

In dealing with the second class it should be remembered that lustre and iridescence include such causes as simple reflection, refraction, and dispersion, scattering of light from microscopic particles, polarization, and diffraction. The most potent cause, and that to which practically all iridescence is due, is the interference produced by reflection from thin films, and this can be advantageously studied with the micro-spectroscope. Such interference colours generally show dark bands in the spectrum, one in the lower order colours produced by thin films, and two or more as the films become thicker so that additional wavelengths interfere. For comparison, records should be made of the spectra of all the brighter colours, which can be done by observing them in the "Newton's rings" produced between two surfaces of glass or by blowing a bubble of melted glass until it bursts, when the thin edges will answer the same purpose. The author has examined the natural iridescent surfaces of many minerals, butterfly scales, beetle scales, iridescent birds' feathers, opals, the chatoyance of cat's-eye germs, and the lustre of pearls. His experiments seem to show that the explanations usually given of certain phenomena, e.g. of butterfly scales, stand in need of revision. Thus the particularly brilliant blue spots on the wings of *Papilio paris* are apparently due to a film of air of about 0.58μ in thickness. Again, the lustre of pearls is not due to minute corrugations, but to repeated parallel laminae separated by extremely thin films.

(4) Photomicrography.

Leitz' Small Photomicrographic Apparatus.*—This apparatus, numbered IV, in the maker's catalogue, is shown in fig. 63. It has a camera extension of 25 cm., and is designed for use in the vertical position only. It consists essentially of a rectangular base-plate of iron, covered with cloth, on one side of which a vertical steel rod is mounted in a massive socket. This rod carries the camera, which by means of the two clamping fittings (shown in the illustration) can be fixed at any required height. When so fixed the camera can be rotated for the final adjustment of the specimen on the stage by direct observation; the return of the camera to exact alignment with the optic axis of the Microscope is ensured by the provision of a spring-catch on the camera fitting, the catch engaging with a groove in the steel rod. The length of the camera is adjusted by sliding the rod, carrying the front up or down in the grooved fitting in which it is mounted. A light-tight

* Leitz' Catalogue, 43 G, Photomicrographic Apparatus, p. 18.

connexion is fitted to the front of the camera for use with the Microscope and for receiving the photographic objectives (microsummers) by means of sliding adapters when the Microscope is dispensed with.

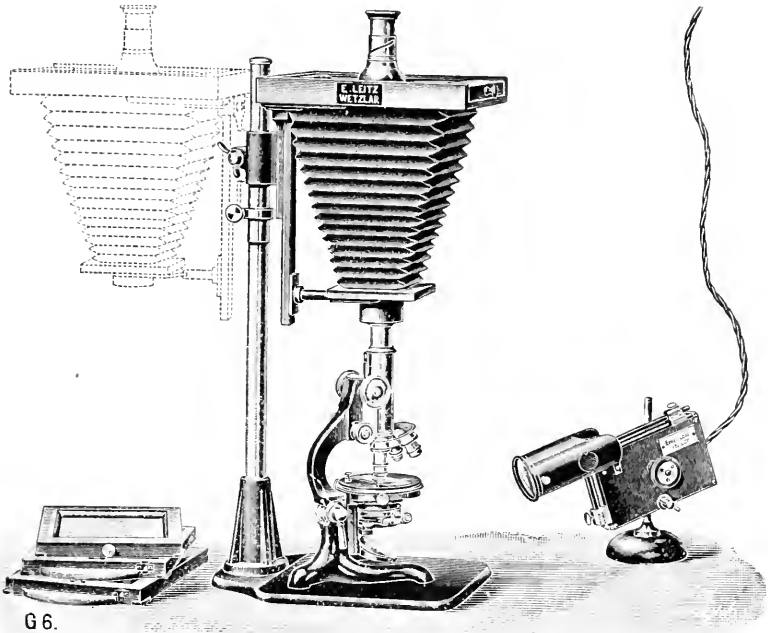

FIG. 63.

Leitz' New Large Photomicrographic Apparatus.* — This apparatus, 1A in the maker's catalogue, is shown in fig. 64 (vertical position). It is characterized by its long camera sliding upon an optical bench. The essential advantage of such a camera consists in obtaining a large variety of magnifications with a single objective; but, in addition to this, greater depth of focus is obtained by using an objective of relatively low magnifying power with an extended bellows. The optical bench, which is in two parts, consists of steel tubes mounted at either end and also midway upon cast-iron feet, the two halves being connected by a hinge arrangement. Upon these tubes can be fitted the various carriers, the curved feet of which fit the tubes exactly, any required position being maintained by means of clamping-screws. The camera occupies one half of the optical bench and rests upon two carriers, one of which holds the focusing screw, while the other carries the camera front with a portion of the light-tight connexion. By means of the hinge provided the camera can be brought into a vertical position: the apparatus may therefore be used either vertically or horizontally, as required.

* Leitz' Catalogue, 43 G, Photomicrographic Apparatus, p. 6.

The camera can be extended to any required distance up to its full length of 100 cm., as each carrier can be moved independently of the other. The bellows, besides being very substantially made, has additional wire supports, two in number, to prevent sagging when fully

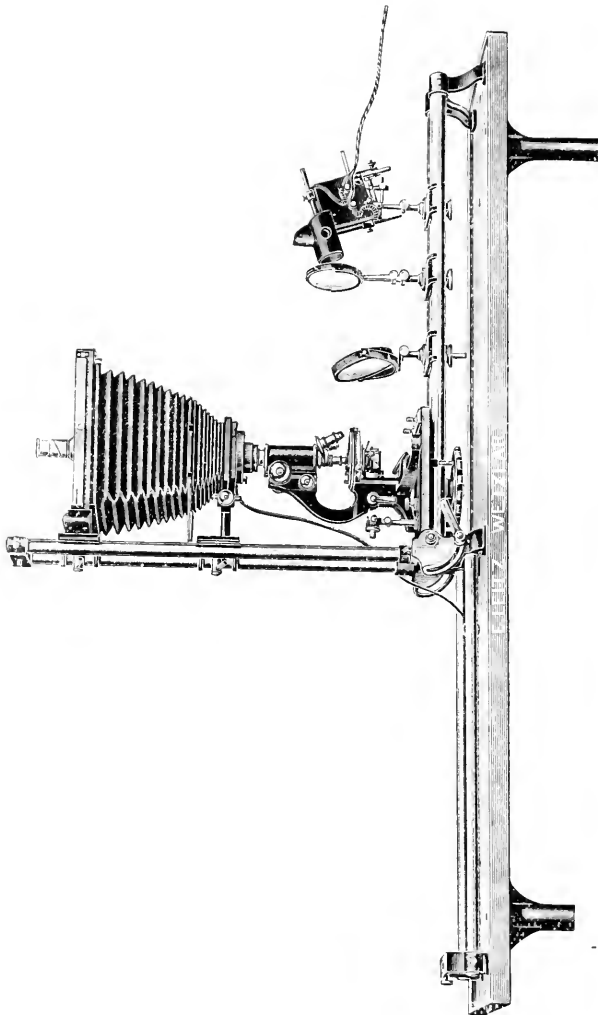

FIG. 64.

extended: the lower portion of the bellows is hinged to the focusing screen, so that upon the withdrawal of two bolts which keep the upper portion in position, it can be retracted in order to observe the image from the front whilst the necessary adjustments are being made. Two

focusing screens, one of ground glass and the other of clear plate glass, are supplied with the apparatus, together with two single dark-slides taking plates 24 cm. square, with carriers for smaller sizes, either English or Continental. The front of the camera is fitted with a pneumatic shutter for time and instantaneous exposures, and for the light-tight connexion referred to above, into which the objective-adapters can be pushed.

The other half of the optical bench is occupied by (1) the Microscope mounted upon a sliding base-plate; (2) an illuminating lens or condenser; (3) a large iris-diaphragm; and (4) a Liliput arc-lamp. Each of these accessories is adjustable for height; that for the sliding base-plate being controlled by a hand-wheel below the level of the steel rods, this adjustment being necessary to compensate for the variation in the heights of the optic axis of horizontal Microscopes. A special mechanism is fitted to the base-plate, and this, in conjunction with a lengthening rod, permits of the fine-adjustment being effected during observation of the image on the screen.

For taking photographs of large objects with the microsummars without the Microscope, a special vertical stage is provided, mounted on a sliding carrier, and fitted with a micrometer-screw fine-adjustment, to which the lengthening rod referred to above can also be connected should the length of the camera necessitate its use. A series of interchangeable diaphragms is supplied with the stage, and the diameter of each diaphragm corresponds approximately to the focal distance of the lens with which it is to be used, each diaphragm being provided with an illuminating lens which will illuminate uniformly and without colour the given aperture. Objectives and diaphragms are marked, so that the correct pair can be rapidly selected.

Leitz' Photomicrographic Apparatus for Photographing Insects.*

This apparatus (fig. 65) has been suggested by Hermann, and is numbered III. in Messrs. Leitz' Catalogue. It is constructed for use in the horizontal position only, and is mounted on a stand consisting of two steel tubes resting upon two pairs of cast-iron feet. The camera, which can be extended to 70 cm., is mounted upon steel tubes: it has wire supports to prevent sagging, and the bellows-frame can be retracted in the same manner. The front carrying the objectives is fitted with a time and instantaneous shutter. Two lamps (Liliput arc, or incandescent gas) with condensing lenses serve to illuminate the object. These lamps are mounted on slotted arms attached to the pillars carrying the camera front in such a manner that not only the distance of the illuminant, but also the angle of incidence of the light can be varied within wide limits; it thus becomes an easy matter to illuminate an object brightly and uniformly, or to control the density and position of the shadow required to give the necessary contrast.

The object-holder consists of a base-plate sliding upon the tubular base, to which it can be clamped in any desired position by means of a thumb-screw. It has two micrometer-screw adjustments for moving the object in a horizontal plane in two directions, at right angles to one

* Leitz' Catalogue, 43 G, Photomicrographic Apparatus, pp. 16-18.

another, one of which serves for lateral displacement and the other for focusing the image on the screen. The former movement is especially useful when taking stereoscopic pictures, and both are provided with lengthening rods, so that the adjustments are easily effected when the operator is sitting in front of the focusing plate. For the vertical adjustment of the object a rack-and-pinion adjustment is provided, upon which is mounted a universal arm carrying a glass rod, the possible movements of which are well shown in the illustration, the object being fixed to the point of the rod by an adhesive, or by first mounting upon cork.

In order to render the apparatus suitable for taking pictures by transmitted light, the universal arm figured and described must be removed

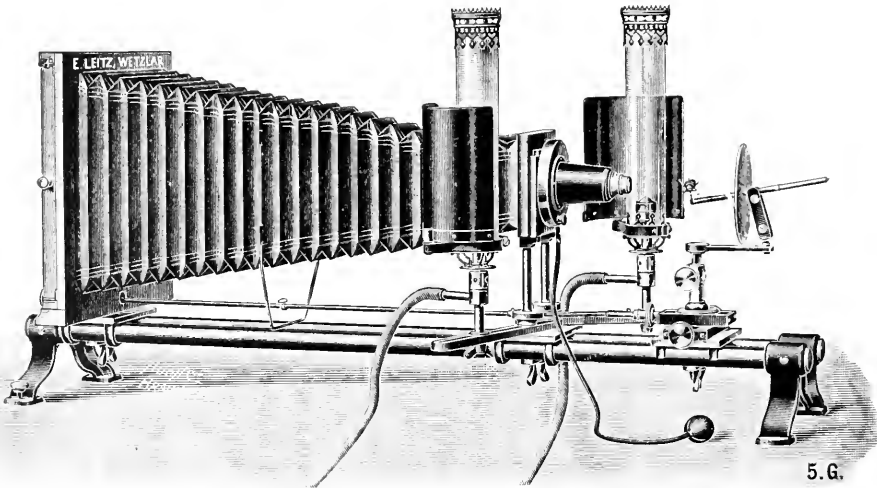

FIG. 65.

from the pillar actuated by the rack-and-pinion and replaced by a vertical stage. The illuminant (Liliput arc or incandescent gas) and condenser are then mounted on a special removable optical bench behind the stage. Leitz' microsummars will be found particularly useful with this apparatus; but, if higher magnifications, such as can only be obtained with a compound Microscope, be required, a tube carrying objective and eye-piece can be screwed into the front of the shutter, thus dispensing with the ordinary Microscope stand.

Barnard's Practical Photomicrography.*—In this work the subject is treated by the author, J. E. Barnard, in a simple and straightforward manner, and from first-hand knowledge. He remarks in the preface that it is one thing to be conversant with the practical side of the subject.

* London: Edwin Arnold (1911) xii. and 322 pp. (10 pls. and 79 figs.).

but quite another to write such a description of the procedure as will enable another person to carry it out. From a perusal of the work it is obvious that his descriptive power is quite equal to his practical knowledge. After a short description of such Microscope stands as are most suitable for the work, the author enters in fuller detail into the optical equipment—objectives, oculars, condensers, and collecting-lenses. The various types of illuminant and illumination are fully described—a subject as to the paramount importance of which no photomicrographer needs to be reminded. Upon the illumination success primarily depends, and the seventh and eighth chapters, by their insistence on the great advantage to the amateur or beginner of a good deal of preliminary experimenting, are intended to give him a firm grounding in the art of illuminating an object. For such preliminary work nothing can be more instructive than the observation of the image projected on an opaque screen. Colour-filters for securing contrast, or for more perfectly rendering colour differences in monochrome, are next considered, and are followed by plates and their development. Chapter XI. deals with photomicrography by ultra-violet light—a method with great possibilities, but at present only suitable for practised experts—with stereoscopic microphotographs, and with the production of coloured lantern-slides. Lastly, a series of progressive examples, ranging from botanical, bacteriological, and pathological subjects, to diatoms, foraminifera and metallic sections, and each chosen to show some special point in the structure or lighting, are illustrated by ten collotype plates.

(5) Microscopical Optics and Manipulation.

Ultramicroscopical Study of Solutions of Iodine.*—The fact that iodine gives, according to the nature of the solvent, solutions either violet or brownish, has attracted much attention from chemists. J. Amann has, in addition to chemical investigations, now attacked the subject by ultramicroscopical methods. He finds that there is a marked ultramicroscopic difference between the violet and the brown solutions. Although the former only rarely contain ultramicroscopic micellæ, yet the brown solutions furnish an ultramicroscopic micellar-phase, more or less abundant. The author fully discusses the significance of his observations, which seem to confirm the theories of polymerization of iodine.

Elliptic Interference with Reflecting Grating.†—C. Barus describes a method for obtaining elliptic interference. In a previous experiment (fig. 66) L was a source of light, M a glass-plate grating, $G_m G_n$ plane-mirrors, each reflecting a spectrum from M. It was found that elliptical interference was produced whenever the rays returned after passing M by transmission and reflection were made to overlap in the spectrum. The author's present method is the converse of this, since the gratings and the opaque mirrors now change places. Parallel rays from L strike the plate of glass M, and the component rays reach identical reflecting gratings G_m and G_n placed symmetrically with respect to M at an angle i to the E and L directions. The undivided rays pass off

* Bull. de la Soc. Vaudoise des Sci. Naturelles, xlvii. (1911) pp. 1-50.

† Proc. Amer. Phil. Soc. Philadelphia, i. (1911) pp. 125-39 (5 figs.).

eccentrically at R and are not seen in the telescope at E. They may, however, be seen in an auxiliary telescope pointed in the line R, and they then facilitate the adjustments. Rays diffracted at the angle $L\hat{i}$, however, are respectively transmitted and reflected by M and interfere in

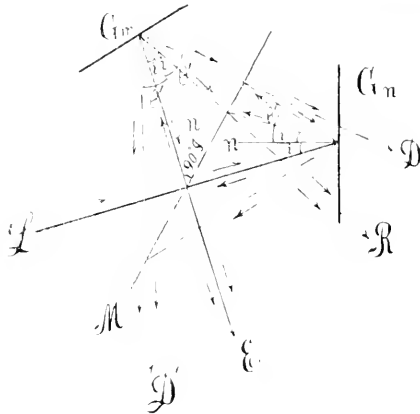

FIG. 66.

the telescope in the line E. Similarly, rays diffracted at an angle $\theta > i$ interfere in the line D.

The author describes the adjustments necessary, and several modifications of the experiment.

HARTING, H.—**Über eine Grenzbedingung bis der Konstruktion gewissen optischer Systeme.**

[The author has worked out the numerical values of the co-efficients for certain two-lens optical systems.]

Zeit. f. Instrumentenk., xxx. (1910) pp. 359-63.

HEINRICH, K.—**Verwendung der Savartschen Platte bei der Beobachtung der relativen Phasendifferenz zur Bestimmung der optischen Konstanten von Metallen**

Berichte über die Verh. d. König. Sächsischen Gesell. d. Wissenschaften zu Leipzig, Math.-Phys. Klasse, v. (1910) pp. 253-5.

(6) **Miscellaneous.**

Quekett Microscopical Club.—The 474th Ordinary Meeting was held on May 23, Dr. E. J. Spitta, F.R.A.S., Vice-President, in the Chair. Mr. C. D. Soar, F.L.S. F.R.M.S., read a paper on "The Work of the late Saville Kent on British Hydrachnids." Together with Mr. Williamson, of Edinburgh, the author is preparing a monograph of British Hydrachnids, and having, by courtesy of the British Museum authorities, had access to Saville Kent's collection of slides, notes, and drawings, it was thought a brief account would be of interest to the Club. Saville Kent's work on these organisms was begun in 1867 and continued till 1883, and from the material available Mr. Soar had identified fifty

species, of which forty were adult forms. Saville Kent's method of preparing and mounting his specimens was described in *Science Gossip*, 1882. The specimens, adult, larvæ, or ova, were killed by momentary immersion in boiling water. They were mounted in a cell of suitable depth in either camphor-water, or a solution of 1 of spirit to 4 or 5 of water. Specimens fourteen years old so preserved retained their pristine form and brilliance of colour. The Hon. Sec. read a paper communicated by Mr. E. M. Nelson, F.R.M.S., on "Methods of Illumination." The paper dealt first with mirror illumination, and the right and wrong ways of getting centred illumination with concave mirrors only. The use of ground glass was referred to, and, generally, its use deprecated. The least harmful position for it is below the substage condenser. The very cheapest form of substage condenser will give a better image than is obtainable with ground glass. In dealing with the use of screens for visual work, it was stated that the normal eye is most sensitive to fine detail when the light is peacock-green in colour.

The 475th Ordinary Meeting of the Society was held on June 27, Mr. C. F. Rousselet, F.R.M.S., Vice-President, in the Chair. A paper by Dr. E. Penard, on "Some Rhizopods from Sierra Leone," was read by Mr. A. Earland, F.R.M.S. The material examined was supplied by Mr. G. H. Wailes, and yielded fourteen species of fresh-water Rhizopods, of which three were new, and four at least might be considered as special forms and varieties. The genera represented were *Centropyxis* (2 species), *Diffugia* (5 species, 2 new), *Euglypha* (2 species), *Lesquerentia* (3 species, 1 new), and *Pontigulatia* (2 species). The new species will be fully described and figured in the next issue of the Club's Journal. Mr. T. A. O'Donohoe read a note on "Dimorphism in the Spermatozoa of the Flea and the Blow-fly." In the common flea two forms were found, both of which are very large compared with those of man, whose spermatozoa have an average length of 0.06 mm. In the flea the larger form is 0.7 to 0.45 mm. long, and the smaller form about half these lengths. Carbol-fuchsin or gentian-violet are suitable stains. The spermatozoa of the blow-fly are much smaller than those of the flea. The two forms observed do not differ much in length, but one is very much thicker than the other. (For other cases of dimorphic spermatozoa see this Journal, 1905, p. 34.) A paper on "Normal and Abnormal Vision in Microscope Work," by E. M. Nelson, F.R.M.S., was read by the Assist. Hon. Sec. The experiments described showed that differences from normal sight produced the greatest effect with low powers, such as those obtained with a "loup."

B. Technique.*

(1) Collecting Objects, including Culture Processes.

Examination of Water for Typhoid Bacilli by the Complement-fixation Method.†—G. Volpino and E. Cler employ the complement-

* This division contains (1) Collecting Objects, including Culture Processes; (2) Preparing Objects; (3) Cutting, including Embedding and Microtomes; (4) Staining and Injecting; (5) Mounting, including Slides, preservative fluids, etc.; (6) Miscellaneous.

† *Centr. Bakt.*, 1^{te} Abt., lviii. (1911) pp. 392-9.

fixation reaction in determining the presence of typhoid bacilli in water. The water is filtered through a Chamberland filter; the deposit is scraped off and mixed with normal saline. To a measured quantity of this are added 2 drops of a strong anti-typhoid serum, 1 drop of complement, and 1 c.cm. of sensitized blood-corpuseles. The absence of haemolysis indicates the presence of typhoid bacilli. By actual trial the authors have determined that the method is much more delicate and reliable than the culture methods at present in use, and it is just as easy of application.

Collodion Filters.*—J. Duclaux and A. Hamelin make some observations on the use of collodion filters, based on an experience of several years. The usual difficulty in their use is that they cannot be dried or sterilized by heat. The authors have succeeded in preparing cellulose filters which obviate these difficulties, but the results are not constant enough to be satisfactory. These were prepared by mixing a solution of cellulose with Schweitzer's fluid, but much better results have been obtained by denitrifying nitrocellulose, the best agent for the purpose being ammonium sulphohydrate. These filters can be dried any number of times, or placed in boiling water without being affected. They also resist the action of alcohol, ether, and acetone. In filtering liquids containing very fine particles the process is very slow. It is impossible to use air-pressure lest the filter be ruptured, and the device is recommended of using osmotic pressure as an accelerating agent. To this end the authors employ a solution of Congo red, which does not penetrate the cellulose filter, but exerts a considerable osmotic pressure upon it. By this means they were able to increase the rapidity of filtration by as much as seven times without endangering the filter.

Resistance to Passage of Microbes through Collodion Filters.† Grenet and Salimbeni have succeeded in preparing a collodion filter for general use. Their method is to dip an ordinary Chamberland candle into a solution of collodion containing 10 p.c. of glycerin. The glycerin prevents the filter drying and so becoming useless. Before doing so it is necessary to remove all the air from the candle by plunging it in water, or, better, in alcohol. Such a filter prevents the passage of ultramicroscopic organisms, and it retains its efficiency for at least a year. It does not become clogged like an ordinary Chamberland. To prevent the growth of moulds upon it, it is advisable to add a trace of formalin to the collodion solution.

Rapid Method for Isolating *Oospora linguæ*.‡—F. Guéguen states that carrot is the least unfavourable medium for isolating *Oospora linguæ*, a parasite found in cases of black tongue. The carrot is inoculated by stroking the surface with an affected papilla. In about five days the growth will be evident above the general surface. A trace of the growth is removed and sown in liquefied gelatin: a second tube is inoculated with a drop of the first, and from the second a third tube is similarly inoculated. Sometimes it is necessary to make a fourth and

* Ann. Inst. Pasteur, xxv. (1911) pp. 145-9.

† Comptes Rendus, clii. (1911) pp. 916-19.

‡ C.R. Soc. Biol. Paris, lxx. (1911) pp. 752-3.

even a fifth dilution. These different dilutions are then made into plates. In 48 hours at 22° colonies of yeast will appear, while *Oospora* only becomes evident about the sixth day as minute white points. These colonies grow extremely slowly.

Cultivation Medium for the Influenza Bacillus and Ducrey's Bacillus.*—Elizabeth T. Fraser recommends *Staphylococcus* agar for cultivating the influenza bacillus; this is made by melting a tube of ordinary agar and adding to it $\frac{1}{2}$ –1 c.cm. of a sterilized emulsion of *Staphylococcus* in saline solution. It is immaterial whether the emulsion be sterilized at 60° or 100° C. It is asserted that the organism grew better on this than on blood media; it is also suitable for Ducrey's bacillus.

Culture of *Leishmania tropica* on Solid Media.†—C. Nicolle and L. Manceaux have cultivated *Leishmania tropica* on blood-agar composed according to the formula of Novy and MacNeal. Two precautions are necessary: the surface must not be dry (therefore old tubes are not employed), and the condensation water must be pipetted off before the medium is inoculated. At 20–22° a film appears on the surface 4 or 5 days after inoculation. Much better preparations are obtained by this procedure than by the condensation-water method.

LUCET, A.—De l'influence de l'agitation sur le développement du *Bacillus anthracis* cultivé en milieu liquide. *Comptes Rendus*, cli. (1911) p. 1512.

(2) Preparing Objects.

New Methods of Histological Technique.‡—O. Schultze makes some general remarks on the use of osmic acid as a fixative, and maintains that it is one of the best. He indicates a method for staining with hæmatoxylin after osmic fixation. He makes further remarks on the clearing of large objects, such as frog embryos, in bulk, and recommends for the purpose a mixture containing 80 c.cm. of 1 p.c. chromic acid, 5 c.cm. eau de Javelle, and 10 drops of potash. This fixes, removes the pigment, and clears, so that the internal anatomy can be distinctly seen.

(3) Cutting, including Embedding and Microtomes.

Modification of the Freiburg Method of putting on a Directing-plane (Richtungs-Ebene) for Reconstruction.§—N. C. Rutherford's device consists in the use of lamp-black obtained by burning camphor. This is made into a thin film by means of a mixture of absolute alcohol and collodium, and applied by means of a camel-hair brush. After drying, melted soft paraffin is run over the surface in the usual way, and when this has solidified the squaring of the block is completed.

(4) Staining and Injecting.

Staining of Fats.||—J. Lorrain Smith and W. Mair review their previous work on the methods of staining fats and lipoids. Fats can

* *Lancet* (1911) i. pp. 1573–4.

† *C.R. Soc. Biol. Paris*, lxx. (1911) pp. 712–13.

‡ *Verh. d. Physikal.-Med. Gesell. z. Würzburg*, xl. (1910) pp. 157–68 (pl. xvi.).

§ *Anat. Anzeig.*, xxxix. (1911) pp. 22–4 (1 fig.)

|| *Skand. Archiv Physiolog.*, xxv. (1911) pp. 247–55.

be stained by anilin dyes, such as sudan iii, sharlach R ; by basic anilin dyes which depend for their action on hydrolysis of the fat, but not by acid dyes. Certain lipid substances, however, can be stained with acid fuchsin. These substances must possess basic properties, and the staining is a result of the chemical reaction between the base and the acid Nile blue sulphate A was found to stain fat red, the peculiar result being due to an oxazine base in the dye, which in watery solutions slowly changes into an oxazone, red in colour and soluble in liquid fat. Weigert's and Altmann's methods of mordanting with potassium bichromate are discussed, and an investigation of the bichromate hæmatoxylin method has yielded an interpretation of Marchi's method.

Apparatus for Romanowsky Staining.*—C. Schilling describes a simple apparatus (fig. 67) for facilitating staining. It consists of two

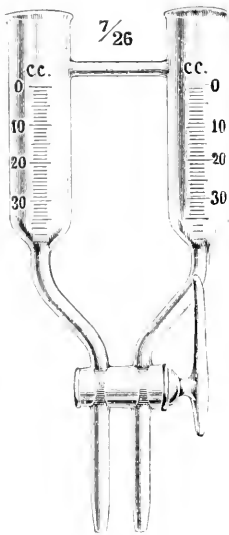

FIG. 67.

graduated tubes of equal bore, joined by a cross-piece. From the bottom of each tube leads a narrower tube to a stop-cock, by which both can be opened simultaneously. A small funnel receives the drop from each tube and conducts the mixed stain to the preparation. One tube contains methylen-blue (med. Höchst) 2 grm., borax 5 grm., water 93 grm., diluted 1 in 50 with water; the other contains eosin B (A. extra Höchst) 0.2 grm. in 1000 grm. of water. The advantage of this method is that the mixing takes place uniformly and the staining is more rapid.

Methods of Staining Tubercle Bacilli.†

S. Rosenblat, after a comparison of the staining methods of Gasis, Ziehl, and Much, has come to the conclusion that the first-named method is of little value. It throws no light upon the minute structure of the tubercle bacillus, nor is it of any practical value in routine diagnostic work. The method is very complicated. Much's modification of Gram's method may elucidate mor-

phological points of importance, particularly in the case of young forms. It is of no use as an aid to the search for tubercle bacilli in sputum or in smears from animal tissues. There are also troublesome complications in this method. For the demonstration of the organisms, the best method is that of Ziehl, which gives a clear and distinct picture. The author considers that the granules shown in preparations according to the method of Much are not developmental forms, but degeneration products in bacilli which have lost their acid-fast membrane. A Ziehl-Gram combination throws some light upon the minute structure of the organism.

* Centralbl. Bakt., 1te Abt. Orig., lviii. (1911) pp. 264-5.

† Centralbl. Bakt., 1e Abt. Orig., lviii. (1911) pp. 173-92.

Improved Method of Iodine Staining.*—F. Tobler finds that by the use of lactic acid better results are obtained with histological botanical preparations stained with iodine. The original method had certain drawbacks, such as the rapidity with which preparations deteriorated, and the tendency of the iodine to crystallize irregularly. The application of lactic acid solutions obviates these troubles to a large extent. Iodine is only slightly soluble in lactic acid. If this latter reagent be allowed to diffuse in from the edge of a coverslip, displacing alcohol, and act upon a fresh iodine preparation, it will determine a crystallization of iodine *in situ*, and so fix the stain. Blue as well as brown staining preparations may be so tested, but greater care is required with the preparations.

Method for Studying Osseous Tissue.†—E. Retterer and A. Lelièvre first make paraffin sections of material previously fixed and decalcified. Two methods of staining are given. In the first the sections are immersed in alum-carmin for 12 to 24 hours, and then in potash-alum-hæmatoxylin; they are then decolorized in dilute picro-hydrochloric acid, and, after washing in running water, are dehydrated and mounted in balsam. In the second method, the sections, with or without previous mordanting in picro-hydrochloric acid, are treated for 24 hours with potash-alum-hæmatoxylin, and then differentiated with the acid solution. After a thorough washing in running water, they are overstained with saturated aqueous solution of picric acid; after a rapid wash in water they are passed through alcohol, then xylol, and mounted in balsam.

By these procedures it is found that the intercellular substance of osseous tissue is composed of morphotic elements and an amorphous mass. From a morphological and structural point of view, the authors compare the fundamental substance of bone to reinforced concrete: the iron framework corresponds to the capsules and to the trabecular system of the bone, the cement or mortar to the amorphous and calcified mass of the osseous tissue.

(5) **Mounting, including Slides, Preservative Fluids, etc.**

Fluid Mounting.‡—C. E. Heath remarks that for fluid mounting there is required a cement sufficiently hard to be adhesive, rigid enough to bear handling, yet elastic, to stand the trifling differences of volume due to temperature variation. Such a cement can be made as follows: a penny tube of cycle-rubber solution, which is rubber in naphtha, is emptied into a four-ounce bottle and double its volume of old gold-size added, shaking till thoroughly mixed. This must now be placed on a water-bath, or anywhere to be heated not beyond 150°, in order to drive off the naphtha and any volatile constituent of the gold-size. Whilst this is being done, prepare a thick solution of shellac in absolute alcohol (not methylated spirit) and add, when the other solution is naphtha-free, twice its volume of shellac solution as thick as treacle. Stir whilst hot and filter through fine muslin before cooling. It can be thinned as desired with absolute alcohol. The reason why methylated spirit cannot be used is that the denaturant which evaporates with the

* Zeitsch. wiss. Mikrosk., xxvii. (1910) pp. 366-8.

† C.R. Soc. Biol. Paris, lxx. (1911) pp. 630-3.

‡ Knowledge, xxxiv. (1911) p. 235.

spirit may evaporate inwards and be condensed in the fluid mountant, and many slides may be spoiled by a milky fog caused by the condensed denaturant, which is not transparent when mixed with water any more than methylated spirit is. The quantity required is not large, so absolute alcohol is not prohibitive.

Use the mountant as thickly as it can be worked to flow, and make a heavy ring on the slide. Of course, it is preferable to do a fair quantity at one time. This sets in about 15 minutes, and dries reasonably hard in a day. This ensures perfect contact of the cement to glass slip. To cement the rings, take a scraping of soap from the piece in use, and spread it on the turntable centre. A ring, flatted on coarse emery cloth if metal, or coarse sandpaper if vulcanite, can be pressed on to the soap and adjusted centrally with sufficient firmness to be cemented all round, leaving a more level ring than can be otherwise obtained. The next day, or later, a thin ring of cement can be put on the slip and the ring adjusted in place. When hardened, there will be perfect contact of cement and glass, with perfect contact of cement and ring, with an elastic layer of cement in between, which is capable of absorbing any small variation under the exercise of pressure. A ring fixed in this manner is likely to remain permanent if the further mounting operations are properly performed.

Direct Enumeration of Bacteria in Water.*—In the bacteriological examination of water samples, Y. Amann counts the number of micro-organisms by direct observation of a known volume of the water with dark-ground illumination. For this procedure are required the ordinary accessories for oblique illumination, and a ruled slide of the type used for the enumeration of blood-cells. The author finds that by this method much higher figures are obtained than with methods of plate cultivation. For example, a sample of water which, when plated, gave growth of 584 organisms, was found, by the method of direct enumeration, to contain 86,000 organisms per cubic centimetre. This method permits of the enumeration of organisms which are incapable of growth upon ordinary media, and of the differential counting of motile and non-motile bacteria.

Method of Preserving Brain Sections.†—R. E. Liesegang describes a simple and inexpensive method of preserving large sections of brain by means of embedding in gelatin. The section is placed carefully in a freshly prepared 5 p.c. solution of gelatin, which is gently warmed in order to prevent it from solidifying too rapidly. A further quantity of gelatin is then poured over the surface of the section, and the preparation is then removed to a cool place and allowed to solidify. Great care must be taken to remove all air-bubbles. The best quality of gelatin, that used for the preparation of photographic emulsions, should be used. Attention must be directed to obtaining an even surface on the embedded section. On no account should the preparation be placed in an incubator to hasten the solidifying process.

* *Centralbl. Bakt.*, 2te Abt., xxix. (1911) pp. 381-4.

† *Zeitschr. wiss. Mikrosk.*, xxvii. (1910) pp. 369-74.

(6) Miscellaneous.

Improved Form of Graduated Pipette.*—C. Permin has devised a form of pipette for bacteriological purposes, which possesses the advantage that its use does not involve those departures from hygienic

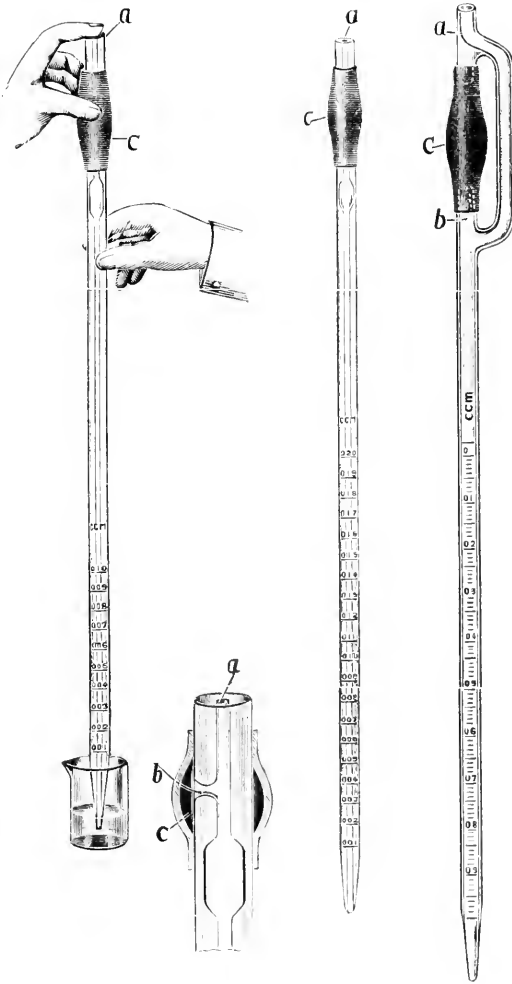

FIG. 68.

principles which are associated with the ordinary pattern. The peculiarities of construction and method of use are clearly illustrated in fig. 68. A side opening near the top end communicates with a chamber, walled with a rubber collar. When the top-end of the pipette is closed

* *Centralbl. Bakt., 1^{te} Abt. Orig., lvii. (1911) pp. 575-6.*

by the finger, pressure upon this collar controls the column of liquid. If it be desired, on the other hand, to alter the size of the cavity within the collar, independently of the column of liquid, the top opening of the pipette is left free.

Method of Examining Fæces for Evidences of Parasitism.*—M. C. Hall, after describing methods of other observers, states that the best results in routine examination of fæces of all kinds are obtained as follows. Briefly, the method consists in breaking up the fæces very thoroughly by shaking in water, adding a quantity of small shot if necessary or desirable; sieving through a set of brass sieves and then through a silk bolting-cloth sieve, or a sieve made with a jeweller's fine-meshed brass screen; examining the material left on sieve for parasites; sedimenting (and washing); centrifuging (and washing)—one tube being filled with calcium chloride solution of 1250 sp. gr., centrifuged and, if desired, the top cubic centimetre removed with a pipette, shaken up in a tube with 14 c.cm. of water and centrifuged—and then making a microscopic examination of a drop of the sediment from the bottom of the tube centrifuged with water, and one from the top when the calcium chloride solution alone was used, or from the bottom in case water was added to the top cubic centimetre. The material is washed at either or both of the points indicated.

R. and J. Beck's Grinding and Polishing Machine for making Microscopical Specimens for Metallurgical Work.†—This machine, the details of which have been worked out in conjunction with some of the leading metallurgists, gives in a compact and convenient form all that is required for preparing metal specimens for examination.

Fig. 69 gives a general view of the machine, which consists of a vertical spindle carrying a grinding or polishing disc driven by a small electric motor. The spindle A is made of steel, and is bored out at the upper end to receive the disc upon which the polishing or grinding material is to be placed. The lower end is hardened to prevent undue wear. This spindle is furnished with a speed cone F with pulleys of varying diameters, and is driven by means of a belt from the driving cone G, which in its turn is driven from the motor. By shifting the belt on the speed cone a range of speeds varying from about 300 to 1,000 revolutions per minute can be obtained. The disc B is made of brass, and fits by means of a tapered fitting into the spindle A, which allows of its easy removal, and at the same time ensures accuracy in the running. A lip E projects downwards and prevents any grinding or polishing material reaching the bearing.

The cloth for polishing, or emery-paper for grinding, is secured to the disc by a simple but very effective device. A groove K is made in the edge of the disc, and the paper or cloth is stretched over the surface of the disc, and is held in position by means of a garter made of a stiff brass spiral spring, which presses the material into the groove. In this way the cloth or paper is held in close contact with the disc, no matter what its thickness may be.

* U. S. Depart. Agric., Bull. No 135 (1911) 36 pp. (figs.).

† R. and J. Beck's Special Catalogue (1911) (2 figs.).

In order to collect the spent polishing materials, the disc is surrounded by a catcher C, which can be easily removed for cleaning. Into the top of the catcher is fitted a guard ring D, which being wide forms a rest for the hand, and by being continued downwards below the surface of the disc and nearly touching the edge, prevents any specimens that are being polished from falling into the catcher should they be let slip from the fingers.

The standard machine is supplied with a switch H and flexible connecting wire, with a plug adapter attached, so that it can be connected

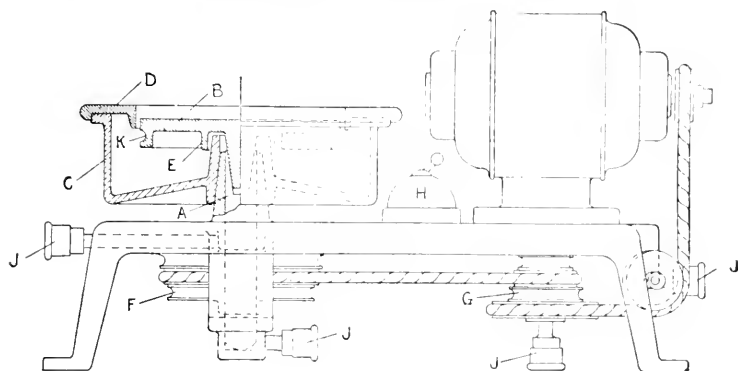

FIG. 69.

with any ordinary electric lamp fitting. The motor can be supplied suitable for any direct current circuit between 100–220 volts, or can be specially made to run on an alternating circuit if desired.

Metallography, etc.

Spontaneous Disintegration of Aluminium.*—H. le Chatelier describes the microstructure of aluminium utensils in different stages of disintegration. The metal in which the change had made progress showed, after etching, a continuous cellular network. At the surface, where the decay had proceeded the furthest, the network had developed into actual spaces, separating the grains, which could easily be detached. The disintegration appeared to be the result of the parting of the grains at their boundaries.

The same author† further discusses the subject. Investigations by Heyn and Bauer have shown that the decay takes place only in severely cold-worked metal. The instability of cold-worked metals appears to be a general phenomenon, and should not be overlooked when additional strength is sought by cold-working. While chemical influences may play a part in the decay of such material, they probably act merely as exciting agencies, setting in operation the latent tendency to disintegrate.

* Comptes Rendus, clii. (1911) pp. 650–2 (4 figs.).

† Rev. Métallurgie, viii. (1911) pp. 373–6 (4 figs.).

Metallographic Notes.*—H. le Chatelier describes the micro-structure of a variety of specimens. Titanium of different degrees of purity, carbide of titanium, carbide of aluminium, cast iron quenched in the experiments on the artificial production of diamond—all these being specimens prepared by Moissan in the electric furnace—were examined. The effect of cold-work in promoting the growth of crystalline grain in mild steel upon subsequent annealing between 600° and 700° C., was clearly shown by a specimen furnished by Charpy. This had been impressed by a Brinell ball, then annealed, and machined level with the bottom of the impression. The polished and etched specimen showed a ring of exceedingly large crystals, corresponding to the region which had undergone the greatest distortion in the test. The structure inside and outside this ring was much less coarse. The author's remarks on the disintegration of aluminium are dealt with in the preceding abstract.

Alloys of Sodium with Silver and Gold.†—C. H. Mathewson has worked out the equilibrium diagrams of the sodium-silver and sodium-gold systems by thermal, microscopical, and chemical methods. Sodium and silver form no compounds, and each is soluble in the other in the solid state only to a minute extent, if at all. Sodium and gold form one compound, Au_2Na . The concentration of any solid solutions is extremely small.

Ternary System, Silver-tin-lead.‡—N. Parravano has investigated this ternary system by determining, by thermal methods, the equilibrium diagrams of a number of sections, parallel to the silver-tin side, of the triangular ternary diagram. Cooling curves were taken of 102 alloys, falling into 13 series, each series containing a constant percentage of lead. Confirmation of the thermal results was obtained microscopically; a 10 p.c. solution of acetic acid in alcohol was used for etching. Four solid phases exist: mixed crystals of silver and tin, mixed crystals of lead and tin, the compound Ag_3Sn , and pure tin. A ternary eutectic melting at 175° C. was found.

Ternary Alloys of Lead, Tin and Antimony.§—R. Loebe has determined the equilibrium diagram of this ternary system by thermal methods, confirming his conclusions by microscopical examination of the alloys. Cooling curves were taken of some 200 alloys, falling into 12 series; each series formed a section across the triangular diagram. In the binary systems, lead-antimony and lead-tin, the components are insoluble in each other in the solid state, while in the tin-antimony system three series of solid solutions occur. The position and form of the four surfaces of primary crystallization of the ternary system were established, but owing to the slow rate of diffusion in the solid state, and also to the segregation caused by differences in specific gravity between some of the phases, the position of the solidus surfaces could not be fixed with certainty. No ternary eutectic point was found, the binary eutectic tin-lead having the lowest melting-point. The ternary

* Rev. Métallurgie, viii. (1911) pp. 367-76 (14 figs.).

† Internat. Zeitschr. Metallographie, i. (1911) pp. 51-63, 81-8 (14 figs.).

‡ Internat. Zeitschr. Metallographie, i. (1911) pp. 89-103 (32 figs.).

§ Metallurgie, viii. (1911) pp. 7-15, 33-49 (79 figs.).

alloys contain the same constituents that occur in the tin-antimony system, with the addition of lead: lead acts merely as a solvent. The microstructure of some of the alloys showed that complete equilibrium had not been obtained in the cooling.

Gold Tellurides.*—G. Pellini and E. Quercigh have determined the equilibrium diagram of the gold-tellurium system by thermal methods. A single maximum in the curve, at 464° C., corresponds with the compound AuTe_3 . This compound occurs in nature as calaverite.

Amalgams containing Silver and Tin.†—R. A. Joyner has investigated the ternary system tin-silver-mercury, studying more especially the peculiarities of the alloys used as dental amalgams. Fresh filings of silver-tin alloys require more mercury for amalgamation than filings which have been kept for some months, or heated to 100° C. This property of "ageing" is shown to be a characteristic of the compound Ag_3Sn ; possibly "ageing" is the result of the polymerization of this compound. The reaction, to which is due the hardening of amalgam prepared by mixing filings of silver-tin alloy with mercury, is the breaking up of Ag_3Sn with the formation of Ag_3Hg_4 and free tin. The ternary equilibrium was studied chiefly by the method of chemical analysis of the liquid phase, separated from the alloy by mechanical means.

Occlusion of Hydrogen by Palladium-gold Alloys.‡—A. J. Berry has determined the amount of hydrogen occluded by a number of palladium-gold alloys. Two similar voltameters containing dilute sulphuric acid were connected together in series. Both anodes and one cathode were of platinum; the other cathode was of the alloy under investigation. The difference between the volumes of hydrogen collected from the two cathodes is the amount occluded by the palladium-gold cathode. Alloys containing less than 25 p.c. palladium do not occlude hydrogen, while the occluding power of alloys containing more than 25 p.c. is a simple function of the concentration of palladium.

Properties of Cast and Rolled Gold Plate.§—H. J. Morris and A. McWilliam have investigated the relative strengths of cast and of swaged dental gold plate. Static bending tests indicated that cast plate had a much lower elastic limit than rolled or soldered plate, and in repeated alternating bending tests the endurance of the cast plate was very low. Some notes on the microstructure and the fractures of the different plates are given.

Flow-pressure of Tin.||—The pressure at which a plastic metal will flow steadily through an aperture appears to be an important physical constant of the metal. E. Jänecke has measured the flow-pressure of tin at different temperatures up to 217° C. The curves showing the relation between temperature and flow-pressure do not indicate by any inflection the temperature at which the allotropic change in tin takes place.

* *Atti R. Accad. Lincei*, xix. (1910) pp. 445-9, through *Journ. Chem. Soc.*, c. (1911) p. 45.

† *Journ. Chem. Soc.*, xcix. (1911) pp. 195-208 (2 figs.).

‡ *Journ. Chem. Soc.*, xcix. (1911) pp. 463-6 (1 fig.).

§ *Proc. Roy. Soc. Medicine (Odontological Section)* iv. (1911) pp. 57-68 (9 figs.).

|| *Metallurgie*, viii. (1911) pp. 68-72 (12 figs.).

Influence of Nitrogen on Cementation of Steel.*—J. Kirner has investigated the efficiency of two nitrogenous case-hardening materials, and a third containing alkali carbonates but very little nitrogen. From 600° to 850° C. cementation proceeded actively with the nitrogenous materials. At 900° C. their action was uncertain, while above 950° C. the rate of cementation again increased. With the nitrogen-free material the rate of cementation steadily rose with the temperature. When the nitrogenous materials were used at temperatures between 600° and 850° C. the nitrogen content of the outer layer of the steel rose to 0.6 p.c., diminishing, however, at higher temperatures. A new constituent, named "Flavite," was detected in the slowly cooled steel of high nitrogen content. Flavite goes into solution above the critical temperature, and is not observed in quenched specimens.

Influence of Manganese on Mild Steel.†—G. Lang has examined eleven mild steels containing 0.3 to 2.5 p.c. manganese, the carbon content being 0.09 to 0.12 p.c. Mechanical tests were made on rod, in three states, as rolled, quenched from 900° C. and slowly cooled from 900° C. Magnetic and electrical tests were also made. Tensile strength and hardness were raised by increase of manganese, and in general the addition of manganese up to 1.5 p.c. appeared to improve the properties of the alloys.

Iron-carbon System.‡—A. Baykoff considers as untenable the view that in the iron-carbon diagram there are two distinct branches, corresponding to the separation of cementite and of graphite from the melt. Cementite and graphite must therefore separate along the same line of the diagram, and from this it follows that cementite is a solid solution and not a compound. Determinations of heat of combustion of pure iron and of cementite, by burning in oxygen in a Berthelot bomb, have confirmed the author's view of the constitution of cementite, since that body is shown to have a negligible heat of formation. An interpretation of the iron-carbon diagram, involving the separation from the melt, at the carbon-rich end, of mixed crystals of iron and carbon, is advanced. The name "moissanite" is given to these mixed crystals, the carbon-content of which may vary through the range 100 to 6.66 p.c. (pure carbon to cementite).

In a footnote, H. le Chatelier points out that Baykoff's conclusion is in disagreement with the experimental results obtained by Moissan, who found graphite and cementite, but no intermediate solid solutions, in high-carbon alloys.

Iron-antimony Alloys.§—A. Portevin has determined the critical points of five alloys containing 1.19 to 9.20 p.c. antimony, with little carbon. The results indicate a tendency of antimony to raise the critical points of iron slightly. For microscopical examination, the alloys were etched with copper-potassium chloride solution acidified with hydrochloric acid. A white constituent first appeared in the alloy containing 6.5 p.c. antimony.

* *Métallurgie*, viii. (1911) pp. 72-7 (15 figs.).

† *Métallurgie*, viii. (1911) pp. 15-21, 49-53 (25 figs.).

‡ *Rev. Métallurgie*, viii. (1911) pp. 315-19 (2 figs.).

§ *Rev. Métallurgie*, viii. (1911) pp. 312-14 (3 figs.).

"Graphitic" Cast-iron.*—O. Kröhnke has studied the peculiar decay of cast-iron pipes resulting in the so called graphitic condition, in which the material is sufficiently soft to be cut with a knife or even to be crumbled in the fingers. Microscopical examination of numerous specimens has indicated that the change involves the dissolving of the ferrite out of the pearlite and the transformation of the graphite into a grey or white substance designated "graphitite." Cementite and the phosphide eutectic are unaffected, and only grey iron is subject to corrosion of this kind, white iron resisting the corrosive agencies.

Malleable Cast-iron.†—F. Giolitti, F. Carnevali and G. Tavanti have heated various samples of white cast-iron, grey cast-iron, and steel in different mixtures of carbon monoxide and carbon dioxide, at temperatures ranging from 800° to 1050° C., to ascertain the effect on carbon content and carbon condition. It was found that carbon was more readily oxidized when existing as cementite than when in the free state, as graphite or temper carbon. The conditions for effective decarburization were determined.

Precipitation of Free Carbon in the Iron-carbon System.‡—W. H. Hatfield has submitted a number of alloys of iron and carbon, containing also different percentages of common impurities, to various heat treatments. The main conclusion reached is that free carbon is only produced by the decomposition of structurally free carbide of iron. When silicon is the only other element present in the alloy, the carbide contains some silicon. Manganese is largely found in the carbide to the exclusion of silicon. Sulphur also appears to cause the exclusion of silicon from the carbide. The tendency of the carbide to decompose is influenced by the presence in it of other elements. The mechanism of the separation of annealing carbon in high-carbon steel is described.

Synthesis of Meteoric Iron.§—C. Benedicks has prepared an artificial plessite (the eutectoid aggregate, kamacite + taenite, of meteoric iron) by cooling an iron-nickel alloy containing 12 p.c. nickel very slowly from the molten state. The results are regarded as confirming the Osmond equilibrium diagram for the iron-nickel system.

Effect of Galvanizing on Strength of Steel Wire.||—H. Winter has made a microscopical study of galvanized wire. The wire was coated electrolytically with copper and embedded in Rose's alloy; transverse sections were polish-etched with rouge and a solution of ammonium nitrate. The injurious effect of pickling, the formation of a brittle layer of zinc-iron alloy, the thermal action of too long immersion or too high temperature in the zinc bath, are causes of the reduction of strength which occurs to a very variable extent upon galvanizing.

Annealing of Steel.¶—W. Campbell has determined the temperature at which, in a rolled steel containing 0.30 p.c. carbon and having a

* Metallurgie, vii. (1910) pp. 674-9 (29 figs.).

† Rass. Min. Met. e Chim., xxxiii. (1910) pp. 1-51, through Journ. Soc. Chem. Ind., xxix. (1910) p. 1456.

‡ Proc. Roy. Soc., Series A, lxxxv. (1911) pp. 1-13 (36 figs.).

§ Rev. Métallurgie, vii. (1910) pp. 1084-6 (4 figs.) and viii. (1911) pp. 85-170 (15 figs.).

|| Rev. Métallurgie, vii. (1910) pp. 1064-74 (15 figs.).

¶ Proc. Amer. Soc. Testing Materials, x. (1910) pp. 193-200 (12 figs.).

coarse structure, the coarse laminae of ferrite disappeared. Small pieces were heated to temperatures ranging from 715° to 900° C., cooled in air, and microscopically examined. Complete refining, involving the disappearance of all ferrite lamination except that caused by re-precipitation on lines of slag or manganese sulphide, took place on the completion of the Ac 2-3 change, at 825°C.

Thermo-electric Forces of Solid Solutions.*—A. L. Bernoulli has made thermo-electric measurements for solutions of thallium and tin in silver, of mercury in cadmium, and of tin, zinc, and nickel in copper. Schenck's law was found to hold for sufficiently dilute solutions, but not so well with higher concentrations. For the copper-zinc alloys the potential differences are much greater than those calculated by Schenck's formula; this is ascribed to the formation of the compound Cu_9Zn_3 .

Defects in Alloys.†—C. H. Desch discusses the character and origin of defects commonly found in non-ferrous alloys. Sponginess is caused by gases, dissolved in the molten alloy, being released during solidification. The solubility of gases in molten metals appears to increase with rising temperature. Brittleness may be due to the presence of oxide or intercrystalline eutectic. It is suggested that the "burning" temperature, in brass, is that at which the zinc has a certain appreciable vapour pressure. Of the numerous other defects described, many may be detected microscopically.

Solid Colloid Systems in Metallography.‡—C. Benedicks develops the view that troostite is a solid colloidal solution of cementite in iron. Troostite, formed by reheating martensite, may by further reheating be coagulated into pearlite. Sorbite is regarded as an intermediate stage in which this coagulation is incomplete. Colloidal solutions probably exist in the iron-nickel, iron-manganese, and other alloys.

A. Lottermoser § compares iron-carbon alloys with gold glasses in their capacity for forming solid colloidal solutions.

Electrical Conductivity of Molten Alloys.—P. Muller describes in detail the apparatus and method he has used for the determination of electrical conductivity of alloys in the liquid state. Numerous results are given for the systems potassium-sodium, lead-tin, potassium-mercury, sodium-mercury, lead-cadmium, lead-antimony, lead-bismuth and lead-zinc. The relation of the electrical conductivity and the temperature coefficient to the constitution of the alloy is discussed.

Equilibrium Diagrams.¶—K. Bornemann enters upon a theoretical discussion of some general properties of binary equilibrium diagrams, these properties being illustrated by the complex transformations occurring in the nickel-sulphur system.

* Ann. Physik., xxxiii. (1910) pp. 690-706, through Journ. Chem. Soc. xvii. (1910) p. 1030.

† Journ. Inst. Metals, iv. (1910) pp. 235-47, 257-64.

‡ Zeitschr. Chem. Ind. Kolloide, vii. (1910) pp. 290-9 (5 figs.).

§ Op. cit., viii. (1911) pp. 95-6.

¶ Metallurgie, vii. (1910) pp. 730-40, 755-71 (35 figs.).

¶ Metallurgie, vii. (1910) pp. 740-7 (13 figs.).

Ternary Systems.*—E. Jänecke discusses the constitution of various types of ternary systems, classifying them according to the constitution of the binary systems of which they may be considered to be composed. As examples of the different types, systems are selected containing three of the following metals: copper, silver, gold, chromium, manganese, iron, cobalt, nickel, palladium, platinum.

Pseudo-binary Alloys.†—If in a metallic binary system the two components A B form a compound C, it is usually assumed that the complete equilibrium-diagram may be regarded as being composed of the diagrams of the systems AC and CB, merely juxtaposed. This involves the assumption that A and B cannot co-exist in equilibrium, one or the other of the two metals being completely combined in the compound C. A. Portevin draws attention to the possibility of a partial dissociation of the compound resulting in the co-existence of A, B, and C. In such a case the system must be regarded as ternary, the components being A, B, and C. The theory of equilibrium of such systems is worked out at some length, on the lines indicated by Roozeboom and Aten. Among the systems to which the theory is applied are aluminium-antimony, iron-molybdenum, and iron-chromium.

Apparatus for Microscopical Examination of Metals.‡—A. Sauveur describes the appliances he has found most satisfactory. Specimens of steel and other magnetic substances may be held on the microscope stage by a magnetic holder. This device is a thin V-shaped permanent magnet, 1 inch wide, 2½ inches long. It is placed on the Microscope stage like a glass slip, the specimen is held magnetically with its polished surface against the lower surface of the holder. Small sections are suspended near the small end of the V-opening, large ones being placed near the wider end. The plain glass illuminator is preferred to the prism type. A simple form of inverted Microscope with horizontal photomicrographic camera is described, though for photomicrography a vertical Microscope and camera are recommended. The stand, objectives, eye-pieces, illuminators, sources of light, condensers, and cameras, are all of well-known types.

Colour-etching of Steel.§—F. Robin and P. Gartner recommend the following method of etching for austenitic and martensitic steels. The polished surface is immersed in a saturated solution of picric acid in alcohol for 30 to 60 seconds, is then washed in water and allowed to dry slowly in air. From the colours observed on a surface etched in this manner much information as to the nature of the austenite or martensite may be obtained. Differences in speed of etching also serve to distinguish different natures of steel. The authors describe in detail the microscopical characteristics of a number of steels of different compositions treated to give austenite or martensite in large quantity.

* *Metallurgie*, vii. (1910) pp. 510-23 (46 figs.).

† *Rev. Métallurgie*, viii. (1911) pp. 7-37 (39 figs.).

‡ *Proc. Amer. Soc. Testing Materials*, x. (1910) pp. 518-50 (32 figs.).

§ *Rev. Métallurgie*, viii. (1911) pp. 224-40 (34 figs.).

Limits of Elasticity, and the Hardening of Metals.*—O. Faust and G. Tammann have submitted test pieces of various metals to tensile or compressive stress. One side of the specimen, previously polished, was observed microscopically during the loading; the stress at which dulling of this surface was noted, corresponding with the beginning of permanent deformation, is termed the lower elastic limit, and has the same value in both tension and compression. By successive compressions with increasing loads, between which the stress was removed and the face re-polished, the elastic limit was raised to a point beyond which no further increase took place; this is the upper elastic limit. The hardening of metals by strain is ascribed to a diminution in the size of the crystals, brought about by the formation of surfaces of slip. No evidence of the existence of an amorphous phase was obtained.

Reheating of Cold-worked Metals.†—L. Guillet has made tensile tests of cold-drawn wires of hard steel, mild steel, and nickel, which had been heated for 3 minutes to 100°, 250°, 300°, 400°, and other temperatures differing by steps of 50° up to 900° C. The results showed that complete annealing took place in each case between 750° and 800° C.

Stresses in Cold-worked Metals.‡—E. Heyn and O. Bauer have devised a method for the measurement of stresses existing in cold-worked metals. A cold-drawn bar of nickel steel (25 p.e. Ni) was found to be stressed in tension in the outer layers, and in compression in the inner portion, the value of the stresses exceeding one-half of the elastic limit. Such stresses disappear upon annealing. An explanation of the manner in which internal stresses come into existence upon cold working is given, and is illustrated with numerous examples. The specific gravity of most metals is diminished by cold work, and restored to its higher value by annealing. The causes of the cracking of cold-worked metals are discussed.

Simplification in Technique of Metallography.§—The preparation of hard or brittle substances for microscopical examination, by the usual methods, is a tedious and difficult process. Le Gris describes a method of embedding minute fragments in gum lac, for polishing, etching, and examination. A hole of suitable diameter (3, 6 or 10 mm.) and equal depth, is bored in a small piece of brass, which is then heated and the hole filled with gum lac. After cooling, the gum lac is filed level with the surface of the brass; the metal fragment is placed on the gum lac and pressed into it with a heated flat metal surface to a depth of rather more than half the thickness of the fragment. When cold, the preparation is polished by the usual methods, but as the surface of the fragment is so small, the operation takes little time. In 2 or 3 minutes an embedded fragment may be ground, polished, and etched. Filings, drillings or powder may be examined in this way. Typical photomicrographs of such preparations are given.

* Zeitschr. Phys. Chem., lxxv. (1910) pp. 108-26.

† Comptes Rendus, cli. (1910) pp. 1127-8.

‡ Internat. Zeitschr. Metallographie, i. (1911) pp. 16-50 (22 figs.).

§ Rev. Métallurgie, viii. (1911) pp. 335-9 (6 figs.).

Composition of Eutectics.*—K. Losew has studied microscopically the alloys of cobalt and antimony, and of nickel and antimony, as examples of systems stated to contain eutectics differing but slightly from one of the pure metals. The uniformity in the composition of such eutectics has been questioned. The results indicate the improbability of the existence of eutectics approximating to pure antimony in the two systems.

Electrical Conductivity of Alloys.†—W. Broniewski reviews the work which has been carried out upon the relation of constitution of alloys to their electrical conductivity and temperature coefficient of electrical resistance, and summarizes the general conclusions established. A comprehensive bibliography (1827–1910) is appended.

Electrical Conductivity of Molten Metals.‡—E. Wagner finds that in many cases the conductivity of a solid metal at the melting-point is a simple multiple of the conductivity of the liquid metal at the same temperature. An explanation based on the electron theory is advanced.

Influence of Pressure on the Melting-points of Metals.§—J. Johnston and L. H. Adams have constructed an apparatus suitable for studying chemical and physical reactions at temperatures up to 400° C. and under pressures up to 2000 atmospheres. Both temperature and pressure in the reaction zone could be accurately measured. The change with pressure of the melting-point of tin, bismuth, lead and cadmium was found to be a linear function of the pressure. The melting-point of tin, cadmium and lead rises with increase of pressure; that of bismuth falls. The difference between melting-point at 1 and 2000 atmospheres is 6·57° C. for tin, 12·61° for cadmium, 16·03° for lead, and 7·15° for bismuth.

BORNEMANN, K.—Binary Metal Alloys.

[Further instalments of the author's summarized account of the binary systems. See this Journal, 1909, p. 787; and 1910.]

Metallurgie, vii. (1910) pp. 572–9, 603–7 (39 figs.).

BURGESS, C. F., & J. ASTON—Some Alloys for Permanent Magnets.

Met. and Chem. Engineering, viii. (1910) pp. 673–6.

CAMPBELL, W., & F. C. ELDER—Notes on Lead-tin-antimony Alloys.

[The compositions of numerous bearing metals and other alloys are given, with some account of the equilibrium diagram of the ternary systems and the structure of the alloys.]

School of Mines Quart., xxxii. (1911) pp. 244–55.

GRARD—Hardness and Brittleness of Steels.

Rev. Métallurgie, viii. (1911) pp. 241–74 (14 figs.).

GÜPEL, F.—Blueing of Steel.

Deutsche Mech. Zeit., 1911, pp. 121–3 (11 figs.).

GUILLET, L., & L. RÉVILLON—New Shock Tests at Variable Temperatures.

Rev. Métallurgie, vii. (1910) pp. 837–44 (1 fig.).

HADFIELD, R. A.—Experiments on Segregation in Steel Ingots.

Tom. cit., pp. 1133–6 (6 figs.).

* J. Russ. Phys. Chem. Soc., xliii. (1911) pp. 375–92, through Journ. Soc. Chem. Ind., xxx. (1911) p. 694.

† *Rev. Métallurgie*, viii. (1911) pp. 320–34.

‡ *Ann. Physik.*, xxxiii. (1910) pp. 1484–92, through Journ. Chem. Soc., c. (1911) p. 177.

§ *Amer. Journ. Sci.*, xxxi. (1911) pp. 501–17 (4 figs.).

- HALL, E. H., & L. L. CAMPBELL—**Electromagnetic and Thermomagnetic Transverse and Longitudinal Effects in Soft Iron.**
Proc. Amer. Acad. Arts and Sci., xlvi. (1911) pp. 625-68 (14 figs.).
- HOWE, H. M.—**Welding of Blow-holes in Steel.**
 [Evidence is given tending to show that, in rolling, the welding of blow-holes may be complete, under favouring conditions.]
Proc. Amer. Soc. Testing Materials, x. (1910) pp. 169-92 (12 figs.).
- HUGHES, T. V.—**Failure in Practice of Non-ferrous Metals and Alloys.**
Journ. Inst. Metals, iii. (1910) pp. 187-203.
- LANTSBERRY, F. C. A. H.—**Some Alloys of Aluminium.**
Foundry Trade Journal, xiii. (1911) pp. 202-6, 262-5 (6 figs.).
- PARRAVANO, N., & E. VIVIANI—**Ternary System Copper-antimony-bismuth.**
 [Continuation and completion of the investigation of this system. (See this Journal, 1911, p. 124.) The complete equilibrium diagram is obtained by uniting the diagrams of Cu₃Sb-Sb-Bi and Cu₃Sb-Cu-Bi.]
Atti. R. Accad. Lincei, xix. (1910) pp. 197-201, 243-7, 343-449.
- PORTEVIN, A.—**Application of the Method of Thermal Analysis to Ternary Alloys.**
 [A theoretical treatment.] *Rev. Metallurgie*, vii. (1910) pp. 1149-57 (9 figs.).
- PORTEVIN, A., & P. GARTNER—**Use of Oblique Illumination in Photomicrography.**
Tom. cit., pp. 921-3 (6 figs.).
- ROSS, A. D.—**Magnetic Alloys formed from Non-magnetic Materials.**
Journ. Inst. Metals, iv. (1910) pp. 68-91 (3 figs.).
- ROSS, A. D., & R. C. GRAY—**Magnetism of Copper-manganese-tin alloys under varying Thermal Treatment.** *Proc. Roy. Soc. Edin.*, xxxi. (1910) pp. 85-99.
- REINBOTH, F.—**Chemical Colouring of Metals.**
English Mechanic, xciii. (1911) pp. 446-8.
- TASSIN, W.—**Copper-clad Steel.**
 [Photomicrographs are given to show the fine structure of steel coated with copper.]
Proc. Amer. Soc. Testing Materials, x. (1910) pp. 280-94 (16 figs.).
- WATERHOUSE, G. B.—**Influence of Titanium on Segregation in Bessemer Rail-steel.**
Tom. cit., pp. 201-11 (8 figs.).
- WICKHORST, M. H.—**Low-carbon Streaks in open-hearth Rails.**
 [Some details of the method of macro-examination employed are given.]
Tom. cit., pp. 212-22 (14 figs.).

PROCEEDINGS OF THE SOCIETY.

MEETING

HELD ON THE 28TH JUNE, 1911, AT 20 HANOVER SQUARE, W.,
H. G. PLIMMER, ESQ., F.R.S., ETC., PRESIDENT, IN THE CHAIR.

The **Minutes** of the Meeting of May 17th were read and confirmed, and were signed by the President.

The following Donations received since the last Meeting were announced, and the thanks of the Society voted to the donors :—

Edward A Birge and Chancey Juday, The Inland Lakes of Wisconsin. The Dissolved Gases of the Water. (8vo, Madison, Wisconsin, 1911)	From <i>The Authors.</i>
The Proceedings of the Optical Convention of 1905. (8vo, London, 1905)	<i>The Secretary of the Committee of the Proposed Optical Convention of 1912.</i>
Diatomaceous material for distribution	<i>Mr. C. F. S. Billbrough</i>

Mr. Conrad Beck gave the following demonstration of the method of determining in wave-lengths the measurement of a stage-micrometer.

Of late years several papers have been read before the Society setting forth the results of a series of extremely careful and laborious measurements of different specimens of stage-micrometers. Such measurements have all been comparative, showing the differences that exist in various ruled micrometers, but have in no case been measurements of the absolute value of the rulings. Where ruled micrometers are found which are uniform, and where a number of micrometers made by entirely different methods agree, there is a probability that such micrometers may be approximately accurate, but it does not follow that such is the case.

Since Professor Michaelson by means of an interferometer measured in wave-lengths the French metre, a great deal of attention had been paid to this method of determining and recording measurements of length, and Major MacMahon and Dr. Tatton are applying a similar method to the measurement of the British standard yard.

A wave-length of light being a very small quantity of about $\frac{1}{500,000}$ in., a number in the neighbourhood of two millions of these small units are contained in the metre, and the determination of the exact number requires very elaborate apparatus and an indirect method of procedure.

A stage-micrometer, however, ruled to $\frac{1}{100,000}$ in. or $\frac{1}{10,000}$ mm. contains a comparatively small number of these units, and being ruled on a transparent glass plate, is peculiarly well adapted for being measured in this way.

By means of an interferometer which my firm has made to the

suggestions of Dr. Clay, the process can be carried out, although the conditions for taking accurate measurements require a more stable support than an ordinary table. The whole apparatus is here shown in use sufficiently rigid to demonstrate the procedure.

It will be realized that if an instrument can be devised in which the motion of some part of it can be made to show some optical change every time it has moved through a distance of one or one-half wave-length, then by counting how many times this optical change takes place as it moves along, the distance that it has travelled is determined. An interferometer is an apparatus which by means of the interference of light causes a change from brightness to darkness to take place every time one of its mirrors is moved along a distance of half a wave-length.

If this mirror be fixed to a carriage which also holds the micrometer to be measured, and the micrometer is so held that it can at the same time be viewed by a high-power Microscope with a cross line in the eye-piece, then the number of optical changes that take place while two consecutive ruled lines pass the cross-line in the Microscope eye-piece may be counted, and the distance apart of these two lines is obtained as a direct measurement in wave-lengths. Apart from other limitations as to the distance within which the interferometer will show the optical change, the number of units to be counted in measuring as great a length as a metre or a yard is so great that it is not a possible achievement, and a step-by-step indirect method of great complexity has to be employed; but for the determination of the small distances represented by the rulings of a micrometer this difficulty does not arise, and a direct count can be made with ease. The apparatus being set up, one observer counts the optical changes, while the other, looking through the Microscope, indicates the time when the lines which are being measured cross the cross-wires in the Microscope.

The interferometer consists of a series of mirrors which receive a beam of light from a radiant source, and divide it into two beams of light, which are afterwards re-combined and viewed by a telescope. All the portions of the instrument are fixed, except one reflecting mirror, which reflects one-half of the divided beam of light. This can be set in such a position that the two half-beams of light, during their period of division and before they re-combine into one, have travelled exactly the same distance. A movement of the reflecting mirror can then be made, so that one half-beam of light has travelled half a wave-length farther than the other; and when that is the case, interference will take place, and the light will be extinguished. As the mirror is moved farther, the light will again appear, until the path is $1\frac{1}{2}$ wave-lengths different, when a second interference is produced; this goes on at each successive motion of the mirror through the same distance, and the wave-lengths are counted (fig. 62, p. 539).

As a matter of practice, it will be seen, on looking through the telescope, that the effect is not a complete change from brightness to darkness, because this only takes place in the exact centre of the field, and a series of bright and dark bands are seen in the field, which travel from right to left, and are counted as they cross the centre of the field against a line in the telescope.

I am here showing the apparatus with a Bunsen burner and a sodium flame as being a sufficiently monochromatic light for demonstration; but

as the sodium light is not a purely monochromatic light, but consists of two lines which are not in themselves quite monochromatic, sodium does not form a very good source for the illumination. Either cadmium, mercury or hydrogen, used in connexion with a prism which shall direct one only of the chief lines into the instrument, is what is best for the purpose.

The micrometer is held on a bracket which projects out from the carriage, on which the moving mirror is fixed in such a manner that, although it is viewed by the Microscope, it is not in contact with it, and no friction is caused which could interfere with its motion.

The President, in inviting comments, informed the Meeting that on the following day, at the Royal Society, a paper would be given on the use of silica as a standard for measurement. That fact would show that the standard of measurement was not yet settled.

Mr. Conrady said he thought the chief interest in comparing standards of length with the wave-length of light lay in comparing standards themselves, the mixed standards, because when it came to small things like stage-micrometers, it was of no use to those who wanted to measure ten-millionths, and he doubted whether any method could determine them. What was wanted was constancy of materials for the standard length, for one part in a million and less. No one would want, for practical purposes, to know nearer than one part in a million; one part in ten thousand was what most people would be interested in. He thought that if, at the present day, one were to send a stage-micrometer to the National Physical Laboratory at Teddington, they would, in a very short time and for a very few shillings, state what was the value of the millimetre, or whatever measurement it might be on that micrometer, to a far greater degree of accuracy than one was likely to want for measuring bacteria or infusoria, because all these forms of life were growing things, and so there was no constancy about them. It was a different matter with standards of length, because very few materials were even fairly constant now, and probably the platino-iridium which was used in the international metres was not quite reliable. He reminded the Meeting that there was no such thing as the French metre now, there was only the international metre, because the Institute at Paris was now the International Bureau of Weights and Measures, and the metre which they issued was internationally accepted by Great Britain, as one of the signatory nations; so that England was bound to the Paris metre, and anything which might be done or said at this Society could not alter the international standard of weights and measures. There was doubt about that constancy, and after very lengthy experiments, the International Commission adopted a 10 p.c. platino-iridium as the most unchangeable material which they could find, and in that material the international metres were made. In the choice of material, quartz was considered, but being a crystalline substance there was some doubt about it. It was important to remember that Michaelson and his successors had adopted another standard, which was fairly above suspicion as regards constancy. It had been pertinently pointed out that the whole solar system was travelling through space at the rate of, he believed, something like 20 miles a second, and was therefore encountering a different supply or area of ether every second, and very sensibly so. Therefore in the course of a few days there must be possibility of

a great change in this respect. It was a moot point whether the ether was of the same density throughout the universe. If not, cadmium would be as little permanent as a standard as would platino-iridium, which was now being used. Therefore the measuring of those standards in wave-lengths only possessed the value of giving us another independent and supposed-to-be constant standard. There was evidence that standards were much the same now as they used to be. With regard to the standard yard, he doubted very much whether the work carried out by the Board of Trade to measure the standard yard was worth the money spent on it, especially on a basis of wave-length. It was already known that the yard was either growing or getting less—he did not remember which—all the time. In the different measurements which had been made it was found to have changed considerably, and no doubt it was changing now, and probably would go on changing for ever, or as long as it escaped another fire like that in the House of Parliament 100 years ago. He did not see what was the real interest of such minute measurements as those just demonstrated. It seemed to him very much like measuring a puppy dog to the $\frac{1}{100}$ in. one day, and finding the next day it had grown.

Mr. Beck, in reply, said it would be interesting to hear what would be said at the Royal Society meeting on the following evening, because he believed that the standard which was to be discussed there was one made of fused quartz. The Board of Trade had tried making various measurements with crystalline quartz, but had found that it was not stable. It was supposed that fused quartz was more likely to be stable than anything else. He was told that even platino-iridium was not above suspicion, and it was hoped that fused quartz would constitute a less variable standard than anything which had hitherto been suggested. What Mr. Conrady said about micrometers was true, provided we knew they were correct, but he thought actual measurement of a certain number was important, so that one might know whether they were anywhere near correct; because when it came to subdividing anything as large as a metre or a yard down to $\frac{1}{100}$ mm., so many errors might creep in that microscopists would be more satisfied if they could be assured that one or two specimens were approximately accurate. If they were found to be accurate, one might well leave the question of accuracy to one part in a million to those who were sufficiently interested to make careful experiments. But he thought it important that some stage-micrometers should be measured on the method which he had set out, which was certainly the most delicate method of measurement known, in order to satisfy ourselves that the measurements were within the ordinary range of accuracy which was required. He believed it was true that the original standard yard was changing very slightly, though one might almost derive the impression from Mr. Conrady's remarks that it was changing at a rapid rate and by a considerable amount. He (Mr. Beck) believed that the change was extraordinarily minute. The standard, which, he believed, was only taken out of its hiding-place once in twenty years, was compared with platino-iridium and other standards from time to time; and he believed the Standards Office had in their possession standards made of different materials, which were periodically compared in order to ascertain what was, at all events, the relative variation in the metals. In discussing the question of the influence of the

ether, one was approaching a subject which was altogether too large for discussion, because it was a problem whether ether existed at all. If it should be discovered that light had nothing to do with ether, but was merely the manifestation of electrical stress, it would alter their views; but he thought there were some measurements of a thousand or two years back, astronomical measurements, which led to the belief that the wave-length was not likely to have changed during that, perhaps, comparatively short period. He thought it was of great importance to be able to get a standard which could easily be reproduced, by physical means instead of by mechanical methods, in case some earthquake should come and destroy the standards, even apart from the question whether the ether might, in the course of a few hundred thousand years, vary in its physical properties. He thought it was now generally recognized that measurements based on wave-lengths were likely to be of great service.

Mr. Conrad Beck exhibited a New Portable Microscope suggested by Mr. Murray. He said that this instrument had been designed to the suggestions of Mr. James Murray, the well-known explorer, who was anxious to have a Microscope extremely small and portable, and which could be used in the field. Being away from the comforts of civilization, in tropical forests, he would be debarred from the luxury of chairs and tables, and the Microscope was therefore so designed that it had one leg, which could be strapped to a walking-stick, which is then driven into the ground, and the observer could sit with the stick projecting from the ground between his legs, and the Microscope could be inclined by means of the usual joint to a convenient position. The instrument was on the model of the Star Microscope, with an aluminium stage, and all the superfluous metal removed everywhere to make it extra light. It had a sliding coarse-adjustment, a micrometer-screw fine-adjustment, and a small substage condenser, with iris-diaphragm. It was provided with two loose legs, which screwed into the single leg-base, making it into a tripod for use on a table in the usual way, when such a support was available on the return from an expedition. For the study of pond-life on the spot this instrument was specially desirable, as the naturalist on the walking-stick-stand principle might spend many profitable hours in pleasant weather in conducting his microscopical examination at the side of the pond, or on the countryside in the open air.

Mr. Murray remarked that as the journey he was about to undertake had to be made without the assistance of carriers, it became important to reduce the weight to the utmost, because every ounce put into instruments to be carried must be deducted from the amount of food which could be carried. Therefore, remembering his previous experience with the Star Microscope on his journeys, he asked Mr. Beck if he could improve upon that instrument in the matter of weight. The present Microscope was the result. It was true that the necessity for unscrewing the legs of the tripod introduced a structural weakness, but the instrument was intended to be primarily used on a walking stick. Its use in the ordinary way, on a table, was a secondary matter. It was not anticipated that one would be able, as Mr. Beck had said, to sit comfortably and work with the Microscope; that was usually impossible in the Amazonian forest. It was

proposed to have the walking-stick sufficiently long to enable the observer to work standing. Quite possibly the conditions would prevent work, but it was hoped sometimes to rig up a net to keep out insects and allow a little work to be done. Mr. Beck did not state what the weight of the Microscope was. Complete in its case, as fitted for use on the table, it weighed two pounds. But even that was far too much to take on such a journey, for, as he had said, only so much could be taken, and the heavier the instruments, the less the quantity of food which could be carried. Therefore, when the difficult journey began, the case of the Microscope would be left behind, the two supplementary legs would be unscrewed, and the Microscope folded up and wrapped in a spare shirt. The weight, without the case, was only one pound.

Mr. Scales exhibited a variable eye-piece, designed by Mr. M. J. Allan, of Geelong, and a slide of diatoms from the same gentleman.

Mr. Beck remarked that, unfortunately, he had not had a very long time in which to examine the eye-piece, as he had been very busy. He had made a casual examination of it. It was, as one would expect, a compromise. It was not a first-class eye-piece in any of its conditions. For instance, its best condition was when both lenses were screwed on and it was closed up. It then had a magnifying power of $12\frac{3}{4}$; it had a slight distortion and fairly good definition at the edge, and moderately good central definition. When one lens was removed and it was drawn out to its fullest extent it was still a moderately good eye-piece, though there was a slight colouring on the fringes at the edge of the field. In that condition it had a magnifying power of about $7\frac{1}{2}$. But in the other cases in which it was used, either with both lenses on and the tube extended, or with one lens on and the tube closed, the marginal definition was extremely bad. There was a considerable colour, and a good deal of pin-cushion distortion. Therefore it was, as one would expect, a compromise between two different powers, between $7\frac{1}{2}$ and 12, with the corrections a good deal marred from the fact that it was a combination. One could not expect the same lenses at different distances to give the same corrections. At any rate that method, although it might be convenient under certain occasional circumstances, did not, he thought, recommend itself, because eye-pieces were very cheap, and he considered that it would be very much more satisfactory to use a couple of really well corrected eye-pieces than one which had not the finest possible corrections in any condition, and was thoroughly bad in some.

Mr. Scales remarked, with regard to the eye-piece which was submitted to him, that while he agreed with what Mr. Beck said as to it being a compromise, and that it was not, and could not by its construction be properly corrected, he was rather surprised, knowing the imperfect construction of the eye-piece, to find that its definition was as good as it turned out to be. He was also surprised to find that there was not more colour, and that the definition, except at the margin of the field, was fairly good. The maker seemed to have committed the error of trying to get a large field, so that marginal imperfections were not cut off. If he had been content with a smaller field, there would have been a more successful instrument; but, considering that he had endeavoured to get three eye-pieces into one, he would have anticipated a worse result.

He quite agreed with Mr. Beck that it was not worth making, because eye-pieces were now so extraordinarily cheap.

A New Microscopical Lamp, designed by Professor Emrys-Roberts, was exhibited by the Secretary, who read the following description prepared by Professor Emrys-Roberts:—This lamp has been designed to combine simplicity with efficiency. Incidentally, by using standard fittings, the cost of production has been reduced to a minimum. The base is brass, heavily weighted, and covered beneath with baize to prevent damage to desk or bench. The upright is brass tubing bent to a convenient curve so as to accommodate the light. At the angle is a universal joint, which can be tightened so as to fix the light in any required position. The parabolic shade or reflector is made of plated metal. The Osram light is frosted below, and so no points of light from the filaments are visible. For general microscopical work it has been found to be both useful and convenient.

Mr. Scales said that the author enclosed an extract from the British Medical Journal of April 15, in which he described it. As far as he (Mr. Scales) could see, it was an ordinary Osram lamp with parabolic reflector. It was compact, and could be switched on to any circuit. There, in his opinion, its virtues ended. Ordinary frosted lamps were in common use in laboratories, but they were unsuitable for decent work; and when he saw this lamp mentioned in the British Medical Journal he felt sorry that it had been put forward as the type of lamp suitable for work of good quality in an ordinary laboratory. The lamp is manufactured by The General Electric Company, Limited.

In regard to the diatom slides which Mr. Allan had sent, that gentleman said he would be very grateful if any members or Fellows would name some of the specimens.

Referring to the two slides of *Aulacodiscus superbus* presented by Mr. Norman Thomas in October 1909, and April 1911,

Mr. Spitta said it was well-known that the *Aulacodiscus* was a genus of great beauty; he said this with all diffidence, as he was not a certified diatomian, but still he was very fond of the subject. The peculiarity about the *Aulacodiscus* was, that a large number of the varieties were so difficult to obtain. Van Heurck mentioned but a few. He believed that the only treatise extant on the subject was one by Mr. Rattray, in the Proceedings of the Society for 1888—the October Proceedings, published in December. He thought that in this work 127 varieties were given; but on looking through the catalogues of those who sold diatoms it would be found that rarely were there more than a dozen mentioned, though in one or two instances as many as fifty might be given. The remaining ones were very rare. Very few specimens of *A. superbus* had been seen since it was originally described by Kitton in 1857. His description did not exactly correspond with the specimens that Mr. Norman Thomas had sent. Many opinions had been advanced as to what was the cause of the rarity of these forms, and one was that those varieties needed a certain environment, and that otherwise they would not grow. A certain element of probability was lent to that view by

the fact that Mr. Hens, in his celebrated excursion to the Congo, when he was passing the shores of Banana, saw a large quantity of a greenish mass, of which he obtained three bottles full, and, to his surprise, it consisted of what bacteriologists would call a pure culture of the *Aulacodiscus africanus*. If only a few were washed away, and if that peculiar tribe required a certain environment, those which were washed away would easily die, and consequently specimens would rarely be met with. But a strong objection to that was contained in the question, was it likely that 100 varieties would each require a separate growing ground? Thus the point was a very difficult one, but perhaps some Fellows present might be able to throw light upon it. The real point for which he rose was to express thanks to Mr. Norman Thomas for presenting to the Society the specimens of the *A. superbus*, which were so very rare, for of course it was of great academic interest to possess them. The reason that the specimens did not correspond to the drawings might be due to the fact that the latter were made as far back as 1857, the objectives in use at that time being very different in defining power to those of the present day.

The thanks of the Society were tendered, by acclamation, to Mr. Beck, Mr. Allan, Professor Emrys-Roberts, and Mr. Norman-Thomas, for their exhibits.

Papers by Mr. James Strachan: (1) "On the Structure of Scales from *Thermobia domestica*," and (2) "A Description of a Model producing an Optical Effect similar to the Cuneate Markings on Insects' Scales," were read by Mr. F. Shillington Scales.

The President remarked that to those who, like himself, knew but little of this kind of work, the worst of such papers was that they tended to destroy one's faith in the Microscope; apparently one could produce any appearance one wished, if only one knew how to do it. No doubt it was really only the little knowledge that was dangerous.

The Paper by Mr. James Murray, "Rotifera of New Zealand and South Africa, collected by the Shackleton Antarctic Expedition," being the concluding paper of the series, was taken as read.

The Meeting concluded with the carrying of thanks to Messrs. Watson and Sons for the loan of Microscopes.

The following Instruments, Objects, etc., were exhibited:—

Mr. Conrad Beck: An Interferometer; a New Portable Microscope, suggested by Mr. James Murray.

Mr. F. Shillington Scales: A New Microscopical Lamp, designed by Prof. E. Emrys Roberts; a Variable Eye-piece designed by Mr.

M. J. Allan: a Slide of Naviculæ, sent by Mr. Allan for identification; a Model, Micro-slides and Lantern-slides, in illustration of Mr. Strachan's papers.

The Society: Two Slides of *Aulacodiscus superbus*.

New Fellows:—The following were elected *Ordinary* Fellows of the Society:—Prof. S. D. Chalmers, Mr. Charles Panzetta Chatwin, and the following was nominated as an *Ordinary* Fellow: W. E. Garforth.

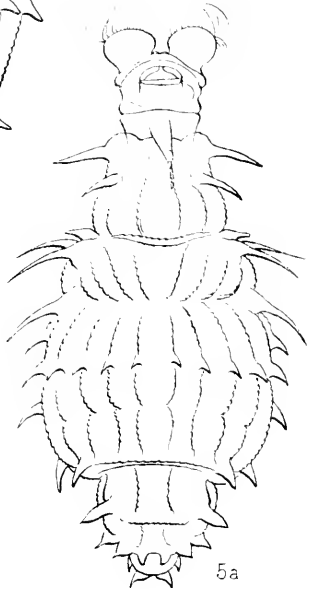
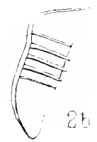
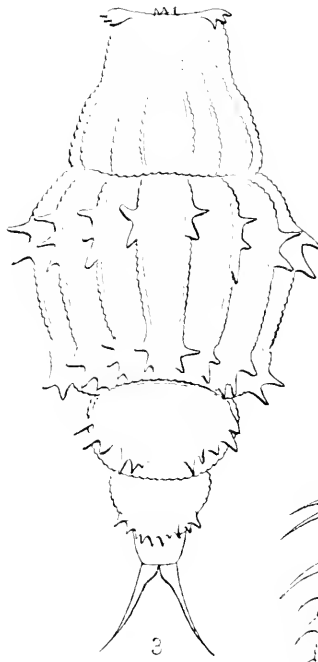

J. Murray del ad nat

West, Newman photo-lith.

ROTIFERA OF NEW ZEALAND AND S. AFRICA.

JOURNAL
OF THE
ROYAL MICROSCOPICAL SOCIETY.

OCTOBER, 1911.

TRANSACTIONS OF THE SOCIETY.

XVII.—*Rotifera of New Zealand: Collected by the Shackleton Antarctic Expedition, 1907-9.*

By JAMES MURRAY, F.R.S.E.

(Read June 28, 1911.)

PLATES XVI., XVII.

As the 'Nimrod' remained in New Zealand for a month on the outward voyage in 1907, and for about the same time on the return from the Antarctic in 1909, there were better opportunities for collecting there than in any other country visited. We did, in fact, examine representative districts in all parts of the islands.

EXPLANATION OF PLATE XVI.

- Fig. 1a.—*Microdina paradoxa* Murray, variety. Head.
,, 1b. Ditto. Foot.
,, 2a.—*Pleuretra brycei* (Weber), variety.
,, 2b. Ditto. Side view.
,, 2c. Ditto. Jaw.
,, 3. —*Dissotrocha pectinata* sp. n.
,, 4a.—*Callidina microcornis* sp. n.
,, 4b. Ditto. Foot.
,, 4c. Ditto. Jaw.
,, 5a.—*Callidina multispinosa* (Thomp.) variety.
,, 5b. Ditto. Jaw.

from Stewart Island in the extreme south to Auckland in the north.

Very little work was done on ponds or other waters, as the main object was the study of moss-faunas. From the extent of the work done, we should be able to form some estimate of the general characters of the moss-fauna of New Zealand, especially of the Bdelloid Rotifera.

Although I was only looking for the Bdelloids among the Rotifera, it seems a pity not to record the species of the other orders casually observed, as many of them were not previously noted for New Zealand. Many Ploima and Rhizota were observed, but I could only venture to name a few.

For descriptions of the unfamiliar genera of Bdelloids mentioned in this paper, Bryce's recent work on A New Classification of the Bdelloid Rotifera, 1910 (2),* should be consulted.

Historical Sketch.—Very little appears to have been done at New Zealand Rotifera before Hilgendorf. The following notes contain all I have been able to find on the subject. Unfortunately Hutton (5), while giving in 1904 a list of forty-two Rotifera (compiled, I understand, by Hilgendorf), gives no bibliography of the sources of the records, so we have not the advantage this would have given in tracing the previous history.

Schmarda, in 1859 (10), notes three species in New Zealand, one of them a Bdelloid, *Philodina megalotrocha*.

Stock, in 1893 (11), records a Rhizotan.

Hilgendorf, in 1898 (3), notes sixteen species, two of them Bdelloids, one a new species, *Callidina quadridens*.

Hilgendorf, in 1903 (4), gives an extended list of four Bdelloids, one of them a new species, *Philodina cloacata*.

Hutton, 1904 (5), gives nine Bdelloids.

Richters, 1908, mentions *Callidina* in various localities in the North Island, but he does not identify any of the species (8).

Hilgendorf mentions another record of a Rhizotan, in Trans. New Zealand Inst., xii. p. 301, which I have not seen.

In these various papers there are recorded ten Bdelloids, nine of which we did not see. They are: *Philodina erythrothalma*, *roscola*, *megalotrocha*, *microps*, *cloacata*; *Callidina bihamata*, *quadridens*, *venusta*; *Rotifer macrourus*.

R. vulgaris is the only previously recorded species which we observed.

* The figures in brackets refer to the Bibliography at the end of paper.

LIST OF SPECIES COLLECTED.

BDELLOIDA.

	North Is.			South Is.			Stewart Is.
	Auckland	Rotorna	Canterbury	Mt. Cook	Wakatipu	W. Coast	
<i>Microdina paradoxa</i> Murray				×	×		
<i>Philodina citrina</i> Ehr.	×			×			
<i>P. flaviceps</i> Bryce	×		×	×	×		
<i>P. nemoralis</i> Bryce					×		
<i>P. brevipes</i> Murray					×		
<i>P. rugosa</i> Bryce					×	×	
<i>P. vorax</i> (Janson)						×	
<i>Pleuretra alpinum</i> (Ehr.)				×			
<i>P. humerosa</i> (Murray)				×			
<i>P. brycei</i> (Weber)	×						
<i>Dissotrocha macrostyla</i> (Ehr.)		×		×			
<i>Callidina habita</i> Bryce				×	×		
<i>C. plicata</i> Bryce	×		×	×			
<i>C. chrenbergii</i> Janson					×	×	
<i>C. quadricornifera</i> (Milne)						×	
<i>C. muscosa</i> (Milne)				×			
<i>C. microcornis</i> sp. n.						×	
<i>C. papillosa</i> (Thomp.)	×			×	×	×	×
<i>C. multispinosa</i> (Thomp.)						×	×
<i>Mniobia magna</i> (Plate)				×			
<i>M. symbiotica</i> (Zel.)				×		×	
<i>M. tetraodon</i> (Ehr.)	×	×	×	×		×	
<i>M. scabrosa</i> Murray				×			
<i>Rotifer vulgaris</i> Schrank				×			
<i>R. curtipes</i> sp. n.				×			
<i>R. longirostris</i> (Janson)	×	×	×	×		×	×
<i>R. montanus</i> sp. n.				×			
<i>Habrotrocha pusilla</i> (Bryce)	×					×	
<i>H. angusticollis</i> (Murray)	×	×			×	×	
<i>H. perforata</i> (Murray)	×					×	
<i>H. leitgebii</i> (Zel.)			×	×	×		
<i>H. lata</i> (Bryce)				×		×	
<i>H. pulchra</i> (Murray)						×	
<i>H. aspera</i> (Bryce)	×					×	
<i>H. constricta</i> (Duj.)					×		×
<i>Scephanotrocha rubra</i> Bryce			×	×			
<i>Adineta vaga</i> (Davis)	×			×		×	
<i>A. gracilis</i> Janson			×	×	×	×	
<i>A. barbata</i> Janson	×				×		
<i>A. tuberculosa</i> Janson				×			
<i>A. longicornis</i> Murray	×			×		×	

NON-BDELLOID ROTIFERA.

	North Is.		South Is.		
	Auckland	Rotorna	Canterbury	Mt. Cook	Wakatipu
<i>Ceistes velatus</i> Gosse				×	
<i>Synchaeta oblonga</i> Ehr.				×	
<i>Polyarthra platyptera</i> Ehr.	×			×	
<i>Triarthra longiseta</i> Ehr.	×				
<i>Notommata aurita</i> Ehr.			×	×	
<i>Lindia torulosa</i> Duj.				×	
<i>Furcularia forficula</i> Ehr.				×	
<i>Elosa worralii</i> Lord				×	
<i>Diurella porcella</i> Gosse			×	×	
<i>Rattulus longiseta</i> Schrank.				×	
<i>Dinocharis inornatus</i> Hilg.		×		×	
<i>Stephanops tenellus</i> Bryce	×				
<i>Diaschiga gibba</i> (Ehr.)	×			×	×
<i>Euchlanis dilatata</i> Ehr.			×		
<i>E. deflexa</i> Gosse			×		
<i>E. oropha</i> Gosse			×	×	
<i>Monostyla lunaris</i> Ehr.				×	
<i>Distyla flexilis</i> Gosse				×	
<i>Metopidia lepadella</i> Ehr.				×	
<i>M. solidus</i> Gosse			×		
<i>M. latusinus</i> Hilgendorf.				×	
<i>M. triptera</i> Gosse				×	
<i>Pterodina reflexa</i> Gosse				×	
<i>Anuraea cochlearis</i> Gosse				×	
<i>A. valga</i> Ehr.			×	×	
<i>Pedalion</i> sp.					×

NOTES ON THE SPECIES.

BDELLOIDA.

Microdina paradoxa Murray. Plate XVI. figs. 1a, 1b.

The new New Zealand form has a very short antenna, scarcely longer than broad, and almost spherical. The spurs are slender, and are separated by a broad interspace.

Philodina citrina Ehr.

The common stout form occurred in Mount Cook district. At the Nihotupo Waterfall, near Auckland, there was a distinct form, smaller than the other, slender, pale yellow, and stippled.

Pleuretra brycei (Weber). Plate XVI. figs. 2a-2c.

Variety.—Spines on anterior margin of trunk small, median furca short. Lateral spines (in front of first dorsal row) one at each side; first dorsal row ten; second, third, and fourth dorsal rows of four spines each. The fourth row is on the rump. Skin papillose, papillæ with central dots. Spurs not seen.

This variety, which is only known in New Zealand, has more transverse dorsal rows of spines than any other variety. It is also peculiar in having four spines in the last row (on the rump). Most forms have only two. Only a Canadian form, and a distinct species (*P. africana*), have four spines on the rump. It is curious that with the great development of the dorsal spines, the lateral spines are reduced in number, and the anterior ones in size.

Callidina microcornis sp. n. Plate XVI.
figs. 4a-4c.

Specific Characters.—Of moderate size, stout; corona less than trunk; rostrum short; antenna $\frac{3}{5}$ of neck width; teeth 2; stomach with wide lumen; foot short, 3-jointed; spurs minute points, with wide convex space.

Length, feeding, 300 μ , width of corona 85 μ , trunk 100 μ , across spurs 24 μ . Sulcus less than disk; collar slightly prominent. Jaw triangular, with thick border.

The very minute spurs are like those of *C. armillata* and *C. lepida*, which also have the wide lumen. It has not the hyaline collar of *armillata*, nor the knobbed anal segment of *lepida*.

Habitat.—West Coast, S. Island; Australia.

■ *Callidina papillosa* (Thomp.).

The New Zealand form is like the smaller Canadian form (figured in another number of this Journal), which is near the type, but has more numerous warts on the trunk.

Callidina multispinosa (Thomp.). Plate XVI.
figs. 5a, 5b.

Variety.—Long-spined; teeth 3 + 2 or 4 + 1; five stout spines on each side of anterior trunk; a dorsal series of spicules across widest part of central trunk; a spicule in the angle of junction of first and second anterior segments of trunk; several lateral spicules on central trunk and on rump.

The only form of the species observed in New Zealand; it is also present in Australia, and is confined to Australasia.

Rotifer vulgaris Schrank.

The common Rotifer seemed to be rare in New Zealand. We found it only in one district (Mount Cook). It was not typical,—the eyes were minute dots, and the antenna was very short.

Rotifer curtipes sp.n. Plate XVII. figs 8a–8c.

Specific Characters.—Of moderate size; trunk strongly stippled with pellucid dots. Extended foot and rump of equal size; first three foot-joints very short, broader than long; spurs short, divergent, obtuse, without interspace. Movements very sluggish.

Length 350 μ , width of corona 60 μ , neck 36 μ , trunk 60 μ , length of rump 55 μ , foot 55 μ , spur 14 μ . Trunk narrow, of nearly uniform thickness, strongly plicate; stippling extending over trunk and foot to spurs; head and neck not dotted. Rostrum short, eyes near the end; antenna 25 to 30 μ , clavate. Disks widely separated; sulcus a flat ∇ ; collar prominent.

Even more tardy in its movements than *R. tardigradus*, it extends itself with the same apparent extreme deliberation which we see in those lizards which are trying to pass themselves off for twigs.

R. curtipes is near enough to *R. vulgaris* to require care in its discrimination. It is distinguished by the dotted skin, very short foot (which has, however, the number of joints usual in the genus), short spurs, and slow movements.

Habitat.—Among bog mosses (*Sphagna* and *Hypnum*), Mount Cook district. Previously known in Scotland, where it was abundant at Fort Augustus, but not described.

Rotifer longirostris (Janson). Plate XVII. figs. 6a–6c.

The type occurred, the variety *jimbriata* Murray, and a short stout variety, with short spurs, which is here figured.

Rotifer montanus sp.n. Plate XVII. figs. 7a–7d.

Specific Characters.—Small, stout; trunk viscous and sordid; rostrum narrow; antenna stout, as long as width of neck; mouth with small rosette; teeth 2 in each jaw; rump, foot, and spurs short; spurs obtuse, divergent, without interspace; no eyes; viviparous; toes 3.

Length about 260 μ , diameter of neck 36 μ , trunk 70 μ , rump 40 μ , length of spur 12 μ . Trunk closely plicate, usually black with adherent matter; foot, head, and neck clear.

The rosette round the mouth is like that of *R. longirostris* and *H. reperi* Milne. The jaw has a thin border, and the teeth are nearly central. The number of segments in the foot was not ascertained.

Though this animal has not been seen to feed, I describe it for the following reasons: it is clearly a Rotifer, being 3-toed and viviparous. The corona rarely has anything distinctive in this genus. The lack of eyes, the rosette, and the sordid trunk show the species to be very near *R. longirostris*. From that it is distinguished by the smaller size, and relatively shorter rostrum, rump, foot, and spurs. The spurs are not 2-jointed (as in *R. tardigradus* and *R. longirostris*).

Habitat.—Nun's Veil, Mount Cook district; elevation 5000 to 6000 ft. (coll. Dr. Mackay). Also in the Australian Alps, about the same elevation; spurs slightly different.

Habrotrocha perforata (Murray).

One of the commonest species in tropical and sub-tropical countries, it has rarely been found in temperate regions, though Heinis recently found it in Switzerland. In New Zealand it only occurred sparingly in the moist bush of the west coast, in both islands.

Habrotrocha lutea (Bryce).

Rarely obtained in this country except among *Sphagnum*, in New Zealand it occurred among tree mosses on the West Coast.

Habrotrocha pulchra (Murray).

With the last, among tree mosses on the west coast. No doubt in that dripping climate the tree mosses are about as constantly moist as *Sphagnum* is in Britain.

Habrotrocha sp. (?). Plate XVII. figs. 10a-10c.

Specific characters.—Of moderate size, reddish, narrow; teeth $5/4$; antenna short; trunk deeply plicate; foot 3-jointed; spurs narrow, acute, divergent, with wide, straight interspace.

Length 350 μ , width of trunk 75 μ , neck 50 μ , length of spur 12 μ , jaw 24 μ . Neck with lateral prominences. Top border of jaw continued beyond lateral border as a sort of incomplete loop. Not seen feeding.

By the number of teeth this might be Hilgendorp's *quadridens*. That species is not seen so described that its genus can be known. It is said to have a long foot, but it is figured short. Our animal has a short foot.

Scaphanotrocha rubra Bryce (2).

I have never seen this species feed. The generic characters cannot be seen unless when it is feeding—nevertheless, it can be distinguished from all known species of *Habrotrocha* by its specific characters, the red stomach, short blunt spurs, and the teeth.

Only found in the South Island, as usual among *Sphagnum*. Known in Britain, North America, and Australia.

Bdelloid egg sp. (?). Plate XVII. fig. 9.

This very large egg was found in the Mount Cook district. It is drawn to the same scale as the adult animals on the same plate. It is knobbed like the egg of *Adineta barbata*. The well-developed jaw proves it to be a Bdelloid, but as neither corona nor foot was seen, the family to which it belongs cannot be ascertained. The 2 teeth in each jaw are very thick, like those of some forms of *C. quadricornifera* and *R. trisectatus*.

RHIZOTA.

Many Rhizota were seen, but they were unfamiliar, and I had no books, so I could not identify them.

Ecistes relatus Gosse was recognized from its resemblance to *Pseudocistes rotifer* Stenroos, but it has differently placed eyes.

PLOIMA.

Polyarthra platyptera and *Triarthra longiseta*. These plankton species were obtained from the water taps in the city of Auckland.

EXPLANATION OF PLATE XVII.

- Fig. 6a.—*Rotifer longirostris* (Janson) variety.
 ,, 6b. Ditto. Jaw.
 ,, 6c. Ditto. Spurs and toes.
 ,, 7a.—*Rotifer montanus* sp. n.
 ,, 7b. Ditto. Head (rostrum and mouth).
 ,, 7c. Ditto. Side view of head.
 ,, 7d. Ditto. Jaw.
 ,, 8a.—*Rotifer curtipes* sp. n.
 ,, 8b. Ditto. Side view of head.
 ,, 8c. Ditto. Head.
 ,, 9. —Bdelloid egg.
 ,, 10a.—*Habrotrocha* sp.
 ,, 10b. Ditto. Side view of foot.
 ,, 10c. Ditto. Jaw.
 ,, 11a.—*Metopidia latusinus* Hilgendorf. Extreme form.
 ,, 11b. Ditto. Form with narrower sinus.

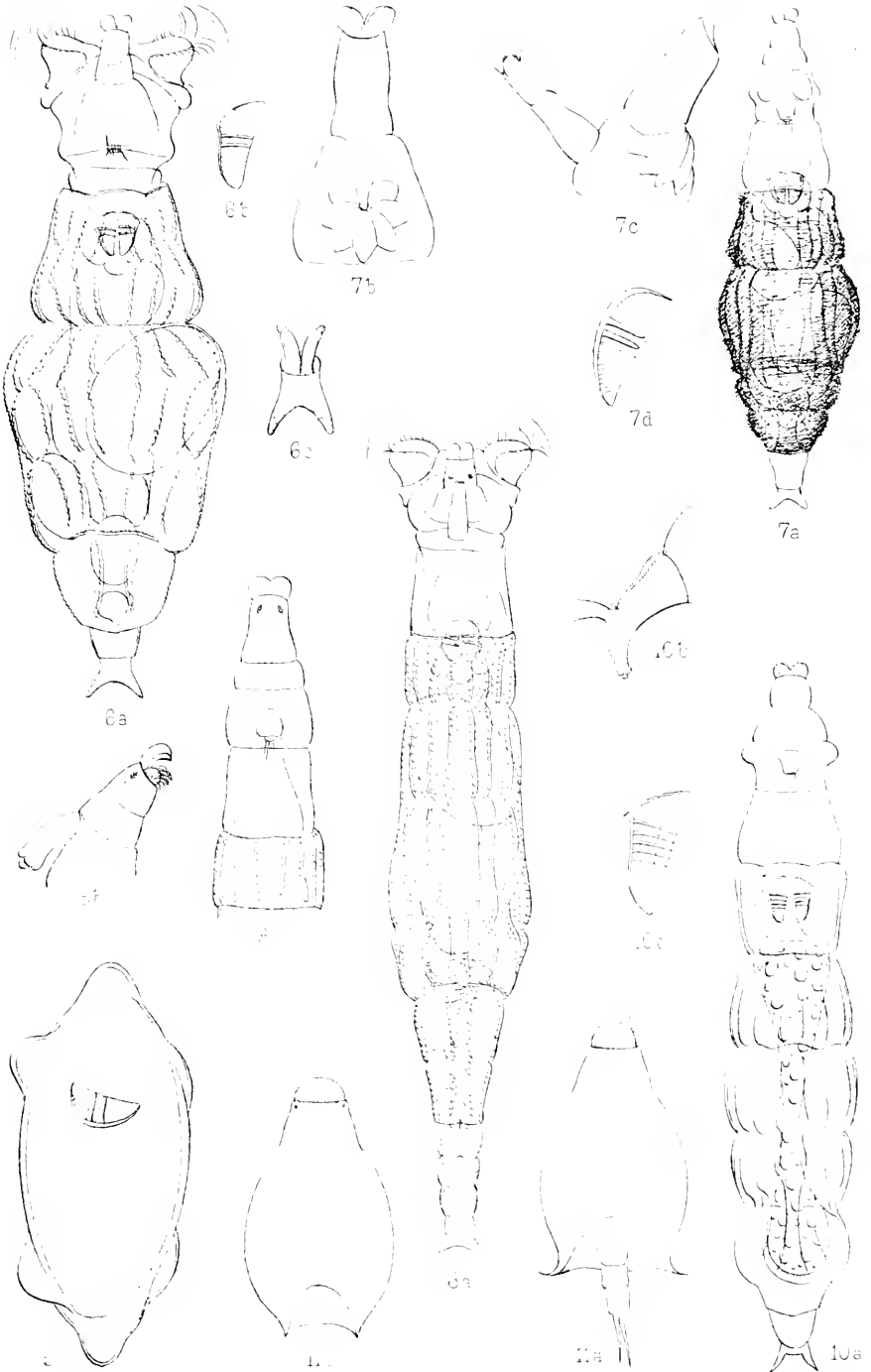

J. Murray del. ad nat.

West Newman photo lith

ROTIFERA OF NEW ZEALAND.

Elosa worrallii Lord (7).

This curious animal, with its bizarre optic arrangements—one eye on the side of its nose, and the other in the back of its neck, so to speak—appears to be rare. I have usually found it among *Sphagnum*, but in New Zealand it was obtained from a pond in the Mount Cook district.

Dinocharis inornatus Hilgendorf (3).

In both islands: ponds at the Hermitage, Mount Cook, and on Mount Wakefield, 6000 feet; pond at Rotorua. Hitherto only known in New Zealand, but we afterwards obtained it in Sydney.

Stephanops tenellus Bryce (1).

This energetic little atom may not be rare, but it is so very small and so very lively, that it is little likely to be recognized for the Rotifer it is. In my experience it has occurred pretty frequently among moss, chiefly from warm countries.

Metopidia latusinus Hilgendorf (3). Plate XVII. figs. 11a, 11b.

Synonym: *M. solidus* var. *latusinus* Hilgendorf.

This interesting species was only obtained in one place, in an ice-cold stream issuing from a glacier in the Mount Cook district. It was abundant on *Myriophyllum*.

I was able to convey some specimens to Mr. Rousset, and it is supported by his authority that I decide to recognize it as of specific rank. There is considerable variation in the width of the sinus, as our two figures show, which no doubt led Mr. Hilgendorf to subordinate it to *M. solidus*.

Pedalion sp.

In the pure cold water of Lake Wakatipu, South Island. *Pedalion* has been so often reported from ponds and shallow waters, that I was rather surprised to find it as a plankton species in a great lake.

Unfortunately I had never seen it before, and did not know the specific differences. My rough sketch does not show the short processes near the posterior end, which distinguish *P. mirum*, nor the cuspidate point of a more recently discovered species, so the probability is that it is *P. fennicum*.

I succeeded in preserving many, but the bottle was one of several which have not arrived home.

SUMMARY OF RESULTS.

Bdelloida: forty-one species were identified, fifteen in the North Island, forty in the South Island, and four in Stewart Island. Three new species are described. The South Island was very much more productive than the others. Only one form, a peculiar variety of *P. brycei*, occurred in the North Island and not in the South. This is the only form of Bdelloid observed by us which is not known elsewhere. Two of the new species here described were afterwards obtained in Australia; one was previously known in Scotland. Two of Hilgendorf's species (*P. cloacata* and *C. quadridens*) are the only species of Bdelloida recorded for New Zealand alone.

There were ten Bdelloids previously known in New Zealand, only one of which (*R. vulgaris*) occurred in our collections, so that forty species are new records for New Zealand, making the list of known Bdelloida up to fifty.

The most noticeable features of the Bdelloid fauna of New Zealand are its close resemblance to that of temperate Europe and the great scarcity of peculiar forms. In such an extensive, remote and varied country these facts are very remarkable.

But for five names, our collection might have been made in Britain; there are only four species not recorded for Europe. And, moreover, there are few rare species among the thirty-six which are common to Britain and New Zealand. These facts strongly support Mr. Rousselet's contention (9) that each species of rotiferon is cosmopolitan, wherever suitable conditions prevail. Jennings earlier (6) stated the same thing in general terms. It might be better to express the fact by saying that the limits of distribution are determined by conditions, since, if climatic conditions exclude some species from great zones of the earth, they cannot be called cosmopolitan.

I believe, however, that the case of New Zealand, so strongly supporting the theory that similar climates have similar Rotifer faunas, is exceptional, and that other factors must be considered. All the continents, so far as they have been examined, show greater peculiarity than New Zealand. Canada, with a climate so like that of Northern Europe, has many Bdelloids not known in Europe. Temperate South Africa, with a climate sufficiently like that of New Zealand, has many peculiar Rotifera.

The apparent poverty of the Rotifer fauna of New Zealand must be regarded along with its resemblance to that of Europe. The poverty in peculiar forms is especially marked. North America and Australia, though only partly worked, have longer lists of Bdelloids, and more peculiar species. Even Britain has many Bdelloids not known elsewhere.

It appears as though insular faunas of Bdelloids were poor compared with those of continental masses of land. Great Britain seems to be an exception to the rule, but that may be because it is not isolated like New Zealand. The poverty of New Zealand may be partly due to the difficulty of migration.

There are thirty-three Bdelloids recorded as common to New Zealand and Australia, but nearly all of these are cosmopolitan species. There is besides a small Australasian element in New Zealand, some three species and one variety occurring in both Australia and New Zealand, and not elsewhere.

There are only some half-dozen other species in New Zealand whose range is so limited that it is worth while indicating it. *Microdina paradoxa* and *Rotifer curtipes* are only known in New Zealand and Europe—*Mniobia scabrosa* is also in Australasia and Africa—*Scaphanotrocha rubra* in Europe, North America, and Australasia. *Hubrotrocha perforata* and *Adineta longicornis* are characteristic of tropical and sub-tropical countries, but the former has been found in Switzerland, and the latter in the Antarctic and Canada.

Rhizotu and Ploima.—General questions of distribution of Rotifera, other than the Bdelloida, will not be discussed, as they were not systematically collected, and the material available is insufficient. Twenty-six forms were recognized, but many others were seen. Seven of these are in Hutton's list (5), so that nineteen appear to be new records for New Zealand.

BIBLIOGRAPHY.

1. BRYCE, D.—Non-marine Fauna of Spitsbergen: Rotifera. Proc. Zool. Soc. Lond. (1897).
2. „ A New Classification of the Bdelloid Rotifera. Journ. Quekett Micr. Club (1910) p. 61.
3. HILGENDORF, F. W.—Rotifera of New Zealand. Trans. New Zeal. Inst., xxxi. (1898) p. 107.
4. „ „ Rotifera of New Zealand a revised and expanded list. Op. cit., xxxv. (1902) p. 267.
5. HUTTON, F. W.—Index Faunæ Novæ Zealandiæ London, 1901.
6. JENNINGS, H. S.—Rotatoria of the United States. U.S. Fish. Comm. Bull. (1900, for 1899).
7. LORD, J. E.—A New Rotifer (*Elosa Worrallii*). Inter. Journ. Micr. and Nat. Sci., ser. 3 i. p. 323.
8. RICHTERS, F.—Moosfauna Australiens, etc. Zool. Jahrb., Abt. f. Syst., xxvi. (1908) p. 196.
9. ROUSSELET, C. F.—On the Geographical Distribution of the Rotifera. Journ. Quekett Micr. Club (1909) p. 465.
10. SCHMARDA, L.—Neue wirbellose Thiere (Leipzig, 1859).
11. STOCK.—A New Zealand variety of *Florescularia coronatta*. Trans. and Proc. New Zeal. Inst., xxv. (1893) p. 193.

XVIII.—*South African Rotifera: Collected by the Shackleton Antarctic Expedition, 1907.*

By JAMES MURRAY, F.R.S.E.

PLATE XVI.

WHILE the 'Nimrod' lay at Cape Town for two days on the outward voyage in 1907, Drs. Mackay and Michell gathered a small quantity of moss on Table Mountain. When this was washed a few days afterwards, eleven species of Bdelloid Rotifers were found.

Eight of them are known species; two are species not yet described, but known to Mr. Bryce; one new species (*Dissotrocha pectinata*) is here described.

Little has been written about the Bdelloida of South Africa. Ehrenberg (2)* records *Callidina rediviva* and *C. hexadon* for Cape Colony; Thorpe (9) found *Philodina citrina* at the Cape; Kirkman (3) gives a list of seven species for Natal, but he is doubtful about several of them. Rousset, in 1907 (7), summed up all that was known about South African Rotifera, including a list compiled by Mr. Milne, and the species collected by himself. In a list of 156 species only thirteen are Bdelloids.

The *R. tardus*, given by Rousset on Kirkman's authority, is doubtless *R. longirostris* (Janson). Adding Ehrenberg's two species, the identity of which is doubtful, and *C. pinnigera*, mentioned by myself in 1908 (5), we have a total of seventeen species recorded for South Africa.

Mr. Milne is known to have observed a great many others, including some very peculiar species, and some of these I have seen among moss which he sent to me, but they are not yet published.

Lastly, in 1911 (6), I compiled from material collected by the curators of the Transvaal Museum a list of forty species, twenty-eight for the Transvaal and nineteen for Cape Colony. Six new species are described. That paper has gone to press earlier than this one, but is likely to appear later, so it cannot be referred to accurately.

Combining all these records, we find that fifty-four Bdelloids are known in South Africa. For all Africa the number is seventy-one, of which, however, several are doubtful.

* The figures in brackets refer to the Bibliography at the end of paper.

Of our nine species, eight are new records for South Africa; only *Adineta vaga* was previously recorded.

With Mr. Rousselet's remarks, in his paper on Geographical Distribution (*S*), on the cosmopolitan character of the Rotifera, I am in the main agreed, although I see some evidence for approximate tropical and temperate zones for Bdelloid Rotifera. These zones, if they were demonstrated, would be determined by climate, so that they would still depend on "suitable conditions" for each species. The cosmopolitan character is doubtless more marked among the aquatic Ploima, with which Mr. Rousselet has chiefly concerned himself, as the conditions in water are very uniform over the earth's surface. We get very nearly the same maximum summer temperature for ponds in the polar regions as in Britain, and in the tropics it is not so very much higher. Water is the great equalizer of temperature. Moss-dwelling animals are directly exposed to the extremes of temperature of different climates; and if some are more susceptible to cold and heat than the others, they may readily become segregated in zones.

In the present paucity of records for many countries the fact is that there are eighteen Bdelloids which are only recorded for Africa, six only for South Africa.

Philodina flaviceps and *Adineta gracilis* are additions to the African fauna.

In view of the suggestion made above that tropical and temperate zones for Bdelloid Rotifers may be distinguished, it is noticeable that our short list contains only temperate species. There is a total absence of those species characteristic of the whole of tropical and sub-tropical Africa. Even in Cape Colony ordinary collections of Bdelloids are characterized by the tropical element. No doubt the absence of these species from our collection is due to the high elevation at which they were gathered. They were not from the summit, but from a considerable elevation, probably between 2000 and 3000 ft.

SPECIES COLLECTED ON TABLE MOUNTAIN.

Philodina rugosa Bryce.

P. flaviceps Bryce.

Dissotrocha pectinata sp.n.

Callidina habita Bryce.

C. plicata Bryce.

Habrotrocha angusticollis (Murray).

H. constricta (Duj.).

Adineta vaga (Davis).

A. gracilis Janson.

Dissotrocha pectinata sp.n. Plate XVI. fig. 3.

Specific characters.—Trunk bearing numerous small spines arranged in comb-like groups. On the central trunk there are two “combs” on each of the dorsal longitudinal ridges—on the anterior margin of the trunk and on the anal and pre-anal segments, the ridges are transversely placed; 2 or 3 teeth in each “comb”; no long single spines.

Closely related to *D. spinosa* (Bryce) (1), it is distinguished by the following characters: *D. spinosa* has several stout single spines on the anterior margin of the trunk, here replaced by “combs” of short spines; it has some pairs of single spines on the central trunk, absent from *pectinata*—it has only small single spicules on the rump, where *pectinata* has transverse rows of “combs.”

In size, general form, spurs, etc., *D. pectinata* resembles the rest of the genus.

Habitat.—Table Mountain, Cape Town. *D. spinosa* is itself rare, and is only known in Britain, where it has been found in England, Scotland, and Ireland. The above comparison had to be made with my Scotch examples (4), as Bryce did not figure the dorsal aspect.

BIBLIOGRAPHY.

1. BRYCE, D.—On the Macrotrachelous Callidinæ. Journ. Quekett Micr. Club (1892) p. 15.
 2. EHRENBERG—Mikrogeologie (Leipzig, 1854).
 3. KIRKMAN, T.—Rotifera of Natal. Journ. R. Micr. Soc. (1901) p. 229.
 4. MURRAY, J.—*Philodina microstyla* and its Allies. Journ. Quekett Micr. Club (1908) p. 207.
 5. “ “ Some African Rotifers. Journ. R. Micr. Soc. (1908) p. 665.
 6. “ “ Bdelloid Rotifera of South Africa. Annals of the Transvaal Museum (1911).
 7. ROUSSELET, C. F.—Rotifera of South Africa. Journ. R. Micr. Soc. (1907) p. 395.
 8. “ “ Geographical Distribution of the Rotifera. Journ. Quekett Micr. Club (1909) p. 465.
 9. THORPE, V. G.—Recorded Localities for Rotifers. Op. cit., 1893, p. 312.
-

GENERAL SUMMARY.

The four short papers which have appeared in this Journal during 1911 deal with all the Rotifera collected by the Shackleton Antarctic Expedition of 1907-1909, except those collected actually in the Antarctic. The report on the Antarctic Rotifera had appeared at an earlier date.

In the four papers 72 species of Bdelloida are enumerated: of which there were 46 in Australia, 42 in Canada, 15 in Fiji, 24 in Hawaii, 41 in New Zealand, and 9 in South Africa.

There are 18 new species described: 7 from Australia, 5 from Canada, 2 from Fiji, 3 from New Zealand, and 1 from South Africa. In addition to these, there is a large series of very distinct varieties of several of the spiny Bdelloids—*Pleurotra brycei*, *Callidina multispinosa*, *C. papillosa*, etc. The series of varieties of *P. brycei* and *C. multispinosa* are of great interest in the study of the distribution and development of the species of Bdelloida.

Adding the Antarctic Bdelloida, in order to complete the account of the Rotifera collected by the Expedition, we have a total of 77 species. In the Antarctic 11 species were obtained, 5 of them new to science.

The Rotifera other than Bdelloids were only casually collected in one or two countries, and present little of interest. In these papers 33 species are noted: 26 for New Zealand and 8 for Australia.

XIX.—*Apparatus for Photomicrography with the Microscope standing in any Position, especially in Inclined Position.*

By DOMINGO DE ORUETA, F.R.M.S.

(Read April 19, 1911.)

It will be agreed that the inclined position is the most comfortable one, and that the advantage of working in this position increases when large Microscopes are used. When, however, working with the inclined Microscope, it is desired to photograph the object under study, the position of the Microscope must be changed to the horizontal or vertical, and sometimes the instrument must be taken to the special table that holds the optic bench, with its illuminating apparatus: once there it must be centred again, and adapted to the photographic camera. All this is inconvenient and takes some time. There is also the greater inconvenience, that the good illumination obtained in direct observation is lost when the position of the Microscope is altered, and all the preliminary operations must be re-undertaken.

The apparatus described in this note has been constructed to avoid these inconveniences, and with the following aims. 1. To enable photomicrographs to be taken with the Microscope in any position, especially in the inclined one, without either moving the instrument or modifying or changing the illumination. 2. To secure that the apparatus shall always be ready for use, yet without incommoding the operator when not needed. 3. That the resulting photomicrographs may be of the most convenient size; that the camera may be lengthened or shortened in order to vary the magnification; and that the image may be focused on the ground glass or transparent screen as easily as it can be done with the ordinary horizontal camera.

The camera when fully extended has an optical length of 0·8 m. (31½ in.), taking plates of 13 by 18 cm., or smaller sizes.

A short explanation of the figures will be sufficient.

The camera (constructed by the firm of Carl Zeiss, of Jena), is mounted on a cylindrical bar B, along which either the front of the focusing screen can be moved at will, and when adjusted, fixed in any desired position by means of screws, the ends of which enter a V-shaped groove running the whole length of the bar (so that both front and back are always vertical).

The bar B slides forwards and backwards in a collar C, and can be fixed in the position desired. This enables the whole camera

to be moved nearer or farther from the Microscope without moving the camera base.

The collar C is supported on a vertical bar, by means of which the bar B and the photographic camera can be raised or lowered together.

The nut T is used to turn the other nut T', and to prevent the height of the apparatus changing when it turns round the column C. Both screws are moved by a key A.

The amplitude of this vertical movement is 75 mm. (3 in.), and serves to adapt the camera to the Microscope, at the inclination given to the latter.

The camera, the bar B, and the nuts T and T' are carried on a

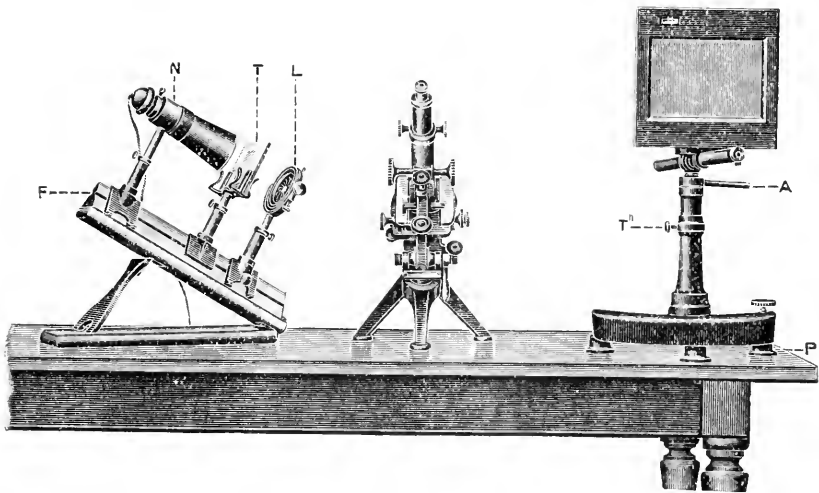

FIG. 70.

vertical column G rising from a cast-iron base M. The base M is provided with two levelling screws S and a pivot S'. The ends of these screws project into a groove made in the base-piece *p*, and they can run inside it moving the column and the camera parallel to the axis of the Microscope. The amplitude of this movement is 37 mm. (1½ in.), and by the combination of this movement and the vertical movement already mentioned, the camera can be rapidly adjusted to differences in the tube-length of the Microscope.

The important feature of the apparatus is a reflection prism P, which fits over or replaces the eye-piece and can be easily changed. This prism reflects the light rays at right angles to the axis of the Microscope, and is provided with a cylindrical cover which enters a tubular collar of similar diameter on the front of the camera, forming a light-tight connexion.

Fig. 70 shows the apparatus in the position corresponding to direct observation with the Microscope in an inclined position. The movements of the camera above detailed allow compensation for any change in inclination.

The camera stands some 15 in. to the right of the Microscope, leaving a space sufficient for the worker to move his hands and manage the Microscope.

When the object has been found and is well illuminated, all that is necessary is to take off the eye-piece and put on the prism eye-piece (or to put the prism over the eye-piece used for the direct observation) and turn the camera through 90° to the position of fig. 71, and adjust the cap of the prism to the collar on the

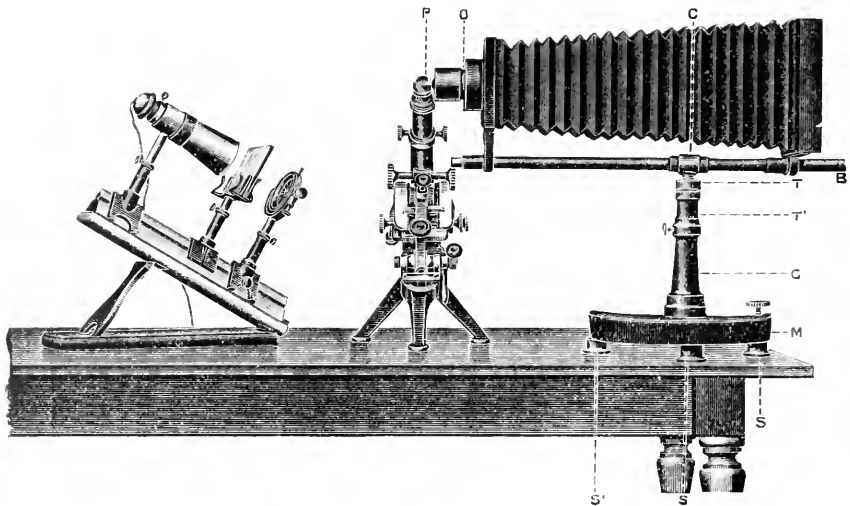

FIG. 71.

camera front. The image is then projected on the ground-glass screen and any necessary alterations in focusing, etc., carried out.

When focusing it will be found that the right hand easily reaches the screw of the Microscope, the maximum length of the camera being 0·8 m.

The shutter O controls the exposure. The same illuminating apparatus is employed for direct observation and for photomicrography. Perhaps the best illuminant for the purpose is the Nernst lamp, modified by Greil (three filaments crossed star-like, instead of one only), because the light is very intense, very steady, and gives a uniformly lighted field. It can be placed either to the left of the operator, as it is shown in these figures, or facing the Microscope.

The illuminating apparatus is mounted on a triangular optical bench F, of 0.5 m. (19½ in.) length, permitting exact centring and focus. This bench stands on a wooden desk, which can be inclined in all positions between the vertical and 50°.

The illuminating system used by the author is composed of a Nernst lamp, N, a support, T, for coloured glasses, or liquid filters of different classes, and a collector, L ("bullseye") with an iris diaphragm. In order to reduce the intensity of the light for direct observation, one or more white ground glasses are put on the support T. These must be removed when the photograph is about to be taken.

With this apparatus photographs can also be taken when the Microscope is in the horizontal or vertical position.

In the former case the camera axis must be placed in continuation of the axis of the Microscope. In the latter, the situation of the bar B must be changed, sliding it directly inside the column C.* The apparatus then becomes the vertical camera, figured in Zeiss's catalogues.

The author has made many photomicrographs with this apparatus, among them several of very difficult diatoms at 1200 diameters (with an apochromatic objective of 1.4 N.A.), and the results have always been very satisfactory. The price of the apparatus is very low compared with the price of the large photomicrography installations.

* It is better, however, to have an additional B bar.

XX.—*A Method of Disintegrating Bacteria and other Organic Cells.*

By J. EDWIN BARNARD, F.R.M.S.

(Read May 17, 1911.)

PLATE XVIII.

THE pathogenic effect of disease-producing micro-organisms is almost entirely due to the poisons or toxins which they secrete. These toxins are of two kinds. A few organisms, of which the diphtheria and tetanus bacilli are examples, form toxins which are excreted into the medium, e.g. broth, in which they are growing, so that by filtration through a porous porcelain filter such as the Pasteur-Chamberland, the organisms can be removed and the toxin is obtained in the filtrate. But the majority of pathogenic micro-organisms do not excrete their toxins, at least to any extent, and the toxins are retained within, or form integral parts of, the cells of the organisms. This is the case with such organisms as typhoid, cholera, plague, glanders, *B. coli*, streptococci, staphylococci, etc., and considerable difficulty has been experienced in obtaining their toxins for immunization, for the preparation of anti-sera, and for other purposes.

If the toxin is thus contained in the protoplasmic contents of the living cell, clearly a method of disintegration in which the cell wall is ruptured and the fluid contents are expressed, might meet the necessity of the case.

Another purpose for which disintegration of the bacterial cells seems eminently desirable, is the investigation of the chemical composition and properties of the bacterial proteins and other cell constituents.

Experiments were initiated by Macfadyen and Rowland some years since for obtaining the protoplasmic contents of the living cell by mechanical means, and the apparatus here described has been evolved partly as the result of those experiments and more recently in connexion with those which have been carried out at the Bacteriological Laboratory, King's College.

The chief conditions to be fulfilled in a machine for efficiently accomplishing the disintegration of micro-organisms are as follows:—

1. The grinding should be effected in a manner which is as far as possible frictionless, so that the risk of rise of temperature and

consequent chemical change is avoided, even apart from any extraneous cooling arrangement.

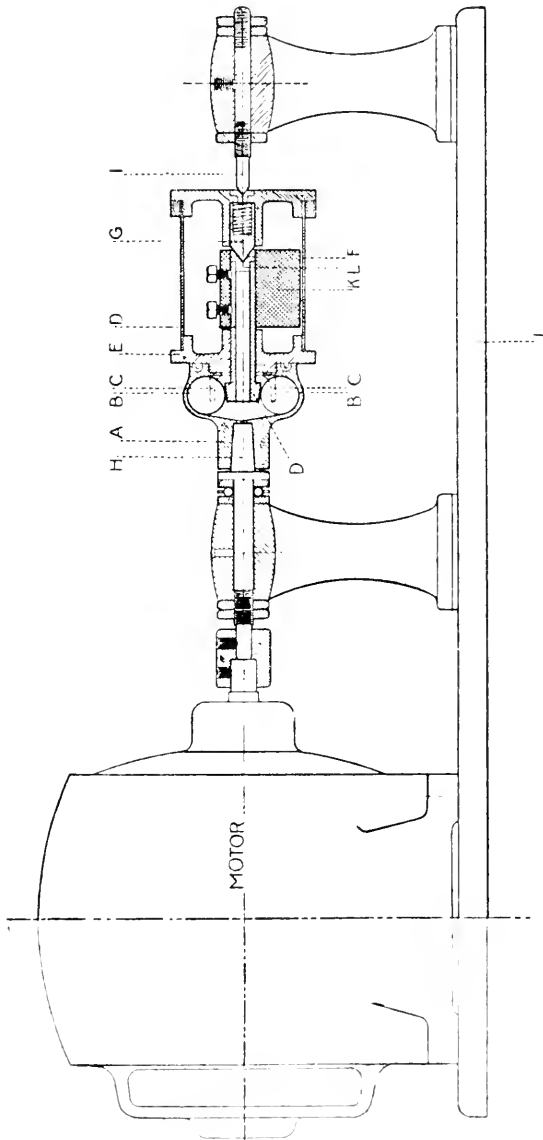

FIG. 72.

2. Every micro-organism or cell should sooner or later be brought under the influence of the grinding action, so that either

no whole cells remain or that their number is reduced to a minimum.

3. The containing vessel in which the grinding action takes place must be so effectually sealed that, during the process of disintegration, no cells have any opportunity of escaping. This applies particularly when pathogenic organisms are being dealt with.

4. The appliance must be such that an efficient cooling arrangement may be adopted, and, if necessary, a temperature of -15° to -20° C. maintained at the actual point at which the grinding action takes place.

5. The action presumably requiring to go on in metallic containing vessels, it should be provided that the actual mechanical disintegration of metal between the grinding surfaces should be as little as possible.

6. No material such as sand or kieselguhr, which were utilized in some of the earlier forms of machine, should be added to the material to be disintegrated, as it is necessary at a later stage to remove these abrasive materials, a process which is not without difficulty. They further have the effect in any case of tending to raise the temperature during the grinding operations.

The apparatus as designed is made in two forms; in one (fig. 72) it is mounted between horizontal centres, and in the other (fig. 73) between vertical centres. In the former the grinding action is controlled by gravity, and in the latter by electromagnetic means.

The appliance consists essentially of a metal pot or vessel A, in which a number of steel balls B are allowed to revolve. The containing vessel may be made of phosphor-bronze, steel, or any similar metal, but phosphor-bronze has been found the most suitable; it is the easier to work in the course of manufacture, and owing to its toughness the surface does not disintegrate rapidly. The steel balls accurately fit the inside of the containing vessel, so that as the machine rotates they are in contact over nearly one half their circumference with the inside of the vessel. A metal cage C is made of such a shape that its prongs lie between the balls, so that the latter cannot collide one with another when the machine is rotating. Mounted at the centre of the metal vessel is a steel cone D, which is of such a size that it keeps the balls in their proper position in close contact with the periphery of the containing vessel. This cone is an important part of the apparatus, as upon it depends the pressure that may be exerted on the balls; and further as the result of its use the balls themselves have freedom to slip if any additional strain is thrown on them or any undue amount of material comes under their action. The containing vessel is closed by a metal cap E, which screws down hermetically sealing the vessel. A groove is made in the top of

the containing vessel into which a lip on this screw-cap loosely fits. Sufficient space remains between the two, as shown in the figure, to allow of some bactericidal agent being placed therein,

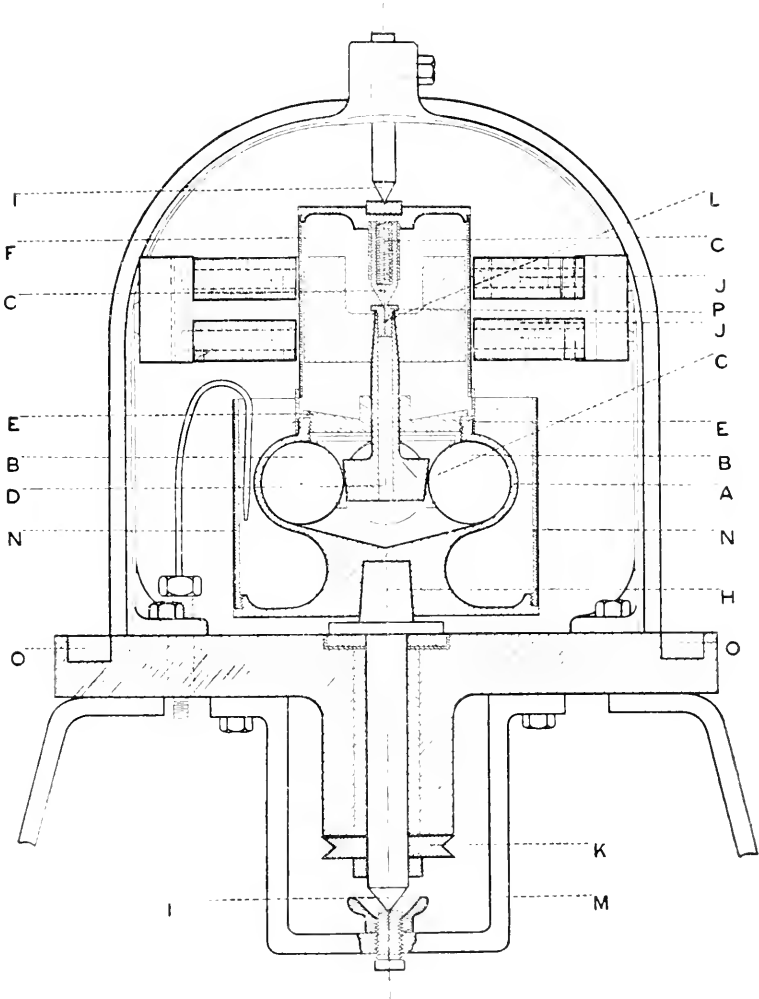

FIG. 73.

thus effectually preventing the escape of whole bacteria or ground material from the containing vessel. Over the whole of this a cylindrical cap F is placed, and in the top of this cap a metal cone G is fitted, which presses by means of a spring on to the top of the

steel cone D. The steel cone is itself hollow, and is closed by a small metal cap L. A lead or steel weight K is fitted on to the steel cone D, and is clamped in any desired position along it. The apparatus is mounted on a cone H, and runs between this cone and the centre I. It may conveniently be connected directly up to a motor, as shown in the illustration, or may be driven by a belt from any suitable source of power by putting a groove pulley on the left hand end of the spindle.

The grinding action takes place between the steel balls contained in the metal vessel and the interior surface of the same. It is evident that if the weight K were not on the central cone as shown, or unless some similar method were adopted to control the cone to prevent it from rotating, no grinding action would result; the central steel cone, in fact, must either remain still or be allowed to rotate at a slower speed than the containing vessel. The metal weight K is of such size that on the whole machine being driven at a suitable speed the action of gravity results in the steel cone remaining still and so a grinding action takes place between the steel balls and the inside surface of the containing vessel.

To ensure that all the bacterial or other cells are as quickly as possible brought under the grinding action of the balls, the speed of rotation should be high. In practice it has been found that from 1000 to 1500 revolutions per minute is a convenient speed, and that centrifugal action is then sufficient to ensure that the whole of the material does actually come between the balls and the metal vessel.

The method of using the machine is briefly as follows: The bacteria after being removed from the culture tubes or plates on which they are grown, are centrifugalized; the semi-fluid mass is then emulsified with saline solution, so that it is of a creamy consistence. This material is then introduced into the container by means of a pipette through the hollow centre of the steel cone. This ensures that no parts of the machine are disturbed more than is absolutely necessary either before or after grinding. The machine is then run for a longer or shorter period depending on the amount of material to be dealt with, and the ground material is then pipetted off through the steel cone. As the balls are themselves free to rotate, the amount of friction is negligible, but any rise of temperature may be prevented by allowing a small stream of carbonic acid gas from a cylinder of liquid carbonic acid to impinge on to the side of the vessel; alternatively an ether spray, such as is used for section-cutting purposes, may be used, and will be found quite efficient.

The vertical type of machine (fig. 73) is exactly similar in all essential details except that the central steel cone is controlled by means of electro-magnets. On the top of the cone a mass of



FIG. 1.

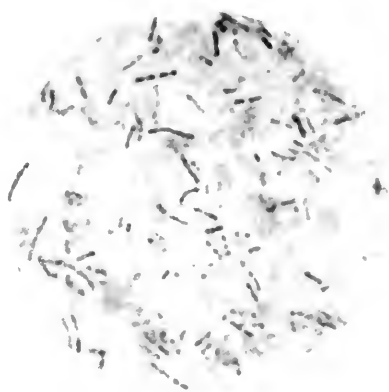

FIG. 2.



FIG. 3.

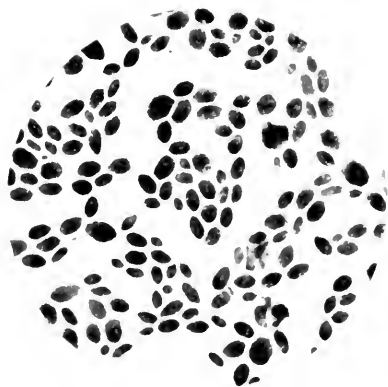

FIG. 4.



FIG. 5.

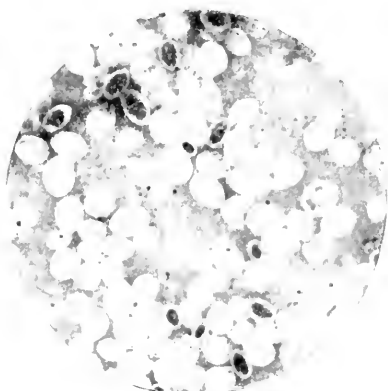

FIG. 6.

soft iron is fixed, and this is kept from rotating by means of the electro-magnets J. The only constructional difference is that the containing cylinder F is made of vulcanite so that it is perfectly diamagnetic. The chief advantage of this design over the one previously described is that it can be completely covered by a glass bell-jar while in action. A bactericidal agent may be placed in the groove O, and the bottom edge of a bell-jar allowed to dip into it.

The actual effect of the process may be seen in the illustrations (Plate XVIII. figs. 1 to 6).

Fig. 1 is a photograph of some bacterial cells before grinding; figs. 2 and 3 being the same cells after grinding for fifteen and thirty minutes respectively.

Fig. 4 is a photograph of unground yeast; figs. 5 and 6 show the result of grinding for fifteen and thirty minutes respectively.

It will be seen in the case of the yeast preparation that after the thirty minutes' grinding the cell contents have been completely expressed. This shows itself clearly, as the cell bodies are unstained, and show up lighter on the stained cell contents, while in the unground yeast the contrary is the case.

XXI.—*The Re-appearance of the Nucleolus in Mitosis.*

By E. J. SHEPPARD.

(Read April 19, 1911.)

PLATE XIX.

SOME time back I had the honour of reading before the Society a paper upon "The Disappearance of the Nucleolus" in Mitosis.

The subject of the present paper is upon its Re-appearance, and it is my desire to bring before your notice some observations I have made with regard to this equally interesting subject.

The processes of staining, fixing, and other treatment of sections and tissues adopted in the study of the above subject have been, with the exception of two slight modifications, the same as mentioned in my previous paper upon "The Disappearance of the Nucleolus."

The two modifications mentioned are as follows:—

First, the abandonment of the use of picric-formol for fixing.

Second, a much longer time occupied in the mordanting and hæmatoxylin staining baths.

The first was adopted because after repeated trials I came to the conclusion that for work upon the subject of mitosis, preferable results are obtained by the use of Flemming's, Lindsay Johnson's, and Hermann's solutions.

With regard to *the second*, that of mordanting and staining, I have prolonged the immersion of sections in these baths for as much as 36 hours in the former and 72 hours in the latter. This seems to me to give the maximum degree of perfection with regard to staining, and the highest resisting power obtainable to the finest nuclear structures for their second iron or differentiation bath.

This applies to such Amphibia as the frog, triton and sala-

EXPLANATION OF PLATE XIX.

- Fig. 1.—Loops in chromatin of daughter-nuclei before disappearance of interzonal fibres. *Hyacinthus*.
 „ 2.—Loops in chromatin of daughter-nuclei. *Hyacinthus*.
 „ 3.—Re-appearing nuclei. Top daughter-nucleus with nucleolus well developed; chromatin not quite severed from nucleolus. Bottom daughter-nucleolus not so fully developed, its lower left portion still fused with chromatin.
 „ 4.—Loops in chromatin (telophase). Triton.
 „ 5.—Loops in chromatin (telophase). Salamander.



FIG. 1.

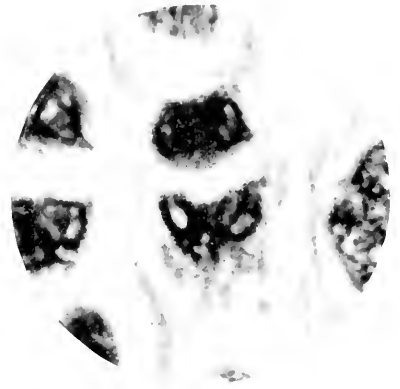

FIG. 2.



FIG. 3.

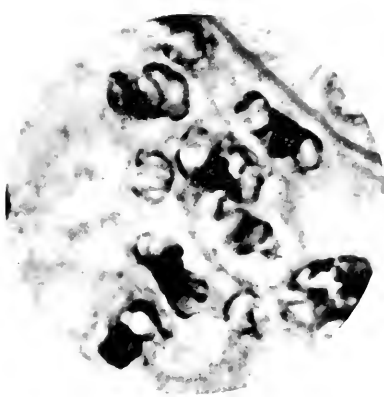

FIG. 4.

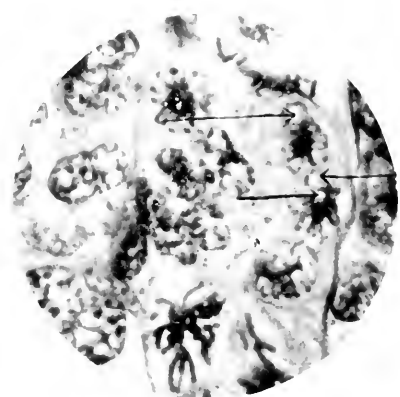

FIG. 5.

mander that I have worked upon. I do not think that sections of plants, rootlets, etc., require nearly such long baths; 12 to 24 hours in my opinion is plenty. These periods of immersion can and should be modified if fixatives other than those mentioned or their like be used.

A point with regard to the differentiation process which should not be forgotten, is that the strength of the iron solution for this purpose should be weak; i.e., whatever be the strength of the mordanting solution used (a 3 p.c. I find about the best), it should be diluted five to ten times its volume with water, according to the rapidity it has for extracting the hæmatoxylin; this can be easily ascertained by working a test section.

The extraction should not be too slow nor too quick: roughly from 15 to 20 minutes should be occupied in differentiating a section or series fixed to the slide. Vegetable sections will take slightly less time than this.

Not too much importance, however, must be put upon timing results in this all-important part of the process, as the only really reliable way is to repeatedly stop the process by washing for about half a minute and very carefully examine under the Microscope with the aid of a $\frac{1}{4}$ -in. lens until you are satisfied the best point has been reached.

All other treatment remains the same, as previously described in my other paper.

Now regarding my observations made with a view to ascertaining how and when the nucleolus makes its re-appearance; the *diaster stage* is the one which calls for most careful study and observation.

The first thing to be noticed is, that soon after the formation of the diaster and the arrival of daughter-chromosomes at or near the poles, the chromosomes begin to link up to form the dispirem.

At or about this time, and before the diasters have lost very much of their characteristic shape, a looping in the chromatin may be observed as shown (Plate XIX. figs. E and B.). The loops may be one or more in number in each half of the diaster, i.e. in each future daughter-nucleus.

It is in these loops that the nucleoli are at some time going to make their appearance.

It does not always follow that these loops are apparent at one and the same time in each half of the diaster, and I am not prepared to say that the number of loops that may be seen is indicative of the number of nucleoli that are going to be present in each daughter-nucleus, for there often appear more loops than there are likely to be nucleoli present.

From the first appearance of the loops the whole area of inclusion is stained, but with varying degrees of density; this may be influenced to some extent by the compactness of the chro-

mosomes. Sometimes when the depth of stain is not too dense to make out any detail, it will be observed that that part lying close to the chromatin shows a slightly deeper shade than that farther towards the centre. The exact manner in which the nucleolus is injected is at present rather uncertain for me to state definitely; and perhaps for a while too much weight should not be put upon the following remarks until more work and observation have been carried out.

At or about the time when the line of division of the cell into two is well marked, and what remains of the interzonal fibres has nearly always disappeared, and in some instances when the daughter-nuclei have made an attempt at regaining a spherical or oval shape, the nucleoli make their appearance in the loops.

It is difficult to say whether this occurs gradually by streaming in, or takes place with a sudden inrush, bursting, or pouring. Personally I give preference to the former mode, and in support of this view a careful observation of fig. D should be made. Here it will be seen that the upper nucleolus is well developed and occupies a good portion of the area of the loop, whilst the lower, from the centre downwards, is wasted off until at its lowest extremity, which is somewhat broadened, appears fused to the chromatin. At the completion of the formation of the nucleolus nothing is left but one, occasionally two or more, very fine drawn-out processes marking its attachment or association to the chromatin. These exist for varying lengths of time, and eventually disappear entirely. During the time they are to be seen they should not be taken for *linin* thread—a mistake which can very easily happen.

For a fuller account of these processes a reference should be made to my previous paper and photographic reproductions.

When the nucleolus has made itself manifest, it is in many instances of a size somewhat proportionate to that of its loop, and again it may be very small.

In the latter case the nucleolus is more often than not very close to or apparently in contact with the chromatin.

The position in the loop at which it may appear is not constant, and may vary in such a manner that I am inclined to think the shape of the loop may have some influence in this respect.

This latter remark is at present only an assumption on my part, and may be purely imaginary.

However, if the loops be round, or nearly so, the nucleolus may start to form at any position. On the other hand, if their outline be at all irregular or distorted, it appears to choose for its developing point one of the irregular situations.

This brings me to the part of my subject in which I wish to put before your notice my views as to what I believe to be the actual manner in which the nucleolus makes its re-appearance or disappearance.

No doubt many of you who are interested in the subject of mitosis, and have read my paper upon "The Disappearance of the Nucleolus," will remember the photographs that I presented to your notice illustrating the fine processes extending from projections of the nucleolus to the chromatin.

These become apparent soon after the loops give up their power of holding the stain so deeply that nothing can be made out.

When this period of densely staining has passed off sufficiently, and the nucleolus is occupying its final position, the processes just mentioned can be distinctly seen, and I am of opinion that it is by these processes that the nucleolus is thrown out from or drawn into the chromatin.

Hence comes, as above mentioned, my reason for giving preference to the method by which the nucleolus may make its re-appearance by a streaming-in process.

Up to this part the above remarks apply particularly to observations made upon vegetable tissues: *Hyacinthus*, *Allium*, *Fritillaria*, etc.

Observations made upon animal tissues, such as frog, triton, salamander, have been somewhat disappointing, and I have only here been able to prove the process of re-appearance identical with that of vegetable tissue up to a certain point: that of the loop formations in the chromatin. These in the above-mentioned Amphibia are especially well formed and beautifully distinct, as reference to figs. A and C will show.

In not a single instance up to the present—and I have examined many hundreds of cells—have I been able to see a nucleolus in a state of developing, or in a fully developed condition.

Further, I have never been able to discover in any one of these loops a trace of anything resembling a nucleolus.

What this fact points to I am unable to say; possibly some marked deviation in the process takes place here from that exhibited in vegetable tissue, and remains to be worked out before anything can be said upon this apparently startling difference.

One curious point, perhaps well worthy of mention, is that I have not yet succeeded in staining the included loop areas in the slightest degree, this alone being a marked difference when contrasted with the results obtained in vegetable tissue.

It might reasonably be asked what is the part played by the nucleolus in mitosis.

To such a question I would reply that in my opinion the nucleolus is an *inciting* or *stimulating* factor to the starting of the process of mitosis.

It will be frequently seen upon examining vegetable sections exhibiting mitosis, that some cells have had their nucleolus wholly pushed out of its socket or position in its nucleus; and if careful

observation is made, in certain instances the exact course the displaced nucleolus has taken can easily be seen by the path it has apparently swept over the protoplasm of the cell.

This feature having been observed by me on repeated occasions, and its occurrence taking place almost without exception at a time when the nucleus is in a resting condition, or only very slightly removed from same, aroused my interest, and consequently I tried to find a reason.

The conclusion I came to after duly considering different possibilities was, that this can only occur for the reason that the nucleolus at the time of the resting-stage of the nucleus must be in a more compact and denser state than it is in later phases of mitosis: hence offering at this time some greater resistance to the impact of the microtome-knife, and is not cut clean through like the other surrounding and apparently softer tissues. This failure to cut through the nucleolus and instead push it out of position, is not, or only rarely, seen in later phases of mitosis; proving that at such time when disappearance, or, as I should prefer to call it, imbibition of the nucleolus is about to take place, the nucleolus is in a far greater state of relaxity for this process; and again its varying shapes and actions towards staining reagents goes towards proving this latter condition.

SUMMARY OF CURRENT RESEARCHES
RELATING TO
ZOOLOGY AND BOTANY
(PRINCIPALLY INVERTEBRATA AND CRYPTOGAMIA),
MICROSCOPY, ETC.*

ZOOLOGY.

VERTEBRATA.

a. Embryology. †

Post-natal Remains of the Notochord in Mammals. ‡—J. Schaffer discusses the view that the gelatinous nucleus pulposus in the intervertebral disc represents the residue of the notochord. He has especially studied the “intervertebral chorda-segments” in mouse, rat, mole, guinea-pig, pig, and man. The chorda-tissue has markedly vesicular cells, and because of the resulting elasticity it retains some mechanical functional importance. In other cases it is of use in forming a mucous mass, penetrated by chorda-reticulum and cell-remains, like a synovia. Many details are given in regard to the remains of the notochord in various Mammalian types.

Maturation of the Mammalian Ovum.—M. Athias describes the maturation-divisions in various rodents (*Mus musculus*, *Cavia porcellus*, *Eliomys quercinus*, and *Microtus incertus*), and bats (*Vesperugo noctula*, *V. serotinus*, and *Rhinolophus hipposideros*), and compares these with what occurs in Insectivores, Carnivores, etc. The main general questions connected with maturation are discussed, e.g. as regards the number of chromosomes, their individuality, the reduction-process, the rôle of the centrosomes, the polar bodies, and so on. The memoir is beautifully illustrated.

Early Development of White Mouse. §—J. Sobotta describes (1) the blastocyst before there is any trace of mesoderm: (2) the first appear-

* The Society are not intended to be denoted by the editorial “we,” and they do not hold themselves responsible for the views of the authors of the papers noted, nor for any claim to novelty or otherwise made by them. The object of this part of the Journal is to present a summary of the papers as *actually published*, and to describe and illustrate Instruments, Apparatus, etc., which are either new or have not been previously described in this country.

† This section includes not only papers relating to Embryology properly so called, but also those dealing with Evolution, Development, Reproduction, and allied subjects.

‡ SB. k. Akad. Wiss. Wien., cxix. (1910), pp. 409-65 (5 pls. and 2 figs.).

§ Sôbre as Divisões de Maturação do Ovulo dos Mamíferos (Lisbon, 1910) pp. 1-192 (4 pls.).

|| Arch. Mikr. Anat., lxxviii. (1911) Festschrift Waldeyer, pp. 271-352 (3 pls.).

ance of the mesoderm and the formation of the amniotic folds; and (3) the process of gastrulation and the origin of the allantois. He discusses in particular the so-called inversion of the germinal layers (or "entypy of the germinal area" by a process of delamination), and maintains its entire distinctness from the belated gastrulation.

Teeth of Two Dentitions in a Dermoid Cyst.*—H. Bluntschli describes a dermoid cyst from the human ovary which was remarkable in showing a number of typical milk-teeth (incisors and canine of the lower jaw), and, along with these a number of teeth (premolars) of the permanent set. The remarkable feature is the simultaneous occurrence of the two kinds of teeth, for normally the permanent premolars do not appear until the milk-incisors have been replaced.

Ovary in Hybrid Birds.†—Heinrich Poll has studied the state of the ovary in crosses between *Anas boschas* var. *dom.* and *Cairina moschata*, *Fuligula fuligula* and *Mareca penelope*, and eighteen other cases. Some female hybrids lay eggs which develop; others are quite incapable of reproduction, though they may sometimes lay eggs.

In all the quite sterile hybrid females there is a constant peculiarity, namely the absence of small reserve follicles in the adult. This is seen in hybrids of *Anas* and *Cairina*, *Lampronessa* and *Metopiana*, *Netta* and *Polionetta*, etc. In other cases even the just mature bird may show no trace of follicular apparatus, as in *Mareca* and *Dafila*, *Fuligula* and *Mareca*. The degeneration may go even farther, as in *M. penelope* and *Lampronessa sponsa*.

There are reserve ova in the female and trimitosis in the spermatogenesis of the male in cases like *Mareca penelope* and *Chaulelasmus streperus*, *Alopocheu ægyptiacus* and *Talorna talorna*, *Streptopelia risoria* and *Turtur turtur*, *Carduelis carduelis* and *Serinus canarius*. Associated with the absence of reserve ova and the further degeneration of the ovary in the sterile hybrid females, there is a corresponding reduction (dimitosis, monomitosis, and apomitosis) in the spermatogenesis of the hybrid males.

Fluctuations in Growth of Fowl's Comb.‡—Geoffrey Smith finds that the correspondence of the comb-increase in hens with periods of egg-laying is invariable, both in young and adult hens. The increase of the comb in the hen is due to a fatty infiltration of the central connective-tissue core of the comb; the decrease in the comb is due to the abstraction of the fat. The cock's comb contains only comparatively small quantities of fat in the central core, the substance of the comb consisting principally of fibrous connective-tissue. The cock's comb does not exhibit marked fluctuations as the hen's does.

The increase in the comb is not accompanied by a rise in general body-weight, though such a rise usually occurs some time before the increase and fat deposition occur. The explanation of the fatty infiltration of the comb is found in the fact that at the egg-laying periods the

* Morphol. Jahrb., xliii. (1911) pp. 345-57 (3 figs.).

† Arch. Mikr. Anat., lxxviii. (1911) Festschrift Waldeyer, 2^{te} Abt., pp. 63-127 (4 pls. and 1 fig.).

‡ Quart. Journ. Micr. Sci., lvii. (1911) pp. 45-51 (4 pls. and 5 figs.).

blood becomes charged with fatty material which is conveyed to the ovary for the formation of yolk, and that the excess of this fatty material is deposited in the comb, and probably in other situations as well.

The author calls attention to the close parallel between the fat metabolism of the laying hen and that in spider-crabs parasitized by *Sacculina*.

Development of Turtle Skull.*—B. W. Kunkel gives an account of the development of the skull in *Emys luteola*. The most general result is to show its far-reaching resemblance with that of *Lacerta*, in spite of the great differences in the adult result.

Sympathetic Nervous System in Turtles.†—A. Kuntz has made a series of observations on the development of the sympathetic nervous system in turtles, in continuation of his investigation into the development of the sympathetic nervous system of Vertebrates. In embryos of turtles the "Anlagen" of the sympathetic trunks arise as cell aggregates lying along the lateral surface of the aorta and along the dorsal surface of the carotid arteries. The cells which give rise to the rudiments of the sympathetic trunks have their origin in (a) the spinal ganglia, or in the neural crest, and (b) in the neural tube. Before the spinal nerves can be traced peripherally, cells advance from the distal ends of the spinal ganglia directly through the mesenchyme into the rudiments of the sympathetic trunks. After the spinal nerves have grown peripherally, cells migrate from the spinal ganglia, and from the ventral part of the neural tube along the paths of the spinal nerves and of the communicating rami into the rudiments of the sympathetic trunks. About the eleventh day of incubation the cell-aggregates begin to break up and become scattered for a considerable time, after which the cell-groups again become aggregated into compact ganglia. About the thirteenth day of incubation cell-strands push out from the spinal nerves proximal to the origin of the communicating rami, and advance towards the aorta. These cell-strands increase in size and advance mesially until, at the close of the sixteenth day, they appear as irregular cellular tracts extending from the spinal nerves into the rudiments of the sympathetic trunks. A comparative study of the development of the sympathetic trunks in embryos of the turtle and of the chick strongly suggests a more or less direct phylogenetic relationship between the sympathetic nervous system in Birds and in the ancestral type of Reptiles. The prevertebral plexuses arise as cell-aggregates lying along the ventro-lateral aspects of the aorta. They are derived from cells which migrate ventrally from the rudiments of the sympathetic trunks. In the sacral region cells may be traced ventrally from the rudiments of the pre-vertebral plexuses into the sentery, where they become aggregated into small cell-groups associated with the rectum. These sympathetic cell-groups probably represent the neprototype of the ganglion of Remak in birds. In the region of the genital ridges cells migrate ventrally from the "Anlagen" of the pre-vertebral plexuses and become aggregated into small cell-groups associated with the rectum. The vagal sympathetic plexuses in the walls of

* Anat. Anzeig., xxxix. (1911) pp. 354-64 (3 figs.).

† Amer. Journ. Anat., ii. (1911) pp. 297-312.

the visceral organs arise from cells which have their origin in the hind-brain and in the vagus ganglia, and migrate peripherally along the paths of the vagi. The phenomena observed in the embryos of turtle give evidence in favour of the observer's view that the peripheral displacement of cells taking part in the development of the sympathetic system is probably determined by the influence of hormones. In turtles as in higher Vertebrates the cells which migrate peripherally from the cerebro-spinal nervous system into the sympathetic "Anlagen" have the same genetic relationships as the cells which give rise to the neurones and to the neuroglia cells in the central nervous system. The sympathetic nervous system is therefore homologous with the other functional divisions of the peripheral nervous system, and the sympathetic neurones are homologous with their afferent and efferent components.

Sympathetic Nervous System in Fishes.*—A. Kuntz has made a study of the development of the sympathetic nervous system in Fishes. His researches are based on the embryos of three widely separated types, *Acanthias vulgaris*, *Amia calva*, and *Opsanus tau*. In all three the "Anlagen" of the sympathetic trunks arise as cell-aggregates at the median side of the spinal nerves. The cells which give rise to these "Anlagen" have their origin (*a*) in the spinal ganglia or the neural crest and (*b*) in the neural tube. These cells migrate peripherally along the paths of the sensory and motor roots of the spinal nerves. This agrees with the writer's findings in regard to the histogenesis of the sympathetic trunks in Mammals and Birds, but not with those of earlier investigators of the development of the nervous system of Fishes, except with those of Froriep. In embryos of *Acanthias* a large proportion of the cells which wander out from the neural crest and from the ventral part of the neural tube migrate peripherally before the spinal nerves have become distinctly fibrous. These cells become scattered in the mesenchyme, where they remain until they become aggregated to form the "Anlagen" of the sympathetic trunks. In embryos of *Amia* and *Opsanus* such precocious peripheral migration of nervous elements does not take place, but the cells which give rise to the rudiments of the sympathetic trunks migrate from the spinal ganglia and from the ventral part of the neural tube along the fibres of the dorsal and the ventral roots of the spinal nerves. This difference in the details in the course of the early development of the sympathetic trunks in these three widely separated types of Fishes is probably correlated with their habits of reproduction. It has probably arisen in response to the external conditions surrounding the embryos during the early stages of their development. The "Anlagen" of the sympathetic trunks gradually advance mesially from the spinal nerves until they lie at the dorsal surfaces of the cardinal veins. In the posterior region of the trunk in embryos of *Amia* and *Opsanus* the sympathetic "Anlagen" advance still farther mesially until they lie along the ventro-lateral aspects of the aorta. In this region the sympathetic ganglia send out cellular processes mesially, until the corresponding ganglia of the right and left sympathetic trunks are connected by bands of sympathetic cells encircling

* Journ. Comp. Neur., xxi. (1911) pp. 177-214.

the aorta ventrally. The sympathetic plexuses in the walls of the digestive tubes arise, not from the cells which migrate ventrally from the sympathetic trunks, as earlier workers supposed, but from cells which have their origin in the hind-brain and in the vagus ganglia. These cells migrate peripherally along the vagi to their new location in the walls of the digestive tube. The observations on Selachian embryos cited by Held are shown to be inconclusive. They are based on embryos in which the rudiments of the sympathetic trunks already appear as distinct cell-aggregates. Embryos of *Acanthias* in this stage of development are too old to reveal the exact sources of the cells giving rise to the sympathetic rudiment. A large proportion of these cells wander out precociously in embryos of *Acanthias*, and remain scattered in the mesenchyme until they become aggregated to form the "Anlagen" of the sympathetic trunks. The peripheral displacement of the cells giving rise to the sympathetic nervous system cannot be accounted for by the mechanical processes involved in growth or by osmotic influences. Evidence is presented to show that the peripheral displacement of sympathetic elements is probably determined by the influence of hormones.

The sympathetic nervous system in Fishes, like that in the higher Vertebrates, is homologous with the other functional divisions of the peripheral nervous system; and the sympathetic neurones are homologous with their afferent and efferent components.

Early Development of Trout.*—Fr. Kopsch finds that the blastomeres of the egg of *Salmo fario* form at the middle of the fifth cleavage a syncytium with one another and with the protoplasm which covers the yolk. From this syncytial union segmentation-cells begin to separate off from the end of the fifth cleavage onwards. This process of segmenting off reaches, for the most part, its end at the close of the eleventh cleavage. The nuclei that have arisen in the syncytium remain almost wholly within it. The boundaries still present between the various territories afterwards disappear entirely, so that the syncytium becomes a plasmodium. This is the time and the mode of origin of the yolk-sac entoblast.

The segmenting off affects particular areas of the syncytium in different ways. Thus there arise a marginal area and an eccentric area (both with nuclei), and an intermediate area of the yolk-sac entoblast, which has at first no nuclei or only a few. The place of the origin of the yolk-sac entoblast is the margin and an eccentric area of the under surface of the blastoderm.

Development of Pectoral Fin in *Amia*.†—Ch. Heronimus finds that the first primordium of the skeleton in the pectoral fin in *Amia* (as also in *Salmo*) is an undivided plate. This stage lasts for a considerable time. In the middle of the skeletal plate in *Amia* about seven clefts appear at the same time. Later on another is added. At first the distal and proximal margins of the plate are not divided. In *Salmo* the clefts do not all appear at once. The elements in *Amia* increase to ten, but there seem to be only nine in the adult. The facts lend no support to the theory that the fin evolved by the transformation of any other organ.

* Arch. Mikr. Anat., lxxviii. (1911) Festschr. Waldeyer, 2te Abt., pp. 618-59 (16 figs.).

† Anat. Anzeig., xxxix. (1911) pp. 193-203 (8 figs.).

Spermatogenesis of *Lepidosiren*.*—W. E. Agar went to the swamps of the Paraguayan Chaco to obtain material for studying the spermatogenesis of *Lepidosiren paradoxa*—a form in which the nuclei attain a very large size and the chromosomes are beautifully clear. He has paid particular attention to the processes of reduction. The somatic number of chromosomes is thirty-eight, one pair conspicuously larger than the rest. In the spermatogonial and also in the somatic nuclei the chromosomes are arranged in a definite plan, the smaller and larger ones being grouped together. Within the main group there is also evidence of a tendency for chromosomes of equal size to be next each other.

The reduced number of chromosomes in the bouquet stage appears to be arrived at by a parallel conjugation in the early prophase according to Von Winiwarter's scheme. The first maturation division separates entire "homologous" chromosomes. There is no resting stage between the two divisions. In the second division the chromosomes divide longitudinally, forming "tetrads," etc., very like those of the first metaphase. We cannot, however, do more than direct attention to this important, but necessarily very technical paper.

Nature of Seminal Fluid in Man.†—G. Broesike finds that there is first of all, in erection, a secretion into the urethra of the products of Cowper's glands, and perhaps of urethral glands. There are, then, three acts in ejaculation—first of the prostate secretion, then of the sperm-containing testicular secretion, and, lastly, the seminal vesicle secretion.

The mucous, slightly alkaline secretion of Cowper's glands serves mainly to lubricate the mucous membrane of the urethra, facilitating ejaculation. To a slight extent it may neutralize the acidity of the urethral mucous membrane.

The alkaline proteid secretion of the prostate serves to protect the spermatozoa from acidity in the urethra and in the vagina. It is not essential to successful insemination, but it promotes, as Fürbringer and Walker have shown, the mobility and vitality of the spermatozoa.

The seminal fluid with actively mobile spermatozoa comes from the epididymis and vas deferens, and perhaps from the mediastinum testis, but not from the testis as such. The spermatozoa do not attain full mobility till 24–48 hours after they leave the testis. They probably retain their maximum mobility for four or five days, but this is uncertain.

The seminal vesicles are not receptacula seminis, though they sometimes contain ripe spermatozoa. Their importance is glandular. They produce an alkaline gelatinous secretion, which mechanically helps to force out the spermatozoa, and in some cases helps to retain the spermatozoa in the vagina. They should be called, as Kölliker suggested, glandulae vesiculares.

b. Histology.

Minute Structure of Femoral Bones.‡—J. S. Foot has made a comparative histological study of the femur in the frog, the alligator, the snapping turtle, numerous birds, and numerous mammals. He

* Quart. Journ. Micr. Sci., lvii. (1911) pp. 1–44 (4 pls. and 1 fig.).

† Arch. Mikr. Anat., lxxviii. (1911) Festschrift Waldeyer, 2te Abt., pp. 128–50.

‡ Trans. Amer. Micr. Soc., xxx. (1911) pp. 87–140 (9 pls.).

distinguishes three main types of bone structure—the lamellar, laminar, and Haversian system types, which may occur pure or mixed. The frog shows only lamellæ; the reptile shows laminae, formed by the grouping and separating of the lamellæ by canals; the highest grade—the Haversian system—appears in outline in reptiles, but in its complete form in birds and mammals. Many birds and mammals have femurs predominately lamellar or predominately laminar, or mixed lamellar and laminar. Many mammals show a complete mixed type, lamellar, laminar, and Haversian. The author thinks that the structure in any type is partly specific and partly due to the functional requirements of the bone.

Red Blood Corpuscles of Mammals.*—E. Retterer and Aug. Lelièvre find that the young stages are spherical or hemispherical, but are deformed with extreme readiness. In the circulating blood the corpuscles lose their spherical and hemispherical shapes, and become bell-like or lens-like. The spherical and hemispherical stages may be compared to the moon in its first quarter on a clear night: the hæmoglobin-containing portion is like the luminous crescent, but there is another portion without hæmoglobin occupying the concavity of the crescent. What happens is that the portion without hæmoglobin is lost as the corpuscles become older.

Epithelial Cells of Mammalian Kidney.†—K. W. Zimmermann describes the different kinds of elements—those at the beginning of the “main portion” of the tubuli, with well-developed lateral ridges which fit into indentations of adjacent cells; those in the pars radiata, which resemble truncated pyramids and have smooth sides; the branched flat cells of the isthmus; and so on.

Tendons of Wing and Leg in Bats.‡—E. Retterer and Aug. Lelièvre have previously shown that in the muscles of the hind legs of bats the framework of the muscle-fibre is much more developed than the contractile myosarc, while in the muscles of the wings the myosarc is abundant and remains fluid.

They have gone on to study the differences in the tendons, using embryos and adults of *Vesperugo pipistrellus* and *Miniopterus schreibersii*. In the flexor muscles and tendons of the hind limbs there is no hint of reduction—they are in fact better developed than in the wing; this shows that the winter-suspension implies energetic muscular contraction. The tendons of the toes and of the thumb, and their fibrous sheaths, are hypertrophied, and are transformed, partially at least, into vesiculo-fibrous tissue. The tendons of the flexors of the wing are, as usual, fibrous cords.

Cytoplasm, Chondriosomes, and Chromidia.§—Julius Schaxel has studied in young ova of various Echinoderms the structure of the cytoplasm, which appears so different with different modes of treatment.

* C.R. Soc. Biol., lxxi. (1911) pp. 150-3.

† Arch. Mikr. Anat., lxxviii. (1911) Festschrift Waldeyer, pp. 199-231 (3 pls. and 1 fig.).

‡ C.R. Soc. Biol., lxxi. (1911) pp. 67-70.

§ Anat. Anzeig., xxxix. (1911) pp. 337-53 (16 figs.).

It is not something hard and fast, but depends on the presence of two physically different substances in the cytoplasm.

Chondriosomes are present in all conditions of the cell, and they share in differentiating the derivatives of the cytoplasm. They are to be regarded as a characteristic component of the cytoplasm, and probably of a fatty nature. They are not to be identified with extra-nuclear chromatin nor regarded as structural elements of the cell. They are effective substances which share in differentiation when the chromatin induces formative processes.

Path of Hypophysis-secretion.*—L. Edinger has shown that the secretion of the hypophysis passes from the gland-cells into pericellular spaces, and thence by perivascular lymph-channels into the mass of the brain. This explains why compression of the stalk has the same effect as removing the whole organ. It may be that the secretion operates especially through the sympathetic system, whose cerebral beginnings lie near the region where the hypophysis enters the brain.

Conjunctival Epithelium in Man.—Hans Virchow has made a thorough histological study of the conjunctival epithelium in man, distinguishing for instance the varying proportions of mucus-cells and epithelial-cells. He describes no fewer than eleven figures of different areas, all showing something distinctive in the structure of the conjunctiva.

Nuclear Budding in Corneous Epithelium.‡—Christian Ditlevsen describes a peculiar process of nuclear budding which occurs in the stratified corneous epithelium of the œsophagus and tongue in the guinea-pig.

Retina of Birds.§—Gustav Fritsch has made a comparative study of the retina of various birds, discussing in particular the area of clear vision. The high degree of visual acuteness in the bird's eye is essentially due to the delicacy and dense arrangement of the elements in the restricted centre of the fovea.

Grouping of Nerve-cells in Spinal Cord of Tench.||—L. Jacobsohn makes a contribution to the topography of the nerve-cells in the spinal cord of *Tinca vulgaris*, comparing it with that observed in man. He is a strong upholder of heterogeneity of the nerve-elements, whether considered physiologically or histologically.

The tench's spinal cord agrees with man's in showing (1) the same large polygonal cells, rich in chromatin, in the ventral region of the grey substance; (2) the minute cells in the dorsal portion of the grey substance; and (3) the reticularis or "Strang"-cells.

Peculiar to the tench's spinal cord are (1) the giant-cells in the most posterior part of the cord; (2) the rather large cells which occur some-

* Arch. Mikr. Anat., lxxviii. (1911) Festschrift Waldeyer, pp. 496-505 (1 pl. and 3 figs.).

† Arch. Mikr. Anat., lxxviii. (1911) Festschrift Waldeyer, pp. 565-617 (2 pls. and 2 figs.).

‡ Anat. Anzeig., xxxviii. (1911) pp. 208-17 (10 figs.).

§ Arch. Mikr. Anat., lxxviii. (1911) Festschrift Waldeyer, pp. 245-70 (4 pls.).

|| Arch. Mikr. Anat., lxxviii. (1911) Festschrift Waldeyer, pp. 506-28 (9 figs.).

what dorsally to the central canal at a few parts of the median area of the cord; and (3) some isolated cells, which are described.

Awanting in the fish, but present in man, are (1) the sympathetic cell-groups; (2) the so-called Clarke's pillar; and (3) the other large cells of the dorsal cornu of the grey substance.

Muscles of Lamprey.*—P. Schiefferdecker has made an elaborate study of the trunk-muscles of *Petromyzon fluviatilis* as regards the structure of the fibres, the nuclear relations, and the sarcolemma. There are various degrees of differentiation, at least three different kinds: the "parietal" fibres of the trunk, the "central" fibres of the trunk, and the muscles of the head. The "parietal" fibres of the trunk correspond essentially to those of higher animals, diverging only in shape, most of them being four-sided prisms. The "central" fibres are large muscle-plates, very far from the usual type, and fenestrated. The "central" fibres have a sarcolemma, but no perimysium; the "parietal" fibres have both. The latter are poor in sarcoplasm, the former very rich.

The author enters into the subject in minute detail—his summary alone occupying over six pages—and draws from his study a number of conclusions as to muscle-fibres in general. One may regard a differentiated cross-striated muscle-fibre of a Vertebrate as a synectium of muscle-cells, surrounded by a sarcolemma, which is of the nature of a "cell-membrane."

Survival of Isolated Leucocytes.†—J. Jolly has been able to keep leucocytes from the frog's blood living and mobile *in vitro* for a year. They were kept in sealed glass tubes at about zero until May, June, and July, 1911, when the temperature rose to +5°.

c. General.

Action of Radium Radiations on Blood.‡—Helen Chambers and S. Russ have studied the action of radium radiations upon some of the main constituents of normal blood. Red blood-corpuscles are haemolyzed by the action of the α -rays, and oxy-haemoglobin is converted into met-haemoglobin. Leucocytes undergo marked degenerative changes when subjected to α -rays. During the process of clotting, leucocytes appear to move away from an α -radiated region. This movement has been attributed to changes found to occur in the surface tension of blood serum when radiated. The specific properties of opsonin and haemolytic complement are lost when serum is exposed to α -rays. The progressive changes caused by these rays indicate the separate identity of opsonin and complement. The β -rays and γ -rays have yielded negative results in analogous experiments.

Sleeping and Waking.§—Ch. Bouchard re-states his theory that a narcotic substance produced during the activity of waking hours, and experimentally demonstrable in the urine, leads to sleep. During sleep, on the other hand, there is formed an excitatory ("convulsivante")

* Arch. Mikr. Anat., lxxviii. (1911) Festschrift Waldeyer, pp. 422-95 (2 pls. and 3 figs.).

† C.R. Soc. Zool., lxxi. (1911) pp. 147-8.

‡ Proc. Roy. Soc., Series B, lxxxiv. pp. 124-36 (8 figs.).

§ Comptes Rendus, clii. (1911) pp. 564-5.

substance whose accumulation leads to the muscular movements which precede awakening. He refers to the similarity between his theory, stated in 1886, and that of Legendre and Piéron (1911), who find evidence that when sleep is prevented there accumulates in the blood a narcotic substance inducing sleep when injected into other animals.

Sense of Direction in Blind.*—Truschel has made a large number of experiments in regard to the sense that blind people have of a near object, or of an object which they approach. The result of his experiments is to suggest that the perception is auditory, the near object reflecting and altering surrounding sounds. To the objection that a deaf-mute is said to have exhibited the sense, the author answers that those quite deaf to music and speech are sometimes sensitive to very feeble noises.

Plica semilunaris in Hereros and Hottentots.†—Paul Bartels has followed up the discovery of Giacomini, who showed that the plica semilunaris conjunctivæ in coloured races has often a minute piece of cartilage, the occurrence of which is one of the greatest rarities among white folk. The plica is a representative of the so-called third eyelid (in whole or in part) of mammals, birds and reptiles. The presence of the cartilage shows that the Hottentots are *pro tanto* more theromorphie than whites, for it is present in all monkeys.

Bartels studied 8 Hereros and 17 Hottentots, and found the little piece of cartilage in 12; Giacomini found it in 12 out of 16; Adachi found it in 5 Japanese out of 25; Giacomini found it 4 times in 548 whites (= 0.73 p.c.)

Vertebrate Lower Jaw.‡—E. Gaupp discusses the “gonial,” a membrane bone of the lower jaw, which is usually penetrated by the chorda tympani. It is the “angular” of some amphibians; it fuses with the articular in lizards and some amphibians; it is the processus anterior mallei in mammals. The malleus is indeed a gonio-articular.

Mammals of West Indies.§—Glover M. Allan has studied these in relation to the problems of geographical distribution. It appears that the present evidence afforded by the distribution of West Indian mammals in the main corroborates the current hypothesis that the fauna is derived in part from northern South America, and in part, by means of probably at least two land bridges, from North and Central America.

Digestive System of Hornbill.||—H. C. Curi has made sections of the various parts of the gastro-intestinal tract of *Hydrocorax hydrocorax*. He has particularly studied the deciduous membrane lining the stomach, which is periodically ejected with undigested refuse. The deciduous membrane is a tough homogeneous secretion from the glands of the stomach. About the position where one would expect cæca, the mucous

* Comptes Rendus, clii. (1911) pp. 1022-4.

† Arch. Mikr. Anat., lxxviii. (1911) Festschrift Waldeyer, pp. 529-64 (1 pl. and 1 fig.).

‡ Anat. Anzeig., xxxix. (1911) pp. 97-135 (16 figs.).

§ Bull. Mus. Comp. Zool. Harvard, liv. (1911) pp. 175-263.

Philippine Journ. Sci., vi. (1911) pp. 31-6 (2 pls. and 1 fig.).

membrane of the gut is much altered, perhaps taking on the functions of the absent cæca.

The assertion often made that fat is absent is disproved. Similarly, the statement that the circular layer of muscle in the intestine is found external to the longitudinal, requires correction. There is an outer longitudinal layer, a circular layer, and a thinner longitudinal layer, with some oblique fibres.

New Species of *Odontopteryx*.*—B. Spulski describes *Odontopteryx longirostris* sp. n. from Tertiary deposits in Brazil. The specimen is larger than Owen's *O. toliupicus* from the London Clay, and in better preservation. The skull is over $\frac{1}{2}$ m. in length; the bill by itself being 0.4 m., and the rest of the skull 0.13 m. The bird was probably rapid in flight, catching fishes as it flew. The peg-like growths of bone on the jaws are contrasted with the teeth in sockets which *Archæopteryx* possessed. Some affinities with albatross, pelican, and ducks are recognized.

Air-sacs in Birds.†—A. Juillet has examined seventeen species, and distinguishes several types. The anterior diaphragmatic sac may communicate with the interclavicular sac. The latter may arise from the third entobronchus by a canal common to the anterior diaphragmatic. There may be seven openings (fowl, partridge, water-hen, etc.) or six (pigeon and parrot), or more than seven (sparrow, gull, etc.). In the second main type (confined to Anseriformes) the interclavicular arises by a canal of its own from the first entobronchus, and does not communicate with the first diaphragmatic.

Snake-poison and Yolk of Egg.‡—C. Delezenne and S. Ledebt have shown that the venom of cobra and daboia, added to yolk of egg, liberates, at the expense of the yolk, hæmolytic and toxic substances which are extremely potent in their effects.

Effects of Starvation on *Necturus maculatus*.§—W. M. Smallwood and C. G. Rogers have studied two specimens which were kept in a large tank, with running water, but without food, for 4 months and 16 months respectively. The effect of the prolonged fast showed itself in a distinct shrinkage of the whole body in the case of the one starved for 16 months, while the other showed in its general appearance little if any change. An account is given of some of the cytological peculiarities observed.

Corpora Adiposa of Amphibians.||—Pierre Kennel has studied these structures in frog, toad, and newt. They are really differentiations of the serous membrane of the peritoneum, and should be called "adipolymphoid" bodies. They have two functions, (1) storing fat during the summer for utilization during the hibernating period, and (2) giving

* Zeitschr. Deutsch. Geol. Ges., lxii. (1910) pp. 507-21. See also Zool. Zentralbl., xvii. (1911) pp. 805-6.

† Comptes Rendus, clii. (1911) pp. 1330-2.

‡ C.R. Soc. Biol., lxxi. (1911) pp. 121-4.

§ Anat. Anzeig., xxxix. (1911) pp. 136-42 (11 figs.).

|| Comptes Rendus, clii. (1911) pp. 1352-4.

origin in spring and summer to numerous elements of the hyaline leucocyte series (a lympho-poietic role).

Lateral Line System in Tadpoles of *Alytes* and *Rana*.*—P. Win-trebert has made a number of experiments which show that excitation of the lateral nerve is not followed by any motor reaction. The terminal apparatus and caudal nerves of the lateral line system do not include any fibre of general irritability. According to the author, the system has not to do with taste or smell or the like, but is "a system of external defence, allied to the auditory system, whose integrity is necessary for equilibration."

Regeneration in Newts.†—Gustav Wolff brings forward evidence to show that the regeneration of the hind limb of *Triton cristatus* is dependent on the nervous system. He dwells especially on the remarkable fact that if an abnormal limb, say with two toes, be cut off, the same kind of monstrosity is regenerated. His conclusion applies only to the case with which he has experimented, for Wolff is careful to point out that the regeneration of the lens, for instance, takes place without nervous stimulus.

Function of Cerebellum in Fishes.‡—V. Franz brings forward evidence in support of the view that the cerebellum plays a very important role in connexion with locomotion in water, for the precise regulation of the voluntary muscles. It is more than an equilibrating organ: it is a "precision-organ." It appears to be a universal centre for all sorts of sensory stimuli. Just as in terrestrial animals the pallium (of the cerebral cortex) is a new central organ in addition to the olfactory centre, so the cerebellum in aquatic animals has been added on to the auditory centre.

Reduction and Oxidation in Animal Tissues.§—P. G. Unna discusses at length the problem of the localization of these two processes, his general thesis being that the reduction-areas are those tissue-elements which contain catalase, but no peroxydases, and that oxidation-areas are those (notably the nuclei) which contain peroxydases, but no catalase.

Equilibration in Aquatic Animals.||—Albrecht Bethe discusses this problem with reference to a variety of types, both with and without statocysts, and distinguishes those which are by construction stable in a given position from those "labile" forms which keep themselves in the normal position by a co-ordination of many movements. He notes, in reference to young fishes, that in some cases the newly-hatched forms are automatically stable, and that they thus get a start in the acquirement of equilibrating co-ordination.

Summer Plankton of West of Scotland and Irish Sea.¶—W. A. Herdman shows that the abundant vernal phyto-plankton dies away in

* C.R. Soc. Biol., lxxi. (1911) pp. 100-2.

† Festschrift R. Hertwig, iii. (1910) pp. 67-80 (1 fig.).

‡ Biol. Centralbl., xxxi. (1911) pp. 434-45.

§ Arch. Mikr. Anat., lxxviii. (1911) Festschrift Waldeyer, pp. 1-73.

¶ Festschrift R. Hertwig, iii. (1910) pp. 81-92 (10 figs.).

¶ Journ. Linn. Soc. (Zool.) xxxii. (1911) pp. 23-38 (8 figs.).

the Irish Sea in early summer, while a similar micro-flora is present in quantity in some parts of the sea on the west of Scotland (e.g. the Sound of Mull and the sea around Canna, Eigg, etc.) until July, and possibly later. It can scarcely be doubted that the phyto-plankton maximum is found in spring in the Hebrides as in the Irish Sea. But have the July Diatoms remained, or have they reappeared?

A survey of numerous gatherings of zoo-plankton shows (1) that localities, in some cases not very far apart, differ very considerably in the nature of their plankton at the same time of year; and (2) that there is constancy year after year in the nature of the plankton in some localities.

Moss-fauna of Central America.*—Fr. Heinis reports from dry moss and lichens thirty-eight Rhizopods (including *Corycia spinosa* sp. n.), eleven Rotifers, and three Tardigrades (including *Echiniscus siegristi* sp. n.).

INVERTEBRATA.

Mollusca.

a. Cephalopoda.

Japanese Cephalopods.†—G. Wülker deals with a collection made by Doflein in Japanese waters. It includes twenty-five species (four new) in eleven genera. The Japanese Cephalopods show most resemblance to the Indo-Malayan forms, but there is a close similarity also to those of the Mediterranean. The author devotes much attention to the "salivary" glands of the different types.

γ. Gastropoda.

New Fossil Chiton from Girvan.‡—F. R. Cowper Reed describes *Helminthochiton thraivensis* sp. n., from Starfish Bed (Upper Bala), Girvan. It has a narrow elongated body, with eight imbricating plates and marginal girdle (?) of spicules. The surface of all the plates is covered with closely set pores, which, as in living forms, probably served for the passage of nerves to superficial sensory structures. The nearest affinities of the Girvan form are with *H. griffithi* Salter.

δ. Lamellibranchiata.

Artificial Parthenogenesis in Mactra.§—K. Kostanecki has studied the development induced in the eggs of *Mactra* by the addition of some potassium chloride solution to the sea-water. The ordinary cleavage does not occur, but the nuclei multiply by multipolar mitosis and ciliated larvæ are formed.

The eggs may give off two polar bodies, or only one, or none. In every case a bipolar segmentation spindle is formed, in the first case from a single ovum-nucleus, in the second case from two ovum-nuclei, in the

* Rev. Suisse Zool., xix. (1911) pp. 253-66 (1 pl. and 3 figs.).

† Abh. k. Bayer. Akad. Wiss., iii. (1910) Supp. Band. i. pp. 1-70 (5 pls.). See also Zool. Zentralbl., xvii. (1911) pp. 792-5.

‡ Geol. Mag., viii. (1911) pp. 337-9 (1 pl.).

§ Arch. Mikr. Anat., lxxviii. (1911) Festschrift Waldeyer, 2^e Abt., pp. 1-62 (4 pls.).

third case from four ovmi-nuclei. If cleavage occurred, the cells would probably have half the normal number of chromosomes in the first case, the normal number in the second, twice the normal number in the third.

What occurred, however, was nuclear division without cell division, then a simultaneous division of the egg into small cells, and finally, much the same result whether the egg had given off two polar bodies, or one polar body, or none. The author gives a detailed account of the interesting abundance of abnormal mitoses.

Contraction of Adductors in Fresh-water Mussels.*—W. F. Ewald has made an exact study of the electrical changes associated with the contraction of the adductors in *Anodonta* and *Unio*, and distinguishes a "Tonustrom" in addition to the "Zückungstrom." The tonic muscle-contraction is defined. It is not oscillatory nor discontinuous, but a persistent process, both in its mechanical and electrical aspects.

Arthropoda.

α. Insecta.

Blood of Insects.†—A. Ch. Hollande has made a comparative study of the blood of insects, partly to see whether there is any marked cytological difference in cases where "auto-hæmorrhage" is usual. He finds that there is no marked peculiarity. But aphides with "cornicles" have free "wax-cells" (cellules cérières) in the blood which are absent in those without "cornicles." The author describes a variety of leucocytes. In most insects there are proleucocytes, phagocytes, granular leucocytes, and œnoeytoids.

Symbiosis of Yeasts and Insects.‡—Karel Sulc has studied the so-called "pseudovitellus" and similar tissues in Homoptera, e.g. in the larva of *Ptyelus lineatus*, and comes to the interesting conclusion that there is symbiosis with various kinds of Saccharomycetes, e.g. *Cicadomyces ptyeli lineati* g. et sp. n. In another paper§ he deals with the yeasts of Cicadas, e.g. *Saccharomyces cicadarum* sp. n.

Migration of Iris-pigment in Compound Eye.||—R. Demoll has worked specially with Lepidoptera (*Agrotis pronuba*). A constant tonus from the brain keeps the pigment in its darkness-position. If the tonus be interrupted by narcotics or sleep, the pigment in the proximal part of the iris-pigment-cells takes the light-position. If the tonus is interrupted peripherally by illuminating the proximal part of the iris-pigment-cells between the crystalline cones and the rhabdom, the pigment assumes the light-position.

Bee Disease.¶—The Board of Agriculture and Fisheries has issued a leaflet dealing with an epidemic disease which has been prevalent for some years past among bees in the Isle of Wight and is now spreading

* Festschrift R. Hertwig, iii. (1910) pp. 55-66 (5 figs.).

† Arch. Zool. Exper., vi. (1911) pp. 283-323 (2 pls. and 12 figs.).

‡ SB. Böhm. Ges. Wiss. (1910) No. 3, pp. 1-39 (18 figs.).

§ SB. Böhm. Ges. Wiss. (1910) No. 14, pp. 1-6 (4 figs.).

Zool. Jahrb., xxx. (1911) pp. 169-80 (2 figs.).

¶ Board Agric. and Fisheries, Leaflet No. 253 (1911).

to the mainland. The cause remains unknown. The bees become disinclined to work, they lose their power of flight, they crawl about the ground. The abdomen swells, wings and legs are affected. The foragers are always the first affected. Finally the whole colony of workers is found massed together in front of the hive or on the ground, except a few which are found crowded round the queen. The mysterious disease may be distinguished from Bee Paralysis, "May Pest," and Dysentery.

Spermatogenesis of *Stenobothrus viridulus*.*—C. F. U. Meek finds that the chromosomes of the spermatogonial complex can be arranged in a graduated series of pairs, and are divisible into three groups, viz., large, small, and medium-sized chromosomes. The number is constant and is seventeen, the fourth largest being unpaired and corresponding with the "monosome" and "accessory" chromosome of other writers. All the members of the spermatogonial complex divide in mitosis; but the odd or heterotropic chromosome often "lags," and can be seen on the spindle when the ordinary chromosomes are assembling at the poles.

The ordinary chromosomes divide in the primary spermatocyte metaphase, and their halves pass to opposite poles of the spindle; the heterotropic chromosome shows no sign of division, and passes entire to one daughter-cell, while the ordinary chromosomes are still on the equatorial plate. In this manner dimorphism of the subsequent spermatozoa is effected.

The author has been unable to discover whether reduction—the separation of conjugant members—occurs at the first maturation division or the next; possibly both divisions are equational, and only a numerical reduction takes place as a result of lateral association of chromatin granules or masses on the reticulum threads prior to the primary spermatocyte prophase of mitosis.

The secondary spermatocytes show seven or eight chromosomes, and this difference is due to the presence or absence of the heterotropic chromosome. In the spermatids the heterotropic chromosome undergoes resolution into particles, whose identity is indistinguishable in the common chromatin mass.

Though the individuality of the chromosomes is quite lost in the resting-stages, there is strong reason for supposing that the same elements appear on the successive mitotic spindles throughout development. It must not be assumed, however, that corresponding chromosomes of two successive metaphases contain the same individual chromomeres.

New Flea from South Africa.†—J. Waterston describes *Xenopsylla trispinis* sp. n., evidently close to *X. cheopis* Rothsch. and *X. nubicus* Rothsch., taken from nests of the cliff swallow (*Petrochelidon spilodera*), also from the birds themselves, and on the walls of the building (in Cape Colony) where the birds nested.

* Journ. Linn. Soc. (Zool.) xxxii. (1911) pp. 1-21 (3 pls.).

† Proc. R. Phys. Soc. Edinburgh, xviii. (1911) pp. 192-5 (6 figs.).

Fatty Body during Metamorphosis.*—A. Hufnagel describes the changes exhibited by the fatty body in *Hyponomeuta padella*, e.g., that some cells are destroyed by phagocytes, while the majority persist and exhibit a remarkable expulsion of chromatin from the nucleus into the cytoplasm—an “*épuration chromatique*.”

Flying Apparatus of Blow-fly.†—Wolfgang Ritter gives a thorough account of the structural arrangements involved in the flight of *Calliphora vomitoria*, and describes their manner of working. The constituents of the wing-joint are three, the processus pterales thoracis, the pteralia, and the processus pterales alæ. The flexibility of the material permits some relative movement of different parts of the same piece of chitin. It is all very different from a Vertebrate's joint.

The indirect muscles produce the elevation and depression of the wings; the direct muscles change the shape and position of the wings and the course they travel in a beat; the direct muscles are probably also steerers; the downstroke of the wing is forward relative to the insect, and directed, in ordinary forward flight, downward and forward also relative to the surrounding air; it produces an elevation of the insect's body, which overcomes gravity but retards the forward movement. During the horizontal movement of the wings, when depressed forward and also during the upstroke, the wings act as gliders, counteract gravity and retard horizontal advance, or vice versa. The fly descending glides forward, or ascending loses its horizontal velocity. The torsion of the wing attains its maximum at the end of the downstroke, because its anal portion lags behind the anterior part during the downstroke in consequence of its flexibility and the resistance of the air. Toward the end of the upstroke the torsion is at its minimum. The folds of the surface and the hairiness of the wing affect its mechanical effect on the air. The numerous small folds of the anal portion of the wing, which is poor in veins, serve to strengthen it.

Oriental Species of Stomoxys.‡—Sophia L. M. Summers finds that the characters most to be relied on are the width of the frons in relation to the width of the head, the width of the median line on the thorax, and the colour of the legs. The abdominal markings can be relied on to a certain extent only. Ten species are dealt with, including *Stomoxys pratti* sp. n.

Cave Diptera.§—M. Bezzi has found in grottos representatives of twenty-six families of Diptera, but the majority of these are only occasional visitors. The family of Heleomyzidæ is most characteristic. No form without wings has been found; no blind form has been found, though some Heleomyzidæ show a reduction of eyes. Some forms show an elongation of antennæ; some show an expansion of the abdomen. No clear case of reduction of pigment has been found; but the author is strongly of opinion there are genuine cavernicolous Diptera.

* C. R. Soc. Biol., lxx. (1911) pp. 635-7.

† Smithsonian Misc. Coll., lvi. (1911) No. 12, pp. 1-76 (19 pls.).

‡ Ann. Nat. Hist., viii. (1911) pp. 235-40 (5 figs.).

§ Arch. Zool. Expér., viii. (1911) pp. 1-87 (23 figs.).

Occurrence of Ox-warbles.*—N. Lehmann and C. Vaney report on the percentage of hides with warbles, observed at Lyons throughout three successive years. They occurred in the hides in every month, but from September to March inclusive the warbles were either retarded larvæ beginning to degenerate or only larval remains. From March to June, when there are no living adults, there is a growing percentage of larvæ in the skin. This points to a migration from the viscera.

The penetration of the larvæ from the alimentary tract is supported by the following facts: (1) the winter restriction of the very young larvæ to the sub-mucosa of the anterior portion of the alimentary canal; (2) the growth of the larvæ in the cesophageal region; (3) the occurrence in February and March of more developed larvæ in the membranes of the spinal cord and in the sub-cutaneous tissue of unperforated skin; (4) the increasing abundance of sedentary larvæ in the skin from May to July. It may be noted that while bullocks with thin skins show a greater percentage-occurrence of warbles, it is the opposite with cows; which shows the skin-thickness is of no importance.

Classification of Culicidæ.†—A. Alcock maintains the propriety of the old group of the family Culicidæ into two sub-families, Corethrinæ (with short and soft proboscis and with hairs on the veins of the wings) and Culicinæ (with long and stiff proboscis and the mouth-parts of the females specialized for piercing) and with scales on the veins of the wings. He proposes to divide the Culicinæ into four sections, which are defined: Megalorhini, Epialurgi, Culicales, and Metanototricha. The Epialurgi or "Ague-producers" include the single genus *Anopheles*, with about 100 species, distributed in all the great zoogeographical regions. The constitution of the genus is discussed.

Parasites of Olive-fly.‡—Paul Marchal discusses the importance of *Dacus oleæ*, which works such havoc among the olives. Fortunately it is often parasitized, e.g. by two Chalcidid Hymenoptera, *Eulophus pectinicornis* L. and *Eupelmus urazonus* Dalm. Marchal has found a new parasite, a Braconid *Opius concolor*, at home in North Africa. It is an internal parasite, as larva and pupa in the corresponding stages of the olive-fly, and seems to be an effective check. Marchal recommends its importation into Europe.

Digestive Ferments of Beetles.—L. Bonnoire has found in beetles four ferments, a proteolytic diastase, a lipase, an amylase, and an invertin. Comparing various types he shows that the nature of digestive juice is adapted to the alimentary regime. Thus, as regards proteolytic diastase, the carnivorous *Dytiscus marginalis* has much, while the vegetarian cockchafer has little.

Buccal Parts of a Ceylonese Staphylinid.||—E. Bugnion gives a careful description and beautiful figures of the mouth-parts of *Creophilus*

* Comptes Rendus, clii. (1911) pp. 1343-5.

† Ann. Nat. Hist., viii. (1911) pp. 249-50.

‡ Comptes Rendus, clii. (1911) pp. 215-18 (3 figs.).

§ Comptes Rendus, clii. (1911) pp. 228-31.

|| Rev. Suisse Zool., xix. (1911) No. 5, pp. 135-52 (2 pls.).

villipennis Kraatz. The labium forms in front of the pharynx a kind of gutter (atrium) hidden under the labrum. On each side is a brush and a comb with forty teeth. These "paralabial" parts are probably stomodeal differentiations, secondarily fused to the labium. The food, which consists of decomposing animal matter, is pressed by the mandibles into the space between labrum and atrium, and the combs act as a strainer, letting fluid pass out.

Revision of Bathysciinæ.*—R. Jeannel has made a detailed study of these cavernicolous Silphid beetles. He deals with their external features, making a special point of distinguishing palæogenetic characters from those that are adaptive to life in caves. The larval forms, the geographical distribution, and the classification are carefully dealt with.

Nutritive Habits of Bostrychidæ.†—Pierre Lesne discusses the diversity of diet in Bostrychidæ and its parallelism with that observed in Scolytidæ. There is no doubt that Bostrychid beetles are primarily xylophagous (eating the hard woody tissue of Mimosa, Bambusa, Vine, *Ficus carica*, etc.). But to this normal diet, to which they are marvellously adapted, they have added two others: (1) as adults they have taken to eating growing shoots of trees; (2) sometimes as adults and sometimes as larvæ they have taken to exploiting the stores accumulated by plants, either on the plants directly or when garnered by man.

Position and Classification of Protodermaptera.‡—Fr. Zacher discusses this sub-order of earwigs, phylogenetically older than the Endermaptera (Labiidæ, Cheliduridæ, and Forficulidæ). Along with the Protodermaptera may be included the Paradermaptera with the family Apachyidæ. The Protodermaptera include two sets of families, the Pygidicraniales and the Labidariales. The author deals with the detailed classification and the geographical distribution.

New Collembola in England.§—J. W. Shoebottom describes *Oncopodura crassicornis* sp. n. from Hertfordshire, and records twelve species new to England—all new to the British Isles except *Sphyrotheca lubbocki* (Pullb.), which has been recorded by Bagnall (1909) from the Kyles of Bute.

Insect Remains from South Wales Coalfield.||—H. Bolton deals with a large series of Blattoid remains, including new species of *Hemimylæris*, *Archimylæris*, etc. They occurred in marked association with vegetable remains; the deposits were apparently near to a land surface: the presence of Archimylærid and Orthomylærid forms, no less than the presence of *Lamproptilia*, is indicative of a considerable advance in insect development in Britain beyond the more primitive palæodictyopteran types.

* Arch. Zool. Exper., vii. (1911) pp. 1-641 (24 pls.).

† Comptes Rendus, clii. (1911) pp. 625-8.

‡ Zool. Jahrb., xxx. (1911) pp. 303-400 (80 figs.).

§ Ann. Nat. Hist., viii. (1911) pp. 32-9 (1 pl.).

|| Quart. Journ. Geol. Soc., lxxvii. (1911) pp. 149-74 (4 pls.).

β. Myriopoda.

New Termitophilous Millipede.*—S. Hirst describes *Termitodesmus lefroyi* sp. n., found by Maxwell Lefroy in the mounds of *Termes obesus* Rawl. at Cuttack, Bengal. It belongs to a new genus recently established by Silvestri for two new Millipedes found by Escherich in the nests of *T. obscuriceps* Wasm. in Ceylon.

Doubling of Segments in Myriopods.†—Jules Chalande points out that while one may theoretically regard the double ring of the Millipede as due to the fusion of two somites originally separate, this view is not supported by the facts. In the post-embryonic development of Centipedes there is a complete doubling of segments, and in *Glomeris* (a Millipede) there is a partial doubling of the ventral plates. At each stage of the post-embryonic development of a Chilopod a new ring arises between the penultimate ring and the anal ring; soon afterwards two pairs of appendages appear; and then the ring divides into two segments. In Millipedes all the rings except the thoracic show their duality, but remain undivided. A series of stages may be worked out—Symphyla, Geophilidæ, Lithobiidæ, and Scolopendridæ—showing the evolution of the double segments of Centipedes.

δ. Arachnida.

Development of Ischnocolus.‡—Ludmilla and W. Schimkewitsch continue their study of this representative of the Tetrapneumones. The young spiders have at first untoothed claws on the pedipalps and limbs, and the basal joint of the chelicerae has no teeth. The arrangement of the eyes is not the same as in the adult. The invaginations of the body-wall, which form insertions for muscles, are described.

In a later stage the claws of the limbs and pedipalps become pectinate, and teeth appear on the basal joint in the chelicerae. After a moult, a piece of endoskeleton appears between the basis of the chelicerae and the basis of the pedipalps. The limits of the ganglia can be detected in the cephalothoracic mass. The development of the gut and the vascular system is also discussed.

Fresh-water Mites of Clare Island.§—J. N. Halbert records eighty species of Hydracarina from two collecting expeditions in Clare Island. Twelve species are recorded for the first time from the British area. Both cosmopolitan and northern forms are well represented in Clare Island. Thus *Lebertia finbriata* Sig. Thor and *Ocus plantaris* Sig. Thor have hitherto been found only in Norway. Four new species are described: *Eylais relicta*, *Frontipoda carpenteri*, *Atractides (Torrenticola) brevisrostris*, and *Unionicola (Atax) rivularis*.

Pseudoscorpiones of Clare Island.||—H. Wallis Kew found that false-scorpions were unusually scarce in Clare Island, probably because

* Ann. Nat. Hist., viii. (1911) pp. 256-7 (1 fig.).

† Comptes Rendus, clii. (1911) pp. 1345-7.

‡ Bull. Acad. Imp. Sci. St. Pétersbourg (1911) No. 10, pp. 775-90 (1 pl. and 20 figs.).

§ Proc. R. Irish Acad., xxxi., pt. 39 (1) 1911, pp. 1-44 (3 pls.).

|| Proc. R. Irish Acad., xxxi. (1911) Clare Island Survey, pt. 38, pp. 1-2.

most of the surface is peat-covered and boggy. He records *Obisium maritimum* Leach from between tide-marks, *O. muscorum* Leach among dead leaves, and *Chthonius tetrachelatus* Leach among stones.

Transmission of Amakebe by Brown Tick.*—A. Theiler finds that the disease of calves in Uganda called Amakebe is identical with East Coast fever (due to *Theileria parva*), and that it is transmitted by the brown tick, *Rhipicephalus appendiculatus*, which has been proved in South Africa to be the principal transmitter of East Coast fever.

Alleged Importance of Demodex in Spreading Leprosy.†—E. Bertarelli and V. Paranhos bring forward a number of facts which are not in favour of the view that *Demodex* is important in the dissemination of the bacillus of leprosy.

Structure and Habits of Macrobiotus macronyx.‡—J. Henneke has studied the male of this fresh-water Tardigrade. In spring the males are as numerous as the females, but later on they disappear. Perhaps there is an alternation of generations as in Rotifers. The male bears peculiar hooks on the first rudimentary appendage, which are used in the sexual union. A moult occurs in the female at that time and the old husk hangs on posteriorly so that the cloaca opens into it. The males bore into this envelope and empty the seminal material into it. Within it the spermatozoa may be seen moving about, and some may enter the cloaca. When ejaculation is completed the female lays eggs, it may be fifteen in five minutes, which accumulate in the old envelope. The latter is usually carried about until the young hatch out, but sometimes the female gets free from it before that.

The author goes on to describe the integument, the food canal, the blood, and the gonads, devoting particular attention to the testis.

Clare Island Water-bears.§—James Murray reports on the Tardigrada collected at Clare Island, for which he adopts Schnltze's name *Arctiscoida*. He deals with no fewer than thirty-three species, all new for Ireland, indeed, no water-bears have been previously recorded from Ireland. Eleven are new to Britain, and five new to science. Twenty-two species are common to Scotland and Clare Island, sixteen are Arctic, three Canadian species occur, and *Echiniscoides sigismundi* is the first marine water-bear recorded for the British Isles. About half of the Clare Island forms are cosmopolitan or widely distributed. The Britannic list now stands at sixty-one species.

Middle Cambrian Merostomata.||—Charles D. Walcott establishes a new sub-order of Eurypterids which he calls *Limulava* with *Sidneyia inexpectans* g. et sp. n., as its type. Along with *Sidneyia* he describes *Amiella ornata* g. et sp. n., the oldest Merostome now known (from the upper Lower Cambrian). The sub-order *Limulava* differs from the Eurypterida in having a large epistoma similar to that of *Trilobites* : in

* Proc. Royal Soc., Series B, lxxxiv. pp. 112-15.

† Centralbl. Bakt. Parasitenk., lvii. (1911) pp. 490-3.

‡ Zeitschr. wiss. Zool., xxvii. (1911) pp. 721-52 (1 pl. and 20 figs.).

§ Proc. Irish Acad., xxxi. (1911) Clare Island Survey, pt. 37, pp. 1-16 (3 pls.).

|| Smithsonian Misc. Coll., lvii. (1911) No. 2, pp. 17-40 (6 pls.).

not having a metastoma, chelate antennæ, and swimming cephalic appendages; and in having a broad fan-shaped caudal fin, and branchial appendages more or less unlike the lamellar branchiæ of the Euryptera and Xiphosura.

Pentastomes in Australian Cattle.*—T. Harvey Johnston and J. Burton Cleland found in the mesenteric glands of cattle suffering from endemic hæmaturia a few small parasites, which they recognized as larval Pentastomes (*Pentastomum denticulatum* Rud.), the adults being known as *Linguatula serrata* Fröl. The larvæ have been recorded from many Mammals, mostly herbivores; the adults infest the nasal cavities and frontal sinuses of other Mammals, mostly carnivores.

6. Crustacea.

Behaviour of Prawns.†—F. Doflein has studied *Leander xiphius* and *L. treillanus*, two common prawns on the Riviera coast. He deals first of all with the various kinds of chromatophores and pigments, and with the post-mortem change into red, which is rather more complicated than is usually supposed. There is a solution of the blue pigment which changes into red, and there is also a change in the yellow and the red pigments. The red pigment is, however, the primary one, and the others are derivatives of it. A careful account is given of the colour-changes that may be observed during life. The author gives an interesting account of the various attitudes assumed by the prawns when resting, when excited, when eating, when cleaning themselves, and so on, and of their reactions to various kinds of stimuli.

Olfactory Structures in Galatheids.‡—Kurt Marcus has studied these in various types, e.g. *Uroptychus*, *Munida*, and *Petrolisthes*, and shows the various arrangements for protection, and the like. He finds evidence that in abyssal forms, where the eyes are degenerate, there is a compensatory high development of olfactory setæ. In other cases the high development is shown to be probably adaptive, and where the conditions of life mechanically endanger the smelling organ, there is a more or less complex protective apparatus.

Classification of Rock Lobsters.§—A. Gravel has tried to introduce greater order into the classification of Palinuridæ, which include six genera—*Puerulus* Ort., *Pallinurellus* v. Mart., *Jasus* Parker, *Palinurus* Fabric., *Limulus* Gray, and *Panulirus* White.

Anatomical and Experimental Study of *Asellus aquaticus*.|| W. Wege has made a minute study of the joints of the second antenna, the innervation, the indirect insertion of the muscle by an epithelial tendon, the ecdysis, the autotomy, and the regeneration. The autotomy may be either reflex or voluntary. It is adaptive, and there is a definite breakage-line between the fourth and fifth joint. The ecdyses do not end with sexual maturity, but probably continue throughout life, though

* Journ. R. Soc. N.S. Wales, xlv. (1910) pp. 315-18.

† Festschrift R. Hertwig, iii. (1910) pp. 215-92 (4 pls. and 16 figs.).

‡ Zeitschr. wiss. Zool., xcvi. (1911) pp. 511-45 (2 pls. and 18 figs.).

§ Comptes Rendus, clii. (1911) pp. 1350-2.

|| Zool. Jahrb., xxx. (1911) pp. 216-320 (2 pls. and 33 figs.).

at longer intervals in older animals. A regeneration is not apparent until after a moult. The first antenna, which shows no autotomy, can be regenerated just as well as the second, which does show autotomy. Many interesting facts are related in regard to the regenerative process.

Cirripede and other Commensals of Madrepores.* — Ch. Gravier has studied in the Gulf of Aden the various commensals (or parasites, perhaps, in some cases) which are found associated with *Gallareia ellisi*, a Madreporal coral with large calices. He directs attention, in particular, to species of the Cirripede genus *Pyrgonua*, which are common on the calices and produce deformities. He describes also the occurrence of a *Chama*, and the coral's response to the bivalve's destructive action.

Annulata.

Adipose Cells of Pontobdella muricata.† — J. A. Scriban has studied the adipose cells in this leech. They are confined to the connective layer between the gastric epithelium and the longitudinal muscles of the body-wall. He describes the mitochondria in the cytoplasm and the occurrence of numerous parasomes, ergastoplasmic bodies, surrounded by concentric lamellæ. The presence of these parasomes indicates the glandular character of the cells in question.

Studies on Australian Earthworms. — Gwynneth Buchanan‡ continues a study of the blood-vessels in species of *Cryptodrilus*, *Diporochæta*, *Megascoler*, etc.

An account is also given in another paper§ of the accessory glands, close to the male and female genital openings, in *Cryptodrilus succarius* (Fletcher). They probably secrete mucus which facilitates the passage of the reproductive elements. Similar glands have been recently described by Sweet in other Oligochaets.

Frieda Bage|| deals with the nephridia in a dozen species, and Janet W. Raff¶ has made a corresponding study of the alimentary canal, with interesting notes on "calciferous glands" and the so-called pepto-nephridia.

Nerve-cells of Leech and Earthworms.** — Wanda Bialkowska and Zofia Kulikowska have made a study of the minute structure of the nerve-cells in various Hirudinea and in *Lumbricus*, in order to determine whether the "Golgi-Kopfsch" apparatus characteristic of Vertebrate nerve-cells is also to be found in these Annelids. Their conclusion is a decided affirmative.

Nephtyidæ and Lycoridæ of the North Sea and the Baltic.†† — Adolph Heinen deals with a collection of species of *Nephtys*, *Nereis*,

* Comptes Rendus, clii. (1911) pp. 210-12.

† C. R. Soc. Biol., lxx. (1911) pp. 674-6 (2 figs.).

‡ Proc. R. Soc. Victoria, xxii. (1910) pp. 209-20 (3 pls.).

§ Proc. R. Soc. Victoria, xxii. (1910) pp. 221-3 (1 pl.).

|| Proc. R. Soc. Victoria, xxii. (1910) pp. 224-43 (4 pls.).

¶ Proc. R. Soc. Victoria, xxii. (1910) pp. 244-54 (4 pls.).

** Anat. Anzeig., xxxviii. (1911) pp. 193-207 (1 pl. and 4 figs.).

†† Inaug. Dissertat. (Kiel 1911) pp. 1-86 (1 pl. and 4 maps). See also Zool. Zentralbl., xviii. (1911) pp. 345-7.

etc., made by the 'Poseidon' (1902-10). Particular attention is devoted to the sexual conditions in *Nereis diversicolor*, one of the interesting facts noted being the occurrence of a Palolo-like swarm of headless worms in Kiel Harbour.

Papillomatous Neo-formation in an Annelid.*—F. Mesnil and M. Caullery describe in *Potamilla torelli* Mhug. what seems to be the first recorded occurrence of a tumour in an Invertebrate. There are papilloma-like proliferations of the mesoderm, forming bud-like growths on the wall of certain segments and extending inwards, somewhat like false septa. In most of the modified segments there is a parasite, *Haplosporidium potamillæ*, and this may start the new growth. If it does, it disappears in some cases, for some of the growths showed no trace of parasite.

New Species of Ctenodrilus.†—Iwan Sokolow describes a new Ctenodrilid from the lancelet sand at Naples. It occurred in five different forms. In its shape, bristles, number of segments, and mode of division it is nearer to Vaillant's genus *Zeppelinia* than to *Ctenodrilus*, and the author calls it *Zeppelinia branchiata* sp. n. There are 25 to 30 segments; the bristles are long and thread-like (2 to 3 in a bundle); the heart-body is intense scarlet or olive-green; the supra-oesophageal ganglion projects strongly into the cavity of the head-lobe; the atokous form has two eyes, a ciliated wreath on every trunk segment, and pairs of gills on many. New individuals are usually formed from several maternal segments. The new formation of the anterior and posterior ends usually occurs after the separation off of the new individual.

Nematohelminthes.

Potency of Blastomeres in Ascaris.‡ Th. Boveri enquires into the potency of the blastomeres when the cleavage has been modified from the normal, e.g. when dispermy has occurred, or when the ova have been rotated in a centrifugal machine. In the latter case some of the eggs divide into two similar blastomeres by a cleavage plane at right angles to the stratification induced by the rotation. These two blastomeres develop in a precisely similar way. Each of them corresponds to the first "Stamm-Zelle" in the segmentation of a normal ovum. The companion of this first "Stamm-Zelle," known as the first primitive somatic cell, has quite disappeared as such.

Microfilaria from a Fowl.§—Berké gives a description of a "microfilaria," very abundant in the blood of the liver of a domestic fowl in Cameroon. Associated with it in the peripheral blood, but not in the liver, were numerous straight or curved rod-like bodies, the significance of which is discussed.

Plasmic Reduction in Spermatogenesis of Ascaris megalocephala.|| Marc Romieu finds that the spermatid undergoes two successive *cyto-*

* Comptes Rendus, clii. (1911) pp. 628-31.

† Zeitschr. wiss. Zool., xxvii. (1911) pp. 546-603 (3 pls.).

‡ Festschrift R. Hertwig, iii. (1910) pp. 215-92 (4 pls. and 16 figs.).

§ Centralbl. Bakt. Parasitenk., lviii. (1911) pp. 326-30 (1 pl.).

|| Comptes Rendus, clii. (1911) pp. 223-5.

plasmic reductions. The first is represented by the expulsion of the cytophore which forms the "intermediate corpuscles." The second is represented by the protoplasmic lobes which are detached to form residual bodies. According to the author, cytoplasmic reduction is a general phenomenon in spermatogenesis.

Worm-nests in Australian Cattle.*—J. B. Cleland and T. H. Johnston describe projections or nodules in the skin of Australian cattle, known as "worm-nests" or "stone-bruises." They contain *Filaria (Onchocerca) gibsoni* Cleland and Johnston, but do not seem to be of much practical importance.

In another paper,† the authors describe the structure of the parasite, which also occurs in camels, and discuss the possible modes of transmission. They discuss the possibility that some mosquito, biting fly, or tick is the intermediate host, but favour another theory, that the life-history is similar to that of the guinea-worm in man, the intermediate host being some species of *Cyclops* or other fresh-water Crustacean.

New Species of Echinorhynchus.‡—G. Blanc and L. Cauchemez describe *Echinorhynchus brumpti* sp. n. from the hedgehog, from which already three species, unsatisfactorily known, have been recorded, namely, *E. major* Bremser, *E. amphipachus* Westrumb, and *E. erinacei* Rudolphi.

Platyhelminthes.

Alleged Toxicity of Tapeworms.§—Guido Guerrini has made a large number of inoculations of nucleo-proteid extracted from *Tænia solium*, *T. serrata*, and *Dipylidium caninum*, into various parts of dogs, guinea-pigs, and rabbits, and has found no evidence of toxic action, nor any specific deleterious influence.

Structure of Monopylidium passerinum.||—T. Harvey Johnston gives an account of this small tapeworm, which Fuhrmann described from the common sparrow and *Fringilla ruficeps*. He deals with the musculature, the excretory system, and the reproductive organs.

Regeneration in Planarians.¶—P. Steinmann has made numerous experiments, with *Planaria gonocephala* in particular. The size of a regenerate is determined neither by the amount of injury, nor by the organs cut off, nor by the parts directly adjoining the wound, but by the whole of the regenerating organism.

A cut down to the middle of the pharynx results in a two-headed Planarian. In place of one of the heads excised a tail grows. The nature of the regenerate, whether head or tail, depends neither on the nature of the section-margin, nor on the nature of the adjacent tissues, but on the regenerating organism as a whole. Distant parts of the regenerating organism have an organizing influence on the regenerate.

* Journ. R. Soc. N.S. Wales, xlv. (1910) pp. 161-71.

† Journ. R. Soc. N.S. Wales, xlv. (1910) pp. 171-89 (1 pl.).

‡ C.R. Soc. Biol., lxxi. (1911) p. 120 (1 fig.).

§ Centralbl. Bakt. Parasitenk., lvii. (1911) pp. 548-66.

¶ Journ. and Proc. R. Soc. N.S. Wales, xliii. (1910) pp. 405-11 (1 pl.).

¶ Festschrift R. Hertwig, iii. (1910) pp. 29-54 (15 figs.).

Effects of Starvation on Planarians.*—J. Berninger has made a study of the effects of starvation on several species of Planarians. During the course of the starvation period the Planarians lose about one-twelfth of their normal size and length, the loss amounting to about one-twelfth of the total volume. No degeneration could be observed in the nervous system or musculature as a result of starvation, and very little in the intestine or parenchyma. In the absence of food and light the eyes were totally re-absorbed in the course of 7 to 8 months; the whole eye-orbit divides into two, three, or more parts, the pigment breaks up, and finally the optic nerves and cells disappear. In pigmented Planarians the body pigment is also re-absorbed to a certain extent. The sexual organs are without exception reduced and finally disappear. The yolks degenerate first and are followed by the copulatory organs. With these the oviducts and vasa deferentia disappear; the ovaries then follow, and the testes are re-absorbed shortly before death takes place. The cocoons are reduced to about half their normal diameter, and the embryo rarely lives till emergence. The embryos which do survive show in their reduced size the effects of starvation. Planarians endure 3 to 4 months' starvation fairly well. If they are well fed at the end of this period the sexual organs may be restored, even though they have almost entirely disappeared.

Revision of Swiss Triclad.†—Paul Steinmann distinguishes rheophilous forms from flowing water, and limnophilous forms usually in stagnant water. A number live in darkness, *Planaria alpina* var. *bathycola*, and *Dendrocolum lacteum* var. *bathycola* from deep lakes, *Planaria vita* from wells, *Dendrocolum infernale* and *Planaria cavatica* from caves. With the aid of very clear diagrammatic figures he gives an account of the general structure of Triclad. A diagnostic key to the genera and species of Swiss Triclad is then given. There are of course no marine forms for Switzerland, and there is only one terrestrial form—*Rhyngodemus terrestris* (Müll.)—so that the key is practically to "paludicolous" forms.

Malacobdella grossa.‡—G. Gering has made a study of this Nematode. All his specimens were obtained from *Cyprina islandica*, usually in large individuals. In one case four young ones were found in one bivalve. Gering observed that although there is no stilet apparatus, the proboscis is used as a weapon. The oogenesis and the spermatozoa, the maturation, fertilization, and first cleavage are described.

Rotatoria.

Clare Island Rotifers.§—James Murray reports on the Bdelloid Rotifers collected at Clare Island, fifty-seven species, of which forty-eight are additions to the Irish list. There is not a single species which is confined to Ireland, and there is only one (excluding six doubtful ones) which does not also occur in Scotland. One of the most interesting

* Zool. Jahrb., xxx. (1911) pp. 179-216 (29 figs.).

† Rev. Suisse Zool., xix. (1911) No. 7, pp. 175-234 (3 figs.).

‡ Zeitschr. wiss. Zool., xcvi. (1911) pp. 673-720 (1 pl. and 1 fig.).

§ Proc. R. Irish Acad., xxxi (1911) Clare Island Survey, pt. 52, pp. 1-20 (1 pl.).

finds on Clare Island was *Callidina asperula*, a species only recently discovered in Canada. The most important peculiarity of the Irish Bdelloid fauna is to be found in certain varieties of common species. These occur among the spiny Bdelloids, which are found in the genera *Dissotrocha*, *Pleuretra*, and *Callidina*.

Echinoderma.

Structure of *Solaster endeca*.*—James F. Gemmill contributes some notes on the structure of this starfish. 1. The central set of pore canals of the madreporite open into collecting trunks leading into the ampullary part of the axial sinus which leads directly into the stone canal. 2. The marginal set of pore canals form collecting trunks which lead into the upper end of the axial sinus, and also communicate freely with the ampullary chamber. 3. In the strict sense none of the pore canals of the madreporite can be said to open into the stone canal. There is an interesting blind diverticulum from one of the spaces connected with the central chamber, which invaginates the wall of the dorsal sac and expands within its cavity. It may serve as a channel for the escape of wandering cells from the dorsal sac. The anus in *Solaster* occupies the same relative position as in other starfish, i.e. it comes after ray V. In four gonads of a large specimen carefully studied, three had two external openings, while the remaining one had three. The external openings formed slit-like pits, and each received the ends of two or three main ducts. Traced inwards, these ducts, after passing through the body-wall, divided into branches each of which came into relation with one of the small ultimate clusters of egg-tubes. The author also discusses the aboral perihemal sinus and an interbrachial branch of the external oral circular sinns.

Middle Cambrian Holothurians.†—C. D. Walcott has discovered some entire Holothurians in fine-grained silico-argillaceous rock from British Columbia. Their occurrence records for the first time, apart from some scattered calcareous spicules and plates, the presence of this class of organisms in any geological formation. He establishes a new family, Eldoniidae, for a free-swimming form, *Eldonia ludwigi* g. et sp. n. The body was disc-like, the mouth and anus ventral, the water-vascular system radial from the aboral pole. There was a broad band of concentric muscle-fibres on the outer half of the subumbrella surface. There was no calcareous skeleton. It was found associated with Trilobites, Phyllopoths, and Sponges, and was first regarded as a Medusa.

Another form is *Luggania cambria* g. et sp. n., with an elongate, pear-shaped body. The ventral mouth, situated near the anterior end, was probably surrounded by calcareous plates. In *Louisella pedunculata* g. et sp. n. the ventral sole is beautifully outlined by the marginal row of podia on each side. A new Synaptid, *Mackenzia costalis* g. et sp. n., has an elongated cylindrical body, and the plates around the anterior end are preserved as casts on the rock. In none of the forms was there any trace of calcareous matter.

* Proc. R. Phys. Soc. Edinburgh, xviii. (1911) pp. 174-91 (8 figs.).

† Smithsonian Misc. Coll., lvii. (1911) No. 3, pp. 41-66 (6 pls. and 6 figs.).

Comparative Age of Recent Crinoid Faunas.*—A. H. Clark considers recent Crinoid faunas in their "physiological phylogenetic aspect." Faunas, like individuals, species, and genera, pass through a period of youth, of adolescence, of maturity, and of senescence. The Bering Sea Crinoid fauna is the nearest approach to a young fauna that can be found. The Antarctic Crinoid fauna is also very young. The Crinoid fauna of southern Japan is adolescent; the West Indian Crinoid fauna is approximately mature; the Australian Crinoid fauna is a perfect example of a senescent fauna, including about fifty species, nearly all of which are remarkable for the grotesque exaggeration of their specific characters. A pathological fauna may resemble a senescent fauna in its general facies; but in a pathological fauna all the species, beside being aberrant, are excessively variable, which is never the case in a senescent fauna. Pathological faunas occur usually on the limits of faunal areas, e.g., in the southern part of Massachusetts Bay.

Cœlentera.

Hexactinixæ from New South Wales.†—Leonora J. Wilsmore describes *Peachia hilli*, *Phellia browni*, and *Ph. capitata*, three new species. The structure of the new *Peachia* is described in some detail. Two points may be referred to. There are numerous pores through the body-wall in longitudinal rows in the region of the physa; there is a powerful endodermal muscle-system, and a sphincter. The two Australian species of *Phellia* are characterized by the unusual strength of the sphincter and its peculiar contraction into two parts. The size and prominence of the acontia are also unusual characteristics.

Middle Cambrian Medusa.‡—C. D. Walcott describes from British Columbia *Peytoia nathorsti* g. et sp. n., a highly organized Medusa, whose relation to the order Rhizostomæ is shown by its discoidal bell without known annular furrow or pedalia, by the lappets on the margin of the bell, by the absence of tentacles, and by the probable presence of adradial arm-like processes at the mouth.

Development of Lucernarians.§—W. Wietrzykowski has continued his study, starting with a polyp with four perradial tentacles, and four interradiial septa showing primordia of the tentacular muscles. He follows the appearance of the successive tentacles.

Notes on Structure and Budding of Limnocoidea.||—C. L. Boulenger has studied some points in the structure of *Limnocoidea tanganyicæ*, the fresh-water medusoid of Lake Tanganyika. The stinging-cells on the tentacles are not developed in situ, but in the ectoderm of the "nettle-ring" (a thickened band at the edge of the umbrella). They migrate thence to the tentacular batteries. The "nettle-ring" is to be regarded as the factory and storage-place of these stinging-cells.

* Amer. Journ. Sci., xxxii. (1911) pp. 127-32.

† Journ. Linn. Soc. (Zool.) xxxii. (1911) pp. 39-57 (3 pls. and 1 fig.).

‡ Smithsonian Misc. Coll., lvii. (1911) No. 3, pp. 55-8 (1 pl.).

§ Arch. Zool. Exper., vi. (1911) Notes et Revue, No. 2, pp. xlix-liii (2 figs.).

|| Quart. Journ. Mier. Sci., lvii. (1911) pp. 83-106 (1 pl. and 3 figs.).

and is not in itself a functional nematocyst battery. There is a well-developed double nerve-ring at the base of the velum, similar in most respects to that of *Limnocoelum* and of other medusoids.

The manubrium is undoubtedly functional as a digestive organ. The gland-cells and digestive cells are restricted to the more proximal regions, the oral endoderm being characterized by the presence of an unusually large number of mucus-secreting goblet-cells. The development of the medusa-buds presents several interesting features, some of which are undoubtedly primitive.

Structure and Affinities of Thyroscyphus.*—A. Kühn gives for the first time an account of the minute structure of this Hydrozoon. He discusses its affinities and establishes a new species, *Thyroscyphus gracilis*. By the nature of the periderm-sheath and of the hydranth body it is separated from the Campanularids and Campanulinids. It should probably be ranked near the base of the Sertularid stock.

Porifera.

Degenerative Changes in Sponges.†—O. Maas has experimented with *Sycaandra raphanus*, *Leucosolenia lieberkühni* and *Chondrosia reuiformis*, observing the results of lack of lime salts, lack of food, and so on. Processes of involution set in, comparable to gemmule-formation, and these are followed after a pause by revivification. The sponge-body becomes simplified and shows its essentially diploblastic (not triploblastic) constitution. In the resting stage there are internal granular cells and external covering cells. The internal cells are due to the activity of phagocytes which absorb the gastral cells and other elements. In the Calcareea these phagocytes are modified porocytes; in the Demospongiae they are migratory "cellules sphérulenses" of the middle stratum. One of the interesting general results is the indirect confirmation of the view that sponges are fundamentally diploblastic.

Merlia.‡—R. Kirkpatrick gives an account of the remarkable sponge known as *Merlia normani*, found by Canon Norman and afterwards by the author in 60 to 90 fathoms off Porto Santo and Madeira. It is a vermilion-coloured encrusting monaxonellid sponge belonging to a new sub-family—Merlinae—of the Haploscleridae. Large granular amoebocytes (calcocytes) have constructed a basal calcareous skeleton, formed of vertical tubes divided up by horizontal tabulae. The tubes are built up of columns, each with three vertical wings which unite with wings of neighbouring columns to form tubes. This mode of construction was probably primarily determined by the disposition of the branches of the choanosome, which led to the deposition of amoebocytes at the points of bifurcation of the lines of flagellated chambers.

Apparently the calcocytes become wholly transformed into lumps, conules, or flakes. The calcareous skeleton shows certain resemblances, especially at the surface, to certain Palaeozoic fossils, classed among

* Zool. Jahrb., xxxi. (1911) pp. 25-38 (1 pl. and 3 figs.).

† Festschrift R. Hertwig, iii. (1910) pp. 93-130 (3 pls. and 2 figs.).

‡ Quart. Journ. Micr. Sci., lvi. (1911) pp. 657-702 (7 pls. and 5 figs.).

"tabulate corals" or Polyzoa (some of the Monticuliporas). There is no dermal epithelium, and the canal system is hymenopylous.

The author replies to objections (of an *a priori* character) that have been brought against the sponge nature of *Merlia*. He has examined over 500 specimens, and his conviction is that it is a sponge that forms both a siliceous and a calcareous skeleton.

New Lithonine Sponges from Christmas Island.*—R. Kirkpatrick describes *Plectroninia deansii* sp. n., found as a thin vitreous-white crust on some pieces of rock dredged off Christmas Island. The skeleton is constructed of fused four-rayed spicules, as in other Lithoninae; the distinguishing feature of *P. deansii* lies in the character of the loose spicules. These are mostly monaxons, curved at one extremity, running to a sharp point at one end and rounded at the other. One spicule appears to be bifurcated at one end, and may be regarded as a three-rayed form. Kirkpatrick suggests a revised classification of the Pharetronidae, which he divides into four sub-families: Diallytinae, Pharetroninae, Lithoninae, and Murrayoninae.

Pharetronid Sponges of Essen Greensand.†—O. A. Welter gives an account of a collection of the fossil *Calcarea* from the Essen Greensand. The family Lithonina is represented by eleven species of *Porosphærella*; the family Pharetronina is represented by a score of species belonging to the genera *Coryuella*, *Peronidella*, *Steinmannella*, etc. The Pharetronids mostly disappeared at the end of the Cretaceous period, and it is uncertain whether they have left any extant descendants. The author indicates his belief that *Astroclera willeyana* Lister is one of these.

Protozoa.

Studies on Pelomyxa.‡—Antonin Stole enquires into the membrane around the refractive bodies in the cytoplasm of this giant amœba. It consists of a carbohydrate more difficult to dissolve than glycogen. He believes that the agglutinin of the refractive bodies forms this protective membrane out of glycogen. When the animal has to fast, a lysin from the refractive bodies dissolves the membrane. Then there is a mass-agglutination of exhausted refractive bodies; but, in point of fact, the membrane is continually being dissolved and replaced. In the same way a nuclear agglutinin makes a nuclear membrane. The symbiotic bacteria of *Pelomyxa* are agglutinated on the surface of the nucleus and on the surface of the refractive bodies, and sometimes in the cytoplasm in general. There is a bacterio-agglutinin and a bacterio-lysin in continual operation, according to the author, and the capacity that higher animals have of producing immunizing substances (agglutinin, lysin, etc.) has its phylogenetic beginning in cases like *Pelomyxa*.

Encystation in Pelomyxa.§—A. Stole has studied the encysted stage in this giant amœba, and finds that it is closely comparable to that in

* Ann. Nat. Hist., viii. (1911) pp. 177-9 (10 figs.).

† Verh. Nat. Ver. preuss. Rheinl., lxxvii. (1911) pp. 1-82 (3 pls. and 10 figs.).

‡ SB. Böhm. Ges. Wiss. (1910) No. 9, pp. 1-8.

§ SB. Böhm. Ges. Wiss. (1910) No. 16, pp. 1-7 (1 pl.).

Myxomycete plasmodia. The body divides into several unequal parts comparable to the formation of macrocysts in Myxomycetes, according to Zopf's description.

"Trichites" in *Didinium*.*—E. Fauré-Fremiet describes in this large ciliated Infusorian what he calls "trichites." These are intraprotoplasmic filaments of great tenuity, forming a sort of armature for the pharynx. They are straight or gently curved, quite smooth, and pointed at the ends. They are elastic and albuminoid; but the author finds that altogether similar filaments may be induced artificially by using a concentrated solution of sulphate of magnesium, which brings about a partial precipitation of the cytoplasm.

Notes on Flagellates.†—A. Alexieff deals with *Octomitus intestinalis* Prowazek from rat, newt, and axolotl; *Polymastix batrachorum* sp. n. from *Triton taeniatus*; *Monocercomonas bufonis* Dobell from newts, axolotl, and frogs; *Heteromita lacertæ* Grassi in newts, axolotl, and salamander; *Rhizomastix gracilis* g. et sp. n., a rare form from the axolotl, which approaches *Orcomonas* and *Cercomonas*; *Chilomonas paramacium* Ehrbg.; and a number of other forms.

Classification of Trypanosomes in Mammals.‡—A. Laveran directs attention to the large number of Trypanosomes which have been recorded, and the lack of precise description in the majority of cases. The identification of species should rest (1) on structural characters, such as the disposition of the flagellum; (2) on the vital properties, such as whether the form is pathogenic or not; and (3) on special characters discovered by serum-diagnosis and the like.

The non-pathogenic Trypanosomes of Mammals may be divided into those of small Mammals and those of Bovidæ. The pathogenic Trypanosomes of Mammals may be divided into those in which the flagellum has always a free portion; those in which the flagellum has no free portion; and those which occur in both states. Besides these there are many doubtful species.

Frog Trypanosomes in Japan.§—M. Koidzumi has studied the Trypanosomes found in *Rana temporaria*, *R. esculenta*, and *R. rugosa*, distinguishing various types, but coming to the conclusion that there is, after all, but one species, *Trypanosoma rotatorium*.

Trypanosomes in Fresh-water Fishes.¶—C. Mathis and M. Leger describe Trypanosomes in a number of well-known fishes from Tonkin, such as *Anabas scandens*, *Carassias auratus*, and *Macropodus viridi-auratus*.

Cæcal Parasites of Fowls.¶¶—C. H. Martin and Muriel Robertson deal with *Chilomastix gallinarum*, *Trichomonas gallinarum*, *T. eberthi*, *Trichomastix gallinarum*, all of them new species from the cæca of

* C.R. Soc. Biol., lxxi. (1911) pp. 146-7.

† Arch. Zool. Exper., vi. (1911) pp. 491-527 (15 figs.).

‡ Ann. Inst. Pasteur, xxv. (1911) pp. 497-517 (1 fig.).

§ Centralbl. Bakt. Parasitenk., lviii. (1911) pp. 454-60 (1 pl.).

¶ C.R. Soc. Biol. Paris, lxxi. (1911) pp. 185-7.

¶¶ Quart. Journ. Micr. Sci., lvii. (1911) pp. 53-81 (5 pls. and 4 figs.).

fowls. They point out that until the whole life-cycles are known, the breaking up of the complex series of forms inhabiting the cæca of fowls into good species is a matter of great difficulty, but they indicate the characteristic features of the four forms which they have distinguished, as above stated.

Cilium of *Treponema pallidum*.*—C. Levaditi records his observations of a terminal cilium in this parasite of syphilis. It is visible on the living organism: it has a filiform free end; its thickness is about one-third that of the rest of the organism; it has eight to ten deep undulations; it is actively mobile, and it seems as if the organism moves with the cilium behind.

Leptomonad of the House-fly.—J. S. Dunkerly describes some stages in the life-history of *Leptomonas muscæ domesticæ*, distinguishing (1) a typical Leptomonad form which actively divides in the intestine or in the Malpighian tubules of the fly, and (2) very actively slender forms, often with an undulating membrane. These are produced by the others. They probably encyst while attached in large numbers to the rectal wall, and the cysts may be passed out with the faeces to give rise to flagellate forms in another fly.

Hæmatozoa of Australian Batrachians.†—J. Burton Cleland and T. Harvey Johnston describe a Trypanosome (perhaps *Trypanosoma rotatorium* (Mayer) from Queensland frogs (*Lymnodynastes*), and *Hæmogregarina* (*Lankesterella*) *hyla* sp. n. from the common "Green-tree-frog," *Hyla cærulea*.

Studies on Hæmatozoa.—C. Franca § reports on some Hæmatozoa of Portuguese Guinea: *Trypanosoma levisi* Kent, very common in *Mus rattus*; a Hæmogregarine from a tortoise (*Sternotherus derbianus*); another from *Varanus niloticus*.

In another paper || Franca describes *Hæmogregarina pestanæ* sp. n. (from *Bufo regularis*); *Trypanosoma bocagei* sp. n. (reported by others as *T. rotatorium*), from the same; *Toxothrix bufonis* g. et sp. n., from the same; and some other forms, all from Guinea.

In a third paper ¶ he deals with Hæmogregarines from Portuguese fresh-water tortoises.

Parasites of Leucocytes in Brown Rat.**—C. Franca and M. Pinto discuss the various parasites which have been found in leucocytes since Bentley's discovery in 1905. In the family Hæmogregariniidæ they recognize two genera, *Hæmogregarina* Danilewsky (= *Drepanidium*, *Kariolysus*, and *Danilewskyæ*) and *Leucocyto-gregarina* Porter (= *Leucocytozoon* Danilewsky pro parte, and *Hepatozoon*). They go on to describe stages in the life-history of *Leucocyto-gregarina muris* (Balfour).

* C.R. Soc. Biol., lxxi. (1911) pp. 156-8 (1 fig.).

† Quart. Journ. Micr. Sci., lvi. (1911) pp. 645-55 (1 pl.).

‡ Journ. R. Soc. N.S. Wales, xlv. (1910) pp. 252-60 (1 pl.).

§ Arch. Inst. Bacter. Camara Pestana Lisbon, iii. (1911) pp. 201-5 (3 figs.).

|| Arch. Inst. Bacter. Camara Pestana Lisbon, iii. (1911) pp. 229-38 (1 pl.).

¶ Arch. Inst. Bacter. Camara Pestana Lisbon, iii. (1911) pp. 239-44 (2 figs.).

** Arch. Inst. Bacter. Camara Pestana Lisbon, iii. (1911) pp. 207-17 (2 pls.).

Glugea lophii.*—R. Weissenberg discusses the remarkable tumour-like cysts which are produced in the nervous system of the angler (*Lophius*) by the Microsporidian *Glugea lophii*. The hypertrophy of the ganglion-cells, the retrogressive changes in the cysts, the spreading of the infection within the body, are among the subjects discussed.

Studies on Flagellates.†—G. Senn deals with *Oryrhis*, *Nephroselmis*, and other Flagellates. He shows that *Oryrhis* belongs to the Peridinidae, and must be placed near *Hemulinium*. This change is based on the asymmetry of the cell, the possession of a longitudinal and transverse groove, two flagella, the structure of the nucleus, and the mode of division. This removes from the Euflagellata their most divergent member; and the author seeks to define the Euflagellata more precisely. Longitudinal division is dominant, and there is no form with clearly-defined transverse division. In the symmetry of cell, the nature of the flagella, the structure and division of the nucleus, the Euflagellata are clearly marked off from other Protists.

Protozoa in the Alimentary Canal of House-fly.‡—P. C. Flu has found that the gut of *Musca domestica* in Surinam (Paramaribo) contains two species of Flagellates—*Herpetomonas muscæ domesticæ* and *Leptomonas muscæ domesticæ*, and a new Schizogregarine, *Octosporea muscæ domesticæ* sp. n. He describes their various stages, and discusses their transmission from fly to fly.

Cnidosporidian without Cnidoblasts.§—Edouard Chatton describes *Paramyxa paratolosa* g. et sp. n., found within a pelagic Annelid larva. Its spore is remarkable in showing a single parietal cell and no cnidoblast—a unique exception in the class of Cnidosporidia. It seems to require a new Cnidosporidian family for itself, and its inclusion within the Cnidosporidia opens that class to forms like *Peltoomyces* from cockroaches, where the spore is without a stinging apparatus, but protected by a cellular envelope.

Conjugation in Paramœcium.||—H. S. Jennings publishes the results of an experimental study of the conditions which induce conjugation in *Paramœcium*. He finds that they differ greatly in the different races (*P. aurelia* or *P. caudata*). Some races conjugate freely and under conditions readily supplied in experimenting. Others under the same conditions do not conjugate at all. The interval between conjugation may be very short—in one race epidemics of conjugation occurred at intervals of two weeks to a month, while in a single case there were successive conjugations at intervals of five days. In other races conjugation occurred only at intervals of a year or more. In one race, carefully watched, conjugation was not observed during a period of three years. Frequent re-conjugation may be observed among the progeny of a single individual. Conjugation occurred in the races favourable for experi-

* Arch. Mikr. Anat., lxxviii. (1911) Festschrift Waldeyer, pp. 383-421 (2 pls.).

† Zeitschr. wiss. Zool., xcvi. (1911) pp. 605-72 (2 pls. and 8 figs.).

‡ Centralbl. Bakt. Parasitenk., lvii. (1911) pp. 522-35 (2 pls.).

§ Comptes Rendus, clii. (1911) pp. 631-3 (10 figs.).

|| Journ. Exper. Zool., ix. (1910) pp. 279-99 (4 figs.).

mentation, not as a result of starvation, but at the beginning of a decline in the nutritive conditions, after a period of exceptional richness that had induced rapid multiplication. At the time of conjugation the animals are often in good condition, and multiplication may still be in progress. In the races conjugating less readily the external conditions favouring conjugation are probably somewhat different yet of a similar general character. The differences in different races in the matter of conjugation do not bear a simple relation to the relative size of other morphological characteristics of the race. The two largest and the two smallest races observed conjugated only rarely; the race that conjugates most frequently is intermediate in size. Among the races that conjugate rarely are some with two micro-nuclei and some with one. The fact that, in a given race, conjugation may be repeated (in the same line of descent) at intervals of five days to a month, and the fact that races derived from a single individual may live without degeneration for three years without admixture from outside, tend, along with the results of Woodruff, Enriques, and others, to weaken the theory that conjugation is to be considered as a result of senile degeneration at the end of the life-cycle.

Nuclear Changes in Conjugation of Colpidium.*—A. Dehorne finds that in *Colpidium colpoda* the process of conjugation is similar to that which he has described in *Paramacium caudatum*. When the migratory micro-nucleus is about to cross over, the stationary nucleus moves farther back and becomes appressed to the macronucleus, within a vacuole in which it degenerates. The micronucleus which has passed over elongates and forms a spindle, but the stationary nucleus disappears. The long spindle, extending posteriorly, completes its mitosis and forms two micro-nuclei, which immediately prepare for another mitosis.

New Species of Mesnileila.†—E. André describes from the alimentary canal of the Oligochaet *Lumbriculus variegatus* a new species of this genus of astomatous Ciliata. He names it *Mesnilella cepedei* sp. n., and distinguishes it from other species mainly by the shape of the supporting "spiculum," which runs out into a thread posteriorly and by the number (1-4) of contractile vacuoles.

Internal Euglenid Parasite.‡—P. de Beauchamp describes *Astasin captiva* sp. n., which he found very active and in large numbers inside the chain-forming Turbellarian *Catenula lemnæ*. It has no chlorophyll nor stigma, but its position is indubitable. A case of parasitism among Euglenids may possibly have some interest, the author suggests, in connexion with the much-debated question of the origin of Gregarines.

* Comptes Rendus, clii. (1911) pp. 1354-7 (9 figs.).

† Rev. Suisse Zool., xix. (1911) pp. 267-70 (1 fig.).

‡ Arch. Zool. Expér., v. (1910) Notes et Revue, No. 5, pp. lii-lviii (2 figs.).

BOTANY.

GENERAL,

Including the Anatomy and Physiology of Seed Plants.

Cytology,

Including Cell-Contents.

Structure of Protoplasm.*—W. W. Lepeschkin contributes a preliminary paper dealing with work on the structure of protoplasm. The author believes that living protoplasm is to be regarded as a colloidal solution of the nature of an emulsion, which under certain conditions is visible under the Microscope, and may be transformed into a gelatinous foam with fluid, honeycomb-like walls. The writer is of the opinion that such a structure is the only one which would account for the physical and physiological characters of protoplasm. The colloidal parts, which show "Brownian" movement in the plasma of the protoplasm, probably consist of various and heterogeneous chemical compounds. Since the distribution of colloidal parts takes place very slowly, molecules of chemical compounds arising in any particular part of the protoplasm cause alterations in the protoplasm at that point, and bring about such phenomena as prolongations of the cell, separation of special substances, changes in the protoplasm, etc., which in their turn cause movements in the plasma. Such a structure would explain the organization of the protoplasm whereby reactions or conditions occurring in one part are conducted to all other parts. If by the action of electricity, poisons, etc., this colloidal structure is destroyed and coagulation ensues, then life is destroyed. The contents of the protoplasm, i.e. nucleus, chromatophores, etc., all appear to partake of this colloidal nature. The author believes that all phenomena exhibited by protoplasm may be explained by this "living plasma" theory.

Chemical Composition of the Plasma-membrane.†—W. W. Lepeschkin has studied the chemical composition of the plasma-membrane, i.e. the plasma-layers which form on the surface of protoplasm and possess selective osmotic properties. Numerous experiments lead the author to believe that the power of diffusion is due to the same causes which render possible the diffusion of salts, acids, and other readily soluble substances, i.e. to dissolved molecular water in the dispersion-medium. Albuminoids or closely allied compounds also play an important part in dispersion, likewise lipoids and oily substances, although it is still doubtful whether the latter are simple or combined with a mixture of lecithin and cholesterin. At present it appears as though all the above substances exist in the dispersion-medium either in a molecular solution or as a loosely combined chemical compound; the

* Ber. Deutsch. Bot. Gesell., xxix. (1911) pp. 181-90.

† Ber. Deutsch. Bot. Gesell., xxix. (1911) pp. 247-61.

latter is the most probable, since substances like lecithin can only be detected after coagulation of the albumin. The composition of this compound appears to be so unstable that dissociation occurs at the slightest disturbance of the protoplasts.

Function of Nucleoproteid.*—W. Zaleski has made numerous experiments as to the function of nucleoproteids in plants. The investigator finds that these proteids are built up during the growth of the somatic cells, and that they contain very stable formative materials which usually go to build up the protoplasts; under normal conditions of growth the nucleoproteids show no appreciable decrease in quantity, but under abnormal conditions, i.e. when in danger of death, they may serve as a food reserve. Nucleoproteids undoubtedly break down during the growth of seedlings and the differentiation of somatic tissues, but the amount formed exceeds the amount used, except at the time of death, when conditions are reversed. It appears that nucleoproteid is a characteristic system of different compounds, not a single complex substance, and it cannot be regarded either as a bearer of life or as transmitting hereditary characters. The proteids of the nucleus and of the protoplasm appear to be different. The chemical structure of the protoplasts is unknown, but albuminoids, proteids, lipoids, and especially phosphides, appear to be necessary, while stearine also is present. Enzymes are combined more or less firmly with the lipoids, but upon death these enzymes are set free, thus explaining the difference between the ferments of living and of dead plants.

Chondriosomes in Plant-cells.†—A. Meyer contributes some remarks upon a paper lately published by Lewitsky, in which it is stated that chromatophores are developed from chondriosomes. The writer points out that while Lewitsky claims that the chromatophores originate independently of the nucleus and cytoplasm, the chondriosomes of animal-cells give rise to such substances as yolk, pigment, fat, etc., which correspond to those substances formed in the plant-cell as a result of the modification of cytoplasm, and this appears to contradict the view put forward. It is further maintained that difference in coloration in response to certain reagents is insufficient basis for such a theory, and its author is asked to state how chondriosomes may be distinguished, and to give stronger reasons for his opinion.

Heterotypic Division of Pollen-mother-cells.‡—L. v. Bönicke has investigated the presynaptic and synaptic stages in the heterotypic division of pollen-mother-cells, in order to form some definite opinion as to the relative distribution of chromatin and linin. The plants used were *Equisetum*, *Polygonatum*, *Marantha*, *Chelidonium*, *Delphinium*, *Sambucus*, *Datura*, *Bryonia*, and *Helianthus*. Some types, e.g. *Equisetum* and *Polygonatum*, show a distinct net-work of linin with granules of chromatin; *Datura*, *Helianthus*, etc., have a finer net-work of linin with chromatin in the form of prochromosomes, while others, e.g. *Sambucus*, show only nodules and threads of chromatin, but no linin at all. Thus

* Ber. Deutsch. Bot. Gesell., xxix. (1911) pp. 146-55.

† Ber. Deutsch. Bot. Gesell., xxix. (1911) pp. 158-60.

‡ Ber. Deutsch. Bot. Gesell., xxix. (1911) pp. 59-65 (1 pl.).

the author concludes that nuclei vary in richness of chromatin, and that it is only possible to distinguish chromatin from linin where the nucleus is relatively poor in chromatin. Moreover, in all cases investigated during the present work, the author finds that the spirem stage is clearly the result of fusion of paired threads.

Starch-grains and Oil-drops in Conifer-wood.*—G. Lakon contributes a paper upon his discovery of starch-grains and drops of oil in the pitted tracheides of young secondary wood of Conifers. The author has tested his results in various experiments, and is led to the conclusion that both the starch and the oil are the products of the mutual reaction of the glyucose and of certain plasmatic remains present in the tracheides. It is pointed out that only two other such instances are recorded, i.e. in *Mnium* and *Plantago major*; the first is a moss and scarcely forms a parallel case; in *Plantago* protoplasmic remains were found, but this is less remarkable since this genus is herbaceous. Without venturing any opinion as to the reason of such a condition, the author draws attention to the fact that the plasmatic contents of the tracheides are the last to disappear, and remarks that in these sheltered cavities the tenacious protoplasm can live and carry on its functions for a longer time than elsewhere.

Peroxydase and Respiratory Pigments.†—W. Palladine and P. Iraklionoff have made numerous experiments dealing with the nature of peroxydase and its relation to the respiratory pigments. The results show that the quantitative distribution of peroxydase is in proportion to that of the chromogenic respiratory pigments; peroxydase occurs as a free or fixed diastase in different plants, and the quantity present varies very much. It is probable that yeast can cause alcoholic fermentation even in the presence of air, owing to its entire or partial freedom from oxidizing diastases. Albuminoids prevent the liberation and purification of peroxydase. The methods of proving the presence of respiratory pigments vary with the specific peculiarities of each plant, the same reagent acting differently in this respect in different plants; thus, a reagent which accelerates the formation of pigment in wheat-embryos, prevents it in etiolated stems of *Vicia Faba*. Heating to boiling-point aqueous extracts containing respiratory chromogenes, causes chemical changes which render the formation of the pigments impossible, and it probably destroys the substances required by the peroxydase for the formation of the respiratory pigments.

Structure and Development.

Vegetative.

Evolution of Conducting-tissues of Vascular Plants.‡—G. Chauveaud publishes the results of twenty years' work in connexion with the conducting tissues of vascular plants. This publication comprises three parts, viz.: 1. An historic review dealing with the vascular system and

* Ber. Deutsch. Bot. Gesell., xxix. (1911) pp. 175-8 (1 fig.).

† Rev. Gén. Bot., xxiii. (1911) pp. 225-47.

‡ Ann. Sci. Nat. (Bot.) ser. 9, xiii. (1911) pp. 113-439 (218 figs.).

theories relative to its different constituents. 2. A discussion of the theories held at the beginning of the twentieth century, relating to the evolution of the different parts of the vascular tissues and special sections dealing with the stele, bundles, etc. 3. New observations as to the ontogenic development of vascular tissues in the Cryptogams, Gymnosperms, Dicotyledons, and Monocotyledons. The following are the chief conclusions based upon the results obtained:—In the course of evolution the vascular tissues show successive phases, each characterized by a special arrangement of vessels and sieve-tubes. All the phases can be grouped under two cycles, the first of which starts with the centric phase and ends with the opposite phase; the second cycle starts with the alternate phase and ends with the superposed or peripheral phase. Each phase must be regarded as a successive stage of the same general type. Root-structure differs from stem-structure not because of difference in organ, but because the two structures correspond to two different phases of evolution. Ancestral characters are better preserved in the root than in the stem. In the majority of Cryptogams the stem only reaches the first cycle of evolution; in fossil plants the stem and branches have reached the first phases of the second cycle, while in recent plants there has been a more or less rapid advance in evolution. Many living Phanerogams show the first phases at the base of the stem, but these are suppressed or only transitory above the hypocotyl. The root shows only a slow advance, chiefly seen in the gradual absorption of primitive conducting elements. Among the Ferns the stem has made relatively slow advance, and hence the stem tends to resemble the root; the reverse is the case with the Palms. When the stem has just reached the alternate phase, we get the most perfect case of vascular continuity. The vascular structure is more complicated in proportion to the development of the plant; if the groups remain separate the structure is polystelic; if they fuse it is solenostelic. Further complications arise owing to the partial or complete fusion of different groups in different phases of development. The author regards it as more logical to start from the leaf in order to correctly interpret the organization of the stem, since the leaf preserves primitive structures for a longer time, e.g. the cotyledons. Failure to estimate the true course of evolution may be traced to want of due regard to the vascular structure of the leaf.

Leaf-symmetry and Exotrophy.*—K. Boshart has studied the causes of variation in leaf-form in Phanerogams, Ferns, Lycopods, and Mosses. The author finds that while the relative size of the different parts of the leaf is dependent upon the area assigned to them at the growing-point, the subsequent development is proportional to the amount of food-material supplied to them. Another important factor is the direction of the flow of food-material, a larger supply on one side causing asymmetry in the leaf-form. Neither gravity nor light appear to cause any modification of leaf-form. In pinnate leaves the form corresponds to the system of venation, and in dorsiventral forms asymmetry and anisophylly are expressions of general symmetry. In plants like *Goldfussia* and *Klugia* the anisophylly is due to the dorsiv-

* Flora, ciii. (1911) pp. 91–124 (14 figs.).

ventrality of the branch, and the asymmetry of the leaves is a correlation of the same condition. The dorsiventrality of the branches appears to be due to unequal distribution of food-material at the growing-point: when the food-supply is equally distributed the dorsiventrality gives place to a radial arrangement. Similar statements hold good for flowers. Axillary buds cause asymmetry of the inner halves of the subtending leaves.

Monocotyledonous Characters in the Polycarpeæ.*—R. E. Fries has examined many plants belonging to the Polycarpeæ, and while finding no instances of fused cotyledons in the Ranunculaceæ, Lardizabalaceæ, Berberidaceæ, Menispermaceæ, Magnoliaceæ, Calycanthaceæ, Myristicaceæ, Monimiaceæ and Lauraceæ, has found numerous instances of fused first leaves in vegetative-buds, flower-buds, and in the inflorescences of the Nymphaeaceæ. The author points out that this monocotyledonous character is also commonly found in the Anonaceæ and Aristolochiaceæ, and that there are many reasons for classifying these two families in the same group as the Nymphaeaceæ. Many writers regard the Aristolochiaceæ as descendants of extinct Anonaceæ, and such a widely spread (though hitherto little noticed) common character cannot be a coincidence, but seems to point to a relationship between the three families, and also to a connexion with the Monocotyledons. The present paper is to be followed by another dealing with this point in special reference to the Anonaceæ.

Reproductive.

Morphology of Diospyros.†—S. M. Hague has studied the morphology of the flowers of *Diospyros virginiana*, and the following are the chief results of her work. The flowers are formed on young shoots, the order being—a pair of bracts, calyx, corolla, stamens, and pistil. The anatropous ovule has two integuments and contains four megaspores, the chalazal one becoming the embryo-sac. The latter is small at the eight-celled stage, and rests upon a stalk-like portion of the nucellus; it is surrounded by a tapetal layer formed from the inner integument. There is little evidence of pollination and none of fertilization, which probably accounts for the seedless fruit. After the flowers fall the ovule enlarges and endosperm rapidly forms until the embryo-sac is full; the embryo is late in appearing, and a tendency to variation is seen in freak embryos and polyembryony. Pollen-mother-cells are found a week before the older flowers are open; they are large and show difference in size, while frequently only one nucleus can be distinguished.

“Hypanth” of the Rosaceæ.‡—A. Hillmann has investigated the floral structure in the Rosaceæ in order to discover the nature of the “hypanth.” With this object the author has given special attention to

* Ber. Deutsch. Bot. Gesell., xxix. (1911) pp. 292-301 (6 figs.).

† Bot. Gaz., lli. (1911) pp. 34-45 (3 pls.).

‡ Bot. Centrabl., xxvi. 3 (1910) pp. 377-421 (7 figs.).

the course and structure of the vascular strands. The vascular tissues of the "hypanth" are derived from those of the calyx, corolla, and stamens; in most of the genera the strands coming from the calyx and corolla run parallel to each other and are near the surface, while those from the stamens run towards the base of the "hypanth," where they unite with the vascular tissues of the stem or of the "gynophores" (outgrowth of axis on which each carpel is borne). In *Rosa* the condition is different, for the vascular strands derived from the stamens never anastomose with the other strands of the "hypanth." This condition, together with other differences in the form and arrangement of the vascular bundles, induces the author to disagree with those writers who put the fruits of *Rosa* and *Geum* in one class. He regards the fruit of *Rosa* as being indisputably an axis, that of the Pomaceæ as a combination of calyx and axis, and that of *Potentilla*, *Prunus*, etc., as a product of foliar origin. He concludes that in all the Rosaceæ, with the exception of the Pomaceæ and the genus *Rosa*, the fruit is the product of congenital foliar accrescence.

Embryo-sac of Euphorbia.*—N. Dessiatoff has studied the development of the embryo-sac of *Euphorbia virgata*, and finds certain anomalies similar to those found by J. Modilewski in *E. proceræ*. The present paper is a preliminary one, and is to be followed by others dealing with the same subject. The author finds that polarity begins after the first division, and that in subsequent divisions a six-nuclear stage precedes the eight-nuclear stage and a twelve-nuclear stage precedes the sixteen-nuclear stage, owing to delay in division of some of the daughter-nuclei. Not only is this another example of a *Euphorbia* embryo-sac having sixteen nuclei, but the two lateral tetrads of nuclei form cells resembling those of the normal egg-apparatus.

Fruit of Geraniaceæ.†—W. Sorensen has studied the fruits of *Geranium*, *Erodium*, and *Pelargonium*, and is of the opinion that no ordinary botanical term correctly describes them. In *Geranium dissectum*, *G. pusillum*, *G. molle*, and *G. vicinarium* the ovaries are distinct and no septum exists; during maturation the carpels divide vertically to the plan of symmetry into two parts, the ventral part remaining in its place and the dorsal part becoming detached like a valve; nerves or hairs are constricted at the valve. In *Erodium* the valves do not open at the lower end, but dehiscence takes place through the walls themselves. In *Pelargonium* the fruits resemble those of *Geranium*, and there is evidence to show that the central column is formed from the receptacle. It is thus incorrect to describe these fruits as schizocarps having septifragal or septicidal dehiscence. All the above species which shoot out their seeds are provided with a characteristically formed basal spring. Where the seed is not shot out, the opening of the valve may enlarge and allow the loose seed to be shaken out, or it may contract and retain the seed, and the whole thing be distributed by the wind.

* Ber. Deutsch. Bot. Gesell., xxix. (1911) pp. 33-9 (17 figs.).

† Oversigt. k. Danske Vidensk. Selsk. Forhandl., ii. (1911) pp. 99-137.

Physiology.

Nutrition and Growth.

Permeability of the Sheath in Wheat-grains.*—H. Schroeder has investigated the conditions of the permeability of the sheath of wheat-grains, and now publishes an account of his experiments, which are similar to those of A. J. Brown with barley. The chief results are as follows: Solutions of non-permeable substances like sodium chloride retard the absorption of water in proportion to their concentration, but this retardation has no connexion with the cell-contents of the grain, since injured grains do not show the retardation, the results being obtained only where the sheath is uninjured. Peas, which have no selective, permeable membrane, give the same results whether the sheath is injured or uninjured, and are unaffected by change in the concentration of the solution. Aqueous solutions of such substances as Na, NaCl, KCl, KNO₃, MgSO₄, etc., were unable to penetrate the sheath, while solutions of iodine, chloroform, acetone, and other organic compounds were readily absorbed. Similar results were obtained with dead wheat-grains so long as the sheath remained uninjured. The results appear to favour a physico-chemical explanation, and the permeability is apparently connected with a certain damp condition of the membrane which water alone can produce, although in some cases alcohol was found to render non-permeable substances permeable. Under normal conditions of germination the permeability is observed exclusively in the neighbourhood of the embryo, and is in a longitudinal direction parallel to the surface of the grain.

Action of Proteolytic Diastases.†—A. Fernbach and M. Schoen publish a few observations upon the mechanism of the action of proteolytic diastases based upon experiments made with papayotine, pancreatine, and the proteolytic diastase of *Tyrophrix tenuis*, upon such albuminoids as fibrin, casein, "lactocolle" (commercial casein), egg-albumin, and gelatin. The experiments were made in simple aqueous solutions and in solutions containing phosphates, e.g. phosphate of potassium, and it is found that in all cases the activity of the diastase was considerably influenced and accelerated by the presence of the phosphates. The results obtained are entirely in agreement with those previously obtained in connexion with the diastases of malt.

CRYPTOGAMS.

Pteridophyta.

(By A. GEPP, M.A., F.L.S.)

Morphology of *Ophioglossum palmatum*.‡—F. O. Bower publishes some notes on the morphology of *Ophioglossum (Cheiroglossa) palmatum*, the most outstanding type in a remarkable family. It grows on rotting trunks. Fresh material having been obtained on the Blue Mountains of

* Flora, cii. (1911) pp. 186-208 (4 figs.).

† Comptes Rendus Acad. Sci. Paris, cliii. (1911) pp. 133-36.

‡ Ann. of Bot., xxv. (1911) pp. 277-98 (3 pls.).

Jamaica the morphology was investigated. It was found that:—1. The tuberous stock is traversed by a stele showing a bulky central pith and transversely widened leaf-gaps. It is of the same type as *Eu-Ophioglossum*. 2. The leaf-trace originates as two distinct strands inserted widely apart, right and left of the leaf-gap. 3. The spikes, which vary in number, originate like that of *Eu-Ophioglossum*; the lowest usually median, the rest usually intramarginal. The spikes branch frequently and irregularly. 4. The single spike of *Eu-Ophioglossum* appears to be the morphological unit; and the numerous spikes of *Ophioglossum palmatum* are due to "pleiogeny" (a new term invented to denote an increase of organs from a given unit, an increase by branching, interpolation, etc.), and are not directly referable to normal pinnae any more than are the irregular lobes of its sterile lamina. 5. Phyletically *O. pendulum*, *O. intermedium*, and *O. simplex* form a derivative series from *Eu-Ophioglossum*. *Ophioglossum palmatum* represents a parallel, but probably a distinct line, which has carried amplification of the leaf further. The divided leaf-trace which they all show confirms the derivative character of both lines. 6. There is increasing evidence of the alliance of the Ophioglossaceæ with the Filicales—namely in the direction of the Cœnopteridæ and of the Osmundaceæ. 7. The normal spike of *Ophioglossum* on anatomical and other grounds may be held to be ultimately of pinnate nature; perhaps in most cases a result of pinna-fusion, according to the theory of Roeper. But this unit is subject to repetition in *O. palmatum*. 8. The vascular supply to the Ophioglossaceous spike being normally marginal, or from an abaxial pinna-gap, it differs from that to the spore-producing organ in the Psilotaceæ and Sphenophyllaceæ, where it comes off from the adaxial face of the foliar strand, or in the middle region of it. This difference, if it be found to be constant, may provide a real and valid anatomical distinction.

Forms of *Ophioglossum*.*—W. Freiberg publishes notes on some plurispicate forms of *Ophioglossum vulgatum*. He gives new names to three of them and adds some figures. He also cites other examples which have been previously described. He can put forward no reason for the production of these monstrosities.

Origin of Medulla in Ophioglossaceæ.†—F. O. Bower writes on the primary xylem and the origin of medullation in the Ophioglossaceæ. He sums up his observations at some length and draws the general conclusion that the pith in the Ophioglossaceæ is primarily, though not always wholly, of intrastelar origin, and that the pith is, in part at least, intraxyletic in origin.

Medullation in the Pteridophyta.‡—F. O. Bower replies to the views expressed by Jeffrey on the origin of vascular structures. Jeffrey says that "the pith must in all cases be regarded as a derivation of the cortex which has become more or less completely sequestered within the stele." Bower maintains "that there is no rigid law of medullation";

* Allgem. Bot. Zeitschr., xvii. (1911) pp. 81-3 (1 pl.).

† Ann. of Bot., xxv. (1911) pp. 537-53 (2 pls.).

‡ Ann. of Bot., xxv. (1911) pp. 555-74 (1 pl.).

that plants, in accommodating themselves to their surroundings, change their habit and the proportions and attitude of the parts of the shoot. Thus the pith in correspondence with this change may arise from more deeply seated or more superficial sources.

Embedded Antheridia in Pteris.*—M. C. Ferguson describes some instances of embedded antheridia in cultivated prothallia of *Pteris*. A similar abnormality has been observed in *Dryopteris* and *Nephrodium* by C. A. Black.† Ferguson points out a few details in which her examples differ from those of Black. The embedded antheridia may attain a size quite six times that of the normal exerted antheridia. Ferguson describes also some abnormal archegonia containing two egg-cells and two ventral canal-cells lying in the plane of the longer axis of the archegonium. She also calls attention to an instance which she figures of a small archegonium in which the central cell has become developed into what appears to be a sperm-cell.

Xylem Elements of the Pteridophyta.‡—N. Bancroft writes on the xylem elements of the Pteridophyta. She gives the following summary of her work :—1. The xylem elements of Pteridophyta are typically pointed tracheides, the pits on both end and side walls being closed by a membrane formed by the persistent middle lamella. 2. The middle lamella is believed to be exposed in the pit areas by the disintegration of the rest of the primary wall. 3. The varying amounts of disintegration give rise to the prevalence of the "split" or "non-split" appearance between the secondary lignified layers, as seen in transverse section. 4. The width of the split depends largely upon the degree of separation of the secondary layers in the areas surrounding the pit openings.

Development of Stele in Dipteris.§—H. de Bruyn describes the ontogenetic development of the stele in two species of *Dipteris*. Her summary of her work is too long and detailed for quotation. In brief, she finds that :—1. The evolution of the stele is similar in *Dipteris conjugata* and *D. Lobbiana*. 2. The central tissue in middle of xylem at first consists of parenchyma; later sieve-tubes appear and a typical *Lindsaya* stage is reached. 3. Cells with dark contents appear here and there irregularly in the central tissue. They probably represent the beginning of an internal endodermis, but make no connexion with the external endodermis till after the departure of several leaf-traces. 4. Higher up the dark cell-strand is regularly connected with the outer endodermis at the leaf-gaps. Eventually pith-cells appear in the centre of the group of dark cells, and a normal solenostele is formed. 5. The thickening of the xylem on the edges of the leaf-gap occurs in quite young as well as mature plants. 6. A feature in the young plants is the irregularity of development in several of the stelar tissues. 7. The structure of the leaf-traces differs in detail in the two species and indeed in different petioles of the same species.

* Bot. Gaz., li. (1911) pp. 443-8 (2 pls.).

† Bull. Torrey Bot. Club, xxvi. (1909) p. 557.

‡ Ann. of Bot., xxv. (1911) pp. 745-59 (1 pl. and figs.).

§ Ann. of Bot., xxv. (1911) pp. 761-72 (2 pls.).

Anatomy of the Osmundaceæ.*—D. T. Gwynne-Vaughan publishes some remarks on the anatomy of the Osmundaceæ. His summary is as follows. 1. The early appearance of axillary pockets of xylem-sheath parenchyma in the xylem of the sporeling stele of *Osmunda* is confirmed. 2. The intrastelar origin of the pith in the Osmundaceæ is adhered to. 3. The medullary rays are due to the breaking through of the xylem-ring by the xylem-sheath pockets, and are in consequence also intrastelar in origin. 4. The mesarchy found in the basal region of the leaf-trace in *Thamnopteris* and *Zaleskya* is still occasionally retained in the early leaves of *Osmunda regalis*.

Prothallia of Equisetum.†—G. Perrin discusses the prothallia of *Equisetum*. In the Polypodiaceæ the prothallia are much more frequently unisexual and apogamous than is generally indicated. In *Equisetum*, on the other hand, unisexual prothallia are not so general as is commonly supposed; hermaphroditism is frequent enough. The author experimented with *E. sylvaticum*, *E. arvense*, *E. palustre*. The spores do not necessarily lose their germinative faculty within ten days; if kept in a slightly moist atmosphere they are still good after a month. But in dry air they perish quickly. This is due to the thinness of their cell-wall. If they can be kept without unrolling their elaters they retain their power of germination for over a fortnight, even in dry air. After germination the prothallia are mostly unisexual; when male they are digitate, with the antheridia on the ends of their branches. When they are female they are more compact and cordate cushion-like, with the archegonia buried. Frequently these female prothallia show fully developed antheridia on their periphery—rarely in *E. arvense*, frequently in *E. sylvaticum* and *E. palustre*. There is much in common between the spores and prothallia of *Equisetum* and the Polypodiaceæ; in both when the prothallia are unisexual, they are very digitate; and when they are female, or hermaphroditic, they are cordiform. In both cases adventive prothallia can be obtained. External factors have a strong influence over the sex in the two categories.

Life-history of Salvinia natans.‡—K. Yasui gives an account of the life-history of *Salvinia natans*, with the following conclusions: 1. The primary tapetum-cells of both sporangia are formed by division of the archesporial cell, and they again divide into one layer of many cells. 2. The spore-mother-cells are eight in the macrosporangium and sixteen in microsporangium. 3. The number of chromosomes of the spore-mother-cell is sixteen and the reduced number in the spore is eight. 4. During the reduction-division the tapetum-cells begin to degenerate and nourish the spores. 5. Sixty-four mature spores are formed in a microsporangium, but in a macrosporangium only one spore becomes mature. 6. The male prothallium consists of a large prothallium-cell, a small root-cell, two sterile cells, and two antheridia, which consists of a wall-cell and a central cell. The central cell divides twice, and in each of the four cells a spermatozoid is formed. 7. The

* Ann. of Bot., xxv. (1911) pp. 525-36 (1 pl. and figs.).

† Comptes Rendus Acad. Sci. Paris, cliii. (1911) pp. 197-99..

‡ Ann. of Bot., xxv. (1911) pp. 469-83 (3 pls.).

statement of Campbell, who denies the presence of a sterile cell between the two antheridia and the root-cell, was not confirmed, in agreement with the investigation of Belajeff. Belajeff was not clear about the time of the appearance of the root-cell. It has been determined by the present study that the root-cell is formed as a result of the second division of the germinating microspore. 8. The spermatozoid is a spirally coiled body having numerous cilia at the anterior end, and a large vesicle at the posterior end. 9. A blepharoplast, which first appears in the cytoplasm, and later elongates towards the nucleus, was observed in each sperm-cell. 10. Three to five archegonia are usually formed in each female prothallium, and each archegonium consists of one egg-cell, a ventral canal-cell, a neck canal-cell with two nuclei, and the neck-cells. 11. Only one spermatozoid enters into the egg-cell. After the penetration of the spermatozoid into the egg-nucleus there appears in the cavity of the latter a nucleolus-like body, derived very likely from the spermatozoid, and somewhat smaller than the nucleolus. 12. The four quadrants are clearly distinguishable in the young embryo. The development of the root-quadrant ceases at an early stage, and later its tissue cannot be distinguished from that of the foot.

Spore-distribution in *Selaginella*.*—F. W. Neger discusses the question of spore-distribution in *Selaginella helvetica* and *S. spinulosa*, its meaning, mechanism, etc. He confirms all that Goebel had discovered as to the macrospores being liberated spontaneously by the dehiscence of the sporangial wall, and as to their dissemination preceding that of the microspores; also as to the more rapid germination of the microspores. Neger finds, however, that in some cases the microsporangia of the apex of the spike open first, then follow the macrosporangia below, and finally the microsporangia at the base. Thus there are always microspores ready to germinate when the macrospores are ready for them; and cross-fertilization is favoured. He notices in the dorsiventral fertile spikes of *S. helvetica* that the macrosporangia are principally on the ventral side and the microsporangia on the dorsal. He attributes this to the better nutrition of the ventral side.

Lyginodendron (*Crossothea*) in Irish Coal Measures.†—T. Johnson gives a résumé of the literature on *Lyginodendron oldhamium*, *Rachiopteris aspera*, *Sphenopteris Hönighausi*, and *Kaloxylon Hookeri*, all vegetative parts of one fossil type, the reproductive organs of which are represented by *Crossothea Hönighausi*, *Lagenostoma Lomaxi*, and *Calymmatothea*. Johnson found specimens in the Dublin Museum which add confirmatory evidence, and he describes and figures them. His conclusions are as follows: 1. The Pteridospermeæ flourished in Ireland. 2. The Museum specimens confirm the view that *Sphenopteris Hönighausi* is really the foliage of the Pteridosperm *Lyginodendron oldhamium* Will. (*Crossothea Hönighausi* Kidst.). 3. *Calymmatothea Sturieri* Stur. occurs in continuity with *Sphenopteris Hönighausi*, and is simply the de-seminated fertile frond of this type. 4. In the Glen-geole Coal Measures, Co. Tipperary, a seed impression attached to the

* Flora, ciii. (1911) pp. 74-7 (1 fig.).

† Sci. Proc. Roy. Dublin Soc., xiii. (1911) pp. 1-11 (2 pls.).

parent plant and surrounded by radiating cupular lobes has been found. 5. This seed has the characters of a *Lagenostoma* seed, is 6 by 2 mm., radiospermic, elliptic, and apparently ridged. 6. The *Sphenopteris spinosa* condition shows that the cupular lobes are modified foliar segments, as is apparently the ovuliferous body. 7. The male (*Crossotheca*) and female (*Calymmatotheca*) conditions are foliar in nature, and present many features in common.

American Lepidostrobus.*—J. M. Coulter and W. J. G. Land describe and figure a *Lepidostrobus* from Coal Measures in Iowa, the first example yet found in America. The specimen is not a complete cone, but a fragment from near the upper end. It had evidently soaked in water before becoming fossilized; rootlets had penetrated between the sporophylls, and had become attacked by a fungus. The sporangia are empty, but loose spores abound. The authors give a detailed account of the structure of the specimen.

Some Mesozoic Ferns and their Leaf-scars.†—F. Pelourde publishes some remarks upon the structure of certain mesozoic ferns. From a comparison of living and extinct forms he arrives at conclusions which he summarizes as follows. In the families of the Osmundaceæ and Dipteridinea, which were both very important during the secondary epoch, the roots and petioles show in their anatomy a certain number of characters which are concordant and more or less aberrant. The structure of the conducting tissue of the fronds is particularly interesting in *Dipteris conjugata*. As shown in the body of the paper, this tissue exhibits in a transverse section at the base of the petioles and in a section made a little way above, two very different aspects. In fossil types of a similar kind the vessels of the leaf-scars could consequently exhibit variations of form according to the level at which the fronds may have been detached from the stem. And a proper appreciation of this variation might perhaps serve to prevent erroneous confusions and illusory distinctions.

Spores of Spencerites.‡—B. Kubart is investigating the fossil flora of the Ostrau-Karwin Coal Measures, and gives a description of the spores of *Spencerites membranaceus*, a new species of a Lepidophyte genus. He obtained 200 spores from the Lower Carboniferous. In England the genus was found in the Upper Carboniferous.

Archæopteris.§—T. Johnson discusses the question "Is *Archæopteris* a Pteridosperm?" He sums up the characteristics of the plant as follows: 1. The "fern-like" bipinnate type of frond occurs commonly in Pteridosperms and in ferns. 2. The same may be said of dichotomy of fronds and pinnae. 3. And also of aphlebioid pinnules. 4. The stipules are like those of *Angiopteris*, but become detached with the frond; in the Marattiaceæ on the other hand the stipules remain

* Bot. Gaz., li. (1911) pp. 449-53 (2 pls. and figs.).

† Ann. Sci. Nat. (Bot.) ser. 9, xiv. (1911) pp. 80-95 (figs.).

‡ Denkschr. Math. Nat. Kl. Kais.-erl. Akad. Wien, lxxxv. (1909) pp. 83-99 (1 pl. and figs.).

§ Sci. Proc. Roy. Dublin Soc., xiii. (1911) pp. 114-36 (2 pls.).

attached to the leaf-base on the parent plant. Stipules are known in the Cycadeæ. 5. The dichotomy of the veins and the absence of a midrib in the pinnules indicate a primitive type. The vegetative organs thus do not afford much help. 6. The fertile frond, partly vegetative, partly reproductive, is comparable to that of Osmundaceæ, Ophioglossaceæ, and *Azolla*. Nothing like *Archæopteris* is at present known in the Pteridosperms. 7. The lobed sporophyllule of *Archæopteris* suggests affinity rather with *Sphenophyllum* and *Ophioglossum* than with a Pteridosperm. The sporangium of the great majority of living Pteridophyta is evascular. In the Ophioglossaceæ and in the extinct Botryopterideæ (e.g. *Zygopteris*) the sporangium is vascular. In this respect *Archæopteris* is comparable with Ophioglossaceæ. The microsporangia of a Pteridosperm are also in a sense vascular. 8. The sporangium of *Archæopteris* is apparently divided by transverse septa into a series of superposed loculi comparable to one half of a small "sporangiferous spike" of an *Ophioglossum*. No such shape of microsporangium is known in any Pteridosperm; but in living Angiosperms many genera possess pollen-sacs made multilocular by horizontal partitions. 9. *Archæopteris* is known from several localities in Europe, Asia, North America, and the Arctic regions. In no locality have seed-like bodies been found connected directly or indirectly with the plant. These localities have not, however, been exhaustively searched for *Archæopteris*, nor since the Pteridospermeæ were founded. 10. *Archæopteris* occurs in the upper Devonian and Culm rocks; the Pteridosperms are known well-developed forms from the Culm or Lower Carboniferous. The ferns are represented in the Carboniferous by the Botryopterideæ. The author is inclined to regard *Archæopteris* as an ancestral form of the Ophioglossaceæ, until further evidence is forthcoming.

The same author* gives an account of *Archæopteris Tschermaki* and other species of the genus found in Ireland.

Distribution of *Equisetum maximum*.†—A. Verhulst gives an account of the distribution of *Equisetum maximum* on slopes along the upper margin of the Marl (Marne de Grancourt) just where it is covered by a thin layer of Jurassic Limestone (Calcaire de Longwy), along the Franco-Belgian frontier. It is along this zone that the plant finds exactly that underground store of moisture which it requires; and there it grows in abundance, sometimes associated with *Sedum purpureum* and *Sambucus ebulus*. And it is useless to search for it in other situations.

***Asplenium Guichardii*.**‡—R. de Litardière gives a description of a new hybrid, *Asplenium Guichardii*, the parents of which are *A. foresiacum* and *A. trichomanis*, the former being the preponderant element. It is found in the department of Hérault, where also grows *A. Pagesii*, a hybrid of the same parents but with a preponderance of *A. trichomanis*. This latter hybrid was described by Litardière last year. He adds some critical notes on the variability of *A. foresiacum*.

* Sci. Proc. Roy. Dublin Soc., xiii. (1911) pp. 137-41 (2 pls.).

† Bull. Soc. Roy. Bot. Belg., xlvii. (1911) pp. 285-90 (map).

‡ Bull. Géogr. Bot., xxi. (1911) pp. 75-7.

Woodwardia radicans in Italy.*—R. Pampanini gives an account of the distribution of *Woodwardia radicans* and some other ferns in Italy. It is recorded that P. A. Micheli found this species at Ferrara in 1710. That is an error. Micheli found it at Ferriera, in the Valle di Amalfi; he also found it at Ischia, and at Casamicciola in the Vallone dei Bagni. It was re-found at the first station in 1868 by Nevile Reid and Lacaita, at the second in 1831 by Gussone. Micheli has the credit of being the first to find also *Pteris longifolia* in Italy, namely with *Woodwardia radicans* in the Valle di Amalfi. Other records by Micheli, namely *Pteris cretica* near Sorrento, *Scolopendrium Hemionitis* in the Tuscan Archipelago, etc., have been confirmed. But his *Asplenium fontanum* near Sorrento is doubtful, and may be one of three other ferns. His *A. obovatum* in the island of Gorgona is correct.

Ferns of Schleswig-Holstein.†—P. Junge publishes a detailed account of the Pteridophytes of Schleswig-Holstein, of which there are but 40 species, whereas there are 500 hybrids and monstrosities. He also discusses the migrant groups, distribution groups, etc.

Pteridophytes of Libya.‡—E. Durand and G. Barratte give a list of five ferns and an *Equisetum* recorded for Tripoli and Cyrenaica, with the distribution and synonymy of the species.

North American Pteridophytes.—E. J. Hill§ publishes some notes on *Lycopodium porophyllum* and its habitats in the dells of Wisconsin. He shows that it is undoubtedly distinct from *L. lucidulum*.

W. N. Clute|| gives a figure and description of *Asplenium Andrewsii* Nels., a Colorado fern, which may perhaps prove to be conspecific with *A. Bradleyi*.

A. B. Klugh¶ publishes notes on the Pteridophyta of southern New Brunswick, where the special feature is the abundance of *Lycopodium*. He enumerates eighteen ferns and fourteen fern-allies.

W. N. Clute** describes and figures *Dicksonia pilosiuscula* f. *Poyseri*, a beautiful fern found in Maine in 1907 by H. W. Merrill.

A. Prescott †† writes about the oak and beech ferns and their habits.

W. N. Clute ††† discusses the perplexing forms of *Botrychium*, and especially the question of *B. simplex*, the rarity of which has caused much misunderstanding. Some authors have mistaken it for young plants of *B. matricariæfolium*. He cites some remarks by H. Woynar, and figures some Tyrolese forms of *B. simplex*.

F. C. Greene §§ publishes notes on the ferns of north-western Missouri, a disappointing district which hitherto has yielded but eight species.

* Nov. Giorn. Bot. Ital., xviii. (1911) pp. 225-42.

† Jahrb. Hamburg. Wiss. Anstalt, xxxii. (1910) pp. 47-245 (21 figs.).

‡ Floræ Libyæ Prodrômus. Genève: Romet, 1910, pp. 281-2.

§ Fern Bull., xix. (1911) pp. 1-3.

¶ Fern Bull., xix. (1911) pp. 3-4 (1 pl.).

|| Fern Bull., xix. (1911) pp. 4-7.

** Fern Bull., xix. (1911) pp. 7-8 (fig.).

†† Fern Bull., xix. (1911) pp. 9-11.

††† Fern Bull., xix. (1911) pp. 11-14 (fig.).

§§ Fern Bull., xix. (1911) pp. 14-15.

W. N. Clute* has collected under the title Pteridographia a variety of notes on New York ferns. Classification-systems for *Nephrolepis*. The Virtues of Polypody. Hybrid ferns. *Nephrolepis Dreyerii*, *N. Marshalli*.

S. F. Blake† publishes notes on some Pteridophytes from eastern Massachusetts. Winter occurrences of *Woodsia obtusa* were noted in March 1909; they are rare in the region. Many winter specimens of *Dicksonia punctilobula* were also found in sheltered situations. The fresh green appearance of small fronds suggested that growth had occurred on favourable days during winter. It is probable that *Botrychium obliquum* var. *ovoidense* is fairly well distributed in eastern Massachusetts, but is often mistaken for *B. ternatum* var. *intermedium*, with which it seems to intergrade. *Lycopodium clavatum* var. *megastachyon*, a recently described variety, occurs in east as well as in west Massachusetts and in New Hampshire.

W. H. Blanchard‡ gives a description of *Lycopodium flabelliforme*, a new species raised from varietal rank; and he adduces a number of reasons as to why it is a good species. It can no longer be regarded as a variety of *L. complanatum*, being more distinct from that species than is *L. tristachyum*. It differs in habit, method of growth, and other characters. The specimens described came from Caribou, Maine.

Ferns of the Falkland Islands.§—C. H. Wright, in giving an account of the flora of the Falkland Islands, includes a list of thirteen ferns gathered by Vallentin and others.

Chinese Ferns.||—C. G. Matthew gives an alphabetical enumeration of Chinese ferns, containing nearly 1100 entries with citations, distribution, and, where necessary, some synonyms. The system of nomenclature is that of Diels and of Christensen.

R. Pampanini,¶ in a supplementary enumeration of the vascular plants collected by the Rev. P. C. Silvestre in Hu-peh during the years 1904-7, gives a list of forty-two Pteridophytes, with their localities, altitudes, etc.

Ferns of Corea and Quelpaert.**—C. Christensen gives a list of thirty-eight ferns collected in Quelpaert Island by P. Taquet in 1910, and adds a few descriptions and critical notes. In a supplement eight ferns new to Corea are recorded.

Ferns of Annam.††—H. Christ describes *Drymoglossum cordatum*, a new fern collected in Annam by Cadière, and preserved in the Paris Museum.

* Fern Bull., xix. (1911) pp. 15-19.

† Rhodora, xiii. (1911) pp. 101-3.

‡ Rhodora, xiii. (1911) pp. 168-71.

§ Journ. Linn. Soc., xxxix. (1911) pp. 313-39.

|| Journ. Linn. Soc., xxxix. (1911) pp. 339-93.

¶ Nuov. Giorn. Bot. Ital., xviii. (1911) pp. 161-5.

** Bull. Géogr. Bot., xxi. (1911) pp. 69-72.

†† Notule Systematicæ. Paris: i. (1911) pp. 375-6.

Bryophyta.

(By A. GEPP.)

Branch-formation in Mosses.*—K. von Schoenau has studied the ramification of mosses. He finds that : 1. The resting branch-rudiments can produce shoots which are biologically equivalent to the main axis ; they give rise to innovations. 2. Their development is suppressed until the main axis is prevented from further growth. 3. In regeneration development takes place preferably in the apical rudiments, which therefore replace the lost apex and produce a false dichotomy. Otherwise the rudiments which develop are those in the best nourished condition. 4. The most potent factor in the development of lateral axes is light. 5. Another necessity is damp. 6. The form is mostly determined by external influences. 7. The direction of growth is mainly determined by light and damp. Geotropism plays a very small part. 8. Dorsiventrality is caused by light, but to some degree is inherited. 9. The position of the lateral axis in relation to the main axis is due to two causes : (a) the position of the rudiment in the basal portion of the leaf-forming segment ; (b) the torsion, either arising during normal growth of the shoot (*Fontinalis*), or originating in the growing point (*Mnium*, *Sphagnum*). 10. There is no sheath, such as Servit has described, at base of the lateral branches. The position of the primary leaves at the base of the branch is due to the mode of growth of the side bud. 11. There is no leaf-trace bundle, such as described for all mosses by Bastit, passing from the central cylinder into the branch, except in the branched Polytrichaceæ.

Sexuality among the Mosses.†—Ém. Marchal gives a résumé of two sets of new facts ascertained by his father (Él. Marchal) and himself since 1904 during a course of research in the sexuality of the mosses. 1. First, as to the sexualization of the spores. In a dioicous moss, such as *Bryum caespiticium*, the spores are, as they have previously shown, half of them male, half of them female—two being male and two female in each tetrad. Each male spore, for instance, produces a protonema which bears only male plants ; and each female spore, female plants only. This is a fact which systematists have not yet grasped. In the dioicous moss the spores and gametophytes are polarized sexually, and only the sporophyte is bisexual. In the monoicous moss, for example *Amblystegium serpens*, the sexual polarization appears only during the formation of antheridia and archegonia. Incidentally the author notes that *Funaria hygrometrica* is not dioicous, despite assertions to the contrary. 2. The second question raised is that of the possible intervention of apospory. In the case of the dioicous *Bryum caespiticium* it is possible to obtain by very careful cultivation from the cell-walls of the unripe capsule a protonema which produces synoicous gametophyte plants. They are, however, sterile—incapable of fertilization. On the other hand, the monoicous *Amblystegium serpens* readily yields regenerations from its capsule, and the aposporic protonema thus obtained is vigorous and produces normal fertile plants, from which arise

* Hedwigia, li. (1911) pp. 1-56 (29 figs.).

† Bull. Soc. Roy. Bot. Belg., xlvii. (1911) pp. 277-85.

numerous sporophytes. These sporophytes are noteworthy in that they are the product of the union of two diploidic elements. They are in fact tetraploidic plants. The number of chromosomes in the nuclei of the archesporial tissue is four times that of the sexiferous phase in the normal plant. And in the resulting spores this number is reduced to $2n$. Further, by regeneration the tetraploid capsules yield a protoneura which produces weak flowering shoots, hitherto incapable of fertilization, so far as experimentation has gone. Thus there is an essential difference between dioicous and monoicous mosses. The diploidic races obtained from the former have abnormal flowers, which are bisexual but sterile, and can only be reproduced vegetatively. On the other hand, the diploidic races obtained from monoicous mosses have normal sexuality and can be reproduced by sporogenesis. The reproduction of aposporic forms is of great interest to systematic bryologists. For if, as the result of wounds, such forms are frequent in nature, it may become possible to explain the polygamy found in some species of *Bryum*, and sterility in some dioicous species. The diploidic state reveals itself in a notable increase in the size of the cells, the nuclei, and the reproductive organs.

Spermatogenesis in certain Hepaticæ.*—W. L. Woodburn gives the results of his investigations of spermatogenesis in certain hepatics. He finds no evidence of the occurrence of centrosomes in the spermatogenous tissue of *Porella* and *Asterella*, or of *Marchantia* and *Fegatella*. In his preparations he could find nothing such as Van Hook observed in the dividing vegetative cells of *Marchantia*, Mottier in *Dirtyota*, Farmer in the germinating spores of *Fegatella* and *Pellia*, and Farmer and Reeves in *Pellia*. Further, there is no evidence that the centrosome persists in the resulting sperm-cell. The occurrence of such a body sometimes at the pole of the spindle does not necessarily imply more than a probable concentration of cytoplasmic or kinoplasmic materials. The development of the blepharoplast in all these plants proceeds from a dense granular mass of cytoplasm located in the most distant angle of the sperm-cell. The blepharoplast becomes a cord, growing in close contact with the plasma membrane and entirely past the nucleus. The latter then draws out along the posterior portion of the blepharoplast and may extend beyond it, while from near the forward and slightly enlarged end two cilia develop. Ikeno's "cytoplasmatischer Fortsatz" is probably merely a part of the blepharoplast. No body corresponding in size and appearance to the "Nebenkörper" of Ikeno was found. Whereas some authors regard the mature sperm as representing three metamorphosed elements of the cell (nucleus, cytoplasm, and blepharoplast or centrosome), the author prefers to hold the view that the blepharoplast in *Porella*, *Marchantia*, and *Fegatella*, where no centrosome exists, arises de novo in the cell in which it is to function as the cilia-bearer. This is in keeping with the views of Escoyer and Mottier. The mature sperm represents in its head the nucleus, in its blepharoplast and cilia the specialized parts of the cytoplasm, the remainder of the latter being found in the cytoplasmic vesicle.

* Ann. of Bot., xxv. (1911) pp. 299-313 (1 pl.).

Spermatogenesis in the Bryophyta.*—M. Wilson gives an account of spermatogenesis in the Bryophyta, with the following conclusions. 1. In *Mnium hornum* and *Atrichum undulatum* the divisions of the spermatogenic cells are normal, and no centrosomes are present. The final division is not of the diagonal type which is found in several of the hepaticæ. No reduction in the number of the chromosomes takes place at the final mitosis. 2. In *Pellia epiphylla* centrospheres and probably centrosomes are present during the later divisions in the antheridium. The blepharoplast is probably derived directly from the centrosome. 3. In the spermatid of *Mnium hornum* a number of bodies become separated from the nucleolus. These pass into the cytoplasm and there give rise to a number of rod-like structures, which by coalescence finally form a hollow spherical body, for which the name "limosphere" is suggested. The nucleolus then divides into two masses, which both pass into the cytoplasm: one of these functions as the blepharoplast, while the other gives rise to the accessory body. 4. In the spermatid of *Atrichum undulatum* three bodies are separated from the nucleolus and pass into the cytoplasm. The body first produced functions as the blepharoplast. The limosphere arises from one of the remaining bodies, while the other gives rise to the accessory body. 5. In *Pellia epiphylla* a limosphere and accessory body are present in the cytoplasm of the spermatid. Their origin was not determined. 6. In all of the three plants under consideration the blepharoplast passes to the periphery of the spermatid. A thread-like structure is produced in connexion with the blepharoplast, which passes along the inner contour of the cell membrane. The nucleus passes to the periphery and lies in contact with the thread. Elongation takes place in the nucleus, and the latter, together with the thread, produces the entire body of the spermatozoid. The limosphere and accessory body persist in the almost mature spermatozoid, and in all probability are found ultimately in the vesicle.

Mosses attacked by Cladosporium.—I. Györfy† gives an account of some Hungarian specimens of *Burbaunia viridis* which were attacked by a fungus, identified as *Cladosporium herbarum* by L. Hollos. The fungus densely permeates the interior of the capsule and forms stellate spots on the outside. The measurements do not appear to correspond with those of *C. epibryum* Cooke and Masee.

E. G. Britton,‡ in reference to the above, gives a list of the eight mosses upon which Cooke and Masee found *C. epibryum*, all American species sent by her to those authors for examination.

Nomenclature of Sphagnaceæ.§—C. Warnstorff publishes a detailed reply to the suggestions advanced by J. Röhl in favour of alterations of and additions to the Vienna code as regards the nomenclature of Sphagnaceæ. Warnstorff, holding orthodox views, protests energetically against the views expressed by Röhl as to the limitation of species and the grouping of forms.

* Ann. of Bot., xxv. (1911) pp. 415-57 (2 pls.).

† Bryologist, xiv. (1911) pp. 41-3 (1 pl.).

‡ Mycologia, iii. (1911) p. 206.

§ Verh. Bot. Ver. Prov. Brandenburg, lii. (1910) pp. 22-33.

Philonotis revised by Dismier.*—E. G. Britton makes some critical remarks on G. Dismier's † revision of the American species of *Philonotis*, and cites some eleven American species which he has not included in his work. Out of seventy-four species recorded for America, Dismier has reduced forty to synonyms. Authors in the past have been too free in the creation of species.

E. B. Chamberlain ‡ gives a translated résumé of Dismier's revision, giving the key to the twenty-five species in full, and a synoptic account of the twelve North American species, with the addition of synonyms and descriptive notes.

Hypophilopsis, a New Indian Moss-genus.§—H. N. Dixon gives an account of some thirty Indian mosses from the districts of Poona, Mysore, the eastern Himalayas, and Assam. Among them is *Hypophilopsis*, a new genus of Pottiaceæ, with fruiting characters very near to those of *Hypophila*, but with the leaf-areolation of a *Pottia*. The leaf-cells, moreover, are seriatly papillate. It contains one new species. Critical notes are appended to several of the plants recorded; and in all five new species are described and figured.

Wollnya, a Genus of Bryaceæ.||—T. Herzog gives an account of *Wollnya*, a recently published genus of mosses related to *Leptobryum*. He enlarges the genus by including in it *Bryum Wilsoni* Mitt., an Andine species. The type of the genus is *W. stellata* Herz. The author figures both species, and now fixes definitely the position of *Wollnya* among the Bryeæ. It differs from *Leptobryum* principally in leaf-structure.

Swartzia inclinata in Lancashire.¶—J. A. Wheldon notes the similarity of the Lancashire sand-dunes to those of Tent's Muir and Barrie on the east coast of Scotland, and states that chance alone is insufficient to account for the presence, in areas so widely separated, of such rarities as *Bryum Marrattii*, *B. calophyllum*, *B. Warneum*, *B. neodanense*, *Catocopium nigratum*, *Hypnum Wilsoni*, *H. lycopodioides*. To these may now be added *Swartzia inclinata*, recently found well established near Freshfield. It had previously been recorded for an inland situation in south Lancashire, and caused some speculation as to its origin.

Notes on Grimmia.**—P. Culmann publishes notes on some species of *Grimmia*. He gives a description and figure of *G. tergestinoides*, a novelty which, if not a sub-species of *G. tergestina*, is a remarkable variety, found in the Swiss Jura. The allied species *G. poecilostoma* Cardot, must, it is found, assume the prior name of *G. Carloti* Héribaud. Culmann agrees with Bredler and Hagen that *G. sessitana* and *G. subulcata* belong to one and the same species, but does not accept Hagen's

* Bryologist, xiv. (1911) pp. 43-4.

† Bull. Soc. Bot. France, x. (1910), Mém. 17, pp. 17-37.

‡ Bryologist, xiv. (1911) pp. 44-52.

§ Journ. of Bot., xlix. (1911) pp. 137-50 (1 pl.).

¶ Beih. Bot. Centralbl., xxviii. 2^{te} Abt. (1911) pp. 268-71 (1 pl.).

** Journ. of Bot., xlix. (1911) pp. 274-5.

*** Rev. Bryolog., xxxviii. (1911) pp. 75-8 (fig.).

view that *G. alpestris* belongs to the same species. He records with interest the occurrence of *G. atrata* in the Western Alps—namely, in the Graian Alps, thus linking up the stations of the Eastern Alps with those of the Pyrenees.

Tomenthypnum, a new genus.*—L. Loeske creates a new genus for the reception of *Camptothecium nitens* Schimp., a species which has never been happily placed. He gives its history, and compares it with *C. lutescens* and *Homalothecium Philippeanum*. It is partly on ecological grounds that he establishes the new genus *Tomenthypnum*.

Drepanocladus.†—J. Zodda gives a description of a new variety of *Drepanocladus Kneiffii* from Sardinia. It is called var. *sardous*, and differs from var. *larus* Schimp. in having a much more robust habit, larger leaves, etc. It may prove indeed, when known in the fertile state, to be a new species.

Goebeliella, a new genus.‡—F. Stephani gives a description and figures of *Goebeliella*, a new genus of hepaticæ, including two species from New Zealand and New Caledonia respectively. It has the vegetative habit of *Frullania*, save that the lobulus of the leaf is bisected to base into two equal divergent long narrow hooked obtuse segments, and is accompanied by no stylus. The perianth also is peculiar, being cylindrical triplicate with a squarely truncate entire mouth. *G. cornigera*, gathered in New Zealand fifty years ago, was referred to *Frullania* by Mitten. Fertile material is described now for the first time.

New Variety of Lophozia Schultzii.§—W. H. Burrell gives an account of *Lophozia Schultzii* var. *laxa*, a new variety of hepatic found by him at Flordon, Norfolk, in July 1909. It belongs to K. Müller's subgenus *Leiocolea*, and was at first assumed to be *Lophozia Mülleri* Dum. But V. Schiffner found it to be paroicous, placed it in *L. Schultzii*, and suggested the varietal name *laxa*. Kaalaas also examined it, and came to much the same conclusion. Burrell describes the plant and carefully contrasts it with the type, and adds some ecological and distributional notes.

Dichiton calyculatum in Croatia.||—A. von Degen records the discovery of *Dichiton calyculatum* in Croatia. Originally gathered in Africa half a century ago, it has in recent years been detected in the south of France, then in the Austrian coast-lands, and in Elba and Sicily. It has now been found in tufts of *Plagiogchila asplenioides* at an altitude of about 2000 ft. on the Sinjal Mountain in Croatia. The plant is extremely minute, and for this reason has probably eluded observation.

Fossombronia echinata.¶—S. M. Macvicar publishes a description of a new species of *Fossombronia* found in Algeria, Dalmatia, and Italy,

* Deutsch. Bot. Monatschr., xxii. (1911) pp. 82-3.

† Rev. Bryolog., xxxviii. (1911) pp. 89-90.

‡ Hedwigia, li. (1911) pp. 61-4 (figs.).

§ Journ. of Bot., xlix. (1911) pp. 217-19.

¶ Magyar Bot. Lapok, x. (1911) pp. 244-5.

¶ Rev. Bryolog., xxxviii. (1911) pp. 73-5 (1 pl.).

and distinguished from *F. cæspitiformis* by having smaller spores covered by shorter, more abundant, acute papillae. Another species, *F. Müntzii*, is closely allied, but has larger spores covered by broader, more compressed, truncate papillae. The author holds that *F. verrucosa* Lindb. is not a true species, but an undeveloped state of *F. cæspitiformis*, in company with which it always occurs.

Critical European Mosses.*—E. Bauer publishes some important criticisms of *Seligeria brevifolia*, *Anoetangium Hornschuchianum*, *Dicranum fuscescens*, *Dicranodontium subfalcatum*, *Ditrichum julifolium*, recently issued in exsiccata.

British Muscineæ.—W. H. Burrell† and W. G. Clark publish some notes on the moss-flora and rarer flowering plants of West Norfolk. Fourteen species of *Sphagnum* were found; the genus is, however, but scantily distributed. Some interesting mosses are noted, and the rare hepatic *Sphærocarpus terrestris* has been found in more than fifty parishes. *Mörckia* also is a Norfolk hepatic. It would seem that not *Sphagnum* but *Hypnum stellatum* and *H. scorpioides* afford the association upon which *Malaris* is epiphytic; and the same may apply to *Liparis*.

R. Jackett‡ gives a list of 38 hepatics and 145 mosses gathered by him on the banks of the Rheidol, the Mynach, and the Turn in August 1907. He states that 10 hepatics and 17 mosses are new records for the county of Cardigan.

E. A. Richards§ publishes some short notes upon mosses collected by him in South Aberdeen during July 1910. The mosses are nineteen in number and were found on hills and in glens near Ballater and Braemar; they are additions to the county flora. Among them is *Philonotis tomentella*, recently split off from *P. fontana* by Loeske.

Moss-flora of Haute-Saône.||—A. Coppey publishes a further instalment of his phytogeographic studies on the mosses of the Haute-Saône, and gives records of fifty-six species, mostly Grimmieæ and Orthotricheæ.

Belgian Bryophytes.¶—A. Cornet gives a list of habitats of rare bryophytes in Belgium, comprising thirty-six mosses and nineteen hepatics, interspersed with some critical notes.

Moss-flora of Rhine-land.**—H. Broekhausen gives a sketch of the moss-flora of Rhine-land, and records as new to the district *Ditrichum julifolium*. The limits of *Eurhynchium atrovirens* (= *Swartzii*) and *E. hians* in relation to *E. prælongum* have still to be worked out critically.

Mosses of the Erzgebirge.††—J. Röhl publishes a second contribution to the moss-flora of the Erzgebirge, mainly devoted to the Sphagnaceæ. In five short lists he indicates the moss-floras characteristic of certain

* Deutsch. Bot. Monatschr., xxii. (1911) pp. 97-102.

† Journ. of Bot., xlix. (1911) pp. 267-70.

‡ Journ. of Bot., xlix. (1911) pp. 230-2.

§ Journ. of Bot., xlix. (1911) pp. 232-3.

|| Rev. Bryolog., xxxviii. (1911) pp. 90-3.

¶ Bull. Soc. Roy. Bot. Belg., xlvii. (1911) pp. 291-6.

** 38 Jahresber. Westfal. Prov.-Verein. Münster (1910) pp. 93-101.

†† Hedwigia, li. (1911) pp. 65-112.

districts, followed by a general synopsis of the mosses other than *Sphagnum*. He sets forth his views on the nomenclature of the Sphagnaceae and on the proper classification of the innumerable forms and intermediates. He follows Schliephacke in dividing the species into six groups; and under these groups he details the species, varieties and forms, interspersed with notes.

Moss-flora of Bernina.*—T. Herzog contributes a chapter on moss-formations to E. Rübel's monograph on the plant-geography of the Bernina Alps. He discusses the different types of habitat and the mosses found thereon. One remarkable fact is the entire absence of mosses on the tree-trunks, which, however, are covered with lichens. He describes some half a dozen new varieties or forms and a new species.

Mosses of Tirol.—C. Trautmann publishes a contribution to the moss-flora of Tirol, comprising a list of fifty six species gathered chiefly in the region of the Ortler during the month of July in 1909 and 1910. The most interesting species is *Orthotrichum perforatum*, of which he found two forms markedly different in the degree of development of the peristome.

Hungarian Mosses.†—I. Györfy gives an enumeration of the Sphagnaceae gathered by him in the Hohen-Tatra in 1910 and determined by C. Warnstorf. The list includes eleven species and twenty-eight varieties and forms, with their stations, altitudes, etc. *S. imbricatum* is a new record for Hungary.

The same author‡ publishes notes on the localities where fruiting specimens of *Plagiobryum demissum* and *Amphidium lapponicum* have been found on the Hohen-Tatra.

Moss-flora of Bulgaria.‖—J. Podpera, in giving an account of the cryptogamic flora of the Bulgarian Alps, discusses the distribution and ecology of the Bryophytes, and gives an enumeration of all the species found. Some 6000 specimens were examined and yielded 258 species of mosses and thirty-eight of hepatics, and numerous varieties and forms, interspersed with critical notes. The interest of this moss-flora is that it forms a link between the alpine floras of Europe and Asia.

Crimean Mosses.—A. A. Sapelin¶ gives a résumé in German of the first part of his Russian paper** on the ecological, geographical, and floristic aspect of the mosses of the Crimean mountains. He discusses the influence of the climatic and edaphic factors upon the occurrence and adaptability of the mosses of the district. He holds that the principal function of the hairs and papillae of the mosses is to scatter the radiant energy of the sun. He divides the species into xerophytes and hygrophytes, not according to their structure, but according to the nature of their habit.

* Engler's Bot. Jahrb., xvii. (1911) pp. 235-50.

† Hedwigia, li. (1911) pp. 57-60.

‡ Magyar Bot. Lapok, x. (1911) pp. 204-14.

§ Magyar Bot. Lapok, x. (1911) pp. 246-8.

Beih. Bot. Centralbl., xxviii. 2^o Abt. (1911) pp. 173-224.

¶ Engl. Bot. Jahrb., xlv. (1911) Beibl. pp. 62-83.

** Sapiski Novoross. Obsc. Estestv., 1910.

L. Loeske,² in commenting upon the above, points out that the meaning of xerophyte and hygrophyte is unsatisfactory when applied to mosses, and he proposes the use of combined terms, such as sciophil xerophyte and hygrophil xerophyte, where the adjective refers to the habitat, and the substantive refers to the structure of the moss. For instance, *Mnium spinosum* is a sciophil xerophyte.

A. A. Sapchin † publishes the second part of his paper cited above, and gives therein an account of the floristic bryogeography of the Crimean mountains; first some general remarks on the district, and then an enumeration of all the 195 species with notes on their distribution and ecological characteristics. Four species and several varieties and forms are new. He adds a chapter on the origin of the Crimean moss-flora. He finds that 170 of the species are middle European, eight are Alpine, and seventeen are Mediterranean.

The same writer ‡ also publishes, in Russian, some keys to the Crimean mosses, founded almost exclusively upon the anatomical and morphological characters of the gametophyte, since more than half the species are sterile and dwarfed. Short descriptions of the species are added.

Mosses of Libya.§—E. Durand and G. Barratte give a list of twelve mosses recorded for Tripoli and Cyrenaica, with the distribution and synonymy of the species. They were determined by C. Mueller about thirty years ago. The occurrence of an hepatic, perhaps *Lunularia*, has been indicated by Pacho, but its identity has not been verified.

North American Bryophytes.—A. J. Grout ¶ gives a list of fifteen mosses and nine hepatics which are new records for Vermont state, and of nine which are rare or otherwise interesting.

M. E. Jones ¶¶ gives in his Montana Botany Notes a list of 223 mosses and twenty-four hepaticæ collected by J. M. Holzinger, by himself, and others. The local distribution of the species is indicated.

Mexican Mosses.**—J. Cardot, who, in the past two years, has described many new mosses for Mexico—10 genera, 160 species, 30 varieties—now gives a list of 62 species unrecorded previously for Mexico. These additions are all the more interesting as proving the mixed character of the Mexican flora, partly temperate, partly tropical. When analysed these species are shown to be 24 belonging to the United States flora, 23 to South America (especially the Andes), 17 to Guatemala and Costa Rica, and 14 to the Antilles. It is surprising to find among them the European *Campylopus flexuosus*, otherwise unknown in America; and also *Fissidens pallidicaulis*, known only from the Atlantic Isles and Italy.

² Hedwigia, li. (1911) Beibl. pp. 32-3.

† Engler's Bot. Jahrb., xvi. (1911) Beibl. pp. 1-34 (3 pls.).

‡ Mém. Club Alpin Caucase et Crimée (Odessa, 1910) 80 pp. (2 pls.).

§ Floræ Libyæ Prodromus. Genève: Romet, 1910, pp. 283-5.

¶ Bryologist, xiv. (1911) pp. 52-4.

¶¶ Bull. Univ. Montana (Biol. ser.) No. 15 (1910) pp. 50-8.

** Rev. Bryolog., xxxviii. (1911) pp. 79-84.

Nomina nuda.*—E. G. Paris, in a note published after his death, raises a protest against the procedure of certain bryologists in substituting for the earlier suitable names of undescribed mosses new names of their own invention. In illustration he cites instances of which Bescherelle and Mitten were respectively guilty.

E. G. Paris: Obituary.—T. Husnot publishes an obituary notice of the late E. G. Paris, author of the *Index Bryologicus*. Born in 1827 in Calvados, Jean Gabriel Edouard Narcisse Paris (such was his full name) died at Dinard on April 30, 1911, in his 84th year. He attained the rank of General in the French Army, and retired in 1889. In the sixties he was in close bryological correspondence with W. P. Schimper, and with him prepared a monograph of *Cryphaaceae*, with forty plates, which was never published. After leaving the army he settled at Dinard, and published his *Index Bryologicus* in two editions, and numerous papers on the mosses of the French Colonies in China, West Africa, Madagascar, etc.

Thallophyta.

Algæ.

(By MRS. E. S. GEPP.)

Nutrition of Algæ.‡—O. Richter writes a book on this subject, which brings together all the latest information and views concerning the nutrition of algæ. He divides his book into two parts: I. On the physiological meaning of chemical elements and of certain chemical compounds, as regards nutrition. II. On the influence of certain chemical and physical factors, in the nutritive substratum, on the form and development of algæ. Part I. deals with (1) metals, calcium, potassium, magnesium, iron, sodium, manganese, and aluminium, and shows the necessity that they are to certain algæ; (2) non-metals, including carbon, hydrogen, oxygen, nitrogen, phosphorus, sulphur, silica, chlorine, iodine, bromine, fluorine. The second part is divided into (1) poisonous effects of necessary and unnecessary chemical elements and of certain chemical compounds. Under this heading the author treats of Oligodynamic; Beijerinck's auxanogram-methods for the recognition of poisonous effects; hastening the growth by chemical irritation; poisonous effect of arsenic; etc. etc. Under "The reaction of nutritive solution" the author describes experiments with Knops and other solutions having an acid reaction, and discusses the advantage of a weakly alkaline reaction of the nutritive substratum in algal cultures. Experiments on concentration of nutritive solutions are then described, and the subject discussed very fully; and then a section is devoted to physical conditions in the nutritive substratum. In an appendix of some length, the author treats of the influence of temperature and light on algæ, with regard to their culture. A full bibliography and various indices complete this important work.

* *Rev. Bryolog.*, xxxviii. (1911) pp. 84-6.

† *Rev. Bryolog.*, xxxviii. (1911) pp. 93-5.

‡ *Monogr. und Abhandl. zur Internat. Rev. Hydrobiol. u. Hydrograph.*, ii. (Leipzig, 1911) vii. and 192 pp. (figs. in text).

Algæ of Tripoli.*—R. Muschler gives an enumeration of algæ, marine and fresh-water, recorded for Tripoli, Cyrenaica, Fizzan, etc., in Durand and Barratte's Libyan Flora. The number of species is eighty-four. Distribution and synonymy are appended in each case.

Algæ of North Carolina.†—In a paper entitled "The Plant Life of Ellis, Great, Little, and Long Lakes in North Carolina," W. H. Brown deals shortly with their algal flora. That of Lake Ellis is rich in both species and individuals. The green algæ are abundant, but not in good condition in the summer season, while the blue-green algæ are more abundant and more vigorous. The blue-green seem to endure the high and changeable temperature better than the green algæ. The algal flora of Great Lake is very scanty, and this is associated with an absence of supporting plants, the darkness of the water, and the presence of great quantities of bacteria. The phanerogams in Lake Ellis compete with the algæ for CO₂ and possibly also for mineral matter, and thus probably tend to decrease the amount of phytoplankton, although the mechanical support which they afford the algæ may counterbalance the effect of the competition to some extent.

Diatoms and Flagellatæ from East Greenland.‡—C. H. Ostenfeld gives a list of the Diatoms and Flagellates in the surface plankton collected during the Danish Expedition to the North-east Coast of Greenland in 1906-8. Forty-three species of diatoms are recorded and five Flagellates. Novelties are *Coscinodiscus Joergensii* and a Coccolith, *Pontosphæra borealis*.

Periodicity of Phytoplankton of the Leopoldstein Lake.§—K. v. Keissler reports on the investigations concerning the periodicity of the phytoplankton of the Leopoldsteiner See in Styria. From March to September, 1910, *Peridinium*, *Asterionella*, *Cyclotella*, and *Staurastrum* were the most important constituents. *Ceratium* and *Dinobryon* were wanting, as also *Fragilaria*, *Synedra*, and *Botryococcus*. The rarest record is *Asterionella formosa* Hsskn. var. *acaroïdes* Lemm. *Asterionella* and *Peridinium cinctum* were noticed in many different stages of division. *Hydrurus foetidus* disappeared in warmer weather, and the gelatinous balls of *Ophrydium* were taken possession of by diatoms.

Halosphæra and Flagellatæ.||—C. H. Ostenfeld publishes an important report on the geographical distribution and biology of *Halosphæra viridis*, *Phæocystis Pouchetii* Lagerh., *P. globosa* Scherf., *Dinobryon divergens* Imhof, *D. pellucidum* Levand., *Coccolithophora pelagica* Lohm., *Distephanus speculum* Haek., and *Dietyocha fibula* Ehrenb. He deals also with their special distribution in the regions examined by the Danish Expedition. Some of the results are demonstrated by means of maps. It is found that *Halosphæra* has its home in the warm Atlantic, and is only carried north by the Gulf Stream.

* Durand et Barratte, *Floræ Libyæ Prodrômus*. Genève: Romet, 1910, pp. 203-13. + *Contrib. U.S. Nat. Herb.*, xiii. pt. 10 (1911) pp. 323-41.

‡ Meddel. om Grønland, xliii. (1910) pp. 259-85 (11 figs.).

§ Anzeig. k. Akad. Wiss. Wien, xlvii. (1910) pp. 371-3.

|| Conseil Perm. Internat. Explor. de la Mer: Bull. trimest. Résumé Planktonique, I. (Copenhague, 1910) pp. 20-38 (pl. 3-5).

Two Brown Flagellatæ.*—A. Pescher describes two new brown species of Flagellatæ, the first of which, *Cryptochrysis commutata*, somewhat resembles *Cryptomonas erosa*, and was found in backwaters of the Olsch in southern Bohemia. The second is *Protochrysis phæophycearum* from stagnant ponds near Franzensbad. Both are typical Cryptomonads. Stein's *Nephroselmis* seems to represent a later development of *Protochrysis*-like monads.

Cryptomonadeæ.†—A. Pascher publishes a preliminary note of the relationship of the Cryptomonadeæ to the Algæ. He finds that the existing views on the subject are not wholly accurate, and he points out where they should be amended. First he defines the limits of the Cryptomonadeæ, a point on which authors are not in agreement; and then he declares his view that the group is a relatively far advanced developmental series of the Chrysomonads, which either spring from the Ochromonadeæ or with them have been developed from a common root. The Cryptomonadeæ are therefore not the ancestors of the many groups which have been by authors derived from them, but form merely a side-branch from the Chrysomonadeæ. From the Cryptomonadeæ spring only the Phæocapsaceæ, Phæophyceæ, and Dinoflagellatæ. The various lines of descent are indicated in a table.

Cyathomonas.‡—V. Ulehra discusses the systematic position of the genus *Cyathomonas* among the Flagellatæ. The only species, *C. truncata*, was placed by Bütschli in the Cryptomonadeæ, but has later been shifted to the Amphimonadaceæ. The author of the present paper finds Bütschli correct. He makes a detailed comparison of the various points common to *Cyathomonas* and the other genera of *Cryptomonadeæ*. He considers the genus as a welcome completion of a natural developmental series of the Cryptomonadeæ, but standing aside on a line of its own and not forming the final outcome of the series.

Chrysomonadeæ from the Hirschberger Grossteich.§—A. Pascher publishes the first part of the investigations on the flora of the Hirschberger Grossteich, in which he deals with the Chrysomonadeæ. He gives a systematic synopsis of the group. I. Chromulinales (terminal cilia). 1. Chrysapsidaceæ; 2. Euchromulinaceæ; 3. Mallomonadaceæ; 4. Pedinellaceæ. II. Isochrysidales (two equally long terminal cilia). 1. Isochrysidaceæ; 2. Euhymenomonadaceæ. III. Ochromonadales (two terminal, unequal long cilia). 1. Enochromonadaceæ. IV. Phæochrysidales (two laterally inserted cilia). New genera and species are described. Fuller details of this paper may be found in Hedwigia.

Chrysomonads.||—O. Reinisch describes and figures a new species of *Phæococcus*, which was found in a salt-water tank at the Physiological Institute at Prague. She describes the various stages of the life-history

* Ber. Deutsch. Bot. Gesell., xxix. (1911) pp. 190-2 (figs.).

† Ber. Deutsch. Bot. Gesell., xxix. (1911) pp. 193-203.

‡ Ber. Deutsch. Bot. Gesell., xxix. (1911) pp. 284-92.

§ Monogr. u. Abhandl. Internat. Rev. Hydrobiol. u. Hydrograph, i. (Leipzig, 1910) 66 pp. (3 pls.). See also Hedwigia, li. (1911) Beibl. pp. (10), (11).

|| Ber. Deutsch. Bot. Gesell., xxix. (1911) pp. 77-83 (1 pl.); xxix. (1911) pp. 112-25 (1 pl.).

of the alga, and compares it with *P. Clementi*, its nearest ally. *P. Clementi* is however a terrestrial form, while *P. marinus* is a marine species.

A. Pascher describes a new genus of Chrysoomonadinae, which he found growing in masses of *Microspora* and *Edogonium* in a park at Franzensbad. It is very closely allied to the somewhat mysterious *Pedinella* of Wyssotzky, both possessing remarkable tentacles. The author describes the structure and life-history of this new alga, which he calls *Cyrtophora pedicellata*. He proposes to form a new family of the Chromulinales, Cyrtophoraceae, to include *Pedinella*, *Cyrtophora*, and *Palatinella* Lauterborn, all of which genera are characterized by the possession of tentacles.

Chlamydomonas Steinii.*—P. Desroche describes in detail some experiments he has made on the phototropism of the zoospores of *Chlamydomonas Steinii* Goros. He finds that light has no effect either in hastening or retarding the movement of the zoospores. They have a constant speed, which does not depend on the quantity of luminous energy which they receive, but represents solely their own energy. Light has no other action than to direct their movement.

Coccogenous Cyanophyceae.†—R. Chodat describes a new and remarkable genus of Myxophyceae from the park of Mon-Repos at Geneva. It unites the characters of several genera of Cyanophyceae, being in fact a mixture of Chamæsihoneae, Oscillatoriae, and Lyngbyaceae. It develops on a stone into a plate of chroococcoid cells of varying size, 1–3 μ . On this plate arise short filaments of the type of *Chamæsiphon*. Sometimes the filaments reach a great length by stretching out in a regular manner in their narrow sheath, but sometimes the cells twist spirally. The most interesting stage is the detachment of conidia in chains. The isolated cells become free by the rupture of the sheath or by escape from its apex. The name given is *Erustiella rufa*.

Oscillatoria rubescens.‡—H. Bachmann describes a remarkable growth of this alga in the Rothsee near Lucerne. In the autumn of 1909 the lake was covered with a greenish powder composed of *Gomphosphaeria Nægeliana*. Later on the ice formed, and that had a red tinge from the *Oscillatoria*; while in April 1910 *Oscillatoria* was growing in such masses that it formed large flat cakes on the water. The smell from the decaying alga was most unpleasant, and the fish suffered considerably. On the other hand, Infusoria and Rotatoria flourished. It is supposed that either the alga suddenly attained this extraordinary multiplication, or that it was carried from the neighbouring Baldergersee by water-birds. The author compares the alga morphologically with similar algae from neighbouring Swiss lakes.

Red Euglena.§—A. D. Hardy writes an account of a red species of *Euglena* which he has found at Doncaster, Victoria, about eight miles from Melbourne. He gives a full account of its habitat, form and structure, as well as of the various experiments he made with it. As

* Comptes Rendus Acad. Sci. Paris, clii. (1911) pp. 890–3.

† Bull. Soc. Bot. Genève, iii. ser. 2 (1911) pp. 125–6.

‡ Naturwiss. Wochenschr., n.f. ix. (1910) pp. 602–4 (fig.).

§ Victorian Naturalist, xxvii. (1911) pp. 215–20 (1 pl.).

regards the statement by Saville Kent that *E. viridis* was capable of producing a red colour by ingesting particles of carmine in solution, the author cannot make it apply to the species here described. He gives in detail all the points of difference between this new species, *E. rubra*, and *E. viridis*, which was also found in the neighbourhood in great quantity.

Myxonema in Salmon Disease.*—A. D. Hardy publishes a short account of the association of alga and fungus in salmon disease. He had previously recorded the presence of *Myxonema tenue* on fish at Melbourne, and now he finds the same alga associated with a member of the Saprolegniaceæ growing on diseased young salmon in the ponds at Kew, Melbourne. The presence of *Myxonema* appears to depend on the preceding growth of the fungus, in the mycelium of which zoospores of the alga may be enmeshed. In the Yarra River *M. tenue* occurs as long streamers in the current, attached to willow, etc. The plants on the fish in the ponds were small but vigorous, and rich in colour, some of them actively producing zoospores. The note ends with a list of thirty-three algæ either new for Victoria or interesting in connexion with the fish question.

Life-history of Anabæna Cycadææ.†—E. R. Spratt has made a study of the life-history of *Anabæna Cycadææ*, which lives in the modified roots of *Cycas*. The region occupied by the alga is an intercellular space, in the form of a zone between the cortical cells, just below the epidermis. Bottomley has shown that this space always contains living in it two kinds of nitrogen-fixing bacteria, *Pseudomonas radicolica* and *Azotobacter*, in addition to the *Anabæna*. The life-history of the alga is therefore of special interest. The author summarizes her results as follows. 1. *Anabæna Cycadææ* is a typical *Anabæna*. 2. Each mature cell has two investments, an inner and outer, in addition to the external mucilaginous sheath. 3. The chlorophyll and phycoeyanin are lodged in the peripheral cytoplasm, no definitely organized chromatophore being present. 4. The ventral body is a simple structure only capable of direct division. 5. The chief product of assimilation is glycogen. 6. Cyanophycin granules are very abundant. 7. In the vegetative division the ingrowth of the lateral walls is accompanied by direct division. 8. Terminal and intercalary heterocysts are formed from vegetative cells. They may become detached, and appear to have three functions: (a) to limit the filaments—vegetative reproduction; (b) for storage of reserve food material; (c) reproduction by formation of gonidia. 9. Spores are formed. The exospore and endospore are the fully developed cell-sheath and inner investment respectively. 10. There are four types of spore germination: (a) the contents are protruded through a pore in the spore membrane; (b) the spore membrane is ruptured; (c) the spore membrane becomes mucilaginous; (d) the contents divide before escaping from the spore wall. 11. Gonidia are formed by the rejuvenescence and subsequent division of the contents of the heterocysts. A distinct membrane appears inside the walls

* Proc. Roy. Soc. Victoria, xxiii. (1910) pp. 27–32.

† Ann. of Bot., xxv. (1911) pp. 369–80 (1 pl.).

of the heterocyst. A number of spherical gonidia are formed, each of which is capable of dividing to form a new *Anabaena* filament. 12. *Anabaena Cyanea* maintains its existence in the soil in the form of heterocysts and spores, which develop into gonidia, and these enter the *Cyca* tubercles through the lenticels. Twenty-six figures illustrate this paper.

New Species of Nostoc.*—L. Gain describes two new species of *Nostoc* collected on the French Antarctic Expedition (1908-10). The author mentions that he has been able to identify about twenty different species of algae, mainly Cyanophyceae and Desmidiaceae, among mosses and in damp places. The first of the two new species is *Nostoc Borneti*, from Jenny Island, within the polar circle, and is allied to *N. caeruleum* Lyngbye, which it resembles in its globular firm habit, its transparent mucilage, its sharp polished outline, dense sinuous trichomes, and indistinct sheaths. But it differs from *N. caeruleum* in its smaller size. The course of development is described for *N. Borneti*. The second species is *N. pachydermaticum*, also found among mosses and other algae at Jenny Island. This belongs to the section *Communia* Born. and Flah., in the neighbourhood of *N. commune* Vauch.

Ulva latissima.†—A. D. Cotton writes a report on the growth of *Ulva latissima* in excessive quantity, with special reference to the *Ulv*-nuisance in Belfast Lough. The report deals with the botanical aspect only, and it is divided into three parts, namely: (1) a description of the growth of *Ulva* on the Belfast sloblands; (2) an account of various other localities investigated with a view to explaining the conditions which bring about excessive *Ulva*-growth; and (3) a general summary of the ecology of *Ulva*, a discussion on the question of its growth in excessive quantity, and the conclusion as to Belfast. One of the most interesting results obtained by the investigation is the discovery of the important part played by mussels in connexion with an excessive growth of *Ulva*. He says that these molluscs, like *Zostera*, can cover ground on which *Ulva* could find no anchorage, but, unlike *Zostera*, they afford an excellent mooring for the *Ulva*. The presence of mussels and an excessive growth of *Ulva* in estuaries will probably be found to be very intimately connected. Mussels are capable of covering many acres on flat shores which would otherwise be bare mud or fields of *Zostera*, and the result of the mussel-covering is a growth of *Ulva*. The principal conclusions are summed up shortly: Of the conditions necessary for the growth of *Ulva* in the littoral region, two may be singled out as of the very greatest importance: (1) the absence of rough water; and (2) the presence of a substratum which affords a suitable anchorage for the plants. The latter is supplied by the molluscs, as mentioned above. *Ulva* is proved to be an alga that thrives in pure sea-water, and in polluted brackish water. Being a marine and not a fresh-water organism, its growth in polluted estuaries is probably to be regarded as an adaptation. In sewage-contaminated water it absorbs large quantities of ammonia, and its tissues are found to contain a much larger proportion

* Comptes Rendus Acad. Sci. Paris, clii. (1911) pp. 1691-4.

† Royal Commission of Sewage Disposal, rep. 7, app. iv. (1911) 23 pp. (1 pl.).

of nitrogen than fronds from pure sea-water in the corresponding season. The result of this excessive nourishment is seen in an increased rate of growth, the fronds being at the same time of a different texture and of a darker colour. But, as in other cases of over-fed plants, there is a tendency for spore-formation to remain in abeyance, and increase to take place by vegetative methods; the growth, therefore, may be considered as rank rather than healthy. With regard to the Belfast nuisance, the author considers that since *Ulva* is not dependent on sewage, it will not be suppressed until the mussels are exterminated.

Spirogyra.*—F. M. Andrews records an instance of conjugation taking place between *Spirogyra crassa* and *S. communis*. A large quantity of the two species was found in a pond and all stages in the process of conjugation could be seen. In most cases the same species conjugated together, but in many cases the two species cross-conjugated. As a rule the contents of *S. communis* passed over to *S. crassa*, but instances of the opposite mode were also found. Both cases are figured. Apart from a difference in size and form, the zygospores seemed perfectly normal. The author writes from Indiana University, Bloomington, U.S.A.

Desmids of the Burgäschimoos.†—F. Mühlethaler writes on the Desmid-flora of the Burgäschimoos, a locality already well worked for flowering plants. He records ninety-five species and varieties, collected during March and April in last year. Although no new species are formally described, the author gives details of certain species and forms which he finds vary greatly from those already known, and he believes that they will prove to be novelties. A section of the paper is devoted to a short discussion of the ecological conditions, and remarks on the other components of the cryptogamic flora found there. The list of Desmids is finally given in tabulated form, showing the occurrence of each species.

Cell and Nuclear Division in Closterium.‡—B. F. Lutman has made a study of the cell and nuclear division in *Closterium*, and describes the results at length. The summary given is as follows: 1. *Closterium* divides from 10 p.m. to 5 a.m., and the new half has become practically symmetrical with the old one by 9 a.m. 2. Division is dependent upon the storage of a considerable quantity of starch in the chromatophore and around the pyrenoids. 3. The chromatophore divides by a constriction located about a third of the distance out from the middle. This constriction is due to the enlargement of a ring-shaped vacuole under the plasma membrane. 4. The resting nucleus of *C. Ehrenbergii* is made up of a very fine reticulum carrying little if any chromatin in the form of granules. At the centre of this reticulum is a large compound nucleolus made up of a number of partially fused nucleoli. The resting nucleus of *C. moniliferum* has essentially the same structure, but the nucleoli at the centre are more completely fused. 5. The spireme is formed outside the nucleolus and apparently separate from it. During

* Bull. Torrey Bot. Club, xxxviii. (1911) p. 299 (1 fig.).

† Mitteil. Naturf. Gesell. Bern (1911) pp. 104–22 (figs. in text).

‡ Bot. Gazette, li. (1911) pp. 401–30.

its formation that body breaks down, but it is impossible to decide whether its material goes to the spireme or is used up for some other purpose. No chromosomes come bodily out of the nucleolus as has been described for *Spirogyra*. 6. The spindle is cylindrical, with broad poles, much resembling that of *Spirogyra*. 7. In the telophase a dispireme is formed, and in this the nucleoli reappear as small spheres, which partially fuse to form larger masses. 8. The two daughter-nuclei move around the chromatophore, between its ridges, apparently in an amœboid manner, to their new positions. 9. The new end wall is put across in essentially the same manner as in *Spirogyra*, that is, by a growth inward from the periphery. 10. Division in these species of *Closterium* is at least a two-night process: the chromatophore divides the first night: the nucleus the second night. 11. The position of the young transverse wall would seem to indicate that the pointed ends are secondarily formed, and that *Closterium* was originally a filamentous alga, which has developed the habit of breaking up into single cells.

Botrydium granulatum.*—J. Burton describes a plentiful growth of *Botrydium granulatum* which he found at the Welsh Harp Reservoir last October. After a few remarks on its systematic position, he discusses the various modes in which it reproduces itself, and finally points out that our knowledge of the alga is not yet complete.

Vaucheria terrestris.†—E. Paque writes a short account of Desroche's work on this species.‡ Desroche placed some authentic specimens of *Vaucheria terrestris* in sterilized tubes containing Knops' nutritive solution. The specimens in question were about 2 mm. in length, and each bore the characteristic sexual apparatus. Thus all possibility of error was avoided. These fragments germinated, and at the end of a year six of them had grown to a length of several centimetres and bore numerous sexual organs. These organs were all of the type characteristic of *V. geminata*, and therefore the author finds himself compelled to reduce *V. terrestris* Lyngb., to a form of *V. geminata*, under the name of forma *terrestris*.

Codium tomentosum.§—F. Tobler writes on the organization of the thallus of *Codium tomentosum*. His observations were carried out with a view to determine three different points: 1. Normal conditions of growth, especially the development of the germinating plants. 2. Experiments in restitution and observations on polarity. 3. Influence of external factors, especially that of light on the thalli, or on the differentiated portions of it. The author's observations with regard to the first of these points coincide with the information given by Oltmanns in his *Morph. Biol. d. Algen*, 1904. He finds the thallus in the highest degree capable of restitution, new plants being grown from isolated palisade-cells. These show from the very beginning a marked polarity with the base as the centre of development. Restitutions of injuries to

* Journ. Quekett Micr. Club, ser. 2, xi. (1911) pp. 209-12.

† Bull. Soc. Roy. Bot. Belg., xlvii. (1910) pp. 360-3.

‡ C.R. Soc. Biol. (1910) p. 969.

§ Flora, ciii. (1911) pp. 78-87 (3 figs.).

portions of the thallus also show a polarity of the organism. Want of light causes irregularities in growth of the thallus. Adverse influences cause disintegration and formation of bud-like bodies, which develop in a similar manner to the isolated portions. Germination of the zygotes (as also that of the vegetative organs of multiplication) results in a protonema-like growth, which precedes the beginning of the *Codium* thallus.

New Chlorophyceæ from New Zealand and Tahiti.*—F. Brand describes four algæ collected by Tilden which he found among a number of other species sent to him. The first of these, from Tahiti, represents, in the author's opinion, the type of a new genus of Udoteæ, *Rhytisiophon tahitense*, to other members of which group he compares it, omitting, however, to point out the remarkable likeness it bears to *Chlorodesmis comosa*. The other algæ described are *Cladophora stewartensis* from Stewart Island, New Zealand, *Rhizoclonium fissum* from fresh-water in New Zealand, and *Boodleia composita* f. *irregularis* n.f. from Tahiti. The new species are figured.

West Indian Chlorophyceæ.†—F. Börgesen writes on some Chlorophyceæ from the Danish West Indies. He adds two species of *Caulerpa* to the list previously published, of which one species, *C. Vickersii*, is new. It represents the *C. ambigua* recorded from Barbados by A. Vickers and, in part, the *C. ambigua* of Okamura. It is here fully described and figured. The author then deals with the specimens of *Halimeda* found by him, and discusses the views of Howe as to the species limits and characters. He agrees with that author in keeping separate *H. tuna* and *H. discoidea* Decaisne, and gives his reasons. He divides the latter species into two varieties, var. *typica* and var. *platyloba*, comparing var. *platyloba* with the corresponding deep-water variety of *H. tuna*, i.e. var. *platydisca*. The two species, with their varieties, are distinguished by the size and form of the utricles of the subcortical layer, and by certain characters of the peripheral utricles. The author next discusses the vexed question of nomenclature of *H. incrassata* and *H. tridens*, and gives his reasons for accepting *H. incrassata* as the true name for the species. He disagrees with Howe in regarding f. *monilis* as a species, and reduces it again to a variety, as also the *H. simulans* of Howe. On the other hand he describes and figures a form *gracilis* of var. *typica*, and two new forms of var. *monilis*. A new variety, *opuntiioides*, is described for *H. gracilis*, which well defines the marked West Indian variety of that species. In dealing with *Bryopsis*, the author regards the species of the *B. plumosa* group as being mere varieties of that species, and records his finds accordingly. *Vaucheria dichotoma* Ag. is recorded, and a new species of *Enteromorpha*, *E. chaetomorphoides*. Notes are given on *Blattophysa rhizopus* Rke. and *Endoderma viride* Lagerh.

Development of Costaria, Undaria, and Laminaria.‡—K. Yendo has had opportunities for years of collecting and examining the early

* Ber. Deutsch. Bot. Gesell., xxix. (1911) pp. 138-45.

† Bot. Tidsskr., xxxi. (1911) pp. 127-52 (figs. in text).

‡ Ann. of Bot., xxv. (1911) pp. 691-715.

stages of development of various species of Laminariaceæ on the coasts of Japan. The present paper is prepared to elucidate the development of *Costaria Turneri* in particular, as well as of *Undaria pinnatifida* and some species of *Laminaria*, comparing them with previously published accounts of other genera. Three forms of *Undaria pinnatifida* are recognized. The author gives the following summary of his work. 1. The earliest stage of development of the sporelings of the Laminariaceæ investigated is a confervoid body growing by a single apical cell. The confervoid body becomes monostromatic in the next stage, with a monosiphonous stipes. The growth of the monostromatic blade is initiated by the two cells situated side by side at the same level beneath the apical cell, the axis of the blade passing between the two cells. 2. The monostromatic blade becomes distromatic at its base; the monosiphonous stipes becomes polysiphonous at the same time. A new meristematic tissue begins to appear at the transitional region between the blade and the stipes. 3. The growth in length as well as in breadth is due, at a certain period, to both the apical and the stipo-frontal growth. The apical growth is gradually retarded, and finally ceases. Erosion of the apex of the blade follows next. 4. A single precortical layer of large parenchymatous cells is generated at the transitional region between the already existing two layers. The former soon becomes two-layered, and adds to the number of its layers later on. Additions of layers of cells are, as a rule, limited to, and begin at, the transitional region. 5. The hyphal cells are generated as the precortical layer becomes doubled, and the expansion of their distal ends into a trumpet shape takes place at the intercellular spaces. 6. The rib and the meridional region are formed by special thickening of the cortical layers. The dorsiventrality of the lamina, if it exists, is indicated simultaneously with the formation of such parts. 7. In *Undaria* the mucilage-glands are developed at an early stage, but in *Laminaria* the appearance of the lacunæ does not take place before the blade has attained to a considerable length. 8. The cryptostomata in the Laminariaceæ are not generated from a single initial cell. Each hair has its origin in an epidermal cell of equal value, except that those in the middle develop earlier than the peripheral cells. The paper is illustrated by three plates.

Rhodophyceæ.*—N. Svedelius publishes the appendix volume Rhodophyceæ to Engler and Prantl's *Die Natürlichen Pflanzenfamilien*, thus bringing that group up to the present time. It includes Bangiales and Florideæ.

Gonimophyllum Buffhami.†—This alga is recorded by J. Chalon from Astan and the Ile de Bas in the neighbourhood of Roscoff. The specimens were found on *Nitophyllum lacertatum* in Herb. Vickers. *G. Buffhami* had previously only been recorded from Jersey and Deal. The author wonders whether the alga is really so rare as has been supposed, or whether it has merely escaped notice from its extreme minuteness.

* Engler u. Prantl, *Die Natürlichen Pflanzenfam. Nachträge z. 1 Teil, 2^{te} Abt.* (1911) pp. 191-284.

† Bull. Soc. Roy. Bot. Belg., xlvii. (1910) pp. 261-2.

Ceramium.*—H. E. Petersen publishes some studies on *Ceramium*. The first consists of remarks on Danish species of *Ceramium*, viz., *C. tenuissimum*, *C. strictum*, *C. Areschougii*, *C. fruticosum*, and *C. rubrum*. Points of a systematic character are discussed with regard to *C. strictum*, *C. diaphanum*, and *C. fruticosum*, the first two of which are not easily distinguished. Information is also given on the refringent cortical cells containing proteid matter which are common in some species, and on the development of main axes in *C. rubrum*, *C. fruticosum*, and *C. diaphanum*. The second study is devoted to researches on *Ceramium* species from the Faeröes, Iceland and Greenland. The distribution of the species in the three areas and Denmark is shown in tabular form. Three new species are described. Six types are recognized for the many forms of *C. rubrum*.

Lithothamnia from Roscoff in Brittany.†—F. Heydrich writes on certain species of *Lithothamnia* collected in the neighbourhood of Roscoff by Chalon. Among these are specimens of Foslie's *L. Battersii* (?), sunk by the author into *Phymatolithon polymorphum* Fosl. *Lithothamnia rubrum* Phil. is given a new diagnosis and divided into five new forms. A new form is described for *L. calcareum* Aresch., and a new genus is created to contain *Melobesia Lenormandi* Aresch. under the name of *Squamolithon*.

Tolypella intricata Leonh.‡—G. C. Druce writes a note recording the reappearance of *Tolypella intricata* in the ditches at Marston, Oxford, for the fourth time. The ditches in question had been cleared in each case the previous autumn.

Fungi.

(BY A. LORRAIN SMITH, F.L.S.)

Aphanomyces lævis.§—By careful research V. Kasanowsky has proved fertilization in this genus of Saprolegniaceæ. The species examined was collected, along with other fungi, on a dead fly in a pool near to Kiev; it was isolated and successfully cultivated. A detailed account is given of the methods employed in fixing, staining, etc.

Aphanomyces lævis is monœcious, and from a mycelium produced from a zoospore developed oogonia and antheridia, the former full of plasma, and with a large number of nuclei and a large vacuole. As the vacuole enlarges it pushes the contents towards the periphery and many of the nuclei degenerate; those that remain divide once, but all degenerate except one, which becomes the egg-nucleus. The egg is formed by protoplasm gathering towards the centre with a cœnocentrum in the middle, of which the function is to form a centre of nutrition. The nucleus lies near to the cœnocentrum and increases in size.

The antheridia are at first multinucleate, but they all degenerate

* Bot. Tidsskr., xxxi. (1911) pp. 97–120 (5 pls.).

† Ber. Deutsch. Bot. Gesell., xxix. (1911) pp. 26–33 (1 pl.).

§ Journ. of Bot., xlix. (1911) pp. 235–6.

§ Ber. Deutsch. Bot. Gesell., xxix. (1911) pp. 210–28 (1 pl.).

except one, after having undergone mitosis. The single nucleus passes with plasma through the elastic fertilizing tube into the ooplasm, and fuses with the female nucleus. When the oospore is mature, granules, which are evidently fat-centres, are scattered through the plasma.

The oospore is uninucleate, and contains as nutriment a fat-globule which has a membrane and evidently also a stroma. After six months resting period the oospore germinates with a tube which immediately branches.

Parasitic Root-diseases of the Juncaceæ.*—P. Magnus criticizes a paper by E. J. Schwartz on this subject, in which the latter had stated that Magnus had placed a fungus causing the tubercles on the roots of *Juncus articulatus* in the genus *Schinzia*, and that Weber had named it *Enorhiza cypericola*, which Schwartz endorses. Magnus denies these statements, and gives his reasons for doing so.

Sclerotinia as a Plant-disease.†—Joh. Westerdijk records the appearance in Holland of *Sclerotinia Libertiana* on *Lactuca sativa* and other cultivated plants. Continued saprophytic life does not impair its capacity to turn parasite. Infection takes place through wounds, and in moist weather; *Botrytis cinerea* is not the conidial form. The sclerotia often develop mycelium and not ascospore fruits, and the *Peziza* form does not develop in artificial cultures.

Studies in Ascomycetes.‡—Ed. Fischer has made a résumé of work done recently on Tuberineæ and Helvellineæ, tracing the relationships between members of these groups and between the groups themselves. It has been found as a result of researches that there is no great difference between Balsamiaceæ and Entuberineæ, nor between Pezizaceæ and Helvellaceæ. The reasons for these decisions are given, and the different research-workers referred to.

Plicaria Planchonis Boud.§—J. Lagarde found, in November 1910, a number of specimens of a dark violet-coloured *Peziza* on the soil at Montpellier, measuring across from 2 mm. to 3 c. He found it to be identical with authentic drawings of *Aleuria atro-violacea*, and also synonymous with *Ascobolus Persoonii*. The spores are spherical: the hymenium is coloured blue-violet. A coloured plate of the fungus is given.

Hypocrea rufa.||—M. Medisch isolated from the soil the fungus *Trichoderma viride*, the conidial stage of *Hypocrea rufa*, and with it he made a series of culture experiments. In a weak medium of glucose there is a continual oxidation shown by the colour changes. An addition of various salts to the culture quickened the formation of colouring matter. It began with yellowish green or green, and changed to yellow or orange, and Medisch considered these changes as stages of oxidation.

* Hedwigia, l. (1911) pp. 249-52.

† Med. Phytopath. Lab. "Willie Commelin Schoiten," ii. (1911) 28 pp. (2 pls.). See also Ann. Mycol., ix. (1911) pp. 309-10.

‡ Zeitschr. Bot., ii. (1910) pp. 718-22.

§ Bull. Soc. Mycol. France, xxvii. (1911) pp. 39-43 (1 pl.).

|| Jahrb. Wiss. Bot., xlviii. (1910) pp. 591-631. See also Bot. Centralbl., cxvii. (1911) pp. 91-2.

The coloured culture medium could be bleached by reducing substances (hydrosulphite of sodium, etc.). Reducing bacteria acted very weakly. An account is also given of the effect produced by the addition of nitrogen on the development of the fungus.

Research on *Aspergillus*.*—P. Baccarini has made culture experiments with a species, *A. flavus*, that grew on decaying flowers of *Capparis sicula*. He obtained a plentiful crop of conidiophores and conidia, and, when these died down, sclerotia were formed. He found these two sub-races constantly appearing, one forming conidiophores, the other sclerotia. He obtained still another species, of which he gives cultural details.

B. Sauton † has made experiments with the spores of *Aspergillus niger* inoculated on pigeons. They germinate in and destroy the tissues of the animal after they have been treated with extract of *A. fumigatus*. This substance protects them from the phagocytes until they germinate, and then the mycelium kills the animal.

G. Bertrand and M. Javillier ‡ have tested the influence of zinc and manganese on cultures of *Aspergillus niger*. They secured finer growths with an addition of small quantities of both substances to the culture medium. Better results were obtained with the two together than with each separately.

A. Sartory and G. Bainier § have secured a yellow pigment from the perithecia of species of *Aspergillus*, notably from *A. scheelii*. It is fluorescent in the different solutions they made, but they did not succeed in getting crystals. After evaporation the residue was resinous.

Notes on *Erysipheæ*.||—Vittorio Peglion has made a series of observations on different oidia. The *Oidium* of the oak has been very prevalent of late years, and he concludes that the fungus winters in the buds of the host, and is therefore independent of any Ascomycetous form. He compares with it the *Oidium* of the apple, *O. farinosum*, of which the perfect fruiting-form has only recently been discovered, and the mildew of the rose, which winters by its mycelium in the buds. The summer form is thus all the more important, if it is independent of any winter fruiting-stage.

Physalosporina, a New Genus of Pyrenomycetes.¶—N. Woronichin found the new fungus on leaves of *Caragana frutex* from Gouv. Samara. It forms a broad flat rose-coloured or white stroma on the leaves, something like a *Polystigma*, but is judged by the writer to be nearly akin to *Physalospora*, and placed by him in the Pleosporaceæ. He has transferred several other species to the same genus, all of them characterized by a stroma.

Development of the Spores in Pleurage zygospora.**—M. Lewis reports that this species, formerly reported only from Italy, is found

* Bull. Soc. Bot. Ital., 1911, pp. 47-55.

† Comptes Rendus Acad. Sci. Paris, clii. (1911) pp. 1697-8.

‡ Comptes Rendus Acad. Sci. Paris, clii. (1911) pp. 900-2.

§ C.R. Soc. Biol. Paris, lxx. (1911) pp. 776-7.

¶ Atti R. Accad. Lincei, ccviii. (1911) pp. 687-91.

¶ Ann. Mycol., ix. (1911) pp. 217-25.

** Bot. Gaz., li. (1911) pp. 369-73 (1 pl.).

growing extensively in the United States. The mature ascospores have the form of a long filament, with two swollen ends. There are eight of these in the ascus, and Lewis has studied this development to arrive at a right understanding of the systematic position of the species. He comes to the conclusion that each one of these represents but one spore made up of three cells, those at each end being swollen, and each one functioning as a spore, the connecting cell being sterile. The species, therefore, belongs to the genus *Pleurage* and not to the 16-spored *Philocopra*, to which it was transferred by Saccardo.

Alcoholic Ferment of Yeast-juice.*—A. Harden and W. J. Young have tested the influence of arsenates and arsenites on the fermentation of sugars by yeast-juice to see if these acted similarly to phosphates. The action they found was very marked, causing acceleration in the rate of production of carbon-dioxide and alcohol. Arsenites act in the same way but not so vigorously; both substances cause total inhibition of the fermentation when they are present in a highly concentrated form. Other results were tabulated and are discussed in the paper.

Sphæropsidæe.—H. and P. Sydow † describe a fungus *Sclerophyris abietina* g. et sp. n., collected by F. W. Neger on pine-branches. It has a stromatoid base to the pycnidia, and the one-celled spores are given off from cells all round the interior of the pycnidium. No definite sporophores are formed.

H. Diedicke ‡ publishes notes on several genera of the series: *Duthiopsis*, a genus with a pycnidium immersed simply in a stroma; *Sclerophoma*, in which the inner cell-layers become converted into spores, and *Sclerotiopsis*, which has a somewhat soft stroma; the pycnidium is chambered, and there is no ostiole. The species of each genus are listed.

Parasitic Lichen-fungi.§—K. von Keiszl describes two new fungi that he found parasitic on lichens. The first, *Phoma physciicola*, infested the apothecia of *Physcia aipolia*. Another species of *Phoma* has been described on the thallus of *Physcia*, but the new species differs in the broadly ovate spores.

He further found on the thallus of *Hæmatomma clatinum* a fungal perithecium, similar to *Phoma* in producing small colourless spores, but differing in the formation of sterile hyphæ on paraphyses among the fertile sporophores. He names it *Lichenophoma Hæmatommatis* g. et sp. n.

Gum-inducing Diplodia of Peach and Orange.||—H. S. Fawcett and O. F. Burger first obtained the species from peach- and orange-trees in Florida, where it induced copious gumming. A series of inoculations were made on healthy trees in order to test various modes of inducing gummosis. The peach-trees began to gum in 4 to 7 days, but in no case was any tree killed, though the tissues round the inoculation area were destroyed. The fungus was also isolated from rotting fruit of orange and from grape-fruit, in which it causes softening and decay.

* Proc. Roy. Soc., Series B, lxxxiii. (1911) pp. 451-75.

† Ann. Mycol., ix. (1911) pp. 277-8 (4 figs.).

‡ Ann. Mycol., ix. (1911) pp. 279-85 (1 pl.).

§ Hedwigia, l. (1911) pp. 294-8 (2 figs.).

|| Mycologia, iii. (1911) pp. 151-3.

New Fungi from the Tyrol.*—P. Magnus describes two new parasitic species: *Cercospora Feniculi* on *Feniculum officinale* differs from other species of *Cercospora* in the spores remaining non-septate, but the other characters all agree with *Cercospora*. He also found a parasitic *Coniosporium* on the leaves of *Onobrychis sativa*, with large brown conidia measuring $31\mu \times 16-19\mu$. Most of the species of this genus are saprophytes, but Magnus thinks there may be many more parasitic species than is generally supposed.

Hyphomycetes.†—R. E. Buchanan gives an account of the genus *Cephalosporium*. Species of the genus are common in the humus-rich prairie soils of Iowa. Buchanan isolated and cultivated a new species, *C. Pammelii*. It produced the usual heads of conidia, but these, when they fed on the culture medium, became much elongated, somewhat crescent-shaped, and 6-8 septate. They then bud and develop similar conidia. The author considers that the genus *Hyalopus* is the same as *Cephalosporium*, and that *Allantospora* is also probably only a growth form.

Classification of the Hyphomycetes.‡—P. Vuillemin publishes a continuation of previous work on this subject. Instead of the old divisions Mucedineæ, Dematiæ, etc., he proposes Thallosporæ, Hemisporæ, and Conidiosporæ. The latter group is the one dealt with. It includes forms in which the spore is sharply differentiated from the vegetative structure. The author lays more stress on the sterigma on which the conidium is directly borne than on the general sporophore. The sterigma he calls the "Phialide." The first order Sporotrichaceæ has no sporophore, typified by *Rhizotrichum*; the second order Sporophoreæ, with a simple sporophore, is represented by *Acromonium*. The other two are characterized by the branching of the sporophore: they are the Phialideæ, of which the type is *Botrytis*, and Urophialideæ, which includes genera like *Coemansia*.

Green Muscardine of Frog-hoppers.§—In Trinidad the sugarcane is damaged by a fungus *Marasmius Sacchari*, and also by an insect *Tomaspis postica*, called the frog-hopper. The latter is attacked by a fungus determined by Thaxter as *Metarrhizium anisopliæ*. G. B. Rorer gives an account of this fungus and of his cultures of it on artificial media and on frog-hoppers. The infected insects were killed in five days, and it is believed that the fungus may prove of economic service to the planters in getting rid of the frog-hoppers.

Thermophilous Moulds.||—Griffon and Maublanc describe two moulds that grew at high temperatures. One, already reported by Miehé as *Thermomyces lanuginosus*, grew on heated oats, they consider

* Hedwigia, l. (1911) pp. 185-8 (1 pl.).

† Mycologia, iii. (1911) pp. 170-4 (2 pls.).

‡ Bull. Séanc. Sci. Nancy (1910) 44 pp. (5 pls.).

§ Proc. Agric. Soc. Trinidad and Tobago, x. (1910) pp. 467-82 (1 pl.). See also Ann. Mycol., ix. (1911) pp. 311-12.

|| Bull. Soc. Mycol. France, xxvii. (1911) pp. 68-74 (8 figs.).

to be a *Sepedonium*; like other species of that genus, it has minutely echinulate spores. The other grew on fresh manure, and has been diagnosed as a new species of *Penicillium*.

Uredineæ.—Ellsworth Bethel * publishes an account of some species of *Gymnosporangium*, notably of two species that cause witches'-brooms or fasciation of the branches: *Gymnosporangium Nelsoni* on *Juniperus scopulorum*, and a new species *Gymnosporangium Kernianum* on *Juniperus Utahensis*, which produces a compact spherical fasciation: there are no clues as to the æcidial form.

J. W. Ellis† reports the finding of a rare Uredine, *Æcidium leucospermum*, on *Anemone nemorosa* in N. Wales. No trace of *Puccinia fusca*, the alternate form, was found.

Jakob Eriksson‡ gives results of two years' work on the rust of mallows, *Puccinia Malvacearum*. The propagation of the disease is secured chiefly by the dissemination of infected seeds or of shoots grown from such seeds. In the latter case the shoots remain healthy about three months, then suddenly show disease with numerous pustules on the leaves. A secondary eruption, which affects all the green parts of the host-plant, arises from external infection.

The fungus winters under natural conditions in stalks of *Althæa rosea* as a mycoplast in symbiosis with the protoplasm of the cells. In pustules formed in autumn there are two kinds of spores morphologically similar but differing in the mode of germination, some of them forming a bent promycelium with sporidia, the others producing a long straight filament which breaks up at the end into short cells or conidia. Inoculation by promycelial sporidia results in the formation of a filament which penetrates the palisade cells and then passes to the intercellular spaces; pustules of spores follow in 10 to 20 days.

In the case of inoculation by conidia, the whole contents of the conidium passes into the epidermal cell as a plasmic mass, spreads along the cell-wall, and forms plasmic bands across the interior. It passes to neighbouring cells until the whole leaf is occupied. For weeks there may be no trace of disease. The fungus passes from the plasmic to the mycelial stage shortly before spore-formation. At that stage a free nucleolus is constituted in the plasma of the cell round which the mycoplast collects. It then approaches the cell-wall, forms a pear-shaped body, and passes into the intercellular space: there it forms a filament. The same process takes place in a large number of cells: the newly formed mycelium grows and takes possession of the whole leaf, and in 10 to 20 days forms spore sori.

E. Baudys§ records the many attacks of rusts in north-east Bohemia during the year 1910. Great harm was done by *Uromyces Fabæ*, *U. Pisi*, and *U. Trifolii repentes*, on various *Leguminosæ*. *Uromyces Betæ* attacked beet plants, destroying all the leaves; *U. Poæ* appeared on several species of *Poa*. On other grasses were noted *Puccinia dispersa*, *P. bromina*, *P. triticina*, *P. glumarum*, *P. graminis*, etc. *P. Pruni spinosæ* was so

* Mycologia, iii. (1911) pp. 156-60 (1 fig. and 1 pl.).

† Journ. Bot., xlix. (1911) p. 235.

‡ Comptes Rendus Acad. Sci. Paris, clii. (1911) pp. 1776-9.

§ Zeitschr. Pflanzenkr., xxi. (1911) pp. 287-8.

abundant on *Prunus domestica* that the leaves were covered with the spores, and fell mostly before the fruit was ripe. *Gymnosporangium Sabinæ* made its appearance on the leaves of *Pyrus communis*. Species of *Phragmidium*, *Cronartium*, and *Melampsora* were also recorded. The abundance of the rusts during the year is explained by the persistent damp weather.

Y. Orishimo * has established by culture experiments the connexion between *Peridermium Pini-densifloræ* P. Henn. and a *Coleosporium* on *Aster scaber*, the latter to be called *C. Pini-Asteris*. The writer also gives a list of Japanese *Coleosporium* species, with their host-plants.

Ed. Fischer † gives a critical review of Uredineæ experiments carried on during the year 1909. He refers to the immense scope for work in North America, and gives a list of successful culture experiments carried out by Arthur on *Puccinia* and on *Gymnosporangium*. In Europe work was done by W. Tranzschel in clearing up the relationships of various heteroecious species. He established the existence of hemi-forms (without pycnidia). Tranzschel also worked at pleophagous species such as *Puccinia Isiacæ*, which attack different hosts. The opposite tendency is found among the physiologically specialized species such as *P. Hieracii*, examined by R. Probst. The results of other workers on these lines are also given.

Nuclear Phenomena in Puccinia Podophylla. ‡—Lester W. Sharp has published a preliminary note on this subject. He finds that in the mycelium, from which arise the acidia and spermogonia, a binucleate condition prevails, the nuclei being associated in pairs, even before there is any indication of acidium formation. The acidium arises in a dense tangle of hyphæ beneath the epidermis of the host. Certain cells enlarge and become the "basal cells" of the acidiospore chain. Cells may have fused—there is no clear evidence—but there is no migration of nuclei. Observations on the formation of spermatia are also given.

Smut Fungi.—D. McAlpine § gives an account of the smuts of Australia in a volume similar to the one he published on the rusts some years ago. He begins with general characters of the families, their life-histories and distribution, and then treats more particularly the cereal smuts and grass smuts. Other genera occurring on herbaceous plants are more shortly dealt with. McAlpine gives a host-index, a general index, and a fungus index. From the latter we learn that there are twelve genera of smuts in Australia. The volume is copiously illustrated by photographs.

H. C. Schellenberg || has more recently published the smuts of Switzerland. He also gives a general account of the fungi. He divides them into two great families, Ustilaginaceæ and Tilletiaceæ, and gives keys to the genera, seventeen in all. In his descriptions of species he

* Bot. Mag. Tokyo, xxiv. (1910) pp. 1-5. See also Ann. Mycol., ix. (1911) p. 301.

† Zeitschr. Bot., ii. (1910) pp. 332-6.

‡ Bot. Gaz., li. (1911) pp. 463-4.

§ The Smuts of Australia. Melbourne (1910) vi. and 288 pp. (56 pls.).

|| Beiträge zur Kryptogamenflora des Schweiz, iii. Heft 2 (Bern, 1911) xlv. and 180 pp. (79 figs.).

includes the germinations of the spores, the inoculation experiments that have been carried out, and the time and manner of infection. Both McAlpine and Schellenberg give complete bibliographies.

I. Pole Evans * gives notes on maize-smut or "brand" caused by *Sorosporium reilianum*. It breaks out on the surface of the infected parts as a black dusty mass. The spores germinate readily in fresh stable-manure, and a heavily manured crop thus runs considerable risk of being smutted. All young and tender parts of the maize-plant can be infected.

Smut-infection Experiments. †—As a result of a long series of culture experiments, O. Munerate comes to the following conclusions. 1. Without taking other factors into account, the condition of the temperature at the time of sowing by retarding or accelerating growth-changes exercises considerable influence on the susceptibility of the plant to infection. 2. The presence of fungus-spores on the seed does not always cause the development of the fungus. 3. Early sowing of autumn corn and late sowing of spring corn generally procure healthy plants, whether the seeds are infected or not. 4. Late sowing in autumn and early sowing in spring nearly always result in a diseased crop—unless weather conditions are exceptionally favourable. 5. Soaking the seed in some fungicide will, as a rule, preserve the young seedling from the disease.

Note on the Biology of Septobasidium. ‡—The species of this genus are confined to tropical countries, and encrust stems or leaves of living plants. From an examination of a long series of specimens, T. Petch has determined that they are parasites on scale-insects. One purple-black species, fairly common on tea, grows over the insect *Chionaspis biclaris*. Petch found that a North American fungus, known as *Thelephora lichentocola*, also showed a colony of scale-insects beneath the subiculum. He compares the genus with *Hypocrella*, a Pyrenomycete.

Notes on Larger Fungi.—N. Patonillard § has found among the fungi of New Caledonia a species of *Gallucca*, a Gasteromycete, of which only one species was previously known. It has the appearance of a tuber, but it was found on the surface of the soil. The new genus is near to *Hysterangium*.

A. de Jacewski ¶ writes on two forms of *Thyphallus* that he has lately come across. One, *I. imperialis*, was first found in Hungary. It is frequent in America though rare in Europe, and grows on sandy soil. It differs in several particulars from *I. impudicus*, in the colour and form of the egg, size of the spores, etc. The other, *I. amurensis*, is a new species from Russia in Asia; it is a small form.

L. Lutz ¶¶ gives some notes on *Ozonium*. His observations confirm those of Saccardo and of Plowright, who had discovered its connexion

* Agric. Journ. Union S. Africa, 1. (1911) p. 697 (1 pl.).

† Atti Reale Accad. Lincei, cccviii. (1911) pp. 835-40.

‡ Ann. of Bot., xxv. (1911) p. 843.

§ Bull. Soc. Mycol. France, xxviii. (1911) pp. 34-8 (2 figs.).

¶ Bull. Soc. Mycol. France, xxviii. (1911) pp. 81-9 (1 pl.).

¶¶ Bull. Soc. Mycol. France, xxviii. (1911) pp. 110-13 (4 figs.).

with species of *Coprinus*. Lutz found again the connexion between *Ozonium stuposum* and *Coprinus radiatus*.

Fresco-painting of Fungi.*—Leon Marehand has discovered an old Fresco in a chapel near Tours representing the temptation of Eve, in which the serpent is twisted round the tree that is, in reality, a branched sporophore of *Amanita*. A photograph of the picture was sent to Boudier, who gives a description of it and finds that the artist had evidently *A. muscaria* in his mind when he made the drawing of the "tree of good and evil."

Mycological Notes.†—C. G. Lloyd has published a new number of "Notes" relating to matters of interest to mycologists. He remarks on the successful completion by E. Boudier of *Icones mycologicae*, and gives an account of their publication. He gives also a portrait and note on Paul Klinecksieck, the publisher, who has spared neither expense, labour, nor care in producing the plates.

A note is also published on C. Torrend, the Portuguese mycologist. During the recent revolution in Portugal, the Jesuit College, where Torrend lived, was attacked by the mob and all the collections, microscopes, etc., were destroyed.

A paper follows on *Heragona*; several interesting specimens having been sent by Edouard Luga from the Congo Belge. *Lenzites ochroleuca*, sent from Bombay, India, proves to be a very variable fungus, rarely two collections being the same as to the hymenium. A photograph is published of *Mutinus Bambusinus* with a note on other Phalloids.

Poisoning by Fungi.—E. D. Clarke and J. L. Kantor ‡ have investigated *Inocybe infida*, as cases of poisoning were reported as due to eating this fungus. They separated a substance which had toxic effects on frogs, but it was not similar to muscarin. It is rather of the narcotic type, and produces lethargy.

Louis C. C. Krieger § discusses a case of poisoning, said to have been caused by eating *Coprinus comatus*, and he suggests that the specimens of *Panæolus campanulatus* had been gathered instead of *Coprinus*. The symptoms were the same as those produced by *Panæolus*.

Fat-destroying Fungi.||—Rohstri Ohta supports the statement of Kumagawa, that moulds destroy the fat of beef (organpulver). Of the species examined, *Cladosporium herbarum*, *Penicillium glaucum*, *Aspergillus glaucus*, *A. nidulans*, and *Actinomyces repens*, the latter was the most powerful agent; in three weeks it had destroyed 60 p.c. of fat in the sample tested. Other results of the experiments are noted.

Research on Diseases of Trees.¶—E. Nannch has attempted by means of infection experiments to determine the causes that induce

* Bull. Soc. Mycol. France, xxvii. (1911) pp. 31-3 (1 pl.).

† Cincinnati, Ohio, No. 37 (1911) pp. 493-508 (4 portraits and 9 figs.).

‡ Mycologia, iii. (1911) pp. 175-88 (1 pl.).

§ Mycologia, iii. (1911) pp. 200-2.

|| Biochem. Zeitschr., xxxi. (1911) p. 177. See also Centralbl. Bakt., xxx. (1911) p. 493.

¶ Naturw. Zeitschr. Land-Forstw., viii. (1910) pp. 389-408 and 425-47. See also Ann. Mycol., ix. (1911) p. 308.

disease in trees. He used pure cultures of a number of wood-destroying fungi—*Schizophyllum commune*, *Stereum purpureum*, *Polyporus ignarius*, etc. Sensitiveness to disease is connected first of all with the growth-condition of the trees; where they are overshadowed by other trees they are much more liable to infection than are trees in the open. The chief remedy, or rather preventive, against disease is the free entrance of air into the forest. Pruning and attention to wounds are also of importance. Certain fungi also excite to increased growth.

Plant-diseases in South Africa.—I. B. Pole Evans* records the wide prevalence of potato-scab due to *Oospora scabies*. He describes the appearance of the disease, which may be introduced into a crop in two ways: by means of contaminated tubers for seed purposes, or by using contaminated manure. He advises growers how to sterilize the seed-potatoes.

Ethel M. Doidge† contributes an account of a leaf-blight of pear and quince very prevalent in South Africa caused by *Entomosporium maculatum*. It destroys the leaves, the young branches, and also the fruits. In the latter it hardens and cracks the skin. The disease can be held in check by spraying with Bordeaux mixture.

I. Pole Evans‡ also describes the harm done to peaches by *Cladosporium carpophilum*. It causes dark-coloured patches on the fruit, which become hardened and tough. Winter spraying with Bordeaux mixture is recommended.

Plant-diseases.§—Jakob Eriksson remarks, on a paper published by E. Voges, that he cannot agree with his statement that red-coloured apples escape infection from *Fusicladium*, a statement not borne out by experience in Sweden. Eriksson agrees with Voges as to the means for combating the disease: collecting and burning all diseased leaves and fruit and spraying with fungicides.

A. von Jaczewski|| gives a number of cases in which good results followed the use of fungicides, especially with Bordeaux mixture. He also describes and recommends other solutions, giving the cases in which they would prove of service, especially in cases of hop disease, potato disease, vine mildew, apple blotch, etc.

Paul Sorauer¶ describes a case of bitter plums, which was found to be due to the growth of a *Gloosporium*, probably a wound fungus, and induced doubtless by a wet season, which caused so many fruits to crack.

Shot-hole fungus, *Cercospora circumsissa*, attacks the leaves of peach, almond, cherry, etc., and the part infested by the fungus drops out. The Board of Agriculture have issued a leaflet** describing the disease, and explaining how very serious it is. It is stated that when nursery stock is attacked to the extent of causing defoliation three seasons in succession,

* Agric. Journ. Union S. Africa, i. (1911) pp. 692-3 (1 pl.).

† Agric. Journ. Union S. Africa, i. (1911) pp. 694-5 (1 pl.).

‡ Agric. Journ. Union S. Africa, i. (1911) p. 696 (1 pl.).

§ Zeitschr. Pflanzenkr., xxi. (1911) pp. 129-31 (2 figs.).

|| Zeitschr. Pflanzenkr., xxi. (1911) pp. 135-45 (3 figs.).

¶ Zeitschr. Pflanzenkr., xxi. (1911) pp. 145-6.

** Leaflet No. 247 (1911) 4 pp. (3 figs.).

the trees never completely recover. Spraying with a fungicide is recommended to growers.

Notes have been published on the silver leaf disease, found by J. Percival to be due to *Stereum purpureum*. Experiments carried out at Woburn under the direction of Pickering* have proved the truth of the theory. The disease was induced in healthy trees by inserting a small piece of the fungus in a cut made in the bark. The disease is not always fatal: about one-third of the trees attacked eventually recover. Infected trees should be burnt.

F. Eulefield† chronicles cases of the death of five-year old pines caused by *Rhizina undulata*, which grew on the roots and spread from one tree to another through the soil.

In discussing‡ the parasitism of fungi, G. Arcangeli records the finding of *Fomes lucidus* on *Cedrus Deodara* and on *Abies cilicica*, both about thirty years old and in a decaying condition. He was doubtful if the fungus were the cause of disease. Another case is given of a tree on which grew *Fomes rubriporus*, but it had grown there many years without damaging the tree. He cites also the occurrence of *Armillaria mellea* growing for years near to some trees which remained uninjured.

W. O. Glover§ records the occurrence in Ohio of apple blotch, a disease caused by the fungus *Phyllosticta solitaria*. At the time the apples are about to be harvested the blotches are most prevalent, and the pycnidia begin to appear in the diseased spots below the epidermis of the apples. The fungus also attacks the leaves and twigs. Spraying and pruning are both essential for the control of this disease.

In a leaflet issued by the Board of Agriculture|| a description is given of strawberry leaf-spot (*Sphaerella fragariæ*), a disease of the leaves very common in all parts of the country, and when the injury is severe the yield of fruit may be seriously affected. The writer recommends spraying, or, after the fruit is gathered, mowing down the leaves and burning them over the strawberry beds.

A summary¶ of the diseases of garden plants is given by J. Lind. In Jutland, where there is much rain and a short summer, many trees are killed by cancer. In Seeland and other isles better conditions prevail, and cancer attacks the fruit-trees only in damp situations. Notes on other diseases are also given.

R. Laubert** writes on the most important diseases of the rose, one of which, *Coniothyrium wernsdorfiæ*, appears as brown spots on the branches in the early season of the year. The shoots above the parts attacked become enfeebled or die. A *Botrytis* disease attacks the flower-buds, especially in damp hot weather. *Peronospora sparsa* causes brown

* Journ. Board. Agric., xviii. (1911) pp. 38-9.

† Nat. Zeitschr. Forst.-Landw., viii. (1910) pp. 527-9. See also Ann. Mycol., ix. (1911) p. 202.

‡ Atti Soc. Tosc. Sci. Nat., xx. (1911) pp. 13-16.

§ Ohio Naturalist, xi. (1911) pp. 334-6 (4 figs.).

|| Leaflet No. 243, 2 pp. (1 fig.).

¶ Gartner Tidende, 1910, pp. 219-32. See also Bot. Centralbl., cxvi. (1911) pp. 569-70.

** Gartenflora, 1910, Heft 5. See also Zeitschr. Pflanzenkr., xxi. (1911) pp. 233-4.

spots on the leaves, which soon fall off. Various remedies are suggested to combat these fungi.

The attention of potato-growers* is directed to the importance of spraying their fields with Bordeaux mixture as a preventive against potato disease. In wet seasons, when the disease is prevalent, spraying is of great value, and, even in dry seasons, the treatment is beneficial to the crop. It is recommended that the plants be sprayed as soon as there is a good development of haulm in June or July, and again three weeks later. Full directions are given in Leaflet No. 23 (Potato Disease), published by the Board of Agriculture and Fisheries.

G. Lindau † comments on the rapid spread of epidemic diseases of plants, such as potato disease, mildew, etc. He is of opinion that there must be various meteorological factors concerned of which we know almost nothing.

G. Fron ‡ found the fungus *Lophodermium brachysporum* causing a malady of seedling pines by destroying the leaves on which it grew. The fungus has not previously been recorded in France. Good results were obtained in treating a similar fungus with Bordeaux mixture.

Ed. Griffon and A. Maublanc § publish a series of notes on plant diseases that had come under their observation. Leaves of *Helleboris niger*, the Christmas rose, showed large brown spots caused by a fungus that had already been identified as *Coniothyrium Hellebori*. The writers describe the appearance of the mycelium in the tissues of the leaf, and of the pycnidia which are scattered over the spots. They made successful artificial cultures, reproducing the entire development of the *Coniothyrium*.

The same authors || report the occurrence of the disease of the egg-plant caused by *Ascochyta hortorum*, already reported from the United States. It attacks the stalks, forming on them large brown spots covered with minute pycnidia. It also attacks the leaves and the fruits.

Further diseases were noted by them ¶ on cereals (*Helminthosporium*): on Beetroot (*Phoma tabifica*): on Potatoes (*Sclerotinia Libertiana*). Tomato plants, along with the potato, suffered in a specially wet season from the ravages of *Phytophthora infestans*. Notes are given on the treatment of vine mildew by Bordeaux mixture, and of the loss sustained where the vines have been neglected. There is a record of the progress of oak mildew, which threatens to destroy the young oaks. Gooseberry mildew has not been noted in France, but the writers do not see how it can eventually be kept out, as it has spread almost over the whole continent. They warn agriculturalists against warted-scab of potatoes caused by *Chrysophyctis endobiotica*. They describe the appearance of the disease and the methods adopted for stamping it out.

Dorogune ** reports a disease of Pine-needles caused by *Cytosporina septospora* sp. n. The fungus causes yellow spots on the needles, cover-

* Journ. Board Agric., xviii, (1911) pp. 229-30.

† Nat. Wochenchr., n.f., ix, (1910) pp. 625-9. See also Bot. Centralbl., cxvii, (1911) p. 46.

‡ Bull. Soc. Mycol. France, xxvii, (1911) pp. 44-6 (3 figs.).

§ Bull. Soc. Mycol. France, xxvii, (1911) pp. 47-50 (2 figs.).

|| Bull. Soc. Mycol. France, xxvii, (1911) pp. 50-3 (1 fig.).

¶ Bull. Soc. Mycol. France, xxvii, (1911) pp. 53-67.

** Bull. Soc. Mycol. France, xxvii, (1911) pp. 105-6 (3 figs.).

ing often a quarter to half the whole surface. This is the only species of the genus with septate spores.

G. Pethybridge* has published a second report on the diseases that affect potatoes in West Ireland. He gives the results of experiments in spraying the plants with Bordeaux mixture to destroy the blight caused by *Phytophthora infestans*. He recommends early spraying. The question of infection is discussed and the theory of dormant mycelium in the tubers is not considered tenable, as in no case was it found that hyphæ passed up the stalks to the leaves. *Sclerotinia sclerotiorum*, a stalk disease, works great havoc among the potatoes. It is probably a wound fungus and infection takes place from aerial spores and not from the soil. Fungicides were not found to be very effective. Besides *Sclerotinia* the plants are often attacked by *Botrytis*: the black sclerotia of this fungus arise on the surface of the stalk. Careful weeding and the securing of dry conditions are recommended. A bacterial disease is next described; it causes rot in potatoes and also in swedes, carrots, and parsnips. Infection probably takes place from the soil. Diseases due to *Spongospora subterranea* and to *Hypochnus Solani* are also described; results of experiments are given, and remedies dealt with. The paper is well illustrated by figures reproduced from photographs.

A species of *Nummularia* (*N. discreta*) † was found on the fallen branch of an apple-tree at Sandsend, near Whitby, Yorkshire. It is usually saprophytic, but may be a wound parasite, and has been destructive to apple-trees in the United States. It is now recorded for the first time in this country. The first indication of disease is a brown and more or less sunken appearance of the bark, in patches which are usually scattered over a considerable area. Eventually the patches become dry and cracked, and the fruits of the fungus appear on the wood.

Mycorrhiza of Gastrodia. ‡—S. Kusano publishes a preliminary note on this subject. *Gastrodia* has a much reduced vegetative organ, being represented simply by a tuberous rhizome. It forms mycorrhiza with the rhizomorph of *Armillaria mellea*, the fungus penetrating by a sucker-like branch of the rhizomorph strand. The tuber is so far dependent on the mycorrhiza that unless it is present the offsets produced tend to become small. In some cases, however, the fungus penetrates deeper into the tuber and injures it.

BAINIER, G., & A. SARTORY—**Etude d'une espèce nouvelle de Sterigmatocystis** (Study of *Sterigmatocystis flavipes*.)

[Cultural studies were made.]

Bull. Soc. Mycol. France, xxvii.

(1911) pp. 90-7 (1 pl.).

“ “ “ **Etude de *Aspergillus cinereus* sp.n.** (Study of *Aspergillus cinereus*.)

[Cultures were made and results noted.]

Bull. Soc. Mycol. France, xxvii.

(1911) pp. 98-104 (1 pl.).

BERGAMESCO, G.—**Specie dei generi *Amanita* Pers. ed *Amanitopsis* Roz. che crescono nel Bosco dei Camaldoli, presso Napoli.** (Species of the genera *Amanita* and *Amanitopsis* that grow in the forest of the Camaldoli, near Naples.)

[List of species observed.]

Bull. Soc. Bot. Ital., 1911, pp. 13-16.

* Journ. Dept. Agric. Tech. Instr. Ireland, xi. 3, 34 pp. (14 figs.).

† Journ. Board Agric., xviii. (1911) pp. 314-15 (1 pl.).

‡ Ann. of Bot., xxv. (1911) pp. 521-2.

- BRESADOLA, J.—**Fungi Congoenses.**
[A large number of species from the Congo are listed, some of them new to science.] *Ann. Mycol.*, ix. (1911) pp. 266-76.
- BRITTON, E. G.—**Fungi on Mosses.**
[List of mosses supplied by G. Massee on which *Cladosporium epibryum* was found.] *Mycologia*, iii. (1911) p. 206.
- GYÖRFFY, ISTVÁN—**Novitas Bryologica** *errore* *Cryologica*.
[Fungi parasitic on mosses, translated by Ed. Chamberlain.] *Bryologist*, xiv. (1911) pp. 41-3 (1 pl.).
- HARTER, P. L.—**A New Species of Alternaria.**
[The fungus causes spots on *Forsythia*.] *Mycologia*, iii. (1911) pp. 154-5.
- HÖHNEL, F. VON—**Zur Systematik der Sphærospideen mid Melanconieen.**
[A scheme of classification for these difficult groups of fungi.] *Ann. Mycol.*, ix. (1911) pp. 258-65.
- „ „ **Ueber Coniodictyum Har. et Pat. und Hyalodema P. Magn.**
[The writer insists that *Coniodictyum Chevalieri* is identical with *Hyalodema Evansii*, and that the fungus belongs to the Melanconieæ.] *Ann. Mycol.*, ix. (1911) pp. 213-16.
- HOLLRUNG, M.—**Jahresbericht über das Gebiet der Pflanzenkrankheiten.** (Annual report on plant diseases.)
[Résumé of all work done during the year on diseases caused by animals, fungi, etc.] Berlin: Paul Pary, xii. 1909 (1911) viii. and 356 pp.
- JACZEWSKI, A. VON—**Bemerkungen zu der Mitteilung von P. Magnus über Bresadolia caucasica.** (Remarks on the communications of P. Magnus on *Bresadolia caucasica*.)
[The writer sees reason to agree with P. Magnus that the plant is a monstrous form of *Polyporus squamosus*.] *Hedwigia*, l. (1911) pp. 253-4 (1 fig.)
- KOLKOWITZ, JAHN & MINDEN—**Pilze.**
[The part issued deals with Myxobacteriæ and with Chytridineæ.] *Kryptogamenflora der Mark Brandenburg*, v. 2 (1911) pp. 193-352 (figs.).
- KRIEGER, W.—**Eine neue mycosphærella aus Sachsen.** (A new *Mycosphærella*.)
[Found on leaves of *Solidago Virga aurea* in Saxony.] *Ann. Mycol.*, ix. (1911) p. 216.
- MIGULA, WALTER—**Kryptogamen-Flora.**
[Three fascicles have been recently issued, dealing with various genera of *Polypori*.] *Flora von Deutschland*, v. lief. 111-14 (1911) pp. 209-72 (15 pls.).
- MOLZ, E.—**Untersuchungen über die Wirkung des Karbolineums als Pflanzenschutzmittel.** (Action of carbolineum as a fungicide and insecticide.)
Centralbl. Bakt., xxx. (1911) pp. 181-232 (8 pls. and 1 fig.).
- MURRILL, W. A.—**Illustrations of Fungi. VIII.**
[Sixteen of the smaller forms, mostly of Agarics, are printed in colour.] *Mycologia*, iii. (1911) pp. 97-105.
- „ „ **Illustrations of Fungi. IX.**
[Illustrations in colour and descriptions of seven species.] *Mycologia*, iii. (1911) pp. 165-9 (1 pl.).
- „ „ **The Agaricæ of Tropical North America. III.**
[Descriptions of species from Jamaica, Mexico, etc., mostly new.] *Mycologia*, iii. (1911) pp. 189-99.
- PALM, B.—**Nye bidrag till Stockholmstraktens Svampflora.** (New contributions to the fungus-flora of the Stockholm district.)
[A list of microfungi.] *Svenskr. Bot. Tidsskr.*, iv. (1910) pp. 1-8.
See also *Ann. Mycol.*, ix. (1911) p. 301.
- PODPERA, JOSEF—**Ein Beitrag zu der Kryptogamenflora der bulgarischen Hochgebirge.** (Contribution to the Cryptogamic flora of the Bulgarian highlands—Ascolichens.) *Beih. Bot. Centralbl.*, xxviii. (1911) pp. 195-9.

REHM—**Ascomycetes exs. Fasc. 48.**

[Specimens 1926-50 are listed, with notes and references.]

Ann. Mycol., ix. (1911) pp. 286-90.RICKEN, ADALBERT—**Die Blätterpilze.**

[The Agaricaceæ of Germany and neighbouring countries, especially Switzerland and Austria.]

Leipzig: Oswald Weigel, 1911, lief. 3-4, pp. 65-128 (15 col. pls.).

RYTZ, WALTHER—**Beiträge zur Kenntniss der Pilzflora des Kientales.** (Contribution to a knowledge of the fungus-flora of the Kien valley.)[A considerable number of species are listed; two are new to science—*Uromyces Poæalpinæ* and *Coprinus giganteus*.]*Mitt. Naturf. Ges. Bern*, 1910 (1911) pp. 64-81 (1 pl.).SACCARDO, P. A.—**Nota Mycologica.**

[Notes on microfungi from many localities.]

Ann. Mycol., ix. (1911) pp. 249-57.SYDOW, H. & P.—**Fungi Africani novi.** (New African fungi.)[A list of twenty new parasitic species, with a special discussion of *Hemileia*.]*Engler's Bot. Jahrb.*, xlv. (1910) pp. 259-65.See also *Ann. Mycol.*, ix. (1911) pp. 302-3.VUILLEMIN, PAUL — **Les Isaria de la famille de Verticilliacées (Spicaria et Gibellula).**[Notes on various species of *Gibellula*, etc.]*Bull. Soc. Mycol. France*, xxvii. (1911) pp. 75-82 (figs.).

Lichens.

(By A. LORRAIN SMITH, F.L.S.)

Relation of Siliceous Lichens to the Substratum.*—E. Bachmann studied this subject on granite rocks. He found: 1. That granite is reduced by the lichens comparatively quickly to a clay-like finely granular yellow mass. 2. The lichen particles push from the edge of the granite to the bottom of the small depression in which they are growing and seize with avidity on the mica. More rarely the lichen spreads over the surface of the granite. 3. The spread of the lichen over the rock is directed by the chances of humidity and of gripping the stone.

Northern Species of Alectoria in America.†—R. Heber Howe has determined ten distinct species of *Alectoria* that occur in the transitional and Boreal zones. He finds that the genus presents a difficult and complex problem, due to the enormous variations that occur in filamentous lichens, but he insists on taking the broadest view of species, and on allowing the two extremes of variation to stand far apart. Most of the species are European as well as American. Careful descriptions and notes are given of the different species.

HERRE, W. C. T.—**The Gyrophoraceæ of California.**

[An account of Gyrophora and Umbilicaria, with keys to the species, and descriptions.]

Contr. U.S. Nat. Herb., xiii. 10 (1911) pp. 313-21 (6 pls.).HESSE, O. — **Beitrag zur Kenntniss der Flechten und ihrer charakteristischen Bestandteile.** (Contribution to a knowledge of lichens and their characteristic constituents.)

[Account of acids extracted from various lichens.]

Journ. praktische Chemie, n.f. lxxxiii. (1911) pp. 22-96.See also *Bot. Centralbl.*, cxvii. (1911) pp. 93-4.* *Ber. Deutsch. Bot. Gesell.*, xxix. (1911) pp. 261-73.† *Mycologia*, iii. (1911) pp. 106-50 (7 pls.).

- HOWE, R. HEBER—**The Genus *Evernia* as represented in North and Middle America.**
 [The genus is divided into the sections *Letharia*, *Archevernia*, and *Euervernia*; the latter with one species, *E. trulla*.]
Bot. Gaz., li. (1911) pp. 431-42 (2 pls.).
- „ „ **List of Lichens collected in the Yukon Region by R. S. Williams.**
 [Eighty-two species are listed.]
Bull. Torrey Bot. Club, xxxviii. (1911) pp. 287-93.
- LESDAIN, BOULY DE—**Lichens Belges rares ou nouveaux.** (List of crustaceous lichens new to Belgium or rare.)
Bull. Soc. Roy. Bot. Belg., xlvi. (1910) pp. 39-45.
- OLIVIER, H.—**Lichens d'Europe. II.**
 [305 species are recorded in this fascicle; synonymy, locality, and habitat are given, with keys to genera and species, and with index.]
Mém. Soc. Nat. Sci. Nat. Math. Cherbourg, xxxvii. (1908-10) pp. 29-200.
- STEINER, JULIUS—**Adnotaciones lichenographicae.**
 [New species and new varieties of lichens are described from various localities.]
Oesterr. bot. Zeitschr., 1911, Nos. 5, 6 (8 pp.).
- „ „ **Flechten aus dem italienische-französischen Grenzgebiete und aus Mittelitalien.** (Lichens from the borderland between France and Italy and from Central Italy.)
 [A large number of species are listed, including many new species.]
Verh. k.k. Zool. Bot. Ges. Wien, 1911, pp. 29-64.
- ZAHLBRUCKNER, ALEXANDER—**Transbaikalische Lichenen.** (Lichens from beyond L. Baikal.)
Trav. Sous. Sect. Troitzk.-Kiakhta, Section du pays d'amour Soc. Imp. Russe de Géogr., xii. Liv. 1-2 (1909) pp. 73-95.

Mycetozoa.

(By A. LORRAIN SMITH, F.L.S.)

Studies in Myxomycetes.*—E. Jahn has made many spore cultures and studies of plasmodium to determine the occurrence of sexuality in the Myxomycetes. He states that in many species plasmodium formation can be observed. As soon as ciliated spores are formed he advises drying, when these become encysted, and with renewed wetting they divide; this can be repeated several times. The species most easily dealt with were *Stemonitis fusca*, *Trichia varia*, *Oligonema nitens*, *Physarium nutans*, *P. compressum*, and *P. didermoides*. Jahn sums up his results thus: 1. Plasmodium formation begins among numerous amœbæ at certain points with small amœbæ-like stages. 2. These young plasmodia exercise no attractive influence on surrounding amœbæ; they devour them when they encounter them. 3. Nuclear increase follows also from the earliest stages in normal development of karyokinesis. 4. In young plasmodia with normal development the numbers of nuclei are always even; uneven numbers are very rare. 5. Plasmodia nuclei have the double chromosome number of the amœbæ nuclei. 6. An amœboid and nuclear copulation could be seen. 7. Nuclear division before spore-formation is a reduction division.

* *Ber. Deutsch. Bot. Gesell.*, xxix. (1911) pp. 231-47 (1 pl.).

Alternation of Generations in Myxomycetes.*—V. Vouk has considered the Myxomycetes from a biological and cytological standpoint. He concludes that the zoospores are the vegetative stage or progametophyte; the myxamœbæ, also a vegetative stage, and the plasmodium or generative stage, belong to the gametophyte generation. The fruiting body with spores, the fructificative stage, corresponds to the sporophyte. He calls the first generation a water-form, the second a land-form, of life.

New Research on Plasmodiophoraceæ.†—René Maire and Adrien Tison have made further studies of *Sorosphæra Veronicæ*, and of *Tetramyxa parasitica*, which they also include among the Plasmodiophoraceæ. It forms tumours on *Ruppia rostellata*. A series of forms that do not form tumours have been described by them under the genus *Ligniera*. The parasite of *Triglochin*, *Tetramyxa triglochinis*, is constantly asexual, and has been placed in a new genus *Molliardia*. Schizogonic mitosis is remarkably similar in all the known Plasmodiophoraceæ, and the absence of multiple karyogamy before spore-formation thus separates the family from the Myxomycetes. The affinity of *Ligniera* with *Rhizomyxa* and *Woronina* suggests the origin of Plasmodiophoraceæ as near to the Chytridiales.

Spongospora subterranea.‡—T. G. B. Osborn has written an account of the life-history and cytology of this parasite of the potato. It lives in the cells of the tuber in an amœboid condition, and invades the new cells as they are formed in the tissue. The nuclei of the amœbæ divide amitotically, and then fuse to form a plasmodium. This is followed by degeneration, and the vegetative nuclei are replaced by chromidia—the akaryote stage. Following this, the nuclei are formed on different sites from the previous ones, some chromidia being used in the process while the remainder degenerate. Karyogamy takes place between pairs of nuclei, after which the enlarged nuclei show contraction of the chromatin, possibly a condition of synapsis. Two karyokinetic divisions of the nucleus follow, the second having eight chromosomes. The spores are uninucleate, and are massed into spore-balls. *Spongospora* is a member of the Plasmodiophoraceæ.

Life-history of *Sorosphæra graminis*.§—E. J. Schwartz found this new species on tubercles on the roots of grasses. The swellings were caused by eel-worms; the second parasite was an amœboid organism, which proved to be a *Sorosphæra*. The grasses were partially affected by the presence of the tubercles; they were less healthy and less frequently in flower. Schwartz describes carefully cytology and development of the species. It is closely allied to *S. Junci* and *S. Veronicæ*, and does not materially differ from them in its life-history.

* Oesterr. Bot. Zeitschr., lxi. (1911) pp. 131-9. See also Bot. Centralbl., cxvii. (1911) p. 33.

† Ann. Mycol., ix. (1911) pp. 226-16 (5 pls.).

‡ Ann. of Bot., xxv. (1911) pp. 327-41 (1 pl.).

§ Ann. of Bot., xxv. (1911) pp. 791-7 (1 pl.).

Schizophyta.

Schizomycetes.

Bacillus Cellulosæ Desagregans sp. n.*—From the intestinal contents of fowls A. Distaso has isolated an organism which possesses the power of breaking up cellulose. For the purpose of his experiments the author made use of Berzelius' paper. A short straight bacillus, with square ends, forming oval subterminal spores, this organism is with difficulty stained by Gram's method, and does not resist prolonged decolorizing. It is a facultative anaerobe, incapable of growth at 22° C., but growing well in glucose-agar at 37° C., not producing gas. It attacks glucose freely, and is without action on maltose, lactose, or saccharose. It changes starch rapidly into sugar. It decomposes the cellulose in filter-paper, potato, salads, and peas, forming sugar.

Spirophyllum ferrugineum.†—In this paper D. Ellis replies to the criticisms made by Molisch upon the authenticity of this species. This new species of iron-bacterium was first described in a paper‡ communicated to the Royal Society of Edinburgh. In his book upon the iron-bacteria Molisch expresses the view that this organism is identical with *Gallionella ferruginea*. In the present paper D. Ellis emphasizes the points of distinction between the two species. *Spirophyllum* appears as a spiral band, *Gallionella* has the form of a thread twisted spirally round itself. The former has been watched through the complete course of its life-history, and no evidence of transition between this and *Gallionella* has been observed. In its young stages *Spirophyllum* is motile; no motile phase has been observed in *Gallionella*. The author further defends his observations, which also were attacked by Molisch, that conidia-formation takes place in *Spirophyllum*, *Gallionella*, and *Leptothrix*. The paper is illustrated by microphotographs.

Pigment of Azotobacter Chroococcum.§—W. L. Omeliansky and O. P. Ssewerowa, after a review of the literature upon this subject, give an account of their own observations. Various strains of this organism isolated from the soil show differences in their powers of producing pigment. Between good pigment-producers and strains which do not show any pigment there are intermediate strains. The age of the culture has some influence upon this, an old brown culture, when replanted, giving rise to a growth which rapidly produces pigment. Free access of air is necessary, and the optimum temperature is 30° C. The most suitable medium for stimulating pigment-formation is chalk-dextrin-agar containing 2-3 p.c. of dextrin. The pigment is insoluble in most reagents, but dissolves in alkalis, probably undergoing a chemical change. It is possible that this brown pigment may be a factor in determining the prevalent brown colour of the soil.

Human and Bovine Tubercle.||—A. Eber records experiments which give additional support to the hypothesis that tubercle bacilli of the

* C.R. Soc. Biol. Paris, lxx. (1911) pp. 995-6.

† Proc. Roy. Soc. Edinburgh, xxxi. (1911) pp. 499-504.

‡ Proc. Roy. Soc. Edinburgh, xxvii. 1 (1907).

§ Centralbl. Bakt., 2^o Abt., xxix. (1911) pp. 643-50.

|| Centralbl. Bakt., 1^o Abt. Orig., lix. (1911) pp. 193-364.

human and bovine types are identical. Material from a number of cases of phthisis were inoculated into guinea-pigs. Simultaneous subcutaneous and intraperitoneal inoculations of material from these guinea-pigs into cattle produced lesions from which were obtained bacilli, which were shown both by inoculations and culture to belong to the bovine type, although the bacilli obtained from the patients showed all the characters of human tubercle. In one case inoculation into cattle of a pure culture of tubercle bacilli of the human type, obtained from a patient suffering from tubercle of the knee-joint, produced lesions from which bovine bacilli were isolated.

Alopecia areata of Bacterial Origin.*—F. Guéguen has found that certain cases of recurrent alopecia are due to the invasion of the hairs by a micro-organism, to which he has given the name *Bacillus endothrix*. Microscopical examination of the diseased hairs shows the presence of striations, which are resolved, under a high power, into chains of short bacilli. In a cross section of the hair these appear as cocci. A small number of these organisms are found in the follicles. In order to obtain a growth of *B. endothrix* short sections of hair are planted on end upon the surface of a peptone-gelatin slope, the outside of the hair having been freed previously from adherent contaminating organisms. Small chrome-yellow colonies appear in 48 hours. Morphologically the organisms are short, capsulated, Gram-positive organisms, which possess neither spores nor flagella. In older cultures there is a marked tendency to pleomorphism. Gelatin is not liquefied, sugars are not fermented. A number of inoculation experiments have been performed with negative results.

Studies of the Intestinal Flora.†—A. Distaso has made a study of certain bacteria, components of the intestinal flora, which can survive in an acid medium and decompose carbohydrates, producing simple acids, such as acetic acid. The principal members of this group are *Bacillus bifidus* and *Coccus banani*. The types here described are *Bacillus acetogenus* α and β , *B. acetogenus proteiformis* sp. n., *B. butyricus pseudobulgaris* sp. n., *B. dimorphus* sp. n., and *B. parvirelis* sp. n. A full account of the morphological character of these new forms is given. In a consideration of the part played by these bacteria in the intestine it is pointed out that they can inhibit the growth of putrefactive organisms, and moreover that the acids produced stimulate peristalsis. The more complex substances produced by bacteria of the *B. coli* group will also stimulate peristalsis, it is true, but the movements so produced are violent, leading possibly to diarrhœa, whereas those due to the acetogenic group are gentle, not exceeding normal physiological movements, while sufficient to prevent stasis. These organisms all have certain characteristics in common. They are Gram-positive and decompose sugars with great activity. They grow well upon sugar media, producing acetic or lactic acid, and with difficulty upon alkaline media. They are very polymorphic.

In a second contribution ‡ the author considers the intestinal an-

* Centralbl. Bakt., 1^{te} Abt. Orig., lix. (1911) pp. 1-20.

† Centralbl. Bakt., 1^{te} Abt. Orig., lix. (1911) pp. 48-63.

‡ Centralbl. Bakt., 1^{te} Abt. Orig., lix. (1911) pp. 97-103.

aerobes, which have proteolytic functions. The morphological characters of ten new species are described in full. These organisms have a very wide distribution in nature.

Sarcina Citrea conjunctivæ.*—From the conjunctival sac of a patient suffering from conjunctivitis Ph. Verderame has isolated a Gram-negative organism, to which he has given the above name. It grows well upon the ordinary media, both at room temperature and at 37° C., and is a facultative anaerobe. Blood-serum is liquefied, but not gelatin. Milk is not clotted. Neither flagella nor spores can be demonstrated, and the organism is non-motile. Colonies upon most media develop a lemon tint, which gives the *Sarcina* its specific name. It must be distinguished from *S. citrina*, a Gram-positive organism, which liquefies gelatin and clots milk.

New Anaerobe in Typhoid Stools.†—By inoculating this material into a fluid medium composed of a mixture of bile and broth, containing a small cube of cooked white of egg, and after two or three days planting some of the deposit from this medium in glucose-agar, J. Loris-Melikov has obtained colonies of an anaerobic bacillus which has, in his opinion, an important influence upon the course of the disease. The colonies are small and transparent. The bacilli are non-motile, forming ovoid spores, and retain the colour upon the application of Gram's method. They are strict anaerobes, and grow well only at 37° C. Inoculation experiments show that they have a specific effect upon the lymphoid tissue of the intestines, causing swelling and ulceration of the follicles and of Peyer's patches. They have not been found in the stools of persons not suffering from typhoid. They are agglutinated by typhoid serum in a dilution of 1 : 100. The author considers that this organism has a necrosing action in typhoid fever, supplementing the septicæmia caused by Eberth's bacillus.

Pathogenicity of Bacillus chlororaphis.‡—This organism, isolated from certain spring-waters, has the property of producing a green crystalline pigment upon cultures under special conditions. L. Mercier and Ph. Lassenur have injected cultures of this bacillus into crayfish, frogs, bream, and other fresh-water fishes, with fatal results in the majority of cases. Further experiments are still in progress, particularly feeding experiments, and the evidence as to the pathogenicity of this organism is not yet complete.

Rat Plague in East Anglia.§—In the autumn of 1910 it became known that an extensive epizootic of plague was affecting the rodents in a certain portion of Suffolk. The occurrence of a few human cases in October called attention to the dangers of such an epizootic, and in the beginning of 1911 systematic investigations were carried out with a view to ascertaining the boundaries of the infected area. G. F. Petrie and G. H. Macalister examined more than 6000 rats collected from a

* Centraltbl. Bakt., 1te Abt. Orig., lix. (1911) pp. 377-85.

† C.R. Soc. Biol. Paris, lxx. (1911) pp. 865-6.

‡ C.R. Soc. Biol. Paris, lxx. (1911) pp. 889-91.

§ Rep. Local Gov. Board, n.s. No. 52 (1911) viii. and 87 pp. (2 maps).

wide marginal zone bounding the known infected area. The great majority of these rats were perfectly healthy. Seventy-three rats, set aside for further enquiry, either because the possibility of plague infection was suspected or because some pathological feature of interest was present, were found to be infected with the Gaertner bacillus or some other irrelevant organism. From three rats an organism was isolated which resembled the *Bacillus pestis* morphologically and culturally. Further investigation, however, of the sugar reactions of these organisms and of their virulence to rats showed that they must be regarded as identical with *B. pseudotuberculosis rodentium* rather than *B. pestis*. So that no plague-infected rats were found in the marginal zone investigated.

Bacteriological Studies of Danish Butter.*—O. Jensen remarks upon the use of lactic ferments in the preparation of butter, and states that his investigations show that such soured butter remains freer from contamination by harmful organisms than simple butters. Pasteurization, salting, and lactic ferments are three factors which cause a simplification in the flora of butter. The lactic acid organisms principally used in Denmark are two species of streptococci, a finer form, *Diplococcus acidi lactici*, and a coarser form, occurring in long chains. It has been found that the two organisms working together have a greater lactic fermentation power than have either of them when working in pure culture. Discussing the disorders of butter, the author mentions "cheesiness," which is due to the invasion of *Streptococcus casei amari*. He has also found in some samples a butter-fat-splitting form, *Bacillus fluorescens liquefaciens*. The author further discusses moulds and yeasts met with upon butter under various conditions.

Variation and Adaptation in Bacteria.†—E. W. A. Walker, who has made observations upon streptococci with special reference to the value of fermentation tests as applied to these organisms, arrived at the following conclusions. The reactions of any given strain of streptococcus in Gordon's media‡ vary considerably under the conditions of ordinary laboratory cultivation, and by suitable manipulation of the culture-media they can readily be made to vary very greatly. The results obtained entirely oppose the view that these reactions afford a means of distinguishing fixed and definite varieties among streptococci isolated from the human subject. Such differences as are observed are of a temporary and accidental character, and are not in any sense specific, though they may perhaps afford some evidence of the natural habitat or previous environment of the organisms concerned.

SCHROETER & GUTJAHR—Vergleichende Studien der Typhus-coli-Dysenteriebakterien in Ausschlag an eine kleine Ruhr-epidemie in Mitteldeutschland.

Centralbl. Bakt., 1^{te} Abt. Orig., lviii. (1911) pp. 577-624.

STEVENSON, W.—The Distribution of the "Long Lactic Bacteria"—Lactobacilli.

Centralbl. Bakt., 2^{te} Abt., xxx. (1911) pp. 345-8.

* *Centralbl. Bakt.*, 2^{te} Abt., xxix. (1911) pp. 610-16.

† *Proc. Roy. Soc.*, Series B, lxxxiii. (1911) pp. 541-58.

‡ See this Journal, 1906, p. 87.

MICROSCOPY.

A. Instruments, Accessories, etc.*

(1) Stands.

Garjeanne's Simple Excursion Microscope.† — A. J. M. Garjeanne describes this instrument, which has been made to his designs by Messrs. W. Watson and Sons, London. The weight of this Microscope, when made of the ordinary brass and iron, does not exceed 1250 gm. : but

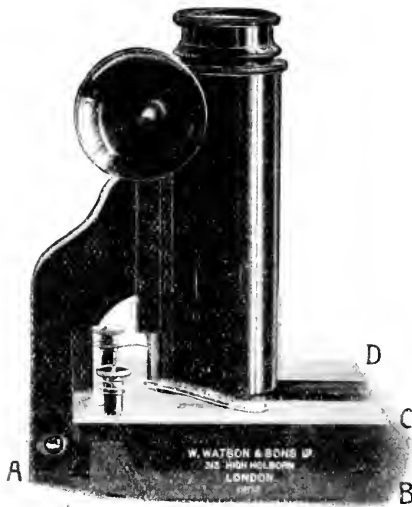

FIG. 74.

this might be considerably reduced by the use of lighter metal. The instrument can be packed in a mahogany box $15.5 \times 11 \times 11$ cm., weighing 500 gm. ; the box provides room for two objectives, two oculars, and some small utensils. Fig. 74 shows the stand shut up, the height to the lower rim of the ocular being only 12.8 cm. The dimensions of the foot confer great stability, and are, $AB = 9.8$ cm., $CD = 7.8$ cm. The object-stage is rectangular, 8.6×7.8 cm., and is made with the Nelson cut-out. A simple diaphragm-disc is below the stage. The

* This subdivision contains (1) Stands; (2) Eye-pieces and Objectives; (3) Illuminating and other Apparatus; (4) Photomicrography; (5) Microscopical Optics and Manipulation; (6) Miscellaneous.

† Zeitschr. wiss. Mikrosk., xxviii. (1911) pp. 56-8 (2 figs.).

total length of the tube is 16 cm. open, 10·3 cm. closed. The peculiarity of the stand is the absence of a pillar between the foot and the hinge for oblique position (fig. 75). The mirror works in a clamping-ring between the toes of the horse-shoe foot; it can be shifted forwards and backwards. When the stand is inclined at about 30° the distance



FIG. 75.

between the mirror centre and the diaphragm centre is about 4 cm., and the sliding adjustability of the mirror renders it possible to bring the mirror centre into the optical axis. As will be noticed from the illustrations, there is only one adjustment, a rack-and-pinion. But in all modern instruments the rack-and-pinion is so well made that it suffices for this Microscope.

Winkel's Demonstration Microscope with Detachable Foot.—A short description of this instrument (figs.76, 77) will be found on p. 497.

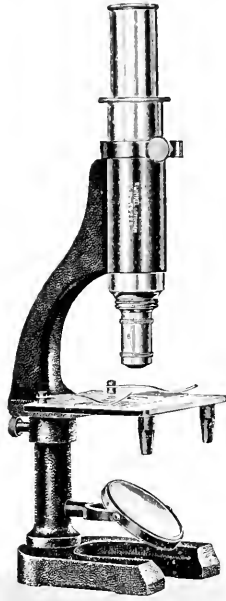

FIG. 76.

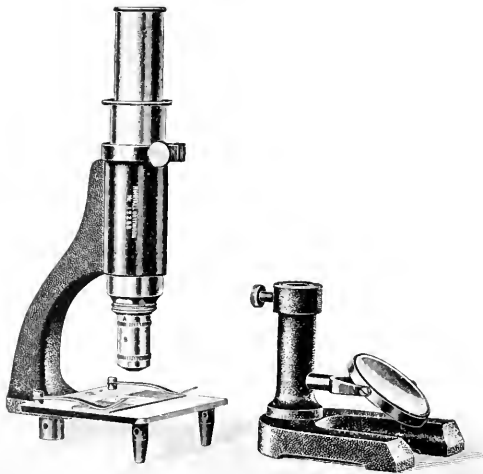

FIG. 77.

Recent Progress in the Construction of Mineralogical and Metallurgical Microscopes.*—E. Sommerfeldt treats of this subject with especial reference to the last decade. The following are the titles of his sections and sub-sections:—

1. *The Petrographic Microscope.*—Wide-angled types; improvements in the condenser; microscopes with simultaneous rotatory nicols.

2. *The Crystallographic Microscope.*—Stands for observations at high temperatures; stands for universal (rotatory) methods.

3. *The Metallographic Microscope.*

4. *Microscopical Auxiliaries.*—Condenser and ocular; heating apparatus; hardness measurements; accessories for metallographic microscopy.

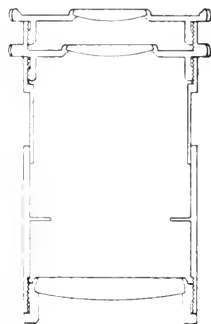

FIG. 78.

(2) Eye-pieces and Objectives.

Allan's Variable Eye-piece.—This eye-piece (fig. 78) was fully described by Mr. Conrad Beck at the June Meeting (see Proceedings, ante, p. 570).

(3) Illuminating and other Apparatus.

History of the Cardioid Condenser: Memorandum on the Leitz Mirror Condenser.†—In order to correct a somewhat ambiguous reference in A. Gleichen's *Die Theorien der modernen optischen Instrumente*,‡ W. v. Ignatowsky supplies the following information about the cardioid condenser. He states that Siedentopf's cardioid was first described in September, 1909, but that his (Ignatowsky's) had been actually placed on the market by Leitz in October, 1907, and its theory had been published in 1908. It has, in fact, been shown by Schwarzschild,§ as Siedentopf admits, that the cardioid condenser is a special case of a more general construction. The author gives an outline of Schwarzschild's investigation.

Apparatus for Microscopical Observation of Frozen Objects.|| E. Schaffnit's cold-chamber is constructed out of a rectangular metal box, 9 by 2 cm. and 2.5 cm. deep. The glass lid slides in a groove, and is perforated for reception of the Microscope objective; the metal floor is similarly perforated for receiving the condenser (fig. 79). The object-carrier *d*, about 15 cm. long, slides through a slit in the side wall *c*, and is steadied by two clips. The side walls are perforated for the escape of the carbonic acid vapours. A suitably graduated thermometer *g* passes through the front wall. Two watch-glasses for ether are placed on the chamber-floor, and are filled with a pipette. There is a suitable tube-attachment to a carbonic acid steel cylinder; it is desirable to

* Zeitschr. wiss. Mikrosk., xxviii. (1911) pp. 70-82.

† Zeitschr. wiss. Mikrosk., xxviii. (1911) pp. 50-55 (2 figs.).

‡ Stuttgart: F. Enke, p. 248.

§ Abhandl. d. Kgl. Gesell. d. Wiss. z. Göttingen, Math. Physik, Klasse: IV. "Untersuchungen zur geometrischen Optik ii."

Zeitschr. wiss. Mikrosk., xxviii. (1911) pp. 45-8 (2 figs.).

place the cylinder on the observer's left, so that he can with his left hand regulate the outflow of gas. The whole chamber is clamped to the Microscope. With a continuous stream of gas a temperature of -30°C . is quickly and easily attained. The author has not found any injurious results happen to his lenses.

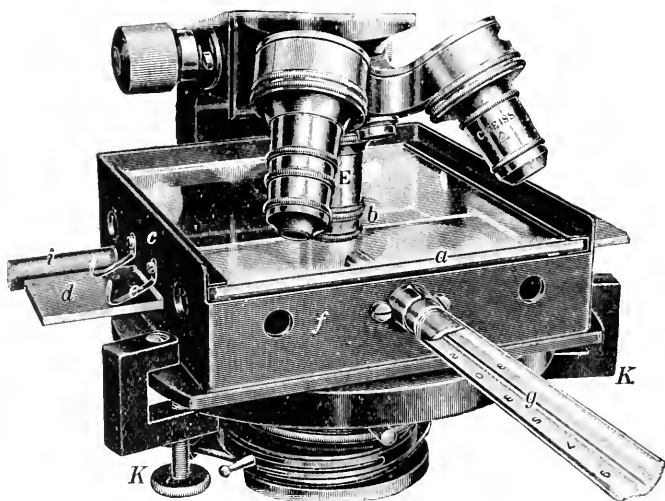

FIG. 79.

Leiss' Universal Spectral Apparatus.*—This apparatus has been constructed by the firm of Fuess, and many of its novelties have been suggested by J. Koenigsberger. The instrument is intended to be available for observations upon emission spectra, absorption spectra, Zeeman effects, wave motions, and measurements of layer thicknesses. Fig. 80 gives a general view of the apparatus, and fig. 81, which is a horizontal section through the collimator and the telescope, represents the optical arrangements. The bearer Λ of the observation-telescope is rotatory about a conical vertical axis carried on a strong tripod fitted with levelling screws. The bellows also, as far as possible, take part in this rotatory movement. The lever screws a clamp A , while the micrometer-screw a_1 operates the fine-adjustment. Connected with this is a drum graduated into 150 equal parts, each part corresponding to an angular distance of $10''$. A large loop L facilitates the reading of the drum divisions, an electric glow-lamp e for 2 or 4 volts serving as an illuminator. The load of the bearer Λ is counterpoised by the weight g . In the above-mentioned conical axis a conical plug is inserted, rotatory by means of the milled head K for adjusting the prism-table, which is clamped on to the plug by the screw p . The screw k_1 clamps the axis of

* Zeit. f. Instrumentenk., xxx. (1910) pp. 353-7 (2 figs.).

the prism-table. The collimator is supported by a very strong pillar situated on one of the legs of the tripod. The slit opens symmetrically; its cheeks are of hard steel; it is first accurately adjusted for infinity

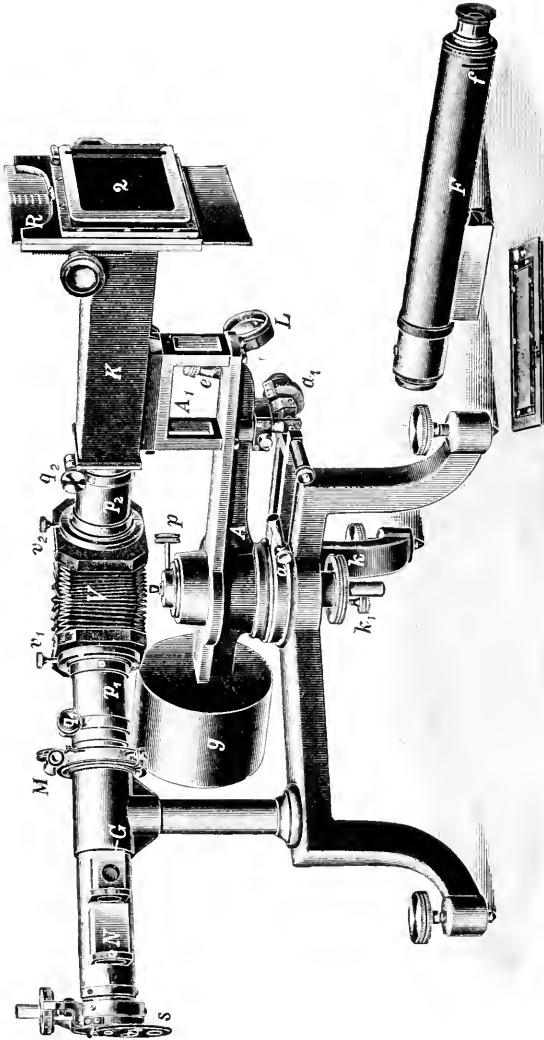

FIG. 80.

and then firmly secured to the collimator. A drum interval of the micrometer-screw corresponds to 0.01 mm. A rotatory disc *s* is in front of the slit, and is useful in connexion with the camera. It can be easily exchanged for two discs for photometric measurements in the case of very

high dispersion. One of these discs carries a totally reflecting prism, through which light passes from the comparison light-source; it also carries a holder, in which gauged smoke-glass wedges with scale and

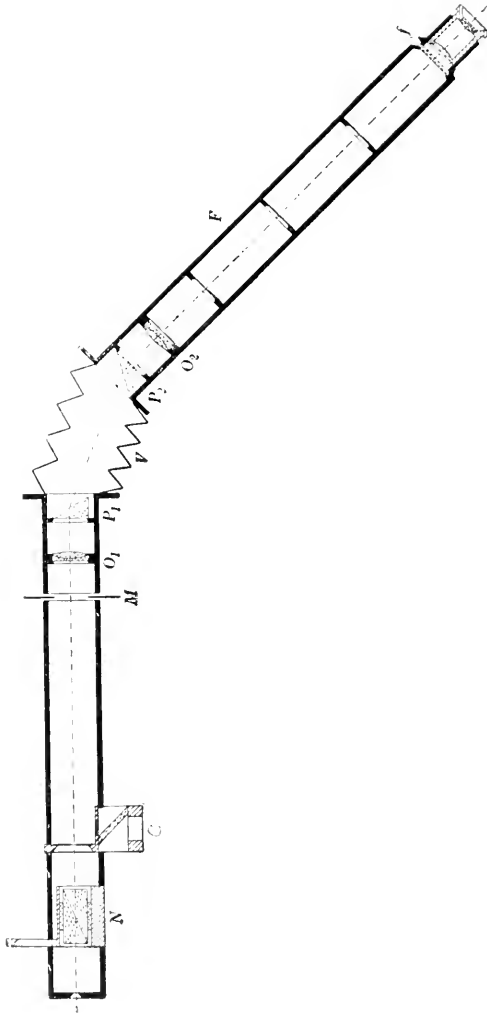

FIG. 81.

platinized glass plates can be inserted for weakening the light-source to a measurable quantity. A second disc is provided for photometric comparisons with the smoke-glass wedges in the direction of the collimator-tube; this arrangement is for measuring the selective absorption of

emitted flames. Behind the slit is a nicol N, movable in and out, and a plane parallel glass plate G, inclined at 45° , and also movable in and out. The nicol is used for observing Zeeman effect, electrical and magnetic double refraction, normal and abnormal magnetic rotations. For observing the Zeeman effect parallel to the lines of force, a mica $\frac{1}{4}\lambda$ double plate, right and left circularly polarized, is placed in front of the slit; the nicol is then pushed in. For observing the same phenomenon perpendicular to the lines of force there are two methods: one is to place in front of half of the slit a plate of quartz cut perpendicularly to the axis; the other is to place a $\frac{1}{2}\lambda$ double plate of mica. A Rowland's grating is then applied in order to avoid the overlapping of the spectra. The nicol is also so placed that its direction of displacement (electric or Fresnel's vector) is vertical. For measuring electric or magnetic double refraction, the mica plate is brought on to the slit of the collimator (after Koenigsberger); then comes the compensator, next the substance in the electric field, and then a second nicol.

If the nicol, as is the case here, is applied to the collimator, then the adjustment of the collimator-lens must be altered, and this adjustment is facilitated by the provision of a notch. The inner nicol affords, in contrast with other arrangements, the advantage of greater brightness with moderately small dimensions: it is also very easily adjustable. Anyone who has once worked with it will scarcely ever abandon it.

The glass plate also serves for measuring layer-thicknesses and phase-origins by Wernicke and Wiener's methods. Near the collimator-objective O_1 is a shutter M, which can be regulated up to 0.02 seconds for time and instantaneous exposures.

The observation tube F and the camera K are easily interchangeable. A glass micrometer divided into hundredths is inserted at the image-plane f of the telescope; it is illuminated from a lateral slit. Two diaphragms can also be inserted at f for shutting out desired parts of the spectrum. A Young's prism arrangement produces the dispersion, which can be increased, if desired, by a Cornu double prism.

The camera K is entirely of metal, and for coincidence photographs a rotatory disc s , with four apertures, is placed in front of the slit.

Glass Polarizing Prisms.*—Of late years calcite has become not only scarce but difficult to obtain sufficiently large and free from defects. The expense of calcite polarizing prisms is consequently considerable. Among other substitutes glass prisms of suitable angle have been suggested. H. Schulz quotes a form due to Stotze (fig. 82) in which the angle π of the prism ABCDEF is so chosen that the ray passing perpendicularly through AB and DE is totally polarized at incidence on BC, the plane EF being silvered to diminish the weakening of light-intensity due to reflection at its surface. The lateral displacement of the polarized beam is, however, a great disadvantage, and has been an obstacle to the adoption of the method. H. Schulz now proposes a prism of the form shown in fig. 83, by which the path of the emergent

* Zeit. f. Instrumentenk., xxxi. (1911) pp. 180-2 (2 figs.).

ray is a continuation of that of the incident ray. The author also discusses some other forms of prisms suitable for the same purpose.

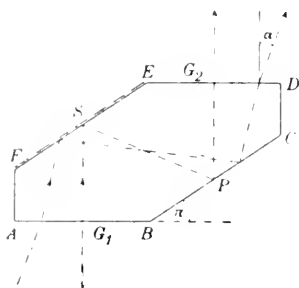

FIG. 82.

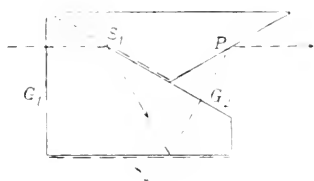

FIG. 83.

Aids to Crystalloptic Projection.*—In discussing the above subject J. Beckenkamp recommends the use of a lantern-screen prepared with aluminium bronze. Photometric tests of such a screen in comparison with screens of other kinds are very much in its favour. The most advantageous position is to arrange so that the incident beam of light falls horizontally on the vertical screen; moreover, the light-beam should be central with regard to the auditorium, the screen being about 3-4 m. from the lantern. The spectators should be ranked on each side of the optic axis of the lantern, and, if possible, the rows should rise in tiers one behind another.

Emrys-Roberts Microscope Lamp.—This apparatus (fig. 84) was exhibited and described at the June Meeting (see Proceedings, ante, p. 571).



FIG. 84.

Model of the Vibration-planes of Light in the Polarizing Apparatus.†—In order to assist the realization of the path of a ray of light

* SB. Phys. Med. Gesell. zu Würzburg, 1911, pp. 13-16.

† Zeitschr. wiss. Mikrosk., xxviii. (1911) pp. 42-5 (1 fig.).

through a polariscope, H. Triepel has designed the model shown in fig. 85. It consists of a rod about 40 cm. high, on a firm foot. Four pairs of cardboard sheets fitting into tubes are slipped over the rod, and are thus easily adjustable in any required vertical positions. In each of the two central pairs the cards are at right angles.

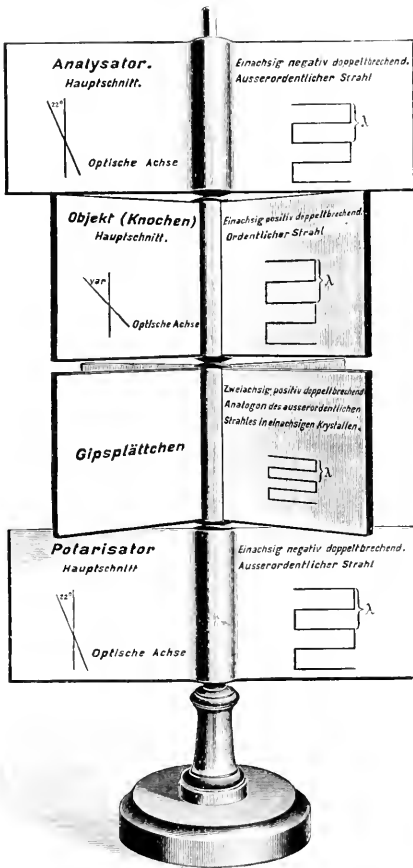

FIG. 85.

ment illustrates the ray as it passes successively through polarizer, selenite, object, and analyzer. The optical axis is supposed to be vertical, and the axis of the nicol prism inclined to it at 22° . Suitable information is recorded on the sheets.

Leitz Liliput Arc-lamp.*—This auxiliary is intended for photomicrographic use, and is illustrated above in fig. 63, p. 541. It pro-

* Leitz, Catalogue 43 G, Photomicrographic Apparatus, p. 9.

vides a current of 4 amperes, and has rack feed and centring adjustment. It has also extension gear for adjusting the carbons while the image on the screen is being observed.

§ 4) Photomicrography.

WYCHGRAM, E.—*Aus Optischen und mechanischen Werkstätten* iii.

[The author gives a very interesting sketch of the progress and development of instruments connected with projection and photomicrography during the last two years.]

Zeitschr. wiss. Mikrosk., xxviii. (1911) pp. 59-69 (6 figs.).

(5) Microscopical Optics and Manipulation.

Observations on the Technical Execution and Biological Realization of Microscopical Measurements.*—R. von Lenderfeld reminds his readers of the great variability in the magnitudes both of crystals of the same chemical composition and of organisms of the same species. The difficulty of appropriately measuring them is therefore so great that the only sound method must be biometric. Thus, for example, the magnitudes of spicules and such like should be stated in relation to the magnitudes of the parent body. This would obviously require a great many measurements: but the measurements could, however, be plotted out on a curve and so afford a realization of their biological value. He has, therefore, contrived a measuring apparatus susceptible of great accuracy, and so arranged that a skilled worker can make a large number of successive observations and dictate them to an assistant. He projects the microscopic image on to a large plane mirror which reflects the image back on to a fixed matt glass screen of about 4 sq. m. in size. The mirror has universal adjustment, so that the image, which is of course a much enlarged one, is brought to a convenient spot on the screen in front of the observer's seat. The Microscope is so placed that the observer is able, without leaving his seat, to regulate the movements of the object on the Microscope stage. The dimensions of the image on the matt screen are ascertained by the use of scales specially drawn on tracing linen. An objective micrometer is used in the Microscope, and thus the proportion of image to object is known. A large number of measurements on one object, or on a group of similar objects, can be quickly and easily made, the results being dictated to an assistant who sits at a table behind the observer. The author has found his method give very satisfactory results.

Opacity of Certain Glasses for the Ultra-violet.†—L. Bell has examined the spectra yielded by ultra-violet rays after transmission through specimens of various kinds of glasses. Photographs are given of the results, which vary very much in opacity. The light-source used was a quartz mercury lamp.

(6) Miscellaneous.

Some New Diatomic Structures discovered with a New Zeiss Apochromat.‡—A. A. C. E. Merlin describes the results of his use of a

* *Zeitschr. wiss. Mikrosk.*, xxviii. (1911) pp. 27-34 (3 figs.).

† *Proc. Amer. Acad. Arts and Sci.*, xlvi. (1911) pp. 671-80 (2 pls.).

‡ *Journ. Quekett Micr. Club*, 1911, pp. 199-202.

new Zeiss $\frac{1}{3}$ apochromat made in 1910. He tested it upon diatomic structures, although the lens had not been specially constructed for such work. In several cases doubtful features were completely established; in others new features were revealed. Among the instances he gives are the following:—

Craspedodiscus coscinodiscus.—Secondaries previously doubtful, now clearly exhibited.

Epithemia turgida.—Primaries prove to be irregularly cruciform in shape, somewhat of the *arachnodiscus* type. High magnification (3000) required.

Cymbella gastroides Kütz. —Primaries rectangular in shape, divided and broken up into secondaries.

Gomphonema geminatum Ag.—Secondaries closely resembling the foregoing.

Stictodiscus areolatus Grun (Oamaru).—Exhibits a delicate but not particularly difficult network on the lower surface of the valve. A fine dotted structure can be seen on the under edge of the rim.

Aulacodiscus Janischii Gr. and St. (Oamaru).—Exhibits a very distinct and obvious veil. Should prove to be within the grasp of most good cheap oil-immersion lenses.

Eulictia oceanica Ehr. (fossil, from Peru guano).—Possesses easy secondary perforations plainly seen in balsam.

All the foregoing observations were made with working apertures varying between 1.3 and 0.95 N.A. In no instance was oblique light or a smaller illuminating cone employed.

The Micrologist.*—This quarterly journal, edited by A. Flatters, made its first appearance in July 1910. Its aims are to instruct the amateur microscopist in the methods of preparing and mounting natural history specimens for microscopical examination. It is illustrated by photomicrographs and also by ordinary line or half-tone blocks. The first volume contains manipulative methods necessary for microscopical work, and in the future special types will be taken, selections being made from those not generally dealt with in ordinary text-books. The first five numbers more than bear out the intention of the editor: they are full of practical information and are most excellently illustrated. The price is very moderate.

Principal Starches used as Food.†—This work by Waldron Griffiths has passed into a second edition. Its general characters are unaltered, but the number of illustrations has been considerably increased and the short descriptions have been as far as possible brought up to date. The object of the work is to facilitate the identification of starch, especially when used either for purposes of adulteration or substitution; it certainly fulfils the intention of the author.

GLEICHEN, A.—**Die Theorien der modernen optischen Instrumente.**
Stuttgart: F. Enke (1911) 332 pp.

* Manchester: Flatters, Milborne, and M'Kechnie, Ltd., 1910–11, pts. i.–v.

† Cirencester: Baily and Woods (1911) 2nd ed. 70 pp. (38 figs.).

B. Technique.***2) Preparing Objects.**

Effects of Pyridin Fixation upon Nervous Tissues.†—A. Montanari has made observations upon the effect of this fixative upon the cells of the medulla. Following Donaggio's method, he put portions of the tissue into the fixing reagent for varying periods of two to seven days, treated them with the mordant, ammonium chlor-molybdate, and stained with thionin. He found that there was a marked difference between the appearance of the cellular structure in those portions that had been in pyridin for two days, and in those that had been exposed to the action of the fixative for longer periods. He describes the appearances successively of cells which had been fixed for two, three, four, and so on up to seven or more days, and traces the changes from a first period of spongy vacuolation through an intermediate stage, showing a false network to a final form in which a true network with moniliform septa is seen. Concurrently with these reticular changes, an alteration in the behaviour of the nuclei towards the stain is observed. The author considers that this work may have a bearing upon the question whether the fibrillation of nervous cells is to be regarded as an artefact.



FIG. 86.

Simple Washing Apparatus.‡—E. Schaffnit has devised the simple piece of apparatus shown in fig. 86. To a water-tap is attached by means of rubber tubing a filter funnel or flask, from which the bottom has been removed. The open end of this vessel is covered with fine silk, fixed round the edge. Portions of tissue to be washed are introduced either through the neck or through the open end before fixing the silk membrane. Before turning on the water the flask is placed in a horizontal axis and half filled with water; then it is restored to its normal position, and as the water continues to flow, the air pressure maintains it at a constant level. To remove the smaller portions of tissue, when washing is complete, the rubber tube is removed, and the flask immersed in water, so that the material floats through the neck.

Simultaneous Fixing and Staining.§—F. Strecker comments upon the advantages, for histological purposes, of using solutions in which the fixing and staining agents are mixed. After a concise résumé of the methods and formulæ recommended by various workers, he points out

* This subdivision contains (1) Collecting Objects, including Culture Processes; (2) Preparing Objects; (3) Cutting, including Embedding and Microtomes; (4) Staining and Injecting; (5) Mounting, including slides, preservation fluids, etc.; (6) Miscellaneous.

† *Zeitschr. wiss. Mikrosk.*, xxvii. (1911) pp. 22-25.

‡ *Zeitschr. wiss. Mikrosk.*, xxviii. (1911) pp. 49-50.

§ *Zeitschr. wiss. Mikrosk.*, xxviii. pp. 17-21.

that fixing and staining reagents cannot be mixed indiscriminately. In the first place the optimum reaction of the various substances must not be disturbed, and, further, there are differences in activity, time of action and so on, which have to be considered. Some stains and fixing reagents are not miscible. For fixing and staining brain-tissues, the author recommends a mixture of 10 p.c. formalin and Ehrlich's tri-acid stain. This solution is also applicable to liver, kidney, spleen, and other tissues. Good results have also followed the use of a formalin-toluidin-blue mixture—10 p.c. formalin 100 parts, toluidin blue (solid) 3 parts.

Preparation of Kaiserling Material for Microscopical Purposes.*—B. Rawitz has devised the following method. Portions of tissue prepared by Kaiserling's method are put into 95 p.c. alcohol containing 10 p.c. tincture of iodine for fourteen days. The fluid is changed every day for the first three days, as it becomes turbid; after this time it will remain clear. From the iodine solution the material is transferred to a saturated potassium bichromate solution for fourteen days, the fluid being changed twice. The material is lightly blotted with filter-paper and put into 95 p.c. alcohol for two days, absolute alcohol for two days, and chloroform for a like period. From this it is transferred to chloroform-paraffin, and finally embedded in paraffin.

The author also describes the application of certain stains, formol-fuchsin and azofuchsin, to the staining of nervous tissues.

(3) Cutting, including Embedding and Microtomes.

Microtome Knives.—The firm of E. Leitz has recently completed arrangements for the manufacture of microtome knives in Sheffield, and are also prepared to undertake the re-sharpening of microtome knives. The sizes of the knives are from $1\frac{3}{4}$ to $9\frac{1}{2}$ in. in length.

Improvements in Rock-section Cutting Apparatus.†—H. J. Grayson thus describes the structural features of his new machine for cutting rock-sections.

“ Dealing with the several portions of the machine in order, Plate XX., which may be regarded as equivalent to a sectional or front view, shows all the principal features of the apparatus, which is built into a corner of the workroom; the lathe in the foreground has no connexion with the rock slicer, beyond being driven by the same motor. The three guard-trays have been removed from the top of the rock machine table, in order to show the position and relation of the slicing and grinding-lap spindles, and of the several supports for rock-holders and clamps.

Plate XXI. may be regarded as a photograph in plan, i.e. looking down upon the machine. It shows to better advantage the relation of the working parts in running order, other than the driving mechanism, which is situated at some height above the machine, and is shown in detail in Plate XXII.

* Zeitschr. wiss. Mikrosk., xxviii. (1911) pp. 1–11.

† Proc. Roy. Soc. Victoria, xxiii. (1910) pp. 65–81 (4 pls.).

Plate XXIII. (Figs. 1 and 2) serves to show the special appliances for serial section cutting, parallel grinding, and work with the goniometer.

Reverting to Plate XX., it will be seen that the base of the machine is a strongly built wooden bench or table, with dimensions as follows: length 7 feet, width 2 ft. 4 in., height 3 ft. 2 in. The tabletop, which is $1\frac{3}{4}$ in. thick, is supported on a strong, well-braced framework, which is screwed to the wall of the building so as to ensure complete freedom from vibration. The details of the construction of the table may be readily made out from an inspection of Plates XX. and XXII., except that a supporting beam for the three spindles, which runs from end to end of the table, 9 in. below its surface, cannot of course be seen.

Details of the Principal Mechanical Parts.—These are described in order, from right to left, as they appear in Plate XXI. First comes the vertical revolving spindle of the slicer. This is made of mild steel—as indeed are all the spindles—15 in. long, by $1\frac{1}{8}$ in. in diameter. It passes through an accurately bored, flanged collar 3 in. long, screwed to the surface of the table. The lower end of this spindle, as also those of the grinding lap, is coned, and fits into a corresponding metal socket, provided with an oil recess and protecting collar, which is screwed to the longitudinal beam of the table-frame. The top of the spindle is threaded, and carries carefully fitted collars and flanges for clamping the slitting discs.

Somewhat to the right of and behind the spindle of the slicer, is a rod of steel, 1 in. in diameter and 18 in. long. The lower part of this rod, which is of somewhat greater diameter than the upper part, is coarsely threaded for 6 in. of its length, and screws into a long nut or socket fitted to the table, thus forming an adjustable support for the various specimen clamps. The rod has 3 in. or more of motion by means of a screw, and a further range is obtained with the aid of lock-nuts sliding on the spindle itself.

The larger specimen-holder is of the usual parallel screw-clamp type, and will hold specimens up to 5 in. in diameter. Several interchangeable clamps are used; one of these, to be seen in the photograph (Plate XXI.), is adapted to hold thick pieces of plate glass $3\frac{1}{2}$ by $1\frac{1}{2}$ inches (length and breadth), to which the ordinary microslips are attached. In addition to its radial motion, this carrier revolves axially, so that specimens to be sliced may be tilted at any convenient angle in relation to the slitting disc. This clamp also carries the goniometric crystal-holder (shown in the front right corner of the tray), which permits of slicing or grinding in any desired direction. The device for maintaining a steady pressure or pull against the slicer comprises the usual cord, weights, and pulleys, so placed as to be readily controlled.

Lubrication of the slicer is provided for by means of a drip-can and two pieces of sponge, one above and one below the disc, held in position by a spring clamp.

Passing now to the grinding laps, of which there are two, seen in the centre of the table, it will be noted that they are screwed to the top of the spindles by means of a threaded boss below each plate. This mode of mounting allows the whole surface of the lap to be utilized, and

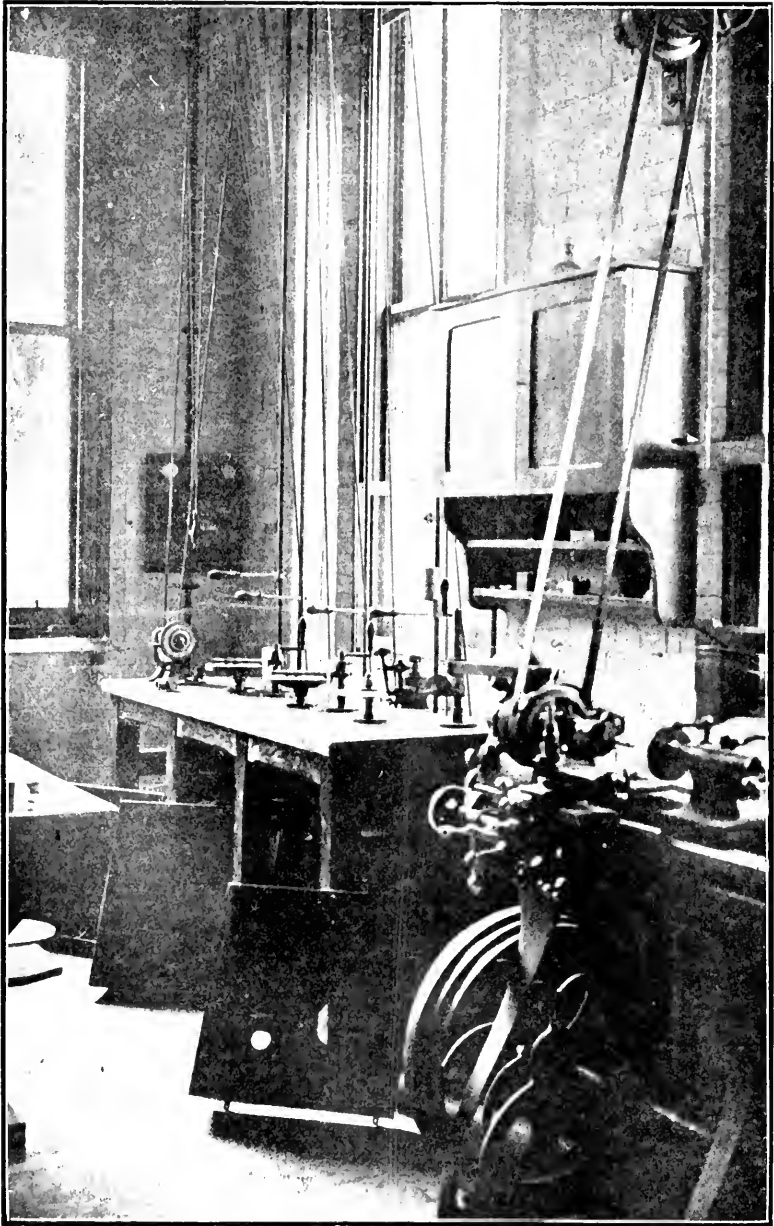

GRAYSON ROCK-SECTION CUTTING APPARATUS.

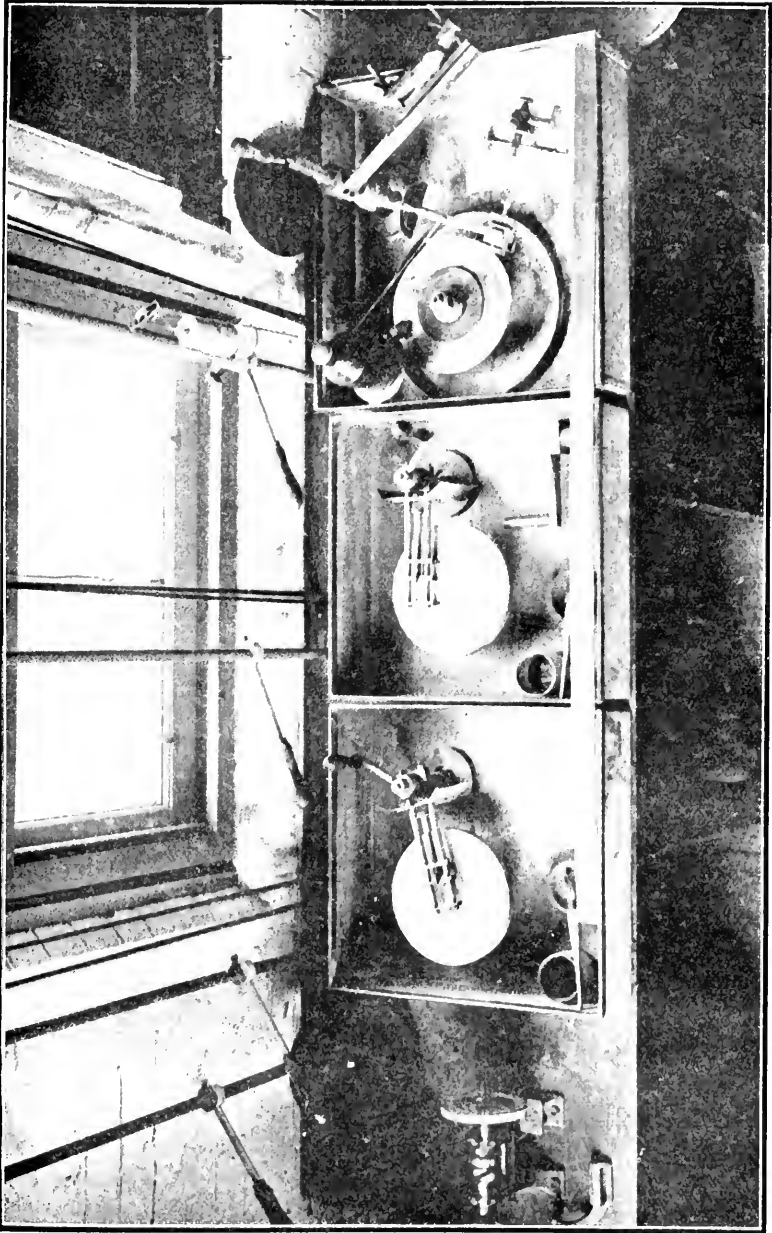

GRAYSON ROCK-SECTION CUTTING APPARATUS.

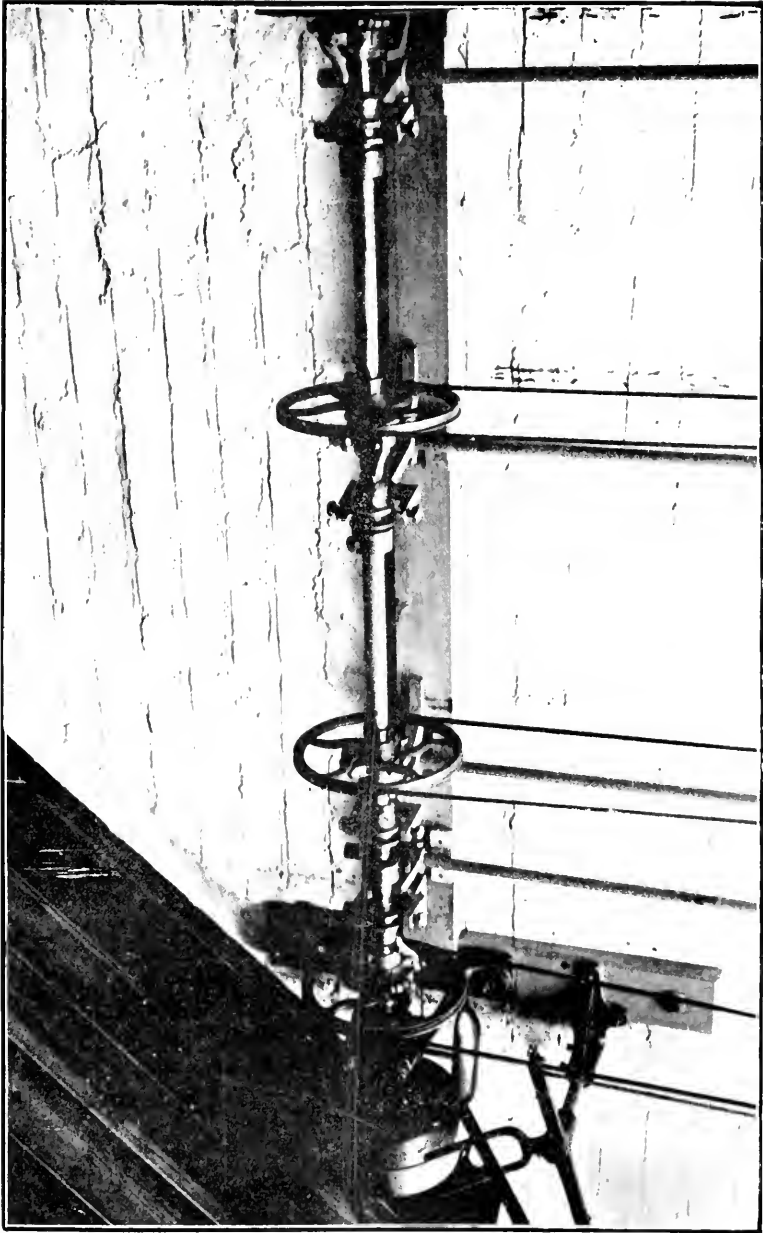

GRAYSON ROCK-SECTION CUTTING APPARATUS.

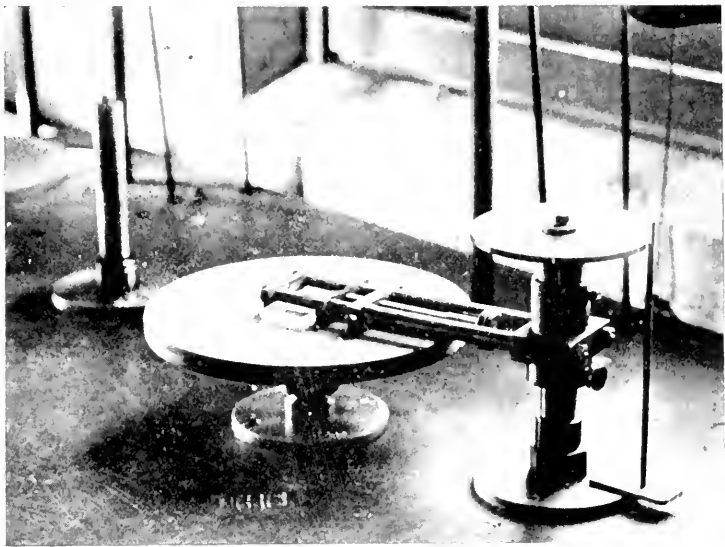

Fig 1

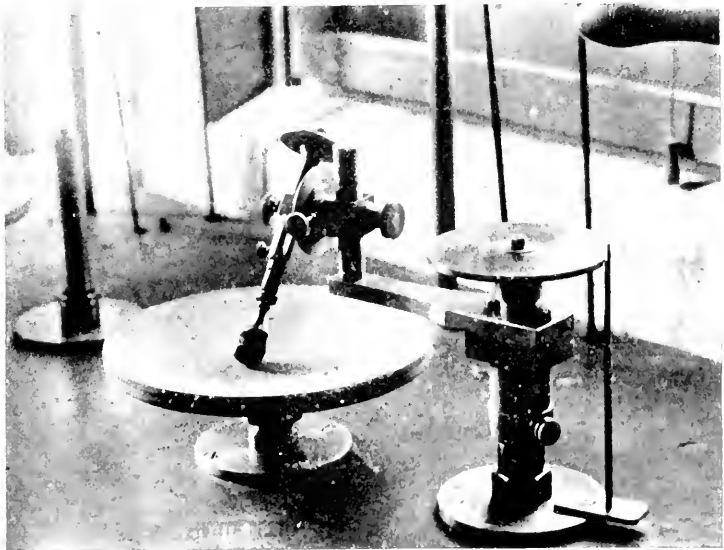

Fig 2

GRAYSON ROCK-SECTION CUTTING APPARATUS.

is a convenience which has only to be once used to be appreciated. It not only allows the utmost freedom of movement, but also aids in the maintenance of a true surface on the lap for a long time. The spindles of the laps are somewhat shorter than that of the slicer, their length being 12 in., so that the lap surface is about $3\frac{1}{2}$ in. above the table, which is a convenient height for most operators. The mounting of the spindles is the same throughout, and has already been described. Dust and grit are excluded from the bearings by means of a special close-fitting collar in each case.

It will be seen that each grinding spindle is accompanied by a pillar which supports a clamping device, in which specimens or blocks of glass are held so as to swing radially across the laps. This permits of parallel grinding to a precise thickness or definite form, and though not necessary for ordinary rock slicing, it has, as already explained, a variety of uses where precision is required.

The lower portion of each rod is threaded, and screws into a long socket let into the surface of the table. It can thus be accurately raised and lowered during use, so as to maintain a steady and even pressure upon the lap. It is also adapted to carry the goniometer, which fits the special holder shown in the centre tray, and, as already indicated, as every part of the machine is interchangeable if so required, a rapid transfer from one lap to another can be made. This correspondence between the several parts of the machine, and the facility of interchange which is thereby effected, results in the long run in a considerable saving of time.

The most effective laps, so far as my experience goes, are those of bronze containing a high percentage of copper, the aim being to secure a tough but not unduly hard lap. Pure copper laps would no doubt be better, but they are difficult to cast and turn. Discs of lead and tin, and also of wood with felted surfaces, are used in special cases and for polishing. A diameter of 10 in. is found to be convenient for most of these laps.

Tray-like shields, or mud-guards, are provided for each of the grinding laps, as well as for the slicer. As will be seen, they are of square outline and conveniently large, the distance between the several spindles, 22 in., permitting of this. The trays are made of stout galvanized iron, 5 in. deep, and the upper edges are rounded and brass-bound, forming clean and comfortable supports for the hands and arms of the operator. It should also be noticed that a space around each pillar or spindle is raised and carefully capped, so as to exclude dust and grit; this, in addition to the brass collars already noticed. The bearings of a machine running at a high speed, and upon which carborundum and other abrasives are to be freely used, cannot be too carefully protected from their intrusion: the life of the bearings is, in fact, directly proportional to the effective exclusion of the abrasives.

As already stated, the machine is motor driven, and as the method of connecting-up is in some respects novel, I refer to it in some detail. An electrically driven 1-horsepower motor serves to run the rock-slicer, lathe, emery wheel, and polisher, and has proved fully adequate for all requirements. As the motor runs at 1400 revolutions per minute, the

main shafting, shown in Plate XXII., is speeded down to about 300, a convenient speed for the driving-wheels of both lathe and rock-slicer. The usual method of gearing to a secondary shaft by means of belts and loose pulleys has been dispensed with, and a system of connecting directly to the main shaft adopted. This permits of any single portion of the section apparatus being run separately; the remaining cords and pulleys being stationary. This effects a saving of power, and reduces the wear and tear upon the machine and belts or cords. The slicer, and each grinder and the polisher, are hence directly connected to the principal shafting, which runs loosely through each driving-pulley, when the latter are not engaged. These pulleys are thrown into action, each by its own clutch, which is operated by a loose coned sliding collar on the main shaft. The sliding cone is moved directly from the work-table by means of a rod, to the lower end of which a lever handle-bar is rigidly screwed in a convenient position. At the top of the rod is a forked lever with adjusting screws fitting a groove in the sliding cone. By a twist of the handle-bar below, the cone is forced under the lever of the clutch, which tightly engages the hub of the driving-wheel, and the lap or slicer, as the case may be, is brought into immediate action; the reverse movement, of course, instantly disengages the clutch, and the lap or slicer becomes stationary. The photograph (Plate XXII.), which shows a portion of the main shaft, driving-wheels, and clutches, will serve to make this portion of the mechanism sufficiently clear.

Connexion between the driving-wheel and each spindle, by means of a leather cord, is easily effected, the latter passing directly from wheel to spindle with the aid of guide pulleys only, these being secured to the under-surface of the table.

Provision was originally made for two speeds, the change being effected by means of split pulleys on the spindle, which can easily be removed if required—but this is seldom necessary. A uniform speed of about 980 revolutions per minute has been found in every way satisfactory.

An extremely useful adjunct to the rock-slicer is to be found in the small emery grinder attached to the same bench (seen to the left of Plate XXI.), and driven in the same manner. It is speeded up to 2000 (or more) revolutions per minute, and has been found most convenient for a variety of work for which the larger machine is not so well adapted. It may be provided with various grinding and cutting wheels, as well as polishers and brushes, which fit it for use upon fossils, and the grinding and polishing of small mineral and other specimens. This is an addition to its varied usefulness in the workroom generally."

Method of Slicing, Grinding and Mounting Rock-sections.*—The following is a summary of the salient points adopted by H. J. Grayson when working at rock-sections:—

"A. *Charging the Slicers, etc.*—This is invariably done with diamond powder, which it pays to crush, and sift from time to time during the operation. The sifting is easily done with the aid of several bits of glass tube about 1 in. long and $\frac{3}{4}$ in. wide, to one end of which, after grinding level, a bit of very fine bolting silk has been cemented. A slicer charged with properly graded diamond powder cuts faster and cuts longer than

* Proc. Roy. Soc. Victoria, xxiii. (1910) pp. 65-81 (4 pls.).

would be the case if the diamond were only ground to an almost impalpable powder in oil, as is frequently done: the former method is more effective as well as more economical.

Every slicer should be made to run 'dead' true, and should be maintained in that condition. The greater the speed at which it is run, the more important it becomes that it should run truly. A slicer is always ineffective in proportion to its eccentricity. Too often the slicer is made to cut as long as it will cut; this is unsound, both in theory and practice.

With regard to charging a slicer, I find a chilled steel roller by far the most effective instrument for this purpose. It is better than any glass or agate implement, and, if properly made, is almost everlasting.

I have tried notching the slicers and charging the notches; it takes a long time to do this well—and it must be well done, or not at all. I was certainly rewarded with a slicer which cut well for a long time. Usually, however, I find a slicer charged in the ordinary way, that is by pressure of the diamond powder into the smoothly turned edge of the soft iron slicer, gives a very satisfactory return for the small amount of time and trouble it requires to prepare. A hundred sections, each of which involves two cuts, at a cost of little more than a shilling, leaves nothing to complain of in the matter of expense. In slicing I use kerosene for lubrication, that is, if the rocks are compact and hard; for such rocks it is more effective than a soap emulsion, which of course must be used for soft and porous rocks. Any good soap makes an effective lubricant if properly dissolved. It need not be Castile soap, which, like many other things, is not always what it is claimed to be.

B. *Grinding Powders*.—For this purpose only the finest graded carborundum is used. I also re-grade what is ordinarily sold as graded material by the manufacturer. For example, FFF grade of the Niagara Falls Company can well be further separated into two or three grades. The coarsest of these is used upon the finest of the two machine laps; the remaining finer grades are used for finishing purposes by hand.

For the coarse lap, I find a fine but well graded powder is more effective than one that is coarse; indeed, the latter is simply thrown off a rapidly revolving lap. Two hundred and twenty grade carborundum is the coarsest I use for rough work. Ordinarily the series of laps comprises one coarse, one fine, and one finishing lap of slate for hand use only.

C. *Canada Balsam and Mounting Methods*.—Many people fail in their first attempts to cut and prepare sections satisfactorily, not through lack of perseverance or skill, but because they do not carefully prepare their balsamed slips beforehand. Good clean natural Canada balsam alone, if carefully prepared, will hold almost any rock securely to the end of the process of its preparation. The tenacity and range of hardness of the balsam may, however, be extended if a small quantity, not more than 1 to 3 p.c., of some clear and colourless organic oil is added to it. Poppy oil, castor oil, clove oil—even linseed oil—are all suitable if used in the right proportions, and here experience alone is the best guide. Those who have not tried the addition of one of these oils, or something similar, will appreciate the improvement effected by them, if the addition is judiciously made.

One should not prepare too many balsamed slips at once, as they continue to dry slowly if not used, and eventually become too brittle. As to mounting, the specimen should be attached, in the first instance, to the slip upon which it is to remain. Transference to another slip is obsolete and unnecessary. It did well for thick sections, which were formerly much more common than they are, or should be, to-day. Again, the section and slip should not be flooded with balsam when about to attach the cover, for, besides making a sticky and unsightly mess, it is both wasteful and unnecessary. Prolonged heating of slip and section is not advisable, when one is mounting, with the object of driving out all the solvent from the balsam. The chances are, when this is attempted, that the section will be disturbed or float, and will tend to break up when putting down the cover, besides raising a crop of bubbles, which are very difficult to remove. It is a wiser and safer course to use no more balsam, and to apply no more heat than is necessary to bring the cover into close and uniform relationship with the whole of the section. An oven with a water-jacket, maintained at about 40° C., will, in from three to five days, complete the drying with perfect safety.

So much for what is general and more or less applicable to almost any successful process for the preparation and mounting of rock sections.

I will now briefly outline the process adopted with a collection of, say, twenty numbered rock specimens which are ready for slicing. It is to be noted that I seldom prepare sections from detached slices, as these involve two parallel cuts and much subsequent grinding. It is twice as economical, both as to time and material, to slice off the rock close to the mounting slip, as by this method the smallest possible amount of material remains to be ground away. Two dozen 3 by 1 in. slips are cleaned and placed, the whole upon white blotting paper, spread on a sheet of asbestos, or a metal plate: this is laid upon a well filled sand bath, supported on a tripod over a Bunsen flame. The heat from the latter is so regulated as not to discolour or char the paper below the slips. Each slip is now balsamed, using no more than experience has shown to be necessary for sections about 1 in. in diameter. While the balsam is "cooking" the specimens are successively clamped in the large specimen holder of the slicing machine, and a piece, large enough for a section, is sliced away; the whole twenty being thus treated. Meantime, the balsamed slips will have become sufficiently hardened. Each slip should be separately tested, when cool, with forceps or knife: the hardened balsam should indent with moderate pressure without splintering.

The sliced face of each specimen is now, for a few seconds, held upon the finest revolving lap, which is fed with F F carborundum, and moistened with water containing about one-fifth of its volume of glycerin, which maintains a rapidly revolving disc sufficiently moist, without excess, for a long time. Each specimen requires only a brief treatment, and if the lap is in first-class order no further preparation should be required. Usually, however, it is safer to give each specimen a few sweeps by hand, upon a slate or glass lap, the surface of which should be accurately true or flat. After washing and drying, the specimens are ready for attachment to the balsamed slips. This is done by heating them sufficiently to occasion discomfort when held against the hand for

a few seconds; the slip being correspondingly heated, the specimen is pressed home on the slip, taking care to exclude all air-bubbles. As each slide is dealt with it is placed on a second plate of glass ($3\frac{1}{2}$ by $1\frac{1}{2}$ in. by $\frac{5}{16}$ in. thick, the blocks being strictly uniform) and heated to melt the beeswax, which is used to hold the slip in position during its subsequent treatment. After the entire series has thus been treated and allowed to cool, each glass plate or block in turn is clamped in the special holder, and the slicer passed through the rock close to the glass of the mounting slip. With everything in good order this may be done to within 0.5 mm.; the thickness being regulated by means of two strips of thin sheet iron, held in position on the slip while the cut is being started.

The series having been sliced, each section is ground to within 0.1 mm. on the coarse grinding lap, using F carborundum, or certainly not a coarser grade than 220. After washing, the grinding is completed on the finest revolving lap, and if the latter is true and the operator experienced scarcely any further grinding will be required. With a sufficiently finely-graded powder, there should be no scoring or scratches; the latter, if present, being due to fragments of too coarse a powder, or to its use in too limited a quantity, thus allowing the specimen to come in contact with the metal of the lap. As a rule, and for safety, it is wiser to give the last touches by hand upon a suitable lap of slate or glass, using only the finest washed powder.

The whole process is not so long or so complicated as any description must necessarily seem to imply. With the aid of the machine described, and given balsamed slides in readiness, I find it possible to complete single slides in 10 to 15 minutes; the finished section, in area, uniformity, and thinness, leaving little to be desired. Furthermore, with a series of rocks—and it is usual to treat a number together—there is a corresponding gain in time, throughout the several operations. Naturally, too, and perhaps more particularly with the type of machine just described, individual experience, dexterity of manipulation, and judgment, are material factors affecting the final result, both as to time and quality of work. Compared with the older type of machine, both hand and treadle, there can be no question as to the net gain in time and labour, both of which are important. There is, too, I think, an equivalent improvement in the average quality of the finished product. On these grounds I hope the publication of this brief description will prove useful to all who are interested in the preparation of rock-sections."

(4) Staining and Injecting.

Staining Bordered Pits.*—G. Kowallik used three solutions: (1) 1 grm. acid-fuchsin dissolved in 100 grm. 95 p.c. alcohol and filtered; (2) 1 grm. anilin-green (brillant-grün?), obtained from Wolff of Posen, dissolved in 100 grm. of distilled water and filtered; (3) 1 grm. chrysoïdin dissolved in 100 grm. 95 p.c. alcohol and filtered. Sections of *Pinus* hardened in alcohol are covered with solution (2) and the slide is heated to vaporization. After a minute the slide is washed in water and then treated with solution (3) diluted one-half with water. After allowing

* Zeitschr. wiss. Mikrosk., xxvii. (1911) pp. 26-7.

this to act for one or two minutes the slide is rapidly washed in 95 p.c. alcohol and then transferred to solution (1) for not more than one minute. It is then treated for 2-5 seconds with 95 p.c. alcohol and afterwards with absolute alcohol for about one minute. The sections are treated with xylol for about five minutes and afterwards embedded in balsam. The tracheids are yellow, the areola green, and the torus red.

(6) Miscellaneous.

Enumeration of Bacteria in Milk.*—R. S. Breed determines the number of bacteria in milk by direct microscopical examination. The sample of milk to be examined is shaken thoroughly and 0.01 c.cm. is withdrawn by means of a specially constructed pipette. The milk so obtained is spread evenly over an area of 1 sq. cm. on an ordinary glass slide. These areas may be easily determined by placing the glass slide over paper or glass on which areas of this size have been accurately ruled out. The milk is then dried with gentle heat, the fat dissolved out with xylol or other fat solvent, the smear again dried, then fixed with alcohol, again dried and stained with some anilin dye. Alkaline or other solutions which attack casein and loosen the smear must be avoided. The counting of the bacteria is done with a Microscope and an oil-immersion objective. If the diameter of the field be so adjusted by means of the draw-tube that it equals 0.16 mm., then each field of the Microscope covers approximately one five-thousandth (0.0002) of a square centimetre. On this basis each bacterium seen in a field taken at random represents 500,000 per c.cm. if they are evenly distributed. But as it is impossible to distribute them evenly, at least 100 fields should be counted. The total number of bacteria seen in 10 fields multiplied by 50,000, or the total number in 100 fields multiplied by 5,000, gives the total number of bacteria per c.cm. Though certain objections may be raised against this method, the author claims that it is more accurate than the plate method.

Metallography, etc.

New Critical Point in Copper-zinc Alloys.†—H. C. H. Carpenter and C. A. Edwards have confirmed the existence of a thermal change at about 470° C. in copper-zinc alloys containing 40 to 63 p.c. copper: this is the range in which the β constituent is present. It is suggested that this critical point corresponds to the decomposition, on cooling, of β into $a + \gamma$. In alloys which above 470° C. consisted wholly of β , the presence of a and γ has been detected microscopically, at high magnifications only. The equilibrium diagram, modified in accordance with the authors' conclusions, is given. As γ is a brittle substance, the decomposition of β into $a + \gamma$ causes embrittlement of the alloy.

C. A. Edwards discusses the nature of solid solutions, in an appendix to the above paper, and concludes that (1) so-called metallic solid solu-

* *Centrallbl. Bakt.*, 2^{te} Abt., xxx. (1911) pp. 337-40 (1 fig.).

† *Journ. Inst. Metals*, v. (1911) pp. 127-93 (26 figs.).

tions are intimate crystalline mixtures; whilst the primary crystals are too small to be detected microscopically, they are large enough to retain their identity; (2) the term "solid solution" is strictly not applicable to crystalline bodies such as metallic alloys, and should be restricted to supercooled liquids, such as glass.

Alloys of Aluminium and Zinc.*—W. Rosenhain and S. L. Archbutt have re-determined the equilibrium diagram of the aluminium-zinc system. Cooling curves and some heating curves were taken; 300 grm. of alloy were used for each experiment, and the rate of cooling was slow. Microscopic examination was applied to specimens which had been (1) slowly cooled from fusion, (2) annealed at certain definite temperatures, and either slowly cooled, or quenched. The diagram differs in important features from that given by Shepherd. The existence of the compound Al_2Zn_3 (corresponding to the β phase) has been demonstrated. In alloys containing this phase, dendritic crystals frequently assuming six-rayed forms were observed. A horizontal line in the diagram at about 440°C . is held to represent the formation of Al_2Zn_3 , while a horizontal at about 255°C . represents the decomposition of that compound.

Aluminium Alloys containing Magnesium.†—A. Wilm finds that certain aluminium alloys containing a small amount of magnesium are capable of being hardened by heat-treatment. Immediately after quenching, the alloy is soft, but after a few days at atmospheric temperature its hardness rises considerably. An increase in ductility accompanies this increase in hardness. The hardness attained upon storage increases with rise of quenching temperature, up to 470°C . An alloy containing 3.5 p.c. copper, 0.5 p.c. magnesium, after being hardened by storage following quenching, was considerably further hardened by cold-rolling. The addition of a small quantity of manganese to such alloys renders them capable of resisting the destructive action of mercury, as the surface is not wetted by mercury.

Lead-tin Alloys.‡—D. Mazzotto has made a careful study of the heat-evolution in the solid state which occurs at about 150°C . in lead-tin alloys on cooling. In an alloy containing 33.3 p.c. tin and 66.7 p.c. lead, it was found that the intensity and the temperature of the recalescence phenomenon were considerably affected by previous annealing, the maximum values of both temperature and intensity being obtained by annealing at 183°C ., the eutectic temperature. The temperature of maximum intensity, and the heat of transformation, rise with increase of tin content up to 18 p.c. tin, which is the concentration of the solid solution saturated at the eutectic temperature. The author shows that the thermal phenomenon in question may be fully explained by the rapid diminution of the solid solubility of tin in lead as the temperature falls below the eutectic temperature. The evolution of heat on cooling is caused by the falling of tin out of solution in lead. Annealing tends to increase the quantity of solid solution which is saturated at the annealing

* Proc. Roy. Soc., Series A, lxxxv. (1911) pp. 389-92 (1 fig.).

† Metallurgie, viii. (1911) pp. 225-7 (9 figs.).

‡ Int. Zeitschr. Metallographic, i. (1911) pp. 289-352 (8 figs.).

temperature, and therefore tends to concentrate the transformation. The ordinary temperature of transformation, 150°C ., is that at which the solid solution saturated at the eutectic temperature, containing about 18 p.c. tin, begins to deposit tin.

Formation of Solid Metallic Solutions by Diffusion in the Solid State.*—G. Bruni and D. Meneghini have heated a nickel wire, electrolytically coated with copper, at 1000°C . in hydrogen, measuring the electrical resistance from time to time during the heating. The resistance, originally 0.026 ohm, ultimately rose to 0.21 ohm. The wire showed no signs of fusion, and the authors conclude that a solid solution of nickel and copper was formed by diffusion in the solid state.

Alloys of Silicon with Metals.†—R. Frilley has prepared, in an electric arc furnace, numerous binary alloys of silicon with manganese, chromium, nickel, iron, tungsten, copper, aluminium, calcium, barium, and strontium. The density of each alloy was accurately determined, and the curves, showing the relation for each system between density and composition, are held to indicate by inflexions or other peculiarities the presence and composition of the definite compounds occurring in the system. A list of the compounds found is too lengthy for reproduction. The author points out the simplicity and accuracy of the density method of investigating alloys. A comparison of the results obtained by applying the method to the copper-aluminium and cadmium-mercury systems, with the equilibrium diagrams obtained by the better-known thermal and microscopical methods, demonstrates the reliability of the density method for indicating the compounds. For each silicon-metal system the density results are given in the form of a specific gravity curve, a specific volume curve, and a molecular volume curve, abscissæ representing in each case the percentage composition. Some information about the properties of the alloys is given.

Extraction of Gases from Copper.‡—M. Guichard has made measurements and analyses of the gases extracted from copper by heating in a vacuum. The gas is quickly evolved from the superficial layer of the specimen, but the gas contained by the deeper layers diffuses very slowly to the outer layer, where it is evolved. By chemical methods, involving the conversion of the copper into iodide or oxide, much greater quantities of occluded gases were extracted. The extraction of the total gas content of copper by heating in a vacuum accordingly presents great difficulties.

Crystallization of White Cast Iron.§—C. Benedicks has examined microscopically a hyper-eutectic cast iron containing 4.36 p.c. carbon and 1 p.c. manganese. Three faces of the specimen, approximately at right angles to each other, were polished and etched. The eutectic was found to exist as "colonies," resembling homogeneous crystals. In some cases the eutectic exhibited spherical surfaces. The solidification of white iron appears to proceed in a discontinuous or oscillatory manner.

* *Atti R. Accad. Lincei*, xx. (1911) pp. 671-4, through *Journ. Chem. Soc.*, c. (1911) p. 703.

† *Rev. Métallurgie*, viii. (1911) pp. 457-559 (39 figs.).

‡ *Comptes Rendus*, clviii. (1911) pp. 104-7, 272-5.

§ *Int. Zeitschr. Metallographie*, i. (1911) pp. 184-91 (14 figs.).

Changes occurring in Nickel Steel.*—C. E. Guillaume has investigated the length changes taking place in course of time in high-nickel steels. Steels containing 28–42 p.c. nickel expand slightly on keeping, while those with higher nickel content, up to 70 p.c., contract. Previous heating, by accelerating the transformations corresponding to these volume changes, reduces the amount of the subsequent alterations. The advantages offered by the 42 p.c. and 56 p.c. alloys for the construction of length standards are discussed.

Ovifak Iron.†—C. Benedicks has microscopically examined specimens of the mass of iron, weighing 25,000 kilograms, found at Ovifak, in order to determine if it is of meteoric origin. The iron was found to contain 1.6 p.c. carbon and some sulphur. The chief constituents are free cementite and pearlite, which by its fine structure would indicate that the iron cannot have been cooled slowly below 700° C. A structure formed of alternate lamellae of cementite and iron oxide is termed "oxide-pearlite." This mass of natural steel has probably been formed by the reduction of iron compounds in molten basalt by carbonaceous matter.

Cementation of Alloy Steels.‡—F. Giolitti and F. Carnevali have carbonized nickel steels containing 2–30 p.c. nickel, and a chromium steel containing 2.3 p.c. chromium, with ethylene and with carbon monoxide, at 950° and at 1050° C. The phenomena of cementation were in general the same as those observed with carbon steels, but in the nickel steels the maximum content of carbon in the cementation zone diminished with increase of nickel content, while the presence of chromium raised the maximum carbon content. The eutectoid composition of steels containing 2–5 p.c. nickel appears to be 0.6–0.65 p.c. carbon.

F. Giolitti and G. Tavanti have studied the cementation of nickel steels containing 20–50 p.c. nickel.

Structure of Galvanized Iron.§—W. Guertler has investigated the microstructure of galvanized iron manufactured by the three usual methods: the dipping process, sherardization, and the electrolytic process. In all cases, a layer of crystals of the compound FeZn_3 is present between the iron and the zinc coating, but in material zinc-coated electrolytically, this layer of FeZn_3 is much thinner than in dipped or sherardized specimens. The FeZn_3 layer is electro-negative to both iron and zinc, and accordingly accelerates corrosion when exposed. The zinc coating obtained by dipping always contains crystals of about the composition FeZn_7 , also electro-negative to zinc. Various other structural features of galvanized iron characterizing the different processes of manufacture are described.

Welding up of Blowholes and Cavities in Steel Ingots.||—J. E. Stead defines welding as the crystallizing into union of two solid metallic

* Comptes Rendus, cliii. (1911) pp. 156–60 (1 fig.).

† Metallurgie, viii. (1911) pp. 65–8 (8 figs.).

‡ Atti R. Accad. Sci. Torino, xlvi. (1911) pp. 409–32, 558–65. *Rass. Min. Met. e Chim.*, xxxiv. (1911) through *Journ. Soc. Chem. Ind.*, xxx. (1911) p. 1017.

§ *Int. Zeitschr. Metallographie*, i. (1911) pp. 353–76 (18 figs.).

|| *Journ. Iron and Steel Inst.*, lxxxiii. (1911) pp. 54–102 (10 figs.).

surfaces when they are brought together under suitable conditions. In a microsection of a weld, the crystals along the junction are found to be common to each of the original pieces of metal. The higher the temperature at which clean metallic surfaces are in actual contact, the more rapidly do they crystallize together. Upon heating in contact, in hydrogen, duplicate pieces of steel, welding resulted at as low a temperature as 800°C . Axial holes were drilled in three steel bars, and closed with steel plugs; the bars were heated to 800°C . and flattened, then re-heated respectively to 750° , 950° , and 1150°C ., and forged into bars of smaller section. The piece forged at 750°C . showed no signs of welding of the artificial cavity, while the bar forged at 950° was partially, and that forged at 1150°C . completely welded. The author discusses the formation of blowholes, of blowhole segregations, and of pipe in steel ingots. It seems certain that blowholes will weld up completely when an ingot is rolled or forged at a temperature of 1000°C . or higher. It is doubtful if pipe cavities can be so readily welded, as the surfaces of such cavities are frequently coated with oxide.

Some Studies of Welds.*—E. F. Law, W. H. Merrett, and W. P. Digby have investigated the strength and the microstructure of steel welded by various processes. A true weld is regarded as involving fusion together of similar or allied metals. Whatever the process used, a more or less sharply defined region of altered structure is produced. Each process develops its own characteristic structural features in this region, so that a microscopical examination of an unannealed weld indicates by what process it has been made. Resistance welds and acetylene welds appear to be least, and arc welds most, prone to oxidation.

Resistance of Steels to Abrasion and to Crushing.†—F. Robin has tested a large number of different steels and cast irons by submitting them to abrasion by emery paper. The test piece, having a surface of given area, was pressed with a given load upon a disc of emery paper rotating at a known speed on a turntable. Usually the loss of weight of the test piece was determined after 1, 2, and 3 minutes' abrasion. Carbon steels show a minimum of resistance to abrasion at about 0.4 p.c. carbon. Steels containing nickel and manganese in high percentages are exceedingly resistant. Another method of testing investigated consists in the determination of the relation between energy of blow and amount of compression in a metal cylinder deformed by the blow of a falling weight. The shock work is the energy of a single blow producing at a given temperature a crush equal to one-fifth of their depth in normal cylinders at a constant velocity, and is held to characterize the metal tested. The tests were carried out upon a large number of carbon and alloy steels, at temperatures from -180° to over 1100°C . In connexion with this test, "interstrain," or the hardening resulting from mechanical distortion, was studied. The original paper should be consulted for an account of the great quantity of experimental work performed and the conclusions yielded by it, and for the author's views on the numerous theoretical points raised.

* Journ. Iron and Steel Inst., lxxxiii. (1911) pp. 103-24 (33 figs.).

† Iron and Steel Inst., Carnegie Scholarship Memoirs, ii. (1910) pp. 1-270 (94 figs.).

“Filiations” of Metallic Alloys.*—The heterogeneous mass obtained by the superposition of two molten metals, in such a manner that mixing is incomplete, is termed by Le Gris a “filiation” of a metallic alloy. A successful preparation contains one metal in a pure state at the bottom, the other pure metal at the top, while the intermediate layers represent, in order, every possible composition of binary alloy. Le Gris has so improved the method, originally introduced by Le Chatelier, that a complete “filiation” can be obtained not exceeding 1 mm. in height. These small preparations are made by bringing into contact fragments of the two metals, melted and in the globular state, and cooling rapidly the single globule formed. Larger “filiations” are made in crucibles. The preparations are useful for a rapid study of the metallography of the complete system, and by successive re-polishings and etchings with different reagents it is a simple matter to ascertain which reagent is the most suitable for the identification of any one constituent. Similar in principle is a method described for the study of the effect of speed of cooling upon grain-size and other structural features. A small ingot is cast in a non-conducting mould, which has a large cold block of metal as its base. The bottom of the ingot is thus rapidly chilled and solidified, while the rate of cooling becomes slower as the top of the ingot is approached.

The author determines the hardness of the various constituents found in a “filiation” by a modification of the Brinell method. The end of a drawn thread of glass is melted, so that a ball having a diameter of a fraction of a millimetre is formed. A series of impressions is made, proceeding from one end of the preparation to the other, with a load of a few hundred grams; the impressions are conveniently measured on a photomicrograph. The presence of impurities in one of the metals usually has a marked effect upon the microstructure of a “filiation”; this observation may be utilized for the detection of impurities and an approximate determination of the amount present. A “filiation” may be prepared and microscopically examined in a quarter of an hour.

Jointed Arm for Workshop Microscope.†—S. Prauss describes a useful modification of the Stead Workshop Microscope. The Microscope is carried by a jointed arm, the other end of which is attached to the specimen by a vice or an electro-magnet. Any surface of a large mass of metal may thus be examined.

Corrosion of Metals.‡—G. D. Bengough reviews generally the present knowledge of the corrosion of non-ferrous metals. The literature of the subject is summarized, and the electrolytic theory of corrosion, to which the author attaches much importance, is clearly explained. The problems awaiting solution are stated, and a scheme for the investigation of the corrosion of 70:30 brass, in the form of condenser tubes, is put forward.

J. T. Corner § describes some cases of corrosion of metals and alloys.

* Rev. Métallurgie, viii. (1911) pp. 613-25 (21 figs.).

† Métallurgie, viii. (1911) pp. 124-6 (6 figs.).

‡ Journ. Inst. Metals, v. (1911) pp. 28-114 (4 figs.). Report to the Corrosion Committee of the Institute of Metals.

§ Journ. Inst. Metals, v. (1911) pp. 115-26.

Nucleus Action and Grain-growth.*—H. M. Howe discusses Cohen's inoculation experiments, in which bright tin surfaces (usually cold worked) were dulled when pressed against specimens of tin which had previously been rendered dull. Most cases of this infection may be explained on the assumption that the cold-worked metal is in a metastable state, and that contact with normally crystalline metal induces the change to the stable condition, a change which is accelerated by raising the temperature. It is difficult, however, to apply this explanation to the case of the dulling, by contact with dulled tin, of the bright surface of a quietly frozen ingot of tin. The author indicates the bearing on this question, of Charpy's discovery that overstrained iron shows a much more rapid grain-growth between 650° and 800° C. than iron which has not been overstrained.

National Physical Laboratory.†—The existence of the compound Al_2Zn_3 has been fully established, but it is stable only within the temperature range 254°–443° C. The microscopical effects of tensile strain upon strips of various binary alloys of eutectic composition have been investigated; the differences observed in modes of deformation appeared to indicate that the crystalline arrangement is fundamentally different in different eutectics. A remarkably coarse crystallization was observed in some electrolytic iron which had been prepared for experiments on effects of strain at high temperatures. The iron had been annealed after rolling into thin strips. It was possible to detach single crystals from these strips; the individual crystals were found to be perfectly tough and ductile.

* *Met. and Chem. Eng.*, ix. (1911) pp. 79–80.

† *Nat. Phys. Lab. Ann. Report* for 1910.

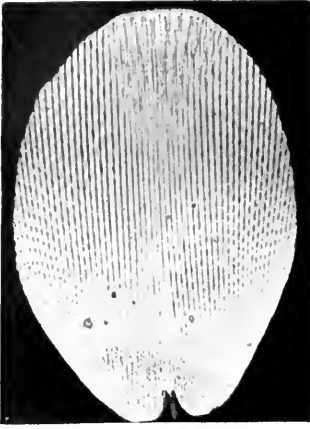

1

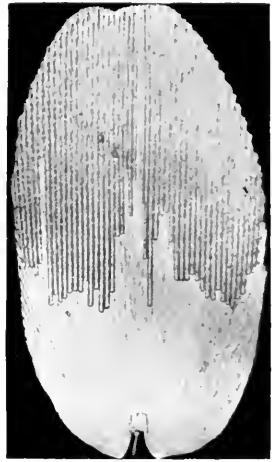

2

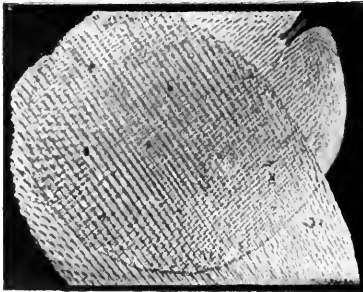

3

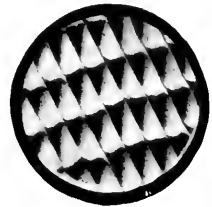

4

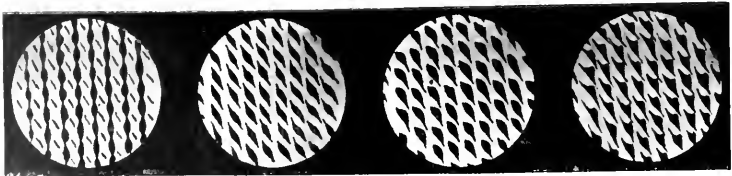

5

6

7

8

JOURNAL
OF THE
ROYAL MICROSCOPICAL SOCIETY.

DECEMBER, 1911.

TRANSACTIONS OF THE SOCIETY.

XXII.—I. *On the Structure of Scales from Thermobia domestica*
(Packard).

By JAMES STRACHAN.

(Read June 28, 1911.)

PLATE XXIV.

Thermobia domestica.—This "bristle-tail" is one of Lepismatidæ—
closely allied to, but distinct from, the common "silver-fish" insect
(*Lepisma saccharina*). It is probably an introduced species in the
British Islands, and is found chiefly in the interior of buildings,
close to warm places such as stoves and hot-water pipes. During
the past few years the present writer obtained a large number of

EXPLANATION OF PLATE XXIV.

- Fig. 1.—Normal scale from *Thermobia domestica* $\times 400$; showing longitudinal
tubes and latter "broken" up at margin.
,, 2.—Scale from *T. domestica* partially immersed in gummy residue from oil of
turpentine; showing upper half of scale with longitudinal tubes and
lower half with radial tubes. $\times 400$.
,, 3.—Scales from *T. domestica* $\times 400$; showing effect produced by crossing two
scales.
,, 4.—Reduced photograph of cuneate markings produced by illuminating the
model obliquely.
Figs. 5, 6, 7 and 8.—Diagrams showing the evolution of cuneate markings from
beaded markings as observed by slowly focusing through the scale of
T. domestica at margin. Fig. 5, Beaded markings. Fig. 6, Twisted
beads. Fig. 7, "Clubbed" or "exclamation" markings. Fig. 8
Cuneate markings.

specimens of this insect in Co. Antrim,* and this circumstance presented a favourable opportunity for the study of its scales.

General Appearance of the Scales.—Under the Microscope the general appearance of the scales is very similar to that of the more common *Lepisma saccharina*. In shape they are for the most part ovate and circular, with a regular indentation at the pedicle. In some scales there is also a slight indentation at the free end. Under low powers they present the familiar “watered-silk” appearance and iridescence. Under medium and high powers they show a shell-like structure, due to longitudinal striæ, which latter at the marginal portion of most of the scales are broken up into bead-like and cuneate markings resembling the “exclamation markings” of *Podura* scales. The area covered by these markings varies in size, being as a rule greater in the more circular scales. The striæ in the central or median portion of the scales are almost invariably unbroken. Towards the pedicle the longitudinal striæ frequently stop short, revealing by their apparent absence another set of striæ, crossing the scale obliquely in two directions and radiating from the pedicle and the median line of the scale. The oblique striæ appear to be slightly narrower than the longitudinal ones. A close examination of the scale with high powers ($\frac{1}{8}$ and $\frac{1}{10}$ in.) clearly reveals, by varying the focus up and down, that the beaded and cuneate markings are produced, as first pointed out by R. Beck, by the intersection of the radial and the longitudinal striæ. The beaded markings occur at the margin towards the pedicle, where the radial striæ cross the others at an angle approaching a right angle, but where the angle of crossing is more acute, towards the free end of the scale, the beaded markings change into the cuneate forms.

Minute Structure of the Scales.—According to R. Beck† the longitudinal striæ appear to project at the free margin of the scale, thus suggesting a series of longitudinal ribs with corrugations between the latter. This is quite true, but a careful examination of the so-called ribs, towards the pedicle end of the scale, shows that they are really the walls of a set of longitudinal tubes. When pressure is applied to the scales these tubes may be made to collapse and disappear to a certain extent, and in some cases when heat is applied both liquid substances and air-bubbles are observed to traverse the tubes. According to the observations of J. Beck the longitudinal striæ are on the side of the scale next the insect, but I find the reverse to be the case, thus supporting the later finding of G. H. Bryan on this point.‡ The scales appear to be slightly concavo-convex in shape, the longitudinal tubes being on the convex side of the scale. On the concave side of the scale the pedicle has

* New Irish Apterygota, by Prof. G. H. Carpenter, Irish Naturalist, May 1911, p. 81.

† Appendix to Sir J. Lubbock's Monograph on the Collembola and Thysanura, Ray Soc., 1872.

‡ Science Gossip, vii. N.S., pp. 152-4.

a projection, which is evidently the point of attachment. Between the two sets of striae there is a thin central membrane. The scales appear to contain some highly refractive substance, and the radial striae start from the pedicle in such a manner as to suggest a system of capillary tubes supplied with fluid through the point of attachment.

On the longitudinal tubes and between the broken markings a minute secondary structure may be observed in the form of little oblique streaks and minute circles. These are due to an effect produced by the light passing through the points of contact of the two sets of crossing striae. The same structure may be observed, on a larger scale, by crossing two scales at right angles to each other, in which case it is produced by the crossing of the longitudinal tubes. A similar structure of minute circular markings was produced on a much larger scale by crossing two sets of fine glass capillary tubes, filled with water and moistened at their points of contact. The form of the secondary structure of the scales is modified by the method of illumination.

Cause of the Beaded and Cuneate Markings.—That the broken markings are due to the crossing of the two sets of tubes or striae is quite evident under a high power ($\frac{1}{10}$ in.). Towards the margin of the free end of the scale by careful and very slow focusing through the former the evolution of the cuneate markings may be observed. First, there is a bead on the longitudinal tube-walls where the radial capillaries cross. This bead lengthens out and becomes twisted obliquely. Then one end of the twisted bead widens out, thus producing an "exclamation" marking. Finally, the wide end of the latter opens out, leaving a cuneate shape. That the radial striae really pass all over the scale is proved by obliterating the longitudinal striae. This was done by Bryan (*loc. cit.*) by placing a grease-spot on the scale. Where the grease-spot was applied the longitudinal striae disappeared, leaving the radial striae alone visible. A much better method of accomplishing this end was discovered by the writer after some experimenting. A slip is ringed with shellac cement and the ring filled with turpentine. Commercial turpentine, which leaves an oily or resinous residue when evaporated, must be used. The turpentine is allowed to evaporate in a warm room and the scales are placed on the oily or gummy residue. The radial striae then become very clear, while the longitudinal ones to a great extent disappear. It is probable that the application of this method will shed light on the structure of other scales, such as *Polura*. In the case of *T. domestica*, in my opinion, two factors are at work in producing the optical effect of the cuneate markings. These are (1) light passing through the two sets of striae; (2) the slightly concavo-convex shape of the scale, which causes the light to pass through obliquely at the marginal area of the scales.

II. *Description of a Model Producing an Optical Effect similar to the Cuneate Markings on Insect Scales.*

In order to test the theory of the production of these markings by the crossing of tubes at various angles, many experiments were made with glass rods, ribbed glass, and tubes filled with various fluids. As a result of these experiments a model was prepared [exhibited], consisting of two sets of parallel thin glass tubes in contact with each other. The tubes were filled with liquids and sealed at both ends. One set of tubes was fixed stationary in a cell and the other set placed in contact with them, but free to revolve over a considerable angle. The best results were obtained by using oil of turpentine in one set of tubes and ethyl-alcohol in the other. It was found that, by illuminating this model obliquely and varying the angles at which the tubes crossed, all the appearances of beaded, "exclamation" and enneate markings could be produced. By modifying the source of illumination and interposing various objects between the light and the model, numerous images resembling the secondary structure could be produced. The crossing of the tubes creates a series of lenses, like a compound eye, each one capable of forming a separate image.

XXIII.—*Instantaneous Exposure in Photomicrography.*

By WALTER BAGSHAW, F.R.M.S.

(Read October 18, 1911.)

ALTHOUGH flash-light has been in common use for purposes of ordinary photography, it has not been tried within the writer's knowledge for photographing through the Microscope, but in the absence of a powerful illuminant, such as the electric light, a ready and simple substitute can be provided whenever the exposure of a fractional part of a second is needed.

In preparing illustrations of pond life, for example, preference is given to dead specimens mounted without pressure, for the simple reason that a time exposure is impossible with anything not absolutely at rest; hence, many amateurs will welcome a method that places in their hands a convenient process of photographing objects in motion.

My first experiment was with fresh-water Polyzoa (*Lophopus crystallinus*) expanding its tentacles, a movement not too rapid for good definition at $\frac{1}{30}$ second. The Microscope was horizontal, with object in vertical cell on the stage, which was focused by properly adjusted transmitted light from oil lamp in the ordinary way, and provision was made for replacing the lamp by a tin dish containing "Agfa" Flash Light Powder on a retort-stand arranged to bring the powder in the position previously occupied by centre of lamp-flame, the top of powder being at the level of bottom of flame. Ignition can then be made at a suitable moment by means of a long taper, or red-hot wire.

To ascertain the most advantageous time for exposure, a dim light should be thrown on the subject obliquely either from behind or in front, sufficient to reveal the outlines when looked at through a hand magnifying glass. The other lights in the room should then be lowered, and the shutter of dark slide withdrawn. Standing in readiness for any desired display of outline, it is easy to fire the powder very quickly.

Some well-defined negatives were secured when using 2-inch objective and $\times 5$ eyepiece. It is advisable to take precaution against any scattered red-hot particles reaching the Microscope by interposing a sheet of plain glass between the powder and the instrument. The quantity of powder is immaterial, as its complete combustion is always $\frac{1}{30}$ second, whilst the maximum light develops in less than $\frac{1}{100}$ second. Only a very little smoke is evolved, which is quickly dispersed.

In this way I have photographed the larva of caddis fly protruding from its case, water shrimps, etc., but I have not yet succeeded in obtaining good definition with darting or rapidly moving objects. I have found no trouble from uneven lighting.

XXIV.—*The Structural Detail of Coscinodiscus asteromphalus.*

By T. W. BUTCHER, M.B. C.M. F.R.M.S.

(Read October 18, 1911.)

PLATES XXV. TO XXVII.

THE note read by Mr. Nelson at the Meeting of the Royal Microscopical Society on October 19, 1910,* announced the completion of over twenty years' labour on this diatom, and contained the suggestion that an enlarged model of it could now be made. I take this opportunity, therefore, of submitting photomicrographs of various specimens in my possession.

Series I.—This displays views in series of a single field, taken at different consecutive foci of the various well-known features—the grouping of the primary areolations, the coarse secondaries (with their finer tertiaries), and the delicate siliceous meshwork woven like a net over the outer surface of the valve in the mature state.

Series II.—Under Series II. are classed fractures—either a single one of special interest, where the outer perforated cap is dislodged from the rest of the valve almost in its entirety, with its structure obvious, as it comes into focus in an otherwise clear space; or a fracture-margin displaying its edges in varied form; or a field where one portion is in focus, whilst other portions, lying somewhat lower down in the mount, give one the appearance of the “eye-spot layer” out of focus.

Series III. A and B.—This series demonstrates the tertiaries described by Mr. Nelson,† and, without re-opening the point as to whether they could be “ghosts” or phenomena of interference, it is self-evident that their irregular number and position in the secondary markings destroys any doubt as to their structural reality, and there is no necessity to enter into any elaborate exercise in geometrical design with Mr. Nelson in elucidating the pattern on

* See this Journal, 1910, p. 698.

† Journ. Quekett Micr. Club, Series 2, vii. p. 81.

EXPLANATION OF PLATE XXV.

- Fig. 1.—Primary areolations; the central perforated membrane surrounded by a ring of coarse “secondaries,” within which are the fine tertiaries. $\times 2700$.
- „ 2.—Fracture displaying a single perforated cap. $\times 1000$.
- „ 3.—Fracture displaying group of perforated caps lying on the upper surface of another larger fragment. At three consecutive foci. $\times 1000$.
- „ 4. Ditto. Ditto.
- „ 5. Ditto. Ditto.

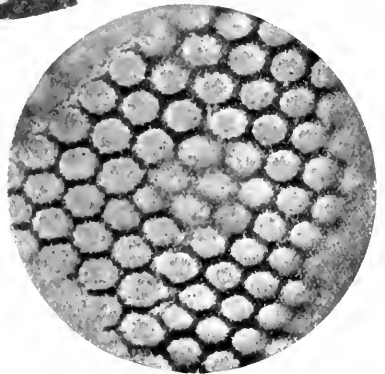
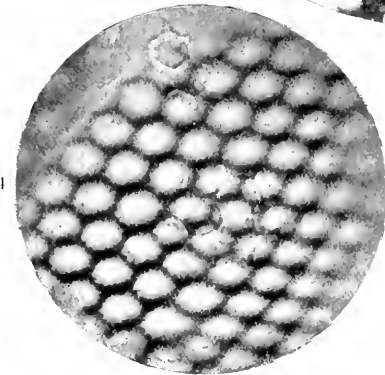
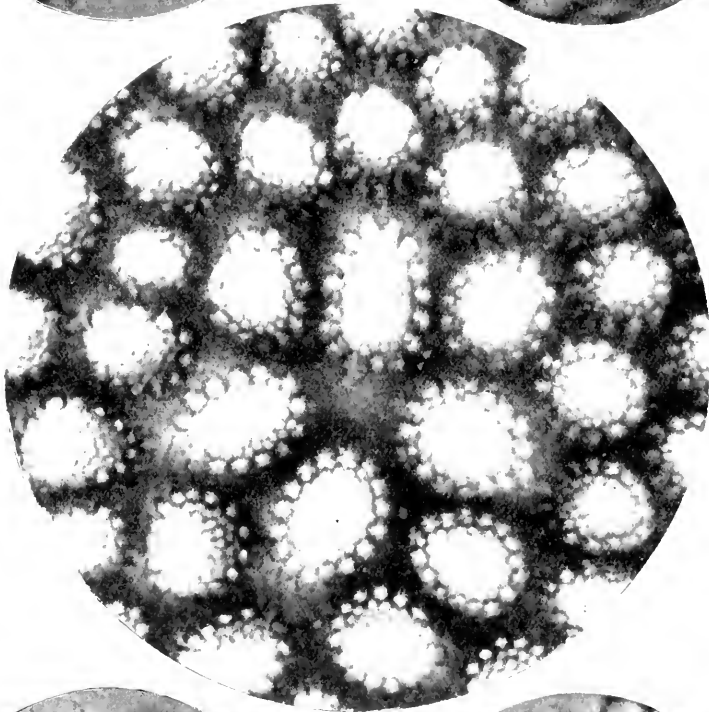
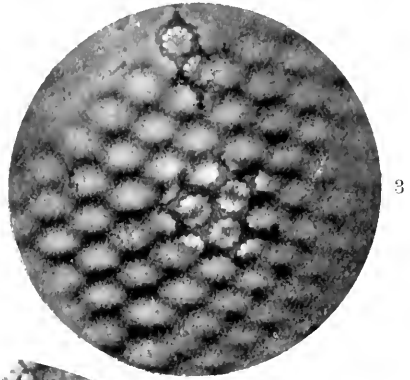
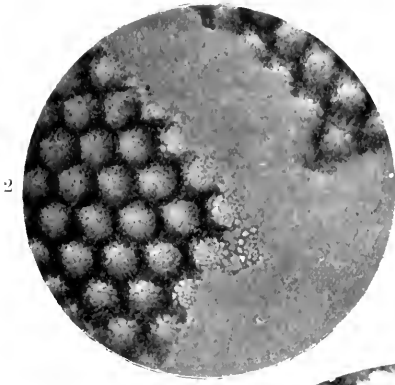

this valve. It is sufficient to indicate that in the areolations nearest to its centre, divisions occur within the secondaries into two or more tertiary spaces, caused apparently by the deposition of minute particles of a siliceous nature, and small circlelets are formed. From these, smaller branches are pushed out in all directions to join other circlelets forming at irregular intervals in other secondaries in these perforated caps. In this way a fine veil is woven over the outer surface of the mature valve, constituting an outer strainer to engage the coarser particles suspended in the water in which the diatom lives. This sediment, as it is deposited, will be easily removed by the movements of the water itself.

The function of the perforated caps is suggested as being that of a fine filter, the water passing through the polygonal cells, of which they are the outer protection, on to the openings in the basal membrane, which, distinguished by the name of the "eye-spot layer," forms the floor of the cells, and is the inner surface of the valve. But Mr. Nelson suggests that a new lens, referred to later, has enabled him to see that these openings are fitted with a still more finely perforated membrane. The perforations here are so fine that Mr. Nelson for once does not give an exact measurement, though he does say that if one assumes that the length of the tubule is four times its diameter, one might occupy one's time counting a hundred a minute, for ten hours a day, for the space of 1381 years, allow 10 p.c. deduction for packing cylinders in a cube, and then one would have the correct number for filling a box 1 c.mm. in size. This can be conceived as an interesting and useful exercise for the mathematician who might be with Mr. Nelson when he says that "we are apt to talk volubly about 1000 and 2000 diameters without in the least realizing what we are talking about," and, I suggest, neglect the fact that it is only by assuming that these tubules are passing through the silex at the rate of 60,000 per inch, and that their diameters are equal to the interspaces between them, that one can give the measurement of the diameter of each tubule as $\frac{1}{120000}$ in., or 0.2116 micron. As an example showing what figures can be made to do, it is excellent, but as scientific micrometry it is of as little value as the diagram supplied would be to the artist engaged on the suggested model, unless he had previously read a note in small type on another page,* which says, "The next inner circle of black dots should be represented about the same size as those at present in the peripheral circles, and, like them, of irregular shape." A better illustration of the advantage as a scientific record of a print made from a "straight," unmanipulated negative, over the sketch of an imaginative draughtsman, as skilled with his pencil as with his figures, need not be sought.

To the biologist, however, a more pertinent question arises.

* See this Journal, 1910, p. 693.

If this valve, formed of a siliceous frame-work arranged in the fashion of a honeycomb, with its intricate system of perforations serving the purpose of a filter, has to be conceived as a congeries of polygonal cells, each with a very finely divided cap on the top, and a still more finely perforated membrane at the bottom of the cell, what is the ultimate fate of the bacterial foes imagined by Mr. Nelson as attacking the diatom? When strained off, are they detained within the cell? Are they removed sooner or later by some system of scientific backwash not yet outlined, or are they imprisoned for life to act as a deposit of microscopic sludge on the floor of the cell, thus preventing the access of the very medium necessary to the life of the diatomic organism under consideration? Such an example of scientific Hari-Kari, of methodically deliberate race suicide, is out of the question.

Series IV. A. and B.—Though one is in doubt as to what the new lens has shown Mr. Nelson in the already well-observed slide that has been in his test box since 1876,* the photographs in Series IV. show quite convincingly that naturally the opening in the "eye-spot layer" is clear and unobstructed, so that it may perform its unmistakable duty of allowing the filtered water free access through the filter cell to the organism within the frustule.

In each group of the series separate fractures are dealt with. In Group A finally the broken edges are seen to be sharp and clean cut, without a trace of crenation comparable to that seen at the edge of the perforated cap (Photo 2, Series II.), and the appearance is exactly what one would accept it as being—a broken edge of the short tube-like cell, described by Mr. H. Morland as giving "a ringed appearance to the perforations when the valve is examined direct on the inner surface."

In Group B the mounter's bristle has, I believe, pierced the surface of the valve, lifted off a portion of the crust covering several of the polygonal cells, leaving fortunately the bottom of the cells exposed and intact as an "eye-spot layer." The photographs of the last resolutions of this floor show corroboratively that the openings are clear and unobstructed, and the series is offered as proof from the optical point of view that the probability of the presence of even a "diaphanous" membrane, first "glimpsed" years ago, and now, on the advent of the new lens, resolved into perforations by

* See this Journal, 1910, p. 147.

EXPLANATION OF PLATE XXVI.

- Fig. 1.—Outer veil of siliceous meshwork. $\times 2700$.
 ,, 2. Ditto. $\times 1000$.
 ,, 3.—Fragment of the polygonal cell-layer, with the "ringed" openings of Morland. $\times 1000$.
 ,, 4. Ditto. Ditto.
 ,, 5. Ditto. Ditto.

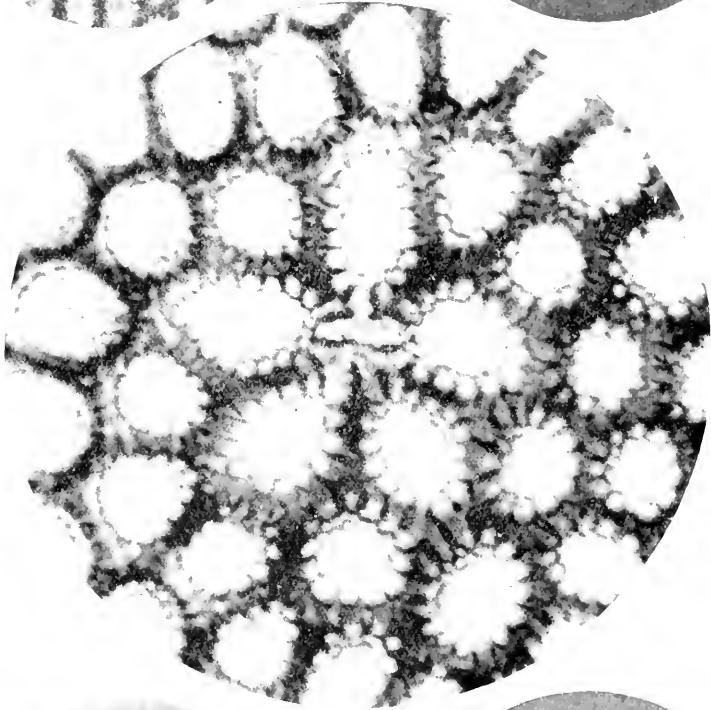
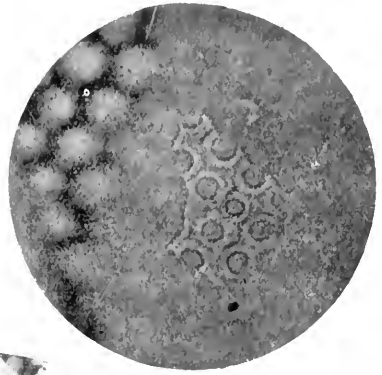
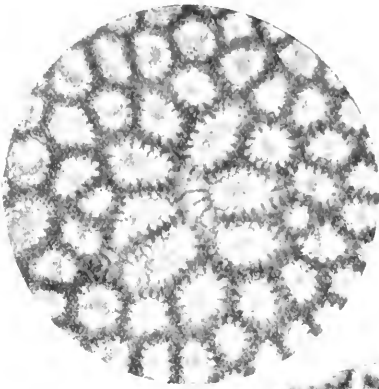

Mr. Nelson, is not to be conceded. One cannot forget that in his paper on "Diatom Structure" he has already said:—"These tertiaries are exceedingly minute." "This is a difficult image, not only on account of its minuteness, but because of its liability to be merely an interference image"; and "In the case now before us, however, its very minuteness prevents this [fracture-margin test] being applied, for it would be quite impossible to see at the fractured edge such a structure, even though it were several degrees coarser." Yet now he says, "A membrane closing the pipe has been seen by me upwards of twenty years ago; it is so diaphanous that its presence was only perceived from an edge in a broken specimen." And, behold! it is dotted with perforations. It is for Mr. Nelson to supply the arguments against the suspicion that he has been recording yet another interference image.

Whilst in London last May, I had several days' study of the slides under almost exactly similar conditions to those set forth by Mr. Nelson in the notes just quoted.

The stand was the Powell and Lealand, No. 1, tube-length 250 mm., oil-immersion, sub-stage condenser, N.A. 1.40, objective (Zeiss) 3 mm. apochromatic, N.A. 1.40, oculars (compensating) Zeiss, screens (*a*) Gifford "F" line and (*b*) Wratten and Wainwright's (D + H) of the "M" series.

The owner, the late Lord Edward Spencer Churchill, believed that the outfit was the one used by the late Dr. Henri van Heurck for his last work on the Diatomaceæ. No further guarantee of the working quality of the apparatus could be desired. That the judgment of this great observer had not been at fault was proved forthwith. The quality of the images presented to the eye was beyond criticism. Employing critical lamp-illumination throughout, the various resolutions already described were obtained with ease, and came out magnificently clear. The fractures were all carefully worked through, but in not one single field was there the slightest trace of the sought-for membrane.

I deal at this moment with another point. Whilst my photomicrographs were being examined at the May Meeting of the Society, one of the senior Fellows passed the criticism "that the absence of the membrane in my specimens was probably due to the valves having been over-cleaned, and that it had been washed away in the process of preparation for mounting."

On hearing this strikingly novel suggestion of an almost incredible dexterity of manipulation by Mr. Firth—admittedly one of the finest of living mounters—I at once replied, "that it was much more likely that Mr. Nelson's ancient slide, upon which the observations had been based, might be an imperfectly cleaned one by a dead and gone mounter, who had not the accurate methods of a modern worker, but that I would at once communicate with Mr. Firth on the matter." There was no necessity to argue the

point, for the washing-out process could hardly have been accomplished without leaving some trace of crenation or irregularity on the inner rim of one of the many ringed openings of Morland that I had photographed, both in the complete and fractured state. This is Mr. Firth's reply:—

“As to my specimens being over-cleaned, I can only say that anyone with this opinion can gladly have a slide for examination. Over-cleaned specimens cannot be handled nor mounted properly, so you can contradict this. I have long experience in cleaning diatoms, and am always striving to improve my slides, and I can say that my present slides are better than those of ten or fifteen years ago. The cement used for fastening the diatoms to the cover-glass is different and better, and the styrax of much better quality. I have requests for slides from Fellows of the Royal Microscopical Society, but none have any special reference to *Coscinodiscus asteromphalus*, though all have been well pleased with those I have sent—generally, diatoms of beauty in marking, etc.—and I feel that they appreciate my work, and would not agree that they are in any way deficient, either through over-cleaning or imperfect mounting.”

Later I asked Mr. Firth to prepare additional mounts of specimens taken from different portions of the Maryland deposit, and in particular to provide me with some of fragments only, mounted as flat as possible in different media of high-refracting index. At various stages of this study I have had the advantage of the counsel and advice of Mr. E. Leonard, who, after examining the slides with the lenses and oculars I was using, was of the opinion that they were first-class mounts of typical examples of *Coscinodiscus asteromphalus*. Most of these slides, prepared by Mr. Firth, are on the stands exhibited here to-night, and as far as possible I have tried to show you the diatom and the conditions under which I was working. One point, however, militating against an absolutely perfect rendering of the tertiary markings, is that, in some cases, oil-immersion condensers have not been obtainable, thus preventing the full display of the value and beauty of this particular diatom. The clearest results have been obtained from two slides mounted in a medium of monobromide of naphthaline and styrax, these being closely followed by two mounted in styrax and one excellent slide in liquidambar styraciflua.

EXPLANATION OF PLATE XXVII.

Fig. 1.—Fragment of the polygonal cell-layer, with the “ringed” openings of Morland. Taken at six consecutive foci. $\times 1000$.

„ 2.	Ditto.	Ditto.
„ 3.	Ditto.	Ditto.
„ 4.	Ditto.	Ditto.
„ 5.	Ditto.	Ditto.
„ 6.	Ditto.	Ditto.

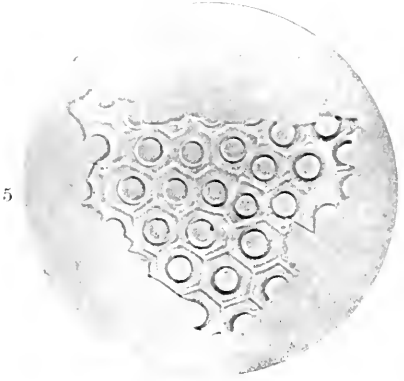
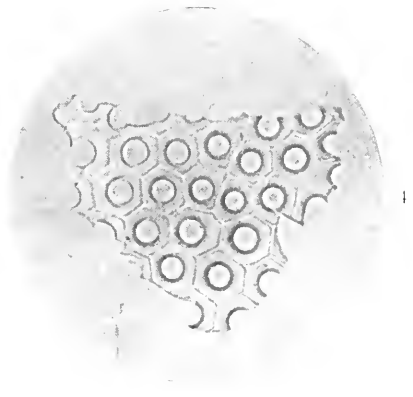
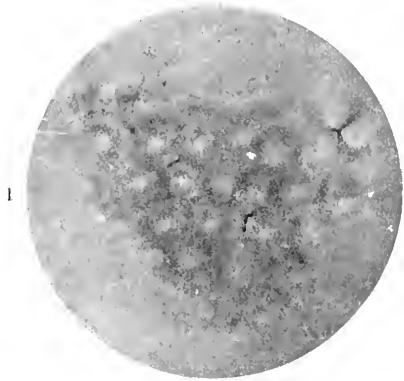

Mr. Firth has mounted them so well that many dozens of photographs have been taken from them without disturbing them in the slightest degree.

There is here material in every way fitted to display the new structure described by Mr. Nelson, for surely, if present, it would be apparent and demonstrable under critical light; and if a structure, and constant, it should not be able to defy detection. Every effort has been made to discover the presence of this membrane, for it was felt that if once seen, a photomicrograph of it could be secured, and that would be all the evidence required in confirmation of Mr. Nelson's announcement. The failure to produce this print arises from the circumstance that I have not been able to get a "glimpse" even of this problematical membrane.

Series V., VI., and VII., showing Tertiary Markings.—Arising out of the resolution of these tertiary markings is a question of considerable importance to all microscopical students.

In the Royal Microscopical Society's Journal, 1910, p. 147, Mr. Nelson states "a definite case." The words are: "The specimen, the Microscope, the sub-stage condenser, the lamp, the method of work, and the eye at the eye-end (hardly improved for being twelve years older), were all the same," and "this apochromatic $\frac{1}{8}$ is more sensitive to tube-length, stands a larger axial cone, bears a deeper eye-piece, and has sharper definition than any Microscope lens I have yet seen." In short—the lens is the finest Mr. Nelson has, as yet, seen, and "a step forward in the perfecting of the apochromatic has been accomplished." It is "a new lens," in our sense of the word, and, in fact, the note on page 698 commences thus: "Additional work with the new lens mentioned in my last note." Therefore one need not dwell on the absurdity of supposing that Mr. Nelson has written and the Society has published his critique on a lens that he had just recently happened to buy.

At the 472nd Meeting of the Quekett Club (March 28th, 1911), reported in the *English Mechanic*, the official organ of the fortnightly Meetings of that Society (No. 2402, p. 215), a paper* was taken as read, in which Mr. Merlin says, "that in 1899 he obtained a Zeiss $\frac{1}{8}$ apochromatic of measured N.A. 1.42, and initial magnifying power 87. He had reason to know that this objective was then probably second to none in existence. However, early in 1910, he was informed that a further advance had been made in the construction of these lenses, and he obtained an example of the combination in June of last year. This objective, exactly similar in aperture and power to the older one, has been found to afford decidedly superior defining power and contrast on delicate objects. Subsequently he re-examined many objects familiar to him with

* Journ. Quekett Micr. Club, Series 2, ix. p. 199.

the older objective, particular attention being given to such as possessed extremely elusive features just within the grasp of the lens. In every case without exception the observations previously recorded were confirmed by the new objective, features previously extremely difficult being found comparatively easy. It should be clearly understood that the new Zeiss apochromatic was manufactured with no intention of being employed solely on the Diatomaceæ." Mr. A. M. Jones spoke next, and said "that at a recent Meeting of the Royal Photographic Society, Mr. Max Poser, of Messrs. Carl Zeiss's London house, had stated that the objective referred to by Mr. Merlin was not constructed to a new formula, but was a picked one of the old series."

Now, what is one to understand from all this? For here is the position: that Mr. Nelson makes the statement that he has examined hundreds of objectives upon this particular slide, and presumably passed an opinion, which may have been adverse, upon them; hence the eulogy of this particular "new" lens in its marking of the step forward of the apochromatic, by reason of its power to pierce the mysteries of the old balsam mount when all its rivals had failed. If so, what is the actual scientific and commercial value of this test? In any case, before full acceptance, it would have to overcome the controversial point of its being a marked instance of the undue importance attached to a "pet slide" test, even though in distinguished hands.

Further, is Mr. Merlin the unfortunate possessor of a twelve-year-old Zeiss $\frac{1}{8}$ apochromatic that has not "weathered" time and constant use? If so, his one-time second-to-none-in-existence lens is verifying a prediction quoted by Mr. Nelson, as follows: "That owing to the instability of these new fancy glasses there would be a falling off in the performance of the finest kinds of object-glasses."* Mr. Nelson, however, says that this has been disproved over and over again, and is a fallacy only mentioned to be destroyed forthwith by his own observations. But there is a way out of the dilemma. To these questionings I can supply the answer. The possessors of high-power apochromatics need not look suspiciously upon their lenses, for all that are in use are by makers of repute, and the plain fact is that if these tertiaries are present, in a properly mounted specimen of mature valves of *Concinodiscus asteromphalus*, they are resolved with comparative ease, and are not so "extremely" elusive as to be only just within the grasp of that lens, to quote Mr. Merlin's reference to his old Zeiss combination. And when present, now that their appearance has become better known, they can be resolved and photographed by a supposedly inferior lens. The photos (Series I, Z.), were taken by me with an old Zeiss 2 mm. apochromatic, N.A. 1.30, projection

* See this Journal, 1910, p. 147.

ocular 4. Similarly, the upper network or veil lying on the outer surface of the valve is not difficult to display when present, and the photomicrographs shown in October last, taken with a still older 2 mm. apochromatic, though with N.A. 1.40, make this quite clear. Indirectly also it is a confirmation of Mr. Merlin's observation in June 1910,* that a similar veil is seen in *N. Smithii*, and we have already seen lantern slides in which it is present in the two specimens I have photographed.

I again say, finally, that I believe that this newly described perforated membrane in the place indicated would be an absurdity from a biological point of view. In this case the error of observation minimises considerably the value of the eulogy from an optical point of view that has been passed upon this particular instance of an advance in the manufacture of the apochromatic lens.

I wish to take this opportunity of thanking Messrs. Watson and Angus very sincerely for the loan of the various stands and lenses through which I have been enabled to exhibit some of the slides mentioned. There are two lenses in use here to-night with which I have photographed these very minute tertiaries, one of them a $\frac{1}{8}$ Zeiss apochromat N.A. 1.40, and the other of the same focal length with N.A. 1.30. There is also a very beautiful lens (3 mm. apochromat N.A. 1.40) set up for me specially by Mr. Powell, with a very perfect specimen under it for examination.

Conditions.

Slides mounted by Wm. A. Firth.

Objective 2 mm. Homogeneous oil-immersion, apochromatic N.A. 1.40. Ocular compensating, $\times 6$. Leitz.

Tube-length 170 mm. Initial magnification, $\times 764$.

Sub-stage condenser: Oil-immersion, N.A. 1.40.

Screen (D + H): Wratten and Wainwright, M series.

Illuminant: Liliput arc lamp. 8 amps.

Carbons, cored 8 mm.

Auxiliary condenser with iris.

Backed plate: ordinary. Speed 225 (H. and D.).

Developer: Metol hydrokinone.

Average exposure: 12 secs.

* See this Journal, 1909, p. 399; and Journ. Quekett Micr. Club, 1908, pp. 247-50

XXV.—*New British Enchytraeids.*

By THE REV. HILDERIC FRIEND, F.L.S., F.R.M.S.

(Read October 18, 1911.)

PLATE XXVIII.

I.—*Enchytraeus minimus* Bret.

AIDED by a Government Grant towards Researches among our British Annelids, I have recently been able to make much progress in the preparation of a Monograph on the subject for the Ray Society. Among the worms to which I have been giving special attention during the present year is a group of microscopic forms which have so far been but very imperfectly studied in this country, and it seems appropriate that I should inaugurate my introduction to this Society by giving, first of all, an account of the smallest of the Enchytraeids at present known, and the latest to be added to our Annelid fauna.

Towards the end of May I paid a visit to Buxton and the adjoining district in the hope of finding something new, and it was here that the worm now to be described was discovered. As I was going along the Serpentine Walk I saw some rubbish and leaf-mould near the banks of the Wye, where the road crosses on the way to Burbage. Among this material I found the common earthworm (*Lumbricus terrestris* Linn.), the red worm (*L. rubellus* Hoff.), the brandling (*Eisenia foetida* Sav.), and other Annelids. I brought away some of the leaf-mould for examination at home, and had the good fortune to find that I had alighted on the haunts of the midget white worm (*Enchytraeus minimus* Bret.).

This tiny creature was first described by Bretscher in 1899 under the foregoing title.* As I have not the original memoir at hand, I am unable to quote the author's definition directly, but I take the following abstract from the careful work of Michaelsen:—

"*E. minimus* Bretscher. Im Leben weiss, hinten gelblich. Borsten zu 3 in den ventralen, zu 2 in den dorsalen Bündeln, ziemlich gross, von halber Segment-Länge. Gehirn $1\frac{1}{2}$ –2 mal so lang wie im Maximum breit, nach vorn verschmälert, hinten abgerundet oder schwach angeschnitten, vorn konkav. Bauchmark mit spindelförmigen Verbreiterungen (Kopulationsdrüsen?) im 5 und 6 Segm. Lymphkörper gross, wenig zahlreich, fast kreisrund, grob granuliert und mit kern versehen. Das Rückengefäss entspringt im 12–14 Segm., 3 Paar Septaldrüsen vorhanden. Peptonephridien

* Rev. Suisse Zool., vi. p. 402.

breit, unverzweigt, vielfach verschlungen schlauchförmig, durch 2 Segm. sich erstreckend. Samentrichter klein, doppelt so lang wie breit. Samentaschen mit dem Darm kommunizierend, einfach schlauchförmig mit spindelförmiger Ampulle, am distalen Ende von einigen Drüsen umstellt.—L. 3–4 mm., Segmz. 30. Vielleicht mit *E. argenteus* zu vereinen. In nasser Erde. Schweiz (Hittnau).” *

This description is so clear and exact that a tyro in the study of Enchytraeids would find it ample for the purposes of identification. Michaelsen was familiar with *Enchytraeus argenteus*, for it was his own discovery. I myself described the worm in 1897 in the Zoologist as *E. parvulus*. Michaelsen, however, had not seen *E. minimus* Bret. when he wrote out the foregoing diagnosis, or he would have recognized at once that they were distinct species. But to distinguish them with absolute certainty one must have the living forms under examination.

I have made a full and careful study of both species, and as my results confirm and extend Bretscher's description, I propose now to transcribe my notes as they were made while the living creature was under the Microscope. It is fortunate that I discovered the species just at the right moment for observing the organs in their mature condition. The study of immature forms may result in difficulty, but when the creature is fully developed one has no hesitation as to the interpretation.

Enchytraeus minimus Bret. lives among decaying leaves and vegetable matter. It is so small that one might easily pass it by, but if damp material containing Enchytraeids is kept for a time, so that the surface becomes dry, the animals seek the moister parts and gradually work downwards. Here they may be detected, when present, by means of a pocket lens or the naked eye. The present species is less than a quarter of an inch in length when fully extended, and in alcohol is not more than one-eighth, or from 3–5 mm., while it is hardly 0·5 mm. in diameter. The number of segments averages twenty-four, and they are of almost equal dimensions throughout. The head is only slightly glandular, and the head pore is situated between the prostomium and the peristomium, being dorsal in position.

The colour, as Bretscher remarks, is white, with a tendency to

* Terreich, Oligochaeta, pp. 92–3. Bretscher remarks (Rev. Suisse Zool., x. (1902) p. 17:—“*Enchytraeus argenteus* Mich. gehört als neue Art ebenfalls der Fauna der Schweiz an; ich fand sie in den Erdproben von Zurich, Basel, Morges, Trimmis, Riesenstalden. Michaelsen hält dafür, dass mit dieser Spezies meine *E. minimus* vielleicht vereinigt werden sollen. Nach dem ich nun unzweifelhafte *argenteus* zu Gesicht bekommen habe, halte ich eine solche Vereinigung für unstatthaft. Die Lymphkörper von *minimus* sind durchaus hell gefärbt; die Drüsen an der Oeffnung der Samentaschen, die Verarbeitungen des Bauchmerkes, der viel schlankere Leib bilden fernere Unterscheidungsmaße.” See Southern Contributions towards a Monograph of the British and Irish Oligochaeta, Proc. R. Irish Acad., xxvii. sect. B, No. 8, p. 157.

a dull yellow behind the girdle; but these colour distinctions are not of importance seeing that they vary greatly with food, habitat, season, and other conditions. The worm is active, and but for the opaque white spot near the middle, revealing the presence of eggs, it might easily be mistaken at first sight for a large Nematode. The setæ, however, are soon discovered when it is placed under the Microscope, and the presence of setæ immediately enables one to differentiate it alike from Nematodes and from minute larvæ of Diptera and other creatures.

As the setæ are an important feature I may add that I gave them special attention, since it was this character which enabled me at once to distinguish it from another form (*Enchytræus hyalinus* Eisen), which it somewhat resembles in other respects. Michaelsen's diagnosis gives the setæ as equal, but the term must be interpreted in relation to the setæ of *Fridericia*. In the latter genus the setæ are often of different lengths in each bundle, but in *Enchytræus* they are equal. I find, however, a difference in the length of the setæ of *E. minimus* Bret. in different parts of the body, and the number of setæ also varies. Thus, the dorsal setæ are two in number in front of the girdle, and three in the hinder segments, while the ventral setæ number three throughout. The first segment (peristomium) has no setæ, the girdle segment lacks the ventral setæ, while the extreme posterior may also be destitute of them. Now the two pairs of dorsal setæ on the girdle segment are small, and if their length is represented by 4, that of the front segments will be 8, and that of the hinder 9. In other words the posterior setæ are slightly longer and more slender (as 9 : 8) than the anterior, while the latter are double the length of those on the girdle. It is possible that these details are liable to slight variation, but these are my results. (Plate XXVIII. fig. 1.)

Next to the setæ, perhaps the peptonephridia or salivary glands are the most striking object. In no worm which I have ever examined has the similarity between salivary glands and nephridia

EXPLANATION OF PLATE XXVIII.

- Fig. 1.—Diagrammatic representation of:—1. Girdle segment with two pairs of short dorsal setæ and male pores (*mp.*). 2. Segment v. with two pairs of dorsal setæ and triplets in ventral bundles. 3. Posterior segment with four bundles of triplets. Ratios 4, 8, 9.
- „ 2.—Showing branching of blood-vessel in anterior segments of *Enchytræus minimus* Bret. (the blood is white).
- „ 3.—Segments iii.–vi., to show peptonephridia (*p.*) and spermathecæ (*sp.*) opening into intestine (*int.*). These organs are paired.
- „ 4.—Sketch of *Fridericia peruviana*. The hatched lines indicate such portions of the vascular system as were made out. *br.* brain; *ph.* pharynx; *gl.* perhaps copulation gland (unpaired) on segment 5; *sept. gl.* septal gland in segments 5–7; *s.g.* salivary glands, unbranched and seeming to be attached behind in segment 7; *dil.* enlarged vessels in segments 7, 8, 9; *pr.* prostomium. No setæ shown.

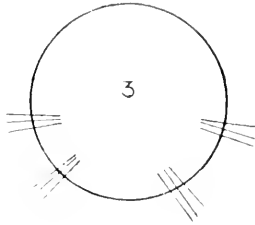
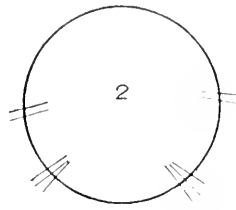
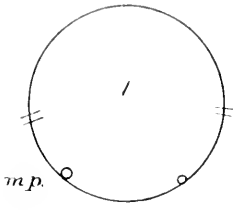

I.

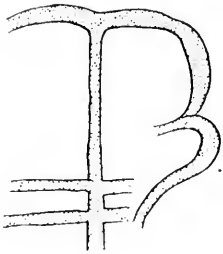

II.

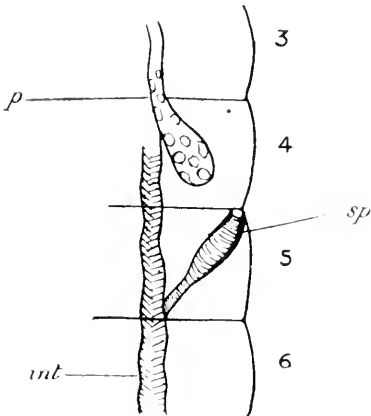

III.

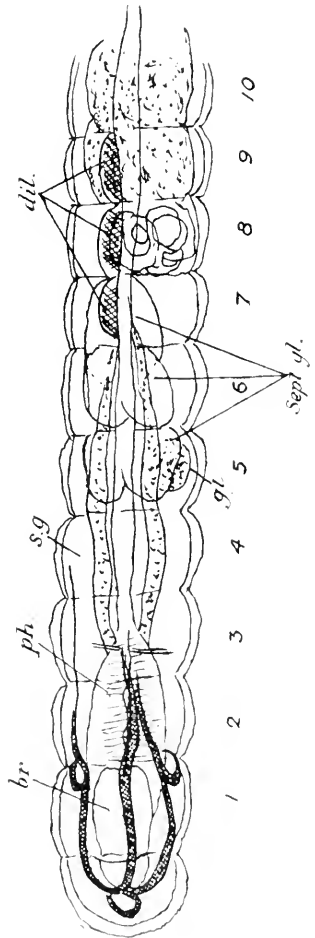

IV.

appeared so marked. Bretscher's description as given above is exceedingly accurate for the British species. These organs branch out immediately behind the pharynx and extend back to the beginning of segment v., filling up almost all the coelomic cavity of segment iv., and presenting a very striking appearance (Plate XXVIII. fig. 3). There are three pairs of septal glands in segments v.-vii., the hindmost pair being, as is frequently the case, the longest; and by the side of this pair lies the first pair of nephridia.

The dorsal vessel I found in one instance to begin in segment xiii. There is no other allusion in the diagnosis given above to the vascular system. I may therefore add that I have found an enlarged blood-vessel in segment viii., which reminds one of what occurs in certain species of water-worm, such, e.g., as *Limnodrilus*. Further, there is a double commissure in the 3rd segment (Plate XXVIII. fig. 2), but I have not worked out all the details of the system. The coelomic corpuscles are oval, blunt, cigar-shaped, or circular. It often happens that these bodies assume a globular or circular shape immediately on being set free, though they may appear pointed when they are flowing about in the coelom. The intestine is covered with cells which have under certain conditions a very oily appearance. The girdle extends over segment xii. to the setæ of segment xiii., and is slightly more cellular or glandular in structure than the other parts of the body.

When one is examining the region around the girdle, eggs in all stages of development may perhaps be in the field. Though these look white to the naked eye they are opaque under the lens, and may make it difficult for the observer at first to study the details of the sexual organs. Large male pores are found on the girdle segment where the ventral setæ are wanting, connected with which is a long and very narrow duct leading to the ampulla, which is somewhat pear-shaped, about twice as long as broad, and possessed of a brownish orifice. These organs are paired.

I have not detected in our native species the thickenings or copulation-glands of the nerve-chord in segments v. and vi. But my experience teaches me that these are very variable, and their meaning, permanence, and other details are not yet sufficiently understood. The brain is well developed and somewhat rounded behind. Only when extremely tense does it show any signs of concavity, this being due to the lateral attachments.

The nephridia are chiefly post-septal, but I have not observed the duct. The only other point of importance relates to the spermathecæ (Plate XXVIII. fig. 3). These are such characteristic organs that it is always necessary to give them careful study. The presence or absence of diverticula may enable one instantly to decide the species. In the Enchytraids they are (with one or two exceptions) always found in segment v., with their opening in the

intersegment 4/5. Sometimes well marked glands are to be found at the orifice or along the duct, but in the present instance I found no such glands, nor were any diverticula present. The organ appears somewhat bottle-shaped, with the narrow neck towards the intestine into which it opens.

As it is proposed to follow this study with descriptions of other new species, it has been thought advisable to go somewhat more into detail than will be necessary in later papers. A few figures are added to make some of the points intelligible to those readers who have not heretofore given the Enechytraeids any attention.

II.—*Fridericia Peruviana* sp. n.

On May 13 I received from Kew Gardens a small quantity of earth, containing two young Annelids, from Peru. The mould had come with some plants in Wardian cases, and I kept it for some days to see what other specimens of interest might reveal themselves. On Whit Monday, while I was subjecting the material to more careful examination, I found a small Enechytraeid which presents so many interesting features, and is so different from any other species yet known to me, that I have ventured to regard it as a new species. As there seems no reason to suppose that it got into the mould after reaching this country, and as it is a well-marked *Fridericia*, I have not hesitated to name it after the country whence it seems to have reached England. While there are one or two *Fridericias* which approach it in certain characters, there are, on the other hand, various points of association with *Henlea* and *Buchholzia*, as will be seen when the diagnosis is complete. In size, average number of setæ, and one or two other particulars, it approaches *Fridericia parva* Bretscher (= *P. Bretscheri* Southern), a species which has already been found in Switzerland, Scotland, and Ireland. But the differences are at the same time great and important.

The new species is 5–6 mm. in length. The intestine from the 8th or 9th segment backward is covered with brownish cells, which render the animal somewhat opaque. The cœlomic corpuscles are large and numerous, so that it is very difficult to see the nephridia. These corpuscles instantly break up upon being forced out of the body, indicating that they are surrounded by an unusually delicate membrane. The nephridia are lobed, and the main portion is post-septal. The anus is terminal, very glandular and sensitive, with a large aperture of striking structure. It appears to be composed of four large flaps, or valvular flanges, closely resembling those of *Dero obtusa*, which seem to indicate that the worm may live in a habitat where a specially constructed posterior is of value, perhaps, for purposes of aeration. Consequently there are no setæ on the two hind-most segments. The setæ range from two to five in

number, four being predominant. In the hinder portion of the body the setæ are of almost equal length—two, three, or four in a bundle. In the middle of the body the setæ are four, the innermost pair being somewhat shorter than the others. In the front of the body the setæ are shorter than behind, and are often irregular. There may be two, three, four, or even five (rarely) in a bundle, and it frequently happens that they are of different lengths, recalling, in some degree, the appearance of the setæ in *Buchholzia fallax*. But the reason is different, the irregularity in *Fridericia* being due to the falling away of the outer setæ on one side of the bundle while they remain on the other.

The number of segments is about 35, and they are nearly all of equal dimensions. The head is only slightly glandular. There are three pairs of septal glands in segments 5, 6 and 7, and on the integument of segment 5 a large unpaired gland, brownish in colour, and made up of many very small cells. It may be a copulation gland,* but differs from all others I have ever seen, and is not connected with any modification of the nerve centres. The brain is slightly indented or concave behind but not in front. The pharynx extends through the whole of segment 2 and the half of segments 1 and 3, and could be everted with ease.

As is the case with *Henlea*, the œsophagus is sharply marked off from the intestine. The intestine of the 8th segment assumes a unique appearance, and the 9th is the first which is normally like all those which follow. The dorsal vessel springs from segment 13 or 15, and in segments 7, 8, 9 there are large pulsating dilatations, which seem to resemble those found in *Fridericia perrieri* Vejd., and in that case are of peculiar interest, as they show that such enlargements are not necessarily (as Beddard suggests) connected with the antielitellian origin of the dorsal vessel.

There is a very small commissural vessel in segment 3, but the blood-vessels are extremely delicate, and are made out with difficulty. This is due in part to the fact that the blood is colourless, and it is therefore often very hard to say where the various organs begin, end, or overlap. This is especially the case also in reference to the salivary glands, which spring from the œsophagus close to the pharynx, and extend backwards without branching, forming long sacs, as in *Fridericia parva* Bret. Indeed, after the most careful examination, I could not discover a free posterior extremity, and I have come to the conclusion that these glands are attached to the œsophagus at both ends in or near segments 3 and 7. But as all my observations had to be made upon a single specimen, it may be that when further material is obtained this view will have to undergo modification. (Plate XXVIII. fig. 4.)

* Later study leads me to think it is not a point of importance.

As the worm was immature, there are no observations to record respecting the nature or position of the clitellum, or the shape of the sperm-ducts and funnels. The spermathecae also were undeveloped. This is greatly to be regretted, as it would have been possible, were these important organs matured, to form a better opinion as to the possible relation with *Fridericia parva* and other allied species. We may summarize the foregoing account as follows:—

Fridericia peruviana Friend. Length 5–6 mm., setae 2–5, somewhat longer behind than before. Brain slightly concave posteriorly. Esophagus sharply marked off from intestine. Dorsal vessel post-clitellian in origin, with dilatations in segments 7–9. Three pairs of septal glands; salivary glands not branched; nephridia lobed, chiefly postseptal.

SUMMARY OF CURRENT RESEARCHES
RELATING TO
ZOOLOGY AND BOTANY
(PRINCIPALLY INVERTEBRATA AND CRYPTOGAMIA),
MICROSCOPY, ETC.*

ZOOLOGY.

VERTEBRATA.

a. Embryology. †

Gestation in White Mice. ‡—J. Frank Daniel notes that the general estimate of the period of gestation in white mice as twenty-one days, requires considerable modification. The period in non-suckling mothers is practically twenty days: in suckling mothers the period seems to be very variable. Not only does one mother differ from another in period of gestation, but the same mother at different times shows considerable variability. The minimum is twenty-two, the maximum thirty. It seems that the period of gestation, in lactating mothers, varies directly with the number of young suckled. The delay due to lactation may operate by retarding ovulation, but the author thinks that it operates by retarding the development of the young before birth.

Factors of Traumatic Parthenogenesis. §—E. Bataillon discusses the occurrence of artificially induced parthenogenetic development in Amphibians. Electrical stimulation may induce more or less pronounced cleavage, but it never goes as far as gastrulation. Puncturing with a thermic cauterium leads to cleavage, but in the puncturing something gets in—a leucocyte or some serum—something not specific. Bataillon distinguishes this traumatic parthenogenesis from that induced, for instance, in Loeb's experiments, but we have not been able to get a clear view of his position.

Alleged Lactation of Male *Lepus bairdii*. ||—A. Berger discusses E. Hart Merriam's (1872) description of adult males of *Lepus bairdii*.

* The Society are not intended to be denoted by the editorial "we," and they do not hold themselves responsible for the views of the authors of the papers noted, nor for any claim to novelty or otherwise made by them. The object of this part of the Journal is to present a summary of the papers as *actually published*, and to describe and illustrate Instruments, Apparatus, etc., which are either new or have not been previously described in this country.

† This section includes not only papers relating to Embryology properly so called, but also those dealing with Evolution, Development, Reproduction, and allied subjects.

‡ Journ. Exper. Zool., ix. (1911) No. 4, pp. 865-70.

§ Comptes Rendus, clii. (1911) pp. 920-2.

|| SB. Ges. Natur. Freunde Berlin (1910) No. 7, pp. 305-6.

which had mammary glands full of milk, and the hair moist round the mamme. He expresses the hope that some American zoologist will corroborate or contradict Merriam's account. Isolated cases are known in which a man has been able to produce milk, and Stengel induced lactation by artificial manipulation of the milk glands in a male calf.

Colour Inheritance in Pigeons.*—J. Lewis Bonhote and F. W. Smalley state some of the results of a series of experiments in which they are engaged. They have reached the following Mendelian conclusions: 1. Silver is dilute blue. 2. Blue is dominant to silver. 3. Chequering is dominant to its absence (i.e. a self-colour). 4. Grizzling is dominant to its absence (i.e. a self-colour). 5. Grizzling is dominant to chequering; the impure dominants may, however, sometimes be easily distinguished. 6. A mealy is a grizzled bird with the white wholly or partially replaced by red. 7. Red in a mealy is apparently dominant to white, and hence a mealy is dominant to a grizzle. 8. White and grizzling when they have met combine together and have a common inheritance. 9. Red combines with grizzling in the same way as does white.

Many details, however, do not entirely accord with the Mendelian theory. Some law or series of laws over-rides and modifies (externally at all events) the expected Mendelian results. A consistent deviation from expected proportions occurs. It would seem that some factor exists which has the power to influence but not to alter the gametic inheritance.

Interchange of Limbs of Chick by Transplantation.†—Florence Peebles finds that it is possible for chick embryos to develop in porcelain cups in a moist chamber at the proper temperature up to the ninth day, although the development is delayed. The leg bud when removed may be grafted on the proximal part of the wing, and the wing bud may be grafted on the proximal portion of the leg without permanently injuring the embryo. The results indicate that when the tip of a young bud is grafted on the proximal portion of another limb it becomes a part of the appendage to which it is attached instead of retaining the character of the part it is destined to become. No regeneration of the limbs takes place after the removal of the buds.

Influence of Environment on Reproductive Period.‡—The late Salvatore Lo Bianco left an interesting paper in which he discussed the movements of the sea, the chemical and physical conditions, the horizontal and vertical distribution, the nutritive conditions, and the like, in their influence on the period of reproduction.

Involution of Tail in *Alytes obstetricans*.§—P. Wintrebert finds that neither the lateral line system nor any part of the spinal cord or brain has any directive role in the metamorphosis.

Physiology of Fish-eggs and Larvæ.||—W. J. Dakin has continued his enquiry into the physico-chemical relations existing between the body-

* Proc. Zool. Soc., 1911, pp. 601-19 (4 pls.).

† Biol. Bull., xx. (1910) pp. 14-18 (2 figs.).

‡ MT. Zool. Stat. Neapel, xx. (1911) pp. 129-56.

§ C.R. Soc. Biol., lxx. (1911) pp. 3-5.

|| Internat. Rev. Hydrobiol., iii. (1910-11) pp. 487-95.

fluids of marine animals and the sea-water. He has experimented on the eggs and larvæ of Teleosts and Elasmobranchs.

The freezing-point of the contents of plaice-eggs is very different from that of the sea-water in which they are found floating, and the osmotic pressure is only about two-fifths that of the latter. The freezing-point of the contents of dog-fish eggs is about the same as that of the sea-water.

Immersion of dog-fish eggs in a fluid of less salinity than normal sea-water, results in a gain in weight due to absorption. The contents of the purse are therefore not independent of the external medium, and a change in salinity of the latter brings about an alteration in the salinity and osmotic pressure of the egg-contents.

The osmotic pressure of the egg-contents in plaice and dog-fish resembles very closely that of the blood of the adults. In the case of the pelagic eggs of the plaice, death results in a disturbance of the conditions under which the equilibrium existing between the egg-contents and the sea-water is maintained, and an increase in the salinity of the egg-contents accompanied by an increase in density takes place, with the result that the eggs can no longer float.

Retarding Development of Herring's Eggs.*—H. Chas. Williamson has been able, by lowering the temperature of the water, to prolong the period of embryonic development to fifty days. This is with a view to facilitating importation to New Zealand. Further experiments in extending the period have proved unsuccessful, and the author recommends that the eggs should be put as soon as possible after spawning into running water, or water kept in motion, and that effective mechanical aeration be secured.

Colouring of Trout.†—K. Wagner has made a study of the development of the coloration in the young trout (*Salmo fario*). The original pigment is the lipochrome of the yolk-sac. The first melanoblasts appear, at a temperature of 7–10° C., some fourteen days before hatching. In other Teleosteans that have been described the time noted is about the time of hatching.

The first melanoblasts separate off from the uppermost portion of the muscle-segments. There is progressive pigmentation in situ and also active migration. The epidermis remains quite unpigmented.

The bands of colour differ from other parts not in having more chromatophores, but in having them in different state of expansion. They function independently of the rest of the body.

The first orange-red colouring is found associated with ramified cells of the connective-tissue. These cells appear about a week later than the melanoblasts. The plasma of the orange-red cells is filled with an oil-like mass, in which a variable quantity of lipochrome has been dissolved. The cells form in their interior the subsequently extra-cellular lipochrome drops, which unite in the red spots of the older trout. There are also carmine-red drops and an iridescent granula.

* Fishery Board Scotland, 28th Rep. (1911) pp. 16-23 (1 pl.).

† Internat. Rev. Hydrobiol., iv. (1911) pp. 1-33 (1 pl.).

Origin of Notochord Epithelium.*—W. Georgi found in embryos of *Necturus* that the primitive notochord-cells (Urchordazellen) produce the elastica externa. Thereafter, but while it is still very fine, mesenchyme cells pass through it into the notochord and form the epithelium. From the epithelium, and therefore of mesodermic origin, there are formed two other sheaths, the fibrous sheath and the elastica interna. After the latter is formed there is no further immigration of mesenchyme cells possible. The notochord cartilage, which takes the place of the primitive notochord, is also due to the chorda-epithelium.

Development of Myotomes.†—A. L. J. Sunier has studied the first stages in the internal differentiation of myotomes and the formation of sclerotomatic elements in Acrania, Selachians, and Teleosts. The undifferentiated elements of the wall of the myotomes become partly muscular, partly mesenchymatous (connective in Acrania). The primordial elements of the musculature are cells in the form of plates, which afterwards become split up longitudinally into fibres. The formation of sclerotomatic elements in Craniata is simply the dissolution of a portion of the median wall of the myotome. The sclerocoel of Selachians is the space which remains between the median wall and the rounded ventral end of the muscular mass. It has no connexion with the formation of sclerotomatic elements, and it is quite different from the altogether special sclerocoel of *Amphioxus*. It seems very doubtful if the "external layer" of the mesoderm has the same significance in different Vertebrates.

Role of Interstitial Testicular Cells.‡—L. Mazzetti has studied these elements in a variety of types, such as frog, bird, dog, and man. He finds that the interstitial cells are unquestionably of connective-tissue origin, being transformations of connective cells which proliferate between the tubules. They may also arise, and perhaps in greater part, from lymphatic lacunae. They have either no importance or only a minimal importance in connexion with secondary sex-characters. These are determined by re-absorption of seminal fluid, including both sperm-cells and their secreted products.

b. Histology.

Spindle-cells of Amphibian Blood.§—E. Neumann maintains that the erythrocytes arise in part from the colourless spindle cells, and that there is a continuous series of transition types between spindle-cells and lymphocytes.

Eye of Pteropus.||—Gustav Fritsch describes a remarkable peculiarity of the eye of *Pteropus condorensis*, similar to that also discovered by Kolmer in *P. medius*, namely, that the choroid sends long finger-like or spindle-shaped (not conical) processes into the middle layers of the retina. His description differs considerably from Kolmer's.

* Anat. Anzeig., xxxviii. (1911) pp. 176-87 (4 figs.).

† Onderzoekingen Zool. Lab. Rijksuniversiteit Groningen, ii. (1911) pp. 1-99 (6 pls.).

‡ Anat. Anzeig., xxxviii. (1911) pp. 361-87 (14 figs.).

§ Arch. Mikr. Anat., lxxvi. (1911) pp. 725-44.

|| Zeitschr. wiss. Zool., xcviii. (1911) pp. 288-96 (1 pl.).

Eye of Protopterus.*—E. Grynfeldt gives an account of the minute structure of the eye of *Protopterus annectens*, which he finds on the whole to be nearest that of other fishes, especially as regards the external and the middle tunic. On the other hand, as regards the retina, there is an approximation to the Urodelous Amphibian type, perhaps by convergence, especially as regards the details of the rods and cones.

Distribution of the Muscle-fibres in Heart of Fishes.†—Luigi Sala has examined the heart in ten Selachians, two Ganoids, and fifty-six Teleosteans in reference to the arrangement of the muscle-fibres. He describes various dispositions, e.g. the occurrence of longitudinal bundles to the inside, transverse bundles to the outside, and radial bundles between.

Cutaneous Papillæ in Gobius.‡—L. Sanzo has made a study of the cutaneous papillæ, or cyathiform organs, which occur in various series—about the orbit, the jaws, the operculum, the back, the sides, etc.—of the various species of *Gobius*, seventeen of which are dealt with. He describes the distribution of the papillæ characteristic of the different species.

c. General.

Animal Life of Sea-bottom.§—C. G. Joh. Petersen and P. Boysen Jensen have studied the quantity, composition and nutrition of the bottom-fauna in Danish fjords. The stomachs of bottom-animals chiefly contain a "dust-fine mass." This is partly inorganic, partly organic, but with few living organisms. It is largely due to the benthos vegetation, especially in the thin brown layer which is uppermost. In several enclosed fjords with rich bottom-vegetation, large quantities of dissolved organic matter have been found in the sea-water. Most of the bottom-animals feed on detritus, partly obtained from the water, partly from the brown layer. The authors emphasize the importance of quantitative studies.

Validity of some forms of Mimicry.||—N. Manders has devoted much attention to the insectivorous birds and reptiles in Bourbon, Mauritius, and Ceylon in their relation to alleged cases of mimicry. He has reached the following conclusions:

In Bourbon and Mauritius there are no butterfly-eating birds or reptiles, so that cases of mimicry occurring there cannot be due to their influence. In Ceylon it has been shown that the butterfly-eating reptiles are impartial feeders.

A trained observer can distinguish the majority of these mimetic butterflies at a distance of twenty or thirty feet, and frequently at the same number of yards. This being so, it is certain that a bird, which depends on its powers of observation, could soon learn to discriminate.

Drongos feed largely on Eupleas, and this being so, a *Papilio*

* Bull. Mens. Acad. Sci. Montpellier (1911) pp. 210-32 (1 fig.).

† Rend. R. Ist. Lombardo, xliii. (1910) pp. 825-9.

‡ MT. Zool. Stat. Neapel, xx. (1911) pp. 251-328 (4 pls. and 15 figs.).

§ Report Danish Biol. Station, xx. (1911) pp. 1-78 (6 pls., 3 charts, and 6 tables).

|| Proc. Zool. Soc. (1911) pt. 3, pp. 696-749.

mimicking them obtains no protection in the vicinity of these birds. There is no bird in Ceylon known to eat butterflies that distinctly discriminates as an adult between one species of butterfly and another.

It has been shown that there is a great destruction of butterfly life in the dry zone, and that here, if anywhere, Müllerian or Batesian mimicry might be induced, but the destroyers are largely migratory, and their attacks are not selective.

The number of broods of butterflies which occur between the termination of tasting experiments in one year and the commencement of them in the next, is so great that any influence which could be wrought by such is almost inappreciable.

The little evidence available shows that young Ceylon birds imitate their parents in their choice of food; but as regards butterflies, the fact that there is no discrimination shown by adults leads one to conclude either that few or no tasting experiments are undertaken in youth, or, what is more probable, that their taste with regard to them is indifferent.

So far as an accurate knowledge of one species goes it is definitely shown, that that form of mimicry represented by wet and dry season forms (cryptic defence) is not produced for the protection of the species, inasmuch as many (four) succeeding broods of the wet weather form may be found under dry season conditions without detriment to the species.

Different kinds of Hair.*—K. Toldt has given a useful account of the different kinds of hairs, distinguishing three main types, bristles (Grannenhaare), wool, and "Leithaare." The "Leithaare" are longer and stronger than the bristles; they are stiff, sparse, and isolated. According to the author, the most primitive kind of hair is the "Leithaar," then the bristle, then wool-type. Special forms of hair, such as those in some bats, in the tail of some porcupines, etc., are described. The disposition of the hairs on the body of representative mammals is also discussed.

Composition of the Lower Jaw.†—E. Gaupp finds that the "gonial," a membrane bone of the primordial lower jaw, is the so-called "angular" of amphibians, the processus anterior mallei of mammals, and has a varied history in reptiles.

In amphibians, the primordial lower jaw may show a posterior and anterior ossification (articular and mento-mandibular), and the following membrane bones: dentary, opercular (= splenial), gonial, and exceptionally an element called "angular."

In Sauropsida the articulating end of the primordial lower jaw ossifies as the articular, and there may be as many as six membrane bones—dentary, opercular (= splenial), gonial, angular, supra-angular, and complementary.

In mammals there arise on the primordial lower jaw three membrane bones—the definitive mandible (corresponding to the dentary), the tympanic (probably = angular), and the processus anterior mallei (= gonial). From the articulating end of the primordial lower jaw the

* Ann. Natur. Mus. Wien, xxiv. (1910) pp. 195-268 (4 pls. and 1 fig.). See also Zool. Zentralbl., xviii. (1911) p. 416.

† Anat. Anzeig., xxxix. (1911) pp. 609-66 (6 figs.).

chief part of the malleus arises. The malleus as a whole is a gonio-articular.

One of the general characteristics of the gonial is its close topographical relation to the chorda tympani, which often penetrates into the canalis primordialis of the embryonic lower jaw. This is retained in some mammals in the perforation of the processus anterior mallei.

In mammals, as contrasted with reptiles, the posterior toothless portion of the jaw gets separated off and goes into the service of the ear (articular + gonial = malleus; angular = tympanic, and quadrate = incus). The anterior part acquires a new connexion with the squamosal, forming the "secondary" articulation of mammals. This is exclusively a squamoso-dentary articulation (formed between two bones not previously in association) and is not shared in by components of the old quadrato-articular joint.

The "ramus" of the mammalian lower jaw is probably referable to the processus ascendens of the reptile dentary, which differentiates into a condyloid and a coronoid portion. The probable history of the establishment of the characteristic mammalian squamoso-dentary articulation in front of the old quadrato-articular joint is discussed in detail.

Origin of Domestic Dog.*—E. L. Trouessart revives and corroborates a view suggested in 1877 by Jeittele that the ancestor of domestic dogs is to be found in the small Indian wolf, *Canis pallipes* Sykes, which has a well-marked supra-orbital crest. The only exception he will admit is that of the dogs of Ancient Egypt, recently discovered by Hilzheimer and by Gaillard and Lortet, which seem to have been derived from several species of jackal. The author cannot agree with Studer's conclusion that the domestic dog is descended from a European species which became extinct in Quaternary times.

Reproductive Organs of Domestic Animals.†—R. Schmalz has given a monographic account—both anatomical and histological—of the reproductive organs of horse, ox, sheep, pig, dog, and cat.

Mobility of Penguin's Vertebral Column.‡—Hans Virchow has made a study of the freedom of movement in the vertebral column of the penguin (*Spheniscus*)—a mobility familiar enough to those who have watched the birds in zoological gardens, but emphasized in recent years by the photographs of various Antarctic explorers. The author analyses the different possibilities, but shows that, as far as structure goes, there is not much difference as one would expect between the penguins and other birds. The difference is not so much in the apparatus as in the way in which it is used.

Migration of Birds.§—A. Landsborough Thomson discusses the possibilities and actual results of bird-marking (by means of aluminium rings bearing a number and address), with a view to discovering additional facts in regard to migration. He gives an historical note on

* Comptes Rendus, clii. (1911) pp. 909-13 (2 figs.).

† Die Struktur der Geschlechtsorgane der Haussäugetiere. Berlin: (1911) xii. and 388 pp. (168 figs.).

‡ SB Ges. Nat. Freunde Berlin (1910) pp. 4-10 (6 figs.).

§ Proc. R. Phys. Soc., xviii. (1911) pp. 204-18.

the method, which is now being pursued at various centres. As an instance of results he sums up the data in regard to the movements of the white stork. These data have been mainly due to the work of Thielenmann, at Rossitten; Mortensen, of Viborg, in Denmark, and the workers at the Hungarian Ornithological Bureau have also contributed largely. The Natural History Department of Aberdeen University started in 1909 an enquiry on the lines of that at Rossitten, and observers, willing to co-operate and desirous of further information on the subject, are invited to communicate with Professor J. Arthur Thomson. A few of the interesting results are the following: a widgeon, marked in June 1909, at Loch Brora, Sutherlandshire, was taken in Groningen, Holland, on September 3, 1909; a swallow, marked at a farm near Tunbridge Wells in June 1909, was re-taken at the same farm in June 1910; a song-thrush, marked in Aberdeenshire in June 1910, was shot in Portugal in September.

Weighing Parts of Eggs.*—Maynie R. Curtis refers to the necessity of very accurate measurements in studying biometrically the size, relations, and proportion of the parts of successive eggs of the same hen. To prevent loss from evaporation the egg should be sealed, as soon as possible after it is laid, in a half-pint Lightning fruit jar containing a cushion of absorbent cotton. An accurate method of separating the parts of the egg is as follows: Break the egg near the centre and allow the albumen to run into a receiving dish. Keep the yolk in one half of the shell. Then turn it into the empty half. The yolk is then dried on filter paper. The shell is also dried on a filter. The yolk and shell are then weighed. The difference between the sum of their weights and the original weight of the unbroken egg gives the weight of albumen.

Bite of Heloderma.†—Marie Phisalix was bitten by *Heloderma suspectum*, the poisonous lizard of Arizona, and she describes all the results, such as the violent pain, the swelling, the profuse perspiration, the pallor, the vertigo, and so on. Even after a week there was fatigue, giddiness, and local pain.

Toxins and Antitoxins.‡—M. Arthus and B. Stawska have experimented with the poison of cobra, rattlesnake, and fer-de-lance (*Lachesis lanceolatus*), and the corresponding anti-venom serums, and they call attention to the instantaneous character of the neutralization. The rapidity suggests not a ferment-action, but the neutralization of an acid by a base.

Corpora Adiposa of Frog.§—P. Kennel continues his study of these bodies, which he proposes to call adipo-lymphoid, since they are lymphopoietic as well as reserves of fat. He finds that the adipose reserves are used in all conditions of malnutrition, and particularly during the hibernation. Moreover, the reserves help towards the development of the germ-cells, particularly as regards the dentoplasm of the ovum.

* Rep. Maine Agric. Exper. Stat. (1911) pp. 93-112.

† Comptes Rendus, clii. (1911) pp. 1790-2.

‡ Comptes Rendus, cliii. (1911) pp. 355-7.

§ Comptes Rendus, cliii. (1911) pp. 505-7.

Tadpoles with Strongly Developed Lips.*—C. du Bois Reymond describes tadpoles of *Megalophrys* from China, which protruded a yellowish, triangular warty membrane in front of the mouth, and hung from the surface with this expanded.

Theodor Vogt † describes a tadpole from the region of Ruwenzori with enlarged lips, with villas-like warts on the lower one. But the lips are after the type of *Rana temporaria*, and not like those of *Megalophrys*.

Luminous Organs in Fishes.‡—Hiroshi Oshima has studied these in *Etmopterus* (a Selachian), in *Maurolicus* (one of the Sternoptychidæ), and in various species of *Myctophum* (Myctophidæ).

In *Etmopterus* no numerical definiteness exists, the organs being diffusely scattered, minute, epidermal swellings partly sunk in the cutis. The photogenic body consists of a small number of conical photogenic cells arranged radially into a hemispherical or semicylindrical mass. The lens is unicellular. No unequivocal innervation has been proved; the blood-supply is carried on by a sinus underlying the organ. The light produced from the organ is tranquil and faint, probably controlled by special activity of pigment-cells.

In the Sternoptychidæ the organs are definite in number and arrangement according to species. They are complicated in structure, and there is in some cases a system of intercommunication between the internal parts of the neighbouring organs. The photogenic body is formed by numerous polyhedral gland-cells filling the interior of the organ in either regular or irregular arrangement.

The lens is multicellular, and lenticular or flat in shape. The blood capillaries form a network between the photogenic cells. The presence of nerves has been proved in a few cases. The luminescence is not momentary, but continuous. The light is not very intense. The photogenic body gives out light in air even when taken out of the organ.

The organs of the Myctophidæ are the most highly differentiated forms of luminous organs. Some species present sexual differences as regards their position on the body. The photogenic body consists of a number of small lamellar gland-cells. The lens, if present, is formed by a local thickening of the superposed scale. The photogenic body is richly supplied with nerves, and the blood-vessels form a plexus around it. The spark-like light is rather bright, and is undoubtedly controlled by nerves.

In all the different forms of organ there is an abundant blood supply, uniformity of structure in the species, glandular photogenic cells, and a secretion product stainable with plasma-stains and never set free. No spontaneous luminescence has been observed. In *Myctophum* where the photophores, especially the large antorbital organs, have a spark-like gleam when stimulated, the light may be quite useful for frightening purposes. In *Anomalops* and *Photoblepharon*, the organs may be useful for illuminating purposes, as they are placed inferiorly to the eyes and emit quite intense and continuous light. There are no other instances of this.

* SB. Ges. Nat. Freunde Berlin (1910) No. 7, pp. 285-7 (3 figs.).

† SB. Ges. Nat. Freunde Berlin (1910) No. 7, pp. 287-9 (2 figs.).

‡ Journ. Coll. Sci. Univ. Tokyo, xxvii. (1911) art. 15, pp. 1-25 (1 pl. and 4 figs.).

Ichthyological Notes.*—H. Chas. Williamson communicates notes on young stages of the angler (*Lophius piscatorius*); on eggs of halibut, conger, tusk; on post-larval *Arnoglossus*; on a rare angler (*Himantolophus reinhardtii*) landed at Aberdeen; on the occurrence of a pilchard off Aberdeen; on an angler with one eye; on three cases of hermaphroditism in the cod; on tumours from the cod, etc.; on sand-eels and a hermit-crab encysted in the abdominal cavity of haddock, cod, and saithe; and on the partial separation of the pectoral fin from the snout in *Raia circularis* and *R. clavata*.

Ambi-coloured Flatfish.†—Richard Elmhirst describes a number of ambi-coloured flatfish from the Clyde—plaice, witch (*Pleuronectes cyroglossus*), dab (*P. limanda*), flounder (*P. fesus*) and turbot.

INVERTEBRATA.

Mollusca.

Layers of the Molluscan Shell.‡—A. R. Horwood gives the following summary of the nature of the shell layer in Molluscs, omitting cases which do not conform to the usual type—e.g. *Patella*, *Fusus*, *Littorina*, *Purpura*, *Ostrea*, *Pecten*, *Chama*, *Spondylus*, and *Mytilus*.

GROUP.	LIVING.	FOSSIL.
GASTROPODA . . .	Only layer. Aragonite with chitinous substance (conchiolin), rarely sulphate of lime.	Only layer. Aragonite usually found as casts, but sometimes as aragonite, sometimes as granular calcite.
LAMELLIBRANCHIATA		1. Absent. 2. Calcite.
		3. Aragonite, usually pseudo-calcite.
CEPHALOPODA . . .	1. "Black layer." 2. Porcellanous laminar aragonite. 3. Nacreous calcite.	1. "Black layer," rare. 2. Aragonite. 3. Aragonite.

Out of 101 species examined, 24 have a shell-layer of aragonite—10 Gastropods (the inner and only layer), 10 Lamellibranchs (the inner of two layers), 4 Cephalopods (the outer of two layers).

a. Cephalopoda.

New Cephalopods from Hawaiian Islands.§—S. Stillman Berry describes *Stephanoteuthis hawaiiensis* g. et sp. n., with short saccular body, large broad head, short stout arms, very large semicircular fins placed somewhat posteriorly, and no gladius. He also describes *Polypus hoylei*

* Fishery Board for Scotland, 28th Rep. (1911) pp. 24-67 (5 pls.).

† Ann. Scot. Nat. Hist. (1911) pp. 77-9.

‡ Geol. Mag. viii. (1911) pp. 406-18.

§ Proc. U.S. Nat. Mus., xxxvii. (1910) pp. 407-19 (9 figs.).

sp. n., *Stoloteuthis iris* sp. n., with relatively enormous sub-circular fins, *Cranhia* (*Liocranchia*) *globula* sp. n., with a very rotund body, and three other new species.

γ. Gastropoda.

Mantle-cavity and Pallial Organs of Bulleidae.*—Remy Perrier and Henri Fischer have made a study of the general and minute structure of the mantle and its associated organs in various Tectibranch Gastropods—*Acteon tornatilis*, *Aplustrum amplustre*, *Scaphander lignarius*, *S. puncto-striatus*, *Acera bullata*, and *A. soluta*. They discuss also the affinities of *Aplustrum* and of *Acera*, and the adaptive characters in the latter.

Alimentary Canal of *Helix pomatia*.†—J. Spiro has studied the minute structure of the epithelium in particular. It consists of cylindrical and calyciform cells. The granulations and fat-globules found in the cylindrical cells in summer are absent in winter. During hibernation the nuclei of the cylindrical cells become poorer in chromatin. All the cylindrical cells bear cilia, but these are lost during hibernation. The calyciform cells secrete an inactive mucus during digestion; it ceases when hibernation sets in. The calyciform cells and the rest of the epithelial lining degenerate in spring, and are re-formed from newly regenerated cylindrical cells.

Damage to Plaice-fishing by Whelks.‡—C. G. Joh. Petersen discusses the damage done to the plaice fishing in the Limfjord by the large numbers of *Buccinum undatum* and *Nassa reticulata*, which devour the plaice when these are caught in the gill nets and sunk to the bottom. It does not seem possible to suggest any remedy that would pay, but it might be well to try more frequent lifting of the nets.

Arthropoda.

a. Insecta.

Studies on Injurious Insects.—Antonio Berlese gives an account of the measures taken to cope with the olive-fly.

Minute Structure of Cuticle in Insects.¶—Serge Kapzov has studied this in larvæ of *Dytiscus* and other beetles, in silkworms and mealworms, in may-fly larvæ, and so on. However complex the cuticle may be, it consists of a coherent meshwork of looser and denser portions. The structure of this meshwork is partly determined by pressures and strains operative during the formation of the cuticle, and partly by variability in the secretory activity of the epidermic cells, which again may be perhaps affected by mechanical conditions. The diverse disposition of the framework is correlated with the varied direction of strains and pressures. Chitin is never a plasmic differentiation; it is rather to be compared to coagulating substances and to cellulose.

* Ann. Sci. Nat. (Zool.) xiv. (1911) pp. 1-189 (9 pls. and 26 figs.).

† Rev. Suisse Zool., xix. (1911) pp. 275-302 (1 pl.).

‡ Rep. Danish Biol. Stat., xix. (1911) pp. 1-20 (9 figs.).

§ Redia, vii. (1911) pp. 111-55.

¶ Zeitschr. wiss. Zool., xcvi. (1911) pp. 297-337 (3 pls. and 3 figs.).

Moulting in Silkworms.*—E. Verson returns to a study of the exuvial glands of the silkworm, which he described in 1889, and adds in detail to his previous account. He devotes much attention to the nucleus which seems to play a chief part in the secretory process. Very remarkable and interesting is what Verson calls the "flow" and "ebb" of the glands (especially in the posterior segments) before and after each moult.

New Stag-beetles.†—Arthur M. Lea discusses the genus *Lissoles*, stag-beetles almost confined to Tasmania, and describes a number of new species. His collection included an hermaphrodite, *L. punctatus*, having the left side male and the right female, and a specimen of *L. curvicornis* with seven legs, the extra one jutting out from the left front coxa.

Alimentary Canal of Dytiscus.‡—H. Rungius has made an elaborate study of the alimentary tract both in the larval and adult water-beetle. He describes the macroscopic features of the various parts, the minute structure of the wall, e.g. the intima, epithelium, basal membrane, and muscularis of the fore-gut, the epithelium, crypts, supporting lamella, and muscularis of the mid-gut, and so on.

Large Egg Laid by a Beetle.§—F. H. Gravely reports that a Buprestid beetle, *Sternocera dasypyleura* Koll., laid an egg 8.5 mm. long by 5.5 mm. broad, the beetle itself being 43 mm. by 16.5 mm. The superficial covering of this large egg was somewhat leathery and whitish.

Fluorescence in Luminous Insects.||—R. DuBois points out that he discovered animal fluorescence in 1909, having demonstrated it not only in Lampyrids and luminous Elaterids, but in some animals which are not luminescent. In luminous insects the fluorescence is accessory and an embellishment. The author refers to recent reports on animal fluorescence by McDermott ¶ and by Ives and Coblentz.**

Gametogenesis of Gall-fly.††—L. Doncaster continues his study of the gametogenesis of *Neuroterus lenticularis*. There are two kinds of parthenogenetic females in the spring generation, which lay eggs differing in their behaviour as regards maturation. In the eggs laid by the one class there is no maturation division, and the early segmentation divisions show the diploid number (20) of chromosomes. No polar chromosomes are ever found. In the eggs laid by the second class of female, the nucleus divides at the surface of the egg, forming an irregular outer group of chromosomes (first polar nucleus) and an inner group of parallel rod-like chromosomes. The latter divide immediately, apparently transversely, into an inner group which forms the egg-nucleus, and an outer or second polar group. The first polar group may divide

* Zeitschr. wiss. Zool., xcvi. (1911) pp. 457-80 (2 pls.).

† Proc. R. Soc. Tasmania (1910) pp. 346-66 (2 pls.).

‡ Zeitschr. wiss. Zool., xcvi. (1911) pp. 179-287 (74 figs.).

§ Records Indian Mus., vi. (1911) pp. 45-6.

|| Comptes Rendus, clxiii. (1911) pp. 208-10.

¶ Journ. Amer. Chem. Soc., xxxiii. (March, 1911).

** Bull. Bureau of Standards, Washington, vi. (1910) pp. 321-36.

†† Proc. Roy. Soc., Series B, lxxxiii. pp. 476-89 (1 pl.).

into two. In the early segmentation mitoses, the haploid number (10) of chromosomes is found.

Since it is known that some parthenogenetic individuals lay eggs which all develop into females, and others lay only male-producing eggs, and since the female shows the diploid chromosome number in all its cells, while the male has the haploid number in the spermatogonia and nerve-cells, it is suggested that the eggs which undergo no maturation-division become female, those which undergo reduction males.

Tabanids and Trypanosomes.*—Sir David Bruce and Captains A. E. Hamerton and H. R. Bateman find that *Tabanus secedens*, *T. thoracicus*, and *T. fuscomarginatus* do not seem to be able to transmit *Trypanosoma pecorum* from infected to healthy cattle by the mechanical method of transmission. Owing to the short life of these Tabanids in captivity it is impossible from the experiments made to state whether they can convey the disease after a period of development of the Trypanosomes in the fly. The investigators believe that the three types of Flagellates found in *Tabanus secedens* and *T. thoracicus* are various stages in the development of a harmless Crithidium in these flies.

Revision of Oriental Species of Tabanus.†—Gertrude Ricardo has done a useful piece of work in revising the species of *Tabanus* from the Oriental Region. The 119 described species are reduced to 73, but the addition of 40 new species raises the total again to 117.

Influence of Weather Conditions on Frequency of Warbles.‡ N. Lehmann and C. Vaney have made careful computations of the frequency of warbles in different seasons. Their general result is that in the region of Lyons, warm weather during July and August favours the oviposition of *Hypoderma bovis*, and is followed by a high percentage of warbled hides the following year.

Respiration and Circulation in Tipula maxima.§—J. M. Brown describes the respiratory and circulatory systems in this larva, a form of "leather jacket," which occurs beneath stones, either close to or in the bed of streams. There is an extensive system of fine air-tubes taking origin from the stigmatic chambers and radiating to the body-wall. Amongst these tubules the blood circulates. This may be an adaptation for bringing the blood into relation with the air near the spiracles themselves. There are "blood-gills" for respiration when submerged.

The author gives a careful description of the "heart," or dorsal vessel, the intersegmental and ostial valves, the pericardial cells, which seem to be in great part excretory, the pulsations, which occupy about 2.5 seconds each (about 24 per minute, the resting phase occupying about half the whole period), and the action of the ostial valves.

* Proc. Roy. Soc., Series B, lxxxiii. (1911) pp. 349-58 (1 pl.).

† Records Indian Museum, iv. (1911) pp. 111-258 (2 pls.).

‡ Comptes Rendus, clii. (1911) pp. 1508-10.

§ Trans. Linn. Soc. (Zool.) xi. (1910) pp. 125-35 (3 pls.).

Mosquito sucked by Midge.*—F. H. Gravely reports finding in the Sunderbunds a small Chironomid (*Culicoides*), with its proboscis embedded in the abdomen of a mosquito (*Myzomyia rossii*). Probably the *Culicoides* sucks mammalian blood and was taking it second-hand from the mosquito.

Experiments with Dragon-fly Larvæ.†—R. J. Tillyard concludes from experiments on a Libellulid larva (undetermined) that the larvæ may live more than a year, and under adverse circumstances over two years; that they can resist starvation for eight months, and considerable drought for nine weeks. He also worked with larvæ of *Synthemis eustacta* Burm., which lived in three inches of dry sand for ten weeks.

Histological Study of the Innervation of the Heart of Larval Dragon-fly.‡—A. Zawarzin points out that, in spite of all the thousands of entomological researches, we do not know much in regard to the minute structure of the nervous system. Modern neurological methods have been but little applied. He has made a thorough study of the nerves of the heart of *Æschna*-larvæ. There are no nerve-cells on the heart or near it; the innervation is due to peripheral nerve-fibres and their terminations. The nerves spring from paired (cardiac) ganglia of the visceral system and from the ganglia of the ventral chain. The nerves from the latter are probably motor; they enter segmentally into the cardiac nerve which comes from cardiac ganglia. Some endings, probably motor, are disposed on the wall of the heart, in the valves, on the septum, and on the alary muscles. Their terminal threads have a characteristic necklace-like varicosity and no anastomosis. Other nerve-endings form a plexus at the ostia.

Buccal Apparatus of Hemiptera.§—E. Bugnion and N. Popoff give an account of the mouth-parts in *Graphosoma*, *Pyrrhocoris*, *Raphigaster*, and other Hemiptera. They discuss the rostrum, the labrum, the stylets, the supporting tentorium, the pharynx, the taste-organs, the salivary pump, the labial and maxillary glands, and the general structure of the head.

Study of a Thrips.||—Pietro Buffa has made a study of *Heliethrips hæmorrhoidalis*, especially in its parthenogenetic phase. All the forms are parasitic and of similar habitat; there is no larval moult; there is a close structural similarity between larvæ and adults, e.g. in mouth-parts; there is a pro-nymph stage and a free nymph stage like the adult, neither feeding; there is a simple form of parthenogenesis.

Study of Phryganea grandis.¶—C. Wesenberg-Lund has made a study of the life of this caddis-fly. The female often goes down about $\frac{3}{4}$ m. below the surface to deposit her eggs. Till about September 1 the larvæ live on the bottom, principally feeding on *Chara*, and making

* Records Indian Museum, vi. (1911) p. 45.

† Proc. Linn. Soc. N.S. Wales, xxxv. (1910) pp. 666-76.

‡ Zeitschr. wiss. Zool., xevii. (1911) pp. 481-510 (2 pls. and 9 figs.).

§ Arch. Zool. Expér., vii. (1911) pp. 643-74 (2 pls. and 8 figs.).

|| Redia, vii. (1911) pp. 70-109 (3 pls.).

¶ Internat. Rev. Hydrobiol., iv. (1911) pp. 65-90 (2 pls.).

their cases of *Chara* material. In summer they ascend to the *Potamogeton* region and creep about among these, making their cases of small pieces of the leaves. In January they return to the bottom, now using bits of leaves that fall from surrounding trees.

The material used in case-making is always arranged as a spiral band. The band of the young larva slowly increases in width; when older, after the last moult, the width remains nearly constant, about 8–10 mm. In building its house the young larva weaves only small fragments of each of the 2–40 mm. long pieces on the case; later on, when all are of the same length, the whole of each piece is fastened on to the case. The case itself consists of a silken tube, upon which the above-mentioned pieces are fixed. When a fresh piece has to be inserted on the tube, the animal spins a membrane across the angles between the last inserted piece and the former spiral, upon which the new piece is placed. It is then spun together with the preceding one. The contrast of the conical tube of the young larva and the cylindrical tube of the full-grown larva is discussed in detail.

It seems that the larva makes use of a fixed measure, partly, while the larva is still young, for determining the length of the pieces that have to be inserted on the tube, and partly, in the older stages, for measuring the length of the piece that has to be cut off from the growing plant. The bending-angle of the head probably constitutes this measure, the width of the angle being limited by a peculiar process or horn, projecting from the under-side of the prothorax—an organ the significance of which has not hitherto been ascertained. It is probably a unit among insects.

Before pupation the larva fastens itself to the roots of a *Carex* or creeps into holes in logs lying at the foot of the pond. It rests as pupa from May 15 till June 1. The imago is common on the reeds and rushes in June.

As to the advantage of the cases described, which are not met with outside the family Phryganidae and the unrelated genus *Triænodes*, the small pieces of leaf arranged in a spiral band encircling the whole case from one end to the other, give the otherwise frail structure the necessary solidity and rigidity. Furthermore, as the material always consists of air-filled pieces of plant, the weight is but slightly increased. And again, owing to their thin and smooth casements, the tubes offer only a slight resistance to the movements of the animals in the water.

Of all Trichoptera with cruciform larvæ, the Phryganidae are the most carnivorous, and at the same time possess greater powers of locomotion than the other larvæ, which are mainly plant-eaters. The larvæ of species of *Triænodes* are the only Trichopterous larvæ whose tubes are enclosed in material not made by the animal itself, and that, nevertheless, are able to move about and even swim. It thus appears that the spiral construction of the tubes is met with in those Trichopterous larvæ which most require light and movable cases.

Studies on Mallophaga and Anoplura.*—Eric Mjöberg is to be congratulated on this fine piece of work on a difficult subject. In the systematic portion he describes numerous new forms. He then gives

* Arkiv Zool., vi. (1910) pp. 1–297 (5 pls. and 156 figs.).

an anatomical account of the various systems of the body. The eggs are also described. They are very closely alike in the two groups—e.g. in showing the same sort of peculiar "ovum-stigma," which is restricted to Mallophaga and Anoplura. Then follow lists of hosts and the associated species.

β. Myriopoda.

Studies on Millipedes.*—Karl W. Verhoeff discusses in particular the family Craspedosomidae and its German representatives. He contrasts the genera *Craspedosoma* and *Macheiriophoron*, establishes a new genus, *Tatrasoma*, based on *Atractosoma carpathicum* Latzel, defines the subgenera of *Craspedosoma* and *Pyrgocyphosoma*, and describes a number of larval forms.

Habits of *Scutigera coleoptrata*.†—J. Künckel d'Herculeis has some interesting notes on this long-legged centipede, which frequents houses. It hides in crevices during the day; it pursues flies (especially *Fannia scalaris*) at night. It throws itself on the fly, enswathing it with its long limbs; it injects poison from its forceps; it chews the dead body, ingesting only the soft parts; it may kill three or four at once without stopping to eat. As a fly-catcher it does good service.

γ. Onychophora.

New Species of *Peripatus* from Grenada.‡—Charles T. Brues describes *Peripatus barbouri* sp. n., which he and G. M. Allen found close to the Grand Etang Lake in the Island of Grenada. It belongs to the section of *P. edwardsi*. The body is entirely without dorsal colour markings. There are 30–31, usually 31, pairs of legs in the female. Its closest affinities are with *P. trinidatensis* from Trinidad, which lies about ninety miles to the south-west of Grenada. It has also close affinities with *P. inthurni*, *P. sedgwicki* and certain forms of *P. dominicæ*. The author also discusses *P. juliformis* Guild, var. *swainsonæ* Cockerell; *P. jamaicensis* Grabham and Cockerell, and an unidentifiable specimen from British Honduras.

δ. Arachnida.

Cavernicolous Gamasids.§—A. Bonnet describes four new species of *Gamasus* and one of *Pergamasus* collected from caves and the like by M. Viré.

Studies on Injurious Mites.||—Giacomo del Guercio has made a zoological and practical study of the Eriophyidae which attack buds, e.g. *Eriophyes corylijallorum* and *E. pyri*.

Monograph on Tarsonemidæ.¶—Guido Paoli deals with the family Diplopodidae, which have "a more or less subdiscoidal body, and the cephalothorax protected by a more or less expanded clypeus which sometimes covers the rostrum and the first and second pairs of limbs."

* SB. Ges. Nat. Freunde Berlin (1910) pp. 19–62 (2 pls.).

† Comptes Rendus, cliii. (1911) pp. 399–401.

‡ Bull. Mus. Comp. Zool., liv. (1911) pp. 305–18 (2 pls. and 4 figs.).

§ Arch. Zool. Expér., viii. (1911) pp. 381–98 (3 pls.).

|| Redia, vii. (1911) pp. 1–64 (7 figs.).

¶ Redia, vii. (1911) pp. 215–81 (5 pls.).

6. Crustacea.

Sperm Transfer in Certain Decapods.*—E. A. Andrews points out that the sperm-masses may be applied to the surface of the shell (as in *Astacus*), or directly introduced into the oviducts, or placed in a special receptacle, like the pit in *Cambarus*. A peculiar receptacle known as the "thelycum," is found in certain prawns, the Peneidæ, as also in Anaspidacea. The paper describes the "thelycum" of Peneidæ, in *Peneus* and *Parapeneus*, where it is a cavity enclosed more or less by outgrowths from the shell, and is found full of spermatozoa. In the deep-sea prawns of the group Eryonidea, Geoffrey Smith has described a similar receptacle, but the author shows that this interpretation is very doubtful. In the species of *Polycheles* which he has studied he finds no spermatheca.

Development of *Maia squinado*.†—C. Schlegel has succeeded in rearing the eggs and larvæ of this crab. Its life-history is much condensed, when compared with that of *Carcinus mænas*, for instance. From the egg there is hatched a minute Protozoæa—a transitional phase which contains the first zoæa. After three-quarters of an hour, the first zoæa is liberated. During the night of the 4th to 5th day the first moult occurs and the second zoæa. Both these zoææ live at the surface and show an intense positive phototropism. During the night of the 8th to 9th day, the megalopa-stage is reached, which lasts for about a week. It leaves the surface and goes deeper and deeper. The subsequent post-larval form has all the adult characters, and is negatively phototropic.

***Palæmon niloticus* in Lake Tchad.**‡—Sollaud and Tilho report that Gaillard has discovered colonies of *Palæmon niloticus* Roux, in Lake Tchad. They discuss the explanation of this interesting fact, and suggest that the Tchad basin formerly extended (probably in Quaternary times), to the south of the Libyan desert, to the Bahr-el-Ghazal, and thus into communication with the Nile. There is considerable resemblance also in the fishes and fresh-water molluscs of the Tchad and the Nile.

Crustacea of Kermadec Islands.§—Charles Chilton reports on a collection (83 species) from these islands, which lie about half-way between New Zealand and the Tonga Islands. Most of the specimens belong to species already known, nearly all the marine and littoral species being Australian or Indo-Pacific forms. Of especial interest is the occurrence of the large Amphipod *Eurythenes gryllus*, whose distribution has attracted much attention. The author also comments on the occurrence and habits of *Actæomorpha erosa*, *Cryptochirus coralliodytes*, and *Porcellanopagurus tridentatus*.

Crayfish Plague.||—L. Mercier and R. de Drouin de Bouville corroborate the conclusion that the crayfish plague in the lake of Nantua is due to Hofer's *Bacillus pestis astaci*, which also causes "lepidorthosis" in fresh-water fishes.

* Proc. U.S. Nat. Mus., xxxix. (1911) pp. 419-34 (15 figs.).

† Comptes Rendus, cliii. (1911) pp. 480-2.

‡ Comptes Rendus, clii. (1911) pp. 1868-71.

§ Trans. New Zealand Inst., xliii. (1910) pp. 544-73 (4 figs.).

|| Comptes Rendus, cliii. (1911) pp. 210-11.

Dispersal of Marine Crustacea by Ships.*—Charles Chilton obtained from a partially split plank of the British Antarctic ship 'Terra Nova' when she arrived at Lyttelton in October 1910, four specimens of a large Sphaeromid, *Cymodoce tuberculata* Haswell, both male and female, and two of them alive. "This species is quite unknown in New Zealand waters, but is an Australian one, and there seems little doubt that it had attached itself to the ship all the way to New Zealand, i.e. about twelve hundred miles." Some similar instances are recorded. Thus T. F. Cheeseman reported a King-crab (*Carcinoscorpius rotundicauda* (Latr.), from Auckland, and Ray Lankester has called attention to a record of another (*Limulus polyphemus*), found in the harbour of Copenhagen, clinging to a ship from North America.

Studies on New Zealand Crustaceans.†—Charles Chilton submits a revision of the four species of New Zealand Squillidæ—*Squilla armata* Milne-Edwards, *S. affinis* Berthold, *Lysiosquilla spinosa* (Wood-Mason) and *L. brazieri* Miers.

The author also reports ‡ on the Crustacea collected by the New Zealand Government Trawling Expedition (1907). The collection includes 28 Decapods, 2 Stomatopods, 4 Amphipods, 5 Isopods, 2 Cirripeds, and 2 parasitic Copepods. Though there are no new species, the collection is interesting in containing a number of species not reported since the 'Challenger' Expedition. There are some interesting cases of commensalism, or epizoic association, e.g. *Paramithrax longipes* with specimens of *Balanus decorus* on its back, which are in some cases so large and numerous that they exceed in size the body of the crab itself, and *Eupagurus stewarti*, which has a straight abdomen, and inhabits tubes formed by a Millepore or a massive calcareous Polyzoan, which is very much larger than the crab.

Primitive Fresh-water Prawn.§—E. Sollaud refers *Palæmonetes trispinosus* Anurivillius, a fresh-water prawn apparently widespread in Equatorial Africa, to a new genus *Desmocarais*, on account of its numerous ancestral characters. It is much more primitive than any of the other Palæmonids; it links the Palæmonids to the lower Eucyphota of the Hoplophorid group.

Genus Leptocheirus.||—E. W. Sexton has revised the species of this Amphipod genus, and has re-examined Zaddack's type species *L. pilosus*, of which *L. cornuareui* Sowinski and *L. subsalsus* Norman are synonyms, the former being the full-grown male and the other the full-grown female. The other six species are: *L. pinguis* Stimpson; *L. hirsutimanus* Bate = *Bæckia typica* Malm.; *L. guttatus* Grube = *Ptilocheirus tricristatus* Chevreux; *L. pectinatus* Norman = *Protomedeia fasciata* Costa and *L. dellavallei*; *L. aberrans* Ohlin; and *L. bispinosus* Norman = *Protomedeia hirsutimanus* Heller, and *L. guttatus* Della Valle. The paper is a good type of careful revision.

* Trans. New Zealand Inst., xliii. (1910) pp. 131-3.

† Trans. New Zealand Inst., xliii. (1910) pp. 134-9 (4 figs.).

‡ Records Canterbury Museum, i. (1911) pp. 285-312 (1 pl. and 1 fig.).

§ Comptes Rendus, clii. (1911) pp. 913-16.

|| Proc. Zool. Soc., 1911, pp. 561-94 (3 pls. and 1 fig.).

New Parasitic Isopod.*—Harriet Richardson describes *Scyrracepon hawaiiensis* sp. n., one of those extraordinary Isopods, modified in relation to parasitism, and exhibiting striking sex-dimorphism. A male and a female were found in the branchial cavity of *Pilumnoplax cooki* in *Globigerina* ooze in the Hawaiian region. Only one species of the genus has been previously described, the type, *Scyrracepon tuberculosa* Tattersall, parasitic on *Scyrramathia carpenteri* Norman, found off County Kerry, Ireland.

Spiny Terrestrial Isopod.†—Harriet Richardson describes *Globalmadillo armatus* g. et sp. n., from Guatemala. Its body is covered with long spines, and both in its armature and general appearance it resembles *Acanthoniscus spiniger*, described by Kinahan from Jamaica. Notwithstanding the striking superficial resemblance of the two forms, they cannot be referred to the same genus.

Development and Minute Structure of Scalpellum and Ibla.‡—F. H. Stewart gives an account of the post-larval development of the hermaphrodite and of the male of *Scalpellum squamuliferum*. He has notes on the structure of the male, the minute structure of the peduncle in the hermaphrodite and male. He found no trace of the rudimentary ovaries described by Gravel in the male of *S. peronii*. Nor did he find any trace of rudimentary testes in the female of *Ibla cummingsii*. He also describes the structure of the male of *S. bengalense* Annandale, the post-larval development of the male of *S. gravelii* Annandale, the structure of the male of *Ibla cummingsii* Darwin, and the sensory hairs in various species.

Rhizocephalous Crustacean from Fresh-water.§—Nelson Annandale describes *Sesarmareos monticola* g. et sp. n., a Rhizocephalous Crustacean from a crab, *Sesarma thalrinoc*, in a jungle stream 700 feet above sea-level, in the Andamans. It is somewhat like *Sacculina*, slug-like or sausage-shaped, and occurred between the ventral surface of the carapace and the retroverted abdomen. It is attached by a chitinous ring apparently without roots; there are two slit-like orifices in the mantle, surrounded and separated by a stout muscle; the visceral mass is apparently attached to the mantle by a mesentery that surrounds the ring of attachment, being surrounded at all other points by a capacious brood-pouch, which contains larvæ of the Cyprid type. The mantle is thin and smooth, but is well provided with slender circular muscle-fibres. The two ovaries are distinct; a testes has not been detected. This is the first fresh-water Rhizocephalon.

New Parasitic Copepods.||—C. B. Wilson describes and establishes two new genera—*Midius* (intermediate between *Caligus* and *Euryphorus*), and *Paralebion*, in the family Euryphoridae, closely allied to *Alebion*. He describes *Achtheinus dentatus* sp. n. and *Leruepoda inermis* sp. n.

* Proc. U.S. Nat. Mus., xxxviii. (1911) pp. 645-7 (6 figs.).

† Proc. U.S. Nat. Mus., xxxvii. (1910) pp. 494-7 (1 fig.).

‡ Mem. Indian Mus., iii. (1911) pp. 33-51 (4 pls.).

§ Records Indian Museum, vi. (1911) pp. 1-4 (2 figs.).

|| Proc. U.S. Nat. Mus., xxxix. (1911) pp. 625-34 (4 pls.).

North American Ergasilidæ.*—C. B. Wilson gives an account of the structure of *Ergasilus*, *Bomolochus*, *Tæniacanthus*, and other members of this family of parasitic Copepods. He makes a very important contribution to the morphology and embryology of the family, and establishes three new genera. As regards systematic position, the author suggests that the Lichomolgidæ must be kept separate from the Ergasilidæ; that the Ergasilidæ are closely related to the Corycæidæ and Lichomolgidæ on the one side, and to the Chondracanthidæ on the other, the four families forming a series; that the Ergasilinæ, Bomolochinæ, and Tæniacanthinæ form a natural series of sub-families.

Development of Achtheres.†—C. B. Wilson gives a detailed account of the development of *Achtheres ambloplitis* Kellicott, the American representative of the European *A. percarum*. The American species is very common on the gill-arches of the rock-bass or red-eye, *Ambloplitis rupestris*. It is taken as a type of the Lernæopodidæ.

Long filaments of ovarian cells loosen themselves from the epithelium of the ovary, and pass down into the uterine processes of the oviduct, where the terminal cells of each filament develop into oocytes one after another. The yolk-globules of the egg are evenly distributed through a cytoplasmic matrix. The eggs are fertilized at the mouth of the sperm receptacle as they pass out of the oviduct. There is a migration of nuclei and cytoplasm to the periphery to form blastoderm cells, and these also segment at the surface. The portion of the blastoderm which is to form the ventral surface of the embryo thickens and shows a series of lobes, the future appendages.

The author describes the nauplius and metanauplius stages which are passed inside the egg, the larva hatching in the first copepodid stage. It is interesting to notice that the nauplius eye is so rudimentary that it is seen only in serial sections. It has neither pigment nor lens. But the most interesting nauplius structure is the attachment filament, begun in the nauplius and completed in the metanauplius stage. It is secreted by a large frontal gland which occupies the whole of the anterior dorsal portion of the cephalon. It is a long, coiled, hollow filament; the distal end is like a mushroom and attached to the host; the proximal end is peg-shaped and attached to the gland. The larva emerges in the first copepodid stage (24 to 48 hours) and fastens itself to its host. The filament is transferred from the frontal margin to the claws at the tips of the second maxillæ. In the male the claws are withdrawn from attachment to the filament at the time of sexual union, after which the male clings to the female. Sex-distinction appears in the second copepodid stage, which shows all the adult organs.

The author has made a fine study of this markedly concentrated development. The nauplius and metanauplius stages are within the egg and fused; the only free-swimming stage lasts 24 to 48 hours, just long enough to find a host; the second copepodid stage moults directly into the adult form.

* Proc. U.S. Nat. Mus., xxxix. (1911) pp. 263-400 (20 pls. and 41 figs.).

† Proc. U.S. Nat. Mus., xxxix. (1911) pp. 189-226 (8 pls.).

Diurnal Migrations of *Calanus finmarchicus*.*—C. O. Esterly finds that this Copepod is most abundant at the surface about 7 or 8 p.m. during June and July. It has begun to leave the surface at midnight, and is then most abundant at a depth of 5 or 10 fathoms. During the day (6 a.m.—6 p.m.) it is most abundant at about 200 fathoms. Towards evening there is an upward movement of a large part of the population.

The cause of the migration is probably the effect of light upon the organism, though it does not seem that a definite movement towards a dim light or away from a stronger one can be at the basis of this behaviour. The effect of light upon the geotropism of the animals is probably the main factor involved.

Ostracods from Madeira.†—G. Stewardson Brady describes a number of new species of *Bairdia*, *Cythere*, *Cythereis*, *Cytherura*, *Paradoxostoma*, etc., from Madeira. The collection is also interesting as extending the known range of several species from the European and North Atlantic areas much further southward, though not quite into the tropical zone.

Sex-determination in Daphnids.‡—R. Woltereck has experimented with *Hyalodaphnia*, and has reached the following conclusions. External conditions (temperature, food, chemical reagents), may sometimes exert a distinct influence on the sex of the developed ovarian ova ('induction') as well as on the ova to be subsequently formed (pre-induction). Such influences act on an internal nexus of causes, and it is noteworthy that they sometimes have no effect at all. Susceptible and non-susceptible periods may alternate. Thus there may be pure parthenogenesis, susceptibility or lability, well defined bisexuality, susceptibility or lability, pure parthenogenesis, and so on.

The internal causes do not depend simply on the degree in which the ova are equipped with plasma-substances or with heterochromosomes (assimilation-chromatin). Nor does it appear that the "Kern-plasma relation," resulting from continuous parthenogenesis or from external conditions, effects the determination of sex.

The author's experiments lead him to the view that there are in each ovum competing sex-substances, one of which becomes active as the egg matures, while the other remains latent. The latency is due to something preventing the substance from becoming active. This inhibition may occur at two different periods. It may occur shortly before the ovum leaves the ovary. The definitive determination of sex then takes place ("induction of sex by hindrance of activation"). Secondly, it may take place much earlier (*a*) in the undifferentiated germ-layer of the ovary; (*b*) in the gonad-primordium of the winter-egg (embryo); (*c*) in the ripening female egg. During these periods a change seems to take place or to begin to take place in the sex-substances, which may be called their "maturation." This change tends to bring about in the sex-substances the faculty of afterwards being activated. If this process during one of the critical periods is hindered in its realization in one of

* Internat. Rev. Hydrobiol., iv. (1911) pp. 140-51.

† Proc. Zool. Soc. (1911) pp. 595-601 (3 pls.).

‡ Internat. Rev. Hydrobiol., iv. (1911) pp. 91-128 (6 figs.).

the sex-substances, then the later determination of the other sex is prepared for ("pre-induction by 'hindrance of maturation'").

Induction and pre-induction of sex can be brought about by external influences, but only if the internal conditions of maturation and activation are approximately the same for the two sex-substances. These conditions, however, are subject to autonomous fluctuations. The male and female substances may vary periodically in being equivalent, prevalent, or recessive as regards one another. If we adopt the author's suggestion of applying the ideas of the ferment and antigen theory to these substances and processes, we can suppose that the alternating appearance and suppression of inhibiting substances ("paralysators"), or of activating substances ("activators"), are the real causes of the periodicity of sex-determination. The sex-substances themselves may be considered as somewhat like pro-ferments (if latent), and ferments (if activated).

Annulata.

Structure of Tomopteris.*—Jakob Nänni gives an histological account of the nervous system, the food canal, the vascular system, the musculature, and the eyes of various species of this interesting genus.

Incubation in Polychæts.†—Ch. Gravier describes from the collection of the second French Antarctic Expedition two interesting forms of incubatory Polychæts. The first is *Parautolytus fasciatus*, which secretes a veil on the dorsal surface, forming a pouch for the eggs and larvae. The second is a new species of *Eteone*, which occurred rolled round its spawn. The relatively large ova form a compact block fixed to the sides and ventral surface of the Annelid, and enveloped by a brown membrane.

Irish Maldanidæ.‡—Ivar Arwidsson describes from the Irish coasts, *Nicomache maculata* sp. n., and establishes a new genus, *Cæsicirrus*, for *C. neglectus* nom. n. (= *Ariothea catenata* (Malmgren) Cunningham and Ramage). The most distinctive characters of the genus are the appearance of the eighth setigerous segment, the division of the anal cirri into long undivided ones and short ones lobate at the point, and the prolonged anal papilla. The nephridial pore is somewhat under the rows of uncini, and in a line with or slightly in front of these. The neck of the developed uncini is a little striated in an oblique fashion.

Littoral Oligochæta of the Clyde.§—J. Stephenson makes a contribution to our knowledge of the littoral Oligochæta. He collected in the vicinity of Millport Marine Biological Station and at Wemyss Bay. Ten species are dealt with, all Enchytræids except *Tubifex costatus*. Two new species of *Lumbricillus* and two of *Enchytræus* are described. The author points out that these two genera are closely allied, and that a number of intermediate forms exist which serve to bridge over the interval between them.

* Jen. Zeitschr. Natur., xlvii. (1911) pp. 343-66 (2 pls. and 2 figs.).

† Comptes Rendus, clii. (1911) pp. 1418-20.

‡ Proc. R. Irish Acad., xxix. (1911) Section B, No. 6, pp. 209-28 (3 pls.).

§ Trans. R. Soc. Edinburgh, xlviii. (1911) pp. 31-65 (2 pls.).

Nematohelminthes.

New Nematode.*—J. Noordhoek Hegt describes *Chlamydonema felineum* g. et sp. n. from the stomach of cats in Batavia. It appears to occupy a somewhat isolated position, as H. F. Nierstrasz † indicates. The outer layers of the cuticular form in the posterior half of the body a sort of mantle within which the female can retract itself. In the male this "mantle" ends at the base of a broad caudal portion with four paired ridges, seventeen sensory papillæ, and numerous cuticular prominences. The head has three unstalked sensory papillæ and two lips, each with three teeth. The posterior end in the female is pointed. In the male there are two unequal spines and three large pear-shaped glandular organs opening into the cloaca. The lateral areas are strongly folded. The pharynx has a bulb. The colour is whitish-red. The animal is cœlomyarian and polymyarian.

Structure of *Filaria bancrofti*.‡—S. Hida has made a fresh study of this Nematode. The adult female is 80–100 mm. long, by 1·8–2·5 mm. broad, and is whitish in colour. In both sexes the head-end is thickened in a club-like manner, and the oral aperture is terminal. The genital aperture is funnel-shaped; between it and the uterine sac there is a spiral canal with three coils. In the uterine sac there are embryos towards the efferent portion, and ova at the other end. The sac is simple to begin with, but it becomes divided into two by a partition. The anus is lateral near the end of the tail.

The male is 30–45 mm. in length, and thinner than the female. Its genital canal is a simple sac, containing spermatozoa and other cellular elements. It opens with the gut into a cloaca just above the end of the tail. From the cloaca two spicules are protruded, which serve to grip the female in the sexual union.

Compression Experiments with the Fertilized Ovum of *Ascaris megalocephala*.§—S. S. Girgolafl finds that the abnormal arrangement of blastomeres produced by compression may induce abnormalities in the embryo. This must result when the developing egg cannot re-arrange the cells after the compression is removed. The arrangement of the blastomeres in one plane results in a thickening of this or that portion of the embryo. There is an observable struggle between the regulative tendency and the direct influence of the pressure. The results of the compression vary considerably according to its degree; it may prevent the egg from dividing at all. It inhibits the development and lowers vitality. The author gives an account of the various results which he has observed, and notes that the division under compression and the division under centrifuging influence have some features in common.

Role of Plastochondria in Fertilization of *Ascaris megalocephala*.||—Fr. Meves finds that formed elements—plastosomes or plastochondria—pass from the spermatozoon into the ovum, where they meet

* Tijdschrift Nederland. Dierk. Ver., xii. (1910) pp. 5–44 (1 pl.).

† Tijdschrift Nederland. Dierk. Ver., xii. (1910) pp. 45–59.

‡ Centralbl. Bakt. Parasitenk., 1te Abt., lx. (1911) pp. 133–41 (9 figs.).

§ Arch. Mikr. Anat., lxxvi. (1911) pp. 770–96 (30 figs.).

|| Arch. Mikr. Anat., lxxvi. (1911) pp. 683–713 (3 pls.).

with elements like themselves. These plastosomes, of which the author gives a detailed account, represent an elementary structure in the cytoplasm, and may be regarded as the primordia of ontogenetic differentiations. In his remarkable paper, Meves suggests that the plastosomes form the hereditary substance of the protoplasm, just as the chromosomes form the hereditary substance of the nucleus.

Nematodes in Deer.*—E. Brumpt has examined some of the deer from the forest of Chantilly, which have been subject for four or five years past to a mysterious malady, fatal to large numbers. He has found very abundant occurrence of Nematode parasites—*Dictyocaulus viverrini*, *D. filaria*, *Esophagostomum venulosum*, *Nematodirus roscidus*, *Trichocephalus affinis*, and a new species of *Capillaria*. It seems, indeed, that the decimating malady is in great part a pulmonary "strongylosis."

Platyhelminthes.

Entozoa in Australian Birds.†—T. Harvey Johnston has brought together under their hosts, ninety-eight in all, a list of the endoparasites recorded, including Protozoa, Trematoda, Cestoda, Nematoda, and Acanthocephala.

Tapeworms of Birds.‡—Paul Solowiow deals with *Monopylidium infundibulum* Bloch from a fowl which he fed largely on house-flies (*Musca domestica*). This corroborates Grasse's view that the fly is the intermediate host of the tapeworm. From *Fuligula cristata* the author describes *Hymenolepis villosides* sp. n. and *H. megarostellis* sp. n., another (unnamed) species of the same genus, and fourthly *Aploparaksis fuligulosa* sp. n. From *Podiceps nigricollis* the author describes *Schistocephalus dimorphus* Creplin.

Gid Parasite.§—C. M. Hall discusses the gid parasite, which is usually called *Cœnurus cerebralis*. It seems that it should be called *Multiceps*. The larval form occurs not only in the sheep, but in ox, goat, horse, chamois, mouflon, gazelle, and various antelopes. The geographical distribution is discussed at length. Other species of the genus, such as *M. serialis* from hares and rabbits, are dealt with. The life-history is the subject of another paper.||

Tapeworms from Mammals.¶—F. E. Beddard describes a species of *Oochoristica* from the Lesser Anteater (*Tamandua tetradactyla*), *Bertiella cercopitheci* sp. n. from the green Cercopitheque, and *Thysanosoma gambianum* sp. n. from a Pouched Rat (*Cricetomys gambianus*).

Parasites of Fishes.**—Jas. Johnstone describes a new Trematode, *Paracotyle caniculæ* g. et sp. n., from the head of the common dogfish, particularly in the region of the gill-slits. The diagnosis reads: "One

* Comptes Rendus, elii. (1911) pp. 906-9.

† Journ. and Proc. R. Soc. N.S. Wales, xlv. (1910) pp. 84-122.

‡ Centrabl. Bakt. Parasitenk. 1te Abt., lx. (1911) pp. 93-132 (26 figs.).

§ U.S. Dep. Agric., Bull. 125 (1910) pp. 1-68.

|| U.S. Dep. Agric., Circ. 159 (1910) pp. 1-7.

¶ Proc. Zool. Soc. (1911) pp. 626-60 (10 figs.).

** Report Lancashire Sea Fisheries Laboratory, xix. (1911) pp. 16-50 (5 pls. and figs.).

anterior sucker, terminal or sub-terminal, leading into a vestibule or pre-pharynx, into which opens the pharynx. Posterior sucker relatively small, and without radial thickenings or chitinous hooks. Intestine with two branches, and without lateral diverticula. Genital opening common, in the middle line immediately behind the pharynx. Vagina single and unpaired, opening on the ventral surface to the left of the common genital aperture. Testis single. One to two millimetres in length."

The author also records *Koellikeria filicollis* (Rudolphi) from the branchial arches of a Ray's Bream from the Menai Straits. The two sexes occur together in one cyst, the males filiform, the females with a filiform anterior portion and a kidney-shaped posterior portion. From a very large Ray the leech *Pontobdella lævis* (Blainville) is reported.

Two-fold Function of Ovaries in some Polyclads.*—Paul Hallez finds that many Antarctic Polyclads have no accessory glands on the oviducts and a relatively small number of ovaries which are, however, very large. Each ovary includes two portions, a ventral germinative zone and a dorsal region which is secretory. The product of secretion recalls that of the accessory glands of the oviducts and uterus in other Polyclads.

Regeneration in Short Head-pieces of Planaria.†—V. H. Keiller has experimented with *Planaria simplicissima*. It seems impossible to determine to what extent heteromorphic head-regeneration may occur. In general, however, about 80 p.c. of the heads formed new heteromorphic eyes and about as many new brains.

The regenerating head-pieces often showed scattered pigment spots, especially when no true eyes are regenerated. A pharynx may be regenerated if the brain is cut near its posterior limit, and always if the cut is made behind the brain. Unless the brain is cut no heteromorphic brain nor eyes are found; but head-pieces in which the brain is cut do not necessarily form brain or eyes.

The heteromorphic brain may be formed (1) by regeneration in close connexion with the cut ends of the old brain, and probably under their influence; (2) by regeneration of a new brain separated from the old, and connected with it by short cords; and (3) by thickening of the commissure nearest the cut ends.

Heteromorphic eyes are usually paired if they develop at all. They are rarely in the normal position. Heteromorphic brains of any of the three types may occur in the absence of one or both eyes; heteromorphic eyes may occur in the absence of any trace of brain regeneration. Heteromorphic heads differ from normal heads in the extent and shape of the digestive tract, which occupies almost the entire new region.

Nemertines of Millport.‡—J. Stephenson reports on these, describing *Amphiporus elongatus* sp. n., and *Micrura scotica* sp. n., and adding useful notes on ten others, with particular reference to their

* Comptes Rendus, cliii. (1911) pp. 142-3.

† Arch. Entwickl., xxxi. (1910) pp. 131-44 (23 figs.).

‡ Trans. R. Soc. Edinburgh, xlviii. (1911) pp. 1-29 (1 pl.).

variations. In connexion with *Cephalothrix linearis* he contributes welcome information in regard to the circulation. There is a definite circulation in the lateral vessels, occasioned by a series of contractile waves alternately postero-anterior and antero-posterior; this is not due to contractions of the body-wall, nor to movements of the body as a whole: it would seem necessary, therefore, to assume the presence of muscular tissue in the walls of the vessels.

The species *Cephalothrix rufifrons* and *C. biculata* are only colour varieties of *C. linearis*, and the unification of *Lineus gesserensis* and *L. sanguineus* is confirmed.

Experiments on Ova of Cerebratulus.*—Max Withrow Morse finds that reagents, such as saponin, oxalic, hydrochloric, and tartaric acids, which were used successfully to induce maturation, would not cause segmentation to proceed.

It was found, however, that if all trace of these reagents was washed off, and the eggs placed in a CO₂ sea-water solution, with a concentration of about 0.19 grm. to 100 grm. sea-water, segmentation proceeded, though development did not continue beyond the later segmentation stages.

Loeb and others have observed, in other cases, this antagonistic action of reagents which induce maturation and those which induce segmentation. "In such cases, as in the present one, the reactions are not reversible; CO₂ will not cause maturation."

Incertæ Sedis.

New Mediterranean Bryozoa.†—Louis Calvet describes *Idmonea arborea* sp.n., a vigorously growing form, ramifying dichotomously; and *Amathia pruvoti* sp.n., which is intermediate between *A. lendigera* and *A. semi-convoluta*.

Barentsia benedeni in British Waters.‡—James Ritchie describes specimens of this endoproctean Polyzoon which was found at Hull growing on the surface of *Membranipora* on the dock timbers. The Hull specimens seem to take a place intermediate between *Barentsia benedeni* (Foettinger), known only from Ostend, and *B. gracilis* (Sars), which occurs on Belgian and English coasts. The salient characters of the specimens are: Stem composed of up to 8 well-defined, robust internodes (3 or 4 being most common), from which buds may arise; no pores in chitinous portions of internodes; no granular masses in internodes; calyx relatively small, with transparent, colourless walls; tentacles 10 to 14, colourless; brain trapezoid in transverse sections.

Consideration of the variations of this and of related species leads the author to the following conclusions:—

1. *Arthropodaria* Ehlers is synonymous with *Gonypodaria* Ehlers, and both are included in *Barentsia*.
2. *Gonypodaria nodosa* (Lomas) is synonymous with *Barentsia gracilis*.

* Science, xxxiii. (1911) p. 388.

† Arch. Zool. Expér., viii. (1911) Notes et Revue, No. 3, pp. lvii.-lxi. (2 figs.).

‡ Trans. R. Soc. Edinburgh, xlvi. (1911) pp. 835-48 (1 pl.).

3. *Pedicellina belgica* van Beneden is synonymous with *Barentsia gracilis*.

4. *Barentsia benedeni* (Foettinger), and *B. gracilis* (Sars), are distinct.

Pectinatella magna near Berlin.*—W. Köhler reports the occurrence of large masses of this remarkable North American Bryozoon in the "Tegeler-See," near Berlin. It has been previously found near Spandau and in the Oder at Breslau. The statoblasts adhere very readily with their minute thorns, and may be transported by birds. Probably the transport from America was effected by ship.

Rotifera.

New Rotifera.†—Three new species from different parts of the world are figured and described by C. F. Rousset: *Anuræopsis navicula*, from Lake Gregory in Ceylon; *Brachionus havanaensis*, found in Plankton collected in the Illinois River near Havana; and *Brachionus satanicus*, a remarkably shaped species found living in the Devil's Lake, North Dakota.

Claro Island Rotifera.‡—In connection with the biological investigation of this small island on the west coast of Ireland, C. F. Rousset has collected 109 species of Rotifera on the island and adjoining mainland, of which 37 are new to Ireland. Some rather rare species are noted, but no forms new to science were discovered. The author remarks on the two distinct species: *Proales parasita* Ehrenberg (not Gosse), and *Hertwigia volvoicicola* Plate, usually found parasitic in the spheres of *Volvox globator*.

Echinoderma.

New European Crinoid.§—Austin Howard Clark defines *Antedon adriatica* sp. n. He finds that there are four perfectly distinct and readily recognizable European species, two inhabiting the Atlantic coasts of Europe, and two the southern shores east of the Straits of Gibraltar. The first two are *Antedon petasus* (Düben and Koren), *A. bifida* (Pennant); one of the last two is *A. mediterranea* (Lamarek); the fourth is *A. adriatica*. The occurrence of four distinct species throws light on the discrepant results of embryologists who worked with what they accepted as one species, *A. rosacea*. According to the author, *Antedon* is primarily an Indian Ocean genus, an intrusion into the Atlantic area, like *Leptometra*. The area inhabited by it is marked by a series of species, each phylogenetically more developed than its predecessor, and the least specialized more advanced than the species of *Mastigometra*, its modern representative in the Indian Ocean.

Recent Crinoids of Australia.||—Austin Hobart Clark reports on the Crinoid collections of the Australian Museum. There are 46 species known

* Internat. Rev. Hydrobiol., iv. (1911) Biol. Supp., pp. 6-7 (1 pl.).

† Journ. Quekett Micr. Club, xi. No. 68 (1911) pp. 161-4 (1 pl.).

‡ Proc. Roy. Irish Acad., xxxi. pt. 51 (1911).

§ Proc. U.S. Nat. Museum, xxxviii. (1911) pp. 329-33.

|| Mem. Australian Museum, iv. (1911) Scientific Results 'Thetis' Expedition, pt. 15, pp. 705-804.

from littoral and sub-littoral zones around Australia. These are included in 19 genera and 9 families. Eight of these families, including 18 of the 19 genera, belong to the sub-order Oligophreata. Twenty of the species and one of the genera are only known from Australia, but the latter is closely allied to two other genera characteristic of the East Indian region. The proportionate frequency of the genera and species in the several families is entirely different from what is found in other parts of the world. The great majority of the Australian Crinoids are tropical species, which have extended their range southward from the East Indian region, and they are therefore limited to the coast of Queensland on the east, and the coast north of Dirk Hartog Island on the west. The southern coasts are tenanted by seven species peculiar to Australia, but belonging to one endemic and four tropical genera, which lend to that region an aspect very characteristic, and yet without any special zoogeographical significance.

Coelentera.

Development of *Cunina parasitica*.*—P. Hanitsch discusses this extraordinary life-history. He takes up a median position between those who call the *Cunina* a parasite in the *Geryonia* and those who regard the association as symbiotic. He deals with the development of the constricted-off *Cunina proboscidea* Metsch., its production of a second generation of *C. proboscidea*, their production of *C. parasitica* (= a third generation of *C. proboscidea*), their production of the so-called budding polyp in the stomach of *Geryonia*, which buds off what we started with. But the alternation of generations is so intricate that we cannot do more than indicate the general nature of this new contribution to a much-investigated subject.

New Type of Alcyonarian.†—S. J. Hickson describes *Ceratopora nicholsonii* g. et sp. n., a remarkable new type of Alcyonarian. A single specimen was obtained by the 'Blake,' off Cuba, 100 fathoms. It was referred to by Agassiz as probably a Bryozoon, and by Alleyne Nicholson (in letters to Sir John Murray) as probably allied to Helioporidæ.

It has remarkable, indeed unique, calcareous spicules, minute, very slender, and tuberculate, which are embedded vertically in the walls of very narrow tubes. The definition of the proposed new family Ceratoporidæ is as follows: "Cænothecalia forming a massive skeleton of crystalline calcium carbonate, in which a few slender spicules are embedded. No tabulæ, the tubes closing below by the continuous growth of the thecal walls. Pores monomorphic and small (in the type species 0.2 mm. in diameter).

The genus *Ceratopora* differs from *Heliopora* in the presence of spicules, in the monomorphic condition of the pore, in the absence of tabulæ, and the complete closure of the tubes below. The small size of the tubes is very striking. Indeed, the small size of the zooids is one of the principal difficulties in accepting the view that the new type is an Alcyonarian.

* MT. Zool. Stat. Neapel., xx. (1911) pp. 204-50 (2 pls. and 9 figs.).

† Proc. Roy. Soc., Series B, lxxxiv. pp. 95-200 (1 pl. and 5 figs.).

Pennatulacea.*—W. Kükenthal and Hj. Broch have produced a magnificent report on the 'Valdivia' Pennatulids, which is also a great contribution to our knowledge of the order. For the authors have compared the 'Valdivia' material with that from other sources, and deal with 84 species in 25 genera. There are 15 new species in the 'Valdivia' collection.

The system established by the authors is as follows:—

- I. Pennatulacea radiata:—
Lituaris, Cavernulina, Polivella, Veretillum, Cavernularia, Actinoptilum, Echinoptilum.
- II. Pennatulacea foliata:—
Renilla.
- III. Pennatulacea bilateralia:—
Mesobelemnion, Sclerobelemnion, Kophobelemnion, Anthoptilum, Funiculina, Protoptilum, Distichoptilum, Stachyptilum.
- IV. Pennatulacea verticillata:—
Calibelemnion, Scleroptilum, Amphicome, Chunella, Umbellula.
- V. Pennatulacea penniformia:—
Pavonaria, Acanthoptilum, Scytalium, Scytaliopsis, Stylatula, Virgularia, Pennatula, Leioptilum, Pterocules, Struthiopteron, Sarcophyllum, Gyrophyllum.

Epizoidic Hydroid on Crab.†—W. T. Calman found a gymnoblastic hydroid, allied to *Styglactis*, attached like a tassel to the "knee" of each of the legs of a crab, *Nanthias haswelli* (Miers) (= *Modæus haswelli* Miers) from Christmas Island. The hydroid is disposed symmetrically with regard to the crab, and the type-specimens of the species to which the crab belongs, although coming from a distant locality, are found to carry colonies of a closely similar, perhaps identical species of hydroid. The polyps occur as follows—two on the carpus and one on the propodus of the cheliped, and one on the carpus of each walking leg. Two other small polyps are unsymmetrical. The hydrorhiza follows the inter-regional grooves of the dorsal surface of the carapace.

Siboga Plumularids.‡—A. Billard gives a preliminary account of new species of *Plumularia* (15) and *Cladocarpus* (2) collected by the 'Siboga' expedition.

Polarity in Tubularia.§—Max W. Morse cut off pieces of *Tubularia crocea* and rotated them in a centrifuge at the rate of 240–600 rotations per minute, for periods varying from a minute to half an hour.

When the pieces regenerated, lying horizontally in finger-bowls, the hydranth appeared at the original distal end, regardless as to whether the distal or proximal end of the stem had been directed centrifugally or centripetally in the experiment, and regardless of the fact that, as in the higher speeds, the contents of the perisarc tube were compressed into

* Wissensch. Ergebnisse deutsch. Tiefsee Exped., xiii. Heft 2 (1911) pp. 113–576 (17 pls., 17 maps, and 295 figs.).

† Ann. Nat. Hist., viii. (1911) pp. 546–50 (2 figs.).

‡ Arch. Zool. Expér., viii. (1911) Notes et Revue, No. 3, pp. lxxii.–lxxii. (16 figs.).

§ Proc. Zool. Exper. Biol. and Medicine, viii. (1910) pp. 29–30.

the end of this tube which was directed centrifugally in rotation. When regeneration took place, the red pigment which marks the future hydranth pole could be seen collecting in the compressed protoplasm, and it gradually migrated up the tube of perisarc until it reached the end of this tube, whereupon the tentacles and other parts of the normal hydranth appeared. The generalization may be made that polarity in *Tubularia crocea* cannot be altered by the action of centrifugal force, in shifting "organ-forming areas" from one end of the piece of stem to the other.

Porifera.

Development of Sponges from Dissociated Cells.*—H. V. Wilson squeezed out cells, e.g. of *Microciona prolifera*, and put a drop of the "sediment" on a slide. The cells fuse into syncytial masses or plasmodia, these may fuse into incrustations, and these may form sponges. The details of the interesting process are described. Experiments were also made with *Lissodendoryx carolinensis* sp. n. and *Stylotella heliophila* sp. n. in both of which the dissociated cells formed plasmodia. When dissociated cells of *Microciona* and *Lissodendoryx* are mingled, they do not fuse. The same is true of *Microciona* and *Stylotella*; the cells of one species fuse, the plasmodial masses of one species fuse, but there is no fusion between the tissues of two separate species. The author thinks that when the cells are violently dissociated in his very interesting experiments they pass into an indifferent generalized state. In this state they re-combine to form a mass of undifferentiated tissue comparable to a heap of blastomeres, in which differentiation and growth occur.

Classification of Halichondrina.†—E. Topsent has studied the larvæ in this sub-order of sponges, and re-adjusts the classification a little in the light of his observations. There are four families. 1. The Halichondridæ have larvæ completely ciliated and of uniform colour:—*Halichondria*, *Tedaniome*, *Ephydatia*, etc. 2. The Haploscleridæ have the larvæ naked posteriorly, with a crown of long cilia and a ring or cap of pigment:—*Reniera*, *Chalina*, *Chalinula*, *Gellins*, *Desmaridon*, etc. 3. The Pæciloscleridæ have the larvæ naked posteriorly, without a crown of long cilia, and with the posterior hernia paler than the rest:—*Mycale*, *Tedania*, *Myrilla*, *Batzella*, *Clathria*, *Echinodictyum*, etc. 4. The Axinellidæ, with larval characters a little like those of the preceding family, but with different spiculation.

Sponges associated with Vermetidæ.‡—N. Annandale describes rocky masses dredged from the Bay of Bengal which consist of the shells of *Siliquaria muricata* (Born.), *S. cochlearis* Mörch, and *Spiroglyphus cumingi* (Möorch), closely associated with sponges, namely two new varieties of the Lithistid *Racodiscula sceptrellifera* (Carter), and the Monaxonid *Spongosorites topsenti* Dendy. Neither of the two species of sponges found associated with the three species of Vermetidæ is peculiar to these shells, nor, indeed, to a habitat or manner of life similar to that

* Bull. Bureau Fisheries, xxx. (1910, published 1911) pp. 1-30 (5 pls.).

† Arch. Zool. Expér., viii. (1911) Notes et Revue, No. 1 pp. i.-xv. (4 figs.).

‡ Records Indian Museum, vii. (1911) pp. 47-55 (2 pls.).

implied by the mollusc's peculiar method of growth. In two cases out of three, however, the sponge appears to be modified to some extent by its association. "It is probable that the masses, with which this paper deals, will be of considerable interest to the geologists of some future epoch, when the bottom of the Bay of Bengal has become dry land, if there be geologists then."

Protozoa

Protozoa of the Soil.*—T. Goodey reports about thirty Protozoa which he has been able to identify in cultures of soil. Of these eighteen are Ciliata, such as species of *Colpoda*, *Balantiophorus*, *Pleurotricha*, and *Vorticella*. It is shown, however, that these exist in the soil in an encysted, not in an active condition. Therefore they cannot function as a factor limiting bacterial activity in the soil. But the experiments on which this conclusion is based were confined to Ciliata. The Amœbæ and Flagellates were not dealt with.

Studies on Amœbæ.†—Maynard N. Metcalf discusses in the first place the localization of the contractile vacuole. More than one portion, probably any portion, of the outer layer of the endosarc may form a contractile vacuole. When it is formed it soon associates itself with a mass of granules—"just the beginning of specialization of cytomicrosomes in connexion with excretion." No portion of the protoplasm will ordinarily, if ever, form a new contractile vacuole so long as the already collected mass of granules associated with the old vacuole persists.

The author describes a new species of *Amaba* (*A. currens*) parasitic in the rectum of tadpoles, which is marked by very rapid locomotion. In connexion with the life-cycle of a Baltimore *Amœba*, which may be *A. proteus*, the author describes the formation of biflagellate spores of a Cercomonad-like type. There is a fragmentation of the nucleus in the parent *Amaba*. He also refers to an *Amaba* he found at Würzburg, which produced amœbosporos with fine reticulate pseudopodia.

Effect of Excretion-products on Rate of Reproduction in Paramœcium.‡—Lorande Loss Woodruff has begun an investigation of the complex factors at work in a "hay infusion" or the like, such as those which determine the interdependence of the organisms, their sequence, time of appearance and disappearance. He has tested the effect of different volumes of culture medium on the rate of reproduction of *Paramœcium*; the effect of changing the culture medium daily and every second day on the rate of reproduction of *Paramœcium*; and the effect of culture medium, in which large numbers of *Paramœcium* have been living, on the rate of reproduction of *Paramœcium*.

He has come to the following conclusions. 1. The rate of reproduction of *P. aurelia* and *P. caudatum* is influenced by the volume of the culture medium, within the limits tested, and the greater the volume the more rapid is the rate of division. 2. There is evidence that *Para-*

* Proc. Roy. Soc., Series B, lxxxiv. (1911) pp. 165-80 (1 pl.).

† Journ. Exp. Zool., ix. (1910) pp. 301-31 (45 figs.).

‡ Journ. Exp. Zool., x. (1911) pp. 557-81 (11 figs.).

maecium excretes substances which are toxic to itself when present in its environment, and these substances are more effective when the organisms are confined in limited volumes of culture fluid. 3. The excretion-products play an appreciable part in determining the period of maximum numbers, the rate of decline, and the like, of *Paramaecium* in hay infusions.

Fertilization in Ciliata.*—P. A. Dangeard discusses Dehorne's position that there is no real fertilization in Ciliata, and points out sources of error. The author upholds the conclusions of Manpas—the occurrence of fertilization in Ciliata is solidly established. The problem of chromatin-reduction is in process of solution.

Polymorphism in Flagellates.†—Ch. Gineste has observed that individuals of *Trichomastix*, and the like, may lose their flagella and move with pseudopodia. Sometimes one flagellum is replaced by a pseudopodium. Sometimes the margin shows sinusoid undulatory movement. He suggests that these different forms are related to diversity of environmental conditions.

Cuirass of Peridiniidæ.‡—L. Mangin contrasts the resistance that the cuirass offers to digestive fluids, with its rapid dissolution inside microscopic animals in the water. He also shows that the cuirass undergoes changes of structure during the individual life, particularly as regards the disposition of the ornaments and the constitution of the sutures. In some species the appearance of the sutures changes very markedly. The variations of the sculpturing in *Peridinium oceanicum*, *P. depressum*, *P. divergens*, *P. crassipes*, and *P. punctulatum*, are recorded. In short, the author shows that the cuirass is in several respects very plastic, and that it is necessary to know the limits of change in each species.

Genus Ceratium.§—E. Jörgensen gives a monographic account of this polymorphic genus, in which he distinguishes four sub-genera—*Poroceratium* (Vanhöffen), *Biceratium* (Vanhöffen) Gran, *Amphiceratium* (Vanhöffen) Gran, and *Euceratium* Gran. After describing all the species, the author discusses their affinities, tracing back the other three sub-genera to the *Biceratium* stock. The variability of species of *Ceratium* is dealt with and the geographical distribution.

Placidiorina californica at Banyuls.||—Edouard Chatton found this Volvocinid, previously reported from California, Indiana, Illinois, in an irrigation pond at Banyuls-sur-Mer. It appeared at the end of April and disappeared at the beginning of July. It was observed in three successive years, but no sexual reproduction was detected in the pond. This was studied, however, in the laboratory. Vegetative colonies, parthenogenetic colonies, male colonies, female colonies, and "involution"

* Comptes Rendus, clii. (1911) pp. 1703-5.

† C.R. Soc. Biol., lxx. (1911) pp. 1014-16.

‡ Internat. Rev. Ges. Hydrobiol., iv. (1911) pp. 44-54 (2 pls.).

§ Internat. Rev. Hydrobiol., iv. (1911) Biol. Supp., pp. 1-124 (10 pls.).

Bull. Sci. France Belg., xliv. (1911) pp. 309-31 (1 pl.).

colonies, are described. The contrast between somatocytes and germinocytes is described. They are grouped in two hemispheres, the somatic hemisphere being always anterior.

It seems that *Pleodorina californica* is connected to *Eudorina* by *Pleodorina illinoisensis*; and *Eudorina*, *Pleodorina*, and *Volvox* form a series illustrating an increasing differentiation between somatic cells and germ-cells. The author makes an interesting comparison between *Pleodorina californica* and the amphiblastula of *Sycandra*, which it exactly resembles, the ectodermic hemisphere corresponding to the somatic and the endodermic to the germinative. The phylogenetic interest of the Volvocinids—"Protozoaires somatidés"—is discussed.

New Dinoflagellates.*—Charles A. Kofoid and Josephine R. Michener give preliminary descriptions of a large number of new species collected by the 'Albatross' (1904-5), and establish two new genera, *Peridiniella*, related to *Peridinium*, and *Berghiella*, of undeterminable relationships. The puzzling form *Berghiella* is like a spheroidal *Gonyaulax*, with very abruptly differentiated low cylindrical apical horn with truncate apex. "Girdle with hyaline lists, descending, displaced less than a girdle width, not impressed. Ventral area not delimited posteriorly. Absolutely no trace of subdivision of theca into plates or regions."

Studies on Trypanosomes.†—Sir David Bruce and Captains A. E. Hamerton, N. R. Bateman and F. P. Mackie report from a Uganda ox a Trypanosome which seems to be identical with *T. brucei*, the cause of Nagana. They also report ‡ *T. vivax* (Ziemann), an easily recognizable species, which gives rise to a fatal disease of cattle in Uganda. Its carrier is probably *Glossina palpalis*, which is found naturally infected on the lake-shore. The reservoir of the virus is possibly the antelope which frequents the *G. palpalis* area.

Bee Disease due to Nosema apis.§—H. B. Fantham and Annie Porter have found bees and combs from Cambridgeshire and Hertfordshire infected with the microsporidian *Nosema apis* (found by Zander in Bavaria), which is closely allied to the parasite of silkworm disease (pébrine), *N. bombycis*. The trophozoite and pansporoblast stages of *N. apis* have been observed in the gut-epithelium of the bee. The result is a dry dysentery, and the spores are the infective stages. Infection is probably spread by diseased bees attempting to enter healthy hives. Experimental infection was brought about. The only certain destructive agent is fire. The authors think that *Nosema* has been responsible for much of the recent "bee-disease"; but they recognize "foul brood" as a quite separate disease. They also call attention to Dr. Malden's investigation of a bacillary infection in bees, the parasite being called *Bacillus pestiformis apis*. The authors found, besides *Nosema*, various Gregarines, a Flagellate apparently belonging to the genus *Crithidia*, a new *Amoeba* (*Entamoeba apis*), a spirochaete, and various Fungi.

* Bull. Mus. Comp. Zool., liv. (1911) pp. 269-302.

† Proc. Roy. Soc., Series B, lxxxiii. (1910) pp. 1-14 (2 pls.).

‡ Proc. Roy. Soc., Series B, lxxxiii. (1910) pp. 15-27 (3 pls.).

§ Proc. Zool. Soc., 1911, pt. iii. pp. 625-6.

Parasite of Coast Fever.*—R. Gonder describes the asexual and sexual phases ("agamonts" and "gamonts") of *Theileria parva*, corroborating Koch's conclusion that it is the parasite of coast fever in African cattle.

Developmental Forms of *Trypanosoma brucei*.†—George Buchanan gives an account of developmental stages of *Trypanosoma brucei* (*pecaudi*) in the internal organs of the gerbil (*Gerbillus pygargus*). He deals in particular with intra-corpuseular and extra-corpuseular forms in the spleen, and with stages seen in lung smears, e.g. the possible formation of the so-called "latent body" of Moore and Breinl, and its metamorphosis into the trypanosome.

New Trypanosome.‡—David Bruce and A. E. Hamerton, H. R. Bateman, and F. P. Mackie describe *Trypanosoma uniforme* sp. n. from oxen, goats, and sheep in Uganda. It resembles *T. vivax* in shape and general appearance, but differs markedly in size. It also resembles *T. vivax* in not being pathogenic to the smaller laboratory animals. There is no evidence available as to what the carrier is.

***Trypanosoma nanum* (Laveran).§**—David Bruce and A. E. Hamerton, H. R. Bateman, and F. P. Mackie discuss this species which was found to occur in cattle in Uganda. It is indistinguishable from *T. pecorum* either in the living condition or when fixed and stained. It differs from *T. pecorum* in not being pathogenic to the smaller laboratory mammals. Its carrier is unknown.

Life-history of *Trypanosoma gambiense* and *T. rhodesiense*.||—H. B. Fantham describes non-flagellate stages, the "latent bodies" of Moore and Breinl. They are especially found in the lungs, spleen, and bone-marrow during periods of decrease of Trypanosomes in the peripheral blood. They are in process of formation at or near the time when the Trypanosomes are most numerous in the peripheral blood. The non-flagellate body contains the nucleus and blepharoplast. In its formation some of the cytoplasm and the flagellum are disintegrated. They develop flagella when placed in fresh warm uninfected blood. There is a life-cycle of Trypanosomes (of the above species) in Vertebrate hosts (rats and guinea-pigs in Fantham's experiments), comparable to those of *Crithidia* and *Herpetomonas* in the alimentary canal of various Invertebrates.

Transmission of Sleeping Sickness.¶—David Bruce and A. E. Hamerton and H. R. Bateman, and R. van Someren, have found that *Trypanosoma gambiense* may retain their virulence for a period of two days after they are ingested by *Glossina palpalis*. But after the Trypanosomes have been within the gut of the fly for two days, the power of infecting animals with sleeping sickness, when inoculated subcutaneously, is lost for twenty-two days. The Trypanosome in question

* Arch. Protistenk., xxi. (1910) pp. 142-64.

† Proc. Roy. Soc., Series B, lxxxiv. (1211) pp. 161-4 (1 pl.).

‡ Proc. Roy. Soc., Series B, lxxxiii. (1911) pp. 176-9 (1 pl.).

§ Proc. Roy. Soc., Series B, lxxxiii. (1911) pp. 180-6 (2 pls.).

|| Proc. Roy. Soc., Series B, lxxxiii. (1911) pp. 212-17 (1 pl.).

¶ Proc. Roy. Soc., Series B, lxxxiii. (1911) pp. 345-8.

regains the power of infecting by direct inoculation after it has been twenty-four days within the intestine of the fly. The number of days, during which the virulence of the Trypanosome contained in the fly is lost, roughly coincides with the time that the infected fly is incapable of transmitting sleeping sickness by biting susceptible animals. There is some evidence that the salivary glands of the fly are invaded by virulent forms of the parasite thirty-six days after the fly has fed upon infected blood.

Trypanosoma evansi.*—David Bruce gives a precise account of the dimensions, shape, and structure of *T. evansi* (Steel) which causes Surra in elephants, camels, horses, cattle, and dogs. He compares it in detail with *T. brucei*, bringing out the differences between the two.

New Coccidian from a Whelk's Kidney.†—W. J. Dakin describes *Merocystis kathæ* g. et sp. n., a Coccidian parasite very abundant, in the form of white spherules, in the renal organ of *Buccinum undatum* (in all the specimens examined at Port Erin). The genus is characterized by the division of the zygote by septa into secondary cysts, in each of which numerous spores are found. In the later stages these all lie loosely in the larger cyst. The genus is referable to Léger's family Polysporocystidae.

The spores are monozoic, somewhat flattened and slightly angular, and the sporocyst is smooth and not bivalve. The sporogonic life-cycle is the only one to be observed in the whelk. Schizogony may take place in another host, or it may be absent altogether.

Development of Sarcocystis muris.‡—Rh. Erdmann dissects this representative of the Sarcosporidia. The first period of the life-history extends from the time of ingestion by the host to the first stage in the musculature. It lasts for 28 to 30 days, and its seat is in the walls of the alimentary canal, in the lymph-vessels, and in the fatty tissue. The second period comprises the transition from the unicellular stage to the completed sac within the muscle. In this second period there is a stage of multiplication of cells, a stage in which the cells become very rich in chromatin, a stage of rapid division into sporoblasts, and a stage in which sickle-shaped spores are differentiated.

Hæmatozoa of Australian Reptiles.§—T. Harvey Johnston and J. Burton Cleland record a number of forms and describe *Hæmogregarina* (*Karyolysus*) *dendrophilus* sp. n. from the green tree-snake, *H. (K.) varanicola* sp. n. from the monitor lizard, *H. (K.) hinulie* from a skink, and other un-named species from a spinifex snake.

Life-history of Hæmogregarina stepanowi.||—E. Reichenow has studied the life-history of this parasite, and is unable to agree with Siegel's account. He emphasizes its resemblance to a *Coccidium*, and describes the asexual phases in the marsh turtle (*Emys orbicularis*) and the sexual phases in the leech (*Placobdella catenigera*).

* Proc. Roy. Soc., Series B, lxxxiv. (1911) pp. 181-7 (1 pl.).

† Arch. Protistenk., xxiii. (1911) pp. 145-53 (14 figs.).

‡ SB. Ges. Nat. Freunde (1910) No. 9, pp. 377-87 (1 pl. and 5 figs.).

§ Proc. Linn. Soc., xxxv. (1910) pp. 677-85 (1 pl.).

|| SB. Ges. Nat. Freunde Berlin (1910) pp. 1-4 (1 pl.).

Free-living Spirohemaceæ.*—J. Gross describes *Saprospira* g. n., with two species *S. grandis* and *S. uana*. In *Saprospira* there is a spirally coiled body and the multiplication is by fragmentation. He regards *Saprospira* as a free-living genus of Spirohemaceæ, and refers the whole family to the Bacteria.

Large Gregarine in Atyephyra.†—L. Mercier reports *Cephaloidophora cuenoti* sp. n., a large Polycystid Gregarine, from the intestine of the freshwater crustacean *Atyephyra desmaresti* Millet. It seems different from *Didymophyes longissima*, which infests *Gammarus* and *Orchestia*. Further investigation is necessary, however, especially in the light of the suggestion made by Léger and Duboscq that *Cephaloidophora* and *Porospora* may represent respectively the gamogonous and schizogonous phases of the same cycle.

Haplosporidian Parasite in Donax.‡—Casimir Cépède discusses the life-history and affinities of the Haplosporidian which Caullery and Chapellier described from the Trematode sporocysts of *Donax* and name *Anurosporidium pelseneri*. Its developmental cycle presents close affinities with that of Cnidosporidians on the one hand and that of *Chytridiopsis* on the other. It is nearly allied to *Haplosporidium* and *Urosporidium*.

* MT. Zool. Stat. Neapel, xx. (1911) pp. 188-204 (1 pl.).

† C.R. Soc. Biol. Paris, lxx. (1911) pp. 51-3.

‡ Comptes Rendus, cliii. (1911) pp. 507-9.



BOTANY.

GENERAL,

Including the Anatomy and Physiology of Seed Plants.

Cytology,

Including Cell-contents.

Permeability of Protoplasm.*—J. Sziics has investigated the permeability of protoplasm as shown in the absorption of anilin dyes by the living cells and the retardation of such absorption by electrolysis. The present investigations show that the rapidity of absorption of many basic colouring matters is directly proportional to the concentration, but the permeability of the plasma-membrane is not constant. Certain electrolytes retard the absorption of basic colouring matters, the retardation being directly proportional to the valency of the kations. Dilute solutions are proportionally more powerful than strong ones; one and the same amount of the electrolyte always produces the same retardation with similarly concentrated solutions of the colouring matter. Calcium salts and other electrolytes likewise retard the absorption of ferrous sulphate. The absorption of basic colouring matters is retarded by the presence of acid colouring matters in accordance with well-defined laws. The retardation caused by electrolytes is due to their effect upon the plasma, while that produced by acid colouring matters is due to the formation of a salt to which the plasma-membrane is impermeable.

Formation of Chloroleucites.†—A. Guilliermond, in studying the germination of barley, has found all stages of transition between chondriocotes and chloroleucites, and is of opinion that the latter owe their origin to the former. In the basal, more rudimentary parts of the seedling, the chondriocotes occur in vacuoles in the neighbourhood of nuclei, and when cell-division occurs they are equally distributed among the daughter-cells. Higher up they are changed in form, and are confined almost exclusively to the neighbourhood of the nuclei; as they pass higher they become ovoid, and increase in size. From this point onwards the chondriocotes disappear, and only chloroleucites are found, which occupy the same places, have the form of disks or spheres, and are uniformly coloured or with light centres. Later on the chloroleucites acquire their normal shape, size, and colour. If this discovery proves to be correct, it is important, because it explains the origin of the chloroleucites and the function of the chondriocotes.

Mitochondries of Plant-cells.‡—The same author contributes a short note dealing with his investigations concerning the presence and function

* SB. Akad. Wiss. Wien, cxix. 7 (1910) pp. 737-73 (4 figs.).

† Comptes Rendus, cliii. (1911) pp. 290-2 (12 figs.).

‡ Comptes Rendus, cliii. (1911) pp. 199-201 (4 figs.).

of the mitochondries. Investigations of the lower plants, e.g. Fungi, Alga, etc., were not very successful, but mitochondries were found in the asci of *Pustularia vesiculosa*. Seeds of the higher plants were especially rich in mitochondries from the commencement of germination, both in the endosperm and in the tissues of the embryo. They varied in form, being rod-like in *Ricinus*, and spherical in haricot beans: they were specially abundant in barley, wheat, and maize. In barley they were present in the cotyledons until the latter began to wither, and in other organs of the embryo they persisted in the meristem until the tissues were differentiated. In parenchymatous cells their disappearance coincides with the appearance of the chlorolenticles, and in the cambial strands with the differentiation of the fibro-vascular bundles.

Structure and Development.

Vegetative.

Splitting of Rhizome and Root of Delphinium.*—M. A. Kingsley has examined several specimens of *Delphinium scaposum*, and finds that the most apparent characteristic common to all is the manner of splitting of the rhizome and root. The following are the chief points of interest:—The primary root-structure is regular. The cambium produces an annual ring of xylem and phloem, but both elements are frequently replaced by parenchyma. There is an endodermis between the outermost spongy cortex and the regular outer parenchyma. In the third year an inner endodermis cuts off the primary xylem, parenchyma and necrotic pith from the rest of the tissues. The outer endodermis pushes between the xylem, joins the inner endodermis, and makes a continuous ring about each of the segments thus formed. The tissues thus cut off become necrotic. Columns arise, surrounded by active cork-forming periderm: these have an independent existence, and never exceed the number of the original bundles.

Epidermal Characters of *Frenelopsis ramosissima*.†—Edward Wilber Berry notes that the genus was founded by Schenck in 1869 upon abundant material from the Lower Cretaceous, and named from its resemblance to the modern genus *Frenela*. The species has since been recognized in Greenland, Texas, New Jersey, and France. In 1880 Hosins and Van der Marck described *Frenelopsis Königi*, from Westphalia, and in 1881 Heer described *F. occidentalis*, from Portugal. The latter also described *F. leptoclada*, which is confined to the Lower Cretaceous of Portugal. In 1889 Velenovsky described *F. bohemica* from the Cenomanian of Bohemia, and in 1890 Fontaine described *F. ramosissima* and *F. parceramosa*, from the Potomac group of Virginia, the same author in 1893 founding a third species, *F. varians*, upon material from the Trinity group. Newberry (1896) described a ninth species, *F. gracilis*, an abundant Upper Cretaceous type, which has been recently shown by Hollick and Jeffrey to be unrelated to *Frenelopsis*.

* Bull. Torrey Bot. Club, xxxviii. (1911) pp. 307-17 (2 pls. and 1 fig.).

† Bot. Gazette, 1. (1910) pp. 305-9 (2 figs.).

Although fruiting specimens have not been found, the position of the genus in Cupressineæ is not disputed. The genus is thus defined:— Shrubs or trees with cylindrical, jointed, monopodial stems and branches, the latter alternate, or whorled, often large. Leaves much reduced, generally triangular with a broad base and acute apex; squamiform, appressed, decussate. Internodes, variable in length, but longer in the apparently annual shoots, which were more or less deciduous and functioned as leaves.

F. ramosissima ranges from bottom to top of the Lower Cretaceous in the Maryland-Virginia region, to which it is thus far confined. The enticle of the type of the genus *F. Hoheneygeri* was described by Zeiller in 1882, and in 1888 Velenovsky described the epidermal features of *F. bohémica*. The stomata in these species consisted usually of four cells, symmetrically arranged, the opening being in the form of a star. According to Zeiller they indicate an affinity with *Callitris* and *Libocedrus*, and disprove Heer's contention that this genus is allied to *Ephedra*.

In *F. ramosissima* the arrangement is similar to that of the two species just mentioned. The epidermal cells are very small, roughly rectangular, and with very thick walls. Their most curious feature is the presence of minute, usually curved, spine-like outgrowths. The curious stomatal openings which apparently characterize *Frenelopsis*, are circular and about 0.03 mm. in diameter. They are very numerous, but whether they are localized on certain portions of branches which perform the functions of leaves, or whether they are uniformly distributed on the annual shoots, could not be determined. They consist of five or six guard-cells arranged around the central stomatal opening. In their more essential characters they agree with the stomata of *F. Hoheneygeri* and *F. bohémica*. These features suggest strong isolation and lack of humidity; but such conditions are not suggested by other members of the associated flora. These peculiar features may have been inherited from triassic ancestors which acquired them when the climate was extremely arid, as we know it was from physical as well as paleontological criteria.

Reproductive.

Ovule and Embryo-sac of the Platanaceæ.*—Th. Nicoloff contributes a brief account of the development of the ovule and embryo-sac of *Platanus*. The ovule is pendent, almost orthotropous, and the manner of insertion varies. The nucellus-tissues are homogeneous at first, but as the integuments are formed, differentiation takes place. The formation and development of the embryo-sac strongly resembles that of *Spiræa* especially in the formation of a sort of epidermal cavity in the neighbourhood of the micropyle and in the peculiarities of the structure of the chalazal portion of the nucellus. Resemblances to *Hamamelis* are found in the slow disappearance of the antipodal-cells, in the retardation of fertilization, etc. The author considers that these facts support the views of those who place the Platanaceæ among the Rosiflores, on account of the similarity in floral structure.

* Comptes Rendus, cliii. (1911) pp. 287-290.

Physiology.

Nutrition and Growth.

Opinions upon Physiology of Leaf-fall.*—R. Combes publishes a paper dealing with the opinion, held by Sachs and others, that substances contained in falling leaves are useless to the plant. The writer refers to the influence which this opinion has had upon deductions made from microchemical researches, and then discusses the variations produced in autumn, in the mineral substances, nitrogenous compounds and hydrocarbons contained in leaves. Finally he concludes that there is no proof that the substances useful to living plants are transferred from the leaves to the stem during the period of leaf-fall. It appears necessary to make more exact experiments at very frequent intervals upon leaves before, during, and after fall; these experiments should be made with leaves exposed to ordinary atmospheric conditions and upon those protected from rain, etc., while simultaneous experiments should be made upon living parts of the plant. The chemical composition of leaf-contents should also be analysed at different stages. The loss or accumulation of substances in falling leaves varies according to species, atmospheric conditions, first frosts, etc. Chemical composition is modified in a similar way; thus frost causes increase in oxidation and hence an accumulation of substances rich in oxygen; likewise starch is transformed into sugar under the influence of frost. Since it has been proved that such substances as sugar and amides can accumulate in falling leaves, the author regards Sachs' opinion as quite inadmissible, and contends that chemical change, persistence, accumulation, or diminution of substances contained in falling leaves, can no longer be regarded as explaining the physiological role of these substances.

Complementary Chromatic Adaptation in Plants.†—P. A. Dangeard has investigated this phenomenon in the Cyanophyceæ by means of a special spectrograph, and finds that the normal colours of the algae are preserved when exposed to that part of the spectrum which has no effect upon the growth, i.e. from the violet to the yellow rays. They become green under the rays extending from the yellow to the infra-red. The rays which are the most active in chlorophyll-synthesis are those which determine the change in coloration.

Irritability.

Effect of Etherization on Metabolism.‡—J. Hempel has studied the effects of anaesthetics such as ether upon the seeds and seedlings of *Pisum* and *Lupinus*, and also upon the buds of *Acer Pseudoplatanus*, and potato-tubers. The writer finds that small doses of ether accelerate the production of CO_2 , especially at low temperatures, while large doses retard it in proportion to the size of the doses. During the after-effect there is no acceleration, but the respiratory process is retarded both by

* Rev. Gén. Bot., xxiii. (1911) pp. 129-64.

† Comptes Rendus, cliii. (1911) pp. 293-4.

‡ Mém. Acad. Roy. Sc. and Lett. Danemark, Copenhagen, ser. 7, vi. (1911) pp. 215-78.

small and large doses. Similar results were obtained in the case of sugar-formation, but when very large doses were given there was an increase in the amount of sugar, probably because of the complete cessation of the transformation of sugar into polysaccharides. The inversion of non-reducing to reducing sugars was retarded by both small and large doses. Destruction of proteids and formation of amides was accelerated by small and retarded by large doses, but very large doses caused increase in the amount of amides. The ripening process of seeds and its accompanying synthesis of proteids is accelerated by small and retarded by large doses.

The results seem to show that in all the above-mentioned cases an exciting phase is produced by small doses of short duration; this is followed by the narcotic-phase proper, which is produced by small doses of long duration and large doses of short duration, and is characterized by retardation of the normal processes. Large doses and average doses of long duration cause the toxic phase, characterized by death phenomena.

CRYPTOGAMS.

Pteridophyta.

(By A. GEPP, M.A., F.L.S.)

Ophioglossum palmatum.*—M. A. Chrysler discusses the question of whether *Ophioglossum palmatum* is anomalous, namely whether the several to many fertile spikes are derived by duplication or branching of the single spike found in *O. vulgatum*, or whether the spikes represent fertile lobes of the leaf. The former is the view lately advocated by F. O. Bower; and the latter represents the usual view. Chrysler discusses the respective arguments for and against. Further investigation is required to settle the question.

Hemigramma latifolia.†—W. N. Clute gives a description and figure of *Hemigramma latifolia*, an anomalous fern which has been referred to various sections of *Acrostichum*, *Hemionitis*, etc. It is the type of the genus *Hemigramma* Christ. Specifically it has been known as *Zollingeri*. It occurs in the Philippines and other East Indian islands.

Asplenium alternans in America.—W. A. Poyser ‡ indicates the identity of *Asplenium Ferrissi* Clute with the Himalayan *A. alternans* Wallich. The former was found in Arizona in 1908. The latter is known from Abyssinia also. Both descriptions and specimens of the two species agree.

J. H. Ferriss § collected *A. Ferrissi* in Arizona at an altitude of 7000 ft. in the Huachuca mountains, Cochise county. Most of the specimens collected have died under cultivation.

W. N. Clute || discusses the distribution of the above fern. Of its

* Bot. Gaz., lii. (1911) pp. 151-3.

† Fern Bull., xix. (1911) pp. 46-8 (1 pl.).

‡ Fern Bull., xix. (1911) pp. 33-6.

§ Fern Bull., xix. (1911) pp. 36-8.

|| Fern Bull., xix. (1911) pp. 38-42.

identity with *A. alternans* there seems to be no doubt. But how an Indian fern should start a colony in Arizona is a deep mystery. Clute seeks for an explanation of the matter, and cites other instances and the theories of multiple origin and of wind-distribution.

Pteridophytes of Schleswig-Holstein.*—P. Junge gives a detailed account of the Pteridophytes of Schleswig-Holstein. These comprise thirty-nine endemic species, which the author has investigated in the most elaborate way, recording and describing every variety, form, sport, and hybrid known in the province, and giving the full distribution. Where necessary he has inserted text figures. He also devotes a chapter to distribution, and another to critical notes.

American Ferns.†—L. F. Kimball gives an account of about two dozen Pteridophytes gathered in San Diego county, California, with some notes on their habitats and characters. *Adiantum capillus-veneris*, found in 1902 under the flume that brings water from the mountains to San Diego across an arid, sandy country, has already advanced eight miles along the flume, and grows wherever there is sufficient shade. *Ophioglossum californicum* and *Gymnogramme triangularis* are the rarest species. *Pellæa ornithopus* varies much in the wild state and under cultivation; it requires investigation.

A. Prescott ‡ describes the walking fern (*Camptosorus rhizophyllus*), and one of its habitats.

W. N. Clute § publishes some notes on variations of form sometimes met with in *Nephrodium marginale*.

Under the title Pteridographia he gives || notes on the following subjects: Forked Liquorice Fern, Sex in the Ostrich Fern, Death of J. H. Hart, Cambium in Ferns, Fragrant Bracken, Abnormal Lycopodiums.

Bornean Ferns.¶—E. B. Copeland publishes descriptions and figures of twenty new ferns collected in Borneo, mostly by C. J. Brooks; and has issued two previous papers on the same subject in the same journal. The specimens were gathered in Sarawak. Copeland calls attention to *Polypodium heracleum*, and discusses its relationship with *Drymaria*. He draws up a key to illustrate in brief the characters of the minor groups in which he prefers to arrange the allied species without taking them out of the genus *Polypodium*.

Ferns of Perak.**—H. N. Ridley gives a list of sixty-six ferns and eight Lycopodiaceæ collected during an expedition to Temengoh, in Upper Perak. One variety is new.

Philippine Ferns.††—E. B. Copeland gives an account of some new or interesting Philippine ferns received from various collectors. Five of

* Beih. Jahrb. Hamburg Wiss. Anstalt., xxvii. (1910) pp. 49-245 (figs.).

† Fern Bull., xix. (1911) pp. 42-6.

‡ Fern Bull., xix. (1911) pp. 48-9.

§ Fern Bull., xix. (1911) pp. 50-2 (figs.).

|| Fern Bull., xix. (1911) pp. 53-9.

¶ Philippine Journ. Sci., vi. (1911) pp. 133-41 (14 pls.).

** Journ. Straits Branch R. Asiat. Soc., 1910, pp. 118-22.

†† Philippine Journ. Sci., vi. (1911) pp. 145-8.

the species are new to science. For *Lastræa exigua* J. Smith, which, through uncertainty and misunderstanding of authors, finds itself without a name, Copeland supplies the designation *Dryopteris confusa*.

Papuan Ferns.*—E. B. Copeland gives an account of the ferns collected in eastern New Guinea by C. King. The series is of a completely Malayan character, and affords a strong argument against the naturalness of Wallace's line between Malaya and New Guinea. It contains 171 species and varieties, 87 of which occur both east and west of New Guinea; while 16 were already known as endemic in New Guinea, and 42 are described as new by Copeland.

E. Rosenstock † publishes descriptions of nine new species found in a collection of about one hundred ferns collected by C. King in British New Guinea, and sent to the Buitenzorg Botanic Garden.

African Ferns.‡—G. Hieronymus publishes descriptions of a number of African species of Polypodiaceæ, most of which are new to science—namely, thirty-seven species and numerous varieties. The specimens cited were collected in German East Africa, Kamerun, Congo, Nigeria, Angola, Bechuanaland, St. Thomé, Fernando Po, Abyssinia, etc.

A. Gepp § publishes a list of sixty-nine pteridophytes collected by C. F. M. Swynnerton in Gazaland, a district lying partly in Eastern Rhodesia, partly in Portuguese territory to the east.

Bryophyta.

(By A. GEPP.)

Inflorescence of Muscineæ.||—I. Donin defines some of the laws of the inflorescence of the Muscineæ. Apart from the synoicous inflorescence which is very rare among the hepatics, the first two laws are as follows:—(1) Every paroicous species can become autoicous and even dioicous by abortion of one or other sexual organ. (2) Every autoicous species can become dioicous in the same way. But the converse of these laws is not true. And hence (3) when two species differ only by their inflorescence, they ought to form only one and the same species. It may possibly be the case that a synoicous species may become paroicous, autoicous, dioicous; but there is at present no evidence of this. There are but four kinds of inflorescence—synoicous, paroicous, autoicous, dioicous; and such other expressions as heteroicous and polyoicous have no value and do but serve to confuse the meaning. It is probable that these laws apply to the mosses also as well as to the whole group of the hepatics.

Social Groups and Adaptive Characters in the Bryophyta.¶—J. A. Wheldon publishes notes on some social mosses and on adaptive

* Philippine Journ. Sci., vi. (1911) pp. 65-92.

† Fedde's Repertorium, ix. (1911) pp. 422-7.

‡ Engler's Bot. Jahrb., xlv. (1911) pp. 345-404.

§ Journ. Linn. Soc., xl. (1911) pp. 237-41.

|| Rev. Bryolog., xxxviii. (1911) pp. 107-8.

¶ Lancashire Nat., iii. (1911) pp. 377-81, 105-8; also iv. (1911) pp. 1-3, 41-3, 75-82, 129-32, 155-63 (2 pls.).

characters in the Bryophyta. The gregarious mosses are able to cover large tracts of ground to the exclusion of almost all other plants, for example, *Rhacomitrium lanuginosum*, species of *Sphagnum*, forms of *Harpidium*, *Bryum* associations on sand-dunes, *Marsipella* associations on high mountains. In the chapter on the adaptive characters in the gametophyte, Wheldon discusses the protonema, the non-sexual methods of propagation, the gametophore; and then he treats of the sporophyte. The paper is of a very discursive character, teeming with field-notes and observations.

Allionella, a new genus.*—V. F. Brotherns describes and figures *Allionella*, a new genus of mosses discovered in Ecuador by M. Allioni. It is allied to *Meothesium*, and is distinguished by its numerous shortly-stalked sporogonia arranged along the upper part of the stem, with theca erect and peristome of regular structure. The one species bears the name *Allionella cryphæoides*.

Austinella, a new genus.†—R. S. Williams gives a description and figures of *Austinella*, a new genus allied to *Trichostomum*, but differing in having leaves with a broad clasping base, and with the upper cells angular and not papillose. It was originally found in Pennsylvania, and named *Syrhodon ? Rawei* by Austin in 1876.

Leucobryum glaucum.‡—E. M. Williams gives an account of the unattached cushions of *Leucobryum glaucum*, which are sometimes found under fir-trees and beech-trees, for example, in Fawley Woods, Hants. They lie loosely on the dead leaves, and are 1½ to 4 inches wide. He agrees with W. H. Burrell's explanation of their existence, that they are due to repeated disturbance by game-birds and other animals, whereby alternating growth takes place on the two flattened sides; and the water stored in the spongy tissue renders the tufts self-sustaining. But he wonders why the cushions are not more common.

Plagiothecium.§—C. Meylan publishes some researches on the monoicous forms of the *sylvatico-denticulatum* group of the genus *Plagiothecium*. The published opinions of leading bryologists being much at variance about the group, the author has collected material for years and is now able to give an exact opinion about the value of each of the forms in the group. The forms are divided into two series absolutely parallel, but differing in the width of the leaf-cells. Series i.: cells wide, 10–20 μ . Series ii.: cells narrow, 5–10 μ . To series i. belong the forms with long capsules contracted below the mouth and having a long neck; while to series ii. belong the forms with short capsules having a short conical or obtuse operculum. There is a correspondence between the form of the leaves (*acuminata* and *obtusifolia*) and that of the cells. The form *obtusifolia* always has the cells wider and shorter than those of *f. acutifolia*. The number of male flowers is more variable in series i. than in series ii. For the sake of clearness the forms in the group may

* Oefv. Finsk. Vet. Soc. Foerh., liii. (1910) 4 pp. (1 pl.).

† Bryologist, xiv. (1911) pp. 70–1 (figs.).

‡ Journ. of Bot., xlix. (1911) pp. 318–19.

§ Rev. Bryolog., xxxviii. (1911) pp. 67–9, 86–9, 109–12.

be arranged under two species, each with a sub-species, namely, Series i. *P. denticulatum*, with a sub-species, *P. lactum*; and Series ii. *P. Ruthei*, with a new sub-species, *P. pseudolactum*. Under each of these the author gives a parallelism of varieties and forms. He then supplies an analytical key showing the distinctive characters of all the principal varieties. In the narrow-celled group are *P. Roeseanum*, *P. denticulatum*, some varieties *P. lactum*, and some forms. In the wider-celled group are *P. sylvaticum*, *P. succulentum*, *P. Ruthei*, some varieties, *P. pseudo-lactum*, and some forms.

Polytrichum.*—E. M. Dunham publishes notes by J. F. Collins and others on a peculiar *Polytrichum* which agrees with *P. Smithiæ* Grout in its sporophytic characters, but is a depauperate *P. ohioense* in its gametophytic characters.

Lophocolea minor not a Species.†—I. Douin returns to the question whether *Lophocolea minor* is a good species, and shows various reasons for combating K. Müller's view that *L. minor* is distinct from *L. heterophylla* in having a dioicous and not a paroicous inflorescence, and in being propaguliferous. The inflorescence is not constant, but varies; and the presence of gemmæ is not a specific character but may occur in any species. The evidence all points to the conclusion that *L. minor* is but a propaguliferous form of *L. heterophylla*.

Metzgeria.‡—V. Schiffner publishes notes on certain neotropic species of *Metzgeria*, and gives valuable characters for distinguishing them from one another, namely, the inflorescence, branching, number of cortical cell-rows on the upper and lower sides of the midrib, structure of central strand of midrib, arrangement and length of hairs on midrib and wings, size and width of alar cells. On the other hand, such characters as fruit-branches, male branches, calyptra, sporogonial valves, spores and elaters, are of interest but of far less importance systematically. As to *M. dichotoma* (Sw.) Nees, it has been much confused. In Herb. Lindenberg at Vienna, eight out of eleven specimens referred to it belong to other species. He gives descriptions of *M. ciliata* Raddi, *M. Herminieri*, *M. bahiensis*, and critical notes on *M. leptomitra*, and on *M. leptoneura* Spruce. The latter he considers to be a variety of *M. hamata*.

British Bryophytes.§—C. A. Cheetham publishes notes upon about a dozen rare mosses gathered by F. Haxby and himself on the less frequented parts of the north-west side of Inglebrö'. The species concerned are of the type met with on the Lake District mountains. One is a new record for England, one for Yorkshire, and others for West Yorkshire.

W. Ingham || gives notes on some mosses and hepatics observed at Castleton, N. Yorks., during the dry weather of last Whitsuntide. Some are characteristic of the Swiddens and some of the Slacks.

* Bryologist, xiv. (1911) pp. 90-1.

† Rev. Bryolog., xxxviii. (1911) pp. 105-7.

‡ Oesterr. Bot. Zeitschr., lxi. (1911) pp. 183-7, 261-4.

§ Naturalist, No. 653 (1911) pp. 231-2.

|| Naturalist, No. 654 (1911) p. 248.

J. J. Marshall* records the occurrence of *Tortula Fahlii* at Cleethorpes, in North Lincolnshire. It occurs on mud dredged from a lock. It is a Mediterranean moss with a scanty distribution in the south of England.

Mosses of Haute-Saône.†—A. Copey continues his phytogeographic studies of the mosses of the Haute-Saône, and treats of the Physcomitricæ, Brycæ, Bartramiacæ, and Polytricheæ. He gives descriptions of a new species of *Fontinalis* and a new variety of *Mniobryum*. He calls attention to the occasional association of *Leptobryum pyriforme* with *Sphagnum*, and suggests that this may explain the frequent introduction of the former plant into greenhouses where much *Sphagnum* is used.

Hepatics of the Atlantic Islands.‡—G. Gola gives a list of forty-two species of hepatics collected by G. Negri in the Canary Islands in 1905. He adds one species (*Aneura pinguis*) to the recent records published by Bornmüller, Pitard and Corbière, and Bryhn, and increases the distribution-records of the various islands of the group.

E. Armitage§ publishes a note upon the presence in Madeira of *Frullania germana*, a species hitherto known only from the British Isles and Faroes. The Madeira specimens had previously been referred to *F. teneriffæ*.

North American Sphagnum.||—A. Le Roy Andrews begins a series of notes on North American Sphagnaceæ. He discusses the grouping of the species within the genus *Sphagnum*, and adopts Russow's two divisions: (1) *Inophlea* for the fibrillose-celled group, commonly known as *Cymbifolia*; and (2) *Litophlea* for the rest of the genus. The two groups are distinguished by sundry other characters. For instance, in *Inophlea* the cortical cells of the branches are homogeneous, the branch leaves are cucullate, and rough dorsally, and not toothed at apex. He rejects the ten sub-groups adopted by Warnstorf and others for the European species, since he finds them to be not applicable to the exotic species. The sub-groups shade into one another. Yet he would subdivide *Litophlea* into *Malacosphagnum* for the *Rigida* sub-group, and *Acisphagnum* for the *Cuspidata*.

North American Hepatics.¶—A. W. Evans publishes a second decade of notes on North American hepaticæ. The species concerned are *Riccia californica* Aust., *Neesiella pilosa* Schiffn., *N. rupestris* Schiffn., *Metzgeria dichotoma* Nees, *M. fruticulosa* Evans, *Scapania spitzbergensis* C. Müll., *Lopholejeunea atroviridis* (Spruce), *Ceratolejeunea integrifolia* Evans, *Brachiolejeunea bahamensis* Evans, *Caudalejeunea Lehmanniana* Evans. The most important of these is *Neesiella pilosa*, the relationships of which are still incompletely understood.

* Naturalist, No. 653 (1911) p. 238.

† Rev. Bryolog., xxxviii. (1911) pp. 112-19.

‡ Atti. R. Accad. Sci. Torino, xlvi. (1911) pp. 1004-8.

§ Journ. of Bot., xlix. (1911) pp. 303.

|| Bryologist, xiv. (1911) pp. 72-5.

¶ Bryologist, xiv. (1911) pp. 84-8.

Mexican Moss-flora.*—J. Cardot, in finishing his survey of the moss-flora of Mexico, points out that the actual number of Mexican mosses known is about 650, and may easily be doubled as time goes on. The moss-flora is closely related to that of the West Indies and Andes, and less intimately with that of the United States. It has but little in common with that of westerly regions in the same latitude—Hawaii, Formosa, Philippines. But curiously enough Mexico has some 20 species in common with India, and 14 others which are very closely allied with Indian species. The author adds critical notes on more than 50 species, which he is compelled to reduce to synonyms or to transfer to other genera.

Hepaticæ of the Bahama Islands.†—A. W. Evans gives an account of the hepaticæ of the Bahamas based on material collected for the New York Botanical Garden. Of the thirty-four species recorded, it is curious that thirty belong to the Jubulææ, namely to *Lejeunea* and *Fruillania*. The other genera represented are *Riccia*, *Marchantia*, *Plagiochila*, *Radula*, with one species each. Three new species are described and figured. The flora has but little in common with that of Bermuda—five species only.

Hepaticæ of Puerto Rico.‡—A. W. Evans publishes his tenth article on the hepaticæ of Puerto Rico, and devotes it to a careful account of *Cololejeunea*, *Leptocolea*, and *Aphanolejeunea*. Besides discussing each genus critically, and describing the species in detail, he gives a chapter to a description of the gemmæ in the three genera—a character very little studied, but showing great constancy. *Cololejeunea* contains about twenty species, two of which are treated here; *Leptocolea* includes about fifty known species, four of which occur in Puerto Rico; *Aphanolejeunea*, a new genus, with the Irish *A. microscopica* Tayl., as its type, contains about six species. In all the author describes three new species, re-describes several others, and makes critical allusions to numerous others.

New Zealand Hepaticæ.§—L. S. Gibbs publishes a list of forty-one hepaticæ collected by her near Auckland, in the northern island of New Zealand, in the spring season in 1907. The specimens were determined by F. Stephani, and include four new species—*Marchantia laceriloba*, *Aneura papulolimbata*, *Calobryum Gibbsiæ*, *Lepidozia Gibbsiana*. Some notes on habitat are appended.

Japanese Bryophytes.||—S. Okamura gives descriptions in German of the following seven new species of Japanese mosses: *Dolichomitra robusta*, *Cryphæa obovatocarpa*, *Dichelyma hatakeyanæ*, *Calliergon nakamuraæ*, *Astomum kiense*, *Dicranella salsuginosa*, *Meteorium cuspidatum*, and gives figures of most of them.

He also describes ¶ *Trichocoleopsis sarculata*, a new genus of hepatics,

* Rev. Bryolog., xxxviii. (1911) pp. 97–105.

† Bull. Torrey Bot. Club, xxxv. (1911) pp. 205–22 (2 pls.).

‡ Bull. Torrey Bot. Club, xxxviii. (1911) pp. 251–86 (2 pls.).

§ Journ. of Bot., xlv. (1911) pp. 261–6.

|| Tokyo Bot. Mag., xxv. (1911) pp. 134–44.

¶ Tokyo Bot. Mag., xxv. (1911) pp. 159–61 (1 pl.).

of which he has studied fertile material. The original material collected sterile by J. Bisset, was referred to *Blephurozia* by Mitten in 1891. It is distinguished from *Mastigophora* and *Ptilidium* by the lack of a perianth, from *Lepidolæna* by the form of the calyptra, amphigastria, and underlobes of the leaves, and from *Trichocolea* by the presence of rootlets, and by the form of the leaves and amphigastria.

Mosses of New Caledonia.*—V. F. Brothens publishes a third contribution to the moss-flora of New Caledonia, including descriptions of fifty-one new species.

Antarctic Mosses.†—J. Cardot gives a preliminary account of the mosses collected by M. Gain in the Antarctic during the French second Charcot Expedition. It is the richest bryological collection yet made in the Antarctic region proper, and comprises 34 species. It adds 3 genera (*Pottia*, *Rhacomitrium*, and *Philonotis*), 11 species (7 new to science) and 2 varieties (1 new) to the Antarctic flora, which now possesses 58 moss-species, divided among 24 genera and 13 families. The Antarctic flora is a poor one as compared with the Arctic, because the climatic conditions are so unfavourable to all vegetation. Nothing is known to occur south of 60° S. lat., whereas Peary collected 57 species between 81° and 82° in the Arctic regions. The present French Antarctic collection came from fourteen localities extending from the South Shetlands to Marguerite Bay, south of Loubet Land. Short descriptions of the 7 new species are appended to the list.

Thallophyta.

Algæ.

(By MRS. E. S. GEPP.)

Physiology of Diatoms.‡—T. Meinhold discusses the physiology of the Diatoms, and especially their cultivation in coloured light. He finds that there are for Diatoms two maxima of assimilation, just as there are for green algæ; and the first maximum lies in the red light of the spectrum, and the second lies in the blue-green for Diatoms, and in the blue for green algæ. The heights of the assimilation in the red and blue light the author is unable to compare. In the blue-violet region of the spectrum, with a given supply of energy, both these groups of algæ exhibit a sinking of the assimilation curve from the maximum out towards the violet end. In addition to the strength of the incident light-rays, the wave-length of the rays has a determining influence on the amount of assimilation.

Phycocerythrin and Phycocyanin.§—H. Kylin gives a detailed account of the phycocerythrin and phycocyanin found in *Ceramium rubrum*. The names of these pigments were proposed by Kützing in 1843, and the pigments have been studied by many authors. Kylin

* Öfv. Finsk. Vet. Soc. Foerh., liii. (1910) 42 pp.

† Comptes Rendus, cliii. (1911) pp. 599-603.

‡ Colm's Beiträge z. Biol. Pflanz., x. (1911) pp. 353-78 (1 pl.).

§ Hoppe-Seyler's Zeitschr. f. Physiol. Chemie, lxix. (1910) pp. 169-239 (1 pl. and 2 charts). See also Nuov. Notar., xxii. (1910) pp. 97-9.

describes his method for obtaining pure solutions of the pigments, and then discusses their various physical and chemical characters. The two bodies are of a proteid nature, and Kylin suggests the name phycochromoproteids for them. Both are insoluble in pure water, but dissolve after the addition of a minute quantity of alkali or neutral salt; by boiling or by the addition of an adequate proportion of acid or alkali the albuminoid components are separated off from the coloured components.

Effect of Light on Algæ.*—P. A. Dangeard gives the results of his investigations of phototactism, assimilation, and phenomena of growth, by means of special apparatus. As to phototactism, he distinguishes two quite different types:—(1) that of the Euglenæ, which seek the most refrangible rays of light; (2) that of the Oscillariæ, which range themselves under the less refrangible rays. He finds that it is only under the action of certain rays determined by the coloured screens that the oxygen bubbles are formed on the filaments of algæ; under other rays *Mesocarpus*, for instance, turns black. As to growth, he states that in the case of *Chlorella vulgaris* it is the chlorophyll absorption-band situated at B and C which is effective in growth as well as in assimilation. Finally, he says that the spectrogram of a culture of a sulphur-bacterium, probably *Thiocystis violacea*, shows the same characters of development as does *Chlorella*, and behaves like a green alga.

Nuclear Autochromatism in Algæ.†—P. A. Dangeard publishes a note on an instance of nuclear autochromatism in a Desmidiæan genus *Penium*. In some cultures injured by excessive solar energy certain cells had been killed, and had the appearance of having been subjected to a fixing reagent, showing all the details of their nuclear structure. After death the pigment had played the role of a staining reagent. The researches are to be pursued further, in order to determine whether other algæ can stain their protoplasm.

Algal Figures on Culture Flasks.‡—M. Molliard gives an explanation of the vertical lines designed by various aquatic algæ on the sides of glass culture-flasks standing near windows. Dangeard had experimented with *Chlorella*, and explained the vertical striæ of the plant deposit as being due to local intensity of light. Molliard admits this factor, but shows that gravity also intervenes as an explanation of the solely vertical vegetation of the algæ. Dangeard, in reply, finds it natural enough that gravitation should have some influence in the matter; but, as luminous intensity and the nature of the radiations play a very active part, he holds that each of the three factors should be studied in each particular case.

Anatomy of Polyides and Furcellaria.§—G. Denys gives an account of his investigations of the anatomy of *Polyides rotundus* and *Furcellaria fastigiata*, two algæ which, in the absence of reproductive organs and

* Bull. Soc. Bot. France, lvii. (1910) 17, pp. 315-19.

† Bull. Soc. Bot. France, lvii. (1910) pp. 453-5.

‡ Bull. Soc. Bot. France, lvii. (1910) p. 519.

§ Beih. Jahrb. Hamburg Wiss. Anstalt, xxvii. (1910) pp. 1-31 (figs.)

holdfast, are not easy to distinguish. R. Caspary* showed how the sterile plants may be separated by their microscopic structure. The present author has studied and compared the tissues and cells of both plants in all parts of the thallus, and treats his subject under the following headings:—morphology, anatomy of tissue, and anatomy of cells (including cell-wall, chromatophores, starch, nucleus, crystals, vacuole-bodies, special nature of cell-contents). He states that the distinctions pointed out by Caspary are complete enough, but can be somewhat supplemented. *Polyides* has a regular structure, and shows a gradual transition in its tissues; its smaller cortical cells are in two to four layers (not four or five); and transverse hyphæ, which traverse medulla and cortex, occur but solitary-wise. *Furcellaria*, on the other hand, has a less regular structure, its tissues presenting almost an abrupt transition: its smaller cortical cells constitute one layer, rarely two layers (not two or three, rarely more, as Caspary stated); and transverse hyphæ pass in considerable number through the medulla and large-celled cortex. In cell-structure there is much in common between the two genera. But a distinction is found in the cell-walls: in *Polyides* the middle lamella is strongly coloured by methylen-blue and ruthenium-red, whereas in *Furcellaria* the middle lamella remains absolutely colourless. Denys adds a chapter on cicatrization in the two genera, and a final one on endophytes. In *Furcellaria* he found a brown filamentous endophyte which he refers to *Microsipharia*, and describes under the name *M. Furcellariæ*, a new species.

Florideæ.†—C. J. Connolly has made a detailed examination of six species of Florideæ, collected by Goebel in New Zealand and south-west Australia. His interesting and important results are given in a summary under the headings of the different species. It runs as follows:—*Polysiphonia decipiens*. 1. Lateral branches arise from the base of the monosiphonous leaves without precise divergence. 2. The female organs arise at the second segment of the leaves. 3. The procarp consists of the following component parts: (*a*) a 4-celled carpogonial branch; (*b*) a 1-celled inferior accessory branch; (*c*) a 2-celled lateral accessory branch, which all arise out of the pericentral cell. 4. As the result of fertilization the pericentral cell cuts off a special auxiliary cell above, and the accessory branches divide further. 5. The carpegonium cuts off a cell at its base, which is to be regarded as the conductor of the fused nucleus to the auxiliary cell. *Asparagopsis armata*. 6. Primary branches arise with a $\frac{1}{4}$ -divergence. They all grow out to short branches (Kurztriebe). Secondary branches arise obliquely opposite the primary branches, and grow out to long branches (Langtrieben) or branched Kurztrieben. 7. The arrangement of the lateral branches cannot be explained by Schwendener's contact theory, but must be referred to internal causes. 8. An indirect, but no direct plasma connexion exists between the neighbouring cells of the central axis. 9. As regards the laterally situated pores of the central axis, which usually occur on the upper portion of the segment, the nearer they are to the apex the deeper they

* Ann. Mag. Nat. Hist., vi. (1850), chap. ix.

† Flora, ciii. (1911) pp. 125-70 (2 pls.).

lie in the segments, so far as the cystocarpic branches are concerned. 10. The auxiliary cell, which before fertilization is not specially marked, is the cell next the Tragzelle, i.e. the second cell from the axil-cell. It is probably identical with the third cell of the branch, reckoning from the carpogonium, which makes the carpogonial branch only 2-celled. 11. The auxiliary cell fuses with the Tragzelle; the process of fusion is so lengthy, that the surrounding tissue is absorbed and reaches as far as the third cell of the central axis. 12. The organs of attachment are short thickened shoots. The Langtriebe, which normally stand opposite the Kurztriebe, wither. *Euzoniella incisa*. 13. The cystocarps arise generally on the lowest side-shoot of a Kurztrieb; they may also arise on the penultimate side-shoot. 14. The procarpia arise on the second segment of the side-shoot of the Kurztrieb. *Rhabdonia verticillata*. 15. *R. verticillata* grows by means of a three-sided apical cell. 16. The cystocarp has been found, and its position is embedded in the thallus. 17. One-celled colourless hairs occur. They must be regarded only as a secondary transitory character. *Erythroclonium Muelleri*. 18. The branches which grow out from the central axis, are not in two rows as Harvey states, but in four rows. 19. There is a secondary growth in thickness at the base of the principal shoot and the place of egress of the larger branches. The layers are not to be regarded as annual rings, but as elements of solidity. *Rhabdonia globifera*. 20. The growth of *R. globifera*, unlike that of *R. verticillata*, which has a single apical cell, belongs to the "Springbrunnen-type." Its position in the genus *Rhabdonia* is therefore hardly to be maintained. 21. Although, in general, attempts to prove a direct plasma connexion have only given negative results, the fact has been established in certain cases.

Erythrocladia.*—N. Svedelius gives an account of *Erythrocladia irregularis* Rosenv., which he found growing epiphytically on *Furcellaria fastigiata*. It was first described in 1909 as a Danish alga; its distribution now includes Sweden.

Batrachospermum growing on Molluscs.†—G. Bignotti publishes a note on the occurrence of two forms of *Batrachospermum* found growing on shells of *Planorbis* in freshwater pools near Modena in the spring of 1908, and cites similar records made by Teodoresco and Lemmermann.

Colpomenia sinuosa.‡—A. D. Cotton gives an account of the increase of *Colpomenia sinuosa* in England. It is a brown alga of the Indian Ocean and the warm Atlantic, and in recent years has migrated up the west coast of Europe. On our coasts it was first noticed in the Scilly Islands in August 1905, in Cornwall in the following year, spreading later to Devon and Dorset. It does not appear to have travelled east of Poole harbour. In the counties mentioned it occurs in considerable abundance in suitable stations. It is an inhabitant of sheltered waters, and it reaches its maximum development in the winter months. It grows epiphytically upon quite a number of algae or attached to rocks

* Svensk. Bot. Tidsskr., v. (1911) pp. 217-18.

† Atti Soc. Nat. Modena, ser. 4, xii. (1910) 2 pp. See also Nuov. Notar., xxii. (1911) p. 90.

‡ Kew Bulletin, 1911, pp. 153-7.

or shells. Balloon-like in shape it sometimes contains air, and breaking away floats on the surface of the sea. It has been accused of thus lifting and transporting young oysters from their culture beds.

Dichotomosiphon and Mischococcus.*—J. Virieux publishes a note on *Dichotomosiphon tuberosus* (A. Br.) Ernst and *Mischococcus confervicola* Naeg. The former plant, new to France, he found in good fruiting condition near Besançon. He also treats of *Mischococcus*, which had not been recorded for France except once in the north.

Freshwater Algæ of the Clyde Area.†—R. Garry publishes some recent additions to the freshwater algæ of the Clyde area. New to the region are the following:—*Bulbochæte mirabilis*, *Microthamnium Kuetzingianum*, *Microspora floccosa*, *Spirogyra bellis*, *S. nitida*, *Choaspis stictica*, *Spirotænia condensata*, *Desmidiium swartzii*.

Pleurococcus sulphurarius.‡—E. Clerici writes on some specimens gathered in the Valle del Bove on Mount Etna. On one of the pieces of lava found near a fumarole was a patch of green alga, possibly the undescribed *Protococcus vulcanicus* recorded by Cesati from the Solfatara of Pozzuoli in 1869, and described by Galdieri in 1899 under the name *Pleurococcus sulphurarius*.

Clathrocystis.§—G. B. De Toni writes about an extraordinary development in Lago di Como of an alga harmful to fishing. This occurred in October 1909, and was due to *Clathrocystis æruginosa*. Similar developments have been recorded by Besana for 1898 and 1908.

Breaking of the Meres.||—J. Burton publishes a note on two instances of the "breaking of the meres," one in a pond at Totteridge on July 10, 1909, the other in the Welsh Harp reservoir. The algæ concerned were *Oscillatoria decolorata* West in the former case, and *O. Agardhii* Gom. in the second.

Fossil Diatoms in Italy.¶—E. Clerici gives an account of the species found in the diatomaceous earth occurring near Lago di Avigliana—some fifty species chiefly belonging to the genera *Cymbella*, *Navicula*, *Gomphonema*, *Epithemia*.

He also ** points out the importance which diatoms present in the study of geology. He indicates, for instance, three types of diatomiferous strata in the environs of Rome (1) with brackish species; (2) with Cyclotella, especially *Stephanodiscus Astræa*; (3) with species of *Epithemia* prevalent.

He also †† gives a microscopic analysis of the calcareous deposit at

* Bull. Soc. Hist. Nat. Doubs, No. 19 (Jan. 1910) (1 pl.).

† Glasgow Nat., ii. (1909) pp. 13-14.

‡ Boll. Soc. Geol. Ital., xxviii: (1910) pp. cevi-vii (1 pl.).

§ Revista Mensile di Pesca e Idrobiologia, v. (1910).

|| Journ. Quekett Micr. Club, xi. (1910) pp. 115-20. See also Nuov. Notar., xxii. (1911) p. 90.

¶ Boll. Soc. Geol. Ital., xxvi. pp. cxliii-iv (1 pl.).

** Boll. Soc. Geol. Ital., xxviii. (1910) pp. 649-76.

†† Boll. Soc. Geol. Ital., xxvi. pp. 557-66 (1 pl.).

S. Demetrio nei Vestini (Prov. Aquila). It is rich in diatoms and sponge-spicules; and the diatoms are of the *Cyclotella* type and of the *Coscinodiscus* type.

Ceratium.*—E. Joergensen publishes a monograph of the genus *Ceratium*, in which he maintains four sub-genera—*Poroceratium*, *Bicerratium*, *Amphiceratium*, *Euceratium*, and gives descriptions of the species and varieties with their respective distributions. A detailed bibliography is appended.

Kammerplankton.†—R. Kolkwitz writes on the Kammerplankton of fresh-water and of the sea. Taking the cubic centimetre as his unit of measurement, he employs a plankton-chamber-slide of that capacity for the quantitative estimation of the plankton in a given water; or at a given depth in that water. He is able to determine directly and quickly under the Microscope the actual condition of the water in relation to organisms, organic and mineral detritus.

Arctic Plankton.‡—C. H. Ostenfeld gives an account of the marine plankton from the east Greenland sea (west of 6° W. Long. and north of 73° 30' N. Lat.), collected during the 'Danmark' Expedition of 1906–8. He enumerates forty-two diatoms and six Flagellatae, one of which is new, *Poutosphaera borealis*.

Plankton of Prester See, near Magdeburg.—II. Homigmann § gives an account of the plankton of the Prester See, by Magdeburg, a subject of which he has treated previously. || The plankton contains *Chaetoceras*, *Acanthoceras*, *Oscillatoria*, *Genicularia*, *Tetraspora*, *Chaetopeltis*, *Auhiphora*, *Bacillaria*, etc. A bibliography of 264 papers is appended.

Vegetation of Upper Rhine.¶—R. Lanterborn gives an account of the vegetation of the Upper Rhine, the biological conditions of the Rhine stream, the plankton, the so-called Altrheine, which accompanies the river from Basel to Oppenheim, the biological characteristics of the Upper Rhine. He also makes observations on several species of the region of the Upper Rhine and Lake Constance.

Plankton of Lago Maggiore.**—M. de Marchi publishes an introduction to the biological study of the Verbano or north end of Lago Maggiore, in which he shows how much preparatory work has been already done, and what lacunae remain in the study of Lago Maggiore. He gives a systematic enumeration of the species, with the names of the authorities for their existence in the Verbano.

* Die Ceratien. Leipzig: Klinkhardt (1911) 124 pp. (10 pls.).

† Ber. Deutsch. Bot. Gesell., xxix. (1911) pp. 386–402.

‡ Danmark-Exped. til Groenlands Nordøstkyst., 1906–8, iii. n. 11 (Köbenhavn, 1910).

§ Abh. Ber. Mus. Natur. Magdeburg, ii. (1910) pp. 1–39 (1 pl.). See also Nuov. Notar., xxii. (1911) pp. 95–96.

|| Arch. Hydrobiol. u. Planktonk., v. (1908) pp. 71–8 (2 pls. and figs.).

¶ Verh. Nat. Med. Verein Heidelberg, x. (1910) pp. 450–502 (figs.).

** Rendiconti R. Ist. Lombard., xliii. (1910) pp. 698–719. See also Nuov. Notar., xxii. (1911) p. 99.

Marine Algology.*—A. Mazza continues his studies of marine algology, and treats of the following genera:—*Callithamnion*, *Sairospora*, *Compsothamnion*, *Spongoecoloniun*, *Haloplegma*, *Euptilota*, *Ptilota*, *Plumaria*, *Dasyphila*, *Muellerena*, *Psilothallia*, *Bollia*, *Antithamnion*.

Marine Algæ of Kamerun.†—R. Pilger gives an account of the marine algæ of Kamerun collected by C. Ledermann. The localities searched were Victoria, Kl. and Gr. Bataunga, Elabi-Hende, Kribi, Bodje, Campo. The number of species recorded is forty-five, ten of which are new. The author discusses the morphology of the species and their distribution. The Cladophoraceæ were determined by F. Brand.

Fungi.

(By A. LORRAIN SMITH, F.L.S.)

Notes on Mucorini.‡—Fernand Moreau gives an account of the history of some Mucorini, with special reference to the nucleus. The latter he has studied under various aspects: in the resting stage it consists of a nuclear membrane, nucleoplasm, a chromatic mass, and a nucleolus which may be either central in position, excentric, or lying against the internal wall of the nucleus. Karyokinesis in this group was also studied by Moreau; it is characterized by the presence of a spindle, two centrosomes, two chromosomes, and by the absence of the nucleolus and the nuclear membrane. The disappearing of the nucleolus is peculiar to the *Mucorini* among fungi. The absence of the nuclear membrane distinguishes them from the Ascomycetes and Siphomycetes. Amitosis or direct division was also noted.

Notes on Hypocreaceæ.§—René Maire divides this family into the genera *Pyxidiphora*, *Peckiella*, *Hypomyces*, and *Nectriopsis* g. n., the latter intermediate between *Hypomyces* and *Nectria*. Maire insists on attention being paid, in this group, to the form, septation, and ornamentation of the ascospore. In some genera an apiculus is always present, in *Nectriopsis* it is always absent. It should also be stated, in any description, whether the spores have been studied in water, in some special medium, or dry. Figures are given of the spores.

Study of Laboulbeniales.||—J. H. Faull describes the structure of thallus and fructification in several species of Laboulbeniales. The spores are uninucleate at first, then become bi-nucleate before maturity. The entire plant-body is enclosed by a thin chitinous membrane; the walls of the cells are thick and laminated.

Antheridia are exogenous as in *Zodionomyces*, or endogenous as in *Laboulbenia*; usually they are borne on the same plant as the female organs. Spermatia are formed as short lateral branches of the antheridia, probably several in succession. The one nucleus almost fills the entire cell. The procarp begins as a single uninucleate cell, an outgrowth

* Nuov. Notar., xxii. (1911) pp. 53-80, 109-39.

† Engler's Bot. Jahrb., xlv. (1911) pp. 294-323 (26 figs.).

‡ Bull. Soc. Mycol. France, xxvii. (1911) pp. 204-10.

§ Ann. Mycol., ix. (1911) pp. 315-25 (1 pl.).

|| Ann. of Bot., xxv. (1911) pp. 650-4.

from the receptacle; it develops into a structure consisting of carpo-gonic cell, trichophoric cell, and trichogyne. The latter is mostly unicellular, though in some cases branched and septate. The carpo-gonium becomes binucleate, though the process was not seen, and the trichogyne degenerates. Stages of ascus and spore-formation are also described, with the relation to the host, etc.

Infection by Ergot Spores.*—R. Falck gives the results of his studies on the subject of spore dispersal, especially in *Claviceps purpurea*, by the agency of air currents. Spore-ejaculation from the asci is aided both by the form of the ascus and the uniform size of the spores. The spores of *Claviceps* are carried by the wind to the developing flower. As the wind blows in a parallel plane to the earth, the spores are carried along great distances at the same level.

Mildew of Cherries.†—Fr. Muth states that owing to the cold summer of 1910, the fungus *Sphærotheca pannosa* spread widely on cherry trees. The mildew, which is also found on apples, is described, and remedial measures are suggested, such as pruning back the twigs attacked in the early part of the year, burning all fallen wood, and spraying with Bordeaux mixture. Sprinkling with sulphur as soon as the disease appears is also recommended.

Sphærotheca Castagnei Lév.‡—O. Winge has studied this fungus about which there has been much controversy in regard to the occurrence in it of fertilization. According to the results obtained by him, the organs which are formed before the perithecium are sexual organs, which are, however, entirely functionless. The antheridium has a great affinity for the oogonium, and frequently the two organs are closely united, but no fusion has ever been observed between them. He holds that the male nucleus does not pass into the female cell, the latter developing parthenogenetically. It is desirable to study further the behaviour of the chromosomes.

Experimental Researches with Uredineæ.§—E. Mayor records the results of various experimental cultures with teleutospores taken from several species of *Carex* and infected on *Ribes alpinum*, *R. Grossulariæ*, etc. He was not quite decided whether he was dealing with one or several species of *Puccinia*, nor whether the Uredine was the same as those described by Klebahn. Mayor also made experiments with the acidiospores of *Puccinia longissima* on *Endophyllum Sedi*, and with those of *Crepis biennis*, which he proved to be associated with the teleutospores of *Carex muricata*. He describes very carefully the different spores of the life-cycle of *Puccinia Actææ-agropyri*, and the experiments undertaken to test the different stages of growth.

Jakob Eriksson || publishes a preliminary note on his investigations

* Zeitschr. Forst.-Jagdsw., 1911, pp. 202-27 (4 figs.). See also Bot. Centralbl., cxvii. (1911) pp. 195-6.

† Zeitschr. Wein-Obst-Gartenbau, vii. (1910) pp. 165-9 (3 figs.). See also Bot. Centralbl., cxvii. (1911) p. 224.

‡ Bull. Soc. Mycol. France, xxvii. (1911) pp. 211-19 (2 pls.).

§ Ann. Mycol., ix. (1911) pp. 341-62 (figs.).

|| Centralbl. Bakt., xxxi. (1911) pp. 93-5.

of the rust *Puccinia malvacearum*, of which the principal host is *Althea rosea*, and after that *Malva sylvestris*. It has been found also on a large series of malvaceous plants. Eriksson considers that the disease is spread by means of diseased seeds, or by seedlings grown upon such seeds. He refers the disease to the existence, in the first place, of a mycoplasma in the seed, and he describes the process of growth from the plasma condition to the mycelium. He describes also the further infection of other plants.

P. Dietel* publishes the results of infection experiments with three Uredineæ, of which the *Cœoma* generation is found on *Larix europæa*, and of which the spores all germinate at low temperatures. They differ in other respects very widely: in the time required from germination until the production of the promycelium, and also in the influence exerted on the spores by a long drying process. The species studied were *Melampsora Larici-capreaeum*, *M. Tremulæ*, and *Melampsorium Betulinum*.

Dissemination of *Puccinia graminis*.†—Experimental investigations have been made by F. J. Pritchard to explain the dissemination of *Puccinia graminis*. He gives an historical sketch of the subject, and explains the methods adopted for the purpose of studying this question. He then sums up as follows:—1. *P. graminis* passed readily from wheat, *Agropyron tenerum*, *A. repens*, *Hordeum jubatum*, and *Elymus triticoides* to the barberry. 2. Observed facts seem to oppose the theory that acidiospores and uredospores are carried considerable distances by wind. 3. Uredo pustules of *Puccinia graminis* appeared on winter wheat at the same time as on grasses near the barberry bushes, and earlier (with one exception) than on grasses remote from the barberry. 4. *P. graminis* did not appear to spread to wheat by aid of the grasses. There are three distinct biological forms. 5. Uredospores of *P. graminis* failed to survive the winter 1904-5 at Fargo, North Dakota. 6. The wintering of *P. graminis* as mycelium in plant tissues in North Dakota is very doubtful. 7. The pericarp of rusted wheat is frequently filled with rust mycelium and numerous pustules of teleutospores. 8. Teleutospores in some of the germinating grains appeared to be germinating in a *Palmella*-like stage. 9. Pieces of mycelium resembling rust were found in the cells of the scutellum close to the growing plant.

Sexuality of Uredineæ.‡—L. Kurssanow reviews this question in the light of the work done on the subject by Blackman, Christman, and Olive, and he then proceeds to give his own observations. The material of *Puccinia Peckiana* Howe, with which he worked, was collected near Moscow, and he describes carefully the sections cut through all the different stages of development, and gives the results of his research. He finds in this species a conjugation of two entirely similar gametes. Olive had described the conjugating cells in the species examined by him as being always a large cell with a small one. Kurssanow thinks that the difference of the species may account for the variations recorded, and he also suggests that the passing over of the nucleus may be a pathological

* Centrabl. Bakt., xxxi. (1911) pp. 95-106.

† Bot. Gaz., lii. (1911) pp. 169-92 (1 pl.).

‡ Zeit-schr. Bot., ii. (1910) pp. 81-93 (1 pl.).

phenomenon. He found, also, that sterile cells were formed by each row in the æcidium, and there could be no consideration of a trichogyne formation. He does not think there is any comparison here with fertilization in the Floridæ. Occasionally there are no sterile cells formed, and in any case they could only be looked on as "buffer" cells.

New Smut in a New Genus of Grass.*—The new grass is *Sargol stipoides* Ewart and White, one of the group of Agrostidæ; the fungus *Ustilago Ewartii* McAlp. D. McAlpine recalls the statement made recently by himself that—"In West Australia only those species (of smut) are known which attack cultivated crops, and those occurring on the native flora have yet to be discovered." The present new species is therefore the first of its kind: it approaches *U. Pepperi* Ludw., but differs from that species in several characters.

Bunt-spores in Meal, Bran, and Grain.†—G. Bredeman has estimated the percentage of *Tilletia* spores in these substances. He gives an account of the manner in which the counting is done and the results obtained.

Studies of Hyphomycetes.‡—P. Vuillemin defines more exactly the genus *Monilia*. The chains of spores in this genus are formed by the transformation of the cells of the hypha into globular spores. Some species included in this genus by various authors have been placed in *Scopulariopsis* owing to the different manner of conidial formation. Descriptions are given of *Acnosporium* and *Catenularia*, which are compared with *Monilia*.

A. Sartory and G. Bainier § publish a note on a species of *Penicillium* which grows as a yellow form on potato, carrot, etc., but when transferred to pepton media, such as soup or gelatin, becomes emerald-green. They compare this change of colour with that noted in certain bacteria that take a blue coloration in pepton cultures.

The same authors || have published a note on the differential characters of *Penicillium*, *Aspergillus*, and *Citromyces*, with special reference to the last-named, which possesses the property of transforming glucose into citric acid. They consider *Citromyces* morphologically connected with both genera, resembling *Penicillium* when young and *Aspergillus* when mature.

J. Bosell ¶ made cultures of *Aspergillus niger* mould on artificial solutions in order to test various growth-phenomena. He found that the secretion of inulase was remarkably constant in all the solutions, and that it diffused easily in the cultures. The optimum of acidity varies with the temperature, being more feeble with a rise of temperature. Other results were obtained and are recorded.

* Proc. Linn. Soc. N.S. Wales, xxxvi. (1911) pp. 45-6 (1 pl.).

† Landw. Versuch., lxxv. (1911) p. 135. See also Bot. Centralbl., cxvii. (1911) pp. 142-3.

‡ Bull. Soc. Mycol. France, xxvii. (1911) pp. 137-52 (figs.).

§ C.R. Soc. Biol., lxxi. (1911) p. 229-30.

|| C.R. Soc. Biol., lxx. (1911) pp. 873-5.

¶ Ann. Inst. Pasteur, xxv. (1911) pp. 694-704.

Contribution to the Study of Fumagines.*—G. Arnaud has just published the second part of his study on these leaf-fungi. He considers that the Capnodiaceæ should be broken up and the species assigned to the Sphaeriaceæ. He gives descriptions of species and the reason for their transference.

Cultures of Mixed Fungi.†—R. Harder has studied the effect on pure cultures of fungi of adding other fungi to the substratum on which they were growing. The influence was in many cases very marked: in some cases it hastened the growth of both organisms, in others it checked development (*Penicillium glaucum* and *Botrytis cinerea*). When one or the other gained the upper hand, the growth was more vigorous than that of the pure cultures. It was found that the fungi differed greatly in their sensitiveness to chemical and physical attraction, and also that Hyphomycetes originated more active products of metabolism than the Basidiomycetes. Other results were obtained and duly recorded.

Notes on the Larger Fungi.‡—P. Baccarini records the growth of *Dædalea unicolor* on *Acer rubrum*. The fungus is usually regarded as a parasite, but in this instance it grew on a living tree and gradually destroyed it. Baccarini describes the effect of the fungoid growth on the woody tissues, and suggests that it may have gained entrance by a wound, and then lived on and so destroyed the wood of the tree.

Bresadola§ publishes a series of notes on species of *Corticium*, *Odontia*, *Pentophora*, etc. He insists that *Boletus fulvus* Scop. is the same fungus as *Polyporus pomaceus* Pers., and that the former specific name should be retained. He describes a new genus, *Jaapia*, a member of the Corticeæ, with straw-coloured appendiculate spores.

Development of Basidia.¶—Hans Knief made cultures of *Armillaria mellea* and found that basidia arose from uninucleate hyphæ, either terminally or as side branches without any formation of pileus or gills. These basidia can be recognized by their clavate form, rich contents, and larger nucleus. The nucleus divides twice mitotically, and the different division stages are described in detail. The resulting four nuclei each have a small nucleolus. From the basidium, the sterigmata bud out to form spores at the top into which a nucleus passes. The spores are absolutely normal and similar to spores formed on the gills of the pileus. Knief has compared the nuclear divisions throughout with those of the pileus basidia, the nucleus of the latter differing in having arisen from the copulation of two spores. He finds that the process is the same in both cases. He discusses fully the significance of this.

Spore-formation in Nidularia.¶—Rob. Fries has followed the various stages of nuclear division and finally of spore-formation in

* Ann. École Nat. Agric. Montpellier, sér. 2, x. (1911) pp. 211-30 (29 figs.). See also Ann. Mycol., ix. (1911) p. 435.

† Nat. Zeitschr. Land.-Forstw., ix. (1911) 34 pp. (2 pls.). See also Ann. Mycol., ix. (1911) p. 443.

‡ Bull. Soc. Bot. Ital., 1911, pp. 100-4.

§ Ann. Mycol., ix. (1911) pp. 425-8.

¶ Zeitschr. Bot., iii. (1911) pp. 529-33 (2 pls.).

¶ Zeitschr. Bot., iii. (1911) pp. 145-65 (2 pls.).

Nidularia pisiformis. He describes the developments of the fruiting body with its peridiola. He found two nuclei in all the cells of the hyphae, fusion taking place in the young basidium, the fused nucleus being very much larger. He describes the subsequent nuclear divisions resulting in the formation of four daughter-nuclei which pass up into the newly formed spores, and there each one divides again so that the spore is always bi-nucleate. It is noteworthy that the nucleus had already begun to divide before it passed through the narrow sterigma into the spore. Comparison is made with nuclear divisions and spore-formation in other fungi.

Mycological Notes.*—In a series of letters, C. G. Lloyd has published lists of specimens sent to him from many localities. He also gives an account of his work on the Polyporoid types of Lévillé at Leiden, and of the Junghuhn types in the same museum. He found there coloured drawings of many tropical Javanese fungi, which were meant for publication but never made use of.

Fungus parasitic on Citrus White Fly.†—The fungus, as described by H. S. Fawcett, forms on the under side of an orange leaf in larvæ of the white fly a chocolate-brown stroma, and was originally called by Webber the "brown fungus." It has been recently identified as a form of *Egerita*, the sporodochia developing on the brown stromata. Larvæ were successfully infected by the fungus.

Leaf-spots of Currant.‡—Ernst Voges has made inoculation cultures of a *Mycosphærella* sp., the fungus of currant leaves, and has obtained the pycnidial form *Phyllosticta*. The latter was identical with *P. Grossulariæ* on gooseberry leaves, and with *P. ruborum* and *P. rubicola* on raspberry leaves. The leaf-spots formed varied considerably in appearance and their diagnostic value was very small. It was also observed that several parasitic species attacked the same leaf, the weakness induced by one parasite having encouraged the development of others.

Physiology and Pathology of Hevea brasiliensis.§—T. Petch has published a handbook for the use of planters on the management of *Hevea*, the principal rubber tree. The latter part of the book deals with the diseases to which it is subject. In Chapter IX. are described the leaf-diseases due to the fungi *Helminthosporium Hevæ* and *Glæosporium Hevæ*, both of them discovered and described by the author. Root diseases are discussed in Chapter X., *Hymenochæte noxia* being the commonest, though *Fomes senitostus* is the most deadly. The fruit and stem suffer from *Phytophthora Faberi*. Pink disease of stem is due to *Corticium salmonicolor* and die back to *Botryodiplodia Theobromæ*. Moulds grow on prepared rubber, but as they do not attack the caoutchouc they are harmless. Other fungi are recorded and described that are probably saprophytic.

* Letters, 27-29 (1910) : 30-7 (1911).

† Science, n.s. xxxi. (1910) pp. 912-13.

‡ Centralbl. Bakt., xxx. (1911) pp. 573-9 (5 figs.).

§ London : Dulau and Co., Soho Square (1911) 268 pp. (16 pls., 1 col. .

Diseases of Plants.—C. W. Edgerton* notes two new diseases of *Ficus Carica*. One which induces canker of the branches is due to *Tubercularia Fici* sp. n. The other is caused by *Corticium lætum*; it attacks the ends of the branches, and spreads backwards.

Edw. C. Johnson† examined the wheat crop of the south-west States of North America to find the reason of the reduced yield. He found that two fungi had attacked the cereal, *Stemphylium Triticum* and *Puccinia graminis*.

W. McRae‡ has published a report on the blister blight of tea caused by the fungus *Erobasilium vexans*. The leaves attacked are often covered with the white blisters, and are rendered valueless; often the whole bush suffers. Only young leaves are attacked; these should be plucked and destroyed.

Flora Patterson, W. Charles, K. Vera, and F. J. Veibmeyer.§ publish an account of some fungous diseases of economic importance. *Karakamia Cyperi* Miyake, a near ally of *Phytophthora*, was introduced from Japan. It grew on *Cyperus tegetiformis*. A case of witches'-brooms on *Phyllostachys* was due to an ascomycetous fungus, with perithecia on a sclerotium and *Cladosporium*-like conidia. The authors consider they are dealing with a new genus, *Loculistroma*. A species of *Glomerella* was found on Cyclamens, and on pine-apples *Thielaviopsis parviflora*. They treated the fruit with formaldehyde to protect it against infection.

A leaflet|| has been issued dealing with *Sclerotinia* disease of the Gooseberry. The bush may be attacked on the stem, branches, leaf, or berry; death follows a severe attack. The disease shows itself by minute tufts of grey-looking *Botrytis* fructifications, or by the presence of sclerotia. All dead or dying bushes should be burnt. Spraying has also been proved to be effective.

Fr. Bubak¶ describes a new disease of Mulberry. Dead branches of the tree had been found to be the substratum of a number of microscopic fungi, among others of a species of *Thyrococcum*, and, associated with the latter, perithecial bodies, which he has placed in a new genus, *Dothiorellina*.

G. Köck** publishes observations made on the growth of *Monilia* and of *Sphaerella sentina* (white-spot) on fruit-trees. In the case of both fungi certain varieties of pear were susceptible to the fungi, others were entirely free. The author thinks it possible that the results obtained may be true for one locality only.

R. Laubert†† discusses the nomenclature and life-history of a parasite of apple-trees. There is a *Phoma*-like perithecium, but the

* Phytopathology, i. (1911) pp. 12-17 (1 fig. and 1 pl.). See also Ann. Mycol., ix. (1911) p. 306.

† Phytopathology, i. (1911) pp. 18-27. See also Ann. Mycol., ix. (1911) p. 307.

‡ Agric. Research Inst. Pusa, Bull. No. 18 (1910). See also Ann. Mycol., ix. (1911) p. 307.

§ U.S. Dep. Agric. Bur. Plant Ind., Bull. No. 171 (1910). See also Ann. Mycol., ix. (1911) pp. 308-9.

|| Board Agric. Fish., Leaflet No. 348 (8 pls. and 5 figs.).

¶ Ber. Deutsch. Bot. Gesell., xxix. (1911) pp. 70-4 (3 figs.).

** Zeitschr. Landw. Ver. Oesterr., xiv. (1911) p. 209. See also Bot. Centralbl., cxvi. (1911) pp. 622-3.

†† Gartenflora, lx. (1911) pp. 76-8. See also Bot. Centralbl., cxvi. (1911) p. 623.

spores are borne directly on a plectenchyma lining the walls, and not on sporophores. It belongs to the genus *Sclerophoma* v. Höhn.

Ed. Essed* gives a long account of the Panama Disease which broke out in banana plantations about five years ago. The trees were attacked when about five or six years old; at ten years they were quite worthless. He traces the disease to a fungus, which he has described as it occurs on the trees and in cultures. He finds that it is a new plant, *Ustilaginoidella musæperda* g. et sp. n. He found, produced on the hyphæ, structures which he calls pegmatia, which break up into chlamydospores.

He also describes† the "Surinam Disease," a condition of elephantiasis of the banana caused by a species of the same genus, *U. adipigera*. It manifests itself by an enormous distension of the base of the stem. Both forms produced hyphæ and conidiophores with *Fusarium*-like spores.

A. v. Jaczewski‡ has written an account of the plant-diseases in Russia during 1909. In that year disease was rife in North and Central Russia, while the south was practically free. Much damage was done to cereals by *Puccinia triticina*, by *Erysiphe graminis* (recorded for the first time in Russia in 1904), by ergot, and other minute fungi. *Phytophthora infestans* and *Cercospora concors* did most damage to potatoes; *Uromyces Pisi* was found on peas, and *Cercospora beticola*, *Phoma Betæ*, and *Uromyces Betæ* on beet. Hops were attacked not only by the mildew, but by a new disease due to *Septoria humulina*, which damages the leaves. Fruit trees suffered from *Fusicladium* (apples and pears). It was found that *Monilia fructigena* had been almost entirely cleared out by spraying, but *Sphaerotheca Mali* on apples was abundant. *Eroascus bullatus* appeared on leaves of the pear, and stone fruits suffered badly from *Clasterosporium Amygdalinum* and *Monilia cinerea*. *Eroascus deformans* was unfortunately very prevalent in some districts. The American mildew of gooseberries was recorded from many districts in previous years, but during 1909 the epidemic had somewhat abated; advice is given how to deal with it. On strawberry leaves *Sphaerella Fragariæ* made its usual appearance, and in addition a new spot disease, *Marssonia Potentillæ*. Vines suffered from *Sclerotinia Fockeliana* and *Septoria ampelina*, the latter known as Melanose in America. Other fungi are recorded on forest trees and on garden shrubs and other plants, two fungi being recorded on tea plants, *Colletotrichum Cameliæ* and *Discosia Theæ*. Palms were often attacked by *Graphiola Phœnicis*.

D. Hegyi§ finds that the black stalk of beetroot is due to the presence in the tissues of *Phoma tabifica*, *Pythium de Baryanum*, and different bacteria, which may have been present in the seed before sowing, or which may have attacked the plant from the soil. He found that the best method of combating the evil was to dry the seed thoroughly. The seeds then germinated more quickly, and produced stronger and more resistant seedlings.

* Ann. of Bot., xxv. (1911) pp. 343-61 (2 pls.).

† Ann. of Bot., xxv. (1911) pp. 363-5 (1 pl.).

‡ Jahrb. Bur. Myk. Phyt., 1909. See also Zeitschr. Pflanzenkr., xxi. (1911) pp. 281-7.

§ Bull. Soc. Mycol. France, xxvii. (1911) pp. 153-9.

A. Stift* has made an exhaustive study of the literature connected with the various diseases of beet and potato, both insect and fungoid, with special reference to the best means of combating these diseases.

C. E. Lewis† has made a study of apple-tree diseases by means of cultural experiments. He finds that *Coryneum foliicola* and *Phoma Mali* cause disease of the wood of young apple-trees and of the branches of older trees. These fungi are more actively parasitic than *Comiothyrium pirina*. As wound-parasites, they attack young trees, where they do as much damage as *Sphaecopsis malorum*. *Coryneum* causes trouble only in ripe apples; *Phoma* is more virulent, and can also attack green fruit. Neither of the fungi attack uninjured leaves, but they may occur on the dead spots of apple-leaves. The spread of the organisms can be checked by burning the dead wood on which they occur.

W. J. Morse and C. E. Lewis‡ have also investigated the diseases of the apple in Maine: diseases of foliage, fruit, and wood, due to various fungi, have been examined microscopically and by cultural methods. The best methods of treating them are recommended and carefully explained.

At the Florida Agricultural Experiment Station § H. S. Fawcett has specially studied diseases of peach trees. He records a stem rot of *Citrus* trees due to a fungus not yet determined, and describes the condition of *Citrus* trees afflicted with scaly bark. A silvered scurf on *Citrus* fruit is also due to a fungus not yet identified. The fungi of scale insects are also discussed.

In a later communication Fawcett || takes up again the question of scaly bark, which he finds to be due to *Cladosporium herbarum* var. *citricolum*. He made many experiments, cultural and others, especially for the purpose of checking the disease. He finds that the disease will yield to Bordeaux mixture, and that pruning out the dead wood lessens subsequent infection. A bibliography of papers on the subject of *Cladosporium herbarum* is appended to the paper.

R. Schander ¶ has published an account of plant and animal diseases in Posen and West Prussia. The potatoes suffered badly from leaf-roll and from diseases due to bacteria. Advice is given to fruit growers how to deal with *Fusicladium*, a fungus which attacks apples and pears.

Pathogenic Fungi.**—A. Sartory has demonstrated in several instances the occurrence of *Oospora* causing more or less of disease in the human organism. One species, *O. buccalis*, was found in the mouth of the patient. The fungus was cultivated and details are given. In other cases not only *Oospora* but also *Endomyces* was discovered; the two parasites being intimately associated.

* Centralbl. Bakt., xxx. (1911) pp. 579-613.

† Marine Agric. Exper. Stat., Bull. No. 170 (1909) pp. 185-200 (13 pls.).

‡ Marine Agric. Exper. Stat., Bull. No. 185 (1910) pp. 337-92 (15 pls.).

§ Rep. Florida Exper. Stat. (1910) lxx. pp. (20 figs.).

¶ Univ. Florida Agric. Exper. Stat., Bull. No. 106 (1911) 41 pp. (31 figs.).

¶ Mitt. k. Wilhelm Inst. Landw. Bromberg, ii. (1910) pp. 1-141 (1 pl. and figs.).
See also Bot. Centralbl., cxvii. (1911) pp. 224-5.

** Bull. Soc. Mycol. France, xxvii. (1911) pp. 160-71 (11 figs.).

Fish Disease.*—M. Plehn and K. Mulson have studied a disease that is fatal to trout, etc. It was previously known and was considered to be a sporozoon. The authors made cultures of the organism, which they have named *Ichthyophonus Hoferi*, and they are inclined to classify it as a fungus and as a genus of Chytridinea. Descriptions of the cultures and figures of the fungus are published.

Obituary Notice.†—Maurice Barbier has published a short sketch of Dr. F. H. Gillot. He was a devoted physician, and, in addition, a keen naturalist. He was especially interested in the toxic qualities of the larger fungi, and constantly published notes on cases of poisoning due to eating fungi, with researches on the harmful species. A long list of his publications is given.

ARTHUR, J. C.—**New Species of Uredinea. VIII.**

[Six new species of *Puccinia* and five of *Uromyces* are described.]

Bull. Torrey Bot. Club, xxxviii. (1911) pp. 369-78.

BARBIER, MAURICE—**Observations taxonomiques et espèces rares ou nouvelle-ment reconnues en Bourgogne.** (Taxonomic observations and rare or newly discovered species in Burgundy.)

[A large number of species have been found and commented on.]

Bull. Soc. Mycol. France, xxvii. (1911) pp. 172-91.

BOUDIER & TORREND—**Discomycetes nouveaux de Portugal.** (New Discomycetes from Portugal.)

[A number of new species described and figured; one new genus, *Torrendiella*.] *Bull. Soc. Mycol. France*, xxvii. (1911) pp. 127-36 (3 col. pls.).

BOURDOT, H., & A. GALZIN—**Hymenomycetes de France. III. Corticiés: Corticium, Epithele, Asterostromella.**

[Synoptic tables of genera and species, with diagnoses.]

Bull. Soc. Mycol. France, xxvii. (1911) pp. 223-66.

BUCHHOLTZ, FEODOR—**Ueber die Befruchtung von Endogone lactiflua.** (Fertilization in *Endogone*.)

[A short preliminary note on the subject.]

Ann. Mycol., ix. (1911) pp. 329-30.

CASTELLARNAU, JOAQUIN M., L. NAVARRO, & L. H. ROBREDO—**La enfermedad del Castano.** (Disease of chestnut-trees.)

Memoria. Madrid: (1909) 51 pp. (10 pls.).

DANGEARD, P. A.—**Un nouveau genre de Chytridiacées.** (A new genus of Chytridiaceae.)

[The new fungus *Mitochytridium ramosum* inhabits the cells of the Desmid *Docidium Ehrenbergii*.]

Bull. Soc. Mycol. France, xxvii. (1911) pp. 200-3 (1 fig.).

GROVE, W. B.—**Four little-known British Fungi.**

[The author proposes a new genus, *Rhopalocystis*, for the dark-coloured species of *Aspergillus*.] *Journ. Econ. Biol.*, vi. 2 (1911) pp. 38-49 (2 pls.).

GUÉGUEN, FERNAND—**Au sujet d'une publication recente de Linford Freeman sur le Xylaria Hypoxylon.** (Concerning Freeman's publication on *Xylaria Hypoxylon*.)

[Guéguen claims that most of the work had been previously published by him.]

Ann. Mycol., ix. (1911) pp. 326-8.

HÖHNEL, F. VON, & JOSEF WEESE—**Zur Synonymie der Nectriaceen.** (On the synonymy of the Nectriaceae.)

[A large number of species are found to be synonymous with others previously described.]

Ann. Mycol., ix. (1911) pp. 422-4.

* *Centralbl. Bakt.*, 1te Abt., lix. (1911) pp. 63-8 (1 pl. and 6 figs.).

† *Bull. Soc. Mycol. France*, xxvii. (1911) pp. 192-9.

- LAAP, OTTO—**Fungi selecti exsiccate. Nos. 301-400.**
 [Lists of the plants, with notes and descriptions.
Verh. Bot. Ver. Brandenb., 1910 (1911) pp. 3-21.]
- " " **Verzeichnis der bei Triglitz in der Prignitz beobachteten Ascomyceten.** (List of Ascomycetes observed at Triglitz, in Prignitz.)
 [A large number of species are listed, with various notes.]
Verh. Bot. Ver. Brandenb., 1910 (1911) pp. 109-50.]
- " " **Ein kleiner Beitrag zur Pilzflora der Vogesen.** (A small contribution to the fungus-flora of the Vogesen.)
 [A large number of species, mostly of micro-fungi, are listed.]
Ann. Mycol., ix. (1911) pp. 330-40.]
- MAGNUS, P.—**Ein neues Melanotænium aus Thüringen.** (A new *Melanotænium* from Thuringia.)
 [The parasite occurred on *Teucrium montanum*.]
Ber. Deutsch. Bot. Ges., xxix. (1911) pp. 456-8.]
- MIGULA, W.—**Krypt.-Flora, Pilze.**
 [Several important genera of gilled fungi (*Cantharellus*, *Coprinus*, etc.) are described.]
Flora von Deutschland (Gera, 1911) Lief. 115-22, pp. 273-400 (40 pls.).]
- REHM, H.—**Ascomycetes Novi. IV.** (New Ascomycetes.)
 [Fungi collected in North America, in South America, and in Asia.]
Ann. Mycol., ix. (1911) pp. 363-71]
- SEEVER, F. J.—**The Hypocreales of North America. IV. Cordycepites.**
 [Three genera are dealt with, *Cordyceps*, *Spermoedia*, *Balansia*.]
Mycologia, iii. (1911) pp. 207-30.]
- SUREYA, M. MEHMED—**Sur quelques Champignons inférieurs nouveaux ou peu connus.** (On some new or little known fungi.)
 [Two new species of microfungi are described.]
Bull. Soc. Mycol. France, xxvii. (1911) pp. 220-2 (3 figs.).]
- SYDOW, H. & P., & E. J. BUTLER—**Fungi Indiæ Orientalis.** (Fungi of East India.)
 [A large number of species, mostly of microfungi, are described, many of them new to science: there is one new genus, *Metachora*, near to *Phyllachora*.]
Ann. Mycol., ix. (1911) pp. 272-421 (9 figs.).]
- TROTTER, A.—**Aggiunte alla Micrologia italica.** (Additions to Italian mycology)
 [Several species of microfungi are recorded, with notes.]
Bull. Soc. Bot. Ital., 1911, pp. 134-7.]
- WHELDON, H. J.—**Key to the British Agaricaceæ.**
 [Continuation of this key arranged for field workers.]
Lanc. Naturalist, iv. (1911) pp. 63-5.]

Lichens.

(By A. LORRAIN SMITH, F.L.S.)

West of Ireland Lichens.*—The Clare Island Survey Committee are reporting on the Flora and Fauna of Clare Island and of the mainland of West Ireland from Achill in the north to Killary Harbour in the south. The Lichens of the district have been worked out by A. Lorrain Smith. A sketch of the districts from the lichenological standpoint is given, with notes on collectors previous to the present survey. A general view of the lichens to be found in the district, with the habitat of the chief forms, is followed by a list of genera and species with locality and habitat.

* Proc. Roy. Irish Acad., xxxi. (1911) 14 pp.

Lichens of Italy.*—J. Steiner publishes the lists of lichens collected by J. Brunnthaler and O. Porsch in Italy. He adds notes on the development of the limestone Verrucariæ and of the value of the oil-hyphæ as aids to diagnosis. He gives also a suggested grouping of *Lecanora subfusca*.

Morphology of Lichens.†—B. Kajanus publishes a series of observations on lichen vegetation as affected by the substratum, the proximity to towns, etc. On decaying wood several species were found with irregular thalli. Species are recorded from pebbles on the beach and from glaciers. Variation of the thallus is noted in several genera and species, notably in *Ramalina calivaris*. Notes are given on soredial formation, etc., and on the dwarfing of species.

Nature and Classification of Lichens.‡—Bruce Fink has canvassed a considerable number of botanists as to their views on the classification of lichens, and he now publishes tabulated results of the replies he has received. Quotations are given from a number of the letters.

HERRE, W. C. T.—**The Gyrophoraceæ of California.**

[Descriptions of species of *Gyrophora* and *Umbilicaria*]

Contr. U.S. Nat. Herb., xiii. (1911) pp. 313-21 (6 pls.).

HOWE, R. HEBER—**A Correction.**

[Pointing out a wrong record, with a description of *Ephebe solida* from Mount Monadnock.]

Bryologist, xiv. (1911) pp. 91-2.

OLIVIER, H.—**Étude synoptique et géographique des Lécidés de la Flore d'Europe.** (Synoptic and geographical study of European Lecideæ.)

Bull. Geogr. Bot., xxi. (1911) pp. 157-209.

SAVICZ, V. P.—**Interessante und neue Arten und Formen der Flechten im Gouv. Novgorod 1910 gesammelt.**

[New and interesting species and forms of lichens collected in Novgorod.]

Bull. Jard. Bot. St. Petersbourg, xi. (1911) 2, pp. 50-5 (fig.).

See also *Bot. Centralbl.*, cxvii. (1911) p. 247.

Mycetozoa.

(By A. LORRAIN SMITH.)

Myxomycetes from the Neighbourhood of Paris.§—R. Ledoux-Lebard states that the study of Myxomycetes has been somewhat neglected in France. He gives an historical account of the species noted from Bulliard onwards. He remarks on the number of species known and their geographical distribution. He then discusses their polymorphism and the questions of nomenclature, and proceeds to a full description of the species found by him, sixteen of which are enumerated belonging to the genera *Ceratiomyxa*, *Balhamia*, and *Physarum*. The list is to be continued.

* Verh. Zool. Bot. Ges. Wien, lxi. (1911) pp. 29-64. See also *Bot. Centralbl.*, cxvii. (1911) pp. 169-70.

† *Ark. Bot.*, x. n. 4, 47 pp. (2 pls.). See also *Hedwigia*, li. (1911) pp. 27-28.

‡ *Mycologia*, iii. (1911) pp. 231-69.

§ *Bull. Soc. Mycol. France*, xxvii. (1911) pp. 275-302.

Notes on Myxomycetes.*—C. J. Lloyd reports an instance of a fly forming a nest in *Enteridium rozeanum* Lister. He also publishes a list of Myxomycetes collected by him in Samoa, and determined by Macbride. He remarks on the wide distribution of species as exemplified in this collection. Though the island is so far distant not one of the species is new.

Schizophyta.

Schizomycetes.

Bacterial Diseases of Orchids.†—G. L. Pavarino describes a bacterium which he found in the leaves of *Cattleya warneri* and *C. harrisoniæ*. This organism, *Bacterium cattleyæ*, varies in size and shape according to the age of the culture. It is aerobic, Gram-negative, but stains well, especially with gentian-violet. It forms spores. It was cultivated in broth and on agar and gelatin. Healthy plants when inoculated with pure cultures showed appearances similar to those in the naturally acquired disease.

From *Odontoglossum citrosomum* was isolated *Bacillus pollacii*, which was the cause of black spots. It is from 8–10 μ long and 1 μ broad. It forms spores; is easily stained, but is decolorized by Gram's method. It is aerobic, and grows well in broth and on gelatin and agar. Experiments with pure cultures seemed to show that the organism gains entrance through a damaged enticle.

Bacterium krameriani produces disease of the leaves and pseudobulbs of *Oncidium kramerianum*. The organism is a rodlet 2–3 μ long and 0.6–0.8 μ broad. It has no special disposition, but is found mostly singly or in pairs. It forms spores; is easily stained, but is Gram-negative. It is cultivable on agar and gelatin and in broth; some of the media present a greenish-yellow hue. Appearances similar to the natural disease were produced by hypodermic inoculation of healthy leaves.

Bacillus farnetianus was obtained from diseased specimens of *Oncidium ornithoricum* and *Cattleya crispa*. This organism may attain a length of 15 μ and is from 0.8–1 μ broad; it may form quite long filaments. It is an imperfect Gram-stainer. It was cultivated on agar and gelatin and in broth. Inoculations of healthy plants were successful.

Bacillus Cypripedii.‡—S. Hori describes a new species of bacterium which causes "brown rot," a disease chiefly affecting the leaves of tropical orchids. *Bacillus Cypripedii* is a slender bacillus with rounded ends, occurring singly or in short chains. It is 1.5–2 μ long and 0.5–0.7 μ broad. It is motile, having four peritrichous flagella 10 μ long. It stains by Gram's method. It does not form spores. On agar the colonies are white, and on potato of a dirty cream colour; forms a scum on broth; liquefies gelatin; coagulates milk; forms much gas on glucose media. It rapidly decolorizes methylen-blue broth. It is a

* Cincinnati, Ohio, No. 37 (1911) p. 506 (2 figs.).

† Atti R. Accad. Lincei, xx. (1911) pp. 233–7.

‡ Centralbl. Bakt. 2^e Abt., xxxi. (1911) pp. 85–92 (2 figs.).

potential anaerobe. Is pathogenic to tropical orchids, entering chiefly through wounds. Careful washing with 1 : 1000 sublimate effects a cure. The author discusses its relations to other bacteria, and concludes that it is a new species.

Bacterium tumefaciens.* — E. F. Smith directs attention to the resemblances between "crown-gall," an affection of plants, and malignant animal tumors, especially sarcoma. It is inoculable on healthy plants, reproducing the disease. In the tumors, both primary and those obtained by artificial inoculation, a bacterial organism, *Bacterium tumefaciens*, is present. This can be isolated and cultivated, and the pure cultures reproduce the disease on inoculation.

Bacterium briosianum.† — G. L. Pavarino describes a new organism, which attacks *Vanilla planifolia*. Morphologically it is a very small rodlet; it stains well, but not by Gram's method. It grows well on the usual media; it liquefies gelatin, and forms a scum on broth; a deposit is formed later, the liquid turning green.

Anaerobic Streptothrix.‡ — Kurt Meyer isolated from empyema pus a Gram-positive *Streptothrix*. It was very selective as to diet and environment, being cultivable only under anaerobic conditions, and on media which contained grape-sugar and ascitic fluid.

Penetration of the Normal Skin by Tubercle Bacilli.§ — H. Koenigsfeld records observations and experiments which seem to show that tubercle bacilli can enter the body through the cutaneous surface by way of the hair follicles and lymph spaces. The infection became more or less generalized, though the site of inoculation (effected by rubbing after shaving, epilation, or cutting off the hairs) showed no local change. Previous experiments by other observers are freely recorded, and a copious bibliography is appended.

Artificial Production of a permanently atypical Bacillus coli.|| C. Revis found a strain of *Bacillus coli* which, when cultivated in the presence of malachite-green, grew quite strongly. After fifteen subcultivations this strain was found to have undergone marked change in its physiological properties: its power to produce gas being almost completely lost, while acid only was produced in identically the same media as originally. As shown by other tests, this organism had suffered no loss of vitality.

Parasite of Rabies and Plasmodiophora brassicæ.¶ — G. Polacci records some observations which indicate the morphological and biological affinity of *Plasmodiophora brassicæ* and Negri's bodies. There are, however, no allusions to experiments made on animals with the *Plasmodiophora*.

* Bureau Plant Industry U.S.A., Dept. Agric., Circ. No. 85 (1911). See also Nature, lxxxvii. (1911) p. 371.

† Atti R. Accad. Lincei, xx. (1911) pp. 161-2.

‡ Centralbl. Bakt., 1te Abt. Orig., lx. (1911) pp. 75-8 (2 figs.).

§ Centralbl. Bakt., 1te Abt. Orig., lx. (1911) pp. 28-68 (3 figs.).

|| Centralbl. Bakt., 2te Abt., xxxi. (1911) pp. 1-4.

¶ Atti R. Accad. Lincei, xx. (1911) pp. 218-22.

Foot-and-mouth Disease.* — L. v. Betegh describes very minute corpuscles which he has obtained from vesicles, uncontaminated by bacteria, of foot-and-mouth disease. They are found in the serum and in the nuclei of the neutrophil leucocytes. They vary from $0.25-1 \mu$, and consist of a central stainable portion and a non-staining peripheral investment. He considers these corpuscles to be the specific cause of the disease.

Diplococcus gadidarum, the cause of the Reddening of Cod and other allied Fish.† — T. D. Beckwith describes an organism which he thinks causes the pinking of cod and allied fish during the various stages of preparation for market purposes. This bacterium, named *Diplococcus gadidarum*, is from $0.4-0.5 \mu$ in diameter, but after prolonged cultivation may attain to 1μ . Somewhat like *Gonococcus* in shape, it is easily distinguished therefrom by its easy cultivability, and by being Gram-positive. It forms a salmon-coloured pigment, and is strictly aerobic. It is remarkably halophilic, growing luxuriantly when 5 to 10 p.c. of salt is added to the medium. Sterilized fish inoculated with pure cultures of *D. gadidarum* turned pink.

Bacillus coli and Plant-diseases.‡ — In an article entitled, "Is *Bacillus coli* a Plant Parasite?" J. R. Johnston records observations and experiments which tend to show that *B. coli* gives rise to disease in plants. An organism morphologically and culturally identical with *B. coli* was isolated from cocoa-nut trees affected with bud-rot. *B. coli* of animal origin, when inoculated on healthy plants, produced similar results. Hence this organism would appear to have greater pathological importance than has hitherto been suspected.

Bacillus pappulus.—F. de Gaspari isolated this anaerobic organism from decomposing sausages. In young cultures the organism is about the same size as *B. perfringens*, $4-9 \mu$, but after a week or more it becomes longer and thinner. It is easily stained, but not by Gram's method nor by iodine. It is an essential anaerobe, forms spores, produces gas and acid, the cultures exhaling an odour like that of rancid butter. On solid media the cultures have some resemblance to those of anthrax. It attacks albumen freely, ferments sugars, coagulates milk, forms indol, but is not pathogenic to laboratory animals. The place of this organism lies between the bacillus of Ghon and Sachs and *B. radiiformis* of Risl and Guillemot.

Scarlet-fever Virus.§—Bernhardt gives an account of his experiments on the transmission of scarlet fever to monkeys. Scrapings from the tongue of a patient suffering from this disease were rubbed into an abraded area of mucous membrane in the mouth of a monkey. Four days later, when the animal was dying of general septicæmia, the inguinal glands were excised and a second monkey inoculated. At the third inoculation — that is, after passage through two monkeys — a

* Centralbl. Bakt., 1te Abt. Orig., lx. (1911) pp. 86-90 (2 pls.).

† Centralbl. Bakt., 1te Abt. Orig., lx. (1911) pp. 351-4.

‡ Depart. Agric., U.S.A., Phytopathology, i. No. 3 (1911).

§ Centralbl. Bakt., 1te Abt. Ref., l. (1911) Beih., pp. 27-30.

scarlatinal disease was produced, the septic contaminations having been eliminated. This monkey showed all the classical signs of scarlet fever. Further experiments with gland material filtered by means of a Berkefeld filter, showed that the filtrate would give rise to the disease. From which it would appear that the causal agent of scarlet fever is a filter passer.

Growth of *Bacterium zopfii*.*—H. Kufferath discusses the physical conditions which determine the mode of growth of this organism in gelatin. If planted upon a thick layer of gelatin, maintained vertically, it will develop a filamentous, arborescent growth, consisting of more or less vertical threads growing in a direction contrary to gravity. The author first of all gives an account of the contributions of other workers to the solution of the problem, giving prominence to the views of Jacobsen, with which he is largely in accord. He considers that under the influence of gravity, the medium might fall into layers of greater or less density, the latter holding, moreover, a larger proportion of water. The bacterium inoculated into such a medium would follow the lines of less resistance and higher proportion of water, thus marking out graphically the lines of force of gravity acting through the medium. This implies that the organism possesses the qualities of haptotropism (response to variations in pressure) and hydrotropism (response to variations in moisture). Superficial colonies consist of radiating filaments. One of these penetrating the surface of the medium forms a deep branching growth. In a scanty quantity of medium, where variations in tension are not perceptible, the growth is more irregular. There is a correlation between the shape of the individual and that of the colony, a coccobacillary type occurring at times in small round colonies. Growth in a comparatively inelastic medium, such as agar, does not show any of these appearances.

- BEIJERINCK, M. W.—**Pigments as Products of Oxidation by Bacterial Action.**
Konink. Akad. Wetensch. te Amsterdam, xiii. (1910) pp. 1066-77.
- ROMANOWITCH, M.—**Contribution à l'étude de la Flore intestinale de l'homme.**
C.R. Soc. Biol. Paris, lxxi. (1911) pp. 237-9.
- SPRINGER—**Ein Fund von *Bacillus paratyphi* Typus A in der Gallenblase, neber Einwirkung der Bakterien der Typhus-Coli-Gruppe auf verschiedene Zuckerarten.**
Centralbl. Bakt., 1te Abt. Orig., lx. (1911) pp. 2-14.
- WOLFF, A.—***Bacterium fuchsinum* und *Bacterium violaceum*.**
[Descriptions of two chromogenous organisms isolated from water.]
Centralbl. Bakt., 2te Abt., xxx. (1911) pp. 639-44.

* *Ann. Inst. Pasteur*, xxv. (1911) pp. 601-17.



MICROSCOPY.

A. Instruments, Accessories, etc.*

(1) Stands.

The **Binocular Microscope**.†—J. Amann points out that the important developments of late years in Microscope construction leave little hope that much further optical improvement is likely to be made. He thinks, however, that practical and especially hygienic considerations still require attention. He would much like to see the Continental Microscope adapted to normal binocular vision. He contrasts monocular with binocular vision, to the disadvantage of the former, but fully admits the difficulties of the undertaking to which he invites the attention of

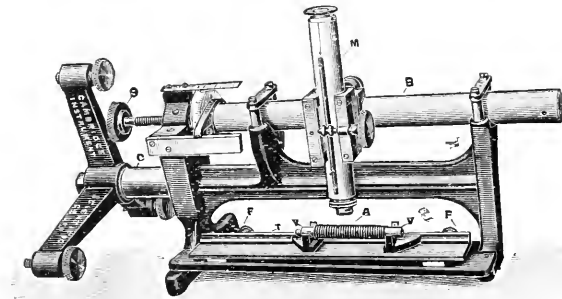

FIG. 87.

Microscope makers. The latest and most complete binocular is Greenough's Stereoscopic Microscope, but it is only adapted for comparatively weak objectives, which are quite insufficient for modern biological investigations. He considers that the constructional requirements to be met in designing a binocular arrangement are:—1. That the arrangement should not sensibly alter the correction of the optical system; it should permit the use of compound objectives—weak, medium, high, including homogeneous immersions. 2. That it should likewise be available for oculars of various types—Huyghens, Ramsden, Compensator. 3. That there should be no sensible loss of light; the light-strength of both fields should be approximately the same. 4. That the arrangement should be easily inserted and removed, in order to use the Microscope monocularly or binocularly as desired. The binocular should be suitable

* This subdivision contains (1) Stands; (2) Eye-pieces and Objectives; (3) Illuminating and other Apparatus; (4) Photomicrography; (5) Microscopical Optics and Manipulation; (6) Miscellaneous.

† Zeitschr. wiss. Mikrosk., xxvii. (1911) pp. 488-93.

for use with all kinds of illumination—polarized light, dark-ground, ultra-microscopy.

Among instruments which have to some extent anticipated his requirements, the author mentions the Wenham-Schroeden objective-prism, made some fifteen years ago by Ross of London, under the title of "Improved Binocular Prism for High Powers." The excellent qualities of this prism—which he fully enumerates—are counterbalanced by the ponderous stand, which makes a rather unwieldy and costly instrument. In conclusion, while admitting that for certain special purposes, e.g. resolution of more difficult structures, test-objects, and so forth, the monocular instrument is the more suitable, yet for most systematic purposes, and especially for prolonged observations, he thinks that the binocular is so much to be preferred that he hopes his suggestions will not be unattainable.

Comparator or Reading Microscope.*—This instrument (figs. 87, 88), made by the Cambridge Scientific Instrument Company, can be used with the axis of the Microscope vertical, horizontal, or inclined. The illustration (fig. 87) shows it with the axis vertical; in fig. 88 it is seen as a cathetometer, with the Microscope horizontal. The tube B, to which the Microscope is clamped, can be traversed slowly by the screw and milled-head S through 40 mm. reading, being taken on the divided micrometer-head to 0.01 mm. For supporting the object under examination a small sliding table I, resting on geometric fittings, is provided.

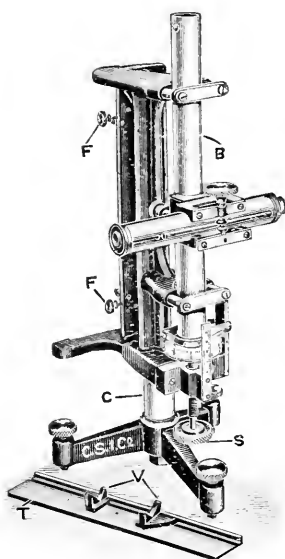

FIG. 88.

This is supported with centring adjustments controlled by the screws F, F. Lucas's patent slow motion is used for this focusing mechanism of the Microscope. The Microscope M, which is fitted with cross lines and can be clamped at any point on the tube B, has a Zeiss achromatic objective a_2 and No. 2 ocular. The working distance between the nose of the objective and the object is 30 mm. The instrument, which weighs 17 lbs., is used as seen in fig. 87 for the examination of screws; it is also employed for measuring the hardness of steel. This is done by pressing a small steel ball into the steel to be examined, by the pressure of a known weight. The indentation thus produced is a measure of the hardness, the diameter of the indentation being measured by the Microscope.

* Cambridge Scientific Instrument Co., List No. 88, p. 9 (2 figs.).

(3) Illuminating and other Apparatus.

New Nernst Lamp for Microprojection.*—A. Köhler, in discussing some of the difficulties attendant upon the Nernst lamp, points out that the best results are attained when the collector-lens is so shaped that its image of a luminous bar completely covers the actual aperture of the iris-diaphragm : in other words, if the breadth of the image of a luminous bar is at least equal to the diameter of the diaphragm aperture. Thus, if (fig. 89) $2L^1$ be the breadth of the image of a bar, or, generally, the least diameter of the image of the light-source, $2r$ the diameter of the condenser-diaphragm, then this condition will be satisfied when $L^1 \geq r$.

If, further, $2L$ be the breadth of a bar, or, generally, the least diameter of the light-source, f_1 the focal distance of the collector-lens,

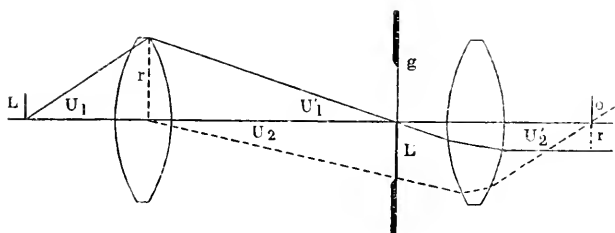

FIG. 89.

and x^1 the distance of the condenser stop from the rear focal point F^1 of the collector, then

$$\frac{L^1}{L} = \frac{x^1}{f_1}$$

From the foregoing results it follows that, by taking only the equality sign in the first equation,

$$\frac{r}{L} = \frac{r^1}{f_1}$$

and this derived equation gives approximately the distance at which a collector of focal distance f_1 belonging to a Microscope of assigned optical structure should be set up. If the image of the light-source is also to be sharp, when the collector has a greater angular aperture, there must be aplanatism ; this requires that,

$$L \sin u_1 = L^1 \sin u_1$$

The author proceeds similarly to investigate other conditions, with especial reference to Zeiss' apochromats and compensation oculars. His principles have been carried into practice by Messrs. Carl Zeiss, and a view of their apparatus is shown in fig. 90. It has the advantage, in the case of small light-sources, of combining the collector-lens with the Nernst. The collector, provided with an iris-diaphragm 1, is clamped

* Zeitschr. wiss. Mikrosk., xxvii. (1911) pp. 477-88.

firmly in a sleeve 2, which surrounds a slit adjustable by means of a micrometer-screw 3. In this manner the image of the bright bar can be made to fall sharp and clear upon the diaphragm of the Microscope-condenser. The screw 4 is for centring the light-source with regard to the axis of the collector. This screw raises and lowers the bright bar, and thereby effects a corresponding perpendicular movement of its image. A lateral movement is not necessary, for the image of the long thread always covers in this direction the condenser-diaphragm, provided that the height-adjustment is rightly attained. The bright bar lies in a pillbox-shaped receptacle, whose under portion is shown in fig. 90 separated from the upper part. In this lower part are seen the two electrodes,

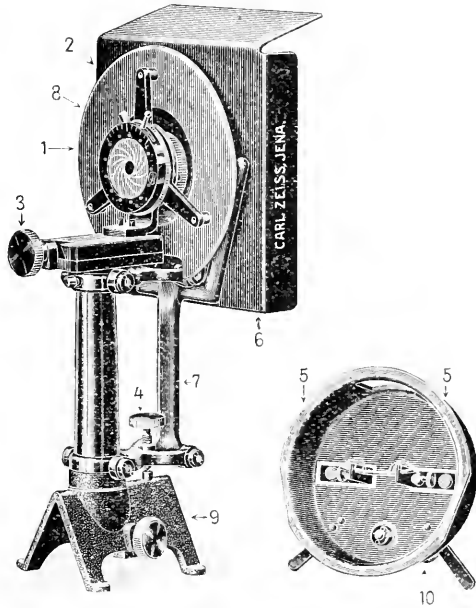

FIG. 90.

connected by a platinum wire and secured by the small screws 5. The front wall 6 of the receptacle is approximately square, and is provided with a small opening opposite to the collector. A so-called parallelogram-movement connects the opening with the pillar carrying the slit and collector, and controls the above-mentioned vertical adjustment of the light-source. The front and rear walls of the receptacle are provided with ventilation openings, and the front wall has also wing-shaped projections for assisting cooling-down. Between the receptacle and the collector is a covering 8 for guarding the collector against radiation from light-source and from receptacle. A rider 9 serves to carry the whole on Zeiss' optical bench. The author also describes many of the details connected with the current and with the management of the light.

Sliding-objective Changers and Revolvers.*—Among devices for saving time when an operator has to work with more than one objective, revolving nose-pieces are the best and most successful. F. K. Studnicka points out, however, that objectives used in this way are liable to errors of centring, and that in high-class work such errors may become important. Another, and perhaps more serious difficulty, is the limitation to the possible number of objectives on a revolver. More than four cannot be applied, and they are apt to interfere with the manipulation of the preparation-slide. The number on one revolver seldom, therefore, extends beyond three. With an objective-slide some of the above disadvantages disappear; there is no restriction as to number, and everyone can adjust the centring without tedium. On the other hand, exchange of objectives is a longer operation than with a revolver. The author expresses his surprise that no attempt has yet been made to combine the advantages of both systems; and that the revolvers themselves might be interchangeable, and be attached to the Microscope-tube by some sliding movement. In this way an operator might work with, say, two revolvers: one with his weak, and the other with his strong objectives.

Methods for the Identification of Sub-microscopic Structures.†—J. Koenigsberger has made use of Lippmann's layers in colour photo-

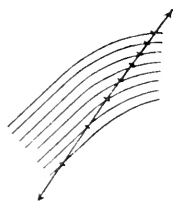

FIG. 91.

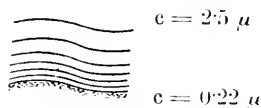

FIG. 92.

graphy for obtaining a natural grating. If the film obtained by blue-violet light be sectionized obliquely by a microtome (fig. 91) and mounted in damara in the usual way, then a grating is obtained in which the layers of silver granules are separated by intervals varying from one-third to four times the wave-length of yellow-red light ($\lambda = 0.6 \mu$), see fig. 92. Resolution through the end at which the layers are distant from each other less than a wave-length is of course impossible, but the polarization effects obtained give a clue to the structure. The author describes fully the nature of the auxiliary polarizing apparatus required.

New Zeiss Nernst Lamp.—This lamp (fig. 93) consists of a single filament in globular metal casing, nickel plated, and so arranged that the upper half readily removes, leaving free access to the filament which is to be started with a spirit flame or wax match after the current is switched on to render it incandescent. A small chimney to draw off the heat of

* Zeitsch. wiss. Mikrosk., xxvii. (1911) pp. 501-3.

† Zeitschr. wiss. Mikr., xxviii. (1911) pp. 34-41 (2 figs.).

‡ Pamphlet on Ultra Microscopy, pt. 4, figs. 1 and 4.

the lamp is provided for on top of the spherical casing, and the whole is mounted on a china pillar with base.

In the cylindrical mount attached to the spherical metal casing an aplanatic condenser of short focus is mounted with a slot arrangement in front to receive ground glass or colour screens. The lamp is fitted to the base in an inclined position, and the aplanatic condenser, which is a fixture, is so arranged that at a comparatively short distance from the lamp an enlarged image of the rod is projected, filling the entire aperture of an average Microscope mirror. The small glass tube

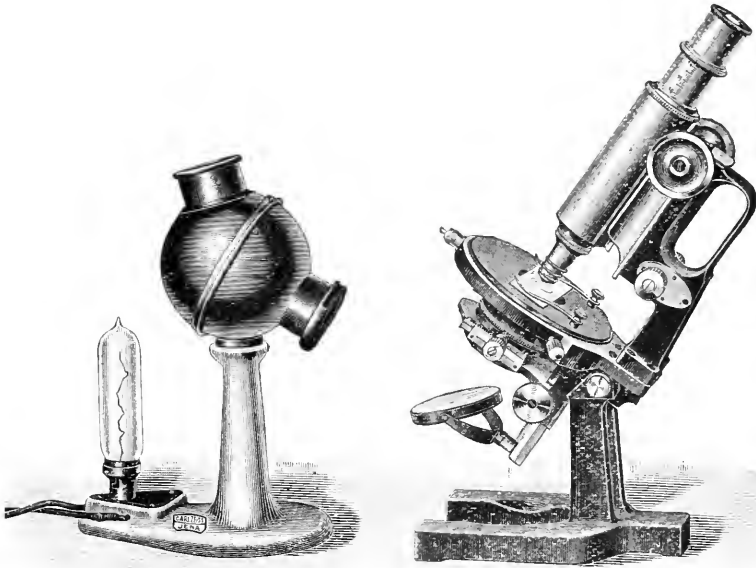

FIG. 93.

mounted to base is a wire resistance for the lamp. The lamp burns at 1 ampere, and can be supplied suitable for either continuous or alternating current. For high voltage an auxiliary resistance is supplied.

Winkel's Drawing Microscope.*—This excellent Microscope, says E. M. Nelson, although described nine years ago, is still so little known that a second and more particular account of it is necessary. Until it had been in use, the writer had no idea what a valuable instrument it was. Several naturalists and science masters who have seen it were very much struck with it, and expressed astonishment that it had not come into more general use.

Fig. 94 shows the instrument by itself—a non-inclinable Microscope upon a horseshoe foot. It is a stage focuser, and the stage, 2.9 in. square, carries on the same bracket a concave mirror 1.8 in. in diameter.

* English Mechanic, xciv. (1911) pp. 257-8 (3 figs.).

The aperture in the stage is 1.9 in. in diameter, and a reducing ring is supplied. Half an inch below the bottom of this stage is a "turn-out" ring with an aperture the same size as that in the stage, so that the disks which fit one will fit the other. The construction of the arm at the top of, and at right angles to, the limb is peculiar, and unlike that in any

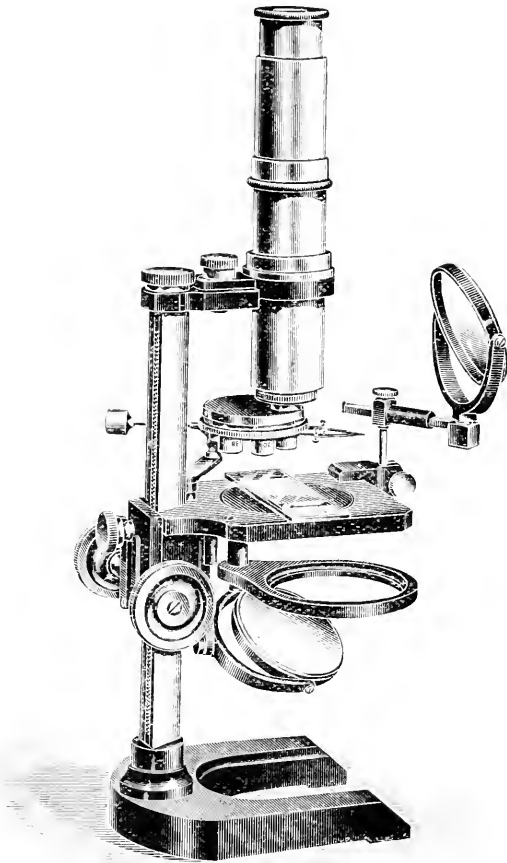

FIG. 94.

other Microscope. It is very short, and it is capable of being rotated and clamped in any position by a screw. This arm has a broad V-groove, to which a second arm, carrying the optical part, can be attached and clamped by another screw. This is a novel and excellent mode of attachment: half a turn of the screw firmly fixes it in position, and half a turn releases the body from the limb. It would be difficult to devise

a better mode of attachment for a body to a limb, for it is simple, rapid in use, and perfectly firm.

Having described the mechanical, we will now pass on to the optical part. (1) To the horizontal arm a short tube, holding a wheel of six "loups," can be attached by the method first described. These "loups"

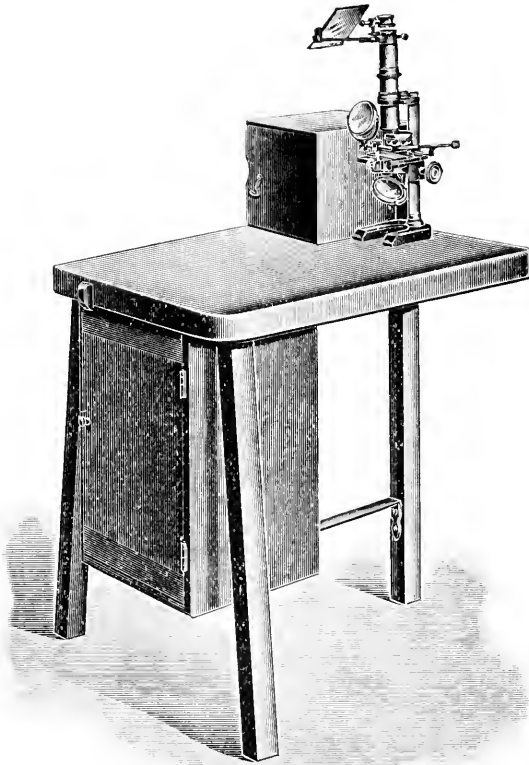

FIG. 95.

vary in power from 2 to 9 diameters. (2) A compound body with a fixed eyepiece, and another wheel of six lenses, giving powers from 12 to 38 diameters, can be attached in place of the "loups."

The drawing apparatus is an Abbe camera. The top of the special table measures 2 ft. by 1½ ft., and is of pitch-pine 1½ in. thick. Its height above the floor is 2 ft., and it has three legs of oak 1½ in. square. The two back legs are braced by an iron bar, and a second bar joins this to the front leg. Beneath the table-top, and attached to it, is a cupboard, which holds the Microscope cabinet. When the Microscope is used for drawing, as in fig. 95, a box without a lid is laid upon its side, and its

lower side is clamped to the table-top by an ordinary brass bench-clamp. The bottom of this box measures $8\frac{1}{2}$ in. by 7 in., by 7 in. deep. Therefore, its side, which forms the drawing-board, measures $8\frac{1}{2}$ in. by 7 in. in area, and is 7 in. above the top of the table.

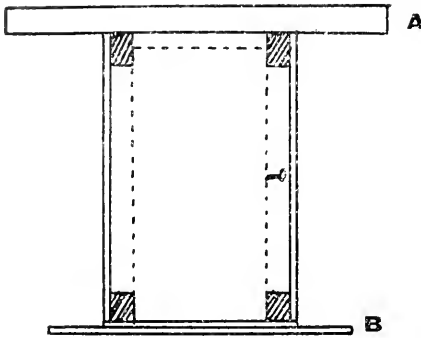

FIG. 96.

When so placed, the path of the rays from the prism of the camera to the drawing-board is 10 in.

The instrument (fig. 95) is shown as arranged for drawing with the compound body; but when the "loups" are used, the Microscope is placed upon a box 8 in. by 6 in., and $3\frac{1}{2}$ in. deep. The Microscope is thus raised $3\frac{1}{2}$ in., and the camera prism kept the same height as with the compound body, and the drawing-board is 10 in. from it as before. The cupboard has four chocks of wood, $2\frac{1}{2}$ in. by $1\frac{3}{8}$ in. at each angle (fig. 96). These serve two purposes:—First, they greatly strengthen the cupboard, and enable it to be attached to the table-top by large screws; further, the whole table is made very rigid, because the iron brace is firmly screwed to the lower chocks in the cupboard. Secondly, the chocks form a packing for the Microscope cabinet, and allow it to be put into the cupboard with the key in the lock.

The main use of this Microscope is for the examination of unmounted objects, botanical, entomological, geological, etc. If the field-lens is removed from the body, and a similar brass adapter, without any lens, screwed into its place, the body is made similar to that of an ordinary Microscope, and ordinary eye-pieces of the Continental gauge can be

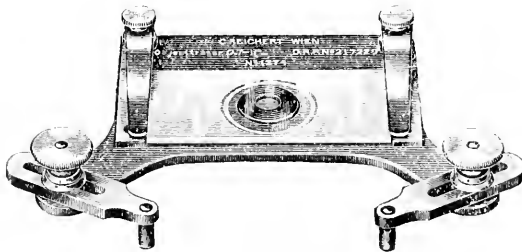

FIG. 97.

used. When the body is charged with a No. 4 complanat eye-piece, the powers given by the wheel of six object-glasses varies from 30 to 100 diameters. So by this addition of a screw adapter we have at our disposal a range of eighteen powers from 2 to 100 diameters, and the instrument has a considerable range of usefulness for general biological work.

Reichert's Dark-ground Illuminator with Arrangement for Centring on a Plain Stage.—This apparatus was fully described by

Mr. Niemeyer at the May Meeting (see p. 426). The blocks for the illustrations were not obtained in time for insertion in a previous number.

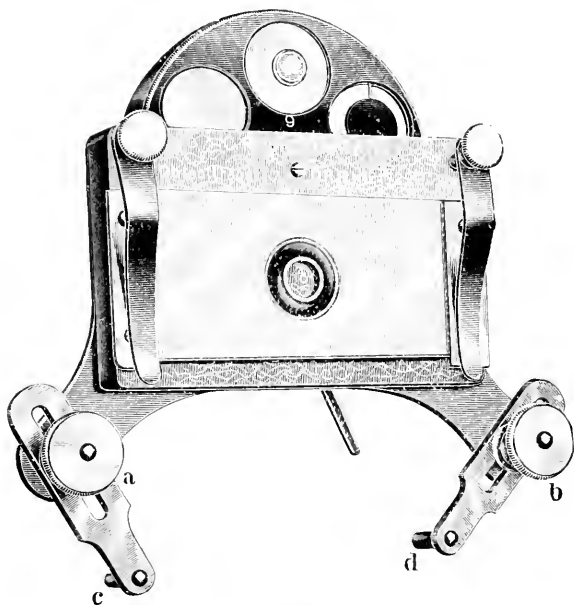

FIG. 98.

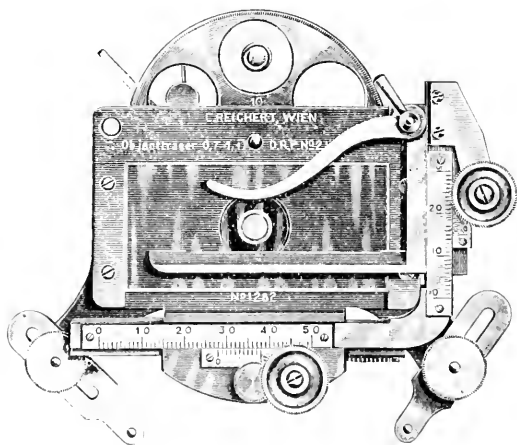

FIG. 99.

(4) Photomicrography.

Stereoscopic Photomicrography.*—A special Microscope has been devised for the purpose of taking stereoscopic photomicrographs, the body of which moves laterally in the arc of a circle, with the specimen as the axis. After the first exposure the body-tube is slightly moved to one side, the optical system keeping in a line with the object, and the second plate exposed. This ingenious and successful instrument is, however, says J. I. Pigg, rendered superfluous by a much simpler plan.

Some years ago a comparatively easy and effective method was introduced for taking stereoscopic photographs with the Microscope. Instead of altering the position of either the specimen or the Microscope-tube, the first exposure is made with one-half of the back-combination of the objective, covered with some opaque material. The back lens-covering is then moved to the other side of the objective, and the second plate exposed. The two negatives are thus taken through different halves of the back-lens, and the consequent separation of the two points of view produces the stereoscopic effect.

An improved variation of this mode of making a stationary lens take two pictures from different standpoints, has since been adopted by photomicrographers. Instead of using the two halves of the back-combination of the objective, a diaphragm with a circular aperture cut near the edge of the stop is fitted behind the lens. After the first exposure the diaphragm is turned round, so that the aperture is at the opposite side of the objective; the second negative is then taken. The use of a small aperture, in place of half the area of the lens, effects a considerable improvement in the stereoscopic effect, owing to the increased separation of the two points of view, but the exposure is proportionately increased. The worker must exercise his own discretion as to the exact size and position of the aperture. If the diameter of the lens will allow of the aperture being placed at a fair distance from the centre, the stereoscopic relief will be considerably improved.

This method of stereoscopic photomicrography is obviously most suitable for low-power work, and the beginner should confine his attention to low magnifications. The best results are obtained from objects illuminated by reflected light, and really beautiful effects can be secured from common microscopic objects. Unless an arc lamp is available, specimens to be photographed as opaque objects should be of a light colour, or the exposure will be abnormally prolonged, as a considerable amount of light is cut off by the diaphragm. Diaphragms for stereo-micro work may be purchased, but the amateur can easily make his own by punching out a hole of the required size near the edge of a circular piece of black paper. This diaphragm can then be fixed in position at the back of the objective, by being pressed into the mount. When the diaphragm is moved round for the second exposure, the aperture must be exactly opposite the position it occupied for the first negative.

Insects' eggs, foraminifera, small insects, and seeds of plants, make excellent subjects as opaque objects for reflected light; crystals, botanical sections, filamentous algae, and foraminifera mounted in liquid cells, are

* Photographic Scraps, vi. (1911) pp. 279-80.

all sufficiently transparent to be taken by transmitted light without any previous preparation. One of the chief obstacles to success in stereo work with the Microscope, is the small depth of focus given by microscopic objectives. If the specimen has considerable depth of structure, the lowest power possible must be used, and the necessary magnification obtained by the eye-piece. When transparent objects are photographed, a narrow angle of illumination should be adopted. This will decrease resolution, but increase depth of focus. When a specimen has strong contrasts in light and shade, it is sometimes advisable to give a normal exposure for the first negative, and then over-expose the second plate, in order to get detail in the darker portions of the subject. A much better effect is given by this plan, when the two prints are viewed through the stereoscope. In the same manner, if a double-stained specimen is being photographed, the first negative should be exposed for the deeper colour, and the second for the lighter shade. Generally speaking, for stereoscopic work, soft negatives give the best effects, and no pure whites should appear in the finished print. The negatives should be printed on smooth paper, such as Ilford Glossy Gaslight.

(5) Microscopical Optics and Manipulation.

Pupil of an Optical System with regard to Perspective.* — C. Beck has found that the so-called "entrance and exit pupils" of an optical system may be used, in connexion with the Gauss planes, for explaining the action of optical instruments as regards the perspective of the images formed. It will be remembered that the Gauss planes enable us to refer the action of a complicated optical system to an equivalent single lens placed successively in two positions—the entrance equivalent-plane and the exit equivalent-plane. By this means, assuming that the optical system is corrected in such a manner that the oblique rays and those far from the axis act in the same manner as the direct axial rays, the position and size of images can be determined with accuracy; but the perspective of the image cannot be correctly explained by aid of the Gauss planes alone. The "pupils," however, account for this apparent discrepancy, and, by assigning the correct position to these two apertures, or pupils, we can investigate the perspective of an image without taking further consideration of the system itself; just as, by assigning the correct position to the two Gauss planes, we can investigate the size and position of the images, irrespective of the system itself. The pupils, in fact, determine what rays form the image, and they further determine the perspective without invalidating the results given by the Gauss system as to the positions and sizes of the focused images. The author discusses in detail several typical cases, and, in particular, clears up a very interesting point in the practical use of telephotographic lenses. Such lenses have usually very small apertures, and possess a large degree of so-called depth of focus, and are consequently capable of depicting a great range of depth in the object. For distant views the perspective will, on the whole, give the effect produced by photographing with an ordinary lens, of about the same focal length as the equivalent focal length of the telephoto system. But if a telephoto lens be used for near objects, as, for

* Proc. Roy. Soc., Series A, lxxxv. (1911) pp. 462-70 (8 figs.).

instance, for full-sized portraits, the perspective of a 9-in. telephoto lens, with exit pupils arranged so as to come between the constituent lenses, will give the perspective effect produced by an ordinary lens of $17\frac{1}{2}$ -in. focus; or, if half-size, of a lens $14\frac{1}{2}$ in. This accounts for the very

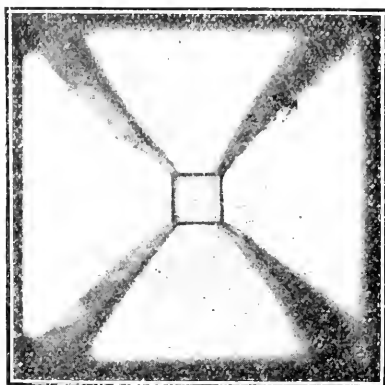

FIG. 100.

pleasing portraits obtained by the use of the telephoto lens. For all purposes, except extreme distance, the perspective foreshortening in a photograph taken with a telephoto lens is less pronounced than would be expected from a lens of that focal length.

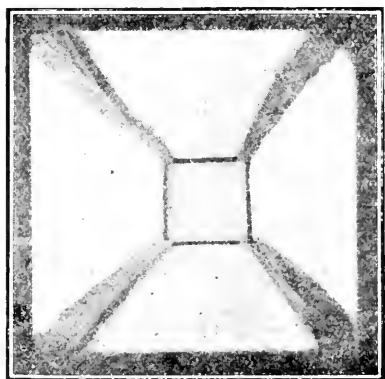

FIG. 101.

Figs. 100 and 101 show two photographs taken, the one (fig. 100) with an ordinary photographic lens, the other (fig. 101) with the above telephoto lens. Both lenses had the same equivalent focal length. The object photographed was a parallel tube about 5 ft. long, built up of laths covered with tissue paper. The photograph was taken looking

down the tube, and the nearest end was in both cases placed at such a distance as to give the same sized image of the object. It will be noticed that the telephoto lens gives a totally different and less steep perspective effect than the ordinary lens.

(6) **Miscellaneous.**

Quekett Microscopical Club.—The 476th Ordinary Meeting of the Club was held on Tuesday, October 24, the President, Professor E. A. Minchin, M.A., F.Z.S., in the Chair. A paper by Mr. E. M. Nelson, F.R.M.S., on "An Improved Compound Microscope by James Mann, 1751," was read by the Hon. Sec. It is, in the main, a copy of J. Cuff's (1744), with various improvements. It is less heavily built, however, and is probably the second Portable Compound Microscope. The instrument originally belonged to the celebrated Dr. Johnson. "A General Account of the Spring-tails (Collembola)" was given by Mr. J. W. Shoebottom, N.D.A. Together with the orders Protura and Thysanura, they belong to the sub-class Apterygota, class Insecta. The various parts of the Collembola were fully described, especial attention being given to the very typical organs, the ventral tube and the spring. Previously considered to be scavengers only, it is now thought that they may do considerable damage to growing crops. In Ireland they have been found feeding on the leaves of tobacco plants. Nearly 500 species have up to the present been recorded, of which 107 are British.

B. Technique.*

(1) **Collecting Objects, including Culture Processes.**

Cultivation of Spirochætes.†—G. Arnheim gives an account of his microscopical and cultural investigations of spirochætes associated with gangrene of the lung and ulcerating carcinoma. He finds in these lesions a definite species of spirochæte, of which, however, the colonies cannot be distinguished from those of other species. These spirochætes are found in carcinomata both of men and of animals, and have been found in the blood of normal rats and mice. They cannot be demonstrated in growths that have not ulcerated.

For his cultivation experiments the author uses a modification of Schereschewsky's method. Material containing spirochætes is introduced into horse-serum, which has been heated for a short time to 75° C. For the isolation of spirochætes from a mixed culture, it is necessary to examine various portions of the mixed growth for the presence of these organisms, and replant it in successive attenuations.

Pure Cultures from a Single Cell.‡—S. L. Schouten has improved his method § for isolating single cells under the Microscope. In the

* This division contains (1) Collecting Objects, including Culture Processes; (2) Preparing Objects; (3) Cutting, including Embedding and Microtomes; (4) Staining and Injecting; (5) Mounting, including Slides, preservative fluids, etc. (6) Miscellaneous.

† Centralbl. Bakt., 1^{te} Abt. Orig., lix. (1911) pp. 20-34.

‡ Konink. Akad. Wetenschap. te Amsterdam, xiii. (1911) pp. 840-50 (1 pl.).

§ See this Journal, 1901, p. 331.

simplified apparatus there is only one needle-holder, placed to the left of the Microscope. The plate on which the Microscope formerly stood is now omitted, and the instrument adjusted by hand.

A. W. Nieuwenhuis* describes an apparatus for the cultivation of micro-organisms from one cell. The description of the apparatus and the procedure is lengthy, and refers to a stand placed by the side of the Microscope. To the top of the stand is attached a needle specially constructed for the purpose of fishing out the desired cell from a culture placed on the stage of the Microscope.

Cultivation of Spirochæta pallida.†—H. Noguchi inoculated his media not directly from human lesions, but from the artificially infected testicular tissue of the rabbit. The only medium which proved suitable was serum-water, to which a piece of sterile rabbit-tissue was added, preferably kidney or testicle. The serum-water in test-tubes is rendered suitable for anaerobic cultivation by a layer of paraffin oil poured on its surface. After the first cultivation strict anaerobiosis is not essential, and the organism can be subcultured to solid media. The first cultures are usually contaminated by bacteria, but these are separated by means of two procedures. In the first the spirochætes are grown through filters which retard the passage of other organisms, while the second method depends on the fact that in stab-cultures the spirochætes grow away from the line of puncture into the surrounding medium, while other organisms fail to do so. The spirochætes cultivated by this method, when inoculated into the rabbit's testicle, produce characteristic histological changes, and are found growing freely in the infected tissue.

New Method for making Blood-agar for Cultivating Bacillus influenzae.‡—W. Thalheimer recommends the following modification of Pfeiffer's method. Its chief advantage over that of Pfeiffer is that the laking agent is one which does not interfere with bacterial growth and does not have to be removed. Freshly-drawn beef-blood obtained from an abattoir was collected in a wide-mouthed jar, and defibrinated by shaking with a number of medium-sized marbles. This was laked by adding an equal part of distilled water, and rendered free from bacteria by passing through a sterile Reichel filter. This yielded a clear red fluid, and 20–30 c.cm. of this were added to a litre of melted agar at 45° C. and poured into sterile tubes. The medium thus obtained was perfectly clear, bright-red, and of the same density of colour as ordinary blood-agar. On this medium *Bacillus influenzae*, *Streptococcus mucosus*, and *Genococcus* grew luxuriantly.

(2) Preparing Objects.

Celloidin Decalcification Method.§ — C. F. Bödecker describes a simplified procedure for decalcification. It consists in mixing 10 c.cm. nitric acid (sp. gr. 1.15) with 30 c.cm. of a methyl-alcohol solution of celloidin. The fluid must be well stirred with a glass rod; the thick

* Konink. Akad. Wetenschap. te Amsterdam, xiii. (1911) pp. 566–76 (2 pls.).

† Journ. Amer. Med. Assoc., July 8, 1911, through Lancet (1911) ii. p. 536.

‡ Johns Hopkins Hosp. Bull., xxii. (1911) pp. 293–6.

§ Zeitschr. wiss. Mikrosk., xxviii. (1911) pp. 158–60 (1 pl.).

jelly is then squeezed under a pressure of about 80 kilos, between thick layers of bibulous paper, in order to remove as much water as possible. The acid-celloidin is next mixed with twice its bulk of methyl-alcohol, whereby it is quickly dissolved. A piece of enamel, 0.5 mm. thick, takes about six days to decalcify. If gas bubbles be given off the process is going on too rapidly. The author alludes to previous communications, for which see this Journal, 1908, pp. 775, and 1905, p. 764.

Fixation and Staining of Glycogen.*—F. Zieglwallner describes fixation and staining methods for the simultaneous demonstration of glycogen and fat, and gives the following formulæ:—1. One p.c. chromic acid solution in 84 p.c. alcohol, 15; 2 p.c. osmic acid, 4; acetic acid, 1. The solution should be prepared immediately before use.

2. Saturated sublimate solution, 20; 2½ p.c. osmic acid, 20; acetic acid, 10; absolute alcohol, 50. This fixes small pieces in from 8 to 12 hours. On removal the pieces are washed for 24 hours in 50 p.c. alcohol, to which a few drops of tincture of iodine have been added. In order to retain the blackening it is advisable to convert the osmium into sulphide by treating the sections or pieces with 70 p.c. alcohol, to which a small piece of Na_2S has been added.

3. By saturating a solution with formula very similar to No. 2 with dextrose, another fixative which gives fair results is obtained.

4. 10 p.c. trichlor-lactic acid for 3 to 4 hours, followed by 50 p.c. alcohol.

5. Trichlor-lactic acid, 9; 2 p.c. osmic acid, 24; acetic acid, 9; distilled water, 58. In this small pieces remain for 10 to 12 hours, after which they are thoroughly washed in 50 p.c. alcohol.

Various methods of staining glycogen are then alluded to, the best being Bleu-de-Lyon, as it gives considerable contrast.

Studying Amœba.†—B. Puschkarew pipettes off from a "zoological culture" the amœbæ, in company with algæ and bacteria, on to an agar-plate. After 6 or 7 hours, a piece, which should not exceed 1 c.cm., is cut out. The piece is placed on a Hansen's slide and a clean cover-glass imposed. After ½ hour, during which time the amœbæ will have crawled on to the cover-glass, the space between the ring of the slide and the agar slip is filled with fixative, the cover-glass not being removed. The fixative used was either sublimate-alcohol or 2 p.c. osmic acid; the former being allowed to act for 20 to 30 minutes, the latter for 10 to 20. The fixative is then removed with a pipette and replaced with iodine-alcohol or 50 p.c. alcohol; the former after sublimate, the latter after osmic fixation. After allowing these reagents to act for 30 to 60 minutes, the cover-glass may be removed. The cover-glass is then washed in water. It should be mentioned that no procedure will get rid of all the bacteria, and these are sometimes very frequent. The preparations may then be stained by the Romanowsky-Giemsa method, or with Heidenhain's iron-hæmatoxylin.

The author's illustrations are extremely effective.

* Zeitschr. wiss. Mikrosk., xxviii. (1911).

† Zeitschr. wiss. Mikrosk., xxviii. (1911) pp. 145-50 (2 figs.).

Washing and Dehydrating Apparatus.*—By means of the apparatus devised by B. Romeis (fig. 102) such processes as the washing, dehydration, or decalcifying of fixed preparations may be carried out without trouble and without undue manipulation. The supply tube A, connected with a water-supply, leads to the cylinder C. This cylinder is drawn out at its lower end, and contains a perforated porcelain disc which rests upon the narrowing part. This cylinder has a twofold purpose: it may be used for washing tissues which can stand rough treatment, or, by the obstruction of perforations in the porcelain disc, it may serve to regulate the flow in the distal portions of the apparatus. By means of the tube E the cylinder communicates with the funnel-shaped vessel F, which contains a series of perforated trays. This vessel is closed at the top with a stopper, pierced by the outflow tube G. A perforated porcelain disc is

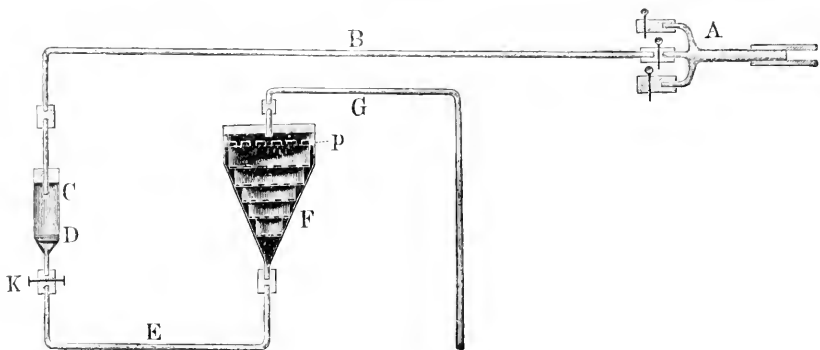

FIG. 102.

placed below this stopper. Objects to be treated are placed in these trays. When washing is complete, and dehydration is to begin, the tube B is disconnected from the water supply and linked up successively with flasks of mounting alcohols. Decalcifying is carried out in an analogous manner.

(4) Staining and Injecting.

Injection of Fusible Alloys in Microscopical Anatomy.†—L. Vialleton and A. Juillet find that Wood's alloy gives excellent results when injected into respiratory tubes or blood-vessels. It is fusible at 70°, and is composed of: bismuth 7, lead in sticks 2, tin in sticks 2, cadmium 2. The bismuth is pounded up and then melted in an iron crucible; a stick of lead held with iron tongs is heated by means of a blow-pipe, and the molten metal allowed to drop into the bismuth. The tin is treated in a similar manner, and then the cadmium is thrown in. The alloy is vigorously stirred with an iron rod, and the mixture kept at a temperature of 120°, for if over-heated the cadmium becomes too much oxidized. To inject the alloy, say into a bronchial tree or pulmonary artery, a copper funnel with a capacity of about 60 c.c.m., the tube being 2.5 mm. in diameter, is used. To the end of the tube metal cannulas

* Zeitschr. wiss. Mikrosk., xxviii. (1911) pp. 12-17.

† C.R. Soc. Biol. Paris, lxxi. (1911) pp. 249-51.

of varying size may be fitted as required. The funnel is placed some 20 cm. above the specimen to be injected; this height gives sufficient pressure. The funnel and cannula are kept warm by means of a ring-burner and gas flame during the injection; the alloy is then poured into the funnel. When the specimen is sufficiently injected it is allowed to cool, and after the lapse of $\frac{1}{2}$ hour it may be cut off from the cannula. It is then placed in cold running water for 2 hours, and on removal all superfluous parts are removed. In order to obtain the casts of the lumina of the tubes or vessels, the organic material is digested away in artificial gastric juice at 50°. After 24 hours the preparation is washed in running water and then, if necessary, further cleaned with a brush.

New Method for the Detection of Tubercle bacilli in Sputum.*

F. W. Ehrich recommends the following procedure. A quantity of the sputum is shaken up with "antiformin" in a glass-stoppered vessel, such as a measure cylinder ("antiformin" = 15 p.c. liq. sod. hydrat. + liq. sodae. chlorinat. $\bar{a}\bar{a}$), the proportion of "antiformin" depending upon the consistence of the sputum; if the latter is very viscid or dense an equal proportion may be required; if thin, then half the amount may suffice. The mixture is occasionally shaken during five minutes; it is then diluted with a volume of distilled water approximately ten times as great as that of the "antiformin" used, and again shaken for a few minutes. Finally, there is added a mixture of equal parts of ether (methylated ether will do) and acetone equal in volume to that of the water. It is shaken once more for a few seconds and the whole allowed to stand. In a few minutes the contents of the bottle will be found to separate into three layers. The middle layer, appearing as a more or less dense white ring, will contain nearly all the tubercle bacilli that may be present in the sputum, and can be drawn off with ease by means of a pipette fitted with a teat. The density of this middle layer can be increased after it has been pipetted off, if desired, with the help of a centrifuge (an ordinary hand centrifuge will answer the purpose), but it is not necessary. A film is made, dried, and fixed in the usual way, by passing it through a flame. Before staining the film it is immersed for a few seconds in 5 p.c. sulphuric acid to neutralize any adhering alkali, and washed to remove the acid. If the examiner is interrupted, or otherwise pressed for time, the whole mixture may be allowed to stand till the next day or even longer; the acid-fast property of the bacilli is not affected by the delay. The sputum-antiformin mixture should be diluted with distilled not with tap-water, as the latter may contain acid-fast bacilli.

Negative Staining of Bacteria,† — II. Fischer, after alluding to Burri's indian-ink method, describes his experience with anilin dyes, such as Congo-red and nigrosin. A drop of the fluid containing bacteria is mixed with a drop of similar bulk of a saturated solution of Congo-red or nigrosin, and a film made in the usual way. When dry the film may be mounted in balsam. The solution may be heated previous to use.

* Brit. Med. Journ. (1911) ii. p. 596.

† Zeitschr. wiss. Mikrosk., xxvii. (1910) pp. 475-6.

(6) *Miscellaneous.*

Preserving Brains.*—A. Stürcke suspends brains in 15 p.c. formalin for 8 to 14 days. On removal the surface is carefully dried; it is then immersed, vertex downwards, in a vessel filled with hard paraffin, heated to at least 15° above its melting-point; a quick turn covers the surface with a mantle of paraffin. Should any gaps be found, the places implicated must be treated anew. Brains treated in this manner will, even after five years, give satisfactory preparations by Nissl's or Weigert's methods of staining.

Turbidometer for Counting Vaccines.†—C. F. Pawson and H. P. Bassett have devised an apparatus for estimating the number of bacteria contained in a certain volume of an autogenous vaccine. To the sliding bar of the mechanical stage of a Microscope is fixed a vertical rod—a hypodermic needle will serve—which dips into a rectangular glass box, fixed to the table. At one end of the box is a transparent circle which admits light; the other end is attached to a cylindrical metal tube, leading to a semicircular eye-shield, at the edge of the table. This shield screens the observer. If the box be filled with a turbid liquid, and the vertical rod be observed through the tube, as it is moved from the proximal towards the distal end of the box, a point is reached where, owing to the opacity of the intervening fluid, it disappears from view. The point at which this takes place depends upon the degree of turbidity. As this only gives a relative observation, it is necessary to have a standard. McFarland has devised a series of test-tubes containing different amounts of freshly precipitated barium sulphate. Tube No. 5 of his series contains sufficient precipitate to produce turbidity equal to that of a suspension of fifty million bacteria per cubic centimetre. This is taken as the standard. The vertical rod is moved to the proximal end of the box, and a reading taken from the scale on the mechanical stage. The box is filled with standard suspension, and the rod is made to move until it can no longer be seen. A second reading is taken. The difference between these readings gives the amount of translation of the rod. Similar observations are taken with the vaccine which is under investigation. The excursions of the vertical rod are inversely proportional to the turbidity of the samples; and so from these data, an estimate may be formed of the strength of the bacterial emulsion.

Agglutination of Trypanosomes.‡—Lange describes a method by which a macroscopic agglutination test for trypanosomiasis may be carried out. For this purpose the author makes use of a suspension of trypanosomes obtained from the blood of a highly-infected animal. The blood is lightly centrifugalized, so that the organisms settle into a definite layer, which is then removed by means of a pipette. This emulsion is then washed in salt solution, centrifugalized and suspended in a fresh quantity of salt solution. A small quantity of formalin is added, and the suspen-

* Zeitschr. wiss. Mikrosk., xxviii. (1911) pp. 150-1.

† Centralbl. Bakt., 1te Abt. Orig., lviii. (1911) pp. 638-40.

‡ Centralbl. Bakt., 1te Abt. Ref., i. (1911) Beih. pp. 171-7.

sion will retain its efficiency for the purpose of these tests for a period of from four to eight weeks. When shaken up, the suspension should be homogeneous and of a greyish-white colour. It should not agglutinate in the presence of a normal serum in a dilution of 1 in 50. Spontaneous agglutination may take place if the washing process is too thorough.

The test is carried out in a similar manner to that used with bacterial emulsions. The serum under observation, in suitable dilutions, is put in tubes with equal quantities of the suspension. Controls are also put up. The tubes are incubated for 6 to 12 hours, and, if necessary, allowed to stand at room temperature for 20 hours after incubation. When examining the tubes, it is necessary to shake them up and examine the floating particles. It is not easy to distinguish degrees of agglutination.

SOMMERFELDT, E.—*Ueber die Fortschritte der mikroskopischen untersuchungsmethoden für mineralogie und analytische chemie während der letzten Jahre.*

Zeitschr. wiss. Mikroskr. xxviii. (1911) pp. 183-206 (2 figs.).

Metallography, etc.

Aluminium-magnesium Alloys.*—W. Broniewski has made determinations of the various electrical properties of alloys of aluminium and magnesium; the results indicate the existence of two compounds, $AlMg$ and Al_2Mg_3 . Alloys corresponding to the formula Al_4Mg and $AlMg_2$ were found to be heterogeneous in microstructure.

Bismuthides.†—A. G. Vournasos has prepared sodium bismuthide Na_3Bi , the existence of which is indicated by thermal analysis of the system, by adding bismuth to sodium melted under paraffin. Potassium bismuthide K_3Bi is obtained in a similar manner.

Arsenides of Tin.‡—P. Jolibois and E. L. Dupuy have prepared alloys by heating known weights of arsenic and tin together in sealed tubes, at $650^\circ C$. Sections for microscopical examination were etched with ferric chloride solution. The presence of the compounds Sn_4As_3 and $SnAs$ was indicated.

A thermal investigation of the arsenic-tin system by N. Parravano and P. de Cesaris § indicates the existence of the compounds Sn_3As_2 and $SnAs$.

Alloys of Silver with Cadmium.¶—G. J. Petrenko and A. S. Fedorow have made a thermal and microscopical investigation of the silver-cadmium system. Six series of solid solutions, with intervening gaps, are formed. The compound $AgCd$ results from a reaction occurring in the solid state. The compounds $AgCd_3$ and Ag_2Cd_3 are probable. The existence of $AgCd_4$ was disproved by quenching experiments.

* Comptes Rendus, clii. (1911) pp. 85-7 (6 figs.).

† Comptes Rendus, clii. (1911) pp. 714-15.

‡ Comptes Rendus, clii. (1911) pp. 1312-14.

§ Atti R. Accad. Lincei, xx. (1911) 1, pp. 593-6, through Journ. Chem. Soc., c. (1911) p. 613.

¶ Zeitschr. Anorg. Chem., lxx. (1911) pp. 157-69; lxxi. (1911) pp. 215-18 (15 figs.).

Selenium-antimony System.*—H. Pólabon has examined microscopically numerous selenium-antimony alloys, and concludes that the only compound obtainable by direct fusion of the elements is Sb_2Se_3 . Within certain limits of composition, the alloys, in the molten state, consist of two phases, of nearly the same density. Measurements of electrical resistance of the alloys were consistent with the existence of Sb_2Se_3 .

Alloys of Noble Metals.†—W. Geibel has determined the electrical resistance and its temperature co-efficient, the thermoelectric power against platinum, and the tensile strength, of palladium-silver, palladium-platinum, platinum-iridium, platinum-gold, and platinum-silver alloys. Palladium and platinum appear to form a continuous series of solid solutions, as also do palladium and silver.

Iron-carbon System.‡—R. Ruer and N. Iljin prepared a pure cast-iron containing 4 to 4.5 p.c. carbon, nearly all in the graphitic state. Small specimens were heated for 6 hours at different temperatures in the range 600° – 1120° C. and quenched. The percentage of combined carbon then found in the specimen is held to indicate the lower limit of solubility of elementary carbon in iron at the temperature to which the specimen had been heated. The solubility curve is parallel to that of cementite, reaching a maximum of 1.25 p.c. at 1120° . By allowing specimens to cool from 1100° C. and quenching at different temperatures, it was shown that temper-carbon does not separate above 800° C., but that the length of time of heating above 800° C. influences the amount of temper-carbon separating below 800° C. It is suggested that "centres of crystallization" form at temperatures above 800° C.

Growth of Cast-irons after Repeated Heatings.§—H. C. H. Carpenter has continued his investigation of this phenomenon. Phosphorus, sulphur, and manganese tend to diminish growth. Dissolved gases have no influence when more than 3 p.c. silicon is present: their influence is most potent when silicon does not exceed 1 p.c.: they may then cause a growth of 10 p.c. A table is given showing how growth increases with increase of silicon content. An alloy containing 2.6 p.c. carbon, 0.6 p.c. silicon, and 1.6 p.c. manganese, showed no signs of growth after 150 heats; it appears to be a suitable material for annealing ovens and other objects in which growth on repeated heating is objectionable.

Iron-silicon-carbon Alloys.||—W. Gontermann explains the equilibrium diagram for the range Fe– Fe_3C –FeSi of this ternary system. The diagram has been derived from the thermal analysis of numerous alloys. The two chief types of crystal separating from the melt are—(1) mixed crystals of iron, silicon, and carbon, termed silico-austenite; (2) mixed crystals of the compounds Fe_3C and FeSi, termed silico-cementite. Views of the three-dimensional model of the ternary system are given.

* Comptes Rendus, clii. (1911) pp. 1302–5; cliii. (1911) pp. 343–6.

† Zeitschr. Anorg. Chem., lxx. (1911) pp. 240–54 (9 figs.).

‡ Metallurgie, viii. (1911) pp. 97–101 (3 figs.).

§ Journ. Iron and Steel Inst., lxxxiii. (1911) pp. 196–248 (17 figs.).

Journ. Iron and Steel Inst., lxxxiii. (1911) pp. 421–75 (20 figs.).

Malleable Castings.*—D. M. Levy explains the changes occurring during the annealing of white cast-iron in the production of malleable castings, by the ore-annealing process and by the black-heart process, in the light of the equilibrium diagram of the iron-carbon system. The influence of silicon, manganese, and sulphur is considered.

Magnetic Properties of Nickel Steels.†—E. Colver-Glauert and S. Hilpert have determined the magnetic properties of three steels containing respectively 5.9, 24.3, and 32.9 p.c. nickel, 0.37, 0.24, and 0.30 p.c. carbon. The measurements were made at room temperature, after the specimens had been quenched, or slowly cooled, from various temperatures, or had been cooled to temperatures ranging down to -180°C . The authors conclude that there is no connexion between magnetic properties and microstructure. The microstructures of commercial nickel steels are stated to be practically the same as those of meteoric iron. No evidence of the non-magnetic character of γ -iron—if γ -iron exists—was obtained.

Chromium Steels.‡—A. Portevin has cooled two steels containing 0.12 p.c. carbon, and 13 and 17 p.c. chromium respectively, extremely slowly from 1300°C . The steels were then found to consist of ferrite with interspersed carbide. The martensitic structure obtained by moderately slow cooling from 1100°C . is accordingly regarded as characterizing a metastable state.

Nickel Steels.§—A. McWilliam and E. J. Barnes have studied a series of eight steels containing 3 p.c. nickel, manganese less than 0.2 p.c., the carbon increasing from 0.06 to 0.91 p.c. Tensile and alternating stress tests were made after various heat-treatments, as in former investigations by the same authors. Heating and cooling curves were taken, and the heat-treated specimens were microscopically examined. The pearlite composition lies between 0.74 and 0.91 p.c. carbon.

Influence of Vanadium on Iron and Steel.||—A. McWilliam and E. J. Barnes have made tensile and alternating stress tests of seven steels containing about 0.2 p.c. vanadium, carbon varying from 0.09 to 1.32 p.c., after different heat-treatments. The microstructure was studied and heating and cooling curves were taken.

W. H. Hatfield¶ has prepared five cast irons containing 0 to 0.65 p.c. vanadium. A chemical and microscopical investigation indicated that vanadium tended to maintain the carbon in the combined state.

Troostite.**—An investigation of the properties of tempered steel has led A. McCance to conclude that (1) troostite consists essentially of α -iron which is in the amorphous condition, or which has not yet attained its crystalline state of ferrite; (2) troostite contains carbon in suspension, and not in solution, as carbide of iron.

* Foundry Trade Journal, xiii. (1911) pp. 321-5 (1 fig.).

† Journ. Iron and Steel Inst., lxxxiii. (1911) pp. 375-411 (35 figs.).

‡ Comptes Rendus, cliii. (1911) pp. 64-6 (2 figs.).

§ Journ. Iron and Steel Inst., lxxxiii. (1911) pp. 269-93 (18 figs.).

|| Journ. Iron and Steel Inst., lxxxiii. (1911) pp. 294-317 (16 figs.).

¶ Journ. Iron and Steel Inst., lxxxiii. (1911) pp. 318-31 (20 figs.).

** Proc. Inst. Mech. Eng., 1910, pp. 1661-98 (21 figs.).

Internal Structure of Pearlitic Steel.*—M. Oknoff has applied the histological method of cutting serial sections to the investigation of the structure of steel in space. Pearlitic specimens containing 0.1, 0.7, and 1.7 p.c. carbon, were examined by successively grinding thin layers off the surface, a marked field being photographed at each stage. The continuity of the pearlite grains was thus established, and their solid form determined.

Crystallization of Steel.†—E. F. Lange describes some masses of perfectly developed "pine-tree" crystals found in the cavity of the sinking-head of a large steel casting. Some of the masses of the crystals pendent from the upper portion of the cavity were as much as 15 in. in length.

Influence of Impurities on the Corrosion of Iron.‡—J. W. Cobb finds that pure iron is electro-positive to most of its impurities, such as phosphide, sulphide, carbide, oxide, and silicate of iron, and carbon (graphite). Sulphide and silicate of manganese are electrically non-conducting. Microscopic examination of iron in contact with particles of impurities, in a corroding solution, showed that the iron went into solution around the particles, though certain rapidly appearing corrosion centres were not visibly related to impurities. Manganese silicate on iron was found to be inactive.

Changes in Properties of Metals upon Working §—G. Tammann further develops the view that the strengthening of metals by cold-working results from the splitting up of the crystals into smaller elementary crystals. Alloys of two metals of about the same strength are considerably stronger than either of the pure metals, since the crystallites of which the alloys are composed are smaller than those of which the pure metals are constituted.

Metallic Fog in Fused Salts.||—R. Lorenz, G. v. Hevesy, and E. Wolff, show that when lead is heated under fused lead chloride to 600° C., the darkening of the lead chloride is due to solution of lead in it. The lead settles out as a black "fog" on cooling. The authors describe a titration method for the estimation of the lead dissolved in the molten chloride, and have determined the solubility between 500° and 700° C.

Crystallization of Cast Metals.¶—C. H. Desch describes the process of solidification of a molten metal by the formation of crystallites.

ANDSTRÖM, V.—**Rusting of Iron.**

Zeitschr. Anorg. Chem., lxi. (1910) pp. 10-21 (3 figs.).

BAAR, N.—**Alloys of Molybdenum with Nickel, of Manganese with Thallium, and of Calcium with Magnesium, Thallium, Lead, Copper, and Silver.**

[The equilibrium diagrams of the binary systems have been determined by thermal and microscopical methods.]

Zeitschr. Anorg. Chem., lxx. (1911) pp. 352-94 (13 figs.).

* *Metallurgie*, viii. (1911) pp. 138-9 (35 figs.).

† *Engineering*, xci. (1911) p. 706.

‡ *Journ. Iron and Steel Inst.*, lxxxiii. (1911) pp. 170-95 (14 figs.).

§ *Nachrichten Kgl. Ges. Wiss. Göttingen*, 1911, pp. 181-96 (2 figs.).

Zeitschr. Phys. Chem., lxxvi. (1911) pp. 732-42 (5 figs.).

¶ *Foundry Trade Journal*, xiii. (1911) pp. 530-1.

- BERG, C. P.—**Heat-treatment of High-speed Tools.**
Journ. West. Soc. Eng., xv. (1910) pp. 738-54.
- BERNOULLI, A. L. — **The Law of Babo and the Electron Theory of Metallic Mixed Crystals.**
Ber. Deutsch. Phys. Ges., xiii. (1911) pp. 213-18.
- BORNEMANN, K.—**Binary Metallic Alloys.**
[Further instalments of this summary of published researches.]
Metallurgie, viii. (1911) pp. 270-80, 289-95, 358-65 (47 figs.).
- BOUDOÜARD, O. — **Testing of Metals by Observation of the Damping of Vibrations.**
Comptes Rendus, clii. (1911) pp. 45-7.
- BROOKS, K. P.—**Resistance of Metallic Mixtures and Alloys.**
[It is shown that the high resistance of alloys cannot be explained by the presence of opposing E.M.F.'s at the junctions of neighbouring particles of the two components.]
Phys. Zeitschr., xi. (1910) pp. 471-3.
- CAMPION, A.—**Notes on the Treatment of Steel Castings.**
Foundry Trade Journal, xiii. (1911) pp. 531-2.
- CALVO, A. R.—**Electrical Conductivity of Silver Amalgams and of Cadmium Amalgams.**
Ion, ii. (1910) pp. 408-10.
- CHARPY, G., & S. BONNEROT—**Gases contained in Steel.**
[The gases were extracted by heating the steel at 950° C. in a vacuum; they were measured and analysed. The removal of the gases had no effect upon the thermal critical points.]
Comptes Rendus, clii. (1911) pp. 1247-50.
- DESCH, C. H.—**Composition of Eutectic Mixtures.**
Trans. Faraday Soc., vi. (1911) pp. 160-6.
- FAY, H.—**Some Causes of Failure in Metals.**
[Metallographical investigations of some defects in steel are described.]
Mech. Eng., xxvii. (1911) pp. 690-1.
- GREENWOOD, H. C.—**Vapour-pressure Curves and Heat of Evaporation of Metals of High Boiling-point.**
Zeitschr. Phys. Chem., lxxvi. (1911) pp. 484-90.
- GUERTLER, W.—**Electric Conductivity and Temperature Coefficients of Alloys.**
Phys. Zeitschr., xi. (1910) pp. 476-9.
- GUILLAUME, C.E.—**Anomalous Dilatation of Nickel Steels.**
Comptes Rendus, clii. (1911) pp. 189-91 (2 figs.).
- HARTMANN, L.—**Mechanism of Permanent Deformation in Metals Strained in Tension.**
[A study of the surface-changes observed during the loading of tensile test-pieces, and of the effect of previous cold-working, annealing, etc., upon these changes.]
Comptes Rendus, clii. (1911) pp. 1005-7, 1034-6, 1233-7.
- HEYN, E.—**Formation of Graphite in Iron Alloys.**
Zeitschr. Elektrochem., xvii. (1911) p. 182.
- ISHIEWSKY, W. — **Production of Granular Pearlite by Annealing Steel in an Electrically-heated Vacuum Furnace.**
Journ. Russ. Met. Ges., 1910, pp. 196-202.
- JEROMIN, K. A.—**Formation of Graphite in Iron Alloys.**
[The view that graphite results from the decomposition of cementite is discussed and supported.]
Zeitschr. Elektrochem., xvii. (1911) pp. 93-8.
- JOHNSON, F.—**Annealing of Copper and Diseases of Copper.**
Met. and Chem. Eng., ix. (1911) pp. 87-90 (4 figs.).
- „ „ **Notes on the Metallurgy of Wrought Copper.**
Met. and Chem. Eng., ix. (1911) pp. 396-401 (9 figs.).
- JOLIBOIS, P.—**Allotropic Varieties and Melting-point of Arsenic.**
Comptes Rendus, clii. (1911) pp. 1767-9.

- LEBEDEW, P.—**Melting-point Studies of some Bisilicates.**
 [The author has applied metallographical methods to the investigation of the equilibrium of some binary systems of silicates; some excellent photomicrographs are given.]
Zeitschr. Anorg. Chem., lxx. (1911) pp. 301-24 (15 figs.).
- MCWILLIAM, A., & W. R. BARCLAY—**The Adhesion of Electro-deposited Silver in relation to the nature of the German Silver Basis-metal.**
Journ. Inst. Metals v. (1911) pp. 212-27 (5 figs.).
- MASON, W.—**Lüders Lines on Mild Steel.** *Engineering*, xcii. (1911) p. 81.
- MATWEJEW, M.—**Reagents employed in the Metallography of Iron.**
Journ. Russ. Met. Ges., 1911, pp. 301-2.
- PARRAYANO, N.—**Ternary System Silver-tin-lead.**
 [The equilibrium diagram, determined by thermal and microscopical methods, belongs to the same type as that of the copper-antimony-bismuth system.]
Atti R. Accad. Lincei, xx. (1911) I, pp. 170-2.
- PRIMROSE, J. S. G.—**Metallography as an Aid to the Ironfounder.**
 [The metallographical investigation of defects and of causes of failure is discussed; numerous examples are given.]
Foundry Trade Journal, xiii. (1911) pp. 525-30 (16 figs.).
- PUTNAM, W. P.—**Malleable Annealing Temperatures.**
Foundry, xxxviii. (1911) pp. 283-5 (8 figs.).
- SAUVEUR, A.—**Metallography and its Industrial Importance.**
Met. and Chem. Eng., ix. (1911) pp. 239-41.
- SIEVERTS, A.—**Solubility of Hydrogen in Copper, Iron, and Nickel.**
 [The solubility has been determined at pressures up to 1.5 atmospheres and in the temperature range 400°-1600° C.]
Zeitschr. Phys. Chem. lxxvii. (1911) pp. 591-613 (2 figs.).
- SMITH, C. A. M., & H. J. HUMPHRIES—**Some Tests on White Anti-friction Bearing Metals.**
Journ. Inst. Metals, v. (1911) pp. 194-211 (9 figs.).
- STOUGHTON, B.—**Annealing and Manufacture of Converter Steel Castings.**
 [The effect of annealing upon the coarse structure of steel castings is discussed.]
Foundry Trade Journal, xiii. (1911) pp. 467-9 (7 figs.).
- WAHL, W. A.—**Chemistry of Meteorites.**
 [A description of the microscopic structure of some meteorites is included.]
Zeitschr. Anorg. Chem., lxix. (1910) pp. 52-96 (13 figs.).
- WEISS, P.—**Magneton in Solid paramagnetic Substances.**
Comptes Rendus, clii. (1911) pp. 688-91.
- WINOGRADOW, A.—**Characteristics of Carbide of Iron.**
Journ. Russ. Met. Ges., 1911, pp. 296-8.

PROCEEDINGS OF THE SOCIETY.

MEETING

HELD ON THE 18TH OF OCTOBER, 1911, AT 20 HANOVER SQUARE, W.,
H. G. PLIMMER, ESQ., F.R.S., ETC., PRESIDENT, IN THE CHAIR.

The Minutes of the Meeting of June 28th were read and confirmed, and were signed by the President.

The List of Donations (exclusive of exchanges and reprints) received since the last Meeting, was read, as follows, and the thanks of the Society were voted to the donors:—

Ernest Edwin Austen: A Handbook on the Tsetse-Flies (Svo, London, 1911)	} Trustees of the British Museum.
Annie Lorrain Smith: A Monograph of the British Lichens, Part II. (Svo, London, 1910)	} Ditto.
Geo. H. F. Nuttall and Cecil Warburton: Ticks. A Monograph of the Ixodoidea, Part II. (Svo, Cambridge, 1911)	} Prof. Geo. H. F. Nuttall.
Ditto. Bibliography (Svo, Cambridge, 1911)	
Waldron Griffiths: The Principal Starches Used as Food, 2nd edit. (4to, Cirencester, 1911)	} The Author.
Richard Strachan: Basis of Evaporation. Notes on the Climate of Ireland (Svo, London, 1910)	} The Author.
Recueil de l'Institut Botanique Léo Erréra, Tome Supplémentaire VII bis (Svo, Bruxelles, 1910)	} M. Jean Massart.
Ditto. Annexe au Tome VII bis (Svo, Bruxelles, 1910)	
Ditto. Tome VIII (Svo, Bruxelles, 1911)	
M. Athias, Sôbre as Divisões de Maturacão do Ovulo dos Mammíferos (Svo, Lisboa, 1910)	} The Author.
Old Microscope by Pritchard	} Capt. A. F. G. Warrington.
Twelve Slides of Rock Sections	} Mr. H. J. Grayson.

Mr. Barnard showed a new Microscope, designed particularly for photomicrography, the main point in which was its great stability. The Microscope was built on the well-known Wales model, and had been made to his specification by Messrs. Swift and Son. The body-tube, stage, and sub-stage were all carried on one substantial casting, ensuring the utmost rigidity of all the movements. The mechanical stage had considerable range in each direction, allowing very large objects to be examined, and could be removed. The draw-tube was racked, and had more than sufficient range for use with long or short tube objectives. Altogether it seemed to him to be an extremely useful type of stand, suitable for high-power work of the most critical nature, and so well balanced as to be equally stable either in a vertical, inclined, or horizontal

position. It embodied every feature likely to be required in an instrument of such a type, and was not open to the objections that might be urged against some well known stands supplied for the work in view.

The thanks of the Society were accorded to Mr. Barnard for his exhibit.

Dr. T. W. Butcher then read a paper on "The Structural Details of *Coscinodiscus asteromphalus*," which was illustrated with lantern slides.

At the conclusion of his paper Dr. Butcher said that he wished very particularly to express his thanks to Messrs. Watson and Sons, Messrs. Angus and Co., and Messrs. Baker for the loan of Microscopes, various lenses, etc., and to Mr. Powell who set up a beautiful lens with a very perfect specimen under it.

Dr. Spitta apologized for the brevity of his remarks, but he had to leave in a few moments. He would show four slides. The first displayed what was Mr. Nelson's focus of the diatom. The second, the "rosette focus," as it has been called—the one in fact that appeared in most, if not all, of Dr. Butcher's excellent photographs. As regards the membrane which Mr. Nelson reported as having seen, Dr. Spitta approached the subject in rather a different manner. First, if oblique light is used with Mr. Nelson's focus, the image will *almost* (but not quite) form itself into the same appearance as that obtained when using that illumination with the rosette focus. But the *perfect* image was only obtained when this form of illumination was used with the *latter* (rosette) focus. This, to his mind, proved that Mr. Nelson's focus was incorrect, and that Dr. Butcher's was really the true layer of the diatom to focus. This was shown in slide 3. To make sure that the effect obtained by the use of oblique illumination was correct, it was a good plan to use annular light, for if that showed anything approaching the same images, it might be confidently believed no false images had been obtained by the use of the previous method. This was shown in slide 4. Dr. Spitta added that of course optical reasons forbade obtaining of *so good an image* in detail with annular light as with oblique illumination, but of that he had no time now to speak. The real point was—whichever focus was tried, no membrane could be seen. He had visually tried several apochromatic $\frac{1}{2}$ and the same type of lens ($\frac{1}{3}$ apochromatic) as Mr. Nelson had used, in fact, all his photographs shown had been taken with this very combination—yet nothing like a membrane could be seen. With such a skilled observer as Mr. Nelson, the only explanation he could offer was that the specimen used must have been of a different kind from that ordinarily met with, for it was a mistake to think Mr. Nelson's $\frac{1}{3}$ apochromatic was of new design: Mr. Poser, of Carl Zeiss's, had distinctly denied such to be the case—being only one out of the ordinary stock.

Mr. A. E. Brown said that, in corroboration of the correctness of the photograph made by Mr. Nelson and exhibited by Dr. Spitta, it was exactly that appearance of the structure of the diatom as found in a Maryland deposit, which he always obtained with a Leitz $\frac{1}{10}$ oil-immersion, when accurately in focus.

Mr. Plaskitt suggested the intermediary structure as being the true

structure, and the bright points in the rosette patterns as due to the illumination. From his own observations he had found that fine undulating continuous lines traversed the whole upper circuit of the disk, and that beneath these radiated others from centre to periphery.

Dr. Butcher, in reply, remarked that he had nothing further to add. There would be full scope for discussion on the subject, he thought, later, when the diatom had been studied by other observers under the same conditions as those in which he himself had worked.

The President said that there appeared to have been some difficulty about Mr. Nelson's description of the objective which he used on this particular object. He would like to suggest that, perhaps, the mistake might have arisen, as in other cases, by the use of the word "series," which the Germans used for a batch of lenses; thus it was quite likely that the words "new series," meaning a new batch of *lenses*, might have been misinterpreted as referring to a new formula. No new batch of lenses, however carefully made, and however much of the machine was used in their construction, could ever be exactly of the same quality. Thus, in his possession he had a Zeiss apochromatic stated to have a numerical aperture of 1.40, which was, however, one of 1.44, as measured, and as the Zeiss firm only engrave a minimum value on their lenses, some such error, in the right direction, might be attributed to Mr. Nelson's lens. The Society was always grateful for any work on diatoms, as this work had, more than any other, led to the perfecting of our Microscope lenses. He was sure that all present were very deeply obliged to Dr. Butcher for his interesting paper, and proposed a cordial vote of thanks to him, which was carried with acclamation.

In the absence of the authors, Mr. Shillington Scales read a paper by the Rev. Hilderic Friend, on "New British Enechytræids," and also one by Mr. Walter Bagshaw, on "Instantaneous Exposure in Photomicrography."

Mr. Barnard remarked that he thought that the method described was not entirely novel, as magnesium had been used as an illuminant from the early days of photomicrography. In his experience, the crux of the whole operation in instantaneous work of this character lay in having some arrangement for observing the image. There appeared to be no suggestion of such in the method described. The actual appearance of the object, therefore, whether in focus at the moment of exposure, or indeed, whether in the field of view at all, was left to chance. Further, the area of the illuminant is very large in flash-light work, and this is a fatal objection to its use for anything but the lowest powers.

The thanks of the Society were returned to Mr. Friend and to Mr. Bagshaw for their communications.

The President said that before they separated there was a matter about which he particularly wished to speak. When the Royal Microscopical Society was inaugurated many years ago, a book—the "Roll" of the Society—was commenced. This book contained the Charter of the Society, but also contained several double-column pages of very distinguished names of earlier Fellows of the Society, beginning with James

Glaisher, President. For some reason or other this Roll of Fellows ceased about 1866, with no indication why it came to an end. The Council has unanimously decided that it would be a very good thing if the custom of Signing the Roll were now renewed. Fellows on admission to the Society would sign this Roll, as they do on admission to many other Societies; whereby not only would a book of considerable interest to our successors be formed, but also a personal record of the Fellows would be kept. In order to carry out this plan, it had been decided that the President and Council of the Society should forthwith enter their names in the book, and that they should request all Fellows present to do the same, hoping that at successive Meetings of the Society other Members, not present that evening, would also sign the book, so that in course of time a real Roll of the Fellows of the Society would be obtained. He hoped that this decision of the Council would commend itself to the Fellows, and he was sure that when they saw how well and with what notable names the Roll had been started, they would be sorry that the custom had not been continued. 1866 was the date of the last signature. It was the wish of the Council that it should now be kept going as a register of the Fellows of the Society from this time—he supported that wish by signing the Roll, and it would be a great satisfaction to himself and the other officers of the Society if all present to-night would follow his example.

Mr. Shillington Scales said he would like to supplement the President's words with a little further explanation. The President, Secretaries and Council, were very anxious, if possible, to draw the bonds of friendship of the Society closer together. New Fellows were elected who, sooner or later, attended the Meetings of the Society, who were absolutely unknown to anyone, and who, feeling the aloofness of their position, tended to lose interest in the Society. The object of the Royal Microscopical Society was that it should be helpful to all its Fellows, as well as advance the interests of Microscopy in its dealings with that subject. The plan, therefore, to be followed henceforth was that each Fellow on being elected would receive a letter announcing his election, and asking him to make himself known to the officers of the Society. At the close of the Meetings, new Fellows would come forward and sign the Fellows' Roll, and make themselves known to the Secretaries, who would introduce them to the President and other Members of Council. This would be done, not with a view of imposing a task upon any new Fellow, but merely with the view of making the Society more helpful to him. There was a kindred Society which, for many years past, had held its meetings in this same building—renowned for the spirit of friendship and *camaraderie* among its members—and he thought it would be well if the Royal Microscopical Society would emulate the Quekett Club in this respect, and by extending the hand of friendship and welcome to each new Fellow, thus help him to the attainment of those objects for which he joined their Society.

The President then signed the Roll, his signature being followed by the Secretaries and Council of the Society.

The next Meeting was announced for November 15.

The following Instruments, Objects, etc., were exhibited :—

The Society :—Rock Section. Graphic Granite from Cara Pook, Western Australia, prepared by Mr. H. J. Grayson.

Mr. T. W. Butcher :—Slides of *Coscinodiscus asteromphalus* ; Lantern Slides and Photographs in illustration of his paper.

Mr. E. J. Spitta :—Three Lantern Slides illustrating his remarks on Mr. Butcher's paper.

Mr. J. E. Barnard :—New Photographic Microscope by Messrs. Swift.

New Fellows.—The following was elected an *Ordinary* Fellow of the Society : W. E. Garforth ; and the following were nominated as Ordinary Fellows : Hamilton Hartridge, Charles Henry Huish, Malcolm Evan MacGregor, Lewis Noad, Henry Blatch Wells.

MEETING

HELD ON THE 15TH NOVEMBER, 1911, AT 20 HANOVER SQUARE, W.,
H. G. PLIMMER, ESQ., F.R.S., ETC., PRESIDENT, IN THE CHAIR.

The Minutes of the last Meeting, on October 18th, were read and confirmed, and were signed by the President.

Mr. Rousselet exhibited an old Microscope by Andrew Pritchard, presented to the Society by Captain Warrington.

At the conclusion of his description of the Microscope, Mr. Rousselet said the Society was very glad to have this old Microscope, as they had no representative of its type in their collection. It was made between 1834 and 1838, at a time important in the history of the Microscope, namely, when lenses first became achromatized. Achromatization of microscopic objectives had been accomplished before 1824, but it was so imperfect that the lenses were no better than those used in the old single-lensed Microscopes. Chevalier, of Paris, was the first to produce an achromatic lens which was serviceable. He did so apparently at the instance of a Mr. Selligne, in 1824, who was the first to place two, three or more of these achromatized doublets, one above the other, to obtain increased magnification ; his plan was to place the convex lens towards the object, but Charles Chevalier soon found that a much better result was obtained by reversing this arrangement and placing the flat surface of the combination towards the object. Between 1830 and 1850 all kinds of combinations of achromatic lenses were tried and made, principally by Talley, Andrew Ross, James Smith, and Hugh Powell, in this country, eventually resulting in the highly perfected achromatic lenses as we knew them.

Mr. Rousselet also showed another type of apparatus lent by Mr. A. H.

Lethbridge, combining Telescope and Microscope, which could be used alternately by unscrewing the eyepiece of the telescope and screwing it on to a drum Microscope stand. The name inscribed on the apparatus was that of Charles Nephew & Co., of Calcutta.

Dr. Spitta, in returning thanks to Mr. Rousselet for his interesting exhibition, asked whether he might suggest that the Society should, if possible, try to induce Mr. Rousselet to commit his valuable knowledge in regard to the history of Microscopes to paper. Such a history was, he believed, nowhere to be found, and he would venture to say that none possessed so intimate an acquaintance with the subject as Mr. Rousselet. It seemed a pity, he thought, that they as a Society supposed to represent Microscopy should not possess some such a history to which reference could be made when necessary.

The President replied that he thought it would be an excellent thing if Mr. Rousselet would fall in with Dr. Spitta's suggestion, and he was sure that all present were of the same opinion. Moreover, the fact that the collection of Microscopes in their possession was about to be put into better keeping and condition would, he thought, afford an excellent excuse for the compilation of a book such as that suggested, and would at the same time furnish a description of the instruments, which such rearrangement would make necessary. He hoped Mr. Rousselet would be persuaded to undertake this work.

Dr. Spitta remarked that after such an invitation Mr. Rousselet could hardly refuse!

Mr. Rousselet replied that he was afraid it was too big an order.

Mr. Barnard read a paper on "A Geometric Slide Photomicrographic Apparatus," the principles of which he illustrated by a diagram and by drawings on the blackboard. The apparatus itself was exhibited.

In the course of his explanation, Mr. Barnard said that the apparatus was designed on the principle of the geometric slide throughout, as enunciated by Lord Kelvin and Tate. The geometric clamp was introduced in a modified form only, but was of such interest that a short description would not, he thought, be out of place. In the photomicrographic apparatus shown, an attempt had been made to embody the principles of a geometric slide throughout. Apart from that the design was such that extreme rigidity was obtained, and there was little or no liability of alteration of any of the components as the result of climatic influences. Owing to this rigidity the whole apparatus would move together if subjected to any shock or vibration. The base of the apparatus was made from two castings which were designed on the girder principle. Each of these might be resolved into a triangle so that the utmost stiffness was obtained. The two castings were braced together at each end and in the middle by a small cast piece.

The portion to carry the Microscope was also on a pair of castings, these being triangular in shape, and braced together in the same way as the main castings. The former pair of castings was supported at the end away from the camera on a metal cone, which allowed them to be swung out from the central position. The female part of the cone was on the

swinging tail piece, whereas the male portion was on the end of the main casting. Rods were fastened down firmly on the top of the castings supporting the whole apparatus, and the camera slid along these on two V-grooves on one side and on a plane surface on the other side. Both the front and back of the camera were identically supported.

The same method was adopted in that portion of the apparatus carrying the illuminant and subsidiary lenses.

In all cases the clamps were of simple character and consisted of a metal bar which engaged on each side of the casting on which it rested, and which was tightened up by means of a quick-acting screw. On manipulating the screw the bar was drawn against the side of the casting. The camera itself was supported on vertical rods, firmly fixed on the geometric slides. There was nothing peculiar about the camera portion as such, except that on one side of it a small white screen was supported, so that when the Microscope was thrown out of alignment an image might be observed on the subsidiary screen. The final focusing, of course, had to be done on a ground or clear glass screen in the usual manner. The apparatus shown could be used equally well as an horizontal or vertical camera, or it might, if required, be inclined at an angle of 45° . It might be used for photographic specimens which required to be in a horizontal or vertical position.

Mr. Barnard said that he had wished also to refer to the method of supporting the whole apparatus, but the Secretary would admit that he had been a little hurried in bringing the apparatus forward, for it had only been finished during the day. It was proposed that it should be carried on two castings, one at each end. The one at the camera end would, in fact, be of the character of a cradle. He was of opinion that this method of supporting the apparatus might be carried even further, as he had experimented with a somewhat larger arrangement in which the camera was swung by short springs, so that in the case of anyone working under trying conditions, the apparatus would be free from extraneous vibrations.

Mr. Shillington Scales said that it seemed to him that the most interesting and ingenious point about this apparatus was, that so far as he knew there was no other photomicrographic apparatus on which the Microscope itself was made to move in the same optic axis as the optical and camera adjustments, whether the camera were used in a vertical, horizontal, or inclined position. He had listened carefully, and he did not see that the optical adjustments themselves offered any advantage over the optical bench. He presumed that the various optical fittings had to be centred by screws. He thought the adjustments of the camera were exceedingly clever; the camera was not supported on any base, and could be adjusted up and down. It had struck him on looking at the apparatus that there might be a little lack of rigidity, but Mr. Barnard had explained that he had been hurried, which would adequately account for this. The only other criticism he had to offer was in regard to the cost, which he thought might perhaps be excessive.

Dr. Spitta said it was, of course, a mere matter of detail, but was not the distance between the illuminator and the Microscope somewhat short?

Mr. Barnard answered that, as it then stood, it might perhaps

be somewhat short, but it must be remembered that the apparatus was merely a model. If, however, any difficulty were experienced, there was not the slightest reason why the illuminant should not be carried over the back, or that longer supporting castings should be used.

Dr. Spitta objected that he thought it might strain the apparatus.

Mr. Barnard said that it could be supported so that its weight came over the centre of gravity of the swinging tail-piece. Mr. Scales thought that the apparatus would not be so easy to use from the point of view of centering in comparison with the triangular bar. So far as his (Mr. Barnard's) experience went, the triangular bar was not entirely satisfactory. One had to rely so entirely on the setting-up of the fittings on the triangular bar, and also on the extent to which the clamping-screw was tightened. He ventured to suggest that triangular bars were even open to improvement. By altering the shape of the groove in the bar it would be possible to change the direction of the strain from a lateral to nearly a vertical pull.

Dr. Spitta said there was no need to screw up.

Mr. Barnard replied, that even if reliance were placed on the fitting, there was still the question of the lateral adjustment of the lens to the optical axis. He thought the main point, however, was that of cost which had been raised by Mr. Scales, and which he ought to have dwelt on. He thought really it should be the cheapest apparatus yet built considering its efficiency, because there was no fitting to be done. A pattern was made in each case, from which two castings were taken. So far as the geometric solids went they were rough castings. All bolting together was done by means of holes provided in the castings, and the whole could be braced up together. It would be difficult to imagine an apparatus in which there was less work, and in all such appliances it was the labour, and not the material, that cost money.

The President said he was very glad indeed to hear this account of the cost. He thought that anyone who, like himself, had taken so many photomicrographs for many years with an inferior instrument, would be full of envy of such a machine. There was one point about the apparatus on which he had to congratulate Mr. Barnard, and that was its compactness as compared with Mr. Barnard's earlier models, one of which he remembered somewhat resembled a suspension bridge in shape and size. He thought from what he could see of the model that this instrument would be extremely rigid. The thanks of the Society would, he was sure, be cordially accorded to Mr. Barnard for the very interesting and important illustration of an apparatus which would prove to be of the greatest value, especially if the cost was what Mr. Barnard had led them to hope.

The vote of thanks proposed by the President to Mr. Barnard was carried with acclamation.

A paper by the Rev. Hilderic Friend on "British Enchytraeids II. ; the Genus *Fridericia*," was read by Mr. Shillington Scales in the absence of the author. Mr. Scales said that as the paper proved to be of a very technical character, he would merely deal with those points of salient interest. In conclusion he said that there followed a long classification

of Encytraëids which he would omit; he was sure, however, that when the paper appeared in print all would agree that it was an important contribution to a neglected group, and that the Society would congratulate themselves on possessing among their Transactions a paper of this kind from a comparatively new Fellow of the Society.

A cordial vote of thanks was returned to Mr. Friend for his contribution.

The President said that before they separated he desired to accord a very hearty vote of thanks to Messrs. C. Baker and Co. for the loan of Microscopes in which the rock-sections presented to the Society by Mr. Grayson were being exhibited. The vote of thanks was cordially carried.

With regard to the next meeting of the Biological Section, the President said he had been asked to state that a visit would be paid to the London School of Tropical Medicine, Royal Albert Docks, on the 29th inst., by kind permission of Sir Patrick Manson. Mr. Scourfield would supply any information in regard to this meeting which might be desired.

He also wished to remind the Fellows that the Roll Book was there, and that he desired that any Fellow present who had not yet signed would be kind enough to do so now.

The next Meeting was announced for December 20, when a lecture would be given by Mr. F. Shillington Scales on "The Photomicrography of the Electrical Reactions of the Heart," and a paper would be read by the Rev. Hilderic Friend.

The following Instruments, Objects, etc., were exhibited:—

The Society: An Old Microscope by Pritchard, presented by Captain A. F. G. Warrington; a Telescope combined with a Microscope, lent for exhibition by Mr. A. H. Lethbridge; the following Slides of Rock-sections, presented by Mr. H. J. Grayson: Anorthoclase trachyte, Diorite, Flint, Beach boulder, Grano-diorite, Olivine basalt, Sandstone, Serpentine, Tourmaline pegmatite, Trachytoid phonolite.

Mr. J. E. Barnard: A Geometric Slide Photomicrographic Apparatus and Diagram, in illustration of his paper.

New Fellows:—The following were elected *Ordinary* Fellows of the Society:—Hamilton Hartridge, Charles Henry Huish, Malcolm E. MacGregor, Lewis Noad, Henry Blatch Wells.

Corrigenda.

Page 410, line 2 from bottom—"δ" should read "g."

Page 538—the first line *should be deleted*. It has been "lifted" from between last line of page 539 and first line of page 540, where it should be read in.

Pages 599, 600, 601, Figs. Plate XIX.—E and B *refer to* figs. 1 and 2; D to fig. 3; A and C to figs. 4 and 5.

INDEX.

A

- Abderhalden, E., Enzymes in different Bacteria, 94
 Abrasion and Crushing, Resistance of Steels, 714
Acetobacter melanogenum, 402
 Achard, C., Distinguishing Dead from Living Leucocytes, 117
 Achatina, Abnormal Shells, 196
 Acne, Bacillus, 262
 Achtheres, Development, 756
 Actinians, Studies, 211
 Actinomycosis of Plants, 92
 Adams, L. H., Influence of Pressure on the Melting-points of Metals, 563
 Adams's "Variable" and the Evolution of the Modern Microscope, 178
 Adductors, Contraction in Fresh-water Mussels, 616
 Adipose Cells of *Pontobdella muricata*, 624
 Æoliidae and Tritoniadae, Blood-vessels and Nerves, 196
 Aerator suitable for Laboratory Aquaria, 24
 Agar, W. E., Spermatogenesis of Lepidosiren, 608
 Agaricaceae, German, 394
 Agglutination of Trypanosomes, 824
Ahnfeldtia gigartinoïdes, 504
 Air-sacs in Birds, 613
 Alcock, A., Classification of Culicidae, 619
 Aleyouarian, New Type, 764
 Aleyouarians, Australian, 364
 — West Australian, 54
 Aleyonidium, New Species, 51
 Alectoria, Northern Species in America, 683
 Alexeieff, A., Division and Encystation of *Amoeba limax*, 474
 — Division in *Amoeba punctata*, 474
 — Intestinal Flagellates of Marine Fishes, 369
 — Notes on Flagellates, 632
 — Studies on *Amœbæ*, 474
 Alga, Corroding, 502
 — Symbiotic, 233
 Algæ and their Study, 230
 — Black Sea, 387
 — Classification, 385
 — Effect of Light, 785
 — Epiphytic, Two, 501
 — Fresh-water, African, 230
 — — from Greenland, 390
 — — from Macedonia, 390
 — from the Laboratory at Roscoff, 70
 — Green and Conjugatae, Metachromatic Bodies, 72
 — — Californian, 503
 — Injury to Water-cress Beds, 500
 — Marine, from the Kermadecs, 230
 — — Japanese, 229
 — Nuclear Autochromatism, 785
 — Nutrition, 498
 — Nutrition, 659
 — of Andritz, 390
 — of Kamerun, Marine, 790
 — of North Carolina, 660
 — of the Clyde Area, Fresh-water, 788
 — of the Elf Loch, 230
 — of the Sheffield District, 230
 — of the Upper Pruth, 72
 — of the West Coast of Norway, 506
 — of Tripoli, 660
 — Phylogeny, 498
 — See CONTENTS
 Algal Coals, Supposed, Investigating Nature of, 262
 — Figures on Culture Flasks, 785
 — Flora of the Missouri Botanical Garden, 230
 Algological Notes, 73, 386, 503
 Algology, Marine, 790
 Alimentary Canal of *Dytiscus*, 748
 — — of *Helix pomatia*, 747
 Allan, G. M., Mammals of West Indies, 612
 Allan, M. J., An Easy Method of Treating Printing-out Paper for all Kinds of Photography, 129
 — Variable Eye-piece, 570, 693
 Alligator, American, Development of Enteron, 187
 Alloys, Aluminium, containing Magnesium, 711
 — Aluminium-calcium, 123
 — Aluminium-magnesium, 825
 — Aluminium-silver, 268

- Alloys, Antimony-lead, Shrinkage, 418
 — Copper, Occluded Gases, 418
 — Copper-zinc, New Critical Point, 710
 — Defects, 560
 — Electrical Conductivity, 563
 — Gold-magnesium, 123
 — in Microscopical Anatomy, Injection of Fusible, 822
 — Iron-antimony, 558
 — Iron-carbon, 125
 — Iron-nickel-copper, 127
 — Iron-silicon-carbon, 826
 — Lead-tin, 711
 — Metallic, "Filiations," 715
 — Molten, Electrical Conductivity, 274, 560
 — of Aluminium and Zinc, 711
 — of Cadmium, Bismuth and Lead, 417
 — of Copper, Antimony and Bismuth, 124
 — of Lithium, 123
 — of Silicon with Metals, 712
 — of Silver with Cadmium, 825
 — of Sodium with Silver and Gold, 556
 — of the Noble Metals, 417, 826
 — Palladium-gold, Occlusion of Hydrogen, 557
 — Pseudo-binary, 561
 — Silver-cadmium, 123
 — Silver-copper, 124
 — Silver-sodium, 124
 — Steels, Cementation, 713
 — Tellurium, 416
 — Ternary, of Lead, Tin and Antimony, 556
 — — of Magnesium, Zinc and Cadmium, 124
Alopecia arcata of Bacterial Origin, 687
 Aluminium Alloys containing Magnesium, 711
 — and Zinc Alloys, 711
 — Silver and Bismuth, Effect of upon Copper, 418
 — Spontaneous Disintegration, 555
 Aluminium-calcium Alloys, 123
 Aluminium-magnesium Alloys, 825
 Aluminium-silver Alloys, 268
Alytus obstetricans, Involution of Tail, 738
 Anakebe, Transmission by Brown Tick, 622
 Amalgams containing Silver and Tin, 557
 — Zinc, 417
 Amann, J., Binocular Microscope, 806
 — Ultramicroscopical Study of Solutions of Iodine, 545
 Amann, Y., Direct Enumeration of Bacteria in Water, 552
 Amber, Blattidae in, 465
 Ambi-coloured Flatfish, 746
 Ambrosia Fungus, 396
 Ambrož, A., Thermobiosis, 403
 Ania, Development of Pectoral Fin, 607
Anaba diploidea, Depression and Apogamy, 475
Anoba limax, Division and Encystation, 474
 — *punctata*, Division, 474
 — Reactions to Light, 366
 — Studies, 474, 767, 821
 Amphibia, Blastopore Closure, 347
 Amphibians, *Corpora Adiposa*, 613
 — Production of Supernumerary Limbs, 187
Anabana cycadex, Life-history, 663
 Anaerobe, New, in Typhoid Stools, 688
 Anaptychia and Physcia, Apothecial Development, 401
 Anatomy of Seed Plants. See CONTENTS
 Andrade, E. N. da C., Viscous Flow in Metals, 274
 André, E., New Species of Mesnilella, 635
 Andreaeaceae, 65
 Andrejew, P., Comparative Study of Coliform Organisms, 91
 Andrews, A. le R., North American Sphagnum, 782
 Andrews, E. A., Jamaica Peripatus, 466
 — Rhythms in Termite Communities, 463
 — Sperm Transfer in Certain Decapods, 753
 Andrews, F. M., Embryo-sac Development in *Hybanthus concolor*, 218
 — Spirogyra, 665
 Angiosperms, Apetalous, Gnetales, 372
 Anguillulide of the White Slime of Oaks, 361
 Aniline-stained Microscopical Preparations, Fading, and a New Medium, 415
 Animal Life of Sea-bottom, 741
 — Tissues, Reduction and Oxidation, 614
 Animals, Aquatic, Equilibration, 614
 — Domestic, Reproductive Organs, 743
 — Sense of Light, 355
 Annandale, N., Barnacles from Irish Seas, 469
 — New Burmese Frog, 353
 — Rhizocephalous Crustacean from Fresh-water, 755
 — Sponges Associated with Vermetidae, 766
 Annealing of Steel, 559
 Annelid, Papillomatous Neo-formation, 625
 Annulata. See CONTENTS
 Annulus of *Cynodontium alpestre*, 66
 Anonas, Pollination Experiments in South Florida, 374
 Anoplura, Studies on Mallophaga, 751
 Ant, Mimicry by Larval Mantis, 356
 Antarctic Genera, New, 498
 Antheridia, Amphigastrical, in some Ptilidioid Hepaticae, 224
 — Embedded in Pteris, 644
 Anthomastus, Genus, 54
 Anthrax, Relative Immunity of Birds, 37

- Anthrax, Sterilization Process applied to Hides in Dry State, 266
 Antimony, Copper and Bismuth Alloys, 124
 — Lead and Tin, Ternary Alloys, 556
 Antimony-lead Alloys, Shrinkage, 418
 Antipatharia, New Genus, 473
 Antitoxins and Toxins, 744
 Auts' Nests, Beetles in, 42
Aphanomyces larvis, 669
 Aplozia, Critical Forms, 225
 Apogamy and Depression in *Ameba diploidea*, 475
 Appel, O., Monograph of Fusarium, 393
 — Study of Hyphomycetes, 79
 Appendicitis, Bacteriology, 91
 Appendix vermiformis, Oxyuris in, 470
 Aquaria, Laboratory, Aerator suitable for, 24
 Arachnida, Carboniferous, 467
 — See CONTENTS
 Arc-lamp, Leitz Liliput, 639
 Archæocyathinae, 56
 Archæopteris, 647
Arenicola loeui, 203
 Arenicolidae, Studies, 202
 Argas, New Species, 45
 Arldt, T., Evolution-centres, 457
 Arnaudoff, N., *Dryptodon hartmani*, 497
 Arnaud, G., Contribution to the Study of Fumagines, 794
 Arnell, H. W., and others, Northern Mosses, 229
 Arnheim, G., Cultivation of Spirochaetes, 819
 Arsenides of Tin, 825
 Arthropoda, Mounting in Amann's Chloralphenol, 416
 — See CONTENTS
 Arthur, J. C., and others, Uredineae, 79
 Arthus, M., Toxins and Antitoxins, 744
 Arwidsson, L., Irish Maldanidae, 758
 Arzberger, E. G., Fungus Root-tubercles, 237
 Ascarids of Carnivores, 361
Ascaris canis and *A. felis*, Comparison, 205
 — *felis* and *A. canis*, Comparison, 205
 — Idiochromosomes, 204
Ascaris megaloccephala, Compression Experiments with the Fertilized Ovum, 759
 — — Plasmic Reduction in Spermatogenesis, 625
 — — Role of Plastochondria in Fertilization, 759
 — Nervous System, 470
 — Potency of Blastomeres, 625
 Ascocarp of Leotia, 234
 Ascomycetes, Nuclear Evolution, 508
 — Studies, 670
Ascophyllum nodosum, Deformation, 503
Asellus aquaticus, Anatomical and Experimental Study, 623
 Ashton, J., Iron-nickel-copper Alloys, 127
 Ashworth, J. H., *Arenicola loeui*, 203
 — Studies on Arenicolidae, 202
 Asp, Horned, New Haemogregarine, 477
Aspergillus niger, Influence of Iron on the Formation of Spores, 79
 — Research, 671
Asplenium alternans in America, 777
 — *Guichardii*, 648
 — New Hybrid, 63
 — *ruta-muraria*, Mutations, 379
Asterias forbesii, Polarity of Primary Oocyte, 472
 Asterochlæna, Fossil, Stipes, 61
 Atavism, 191
 Athias, M., Maturation of the Mammalian Ovum, 603
 Atkins, W. R. G., Cryoscopic Determination of Osmotic Pressure in certain Plant Organs, 219
 Atkinson, G. F., Dictyophora and Ithyphallus, 237
 Atyephyra, Large Gregarine, 772
 Auerbach, M., Cnidosporidia, 213
 — Distribution of Myxosporidia, 477
Aulacodiscus superbus, Slides presented by Mr. Norman Thomas, 571
 Aumann, —, Distribution of Paratyphoid Bacilli, 402
 Avicula and Gorgonia Association, 463
 Axis of Corallium, Formation, 55
Azolla filiculoides, Anatomical Study, 190
Azotobacter chroococcum, Pigment, 686
 Azur-eosin Solution, Giemsa's, Rapid Staining, 414

B

- Baccarini, P., Notes on the Larger Fungi, 794
 — and others, Research on *Aspergillus*, 671
 Bachmann, E., Relation of Siliceous Lichens to the Substratum, 683
 Bachmann, H., Fresh-water Algæ of Greenland, 390
 — *Oscillatoria rubescens*, 389, 662
 Bacillary Disease among Fish, 405
 Bacilli, Dysentery, Action on Nitrites and Nitrates, 94
 — Penetration of the Normal Skin by Tubercle, 803
 — Tubercle, Methods of Staining, 550
Bacillus anthracis, Minute Structure, 524
 — *Cellulosa desagregans* sp. n., 686
 — *chlororaphis*, Pathogenicity, 688
 — *coli* and Plant-diseases, 804
 — — Artificial Production of a Permanently Atypical, 803
 — — Rapid Method of Identifying, 103
 — Coli-form, Mouse Epizootic due to, 246
 — *cyripedii*, 802

- Bacillus influenzae*. New Method for making Blood-agar for Cultivating, 820
- Jöhmé's, 94
- *Lactis aerogenes*, Action upon Glucose, 526
- *Newkii*: New Agar - liquefying Organism, 245
- of Aene, 202
- *pappus*, 804
- Strict Anaerobic, causing Purulent Pleurisy, 522
- *subtilis*, Trypanotoxin, 522
- Bacteria and other Organic Cells, Method of Disintegrating, 426, 592
- Cytology, 523
- Different, Enzymes in, 94
- Fermentation of Sugars, 521
- in Frozen Soil, 92
- in Milk, Enumeration, 710
- in Water, Direct Enumeration, 552
- Intestinal, Variability, 525
- Models of Microscopic Fields, 426
- Movements, New Method of Studying, 260
- Negative Staining, 823
- New Method for Differentiation, 109
- Nitrite-formation, 526
- Oxidizing and Reducing Properties, 244
- Studying the Cytology, 413
- Variation and Adaptation, 689
- Bacterial Cytology, 494
- Disease of Potato-plant, 247
- Diseases of Orchids, 802
- Bacteriological Studies of Danish Butter, 689
- Bacteriology, Agricultural, Methods, 521
- of Baltimore City Water, 524
- of Chorea, 245
- of Landry's Paralysis, 244
- Bacterium briosianum*, 803
- *Briosii*, 523
- *tumefaciens*, 803
- *zoppii*, Growth, 805
- Bagshaw, W., Instantaneous Exposure in Photomicrography, 721
- Baily, F. G., A Stereoscopic Illusion, 411
- Bainier, G., New Hyphomycetes, 393
- Baker, F. W. W., Anomalies in Objective Screw Threads, 175, 283
- Baldwin, W., British Carboniferous Myriopods, 200
- Ballnt, S., New Methods of Demonstrating Plasmodes, 119
- New Mounting Medium for Botanical Preparations, 265
- Bambeke, C., Study of *Ithyphallus impudicus* and *Mutinus caninus*, 512
- Bancroft, C. K., Parasitic Fungi, 393
- Bancroft, N., Xylem Elements of the Psidophyta, 614
- Banfield, H. C., Sliding Nose-piece for Use in Stereo-photomicrography, 95
- Baraduc-Muller, L., Metallic Silicides, 125
- Barbier, M., Obituary, F. A. Gillot, 799
- Barbieri, N. A., Physical Nature of Neuroplasm, 458
- Bardeleben, K. v., Right- and Left-handedness, 192
- Barentsia beneleti* in British Waters, 762
- Barlow, W. E., Alloys of Cadmium, Bismuth and Lead, 417
- Barlow, W. H., Analysis of Seaweeds, 231
- Barnacles from Irish Seas, 469
- Barnard, J. E., A Geometric Slide Photomicrographic Apparatus, 836
- A Method of Disintegrating Bacteria and other Organic Cells, 426, 592
- A Simple Method of Obtaining Instantaneous Photomicrographs, 19
- New Microscope, 831
- On the Use of a Metallic Electric Arc in Photomicrography, 21
- Practical Photomicrography, 545
- Barnes, E. J., Influence of Vanadium on Iron and Steel, 827
- Nickel Steels, 827
- Barrate, G., Mosses of Libya, 658
- Pteridophytes of Libya, 649
- Barnett, W. F., Historical Note on Recalescence, 270
- Bartels, P., *Plica semilunaris* in Hereros and Hottentots, 612
- Barus, C., Elliptic Interference with Reflecting Grating, 545
- Bassal, —, Staining in Bulk with Hæmatoxylin, 118
- Basilia, Development, 794
- Bassett, H. P., Turbidometer for Counting Vaccines, 824
- Bataille, F., Monograph of Hygrophorus, 81
- Bataillon, E., Artificial Parthenogenesis in Toad, 454
- — — of Toad's Egg, 454
- Experimentally Induced Parthenogenesis in Toad, 454
- Factors of Traumatic Parthenogenesis, 737
- Bateman, H. R., Enquiry into Sleeping-sickness, 476
- Tabanids and Trypanosomes, 749
- Bathie, J. and P. de la, Termites and Fungi, 397
- Bathysseine, Revision, 620
- Batrachians and Reptiles, Innervation of Heart, 458
- Australian, Hæmatozoa, 633
- Batrachospermum growing on Molluscs, 787
- Bats, Tendons of Wing and Leg, 609
- Bauer, E., Critical European Mosses, 656
- and others, Rare Species of Bryum, 226
- Bauer, O., Heat-treatment of Bronze, 124
- Stresses in Cold-worked Metals, 562
- Baume, G., Measurement of Hardness, 274

- Baykoff, A., Iron-carbon System, 558
- Bdelloida of Tropical Africa, Some African Rotifers, 1, 129
- Bdelloid, Non-parasitic, 471
- Bearing Metals, 268
- Beauchamp, P. de, Diplenchlanis, a new Sub-genus for *Euchlanis (Diplois) propatula* Gosse, 363
- Internal Euglenid Parasite, 635
- Beauverie, J., Mycoplasm Hypothesis and Metachromatic Corpuseles, 479
- Osmotic Pressure, and the Form and Structure of Plants, 481
- Becher, S., Studies on Holothurians, 209
- Beck, C., 422, 423, 568, 570
- A New Microscope, 419
- Interferometer, 539, 565
- New Portable Microscope, 569
- Pupil of an Optical System with regard to Perspective, 817
- Report on the Grayson's Rulings Presented to the Royal Microscopical Society by, 449
- Beck's London Microscope, Handle Model, 406, 419
- R. and J., Grinding and Polishing Machine for making Microscopical Specimens for Metallurgical Work, 554
- Beckenkamp, J., Aids to Crystalloptic Projection, 698
- Beckwith, T. D., *Diplococcus gadidarum*, the cause of the reddening of the Cod and other allied Fish, 804
- Bequerel, P., Traumatism in Relation to New Plant-forms, 485
- Bedau, K., Studying the Compound Eyes of Water-mites, 413
- Beddard, F. E., Tapeworms from Mammals, 760
- Bedot, M., History of the Study of Hydrozoa, 210
- Beef Disease, 616
- — due to *Nosema apis*, 769
- Beebe, C. W., Account of the Hoatzin, 193
- Bees, Studies, 197
- Beetle, Large Egg Laid, 748
- Beetles, Digestive Ferments, 619
- in Ants' Nests, 42
- Luminous, Fluorescence, 748
- Beijerinck, M. W., Absorption Phenomenon in Microbes, 521
- *Acetobacter melanogenum*, 402
- Bell, L., Opacity of Certain Glasses for the Ultra-violet, 700
- Benedicks, C., Crystallization of White Cast Iron, 712
- Ovitak Iron, 713
- Polymorphism of Zinc, 123
- Solid Colloid Systems in Metallography, 560
- Synthesis of Meteoric Iron, 559
- Benedict, R. C., Genera of Vittarice, 487
- Bengough, G. D., Corrosion of Metals, 715
- Heat-treatment of Brass, 417
- Bennett, A., *Chara stelligera*, 70
- Bentley-Taylor Method of Mounting Mosquitoes, 120
- Beresford, D. R. P., Woodlice of Ireland, 469
- Berger, A., Alleged Lactation of Male *Lepus bairdii*, 737
- Bergh, R., Opisthobranchs of South Africa, 39
- Berké, —, Horse Parasites in Cameroon, 471
- Microfilaria from a Fowl, 625
- Berlese, A., Studies on Injurious Insects, 747
- Bernard, C., Presence of Yeast on Tea, 392
- Berner, O., Apparatus for Rolling Wax Plates, 112
- Bernhardt, Scarlet-fever Virus, 804
- Berninger, J., Effects of Starvation on Planarians, 627
- Bernoulli, A. L., Thermo-electric Forces of Solid Solutions, 560
- Berry, A. J., Occlusion of Hydrogen by Palladium-gold Alloys, 557
- Berry, E. W., Epidermal Characters of *Frenelopsis ramosissima*, 774
- Fossil Lycopodium, 62
- *Schizæopsis expansa*, a Fossil Fern, 489
- Berry, S. S., New Cephalopods from Hawaiian Islands, 746
- Bertarelli, E., Alleged Importance of Demodex in Spreading Leprosy, 622
- Cultivation of Leprosy Bacillus, 526
- Bertrand, P., Stipes of the Fossil Asterochlena, 61
- Bertrand, T., Zygopteridæ, 61
- Besredka, A., Experimental Typhoid Fever, 524
- Betche, E., Queensland Ferns, 491
- Betgh, L. v., Foot-and-mouth Disease, 804
- Bethe, A., Equilibration in Aquatic Animals, 614
- Bethel, E., and others, Uredinæ, 674
- Bevaqua, A., Bacteriology of Landry's Paralysis, 244
- Bezzi, M., Cave Diptera, 618
- Bialkowska, W., Nerve-cells of Leech and Earthworms, 624
- Bialosuknia, W., Corroding Alga, 502
- Bianco, S. lo, Influence of Environment on Reproductive Period, 738
- Biernacki, W., *Bacillus nenckii*: New Agar-liquefying Organism, 245
- Bignotti, G., Batrachospermum growing on Molluscs, 787
- Billard, A., New Plumularid Genus, 365
- Siboga Plumularids, 765
- Billard, G., and another, Immunity to Viper Venom, 193
- Binocular Microscope, 806

- Biological Stations, 38
 Bipore, Growth and Habits, 51
 Birds, Air-sacs, 613
 — and Reptiles, 192
 — and Reptiles, Development of Vertebral Column, 186
 — Australian, Hæmatozoa, 369
 — Coccidiosis in Sparrows and other Wild, 369
 — Development of Extremities, 315
 — of Sympathetic Nervous System, 32
 — Echinostomide, 205
 — Entozoa in Australian, 760
 — Hybrid, Ovary, 604
 — Migration, 743
 — Head Cæcum, 192
 — Passerine, Directive Markings, 352
 — Relative Immunity to Anthrax, 37
 — Retina, 610
 — Size of Spleen, 352
 — Southern, Mallophaga, 465
 — Tapeworms, 760
 — Tonkin, Microfilaria, 361
 Birge, E. A., Notes on Cladocera, 47
 Bismuth, Cadmium and Lead Alloys, 417
 — Copper and Antimony Alloys, 124
 — Silver and Aluminium, Effect of upon Copper, 418
 Bismuthides, 825
 Bison, American and European, Fertility of Hybrids, 455
 Blanc, G., New Species of Echinorhynchus, 626
 Blastomeres, Potency in *Ascaris*, 625
 Blastopore Closure in Amphibia, 347
 Blattidæ in Amber, 465
 Blind, Sense of Direction, 612
 Blodgett, M., Origin and Development of Bulbs in the Genus *Erythronium*, 371
 Blood, Action of Radium Radiations, 611
 — Amphibian, Spindle-cells, 740
 — Corpseles, Red, Direct Division in *Scorpiæna*, 35
 — — — of Mammals, 609
 — — — White, and Spleen in *Bufo vulgaris*, Origin, 346
 — Films, Staining, 261
 — Formation in Grass Snake, 188
 — of Insects, 616
 — of *Varanus varius*, Hæmogregarine, 57
 — Parasites, 57
 Blood-agar for Cultivating *Bacillus influenzae*, New Method for making, 820
 Blood-vessels and Nerves of Æolididæ and Tritoniadæ, 196
 Blow-fly, Flying Apparatus, 618
 — Metamorphosis, 198
 Bluntschli, H., Teeth of Two Dentitions in a Dermoid Cyst, 604
 Bodecker, C. F., Celloidin Decalcification Method, 820
 Bönnicke, L. v., Heterotypic Division of Pollen-mother-cells, 637
 Børgesen, F., West Indian Chlorophyceæ, 667
 Böttger, O., Brain of *Lepisma*, 199
Boletus impolitus, 512
 Bolk, L., Development of Pigment-cells in Teleostean Embryos, 187
 Bolton, H., Insect Remains from South Wales Coalfield, 620
 Bone-growth, Abnormal, in Absence of Functioning Testes, 186
 Bones, Femoral, Minute Structure, 608
 Bonhote, J. L., Colour Inheritance in Pigeons, 738
 — Webfoot Character in Pigeons, 455
 Bonnet, A., Cavernicolous Gamasids, 752
 Born, E., Minute Structure of *Phyllirhõe bucephala*, 196
 Bornemann, K., Electrical Conductivity of Molten Alloys, 274
 — Equilibrium Diagrams, 560
 — Nickel-sulphur System, 416
 Borner, E., M. A. Gomont, 390
 Boshart, K., Leaf-symmetry and Exotrophy, 639
 Bosse, A. W. v., Caulerpa, 74
 — New Genera from the Malay Archipelago, 75
 Bostrychidæ, Nutritive Habits, 620
 Botanical Preparations, New Mounting Medium, 265
 Bothriomolus, Excretory System, 471
Bohrioneurum iris, 469
Botrydium granulatum, 666
 Bouehard, C., Sleeping and Waking, 611
 Bouet, G., Leptomonad in Euphorbias, 367
 Boule, L., Heterogamic Gemini in Impatiens, 480
 Boulenger, C. L., Notes on Structure and Budding of Limnœnida, 629
 Bounoire, L., Digestive Ferments of Beetles, 619
 Bouvier, E. L., New Decapod Pycnogonid, 467
 Bouville, R. de Drouin, Bacillary Disease among Fish, 405
 — Crayfish Plague, 753
 Boveri, T., Potency of Blastomeres in *Ascaris*, 625
 Bower, F. O., Medullation in the Pteridophyta, 643
 — Morphology of *Ophioglossum palmatum*, 642
 — Origin of Medulla in Ophioglossaceæ, 643
 Boyé, G., Anti-coagulant Action of Nematode Extract, 205
 Boyer, J., New Photographic Apparatus of the Paris School of Mines, 103
 Brady, G. S., Ostracods from Madeira, 757
 Brain of *Lepisma*, 199
 Brain-sections, Method of Preserving, 552
 — Staining the Medullary Sheath, 120
 Brains, Preserving, 824

- Branch-formation in Mosses, 651
 Brand, F., New Chlorophyceae from New Zealand and Tahiti, 667
 Brass, Heat-treatment, 417
 Brassfounder, Metallography as an Aid to, 418
 Brause, G., Ferns of German Central Africa, 223
 Brayshaw, S. N., Hardening of Carbon and Low-tungsten Tool-steels, 271
 Breckenridge, J. M., Aluminium-calcium Alloys, 123
 Bredeman, G., Bunt-spores in Meal, Bran, and Grain, 793
 Breed, R. S., Enumeration of Bacteria in Milk, 710
 Brémont, E., New Ascidicolous Copepod, 469
 Bresadola, G., and others, British Mycology, 513
 Bresadola, New Species, 236
 Bridgman, P. W., Action of Mercury on Steel at High Pressures, 272
 Brindley, H. H., Habits of Procession Caterpillar, 42
 Briquet, J., Corsican Ferns, 491
 Britton, E. G., *Philonotis* revised by Dismer, 654
 — *Splachnobryum* in Greenhouses, 383
 Broch, H., Australian Pennatulids, 365
 — Hydroids of Drobak, 365
 — New Genus of Hydroids, 52
 — Pennatulacea, 765
 — Peridinium Plankton at Rovigno, 57
 — Plankton of Spitzbergen, 39
 Brockhausen, H., Moss-flora of Rhineland, 656
 Brölemann, H. W., Cavernicolous Myriopoda, 44
 Broesike, G., Nature of Seminal Fluid in Man, 668
 Broniewski, W., Aluminium-magnesium Alloys, 825
 — Aluminium-silver Alloys, 268
 — Electrical Conductivity of Alloys, 563
 Bronze, Heat-treatment, 124
 Bronzes, Quenching, 268
 Broquet, C., Method of Preserving Plague Material, 120
 Brotherus, V. F., *Allionella*, a New Genus, 780
 — Moss-flora in Central Asia, 495
 — Mosses of New Caledonia, 784
 Broussonetia, Latex Diastases, 483
 Brown, H. B., *Cratægus*: Some Theories concerning the Origin of its Species, 220
 Brown, J. M., Respiration and Circulation in *Tipula maxima*, 749
 — Rhizopods from Lake District, 475
 Brown, W. H., Algae of North Carolina, 660
 — Ascocarp of *Leotia*, 234
 Brown, W. H., Cell-division in *Lyngbya*, 569
 Brownlee, J., Inheritance of Complex Growth-forms, 347
 Bruce, D., Enquiry into Sleeping Sickness, 476
 — Tabanids and Trypanosomes, 749
 — *Trypanosoma evansi*, 771
 — and others, New Trypanosome, 770
 — — — Studies on Trypanosomes, 769
 — — — Transmission of Sleeping Sickness, 770
 — — — *Trypanosoma natum* (Laveran), 770
 Brues, C. T., New Species of *Peripatus* from Grenada, 752
 Brumpt, E., Nematodes in Deer, 760
 Bruni, A. C., Development of Vertebral Column in Reptiles and Birds, 186
 Bruni, G., Formation of Solid Metallic Solutions by Diffusion in the Solid State, 712
 — Silver-cadmium Alloys, 123
 Bruni, G., and others, Ternary Alloys of Magnesium Zinc and Cadmium, 124
 Brunner's Glands, New kind of Cell, 349
 Brunthaler, J., *Coccolithophoridae* from the Adriatic, 499
 — Phylogeny of Algae, 498
 Bruntz, L., Elimination by Leucocytes, 195
 Bruyn, H. de, Development of Stele in Dipteris, 644
 Bryaceae, *Wollnya* a Genus of, 654
 Bryce, D., Bdelloid Rotifera: A New Classification, 207
 Bryological Index, 227
 — Notes, 65
 Bryophyta, British, 381
 — Inter-relationships, 224, 380
 — North American, 68
 — of German Central Africa, 496
 — of North America, 496
 — of the Philippine Islands, 68
 — of Tropical West Africa, 495
 — Social Groups and Adaptive Characters, 779
 — Spermatogenesis, 653
 — See CONTENTS
 Bryophytes, Belgian, 656
 — British, 494, 781
 — German, 494
 — Hungarian, 229
 — Japanese, 783
 — New Zealand, 69
 — Norfolk, 67
 — North American, 658
 — of Southern Europe, 495
 Bryozoa, Development of Statoblasts, 207
 — New Mediterranean, 762
 Bryum, Rare Species, 226
 Brzezinski, J., Mildew of the Vine in Poland, 508

- Bubak, F., and others, Diseases of Plants, 511
- Buchanan, G., Developmental Forms of *Trypanosoma brucei*, 770
- Studies on Australian Earthworms, 621
- Supposed Nematode in Circular Muscle of an Earthworm, 48
- Buchanan, R. E., Hyphomycetes, 673
- Buccal Apparatus of Hemiptera, 750
- Buddenbrock, W., Development of the Statoblasts of Bryozoa, 207
- Budding, Law, in "Portuguese Man-of-war," 473
- Buffa, P., Study of a Thrips, 750
- Bufo vulgaris*, Origin of White Blood-corpuseles and Spleen, 346
- Bug, Ghost, Secretion, 358
- Bugnion, E., Buccal Apparatus of Hemiptera, 750
- — Parts of a Ceylonese Staphylinid, 619
- Pentastomum of Python, 200
- Scelionid Parasite of Spider's Eggs, 41
- Bugs, Red, Apple, 358
- Bulbs in the Genus *Erythonium*, Origin and Development, 371
- Bulleidae, Mantle-cavity and Pallial Organs, 747
- Buller, A. H. R., Cystidia of *Coprinus atramentarius*, 82
- Bulloch, W., Tuberculosis, 523
- Bunt-spores in Meal, Bran, and Grain, 793
- Burger, O. F., Gum-inducing Diplodia of Peach and Orange, 672
- Burgess, C. F., Iron-nickel-copper Alloys, 127
- Burling, L. D., Photographing Fossils by Reflected Light, 257
- Burrell, W. H., New Variety of *Lophozia Schultzei*, 655
- Norfolk Bryophytes, 67
- and others, British Muscineæ, 656
- Burri, R., Comparative Study of Coli-form Organisms, 91
- Burrows, M. T., Artificial Cultivation of Animal Tissues, 107
- Culture of Tissues outside the Organism, 188
- Bursa Fabricii, Function, 460
- — Involution, 458
- Burton, J., *Botrydium granulatum*, 660
- Breaking of the Meies, 788
- Butcher, T. W., The Structural Detail of *Coccinodiscus asteromphalus*, 722
- Butter, Danish, Bacteriological Studies, 489
- Buzmannia viridis*, 493
- C
- Caddis-worms, Head-glands, 44
- Cadmium, Alloys of Silver with, 825
- Bismuth and Lead Alloys, 417
- Cadmium, Magnesium and Zinc Ternary Alloys, 121
- Cæcum, Heal, of Birds, 192
- Calamites compared with Equisetum, 62
- Leaves, 488
- *nodulatus*, 489
- Calanostachlys Ludwigii*, 489
- Calanus jimmarchicus*, Diurnal Migrations, 757
- Caluuli, Method of obtaining Sections, 263
- Uric Acid, Microscopic Structure, 258
- Calman, W. T., Epizoid Hydroid on Crab, 765
- Heterocuma, 46
- New and Rare Cumacea, 468
- — Carboniferous Crustacean, 469
- Parasitic Copepod from Cephalodiscus, 47
- Calvet, L., New Mediterranean Bryozoa, 762
- Cambridge Scientific Instrument Company Comparator or Reading Microscope, 807
- Camisa, G., Bacteriology of Chorea, 245
- Campbell, D. H., Californian Green Algae, 503
- Campbell, W., Annealing of Steel, 559
- Camponotus, North American Species, 357
- Capillaries, Spleen, Structure, 349
- Capitaine, L., Seeds of European Papaveraceæ, 218
- Capsule-formation of Typhoid Bacilli, 525
- Carbide of Iron, Influence of Silicon on the (Maximum Solubility in γ -Iron, 126
- Carbohydrates in Seeds, 480
- Carbon and Low-tungsten Tool-steels, Hardening, 271
- Cardioid Condenser, History: Memorandum on the Leitz Mirror Condenser, 693
- Cardot, J., Antarctic Mosses, 784
- Mexican Moss-flora, 783
- — Mosses, 68, 383, 658
- New Antarctic Genera, 498
- Carnevali, F., Cementation of Alloy Steels, 713
- — of Steel, 269
- Malleable Cast Iron, 559
- Carnivores, Ascarids, 361
- Carpenter, F. W., Feeding Reactions of the Rose-Coral, 53
- Carpenter, G. H., Injurious Insects in Ireland, 44
- Sudanese Pycnogonids, 467
- Carpenter, H. C. H., Growth of Cast-irons after Repeated Heatings, 826
- New Critical Point in Copper-zinc Alloys, 710
- Carrel, A., Artificial Cultivation of Animal Tissues, 107
- Carruthers, D., *Helvella crispa*, 508

- Carruthers, R. G., Evolution of *Zaphrentis delanouei*, 54
- Cartilage Cells, Demonstrating Presence of Mitochondria, 264
- in Thymus of Rat, 35
- Cases, Glass, for Collection of Instruments, 131
- Cassidulina, New Species, 212
- Cast-iron, "Graphitic," 559
- Malleable, 559
- Cast-irons after Repeated Heatings, Growth, 826
- Castings, Malleable, 827
- Castration and Malnutrition, Influence on Development of Sheep's Skeleton, 186
- by X-Rays, 347
- Parasitic, of Earthworms, 360
- Catalogue, Illustrated, Proposed, 138
- Caterpillar, Procession, Habits, 42
- Caterpillars, Wood-eating, Digestion, 464
- Cattle, Australian, Worm-nests, 626
- Descend, 351
- Ear Mite, 359
- Cauchemez, L., New Species of Echinorhynchus, 626
- Caulerpa, 74
- Caulley, M., Notes on Marine Heliozoon, 475
- Canwenberghe, A. v., Giant-cells of Mole's Placenta, 188
- Cavers, F., Inter-relationships of the Bryophyta, 224, 380
- — of the Hepaticæ, 64
- Cell and Nuclear Division in Closterium, 665
- Contents. See CONTENTS
- Cell, Pure Cultures from a Single, 819
- Cell-division in Lyngbya, 500
- Celloidin Decalcification Method, 820
- in Microscopical Technique, 121
- Sections of Nervous Tissue, Staining by Iron-hæmatoxylin Method, 119
- Serial Sections, New Method of making, 116
- Cells, Interstitial Testicular, Role, 740
- Organic, Bacteria and other, Method of Disintegrating, 592
- Cementation by Gases, 269
- in a Vacuum, 269
- of Steel, 269
- Centrifuge, Filtering by Aid of, 267
- Cépède, C., Astomatous Infusorians, 213
- Haplosporidian Parasite in Donax, 772
- Improvement in the Illumination of Objects observed with the Binocular Microscope, 96
- Cephalodiscus, Parasitic Copepod, 47
- Cephalopoda, Dibranchiate, Genera, 196
- See CONTENTS
- Cephalopods, Japanese, 615
- New, from Hawaiian Islands, 746
- Ceranium, 669
- Ceratinum, Genus, 768, 789
- Ceraticornys, 72
- Cereals, Rusts, 89
- Cerebellum in Fishes, Function, 614
- Cerebratulus, Experiments on Ova, 762
- Cerithiidae, Phylogeny, 356
- Cestodes, New, from Ceylonese Fishes, 471
- Cetacea, Fossil, 37
- Musculature of Pectoral Girdle and Flipper, 192
- Pelvic Bones, 459
- Chaetognatha from Ireland, 203
- West Indian, 204
- Chaine, J., Variations in Ureters of Weever, 38
- Chairman (E. J. Spitta), 128, 130, 131
- Chalande, J., Doubling of Segments in Myriopods, 621
- Chalon, J., *Gonimophyllum Buffhami*, 668
- Chambers, H., Action of Radium Radiations on Blood, 611
- Chapellier, A., State of Ovary in Hybrids of Goldfinch and Canary, 455
- Chapman, F., Foraminifera from Funafuti, 56
- Ostracods from Funafuti, 47
- Chara contraria* and *C. dissoluta*, 69
- *dissoluta* and *C. contraria*, 69
- *stelligera*, 70
- Charles, G. M., Anatomy of Marattia, 377
- Chatelier, H. le, Metallographic Notes, 556
- Spontaneous Disintegration of Aluminium, 555
- Chatton, E., Cnidosporidian without Cnidoblasts, 634
- New Ascidiaceous Copepod, 469
- — Flagellate in Pelagic Copepod, 212
- — Type of Suctorina on a Copepod, 477
- Parasitic Dinoflagellate, 57
- *Pleodorina californica*, 592
- — at Banyuls, 768
- Trypanosome and Leptomonad in Drosophila, 368
- Chauveau, M. A., Phenomena of Visual Inhibition which may accompany the re-association of the two Retinal Images dissociated by the Prisms of the Stereoscope. Conditions and Determination of these Phenomena, 410
- Chauveau, G., Evolution of Conducting-tissues of Vascular Plants, 638
- Transitory Tissues in Vascular Plants, 216
- Cheetham, C. A., British Bryophytes, 781
- Chelifer and Chernes, Reproductive Male Organs, 467
- Cheliped, Abnormal, of Lobster, 46
- Chemical Changes in Seed Plants. See CONTENTS
- Magnitudes, Infinitely Small, 110
- Chemotaxis of Fern Spermatozoids, 379

- Chermes pini*, Notes, 44
 Chermeson, H., Anatomical Researches on
 Sea-side Plants, 216
 Chermes and Chelifer, Reproductive Male
 Organs, 467
 Cherries, Mildew, 791
 Chick, Action of X-rays on Developing,
 455
 — Epidermic Fibrils, 458
 — Interchange of Limbs by Transplanta-
 tion, 738
 Chicken, New Tapeworm, 49
 Chilton, C., Crustacea of Kermadec
 Islands, 753
 — Dispersal of Marine Crustacea by
 Ships, 754
 — Studies on New Zealand Crustaceans,
 754
 Chironomidae, East Indian, 463
 Chiton, New Fossil from Girvan, 615
 Chladochytiriaceæ, Research, 233
Chlamydomonas Steinii, 662
 Chloralphenol, Amann's, Mounting
 Arthropoda, 416
 Chlorella, Behaviour in White and
 Coloured Lights, 385
 Chloroleucites, Formation, 773
 Chlorophyceæ from New Zealand and
 Tahiti, 667
 — West Indian, 667
 Chodat, R., Cocceogenous Cyanophyceæ,
 662
 — *Lepidodendron Brownii*, 488
 — Studies on the Conjugatæ, 73
 Cholera and Cholera-like Organisms,
 Characters, 246
 Chondriosomes, Cytoplasm and Chromidia,
 609
 — in Plant-cells, 479, 637
Chondrosia reniformis, Regeneration, 56
 Chordoid Tissue, 188
 Choreæ, Bacteriology, 245
 Christ, H., Chinese Ferns, 491
 — Ferns of Annam, 650
 — Mexican Ferns, 63
 Christensen, C., Ferns of Corea and
 Quelhaert, 650
 — Ferns of Temperate South America,
 223
 Chromatic Adaptation in Plants, Com-
 plementary, 776
 Chromatin Staining, New Method, 414
 Chromidia and Trophospongia, 457
 — Cytoplasm and Chondriosomes, 609
 — in Cells of Muscidae, 461
 Chromium Steels, 827
 Chromosome-reduction in *Oenothera*, 370
 Chromosomes, Accessory in Man, 29
 — in Salamander, Studies, 457
 — Number, in Parthenogenetically Pro-
 duced Larvæ of Frog, 454
 — of *Oenothera* Mutants and Hybrids,
 370
 Chrysler, M. A., *Ophioglossum palmatum*,
 777
 Chrysomadæ from Hirschberger Gros-
 steich, 661
 Chrysomonads, 661
 — Russian, Two, 499
 Chytridiaceæ, New Genus of, 799
 Chytridiales, *Monochytrium*, a New Genus,
 508
Cicinnobolus sp. Parasitic on Oak Mildew,
 393
 — — on *Spharotheca mors-uvæ*, 392
 Ciliary and Neuro-muscular Movements,
 Converse Relation, 350
 Ciliata, Fertilization, 768
 Cilimbaris, P. A., Pigment-cells in Sheep's
 Cornea, 190
 Cilium of *Trepouma pallidum*, 633
Cionia intestinalis, Tenacity of Life, 461
 Circulation in *Tipula maxima*, Respira-
 tion and, 749
 Circulatory System of *Lycosa carolinensis*,
 200
 Cirripede and other Commensals of Madre-
 pores, 624
 Cirripedes, Maxillary Glands, 201
 Cladoceera, Notes, 47
Cladochytrium cæspitii, 76
 Cladoniae, 89
 Cladosporium, Mosses attacked by, 653
 Clark, A. H., Comparative Age of Recent
 Crinoid Faunas, 629
 — New Unstalked Crinoid, 473
 Clark, A. Hobart, Recent Crinoids of
 Australia, 763
 — Interesting Structural Analogy, 191
 Clark, A. Howard, New European Crinoid,
 763
 Clark, H. L., Echinoderms of Peru, 51
 — Genera of Recent Clypeastroids, 472
 — North Pacific Ophiurans, 472
 Clarke, E. D., Poisoning by Fungi, 677
 Clathrocystis, 788
 Claviceps, New Host, 391
 Cleland, J. B., Hæmatozoa of Australian
 Batrachians, 633
 — of Australian Birds, 369
 — Worm Nests in Australian Cattle, 626
 Cler, E., Examination of Water for Typhoid
 Bacilli by the Complement-fixation
 Method, 547
 Clerici, E., Fossil Diatoms in Italy, 788
 — *Pleurococcus sulphurarius*, 788
 Closterium, Cell and Nuclear Division,
 665
 Clusiaceæ of North-west Madagascar, 59
 Clute, W. N., *Hemigramma latifolia*, 777
 — Nomenclature of Nephrodium, 221
 — and others, North American Ferns, 379
 Clypeastroids, Recent, Genera of, 472
 Cnidosporidia, 213
 Cnidosporidian without Cnidoblasts,
 634

- Co-efficients, Temperature, of Electrical Resistance, 274
- Coals, Algal, so-called, Pteridophytal Origin, 221
- supposed Algal, Investigating Nature, 262
- Cobb, J. W., Influence of Impurities on the Corrosion of Iron, 828
- Coccidian, New, from a Whelk's Kidney, 771
- Coccidiosis in Sparrows and other Wild Birds, 369
- Coccolithophoridae from the Adriatic, 499
- Cockayne, L., New Zealand Bryophytes, 69
- Cockerell, T. D. A., Scales of Fishes, 38
- Cockroach, Degenerate, 465
- Codiaceae, 389
- Codium tomentosum*, 666
- Coe, H. L., Manganese in Cast Iron, 272
- Coelentera. See CONTENTS
- Cohen, E., Physico-chemical Studies of Lead, 417
- Zinc Amalgams, 417
- Colacodasya, 505
- Cole, L. J., Abnormal Cheliped of Lobster, 46
- Notes on *Eudeis spinosus*, 45
- Pacific Pyenogonids, 45
- Colcs, A. C., Fading of Anilin-stained Microscopical Preparations, and a New Medium, 415
- Colgan, N., Marine Molluscs of Clare Island, 461
- Coli-form Organisms, Comparative Study, 91
- Colin, H., Absorption by Plants of Alkaline Earth Salts, 218
- Colymbola, New, in England, 620
- Collecting Objects. See CONTENTS
- Collin, B., New Type of Suctorina on a Copepod, 477
- Collin, R., Staining the Internal Network in Nerve-cells, 119
- Colloderma, a New Genus of Mycetozoa, 90
- Collodion Filters, 548
- Resistance to passage of Microbes, 548
- Colomina, A. de, Large Sun-fish, 195
- Colour-change in Fishes, 160
- Colour-etching of Steel, 561
- Colour-pattern in Hybrid Poultry, Inheritance, 34
- Colour-inheritance in Pigeons, 738
- Colour-sense of Hive-bee, 40
- Coloured Plates of Microscopical Preparations, 258
- Colouring of Trout, 739
- Colpidium, Nuclear Changes in Conjugation, 635
- Colpomonia sinuosa*, 787
- Colver-Glauert, E., Magnetic Properties of Nickel Steels, 827
- Sulphurous Acid as an Etching Medium, 273
- Comb, Fowl's, Fluctuation in Growth, 604
- Combes, R., Opinions upon Physiology of Leaf-fall, 776
- Comère, J., Classification of Algæ, 385
- Comparator or Reading Microscope, 807
- Comstock, J. H., Palpi of Male Spiders, 44
- Condenser, Cardioid, History: Memorandum on the Leitz Mirror Condenser, 693
- Jentsch's Concentric, 98
- Conidial Fusion in *Ustilago Tragopogipratensis*, 394
- Conifer-wood, Starch-grains and Oil-drops, 638
- Conifers, Anatomy and Morphology of Roots, 371
- Conjugatae and certain Green Algæ, Metachromatic Bodies, 72
- Studies, 73
- Conjugation, Homothallic, in *Rhizopus nigricans*, 507
- in Paramœcium, 634
- of Colpidium, Nuclear Changes, 635
- Conn, H. J., Bacteria in Frozen Soil, 92
- Connolly, C. J., Florideae, 786
- Conrady, E., 567
- Conte, A., Acephalous Lepidoptera, 464
- Conulus, Teeth and Buccal Structures, 208
- Cook, M. H., Spermatogenesis in Lepidoptera, 43
- Copeland, E. B., Bornean Ferns, 778
- Papuan Ferns, 779
- Philippine Ferns, 778
- Protolindsaya and other Bornean Ferns, 65
- Copepod, New Ascidicolous, 469
- Type of Suctorina on, 477
- Parasitic, from Cephalodiscus, 47
- Pelagic, New Flagellate in, 212
- Copepods, New Parasitic, 755
- Parasitic on Aleyonarians, 202
- Copper Alloys, Occluded Gases, 418
- Antimony, and Bismuth Alloys, 124
- Behaviour towards Gases, 268
- Effect of Silver, Bismuth and Aluminium, 418
- Extraction of Gases, 712
- Impurities, 125
- Copper-zinc Alloys, New Critical Point, 710
- Coppey, A., Moss-flora of Haute-Saône, 382, 656
- Mosses of the Haute-Saône, 229, 782
- Coprinus atramentarius*, Cystidia, 82
- Copulation of Yeast-cells, 392
- Coral, New Ocoradiata, 210
- Coral-formations, History of Study, 473
- Corallium, Formation of Axis, 55
- Corbière, L., Moss-flora of Tunis, 382

- Cordenroy, H. J. de, Clusiaceæ of North-west Madagascar, 59
- Coremium-formation in *Penicillium*, 79
- Corixa, Study, 199
- Cornea, Excised, Survival, 350
— Sheep's, Pigment-cells, 190
- Cornet, A., Belgian Bryophytes, 656
- Corpora Adiposa of Amphibians, 613
— — of Frog, 744
- Corpus Luteum, Reticular Apparatus in Cells, 190
- Corrosion of Iron, Influence of Impurities, 828
— of Metals, 715
- Cortinarii, German, 81
- Corymorpha, Geotropism, 211
— Regeneration, 210, 365
- Coscinodiscus asteromphalus*, Structural Detail, 722
- Coste, M., Gold-tellurium System, 417
- Cotton, A. D., *Colpomenia sinuosa*, 787
— *Lithopyllum fasciculatum*, 506
— *Ulva latissima*, 664
- Cotyledons, Effect of Injury to upon Seedling Development, 60
- Coulter, J. M., American Lepidostrobos, 647
- Council, Annual Report for 1910, 134
— New, 137
- Coventry, A. F., Theory of Dwarf Males in *Myzostoma*, 204
- Crab, Epizoic Hydroid on, 765
- Crabs, Californian, 468
- Crane, C. G., Photogenic Organs of Lampyridæ, 464
- Cratægus: Some Theories concerning the Origin of its Species, 220
- Cratoneuron and Hygramblыstegium, 493
- Crayfish Plague, 753
- Crinoid Faunas, Recent, Comparative Age, 629
— New European, 763
— New Unstalked, 473
- Crinoids, Recent, of Australia, 763
- Criodrilus lacum*, Development, 202
— Neurochords, 202
- Cristispira and Spirochaeta, 58
- Crocynia, a Genus of Lichens, 519
- Crosby, C. R., Apple Red Bugs, 358
- Crossland, C., Fungus Foray at Sandstead, 516
- Crushing and Abrasion, Resistance of Steels, 714
- Crustacea, Decapod, Photophores, 45
— Marine, Dispersal of, by Ships, 754
— of Kermadec Islands, 753
— See CONTENTS
- Crustacean, Rhizocephalons, from Fresh-Water, 755
— New Carboniferous, 469
- Crustaceans, New Zealand, Studies, 754
- Cryoscopic Determination of Osmotic Pressure in certain Plant Organs, 219
- Cryptogams. See CONTENTS
- Cryptomonadeæ, 661
- Crystal Plates, Transparent Inactive, Transmission of Light, with Special Reference to Observations in Convergent Polarized Light, 109
- Crystallization of Cast Metals, 828
— of Steel, 828
— of White Cast Iron, 712
- Crystallography of the Iron-carbon System, 125
- Crystalloptic Projection, Aids, 698
- Ctenodrilus, New Species, 625
- Cucumaria, Species, 52
- Cuirass of Peridiniidæ, 768
- Culicidæ, Classification, 619
- Culmann, P., Notes on *Grimmia*, 654
- Cultivating *Bacillus influenzae*, New Method for making Blood-agar, 820
- Cultivation of Spirochaetes, 819
- Culture, Mushroom, 82
— Processes. See CONTENTS
- Cultures, Aqueous, of Fern Prothallia, 490
- Cultures, from a Single Cell, Pure, 819
- Cumacea, New and Rare, 468
- Cumanotus, Genus, 39
- Cunina parasitica*, Development, 764
- Cunninghamia, Gametophytes and Embryogeny, 481
- Curl, H. C., Digestive System of Hornbill, 612
- Currant, Leaf-spots, 795
- Currant-moth, Spermatogenesis, 357
- Curties, C. L., New dark-ground Illuminator designed by E. M. Nelson, 276
- Curtis, M., Ligaments of Oviduct of Domestic Fowl, 35
- Curtis, M. R., Weighing Parts of Eggs, 744
- Curve, Transformation-point, 126
- Cuticle in Insects, Minute Structure, 747
- Cutting Apparatus, Rock-section, Improvements, 703
— Objects. See CONTENTS
- Cyanophyceæ, Cœcogenous, 662
- Cyathæaceæ and Polypodiaceæ, Relation to Woodsieæ, 486
- Cyathomonas, 661
- Cycads, Occurrence of Phagocytosis in Root-nodules, 60
- Cycas Embryos, Incubation, 463
- Cyclops, Revision of North American Species, 201
- Cyst, Dermoid, Teeth of Two Dentitions, 604
- Cysticeroids from Rat- flea, 471
- Cystidia of *Coprinus atramentarius*, 82
- Cystotæniæ of South American Felidæ, 206
- Cytology of Bacteria, 523
— — — Studying, 413
— See CONTENTS
- Cytoplasm, Chondriosomes, and Chromidia, 609
— Threads and Granules, 189

D

- Daday, E. v., Fresh-water Microfauna of German East Africa, 39, 195
 — Micro-fauna of the Nile, 355
- Dakin, W. J., New Coccidian from a Whelk's Kidney, 771
 — Physiology of Fish-eggs and Larvæ, 738
 — Visceral Ganglion of Pecten, 40
- Dalyellidæ and Umagillidæ, 472
- Dammermann, K. W., Structure and Function of the *Saccus vasculosus* in Fishes, 194
- Dampf, A., New Flea from Jerboa, 43
- Danforth, C. H., Periodicity in *Spirogyra*, 231
- Dangeard, P. A., Algæ from the Laboratory at Roscoff, 70
 — Behaviour of *Chlorella* in White and Coloured Lights, 385
 — Complementary Chromatic Adaptation in Plants, 776
 — Effect of Light on Algæ, 785
 — Fertilization in Ciliata, 768
 — New Genus of Polyblepharidæ, 71
 — Nuclear Autochromatism in Algæ, 785
- Daniel, J. F., Gestation in White Mice, 737
- Dantschakoff, W., Blood-formation in Grass Snake, 188
- Danvis, E., Head of *Kogia breviceps*, 351
 — Spermaceti-organ of *Kogia breviceps*, 37
- Daphnids, Sex-determination, 757
- Darbois, P., Resistance of *Micrococcus melitensis* to Lactic Ferments, 403
- Dark-ground Illuminator, with Arrangement for Centring on a Plain Stage, Reichert's, 814
- Darwacki, L., Presence of Streptotrichæ in Tuberculous Sputum, 522
- Daumézou, G., Tenacity of Life in *Ciona intestinalis*, 461
- Dauphin, J., Study of Mortierellæ, 77
- Davenport, G. C., and C. B., Inheritance of Skin-pigmentation in Man, 30
- Dearness, J., Mushroom Poisoning, 509
- Debarya, New Species, 502
- Decalcification Method, Celloidin, 820
- Decapods Larval Stages, 468
 — Sperm Transfer, 753
- Deegener, —, Intestinal Secretion in *Dytiscus*, 41
- Deer, Nematodes, 760
- Déses, E. D. de, Monograph of Phyllopora *Anostraca*, 46
 — New Antarctic Phyllopod, 47
- Defner, A., Maxillary Glands of Cirripedes, 201
- Degen, A. von, *Dichiton calyculatum* in Croatia, 655
- Dehaut, E. G., Heart of Lungless Urodela, 460
- Dehorne, A., Nuclear Changes in Conjugation of Colpidium, 635
 — Number of Chromosomes in Parthenogenetically produced Larvæ of the Frog, 454
- Dehydrating Apparatus, Washing, 822
- Beibel, J., Respiration in *Donacia* and *Macrolepa*, 198
- Deinosaurs and Birds, 192
- Delachanal, B., Occluded Gases in Copper Alloys, 418
- Delaeroix, G., Plant Diseases in the Tropics, 514
- Deleourt, A., Immobilising Flies for Microscopic Investigation, 266
- Deleano, N. T., Removal of Starch through the Petiole, 373
- Delezenne, C., Snake-poison and Yolk of Egg, 613
- Delphinium, Splitting of Rhizome and Root, 774
- Demodex, Alleged Importance in Spreading Leprosy, 622
- Demoll, R., Migration of Iris-pigment in Compound Eye, 616
- Denys, G., Anatomy of Polyides and *Furcelloria*, 785
- Derjugin, K., Pectoral Girdle and Fins of Teleosteans, 195
- Dermestes, Eye, 41
- Dershawin, A., *Polypodium hydriforme*, 365
- Descent of Cattle, 351
- Desch, C. H., Crystallization of Cast Metals, 828
 — Defects in Alloys, 560
- Desiccation-phenomena in Mosses, 381
- Desmidiaceæ of Bohemia, 232
 — Polymorphism and Life-history, 389
- Desmids of Burgäselhimoos, 665
 — Swiss, 74
- Desroche, P., *Chlamydomonas Steinii*, 662
- Dessiatoff, N., Embryo-sac of *Euphorbia*, 641
- Development of Seed Plants. See CONTENTS
- Diakonoff, H. v., Plant-diseases in Russia, 238
- Diaptomidæ, Geographical Distribution, 201
- Diastases, Latex, of *Broussonetia*, 483
 — Proteolytic, Action, 642
- Diatomic Structure, 593
 — New, discovered with a New Zeiss Apochromat, 700
- Diatoms, 73
 — and Flagellatæ from East Greenland, 660
 — Fossil, 788
 — from Dahomey, 74
 — in Sedimentary Deposits, Study, 385
 — Physiology, 784
- Dichiton calyculatum* in Croatia, 655
- Dichotomosisphion and *Mischococcus*, 788

- Dicranoloma*, 66
Dicrocoelium lanceatum, Life-cycle, 361
 Dietyophora and Ithyphallus, 237
Didinium, "Trichites," 632
 Diedicke, H., Genus *Phomopsis*, 510
 Dietz, E., Echinostomide of Birds, 205
 Dieudonné's Medium, Selective Action, 260
 Digestive System of Hornbill, 612
 Dinoflagellate, Parasitic, 57
 Dinoflagellates, 769
Diospyros, Morphology, 640
Dipluchlanis, a new Sub-genus for *Euchlanis* (*Diplois*) *propatula* Gosse, 363
Diplococcus gadidarum, the cause of the reddening of Cod and other Allied Fish, 804
Diplodia, Gum-inducing, of Peach and Orange, 672
 Diptera, Cuvé, 618
 Diptera, Development of Stele, 644
Dipylidium caninum in a Child, 49
 Disease, Bee, 616
 — Dissemination by *Stomoxys calcitrans*, 463
 — Fish, 799
 Disease-carriers, 93
 Diseases of Economic Plants, 84
 — of Plants, 84, 238, 514, 796
 — of Trees, Research, 397, 677
 — Plant, in the Tropics, 514
 Disintegrating Bacteria and other Organic Cells, Method, 592
 Disk of Confusion, Diameter, 282
 Disks, Suctorial, of Male Ditiscoids, 198
 Disney, A. N., 139
 Distaso, A., *Bacillus cellulose desagreans* sp. n., 686
 — Studies of the Intestinal Flora, 687
 Ditlevsen, C., Nuclear Budding in Corneous Epithelium, 610
 Dittschlag, E., Research on Uredinæ, 394
 Dixon, H. H., Edward Perceval Wright, 61
 Dixon, H. N., *Fissidens tequendamensis*, 383
 — Hyphilopsis, a New Indian Moss-genus, 654
 — *Merceyopsis* g.n., and other Indian Mosses, 66
 — Mosses of Spitzbergen, 494
 — Tencritic Mosses, 382
 Dobell, C. C., Affinities of Spirochaets, 369
 — Cytology of the Bacteria, 523
 — Homeocystidium of the Gecko, 475
 — Studying the Cytology of Bacteria, 413
 Dodd, S., Blood Parasites, 57
 — Microfilaria in Magpies, 48
 Poffein, F., Behaviour of Prawns, 623
 Dog, Domestic, Origin, 743
 Demergue, F., Rapid Method of Identifying *Bacillus coli*, 409
Donacia and *Macropoda*, Respiration, 198
Donax, Haplosporidian Parasite, 772
 Doncaster, L., Effects of One-sided Ovariectomy on Sex of Offspring, 451
 — Gametogenesis of Gall Fly, 748
 — Spermatogenesis in Currant-moth, 357
 Donnan, F. G., Solubility of Oxygen in Molten Silver, 125
 Dopscheg-Uhlár, J., Regeneration and Polarity of Plant-organs, 219
 Douin, I., Inflorescence of Muscinæ, 779
 — *Lophocolea minor*, not a species, 781
 Dragon-fly, Histological Study of the Innervation of the Heart of Larval, 750
 — Larvæ, Experiments, 750
 Douville, H., Evolution of Man, 36
 Drake and Gander, Penis, 353
 Drawings for Projection Purposes, Simple Method of Making, 100
 Drepanocladus, 655
 Drew, G. H., Reaction of Tissues of Pecten to Implantation of Foreign Bodies, 356
 Dreyer, T. F., Blood-vessels and Nerves of *Æolidiæ* and *Tritoniadæ*, 196
 Drop-bottle for Preventing the Action of Air on Copper-oxide-ammonia Solution, 121
 Druce, G. C., *Tolypella intricata*, 669
 Drury, C. T., British Fern-varieties, 63
 Drugs and Food, Microscopical Examination, 121
Dryptodon Hartmani, 497
 Dubard, M., Remarks on Strephonema, 485
 Dubois, R., Fluorescence in Luminous Insects, 748
 Duboseq, O., Selenocoidium and the Relationships of the Sporozoa, 213
 Dubreuil, G., Mitochondria of Adipose Cells, 349
 Duck, New Tapeworm, 471
 Duclaux, J., Collodion Filters, 548
 Ducrey's Bacillus and Influenza Bacillus, Cultivation Medium, 549
 Dudgeon, L. S., New Method for Differentiation of Bacteria, 109
 Dufour, L., Observations on Primary Leaves, 215
 Dufourt, A., New Types of Urobacteria, 93
 Dung-flies, Herpetomonads, 57
 — Oviparity and Viviparity, 198
 Dunham, E. M., *Polytrichum*, 781
 Dunkerly, J. S., Leptomonad of the House-fly, 633
 Duplicity in Chick Embryos, 33
 Dupuy, E. L., Arsenides of Tin, 825
 Durand, E., Mosses of Libya, 658
 — Pteridophytes of Libya, 649
 Dysentery and Typhoid Bacilli, Variations, 526
 — Bacilli, Action on Nitrites and Nitrates, 94
Dytiscidæ, Oogensis, 198

- Dytiscids, Male, Suctorial Disks, 198
 Dytiscus, Alimentary Canal, 748
 — Intestinal Secretion, 41
Dytiscus marginalis, Nervous System, 41
 Dwarf Males in Myzostoma, Theory, 204
- E
- Ear of Urodela, 193
 Earland, A., 139
 — Methods employed in the Cruisers of the International North Sea Commission, 130
 — On the Recent and Fossil Foraminifera of the Shore-sands of Selsey Bill, Sussex—VII, Supplement (Addenda et Corrigena), 298; VIII, Tabular list of Species and Localities, 436
 — Studies on British Foraminifera, 366
 Earthworm, Supposed Nematode in Circular Muscle, 48
 Earthworms and Leech, Nerve-cells, 624
 — Australian, Studies, 624
 — Caucasian, 48
 — Parasitic Castration, 360
 — Reaction to Acids, 48
 Eber, A., Human and Bovine Tubercle, 686
 Echinoderm, Hybridization, 363
 — Permian, Remarkable, 210
 Echinoderma. See CONTENTS
 Echinoderms, Early Stages of Development, 363
 — of Peru, 51
 Echinoids, West Indian, 208
 Echinorhynchus, New Species, 626
 Echinostomidae of Birds, 205
 Edgerton, C. W., and others, Diseases of Plants, 796
 Edible Fungus, Culture, 236
 Edinger, L., Path of Hypophysis-secretion, 610
 — Pointer-Double-Ocular, 252
 Edwards, C. A., Theory of Hardening Carbon Steels, 271
 Edwards, C. L., Idiochromosomes in Ascaris, 204
 — Species of Cucumaria, 52
 Eels, Electric, 354
 Egg, Large, Laid by a Beetle, 748
 — Yolk of, and Snake-poison, 613
 Eggs, Herring's, Retarding Development, 739
 — Weighing Parts, 744
 Electric Arc, Metallic, Use in Photomicrography, 21
 — Eels, 354
 Electrical Conductivity of Molten Alloys, 274, 560
 — Resistance, Temperature Co-efficients, 274
 Elfving, F., Lichen Gonidia, 399
- Ellis, D., *Spirophyllum ferrugineum*, 686
 Elmastian, M., Examining the Salivary Glands of Ticks, 109
 — Salivary Glands of Ticks, 45
 Elmhirst, R., Ambi-coloured Flatfish, 746
 — Pycnogonids of Clyde Area, 200
 — Yawning in Fishes, 194
 Elwes, E. V., Littoral Polychæta of Torquay, 48
 Embedding and Fixation of Embryological Material, 111
 — Vacuum, Adaptation of Ordinary Paraffin Baths for, 26
 Embidæ, Monograph, 465
 Embryo-sac Development in *Hybanthus concolor*, 218
 — of Euphorbia, 641
 — of the Platanaceæ and Ovule, 775
 Embryo, Human, Islands of Langerhans, 31
 Embryogeny and Gametophytes in Cunninghamia, 481
 Embryology in Euphorbiaceæ, 372
 — of Vertebrata. See CONTENTS
 Embryos, Chick, Duplicity, 33
 — Cycles, Incubation, 463
 Emile-Weil, E., Anti-coagulant Action of Nematode Extract, 205
 Emrys-Roberts Microscope Lamp, 571, 698
 Enchytræids II., British, the Genus Fridericia, 838
 — New British, 730
 Encystation in Pelomyxa, 631
Endeis spinosus, Notes, 45
 Engelke, C., Notes on Myxomycetes, 520
 Enteromorpha, Saprophytism, 231
 Enteron, Development in American Alligator, 187
 Entozoa in Australian Birds, 760
 — from Clyde Fishes, 49
 Enumeration, Direct, of Bacteria in Water, 552
 — of Bacteria in Milk, 710
 Enzymes in Different Bacteria, 94
 Ephemerum and Nanomitrium in North America, 66
 Epidermal Characters of *Frenelopsis ramosissima*, 774
 Epidermic Cells of Tadpoles, Thread-like Structures, 189
 — — Protoplasmic Fibres, 189
 — Fibrils in Chick, 458
 Epiphytes of the Laminariæ, 386
 Epithelial Cells of Mammalian Kidney, 609
 Epithelium, Conjunctival, in Man, 610
 — Cornuous, Nuclear Budding, 610
 — Sensory, Supporting Elements, 189
 — Tracheal, in Domestic Mammals, 349
 Epizootic, Mouse, due to Coliform Bacillus, 246
 Equilibration in Aquatic Animals, 614
 Equilibrium Diagrams, 560

- Equisetum, compared with Calamites, 62
 — *maximum*. Distribution, 648
 — Prothallia, 645
 Erdmann, R., Depression and Apogamy in
Amaba diploidea, 475
 — Development of *Sarcocystis muris*, 771
 Ergasilidae, North American, 756
 Ergot, Insects as Disseminators, 463
 — on Oats, 391
 — Spores, Infection by, 791
 Erhard, H., Trophospongia and Chromi-
 dia, 457
 Eriksson, J., and others, Plant-diseases,
 678
 Erysiphææ, Notes, 671
 Erythronium, Origin and Development of
 Bulbs in the Genus, 371
 Erythrocladia, 787
 Erythrocytes, Method of Studying Phago-
 cytosis by Endothelial Cells, 110
Erythrophyllum delesserioides, 504
 Esterly, C. O., Diurnal Migrations of
Calanus finmarchicus, 757
 Etching Medium, Sulphurous Acid, 273
 Etherization, Effect of, on Metabolism, 776
 Euglena, Red, 662
 — *viridis*, 499
 Euglenid Parasite, Internal, 635
 Eonymus, Japanese, Oidium, 78
 Euphorbia, Embryo-sac, 641
 Euphorbiaceæ, Embryology, 372
 Euphorbias, Leptomonad in, 367
 Euplotes, Structure, 368
 — *woosteri*, Division, 368
 Eurich, F. W., New Method for the De-
 tection of Tubercle Bacilli in Sputum,
 823
 Eutelects, Composition, 563
 Evans, A. W., Hepaticæ of the Puerto Rico,
 783
 — of the Bahama Islands, 783
 — New England Hepaticæ, 67
 — North American Hepaticæ, 782
 Evans, I. B. P., and another, Plant-
 diseases in South Africa, 678
 Evans, W., British Bryophytes, 494
 Evolution and Heredity, 453
 — of Man, 36
 Evolution-centres, 457
 Ewald, W. F., Contraction of Adductors
 in Fresh-water Mussels, 616
 Ewart, J. C., Descent of Cattle, 351
 Ewen, D., Shrinkage of the Antimony-lead
 Alloys, 418
 Excretory System of Bothriomolus, 471
 Exhibition of Pond Life, 427
 Exotrophy and Leaf-symmetry, 639
 Extra-enteric Aperture in a Leech, 361
 Extremities in Birds, Development, 345
 Eye, Compound, Migration of Iris-pigment,
 610
 — of Dermestes, 41
 — of Protopterus, 741
 Eye of Pteropus, 189, 740
 — Sensibility to Variations of Wave-length
 in Yellow Region of Spectrum, 106
 Eye-piece, Allau's Variable, 693
 — Variable, 570
 — Wink's, with Screw Micrometer and
 Graduated Glass Diaphragm, 536
 Eye-pieces and Objectives, New, by R.
 Winkel of Göttingen, 281, 451
 — See CONTENTS
 Eyes, Compound, of Water-mites, Study-
 ing, 413
 Eyre, J., 423, 424
- ## F
- Fabre-Domergue, —, Cleansing Oysters, 40
 — Feeding Habits of Oysters, 40
 Fading of Anilin stained Microscopical
 Preparations and a New Medium, 415
 Faces, Method of Examining for Evidences
 of Parasitism, 554
 Fage, L., Study of Species of Gadus, 354
 Falek, R., Infection by Ergot Spores, 791
 Fantham, H. B., Bee Disease due to
Nosema apis, 769
 — Life-history of *Trypanosoma gambiense*
 and *T. rhodesiense*, 770
 Fat in Ciliated Infusorians, 212
 Fat-destroying Fungi, 677
 Fatigue of Metals, 274
 Fats, Staining, 549
 Faulk, J. H., Study of Laboulbeniales,
 790
 Faunas, Recent Crinoid, Comparative Age,
 629
 Fauré-Fremiet, M. E., Continuity of Mito-
 chondria through many Generations
 of Cells, 190
 — "Triehites" in Didinium, 632
 Faust, O., Limits of Elasticity, and the
 Hardening of Metals, 562
 Fawcett, H. S., Fungus parasitic on Citrus
 White Fly, 795
 — Gum-inducing Diplodia of Peach and
 Orange, 672
 Fedele, M., Innervation of Heart in Rep-
 tiles and Batrachians, 458
 Federley, H., Conidial Fusion in *Ustilago*
Tragopogi-pratensis, 394
 Fedorow, A. S., Alloys of Silver with
 Cadmium, 825
 Feeding Reactions of the Rose-coral, 53
 Felidae, South American, Tapeworms, 49
 Felser, H. L., Influence of Segregation on
 the Strength of Mild Steel, 270
 Felt, E. P., Injurious Insects, 466
 Femoral Bones, Minute Structure, 608
 Ferdinandsen, C., Fungi from Greenland,
 395
 — — from Venezuela and the West Indies,
 395

- Ferguson, M. C., Embedded Antheridia in Pteris, 644
- Fermentation and Micro-organisms, 396
- Fern, Fossil, *Schizaeopsis expansa*, 489
- Fronds, Mechanism by which they roll up, 378
- Prothallia, Aqueous Cultures, 490
- Fern-flora of Spain and Portugal, 222
- Fern-spermatozoids, Chemotaxis, 379
- Fern-spores, Influence of Light and Darkness on Germination, 491
- Fern-varieties, British, 63
- Fernbach, A., Action of Proteolytic Diastases, 642
- Ferns, African, 779
- American, 778
- Bornean, 778
- — Protolindsaya, and other, 65
- Chinese, 491, 650
- Corsican, 491
- Fossil, Studies, 61
- Japanese, New, 223
- Malayan, 491
- Mexican, 63
- North American, 379
- of Annam, 650
- of Argentina, 223
- of Borneo, 64
- of Corea and Quelpaert, 650
- of German Central Africa, 223
- of Kermadec Islands, 64
- of North America, 222
- of Perak, 778
- of Schleswig-Holstein, 649
- of South Croatia, 222
- of South Mexico, 63
- of Temperate South America, 223
- of the Falkland Islands, 650
- of the Philippine Islands, 66
- Papuan, 779
- Philippine, 778
- Queensland, 491
- some Mesozoic, and their Leaf-scars, 647
- Fertilization in Ciliata, 768
- Fever, Parasite of Coast, 770
- Filaria bancrofti*, Structure, 759
- Blood, in Horse, 470
- “ Filtrations ” of Metallic Alloys, 715
- Filicinian Leaf-trace, Evolution, 376
- Filter, P., *Tilletia horrida* in Rice-meal, 510
- Filtering by Aid of Centrifuge, 267
- Filters, Collodion, 548
- — Resistance to passage of Microbes, 548
- Fin, Pectoral, Development in *Amia*, 607
- Fink, B., Carolyn Wilson Harris, 90
- Nature and Classification of Lichens, 801
- Firket, J., Epidermic Fibrils in Chick, 458
- Firs, Witches-brooms, 83
- Fish, Bacillary Disease, 405
- Fish-Eagle, Leucozoözoön, 477
- Fischer, E., Studies in Ascomycetes, 670
- Fischer, H., Aqueous Cultures of Fern Prothallia, 490
- Influence of Light and Darkness on Germination of Fern-spores, 491
- Negative Staining of Bacteria, 823
- Total Closure of Gut in Healthy Frog, 193
- Fish Disease, 799
- Eggs and Larvæ, Physiology, 738
- Fisheries of New South Wales, 195
- Fishes, Ceylonese, New Cestodes, 471
- Clyde, Entozoa, 49
- Colour-change, 469
- Fresh-water, Muddy Taste, 37
- — Trypanosomes, 632
- Function of Cerebellum, 614
- Irish Sea, Parasites, 49
- Luminous Organs, 745
- Marine, Intestinal Flagellates, 369
- Parasites, 760
- Scales, 38
- Structure and Function of the Sacculus vasculosus, 194
- Sympathetic Nervous System, 696
- Ventral Musculature, 194
- Yawning, 194
- Fissidens tequeñamensis*, 383
- Variable Leaf-border, 492
- Fistulina hepatica*, Hypochrysis Form, 512
- Fitting, H., Premature Fall of the Perianth, 485
- Fixation and Embedding of Embryologica Material, 111
- and Staining of Glycogen, 821
- Fixing and Staining, Simultaneous, 702
- Objects to Stage, 273
- Flagellate and Diatoms from East Greenland, 669
- and Halosphæra, 660
- Brown, Two, 661
- Flagellate, New, in Pelagic Copepod, 212
- Flagellates, Intestinal, of Marine Fishes, 369
- Notes, 632
- Polymorphism, 768
- Studies, 634
- Flatfish, Ambi-coloured, 746
- Flatters, A., The Micrologist, 701
- Flea, New, from Jerboa, 43
- — from South Africa, 617
- Rat, Development of *Trypanosoma lewisi*, 58
- Fleischer, M., Mosses of New Guinea, 495
- Flesh-parasites of Food-fishes, 206
- Flies, Immobilising, for Microscopic Investigation, 266
- Sterile, Rearing, 261
- Flora, Intestinal, 94
- Floridæ, 786
- Flu, P. C., Protozoa in the Alimentary Canal of House-fly, 631
- Fluid Mounting, 551

- Fluorescence in Luminous Beetles, 748
 Fly, Citrus White, Fungus Parasitic on, 795
 Food of Shrew-mole, 352
 Food-fishes, Flesh-parasites, 206
 Foods and Drugs, Microscopical Examination, 121
 Foot, J. S., Minute Structure of Femoral Bones, 608
 Foot-and-mouth Disease, 804
 Foraminifera, British, Studies, 366
 — from Funafuti, 56
 — Recent and Fossil, of the Shore-sands of Selsey Bill, Sussex—VII., Supplement (Addenda of *Corrigenda*), 277, 298; VIII., Tabular List of Species and Localities, 436
 Forceps, New, 416
 Ford, W. W., Bacteriology of Baltimore City Water, 524
 Fore-gut and Mid-gut, Junction in Hive-bee, 197
 Forti, A., Diatoms, 73
Fossombronia echinata, 655
 Foster, N. H., Woodlice of Ireland, 469
 Fowl, Domestic, Ligaments of Oviduct, 35
 — Microfilaria, 625
 — Queensland, New Nematode in Eye, 48
 Fowl's Comb, Fluctuation in Growth, 604
 Fowler, H. W., Variation of Species of *Notropis*, 38
 Fowls, Cæcal Parasites, 632
 Fox, C. P., Film Test for Crude Rubber, 416
 Fraena, C., Parasites of Leucocytes in Brown Rat, 633
 — Studies on Hæmatozoa, 633
 Franz, V., Function of Cerebellum in Fishes, 614
 Fraser, E. T., Cultivation Medium for the Influenza Bacillus and Dueroy's Bacillus, 549
 Fréiberg, W., Forms of Ophioglossum, 643
Frenolopsis ramosissima, Epidermal Characters, 774
 Freund, L., Ear Mite of Cattle, 359
 Friedrich, K., Iron Sulphide-iron System, 126
 Friend, H., British Enchytræids II, the genus *Fridericia*, 838
 — New British Enchytræids, 730
 Fries, R., Spore formation in *Nidularia*, 791
 Fries, R. E., Monocotyledonous Characters in the Polycarpeæ, 640
 Fries, H., Species and Varieties of Humble-bees, 197
 Frilley, R., Alloys of Silicon with Metals, 712
 Frisch, K. v., Colour-change in Fishes, 460
 Frisch, G., Eye of Pteropus, 710
 — Retina of Birds, 610
 Fröhlich, A., Use of Picramic Acid for Staining, 118
 Frog, Burmese New, 353
 — *Corpora Adiposa*, 714
 — Development of Gonads, 456
 — Healthy, Total Closure of Gut, 193
 — Number of Chromosomes in Parthenogenetically produced Larvæ, 454
 — Robber, Notes, 469
 — Trypanosomes in Japan, 632
 Frog-hoppers, Green Muscardine, 673
 Fronds, Fern, Mechanism by which they roll up, 378
 Fruetification of *Macrocystis*, 504
 Fruit of Geraniaceæ, 641
 Fry, A., Introduction to British Liverworts, 228
 Fry, Sir E., Introduction to British Liverworts, 228
 Frye, T. C., Polytrichaceæ of North America, 383
 Fucus, Hybrid Form, 75
 Fülleborn, F., Rotifera of German East Africa, 208
 Fungagines, Contribution to the Study of, 794
 Funaria, Inflorescence, 492
 Fungi and Termites, 397
 — Assimilation of Nitrogen, 512
 — Chilian, Notes, 395
 — Cultures of Mixed, 794
 — Fat-destroying, 677
 — Fresco-painting of, 677
 — from Greenland, 395
 — — Venezuela and the West Indies, 395
 — Hepaticæ Infected, 492
 — Higher, Chemistry, 396
 — — Do they require Lime? 82
 — *imperfecti*, Study, 509
 — in Clay Mines, 397
 — in the Rhizoids of Leafy Hepatics, 513
 — Larger, Notes, 81, 83, 236, 676, 794
 — New, from the Tyrol, 673
 — North American, 392
 — Notes, 516
 — Origin of Parasitism, 238
 — Parasitic, 393
 — Pathogenic, 798
 — Phototropism and Geotropism, 396
 — Poisoning, 677
 — Smut, 675
 — Wood-destroying, 237
 — See CONTENTS
 Fungicides, 84
 Fungus, Ambrosia, 396
 — Edible, Culture, 236
 — Foray at Sandsend, 516
 — of House-fly, 234
 — parasitic on Citrus White Fly, 795
 — Root-tubercles, 237
 Fungus-carriers, Insects as, 515
 Fungus-flora, German, 395, 512

Fucellaria, Anatomy of Polyides and, 785
Fusarium, Monograph, 393

— *nivide* and *Nectria graminicola*, 78

G

Gadus, Study of Species, 354
Gage, H. P., Arc Lamps for Projection, 96
Gain, L., New Species of Nostoc, 664
Galathids, Olfactory Structures, 623
Gall-fly, Gametogenesis, 748
Galli-Valerio, B., Etiology of Rhinoscleroma, 525
— *Ferruga peruana*, 522
Galvanizing, Effect on Strength of Steel Wire, 559
Gamasids, Cavernicolous, 752
Gametogenesis of Gall-fly, 748
Gametophytes and Embryogeny in Cunninghamia, 481
Gander and Drake, Penis, 353
Ganglion, Visceral of Pecten, 40
Gard, M., Hybrid form of Fucus, 75
Garjeanne, A. J. M., Fungi in the Rhizoids of Leafy Hepatics, 513
— Hepaticæ Infected by Fungi, 492
— Simple Excursion Microscope, 690
Garry, R., Fresh-water Algae of the Clyde Area, 788
Gartner, P., Colour-etching of Steel, 561
Gases, Behaviour of Copper towards, 268
— Cementation by, 269
— Extraction from Copper, 712
— in Commercial Steel and Iron, 270
Gaskell, J. F., Action of X-rays on Developing Chick, 455
Gaspari, F. de, *Bacillus pappulus*, 804
Gasterostomum tergustinum, 471
Gastrodia, Mycorrhiza, 681
Gastropoda. See CONTENTS
Gastropods, Cavernicolous, 356
Gates, R. R., Chromosome-reduction in *Enothera*, 370
— Chromosomes of *Enothera* Mutants and Hybrids, 370
Gaupp, E., Composition of the Lower Jaw, 742
— Homology of Mammalian Lacrymal Bone, 192
— Vertebrate Lower Jaw, 612
Geaster, Notes, 237
Gecko, *Hæmoeystidium*, 475
— Kidney, 190
Geddes, A. C., Abnormal Bone-growth in Absence of Functioning Testes, 186
Geheeb, Adalbert, 69, 384
— Moss-flora of the Atlantic Islands, 382
Geibel, W., Alloys of the Noble Metals, 417, 826
Gemmill, J. F., Adaptation of Ordinary Paraffin Baths for Vacuum Embedding, 26

Gemmill, J. F., Aerator suitable for Laboratory Aquaria, 24

— Structure of *Solaster endeca*, 628

Genera, Antarctic, New, 498

Genera, New—

Botany:

Acanthochondria, 75
Aconema, 501
Alina, 242
Allionella, 780
Aneuria, 75
Apiosporina, 82
Araneomyces, 516
Austinella, 780
Barnesia, 68
Bryobesia, 75
Calathelasma, 88
Chalicostroma, 75
Coccochorella, 82
Coccoidella, 516
Colloderma, 90
Clypeolella, 82
Creosphaeria, 242
Cyrtophora, 662
Discodothis, 516
Dothiorellina, 796
Encodiella, 241
Erustiella, 662
Exophyllum, 75
Farysia, 242
Finetaria, 392
Goebeliella, 655
Goplana, 242
Hartiella, 88, 241
Helotiopsis, 241
Hyalodema, 515
Hygrodicranium, 498
Hyophilopsis, 654
Koordersiella, 516
Lichenophoma, 672
Ligniera, 243
Loculistroma, 796
Loranthomyces, 516
Merceyopsis, 66
Mesospora, 75
Metachora, 800
Microporella, 516
Mohortia, 242
Monochytrium, 508
Morinia, 68
Myxasterina, 516
Myxotheca, 395
Neuroloma, 498
Oligochatophora, 386
Oligocladus, 75
Ordonia, 242
Parenglerula, 82
Perinema, 75
Physalosporina, 671
Pirulus, 501
Protolindsaya, 66
Psidania, 242
Relmiellopsis, 86

Genera, New (*Botany*) *cont.*—

Rhepalocystis, 799
 Rhytisiophon, 667
 Seienella, 243
 Schiffermulla, 516
 Scleropyrenis, 672
 Sirosephyella, 211
 Sirothryella, 82
 Solanella, 239
 Sorolepidium, 192
 Squamolithon, 669
 Stenolepia, 491
 Stephanoptera, 71
 Stilbochalara, 395
 Tomenthypnum, 655
 Torrendiella, 799
 Trichcoleopsis, 783
 Trichopellella, 82
 Trichopeltopsis, 516

Zoology :

Abrochtha, 207
 Aglaiella, 355
 Amiella, 622
 Anophrya, 213
 Avitellina, 362
 Batlymyxis, 359
 Bonnevicella, 52
 Bradyscela, 208
 Buddenbroekia, 51
 Cæscirrus, 758
 Calyptopogon, 463
 Ceratopora, 764
 Ceratotrocha, 207
 Chlamydonema, 759
 Cicadomyces, 616
 Colurostylis, 468
 Conocladus, 463
 Cristispira, 58
 Cyclobothrium, 471
 Deontacylix, 295
 Deradena, 205
 Desmocarid, 754
 Dipleuchlanis (sub-g. n.), 363
 Dissotrocha, 207
 Dubosequia, 58
 Embadomonas, 476
 Embata, 207
 Eudentomyzon, 354
 Globarmadillo, 755
 Gymmodiastylis, 468
 Habrotrocha, 207
 Hexapathes, 473
 Hicksonella, 55
 Intoshellina, 213
 Isidoidea, 55
 Iselina, 213
 Kofoidella, 213
 Lagmania, 628
 Madpighiella, 476
 Maupasella, 213
 Merocystis, 771
 Mesopsylla, 43
 Metamblyops, 359
 Midias, 755
 Mniobia, 208
 Murrayona, 365
 Nephthygorgia,
 54
 Nevaya, 360
 Odontalona, 47
 Orrella, 359
 Paracotyle, 760
 Paradinium, 212
 Paramyxa, 634
 Paratebion, 755
 Peltastis, 55
 Perezella, 213
 Peytoia, 629
 Phoronopsis, 50
 Phyllobothroides
 471
 Pleuretra, 207
 Pleurocuris, 469

Genera, New (*Zoology*)—*cont.*

Plumigorgia, 55
 Proidotea, 201
 Pyrophyllia, 210
 Rhizomastix, 632
 Saprospira, 772
 Scapanotrocha, 207, 208
 Selizotrema, 468
 Selultzellina, 213
 Sesarmaxenos, 755
 Sibogella, 365
 Sidneyia, 622
 Stephanoteuthis, 746
 Syndinium, 57
 Synsiphonium, 471
 Sypharoptera, 466
 Tatrasona, 752
 Termitoptoeus, 41
 Timorechinus, 210
 Toddia, 633
 Toxocystis, 213
 Ustilaginiodella, 797
 Withius (sub-g. n.), 359
 Zanelopus, 47
 Genera, New, from Malay Archipelago, 75
 — of Recent Clypeastroids, 472
 Generations, Alternation in Myxomyetes,
 685
 Genital Organs, Male, in Insectivora and
 Lemuridæ, 191
 — Pores in Norway Lobster, 201
 Genus Anthomastus, 54
 — Ceratium, 768
 — New, of Antipatharia, 473
 — — of Chytridiaceæ, 799
 — — of Grass, 793
 — — of Hydroids, 52
 — — of Plasmodiophoraceæ, 243
 — — of Polyblepharidæ, 71
 — — of the Chytridiacea, 508
 Georgi, W., Origin of Notochord Epithe-
 lium, 740
 Geotropism and Phototropism in Fungi, 396
 — in Corymorpha, 211
 Gepp, A. and E. S., Codiaceæ, 389
 — Marine Algae from the Kermadecs, 230
 Geraniaceæ, Fruit, 641
 Gerber, M., Latex Diastases of Brons-
 sonetia, 483
 Gerber P., Spirochæts of the Mouth, 369
 Gering, G., *Malacobdella grossa*, 627
 Germain, L., Cavernicolous Gastropods, 356
 Germination of Fern-spores, Influence of
 Light and Darkness, 491
 Gestation in White Mice, 737
 Ghoreyeb, A. A. W., New and Quick
 Method for Staining Spirochæts in
 Smear Preparations, 265
 Giacomo, A. de, Microchemical Demon-
 stration of Guanin, 258
 Giant-cells of Mole's Placenta, 188
 Gibbs, L. S., New Zealand Hepaticæ, 783
 Gid Parasite, 760

- Giemsa, G., Rapid Staining with Giemsa's Azur-eosin Solution, 414
 Gilchrist, J. D. F., New Hemichorda from South Africa, 50
 Gilruth, J. A., Blood Parasites, 57
 — Hemogregarine in Blood of *Varanus varius*, 57
 — Microfilaria in Magpies, 48
 — Protozoan Parasite from Mucous Membrane of Sheep's Abomasum, 57
 Gineste, C., Polymorphism in Flagellates, 768
 Ginneken, P. J. H. v., Zinc Amalgams, 417
 Giolitti, F., Cementation of Alloy Steels, 713
 — — of Steel, 269
 — Malleable Cast Iron, 559
 Girgolaß, S. S., Compression Experiments with the Fertilized Ovum of *Ascaris megalocephala*, 759
 Glands and Luminescence of Phyllirhõe, 196
 — Brunner's, New kind of Cell, 349
 — Marginal, of Porpita, 474
 — Salivary, of Ticks, 45
 Glaser, E., Selective Action of Dieudonné's Medium, 269
 Glasses, Opacity of Certain, for the Ultra-violet, 700
 Glaue, H., Comparison of *Ascaris felis* and *A. canis*, 205
Glaeosporium Ribis, 510
Gluga lophii, 634
 Glycogen, Fixation and Staining, 821
 Gnetales as Apetalous Angiosperms, 372
 Gobius, Cutaneous Papille, 741
 Goebeliella, a New Genus, 655
 Goerens, P., Gases in Commercial Steel and Iron, 270
 — Transformation-point Curve, 126
 Gola, G., Hepatics of the Atlantic Islands, 782
 Gold and Silver, Alloys of Sodium, 556
 — Plate, Cast and Rolled, Properties, 557
 — Tellurides, 557
 Gold-magnesium Alloys, 123
 Gold-tellurium System, 417
 Goldschmidt, R., Nervous System of *Ascaris*, 470
 Gomont, Maurice Augustin, 390
 Gonads, Development in Frog, 456
 Gonder, R., Parasite of Coast Fever, 770
 Gonidia, Lichen, 399
 — — Culture, 400
Goniomphyllum Buffhami, 668
Gonium pectorale, 501
 Gontermann, W., Iron-silicon-carbon Alloys, 826
 Goodale, H. W., Blastopore Closure in Amphibia, 347
 Goodey, T., Protozoa of the Soil, 767
 Goodrich, E. S., Occipital Region of Urodela, 456
 Gooseberry and Oak Mildew, 392
 Gordon, F. W., Letter in *re* Show-cases, etc., 284
 Gordon, W. T., *Lepidophloios Scottii*, 62
 Gorgonellids of 'Siboga' Expedition, 55
 Gorgonid and Avicula Association, 463
 Gorgonidæ of 'Siboga' Expedition, 55
 Goto, S., Hydractinia and Hermit-crab, 474
 Gough, L. H., Stilesia and its Relatives, 362
 Grain-growth, Nucleus Action, 716
 Grain-size in Iron, 270
 Gramineæ, Mechanism of Movement in, 374
 Granier, J., Heterogamic Gemini in Impatiens, 480
 Granules in Gland Cells, Origin, 349
 "Graphitic" Cast-iron, 559
 Grass, New Genus, 793
 — Snake in the Sea, 37
 Grating, Reflecting, Elliptic Interference, 545
 Gravely, F. H., Degenerate Cockroach, 465
 — Large Egg laid by a Beetle, 718
 — Mosquito sucked by Midge, 750
 Gravier, C., Cirripede and other Commensals of Madreporæ, 624
 — Incubation in Polychæts, 758
 Grayson, H. J., Improvements in Rock-section Cutting Apparatus, 703
 — Method of Slicing, Grinding, and Mounting Rock-sections, 706
 Grayson's New Ten-Band Plate, Measurement, 129, 160
 — Ruling presented by Mr. Conrad Beck to the Royal Microscopical Society, Report on, 421, 449
 Grebes, Development of Limbs, 345
 Greenish, H. G., Microscopical Examination of Foods and Drugs, 121
 Gregarine, Large, in Atyephyra, 772
 Gregoire, V., Unity of Meiotic Process in Plants and Animals, 186
 Greig-Smith, R., Action of Wax-solvents and the Presence of Thermolabile Bacteriotoxins on Soil, 523
 Grenet, L., Quenching of Bronzes, 268
 Grenet, —, Resistance to Passage of Microbes through Collodion Filters, 548
 Griffin, L. E., Division of *Euplotes worcesteri*, 368
 — Structure of *Euplotes*, 368
 Griffiths, W., Principal Starches used as Food, 701
 Griffon, —, *Cladochytrium cæspitis*, 76
 — Thermophilous Moulds, 673
 — and others, Diseases of Plants, 238

- Griggs, R. F., *Monochytrium*, a New Genus of the Chytridiales, 508
- Grimmia, Notes, 654
— *pilosissima*, 226
- Grinding, Slicing, and Mounting Rock-sections, Method, 706
- Grinnell, J., Linnet of Hawaiian Islands, 353
- Groh, H., New Host for Claviceps, 391
- Gross, J., *Cristispira* and *Spirocheta*, 58
— Free-living Spirochaetaceae, 772
- Grouse, Red, Changes of Plumage, 353
- Groul, A. J., North American Bryophytes, 658
- Growth of Seed Plants. See CONTENTS
- Growth-forms, Complex, Inheritance, 347
- Gruvel, A., Classifications of Rock Lobsters, 623
- Grynfeldt, E., Eye of Protopterus, 741
- Guanin, Microchemical Demonstration, 258
- Guéguen, F., *Alopecia areata* of Bacterial Origin, 657
— Rapid Method for Isolating *Oospora lingualis*, 548
- Guercio, G. del, Studies on Injurious Mites, 752
- Guéin-Ganivet, J., Grass Snake in the Sea, 37
- Guerrini, G., Alleged Toxicity of Tape-worms, 626
- Guertler, W., Iron-Nickel Meteorite, 270
— Structure of Galvanized Iron, 713
- Guichard, M., Extraction of Gases from Copper, 712
- Guillaume, C. E., Changes occurring in Nickel Steel, 713
- Guillemín, G., Occluded Gases in Copper Alloys, 418
- Guillet, L., Reheating of Cold-worked Metals, 562
- Guilliermond, A., Copulation of Yeast-cells, 392
— Formation of Chlorolencites, 773
— Mitochondries of Plant-cells, 773
— Nuclear Evolution in Ascomycetes, 508
- Günther, S., History of Study of Coral-formations, 473
- Güthert, T., Oogenesis in Dytiscidæ, 138
- Gut in Healthy Frog, Total Closure, 193
- Guttenberg, A., Study of Synchronium-galls, 76
- Guttural Pouches of Horse, 37
- Guye, P. A., Infinitely Small Chemical Magnitudes, 410
- Guyer, M. F., Accessory Chromosomes in Man, 29
- Gwynne-Vaughan, D. T., Anatomy of the Osmundaceæ, 645
— Fossil Osmundaceæ, 379
- Györfly, I., *Buzbaumia viridis*, 493
- Györfly, I., Distribution of *Molendou Soudthneriana* in Hungary, 66
— Hungarian Mosses, 657
— Mosses attacked by Cladosporium, 653

II

- Habits of Shrew-mole, 352
- Hachli, Y., Selective Action of Dicouloimé's Medium, 260
- Hacklov, L., Sensilli and Eyes of Medicinal Leech, 203
- Hadley, P. B., Coccidiosis in Sparrows and other Wild Birds, 369
- Hæmopoietic Function of Spleen in Embryo Bird, 460
- Hæmatoxylin, Staining in Bulk, 118
- Hæmatozoa from the Congo, 214
— of Australian Batrachians, 633
— — — Birds, 369
— — — Reptiles, 771
— Studies, 633
- Hæmoecystidium of the Gecko, 475
- Hæmogregarina stepanovi*, Life-history, 771
- Hæmogregarine in Blood of *Varanus varus*, 57
— New, from Horned Asp, 477
- Hæmogregarines, 214
- Hæmpel, O., Growth of *Salmo hucho*, 38
- Hagem, O., Norwegian Mucorini, II, 507
- Hagemann, J., Study of Corixa, 199
- Hagen, J., Annulus of *Cyrodontium alpestre*, 66
— Diceranuloma, 66
- Hague, A., Bearing Metals, 268
— Influence of Silicon on Cast Iron, 272
- Hague, S. M., Morphology of *Diospyros*, 640
- Hair, Different kinds, 742
- Halbert, J. N., Fresh-water Mites of Clare Island, 621
- Halecium, Mediterranean Species, 474
- Halicondrina, Classification, 765
- Hall, C. M., Gid Parasite, 760
- Hall, J. G., Diseases of Economic Plants, 84
- Hall, M. C., Method of Examining Fæces for Evidences of Parasitism, 554
- Hallez, P., Excretory System of Bothriomolus, 471
— Non-parasitic Bdellourid, 471
— Two-fold Function of Ovaries in some Polyelads, 761
- Halesphæra and Flagellatæ, 660
- Hamelin, A., Collodion Filters, 548
- Hamerton, A. E., Inquiry into Sleeping Sickness, 476
— Tabanids and Trypanosomes, 749
- Handlirsch, A., New Paleozoic Insects, 466
- Hanitsch, P., Development of *Cunina parasitica*, 764

- Hannig, E., Significance of the Periplasmedium, 481, 488
- Haplosporidian Parasite in *Donax*, 772
- Harden, A., Alcoholic Ferment of Yeast-juice, 672
- Hardening Carbon Steels, Theory, 271
- of Carbon and Low-tungsten Tool-steels, 271
- Harder, R., Cultures of Mixed Fungi, 791
- Harding, W. A., New Leech from Egypt, 470
- Hardness, Measurement, 274
- Hardy, A. D., Myxonema in Salmon Disease, 663
- Red Euglena, 662
- Harris, Carolyn Wilson, 90
- Hartmann, M., New Trichonympha, 477
- Hartwell, H. F., Bacillus of Acne, 262
- Hatano, S., Combined Staining Methods for Tubercle bacilli, 118
- Hatfield, W. H., Cast-iron and Vanadium, 827
- Precipitation of Free Carbon in the Iron-carbon System, 559
- Hauswaldt, H., Interference Phenomena in Polarized Light, 105
- Hawkins, H. L., Teeth and Buccal Structures in *Comulus*, 209
- Hayden, A., Algal Flora of the Missouri Botanical Garden, 230
- Häyren, E., Culture of Lichen Gonidia, 400
- Saprophytism of Enteromorpha, 231
- Head in *Hypogeophis*, Development, 457
- Head-glands of Caddis-worms, 44
- Head-pieces, Short, of Planaria, Regeneration, 363
- Heart, Beating of, in Hibernating Snail, 462
- Innervation, in Reptiles and Batrachians, 458
- of Fishes, Distribution of Muscle-fibres, 741
- of Larval Dragon-fly, Histological Study of the Innervation, 750
- of Lungless Urodela, 460
- Heat-treatment of Bronze, 124
- Heath, C. E., Fluid Mounting, 551
- Microscope Lamp, 128, 255
- Heating Apparatus, Electric, for Microscopical Observations, 100
- Hebb, R. G., Resignation, 131
- Hefford, A. E., Teleostean Ova and Larvæ, 35
- Hegt, J. N., New Nematode, 759
- Heile, —, Bacteriology of Appendicitis, 91
- Heinen, A., Nephthyidae and Lycopodiæ of North Sea and the Baltic, 624
- Heinis, F., Moss-fauna of Central America, 615
- Heliczoon, Marine, Notes, 475
- Helix pomatia*, Alimentary Canal, 717
- Hellemans, J., *Strongylus pingucicola*, 205
- Heloderma, Bite, 714
- Helvella crispa*, 508
- Hemenway, A. F., Phloem of Juglandaceæ, 480
- Hemichorda, New, from South Africa, 50
- Hemigramma latifolia*, 777
- Hemiptera, Buccal Apparatus, 750
- Hempel, J., Effect of Etherization on Metabolism, 776
- Henckel, A., Black Sea Algae, 387
- Phytoplankton of the Caspian Sea, 71
- Henneke, J., Structure and Habits of *Macrobiotus macronyx*, 622
- Henry, A., Ascarids of Carnivores, 361
- Hens, Injection of Testis-extract, 348
- Hepatic Genera, Figures, 226
- Hepaticæ, European, 381, 493
- Infected by Fungi, 492
- Inter-relationships, 64
- New England, 67
- — Zealand, 783
- of New Caledonia, 383
- of Puerto Rico, 783
- of the Bahama Islands, 783
- Pflidioid, Amphigastrical Antheridia, 224
- Spermatogenesis, 652
- Hepaticarum, Species, 227
- Hepatics, Brazilian, 497
- Leafy, Fungi in the Rhizoids, 513
- North American, 782
- of the Atlantic Islands, 782
- Herdman, W. A., Scotch and Irish Plankton, 355
- Summer Plankton of West of Scotland and Irish Sea, 614
- Heredity and Evolution, 453
- Hereros and Hottentots, *Plica semilunaris*, 612
- Hermaphroditism in Nemerteans, 206
- Hermit-crab and Hydractinia, 474
- Heron-Allen, E., 426
- The Recent and Fossil Foraminifera of the Shore-sands of Selsey Bill, Sussex; VII. Supplement (*Addenda et Corrigenda*), 277, 298; VIII. Tabular list of Species and Localities, 436
- Studies on British Foraminifera, 366
- Heronimus, C., Development of Pectoral Fin in *Amia*, 607
- Hérouard, E., Fixation of *Seyphistoma*, 473
- Herpetomounds from Dung-flies, 57
- Herre, A. W. C. T., Desert Lichens, 519
- Lichen Flora of Santa Cruz Peninsula, California, 518
- Herring's Eggs, Retarding Development, 739
- Herter, W., German Fungus-flora, 395
- Hertwig, O., Influence of Radium Rays on Ova and Sperms, 185
- Herzog, G., Drop-bottle for Preventing the Action of Air on Copper-oxide-ammonia Solution, 121

- Herzog, T., Adalbert Geheeb, 381
 — *Grimmia pilosissima*, 226
 — Moss-flora of Bernina, 657
 — of Bolivia, 68
 — Mosses of Ceylon, 382
 — Parallelism and Convergence of Moss-pedigrees, 65
 — Wollhya, a Genus of Bryaceæ, 654
 Hess, C., Sense of Light in Animals, 355
 Heterocuma, 16
 Heterogamic Gemini in Impatiens, 480
Hevea brasiliensis, Physiology and Pathology, 795
 Hevesy, G. v., Metallic Fog in Fused Salts, 828
 Hewitt, G. G., Fungus of House-fly, 234
 Hewlett, R. T., Sour Milk, 404
 Hexactinellid Spicules, 212
 Hexactinina from New South Wales, 629
 Heydrich, F., Lithothamnium from Roscoff in Brittany, 669
 Heyn, E., Heat-treatment of Bronze, 124
 — Stresses in Cold-worked Metals, 562
 Hieken, C. M., Ferns of Argentina, 223
 Hickson, S. J., New Octoradiata Coral, 210
 — New Type of Alcyonarian, 764
 — Origin of Sex, 454
 Hida, S., Structure of *Filaria bancrofti*, 759
 Hieronymus, G., African Ferns, 779
 — Ferns of German Central Africa, 223
 Higgins, —, A New System of Filing Slides, 129
 Hilger, A., Microspectroscope, 256
 Hill, E. J., and others, Ferns of North America, 222
 — — North American Pteridophytes, 649
 Hillier, L., Moss-flora of the Jura, 494
 Hillmann, A., "Hypanth" of the Rosaceæ, 640
 Hilpert, S., Magnetic Properties of Nickel Steels, 827
 — — of the Modifications of Iron, 270
 — Sulphurous Acid as an Etching Medium, 273
 Hiltzheimer, M., Atavism, 191
 Himoff, M., Improved Micrometer, 408
 Hipple, H., Plug Micrometer, 256
 Hirschfelder, G., Histology of Rotifera, 362
 — Methods of Studying Rotifera, 110
 Hirschler, J., Interstitial Tissue of Striped Muscle, 35
 Hirst, S., New Termitophilous Millipede, 621
 Histological Technique, New Methods, 549
 Histology of Vertebrata. *See* CONTENTS
 Hive-bee, Colour-sense, 40
 — Junction of Fore-gut and Mid-gut, 197
 Höhnel, F. v., Mycological Notes, 82
 — Notes on Mycology, 516
 Hönig, J., Neurochords of Crinoidus, 202
 Hoffmann, E. J., Fruitification of Macro-cystis, 504
 Hofherr, O., Relative Immunity of Birds to Anthrax, 37
 Hollande, A. C., Blood of Insects, 616
 Holloway, J. E., Anatomy of New Zealand Lycopodiaceæ, 62
 Holothurians, Middle Cambrian, 628
 — Studies, 209
 Holothuroids from the Indian Ocean, 209
 — West Indian, 209
 Holste, G., Nervous System of *Dytiscus marginalis*, 41
 Honcamp, F., and another, Study of Smut-infection, 235
 Honigmann, H., Plankton of Prester See, 789
 Hooper, D., Secretion of Ghost Bug, 358
 Hopkinson, J., Scheme to encroach upon the space allotted in 1899 to the Natural History Museum at South Kensington, 425, 426
 Horejsi, J., Symbiotic Alga, 233
 Hori, S., *Bacillus cypripedii*, 802
 — Do the Higher Fungi require Lime? 82
 Hornbill, Digestive System, 612
 Horne, A. S., *Spongopora subterranea*, 401
 Horse, Blood Filaria, 470
 — Guttural Pouches, 37
 Horses, Parasites of Biliary Fever, 369
 Horwood, A. R., Calamites compared with Equisetum, 62
 — Layers of the Molluscan Shell, 746
 Hottentots and Hereros, *Plicia semilunaris*, 612
 House-fly, Fungus, 234
 — Leptomonad, 633
 — Protozoa in Alimentary Canal, 634
 Houston, A. C., and others, Disease-carriers, 93
 Houston, R. A., Efficiency of Metallic Filament Lamps, 408
 Howard, W. T., Nuclear Budding in Tumour-cells, 458
 Howe, H. M., Nucleus Action and Grain-growth, 716
 Howe, R. H., Northern Species of Alce-toria in America, 683
 — Usnea and its Linnaean Nomenclature, 242
 Hoyle, W. E., Genera of Dibranchiate Cephalopoda, 196
 Hudson, O. F., Heat-treatment of Brass, 417
 Hue, A., Crocynia, a Genus of Lichens, 519
 Hufnagel, A., Fatty Body during Metamorphosis, 618
 Humble-bees, Species and Varieties, 197
 Hurwitz, S. H., Reactions of Earthworms to Acids, 48
 Husnot, T., E. G. Paris: Obituary, 659
 — F. Renauld's Moss-herbarium, 497

- Hustedt, F., Diatoms from Dahomey, 74
Hybanthus concolor, Embryo-sac Development, 218
 Hybridization, Echinoderm, 363
 Hybrids of American and European Bison, Fertility, 455
 — of Goldfinch and Canary, State of Ovary, 155
 Hydrachnids of East African Lakes, 200
 Hydractinia and Hermit-crab, 474
 Hydrogen, Occlusion by Palladium-gold Alloys, 557
 Hydroid on Crab, Epizoic, 765
 Hydroïdes, Development of Trochophore, 360
 Hydroids, Deep-sea, of Indian Museum, 52
 — New Genus, 52
 — of Drobak, 365
 — Senescence, 211
 Hydrozoa, History of the Study, 210
 Hygramblystegium and Cratoneuron, 493
Hypoglypium ochraceum, 493
 Hygrophorus, Monograph, 81
 Hymenophyllaceæ in Relation to Moisture, 487
 Hypophilopsis, a New Indian Moss-genus, 654
 "Hypanth" of the Rosaceæ, 640
 Hypomyces, 673
 — Classification, 673
 — New, 393
 — North American, Studies, 510
 — Studies, 79, 793
Hypocrea rufa, 670
 Hypocreaeæ, Notes, 790
 Hypogeophis, Development of Head, 457
 Hypophysis, Pigmentation of Nervous Lobe, 459
 Hypophysis-secretion, Path, 610

I

- Ibla, Development and Minute Structure of Scalpellum, 755
 Ichthyological Notes, 746
 Idiochromosomes in *Asecaris*, 204
 Idoteid, Fossil, 201
 Ignatowsky, W. v., History of the Cardioïd Condenser: Memorandum on the Leitz Mirror Condenser, 693
 Ibsen, G., *Fusarium nivale* and *Nectria graminicola*, 78
 Iijin, N., Iron-carbon System, 826
 Illuminating and other Apparatus. *See* CONTENTS
 Illumination of Objects observed with the Binocular Microscope, Improvement in, 96
 Illuminator, Dark-ground, designed by E. M. Nelson, 276
 — — with Arrangement for Centring on a Plain Stage, Reicher's, 426, 814
 Imbedding Objects. *See* CONTENTS
 Immunity, Natural, of White Mice to *Trypanosoma lewisi*, 459
 Impatiens, Heterogamic Gemini, 480
 Incertæ Sedis. *See* CONTENTS
 Incubation in Polychæts, 758
 Inflorescence of *Funaria*, 492
 — of Muscinæ, 799
 Influence of Light and Darkness on Germination of Fern-spores, 491
 Influenza Bacillus and Ducrey's Bacillus, Cultivation Medium, 549
 Infusorians, Astomatous, 213
 — Ciliated, Fat, 212
 Ingham, W., and others, British Mosses, 228
 Inheritance in Hybrid Poultry, 34
 — of Colour-pattern in Hybrid Poultry, 34
 — of Complex Growth-forms, 347
 — of Skin-pigmentation in Man, 30
 Injecting Objects. *See* CONTENTS
 Injection of Fusible Alloys in Microscopical Anatomy, 822
 — Preparations of Petromyzon, 263
 Injury to the Cotyledons, Effect on Seedling Development, 60
 Innervation of the Heart of Larval Dragonfly, Histological Study, 750
 Inouye, K., Physico-chemical Studies of Lead, 417
 Insect Remains from South Wales Coalfield, 620
 Insecta. *See* CONTENTS
 Insectivora and Lemuridae, Male Genital Organs, 191
 Insects and Yeasts, Symbiosis, 616
 — as Disseminators of Ergot, 463
 — as Fungus-carriers, 515
 — Blood, 616
 — in *Nepenthes* Pitchers, 42
 — Injurious, 466
 — — Studies, 747
 — — in Ireland, 44
 — Leitz's Photomicrographic Apparatus for Photographing, 543
 — Minute Structure of Cuticle, 747
 — New Palæozoic, 466
 — of the Rhine, 197
 Instruments, Accessories, etc. *See* CONTENTS
 Interference Phenomena in Polarized Light, 105
 Interferometer, 539, 565
 Intestinal Flora, 94
 — — Studies, 687
 Intestine of Trichoptera, Protist Parasites, 57
 Invertebrata. *See* CONTENTS
 Iodine Staining, Improved Method, 551
 Iraklionoff, P., Peroxydase and Respiratory Pigments, 638
 Iris, Objective Mount with, 283

- Iris-pigment, Migration in Compound Eye, 616
- Iron and Steel, Commercial, Gases in, 270
- — — Influence of Vanadium on, 827
- Cast, Influence of Silicon, 272, 826
- — Manganese in, 272
- Galvanized, Structure, 713
- Grain-size, 270
- Influence of Impurities on the Corrosion, 828
- Liberation by Green, Water-plants, 484
- Magnetic Properties of Modifications, 270
- Meteoric, Synthesis, 559
- Ovitak, 713
- Sulphide-iron System, 126
- White Cast, Crystallization, 712
- Iron-antimony alloys, 558
- Iron-carbon Alloys, 125
- System, 558, 826
- — Crystallography, 125
- — Influence of Sulphur, 418
- — Precipitation of Free Carbon, 559
- Iron-haematoxylin Method, Staining Celluloid Sections of Nervous Tissue, 119
- Iron-nickel Meteorite, 270
- System, 126
- Iron-nickel-copper Alloys, 127
- Iron-silicon-carbon Alloys, 826
- Irritability of Seed Plants. *See* CONTENTS
- Ischnocolus, Development, 621
- Isidae of 'Siboga' Expedition, 55
- Isopod, New Parasitic, 755
- Spiny Terrestrial, 755
- Israel, W., Notes on Fresh-water Mussels, 162
- Issakowitsch, A., Marginal Glands of Porpita, 474
- Ithyphallus and Dictyophora, 237
- *impudicus* and *Mitinus caninus*, Study, 512
- Iwanoff, E., Fertility of Hybrids of American and European Bison, 455
- Ixolidae, New, 44
- J**
- Jacobi, H., Effect of Injury to the Cotyledons upon Seedling development, 60
- Jacobsohn, L., Grouping of Nerve-cells in Spinal Cord of Tench, 610
- Jacobowa, L., New South African Polychelid, 59
- Jaczewski, A. de., Geotropism and Phototropism in Fungi, 396
- Jahn, E., Studies in Myxomycetes, 684
- Janczewski, E., *Gleosporium Ribis*, 510
- Jänecke, E., Flow-pressure of Tin, 557
- Ternary Systems, 269, 561
- Jaw, Lower, Composition, 732
- Vertebrate Lower, 612
- Jenzen, P., Moss-flora of Eisenach, 67
- Jannel, R., Revision of Bathysciinæ, 620
- Jeffrey, E. C., Investigating Nature of Supposed Algal Coals, 262
- Pteridophytal Origin of so-called Algal Coals, 221
- Pteropsida, 378
- Jennings, H. S., Conjugation in Paramoecium, 634
- Jennings, O. E., and others, North American Bryophyta, 68
- Jensen, H., Insects in Nepenthes Pitchers, 42
- Jensen, O., Bacteriological Studies of Danish Butter, 689
- Jensen, P. B., Animal Life of Sea-bottom, 741
- Jentsch, F., Electric Heating Apparatus for Microscopical Observations, 100
- Jentsch's Concentric Condenser, 98
- Ultra-Condenser, 97
- Jerboa, New Flea, 43
- Jöhne's Bacillus, 94
- Jørgensen, E., Genus Ceratium, 768, 789
- Johannson, L., Extra-enteric Aperture in a Leech, 361
- Johnson, F., Effect of Silver, Bismuth and Aluminium on Copper, 418
- Impurities in Copper, 125
- Johnson, T., Archæopteris, 647
- Lyginodendron (*Crossothea*) in Irish Coal Measures, 646
- Johnston, E. A., New Species of Linguatula, 359
- Johnston, J., Influence of Pressure on the Melting-points of Metals, 563
- Johnston, J. R., *Bacillus coli* and Plant-diseases, 804
- Johnston, T. H., Entozoa in Australian Birds, 760
- Hæmatozoa of Australian Birds, 369
- — — Reptiles, 771
- Pentastomes in Australian Cattle, 623
- Structure of *Monopygidium passerinum*, 626
- Worm-nests in Australian Cattle, 626
- Johnstone, J., Parasites from Irish Sea Fishes, 49
- — of Fishes, 760
- Joisten, A., Grain-size in Iron, 270
- Jolibois, P., Arsenides of Tin, 825
- Jolly, J., Function of Bursa Fabricii, 460
- Hæmopoietic Function of Spleen in Embryo Bird, 460
- Involution of Bursa Fabricii, 458
- Mitotic Figures in Isolated Tissues, 319
- Survival of Isolated Leucocytes, 611
- Jong, D. A. de, Relation between Avian and Mammalian Tuberculosis, 93
- Jongmans, W., *Calamites undulatus*, 489
- Jonnescq, V., Histological Changes in Infantile Paralysis, 258
- Jørgensen, A., Micro-organisms and Fermentation, 396

- Jørgensen, M., Ovarian Ovum of *Protens*, 456
- Joyner, R. A., Amalgams containing Silver and Tin, 557
- Juday, C., Biological Stations, 38
- Juel, O., Structure of *Riccia Bischoffii*, 225
Juglandaceae. Phloem, 480
- Juillet, A., Air-sacs in Birds, 613
- Injection of Fusible Alloys in Microscopical Anatomy, 822
- Juncaceae, Parasites on Roots, 99
- Parasitic Root-diseases, 670
- Junge, P., Ferns of Schleswig-Holstein, 649
- Pteridophytes of Schleswig-Holstein, 778
- Jusbaschjanz, S., Post-embryonic Development of *Stratiomyidae*, 199
- K
- Kaalaas, B., and another, British Bryophyta, 381
- Kaiser, G. B., and others, Bryophyta of North America, 496
- Kaiser, P. E., Algological Notes, 503
- Kaiserling Material, Preparation for Microscopical Purposes, 703
- Kajanus, B., Morphology of Lichens, 801
- Systematic Position of *Stereocaulon*, 519
- Kamm-plankton, 789
- Kantor, J. L., and another, Poisoning by Fungi, 677
- Kapzov, S., Minute Structure of Cuticle in Insects, 747
- Kasnowsky, V., *Aphanomyces laevis*, 669
- Kaudern, W., Male Genital Organs in Insectivora and Lemuridae, 191
- Kaufmann, F., German Cortinariii, 81
- Kawamura, S., Phosphorescence of *Pleurotus japonicus*, 512
- Keiller, V. H., Regeneration in Short Head-pieces of *Planaria*, 761
- Structure of *Pentaceros reticulatus*, 364
- Keissler, H. v., Periodicity of Phytoplankton of the Leopoldstein Lake, 660
- Phytoplankton of the Zeller See, 388
- Plankton from the Julisee-Alps, 388
- Keiszlcr, K. v., Parasitic Lichen-fungi, 672
- Kemp, S., Photophores of Decapod Crustacea, 45
- Kennel, P., Corpora Aliposa of Amphibians, 613
- — of Frog, 744
- Keroëididae, 364
- Kew, H. W., False Scorpions of British Isles, 359
- Pseudoscorpiones of Clare Island, 621
- Kidney, Mammalian, Epithelial Cells, 609
- of Gecko, 190
- Kilston, R., Fossil Osmundaceae, 379
- Kieffer, J. J., East Indian Chironomidae, 463
- Kimball, L. F., American Ferns, 778
- Kindberg, Nils Conrad, 384
- Kingsley, M. A., Splitting of Rhizome and Root of *Delphinium*, 774
- Kinoshita, K., Keroëididae, 364
- New Genus of Antipatharia, 473
- Kirehoffer, O., Eye of *Dermestes*, 41
- Kirkpatrick, R., Hexactinellid Spicules, 212
- Merlia, 639
- New Lithonine Sponge from Christmas Island, 631
- Remarkable Pharetronid Sponge, 365
- Kirner, J., Influence of Nitrogen on Cementation of Steel, 558
- Kleine, F. K., Trypanosome Studies, 476
- Knauer, K., Ventral Musculature of Fishes, 194
- Knief, Hans, Development of Basidia, 794
- Knives, Microtome, 703
- Kobayashi, M., Tellurium Alloys, 416
- Köck, G., Mildew of Gooseberry and Oak, 392
- Köhler, A., Application of Mercury Light to Microscopical Works, 253
- New Nernst Lamp for Microprojection, 808
- Koehler, R., New Starfishes, 210
- Köhler, W., *Pectinatella magnifica* near Berlin, 763
- Koenigsberger, J., Leiss' Universal Spectral Apparatus, 694
- Methods for the Identification of Sub-microscopic Structures, 810
- Koenigsfeld, H., Penetration of the Normal Skin by Tubercle Bacilli, 803
- Kofoid, C. A., Ceratocaryns, 72
- New Dinoflagellates, 769
- Kogia breviceps*, Head, 351
- — Spermaceti-organ, 37
- Kohn, A., Pigment in the Human Neurohypophysis, 190
- Koidzumi, M., Frog Trypanosomes in Japan, 632
- Kolkwitz, R., Kammerplankton, 789
- Kolmer, W., Eye of *Pteropus*, 189
- Supporting Elements in Sensory Epithelium, 189
- Kopsch, F., Early Development of Trout, 607
- Kostanecki, K., Artificial Parthenogenesis in *Maetra*, 615
- Koumiss, Micro-organisms, 92
- Kowallik, G., Staining Bordered Pits, 709
- Krahmer, B., Moss-flora of South Thuringia, 67
- Krauss, H. A., Monograph on Embiidae, 465
- Krönke, O., "Graphitic" Cast-iron, 559
- Krogh, M. v., New Method of Chromatin Staining, 414

- Kroll, A., Crystallography of the Iron-carbon System, 125
- Krumphaar, W., Behaviour of Copper towards Gases, 268
- Krumwiede, C., Cultivation of Human and Bovine Tubercle Bacilli, 107
- Kubart, B., Spores of Spenceites, 617
- Kühn, A., Structure and Affinities of Thyrocyphus, 630
- Kühnemann, G., Capsule-formation of Typhoid Bacilli, 525
- Kükenthal, W., Genus Anthomastus, 54
— Pennatulacea, 765
— West Australian Alcyonarians, 54
- Künckel d'Herculeis, J., Habits of *Scutigera coleoptrata*, 752
- Kufferath, H., Growth of *Bacterium Zoppii*, 805
- Kuhn, Ph., Dissemination of Disease by *Stomoxys calcitrans*, 463
- Kumakow, N., and others, Silver-copper Alloys, 124
- Kundt, A., Spore-development in *Salvinia natans*, 490
- Kunkel, B. W., Development of Turtle Skull, 605
- Kuntz, A., Development of Sympathetic Nervous System in Birds, 32
— — — — — in Mammals, 31
— Sympathetic Nervous System in Fishes, 606
— — — — — in Turtles, 605
- Kurssanow, L., Sexuality of Uredinæ, 792
- Kusano, S., Mycorhiza of Gastrodia, 681
- Kuschakewitsch, S., Development of Gonads in Frog, 456
- Kylin, H., Algæ of the West Coast of Norway, 506
— Phycocerythrin and Phycocyanin, 784
- L
- Laboulbeniales, Study, 790
- Lachrymal Bone, Mammalian, Homology, 192
- Lacouture, C., Figures of Hepatic Genera, 226
- Lactation, Alleged, of Male *Lepus bairdii*, 737
- Lactic Ferments, Resistance of *Micrococcus melitensis*, 403
- Lafar, F., Technical Mycology, 83
- Lagarde, J., *Plicaria Planchonis* Bond., 670
- Lakon, G., Starch-grains and Oil-drops in Conifer-wood, 638
- Lamellibranchiata. See CONTENTS
- Laminaria hyperborea*, 74
- Laminariaceæ, Medulla-cells, 501
- Laminarie, Epiphytes, 386
- Lamp, Microscope, 128
— Microscopic, Emrys-Roberts, 698
- Lamp, Microscopical New, 571
— New Microscope, 255
— New Nernst, for Microprojection, 808
— — — Zeiss Nernst, 810
- Lamprey, Muscles, 611
- Lampreys, Synopsis, 354
- Lamps, Arc, for Projection, 96
— Metallic Filament, Efficiency, 468
- Lampridæ, Photogenic Organs, 464
- Land, W. J. G., American Lepidostrobos, 647
- Lang, A. B., Beating of the Heart in Hibernating Snail, 462
- Lang, G., Influence of Manganese on Mild Steel, 558
- Lange, —, Agglutination of Trypanosomes, 824
- Lange, E. F., Crystallization of Steel, 828
- Langerhans, Islands of, in Human Embryo, 31
- Langeron, M., Mounting Arthropoda in Amann's Chloralphenol, 416
- Lankesteria, 477
- Larva of Mantispa, 465
- Larvæ and Fish-eggs, Physiology, 738
— Blow-fly, and Gravity, 198
— Experiments with Dragon-fly, 750
— Mosquito, Carnivorous, 358
— Muscid, Metamorphosis of Intestinal Musculature, 42
- Larval Stages of Decapods, 468
- Latter, O. H., Demonstrating Presence of Starch in a Leaf, 263
- Lauby, A., Study of Diatoms in Sedimentary Deposits, 385
- Laurent, J., Physical Conditions of Resistance of the Vine against Mildew, 395
- Lauterborn, R., Vegetation of Upper Rhine, 789
- Layeran, A., Classification of Trypanosomes in Mammals, 632
— Hæmogregarines, 214
— Leucocytozoon in Fish-Eagle, 477
— New Hæmogregarine from the Horned Asp, 477
- Lavison, I. de R., Absorption by Plants of Alkaline Earth Salts, 218
— Mineral Nutrition of Vascular Plants, 482
- Law, E. F., Some Studies of Welds, 714
- Lawson, A. A., Synopsis of the Nucleus, 478
- Lea, A. M., Beetles in Ants' Nests, 42
— New Stag-Beetles, 748
- Lead, Cadmium and Bismuth Alloys, 417
— Physico-chemical Studies, 417
— Tin and Antimony, Ternary Alloys, 556
- Lead-tin Alloys, 711
- Leaf, Demonstrating Presence of Starch, 263
- Leaf-border, Variable, in Fissidens, 492
- Leaf-fall, Opinions upon Physiology, 776

- Leaf-scars, Some Mesozoic Ferns and their, 647
- Leaf-spots of Currant, 795
- Leaf-symmetry and Exotrophy, 639
- Leaf-trace, Filicinæan, Evolution, 376
- Leaves of Calamites, 488
- Primary, Observations, 215
- Lebedeff, W., *Trypanosoma rotatorium*, 476
- Lebœuf, A., Hæmatozoa from the Congo, 214
- Lechmere, A. E., Notes on Saprolegnia, 234
- Ledeft, S., Snake-poison and Yolk of Egg, 613
- Ledoux-Lebard, R., Myxomycetes from the Neighbourhood of Paris, 801
- Leduc, S., Osmotic Growths, 191
- Lee, A. E., Reduction in the Spermatogenesis of the Snail, 462
- Leech and Earthworms, Nerve-cells, 624
- Extra-enteric Aperture, 361
- Medicinal, Sensilli and Eyes, 203
- New, from Egypt, 470
- Left- and Right-handedness, 192
- Legendre, R., Physiology of Sleep, 459
- Legendres, R., Rapid Method of Identifying *Bacillus coli*, 109
- Leger, A., Trypanosome and Leptomonad in *Drosophila*, 368
- Léger, L., Muddy Taste in Fresh-water Fishes, 37
- Leger, M., Microfilariae in Tonkin Birds, 361
- Selenocoeidium and the Relationships of the Sporozoa, 213
- Species of Leucoctozoon, 368
- Spirochaet from the Rabbit, 369
- Studies on Trypanosomes, 213
- Trypanosomes in Fresh-water Fishes, 632
- Le Gris, —, "Filiations" of Metallic Alloys, 715
- Simplification in Technique of Metallography, 562
- Lehmann, N., Influence of Weather Conditions on Frequency of Warbles, 749
- Occurrence of Ox-warbles, 619
- Leininger, H., Study of Fungi imperfecti, 509
- Leishmania tropica*, Culture on Solid Media, 549
- Leiss' Universal Spectral Apparatus, 694
- Leitz' Liliput Arc-lamp, 699
- New Large Photomicrographic Apparatus, 541
- Photomicrographic Apparatus for Photographing Insects, 513
- Small Photomicrographic Apparatus, 540
- Leitz, E., Microtome Knives, 703
- Lelièvre, A., Ileal Cæcum of Birds, 192
- Method for Studying Osseous Tissue, 551
- Lelièvre, A., Red Blood Corpuscles of Mammals, 609
- Tendons of Wing and Leg in Bats, 609
- Union of Muscle-fibre and Tendinous fibre, 458
- Lemmermann, E., African Fresh-water Algæ, 230
- Plaukton-algæ, 71
- Lemoine, —, Classification of Melobesiæ, 505
- Melobesiæ, 505
- Lemuridæ and Insectivora, Male Genital Organs, 191
- Lenartowicz, J. T., New Method of Demonstrating *Spirochaeta pallida*, 118
- Lenderfeld, R. v., Observations on the Technical Execution and Biological Realization of Microscopical Measurements, 700
- Leon, N., Roumanian Mosquitos, 463
- Leotia, Assocarp, 234
- Lepeschkin, W. W., Chemical Composition of the Plasma-membrane, 636
- Structure of Protoplasm, 636
- Lepidodendron brownii*, 488
- Lepidophlois Scotti*, 62
- Lepidoptera, Acephalous, 464
- Spermatogenesis, 43
- Lepidosiren, Spermatogenesis, 608
- Lepidosirenidæ, Fossil, 460
- Lepidostrobos, American, 647
- *Bertrandi*, 62
- Lepisma, Brain, 199
- Lepra Bacillus of Man, Method of Isolating and Growing, 107
- Leprosy Bacillus, Cultivation, 526
- Leptocheirus, Genus, 754
- Leptomonad and Trypanosome in *Drosophila*, 368
- in Euphorbias, 367
- of the House-fly, 633
- Lesne, P., Nutritive Habits of Bostrychidæ, 620
- Lesquereuxia, 492
- Leucobryum glaucum*, 780
- Leucocytes, Distinguishing Dead from Living, 117
- Elimination by, 195
- Endothelial Genesis, 188
- in Brown Rat, Parasites, 633
- Isolated, Survival, 611
- Leucoctozoon in Fish-Eagle, 477
- Species, 368
- Levaditi, C., Cilium of *Treponema pallidum*, 633
- Trypanotoxin of *Bacillus subtilis*, 522
- Levy, D. M., Malleable Castings, 827
- Lewin, K. R., Experiments on Paramœcium, 366
- Lewis, F. J., Moss-remains in Scottish Peat, 381
- Lewis, M., Development of the Spores in *Plourage zygospora*, 671

- Lewis, R. T., Larva of Mantispa, 465
 Lewitzky, G., Chondriosomes in Plant-cells, 479
 Lichen, American, Notes, 519
 — Flora of Santa Cruz Peninsula, California, 518
 — Gonidia, 399
 — — Culture, 400
 Lichen-fungi, Parasitic, 672
 Lichens, Desert, 519
 — in Italy, 801
 — Lancashire, New, 243
 — Morphology, 801
 — Nature and Classification, 801
 — Nutrition, 518
 — Siliceous, Relation to the Substratum, 683
 — West of Ireland, 800
 — See CONTENTS
 Liesching, T., Influence of Sulphur on the Iron carbon System, 418
 Liesegang, R. E., Method of Preserving Brain Sections, 552
 Light, Coloured, Effect on *Stichococcus bacillaris*, 387
 — Mercury, Application to Microscopical Works, 253
 — Model of the Vibration-planes in Polarizing Apparatus, 698
 — on Algae, Effect, 785
 — Polarized, Interference Phenomena, 105
 — Reactions of Amœba, 366
 — Sense of, in Animals, 355
 — Transmission through Transparent Inactive Crystal Plates, with Special Reference to Observations in Convergent Polarized Light, 409
 Lights, White and Coloured, Behaviour of Chlorella in, 385
 Lignier, O., Gnœtales as Apetalous Angiosperms, 372
 Limbs, Development in *Salamaudrella Kayserlingii*, 35
 — in Grebes, Development, 345
 — of Chick, Interchange by Transplantation, 738
 — Supernumerary, Production in Amphibians, 187
 Linnœcida, Notes on Structure and Budding, 629
 Lingelsheim, A., Notes on the Larger Fungi, 236
 Lingnatula, New Species, 359
 Linnet of Hawaiian Islands, 353
 Linnossier, G., Influence of Iron on the Formation of Spores in *Aspergillus niger*, 79
 Linton, E., Flesh-parasites of Food-fishes, 206
 — New Commensal Turbellarian, 206
 — Trematodes from Tortugas, 205
 Lipska, I., Effect of Inanition on Paramœcium, 366
 Lissitzky, E., Production of Supernumerary Limbs in Amphibians, 187
 Lister, G., Colloderma a New Genus of Mycetozoa, 90
 Litardiere, R. de, *Asplenium guichardii*, 618
 — Fern-flora of Spain and Portugal, 222
 — New Hybrid Asplenium, 63
 Lithium Alloys, 123
Lithophyllum fasciculatum, 506
 Lithothamnium from Roscoff in Brittany, 669
 Liverworts and Mosses, British, 227
 — British, Introduction, 228
 Livon, C., Pigmentation of the Nervous Lobe of the Hypophysis, 459
 Lloyd, C. G., Mycological Notes, 677, 795
 — Notes on Myxomycetes, 802
 — — on the Larger Fungi, 83
 Lobster, Abnormal Cheliped, 46
 — Norway, Genital Pores, 201
 Lobsters, Rock, Classification, 623
 Locomotion in *Surirella*, 384
 — in *Surirella elegans*, 133
 Loebe, R., Ternary Alloys of Lead, Tin and Antimony, 556
 Lönning, E., Pelvic Bones of some Cetacea, 459
 Loeske, L., Lesquereuxia, 492
 — Tomenthypnum, a new genus, 655
 Lœwenthal, N., Thread-like Structures in Epidermic Cells of Tadpoles, 189
 Logie, W. J., Action of Dysentery Bacilli on Nitrites and Nitrates, 94
 Loginoff, W. J., Tracheal Epithelium in Domestic Mammals, 349
Lophocolea minor not a Species, 781
Lophozia schultzei, New Variety, 655
 Lorenz, R., Metallic Fog in Fused Salts, 828
 Loris-Melikov, J., New Anaerobe in Typhoid Stools, 688
 Lösew, K., Composition of Eutectics, 563
 Lovell, J. H., Colour-sense of Hive-bee, 40
 Loyez, M., Staining Celloidin Sections of Nervous Tissue by the Iron-hæmatoxylin Method, 119
 Lucernarians, Development, 629
 Lucien, M., Staining the Internal Network in Nerve-cells, 119
 Ludmilla, —, Development of Ischnocolus, 621
 Lühe, M., Cystoteniæ of South American Felidæ, 206
 — Tapeworms of South American Felidæ, 49
 Lütke, H., Iron-carbon Alloys, 125
 Lütkemüller, J., Desmidiaceæ of Bohemia, 232
 Luminous Organs of Fishes, 745
 Lungs, Development and Evolution, 457
 Lutman, B. F., Cell and Nuclear Division in Closterium, 665

- Lutz, L., Deformation of *Ascophyllum nodosum*, 503
- Lycopodiaceæ, New Zealand, Anatomy, 62
- Lycopodium Fossil, 62
- Lycoridæ and Nephthyidæ of the North Sea and Baltic, 624
- Lycosa carolinensis*, Circulatory System, 200
- Lyginodendron (Crossothea) in Irish Coal Measures, 646
- Lymph-hearts of Turtles, 455
- Posterior, of Turtles, Structure and Development, 346
- Lyngbya, Cell-division, 500
- M
- Maas, O., Degenerative Changes in Sponges, 630
- Regeneration in *Chondrosia reniformis*, 56
- Macalister, G. H., Rat Plague in East Anglia, 688
- McAlpine, D., New Smut in a New Genus of Grass, 793
- Smuts of Australia, 81
- and others, Smut Fungi, 675
- McCance, A., Troostite, 827
- McCormick, F. A., Homothallic Conjugation in *Rhizopus nigricans*, 507
- McDermott, F. A., Photogenic Function in Marine Organisms, 355
- Photogenic Organs of Lampyridæ, 464
- McFadden, A. S., *Ahnfeltia gigartinoïdes*, 504
- McFadden, M. E., Colocodasya, 505
- Machine, Grinding and Polishing for making Microscopical Specimens for Metallurgical Work, R. and J. Beck's, 554
- Mellroy, A. L., Oogenesis in Mammals, 344
- McIntosh, D. C., Genital Pores in Norway Lobster, 201
- McIntosh, W. C., Notes on Polychæts, 360
- M'Keever, F. L., Algæ and their Study, 230
- — of the Elf Loch, 230
- *Phaethonium conferticoloum*, 233
- Mackinnon, D. L., Australian Aleyonarians, 364
- Herpetomonads from Dung-flies, 57
- Protist Parasites from Intestine of Trichoptera, 57
- Protozoan Parasites from Trichoptera, 476
- McLaughlin, A. J., Characters of Cholera and Cholera-like Organisms, 246
- Macrobotus macronyx*, Structure and Habits, 622
- Macrocystis, Fructification, 504
- Macroplea and Donacia, Respiration, 198
- Mactra, Artificial Parthenogenesis, 615
- Macvicar, S. M., *Fossombronina echinata*, 655
- McWilliam, A., Influence of Vanadium on Iron and Steel, 827
- Nickel Steels, 827
- Properties of Cast and Rolled Gold Plate, 557
- Madrepores, Cirripede and other Commensals, 624
- Magitat, A., Survival of Excised Cornea, 350
- Magnan, —, Size of Spleen in Birds, 352
- Magnesium, Aluminium Alloys, containing, 711
- Zinc and Cadmium, Ternary Alloys, 124
- Magnetic Properties of the Modifications of Iron, 270
- Magnus, P., New Fungi from the Tyrol, 673
- — Species of *Bresadolia*, 236
- Oak-mildew, 508
- Parasitic Root-diseases of the Juncaceæ, 670
- and another, Oak Mildew, 78
- Magpies, Microfilaria, 48
- Main squinado*, Development, 753
- Maiden, J. H., Queensland Ferns, 491
- Maier, F., New Method of Making Celluloid Serial Sections, 116
- Mair, W., Staining of Fats, 549
- Maire, R., *Boletus impolitus*, 512
- New Genus of Plasmodiophoraceæ, 243
- — Research on Plasmodiophoraceæ, 685
- Notes on Hypocreaceæ, 790
- Research on Cladochytriaceæ, 233
- and another, Notes on the Larger Fungi, 81
- Makuschok, M., Development and Evolution of Lungs, 457
- Malacobdella grossa*, 627
- Maldanidæ, Irish, 758
- Malleable Castings, 827
- Mallophaga and Anoplura, Studies, 751
- from Southern Birds, 465
- Mammalian Spermatozoon, 30
- Mammals, Development of Sympathetic Nervous System, 31
- Domestic, Tracheal Epithelium, 349
- European, 36
- — Six New, 36
- of West Indies, 612
- Oogenesis, 344
- Post-natal Remains of Notochord, 603
- Red Blood Corpuseles, 609
- Tapeworms, 760
- Trypanosomes, Classification, 632
- Man, Accessory Chromosomes, 29
- Conjunctival Epithelium, 610
- Evolution, 36
- Inheritance of Skin-pigmentation, 30

- Man, J. G. de, Anguillulide of the White Slime of Oaks, 361
- Manceaux, L., Culture of *Leishmania tropica* on Solid Media, 549
- Methods of Investigating Oriental Sore, 261
- Manuel, H., Blood Filaria in Horse, 470
- Manders, N., Validity of some forms of Mimicry, 741
- Manganese in Cast Iron, 272
- Influence on Mild Steel, 558
- Mangin, L., Cuirass of Peridimidae, 768
- Manipulation, Microscopical. See CONTENTS
- Mantis, Larval, Mimicry of Ant, 356
- Mantispæ, Larva, 465
- Mantle-cavity and Pallial Organs of Mollusca, 747
- Maplestone, C. M., Growth and Habits of Biporæ, 51
- Marattia, Anatomy, 377
- Marchal, E., Sexuality among the Mosses, 651
- Marchal, P., Notes on *Chermes pini*, 44
- Parasites of Olive-fly, 619
- Marchand, L., Fræco-painting of Fungi, 677
- Marchi, M. de, Plankton of Lago Maggiore, 789
- Marcus, H., Development of Head in Hypogcephis, 457
- Marcus, K., Olfactory Structures in Galatheids, 623
- Markings, Directive, of Passerine Birds, 352
- Marsch, C. D., Revision of North American Species of Cyclops, 291
- Marshall, F. H. A., Effects of One-sided Ovariectomy on Sex of Offspring, 454
- Martini, L. C. de, Internal Fertilization in Pareudrilus, 202
- Martin, A. L., Effect of Light on Obelia, 212
- Senescence in Hydroids, 211
- Martin, C. H., Cæcal Parasites of Fowls, 632
- Masing, G., Alloys of Lithium, 123
- Massalongo, C., Brazilian Hepatics, 497
- Masse, G., Notes on Fungi, 516
- Origin of Parasitism in Fungi, 238
- Masson, P., Saffron in Histological Technique, 444
- Mast, S. O., Blow-fly Larvæ and Gravity, 198
- Reactions of Amœba to Light, 366
- Mastigocoleus testarum*, 500
- Mastin, J., Polishing Metallic Preparations for Microscopical Examination, 267
- Mathewson, C. H., Alloys of Sodium with Silver and Gold, 556
- Mathis, C., Microfilarie in Tonkin Birds, 361
- Mathis, C., Species of Leucoctozoon, 368
- Spirochaet from the Rabbit, 369
- Studies on Trypanosomes, 213
- Trypanosomes in Fresh-water Fishes, 632
- Matrucho, L., Culture of an Edible Fungus, 236
- Matsumura, J., New Japanese Ferns, 223
- Matthew, C. G., Chinese Ferns, 650
- Matweiff, —, Slag in Steel, 271
- Maublanc, —, *Cladocytrium cæspitis*, 76
- Thermophilous Moulds, 673
- Maurel, E., Survival of Intestinal Organisms in Cooked Meats, 403
- Maxillary Glands of Cirripedes, 201
- Mayer, A. G., Converse Relation between Ciliary and Neuro-muscular Movements, 350
- Mayer, O., Modified Method of Isolating Typhoid and Paratyphoid Bacilli, 108
- Mayer, P., Tetrander Microtome, 113
- Mayor, E., and others, Experimental Researches with Uredineæ, 791
- Mazza, A., Marine Algology, 790
- Mazzetti, L., Interstitial Testicular Cells and Secondary Sex Characters, 348
- Role of Interstitial Testicular Cells, 740
- Mazzotto, D., Lead-tin Alloys, 711
- Measurement of Hardness, 274
- Measurements Microscopical, Observations on the Technical Execution and Biological Realization, 700
- Meats, Cooked, Survival of Intestinal Organisms, 403
- Medisch, M., *Hypocrea rufa*, 670
- Study of *Hypocrea rufa*, 391, 392
- Medium, Cultivation, for the Influenza Bacillus and Ducrey's Bacillus, 549
- Dieudonné's, Selective Action, 260
- New, and Fading of Aniline-stained Microscopical Preparations, 415
- — Mounting, for Botanical Preparations, 265
- Medulla, Origin in Ophioglossaceæ, 613
- Medulla-cells of Laminariaceæ, 504
- Medullation in the Pteridophyta, 643
- Medusa, Middle Cambrian, 629
- Meek, C. F. U., Spermatogenesis of *Stenobothrus viridulus*, 617
- Meek, W. O., Method of Studying Phagocytosis of Erythrocytes by Endothelial Cells, 110
- Meijere, J. C. H. de, Insects in Nepenthes Pitchers, 42
- Meinhold, T., Physiology of Diatoms, 784
- Meiotic Process, Unity in Plants and Animals, 186
- Melobesizæ, 505
- Classification, 505
- Mench, E., Direct Division of Red Blood Corpuscles in Scorpena, 35

- Mendel, Y., Fermentation of Sugars by Bacteria, 521
- Mendelism, 453
- Meneghini, D., Formation of Solid Metallic Solutions by Diffusion in the Solid State, 712
- Merceyopsis g.n. and other Indian Mosses, 66
- Mercier, L., Bacillary Disease among Fish, 405
- Crayfish Plague, 753
- Insects as Disseminators of Ergot, 163
- as Fungus-carriers, 515
- Large Gregarine in *Atyophyra*, 772
- Pathogenicity of *Bacillus chlororaphis*, 688
- Mercury, Action on Steel at High Pressures, 272
- Light, Application to Microscopical Works, 253
- Meres, Breaking of the, 788
- Merlia, 630
- Merlin, A. A. C. E., Diatomic Structure, 503
- Mr. Nelson's suggested Examination Questions upon Microscopy, 133
- On the Measurement of Grayson's New Ten-Band Plate, 160
- Some New Diatomic Structure discovered with a New Zeiss Apochromat, 700
- The Measurement of Grayson's New Ten-Band Plate, 129
- Merostomata, Middle Cambrian, 622
- Merrill, E. D., Bryophyta of the Philippine Islands, 68
- Ferns of the Philippine Islands, 66
- Merritt, M. L., Bryophyta of the Philippine Islands, 68
- Ferns of the Philippine Islands, 66
- Merton, F., *Pleodorina illinoisensis* Kofoid, 70
- Mesnil, F., Papillomatous Neo-formation in an Annelid, 625
- Mesnilella, New Species, 635
- Mesozoon, New, 51
- Metabolism, Effect of Etherization, 776
- Metachromatic Corpuscles and Mycoplasma Hypothesis, 479
- Metallic Fog in Fused Salts, 828
- Preparations, Polishing, for Microscopical Examination, 267
- Solutions, Solid, Formation by Diffusion in the Solid State, 712
- Metallographic Notes, 556
- Metallography, Microscopical, New Method, 253
- Simplification in Technique, 562
- Solid Colloid Systems, 560
- See CONTENTS
- Metallurgical Work, R. and J. Beck's Grinding and Polishing Machine for making Microscopical Specimens, 554
- Metals, Apparatus for Microscopical Examination, 561
- Bearing, 268
- Changes in Properties upon Working, 828
- Cold-worked, Reheating, 562
- — Stresses, 562
- Corrosion, 715
- Crystallization of Cast, 828
- Fatigue, 274
- Influence of Pressure on Melting-points, 563
- Limits of Elasticity and Hardening, 562
- Molten, Electrical Conductivity, 563
- Noble Alloys, 417, 826
- Viscous Flow, 274
- Metamorphosis, Fatty Body during, 618
- of Blow-fly, 198
- Metcalf, M. N., Studies on Amœbæ, 767
- Metchnikoff, E., Experimental Typhoid Fever, 524
- Intestinal Flora, 94
- Meteoric Iron, Synthesis, 559
- Meteorite, Iron-Nickel, 270
- Metzer, C., Junction of Fore-gut and Mid-gut in Hive-bee, 197
- Metzgeria, 781
- Meves, F., Role of Plastochondria in Fertilization of *Ascaris megalocephala*, 759
- Meyer, A., Chondriosomes in Plant-cells, 637
- Meyer, H., Transformation-point Curve, 126
- Meyer, K., Anaerobic Streptothrix, 803
- Meylan, C., Plagiothecium, 780
- Mice, White, Gestation, 737
- — Natural Immunity to *Trypanosoma lewisi*, 459
- Michael, A. D., 138
- Michaelsen, W., Caucasian Earthworms, 48
- Michel, A., Precision of Regeneration in Polynoids, 203
- Michener, J. R., New Dinoflagellates, 769
- Micro-organisms and Fermentation, 396
- in Koumiss, 92
- Microbes, Absorption Phenomena, 521
- Resistance to Passage through Colloid Filters, 548
- Microchemical Demonstration of Guanin, 258
- Microcoenus melitensis*, Agglutination by Normal Sera, 402
- — Resistance to Lactic Ferments, 403
- Microfauna, Fresh-water, from German East Africa, 39, 195
- of the Nile, 355
- Microfilaria from a Fowl, 625
- in Magpies, 48
- Microfilariae in Tonkin Birds, 361
- Micrologist, The, 701
- Micrometer, Improved, 408

- Micrometer, Plug, 256
 Micrometers, Glass, Directions for using, 538
 Microprojection, New Nernst Lamp for, 808
 Microscope, Beck's London; Handle Model, 406, 419
 — Binoocular, 806
 — — Improvement in Illumination of Objects observed with, 96
 — Comparator, or Reading, 807
 — Demonstration with Detachable Foot, Winkel's, 407, 692
 — Garjeanne's Simple Excursion, 690
 — Lamp, 128
 — — Emrys-Roberts, 698
 — — New, 255
 — Metal-, Reichert's New, 532
 — — Rejtő's, 531
 — Modern, Adams's "Variable" and the Evolution of, 178
 — New, by J. E. Barnard, 831
 — — Handle Model, 419
 — — Portable, 569
 — Old, by A. Pritchard, 835
 — — by J. Simons, 276, 528
 — The "Variable," 284
 — Winkel's Dissecting, 251
 — — Drawing, 811
 — — Stand No. 1, 248
 — — Stand No. 1d, 406
 — — Travelling, 248
 — Workshop, Jointed Arm for, 715
 Microscopes, Mineralogical and Metallurgical, Recent Progress in the Construction, 693
 Microscopic Investigation, Immobilizing Flies for, 266
 — Structure of Uric Acid *Calcoli*, 258
 Microscopical Examination of Blast-furnace Slag, 275
 — — of Metals, Apparatus, 561
 — — Polishing Metallic Preparations for, 267
 — Manipulation. *See* CONTENTS
 — Measurements, Observations on the Technical Execution and Biological Realization, 700
 — Metallography, New Method, 253
 — Observation of Frozen Objects, Apparatus, 693
 — Observations, Electric Heating Apparatus, 190
 — Optics. *See* CONTENTS
 — Preparations, Coloured Plates, 258
 — Purposes, Preparation of Kaiserting Material, 703
 — Technique, Celloidin in, 121
 See CONTENTS
 — Works, Application of Mercury Light, 253
 Microscopy. *See* CONTENTS
 Microspectroscope, 256
 Microspectroscopic Observation, 539
 Microsporidian, New, from Termite, 58
 Microtomo Knives, 703
 — Tetramer, 113
 Microtomes. *See* CONTENTS
 Mid-gut and Fore-gut, Junction in Hive-bee, 197
 Middleton, A. R., Rhythms in Termite Communities, 463
 Midge, Mosquito sucked by, 750
 Mietens, H., Origin of White Blood-corpuscles and Spleen in *Bufo vulgaris*, 316
 Migula, W., German Fungus-flora, 512
 Migration of Birds, 743
 Migrations, Diurnal of *Calanus finmarchicus*, 757
 Mildew, Oak, 78
 — of Cherries, 791
 — of Gooseberry and Oak, 392
 — of the Vine in Poland, 508
 — Physical Conditions of Resistance of the Vine, 395
 Milk, Bacteria in, Enumeration, 710
 — Soured, 404
 Miller, G. S., Six New European Mammals, 36
 Millipede, Termitophilous, New, 621
 Millipedes, Studies, 752
 Mimiery, Validity of some forms, 741
 Minchin, E. A., Cysticercoids from Rat-flea, 471
 — New Parasite of Rat-flea, 476
 Mirnesen, T., Islands of Langerhans in the Human Embryo, 31
 Mischococcus, Dichotomosphon and, 788
 Mite, Ear, of Cattle, 359
 Mites and Tumours, 200
 — Fresh-water, of Clare Island, 621
 — Injuries, Studies, 752
 Mitochondria, Continuity through many Generations of Cells, 190
 — Demonstrating the Presence in Cartilage Cells, 264
 — of Adipose Cells, 349
 Mitochondries of Plant-cells, 773
 Mitosis in Grafted Tissue, 350
 — Reappearance of the Nucleolus, 423, 598
 Mitotic Figures in Isolated Tissues, 349
 Miyake, K., Gametophytes and Embryogeny in *Cunninghamia*, 481
 Mjöberg, E., Studies on Mallophaga and Anoplura, 751
 Modilewski, J., Embryology in *Euphorbiaceae*, 372
 Mönkemeyer, W., Cratoneuron and Hygramblystegium, 493
 — Muscinæ of Bornholm, 494
 Moisture, Hymenophyllaceæ in Relation to, 487
Molendoa Sendtneriana, Distribution in Hungary, 66

- Molisch, H., Liberation of Iron by Green Water-plants, 184
- Mollé, J. v., Mammalian Spermatozoon, 30
- Molliard, M., Algal Figures on Culture Flasks, 785
- Hypochous Form of *Fistulina hepatica*, 512
- Mollier, S., Structure of Spleen Capillaries, 349
- Mollusca. See CONTENTS
- Molluscan Shell, Layers, 746
- Molluscs, Batrachospermum growing on, 787
- Marine, of Clare Island, 461
- of Ireland, 356
- of Portuguese East Africa, 355
- Monascus, Development, 77
- Monochytrium, a New Genus of the Chytridiales, 508
- Monocotyledonous Characters in Polycarpeæ, 640
- Monopyllidium passerinum*, Structure, 626
- Montanari, A., Effects of Pyridin Fixation upon Nervous Tissues, 702
- Moreau, F., Notes on Mucorini, 790
- Morel, C., Staining in Bulk with Hæmatoxylin, 118
- Morgan, W. De, Reaction of Tissues of Pecten to Implantation of Foreign Bodies, 356
- Moroff, T., Vegetative and Reproductive Processes in *Thalassicolla*, 475
- Morosoff, M., New Forceps, 416
- Morphology of Organisms concerned in the Production of Acute Intestinal Toxæmia in Infants, 280
- Morris, H. J., Properties of Cast and Rolled Gold Plate, 557
- Morse, M., Sterility, 30
- Morse, M. W., Experiments on Ova of *Cerebratulus*, 762
- Polarity in *Tubularia*, 765
- Mortensen, T., West Indian Echinoids, 208
- Mortierellæ, Study, 77
- Mosquito Larvæ, Carnivorous, 358
- sucked by Midge, 753
- Mosquitos, Bentley-Taylor Method of Mounting, 120
- Roumanian, 463
- Moss-fauna of Central America, 615
- Moss-flora in Central Asia, 495
- Mexican, 783
- of Bernina, 657
- of Bolivia, 68
- of Bulgaria, 657
- of Eisenach, 67
- of Haute-Saône, 382, 656
- of Rhine-land, 656
- of South Thuringia, 67
- of the Atlantic Islands, 382
- of the Jura, 494
- of Tunis, 382
- Moss-genus, Indian, New, *Hyophilopsis*, 654
- Moss-herbarium, F. Renauld's, 497
- Moss-pedigrees, Parallelism and Convergence, 65
- Moss-remains in Scottish Peat, 381
- Mosses and Liverworts, British, 227
- Antaretic, 784
- attacked by *Cladosporium*, 653
- Branch-formation, 651
- British, 228
- Crimean, 657
- Desiccation-phenomena, 381
- European, Critical, 656
- — New or Rare, 67, 227, 494
- Exotic, Illustrations, 227, 381
- Hungarian, 657
- Indian, *Merceyopsis* g.n. and other, 66
- Japanese, New, 495
- Mexican, 68, 383, 658
- of Ceylon, 382
- of Eastern Asia, 495
- of Hamburg, New Records, 67
- of Libya, 658
- of New Guinea, 495
- — — Caledonia, 784
- of Spitzbergen, 494
- of the Crimea, 382
- of the Erzgebirge, 656
- of the Haute-Saône, 229, 782
- of Tirol, 657
- Panama, 497
- Northern, 229
- Scottish, New, 228
- Sexuality, 651
- South Russian, 229
- Teneriffe, 382
- Moths, Grape, 464
- Motz-Kossowska, S., Mediterranean Species of *Halecium*, 474
- Moulds, Metabolism, 79
- Thermophilous, 673
- Moulting in Silkworms, 748
- Mounting, Fluid, 551
- Mosquitos, Bentley-Taylor Method, 120
- Slicing, and Grinding Rock-Sections, Method, 706
- Objects. See CONTENTS
- Mouse, White, Early Development, 603
- Movement in Gramineæ, Mechanism, 374
- Movements of Bacteria, New Method for Studying, 260
- Mozejko, B., Injection Preparations of *Petromyzon*, 263
- Mucorini, Norwegian II., 507
- Notes, 790
- Study, 76
- Mühlethaler, F., Desmids of the Burgäschimoos, 665
- Müller, K., European Hepaticæ, 381, 495
- Müller, P., Electrical Conductivity of Molten Alloys, 274, 560

- Müller, R., Formation of Axis of Corallium, 55
 — Rhizoxenia and Sarcodictyon, 54
 — Simple Object-holder for Photomicrography: Tables of Magnifications, 103
 — Variations of Typhoid and Dysentery Bacilli, 526
- Muller-Thürgau, H., Infection of the Vine by *Plasmopara viticola*, 507
- Mulson, K., Fish Disease, 799
- Muneh, —, Research on Diseases of Trees, 397
- Munerate, O., Smut-infection Experiments 676
- Murray, J., 569
 — Antarctic and other Tardigrada, 359
 — Australian Rotifera: Collected by the Shackleton Antarctic Expedition, 1909, 164, 284
 — Canadian Rotifera Collected by the Shackleton Antarctic Expedition, 1909, 285, 424
 — Clare Island Rotifers, 627
 — — — Water-bears, 422
 — Notes on Tardigrada, 468
 — Red Snow, 500
 — Rotifera of New Zealand: Collected by the Shackleton Antarctic Expedition, 572, 573
 — Rotifera of some Pacific Islands: Collected by the Shackleton Antarctic Expedition, 1909, 427, 429
 — Some African Rotifers: Bdelloids of Tropical Africa, I, 129
 — South African Rotifera: Collected by the Shackleton Antarctic Expedition, 572, 584
- Murrill, W. A., and others, Poisonous Mushrooms, 236
- Muscardine, Green, of Frog-hoppers, 673
- Muschler, R., Algæ of Tripoli, 660
- Muscid Larvæ, Metamorphosis of Intestinal Musculature, 42
- Musckke, Cells, Chromidia in, 464
- Muscids, Larval, Beginning of Muscular Phagocytosis, 42
- Muscineæ, British, 656
 — Inflorescence, 779
 — of Bornholm, 494
- Muscle, Striped, Interstitial Tissue, 35
- Muscle-fibre and Tendinous-fibre, Union, 458
- Muscle-fibres in Heart of Fishes, Distribution 741
- Muscle-fibrils and Tendon-fibrils, Direct Connexion, 348
- Muscles of Lamprey, 611
- Musculature of Pectoral Girdle and Flipper in Cetacea, 192
 — Ventral, of Fishes, 194
- Museum, Natural History, at S. Kensington, Scheme to encroach upon the space allotted in 1899, 425
- Mushroom Culture, 82
 — Poisoning, 599
- Mushrooms, Poisonous, 236
- Mussels, Fresh-water, Contraction of Adductors, 616
 — — Notes, 462
- Muth, F., Mildew of Cherries, 791
- Mutinus caninus* and *Ithyphallus impudicus*, Study, 512
- Mycetozoa, Collodermata, a New Genus, 90
 — Distribution in South Midlands, 401
 — See CONTENTS
- Mycogeography, 237
- Mycological Flora of Oak-tree, Slime-flux, 516
 — Notes, 82, 677, 795
- Mycology, British, 513
 — Notes, 516, 795
 — Technical, 83
- Mycoplasm Hypothesis and Metachromatic Corpuseles, 479
- Mycorhiza of Gastrodia, 681
- Myotomes, Development, 740
- Myriopoda, Cavernicolous, 44
 — See CONTENTS
- Myriopods, Carboniferous, British, 200
 — Doubling of Segments, 621
- Myxomycetes, Alternation of Generations, 685
 — from the Neighbourhood of Paris, 801
 — Notes, 520, 552
 — Studies, 684
- Myxonema in Salmon Disease, 663
- Myxophyceæ, 233
- Myxosporidia, Distribution, 477
- Myzostoma, Theory of Dwarf Males, 204

N

- Nadson, G. A., Effect of Coloured Light on *Stichococcus bacillaris*, 387
 — *Mastigocoleus testarum*, 500
- Nageotte, J., Staining Celloidin Sections of Nervous Tissue by the Iron-hæmatoxylin Method, 120
- Namyslowski, B., *Glaesporium ribis*, 510
 — Study of Mucorini, 76
- Nänni, J., Structure of Tomopteris, 758
- Nanomitrium and Ephemerum in North America, 66
- National Physical Laboratory, 716
- Nattan-Larrier, L., Leucocytosoon in Fish-Eagle, 477
- Naunoh, E., Research on Diseases of Trees, 677
- Navicula rhomboides*, 232
- Nectria graninicola* and *Fusarium nivale*, 78
- Necturus maculatus*, Effects of Starvation 613
- Neeracher, F., Insects of the Rhine, 197
- Neger, F. W., Ambrosia Fungus, 396

- Neger, F. W., Spore-distribution in *Selaginella*, 646
- Nègre, L., Agglutination of *Micrococcus melitensis* by Normal Sera, 402
- Nelson, E. M., Adams's "Variable" and the Evolution of the Modern Microscope, 178, 284
- An Objective Mount with an Iris, 283
- *Navicula rhomboides*, 232
- New Dark-ground Illuminator, 276
- On some New Objectives and Eye-pieces by R. Winkel, of Göttingen, 284, 451
- The Society's Standard Thread, 537
- Winkel's Drawing Microscope, 811
- Nematode Extract, Anti-coagulant Action, 205
- New, 759
- in Eye of Queensland Fowl, 48
- Supposed, in Circular Muscle of Earthworm, 48
- Nematodes in Deer, 760
- Nematohelminthes. See CONTENTS
- Nemerteans, Hermaphroditism, 206
- Regeneration, 206
- Nemertines of Millport, 761
- Nepenthes Pitchers, Insects, 42
- Nephrodium, Nomenclature, 221
- Nephtyidæ and Lycoridæ of the North Sea and Baltic, 624
- Nerust Lamp for Microprojection, New, 808
- — New Zeiss, 810
- Nerve-cells, Grouping in Spinal Cord of Tench, 610
- of Leech and Earthworms, 624
- Staining Internal Network, 119
- Nerves and Blood-vessels of *Æolididæ* and *Tritoniadæ*, 196
- Nervous System of *Ascaris*, 470
- — of *Dytiscus marginalis*, 41
- — Sympathetic, Development in Mammals, 31
- — — in Birds, 32
- — — in Fishes, 606
- — — in Turtles, 605
- Tissues, Effects of Pyridin Fixation, 702
- Neumann, E., Spindle-cells of Amphibian Blood, 740
- Neumann, L. G., Mallophaga from Southern Birds, 465
- New Ixodidæ, 44
- Neumayer, L., Celloidin in Microscopical Technique, 121
- Neuro-muscular and Ciliary Movements, Converse Relation, 350
- Neurochords of *Criodrilus*, 202
- Neurohypophysis, Human, Pigment, 190
- Neuroplasm, Physical Nature, 458
- Newts, Regeneration, 614
- Nichols, A. R., Irish Polyzoa, 362
- Nichols, G. E., Ephemerum and Nanomitrium in North America, 66
- Nickel Steel, Changes occurring in, 713
- Nickel Steels, 827
- — Magnetic Properties, 827
- Nickel-sulphur System, 416
- Nicoll, W., Cysticeroids from Rat- flea, 471
- Entozoa from Clyde Fishes, 49
- *Gasterostomum tergustinum*, 471
- Nicolle, C., Culture of *Leishmania tropica* on Solid Media, 549
- Methods of Investigating Oriental Sore, 261
- Nicoloff, T., Ovule and Embryo-sac of the Platauaceæ, 775
- Nidularia, Spore-formation, 794
- Niemeyer, E., Reichert's Dark Ground Illuminator with Arrangement for Centring on a Plain Stage, 426
- Nieuwenhuis, A. W., Pure Cultures from a Single Cell, 820
- Niosi, F., Strict Anaerobic Bacillus causing Purulent Pleurisy, 522
- Nitrifying Organisms in Soil, 405
- Nitrite-formation by Various Bacilli, 526
- Nitrogen, Assimilation by Fungi, 512
- Influence on Cementation of Steel, 558
- Nobre, A., Molluscs of Portuguese East Africa, 355
- Noelle, W., Anatomy and Morphology of Roots of Conifers, 371
- Nogier, T., Castration by X-Rays, 347
- Sterilization by X-Rays, 347
- Noguehi, H., Cultivation of *Spirochæta pallida*, 820
- Nomina nuda, 659
- Nose-piece, Sliding, for use in Stereophotomicrography, 95
- Nosema apis*, Bee Disease due to, 769
- Nostoc, New Species, 664
- Notochord Epithelium, Origin, 740
- in Mammals, Post-natal Remains, 603
- Notropis, Variations of Species, 38
- Nuclear Autochromatism in Algæ, 785
- Evolution in Ascomycetes, 508
- Nuelei, Life-history and Physiology, 478
- Nucleolus, Reappearance in Mitosis, 598
- Nucleoproteid, Function, 637
- Nucleus Action and Grain-growth, 716
- Synopsis, 478
- Nusbaum, J., and another, Regeneration in Nemerteans, 206
- Nutrition and Growth of Seed Plants. See CONTENTS
- Mineral, of Vascular Plants, 482
- of Lichens, 518
- Nuttall, G. H. F., Parasites of Biliary Fever in Horses, 369
- Nutting, C. C., Gorgonellids of 'Siboga' Expedition, 55
- Gorgonidæ of 'Siboga' Expedition, 55
- Isidæ of 'Siboga' Expedition, 55
- Plexaurids of 'Siboga' Expedition, 55

O

- Oak and Gooseberry Mildew, 392
 — Mildew, 78, 508
 — *Cicinnobolus* sp. Parasitic, 393
 Oak-tree Slime-flux, Mycological Flora, 516
 Oaks, Anguillulidæ of the White Slime, 361
 Oats, Ergot, 391
 Obelia, Effect of Light, 212
 Oberstein-Breslau, O., *Cicinnobolus* sp. Parasitic on *Sphærotheca mors-uvæ*, 392
 Obituary, F. H. Gillot, 799
 — Carolyn Wilson Harris, 90
 Object-holder, Simple, for Photomicrography: Tables of Magnifications, 103
 Objective Mount with an Iris, 283
 — Screw Threads, Anomalies, 175, 283
 Objectives and Eye-pieces, New, by R. Winkel of Göttingen, 284, 451
 Objectives. See CONTENTS
 Ocular, Edinger's Pointer-Double, 252
 Odhner, N., Genus *Cumanotus*, 39
 O'Donoghue, C. H., Duplicity in Chick Embryos, 33
 Odontopteryx, New Species, 613
Oenothera, Chromosome-reduction, 370
 — Mutants and Hybrids, Chromosomes, 370
 Offord, J. M., 137
 Ohta, R., Fat-destroying Fungi, 677
 Oidium of Japanese *Euonymus*, 78
 Okajima, K., Ear of Urodela, 193
 Okamura, K., Japanese Marine Algae, 229
 Okamura, S., Japanese Bryophytes, 783
 — New Japanese Mosses, 495
 Okapi, Atlas, 36
 Oknoff, M., Internal Structure of Pearlitic Steel, 828
 Olfactory Structures in Galatheids, 623
 Oligochaet Commensals in *Spongilla carteri*, 469
 Oligochaeta, Littoral, of the Clyde, 758
 Olive-fly, Parasites, 619
 Oliver, R. B., Ferns of the Kermadec Islands, 64
 Omeliansky, W. L., Pigment of *Azotobacter Chroococcum*, 686
 Oocyte, Primary, of *Asterias forbesii*, Polarity, 472
 Oogenesis, in Dytiscidæ, 198
 — in Mammals, 344
 — in Pelagia, 473
Oospora linguialis, Rapid Method for Isolating, 548
 Ophioglossaceæ, Origin of Medulla, 643
 Ophioglossum, Forms, 643
 — *palmutum*, 777
 — — Morphology, 642
 Ophiurans, North Pacific, 472
 Opisthobranchs of South Africa, 39
 Oppel, A., New Kind of Cell in Brunner's Glands, 319
 Optical System with regard to Perspective, Pupil, 817
 Optics, Microscopical. See CONTENTS
 Orange and Peach, Gum-inducing Diplodia, 672
 Orchids, Bacterial Diseases, 802
 Organisms, Intestinal, Survival in Cooked Meats, 403
 — Marine, Photogenic Function, 355
 Oriental Sore, Methods of Investigating, 261
 Orueta, D. de, Apparatus for Photomicrography with the Microscope standing in any Position, especially in Inclined position, 423, 588
 Osborn, T. G. B., *Spongospora subterranea*, 401, 685
Oscillatoria rubescens, 389, 662
 Oshima, H., Luminous Organs in Fishes, 745
 Osmotic Growths, 191
 — Pressure, and the Form and Structure of Plants, 484
 Osmundaceæ, Anatomy, 645
 — Fossil, 379
 Osseous Tissue, Method for Studying, 551
 Ostefeld, C. H., Arctic Plankton, 789
 — Diatoms and Flagellatæ from East Greenland, 660
 — Halosphere and Flagellatæ, 660
 — Thorsophæra, 71
 Ostracods from Funafati, 47
 — from Madeira, 757
 Ova and Larvæ, Teleostean, 35
 — and Sperms, Influence of Radium Rays, 185
 — of *Cerebratulus*, Experiments, 762
 — Sea-urchin, Extra-ovate Experiments, 363
 Ovaries in some Polyclads, Two-fold Function, 761
 — in Starfish, Seasonal Retrogression, 52
 Ovariectomy, One-sided, Effects on Sex of Offspring, 454
 Ovary in Hybrid Birds, 604
 — State of, in Hybrids of Goldfinch and Canary, 455
 Overton, J. B., Living Cells in Relation to Transpiration and Sap-flow, 482
 Oviduct of Domestic Fowl, Ligaments, 35
 Ovipak Iron, 713
 Oviparity and Viviparity in Dung-fly, 198
 Ovule and Embryo-sac of the Platanaceæ, 775
 Ovum, Mammalian, Maturation, 603
 — of *Ascaris megalocephala*, Fertilized, Compression Experiments with, 759
 Ovarian, of *Proteus*, 456
 Ox-warbles, Occurrence, 619

- Oxygen, Solubility in Molten Silver, 125
 Oxyuris in Appendix vermiciformis, 470
 Oysters, cleansing, 40
 — Feeding Habits, 40
- P
- Paiva, C. A., Carnivorous Mosquito Larvae, 358
Palæmon niloticus in Lake Tchad, 753
 Palæozoic Insects, New, 466
 Palladine, W., Peroxydase and Respiratory Pigments, 638
 Palladium-gold Alloys, Occlusion of Hydrogen, 557
 Palmer, T. C., 133
 — Locomotion in *Suirella*, 384
 — *Suirella elegans*. Method of Locomotion, 132
 Palpi of Male Spiders, 44
 Pampalini, R., *Woodwardia radicans* in Italy, 649
 Panton, D. N., New Method for Differentiation of Bacteria, 109
 Paoli, Guido, Monograph on Tarsonemidæ, 752
 Papaveracæ, European. Seeds, 218
 Papillæ, Cutaneous, in Gobius, 741
 Papillomatous Neo-formation in an Annelid, 625
 Paque, E., *Faucheria terrestris*, 666
 Paraffin Baths, Ordinary, Adaptation for Vacuum Embedding, 26
 Paralysis, Infantile, Histological Changes, 258
 — Landry's, Bacteriology, 244
 Paramœcium, Conjugation, 634
 — Effect of Excretion-products on Rate of Reproduction, 767
 — — of Inanition, 366
 — Experiments, 366
 — Two Thousand Generations, 367
 Paranhos, V., Alleged Importance of Demodex in Spreading Leprosy, 622
 Parasite, Gid, 760
 — New, of Rat-flea, 476
 — of Coast Fever, 770
 — Pearl-inducing, 470
 — Protozoon, from Mucous Membrane of Sheep's Abomasum, 57
 Parasites, Blood, 57
 — Cæcal of Fowls, 632
 — from Irish Sea Fishes, 49
 — Horse, in Cameroun, 471
 — of Biliary Fever in Horses, 369
 — of Fishes, 760
 — of Leucocytes in Brown Rat, 633
 — of Olive-fly, 619
 — on the Roots of Juncacæ, 90
 — Protist, from Intestine of Trichoptera, 57
 — Protozoon, from Trichoptera, 476
 Parasitism in Fungi, Origin, 238
 — Method of Examining Fæces for Evidences, 554
 Paratyphoid and Typhoid Bacilli, Modified Method of Isolating, 108
 — Bacilli, Distribution, 402
 Pareudrilus, Internal Fertilization, 202
 Paris, E. G., Bryological Index, 227
 — Bryophyta of Tropical West Africa 496
 — Hepaticæ of New Caledonia, 383
 — Mosses of Eastern Asia, 495
 — Nomina nuda, 659
 — Obituary, 659
 Park, W. R., Cultivation of Human and Bovine Tubercle Bacilli, 107
 Parravano, N., Alloys of Copper, Antimony and Bismuth, 124
 — Ternary System, Silver-tin-lead, 556
 Parthenogenesis, Artificial in Mactra, 615
 — — in Toad, 454
 — — of Toad's Egg, 454
 — Experimentally Induced in Toad, 454
 — Traumatic, Factors, 737
 Pascher, A., Chrysomonadæ from the Hirschberger Grossteich, 661
 Passow, H., Microscopical Examination of Blast Furnace Slag, 275
 Patella, V., Endothelial Genesis of Leucocytes, 188
 Patouillard, N., Notes on Larger Fungi, 676
 Pavarino, G. L., Bacterial Diseases of Orchids, 802
 — *Bacterium briosianum*, 803
 — — *briosii*, 523
 Pavillard, J., Vegetable Protistology, 387
 Pawson, C. F., Turbidometer for Counting Vaccines, 824
 Pax, F., Studies of Actinians, 211
 Peach and Orange. Gum-inducing Diplodia, 672
 Pearl, R., Inheritance in Hybrid Poultry, 34
 — — of Colour-pattern in Hybrid Poultry, 34
 Pearl-inducing Parasite, 470
 Pearlitic Steel, Internal Structure, 828
 Pearson, J., Holothuroids from the Indian Ocean, 209
 Pecten, Reaction of Tissues to Implantation of Foreign Bodies, 356
 — Visceral Ganglion, 40
Pectinatella magnifica near Berlin, 763
 Pectoral Girdle and Fins of Teleosteans, 195
 — — and Flipper in Cetacea, Musculature, 192
 Peebles, F., Interchange of Limbs of Chick by Transplantation, 738
 Peglion, V., Biology of Sclerospora, 234
 — Notes on Erisipheæ, 671
 Peklo, Y., Actinomycosis of Plants, 92

- Pélabou, H., Selenium-antimony System, 826
- Pelagia, Oogenesis, 473
- Pellini, G., Gold Tellurides, 557
— Tellurides of Sodium and of Silver, 416
- Pelomyxa, Encystation, 631
— Studies, 631
- Pelvic Bones of some Cetacea, 459
- Pelourde, F., Some Mesozoic Ferns and their Leaf-scars, 617
- Pelz, E., Nitrite-formation by Various Bacteria, 526
- Penard, E., Antarctic Rhizopods, 366
- Penau, H., Bacterial Cytology, 404
— Minute Structure of *Bacillus anthracis*, 524
- Penfold, W. J., Variability of Intestinal Bacteria, 525
- Penguin's Vertebral Column, Mobility, 743
- Penicillium, Coremium-formation, 79
- Penis of Drake and Gander, 353
- Pennatulacea, 765
- Pennatulids, Australian, 365
- Pennington, L. H., Assimilation of Nitrogen by Fungi, 512
— Effect of Longitudinal Compression upon the Production of Mechanical Tissue in Stems, 373
- Pentaceros reticulatus*, Structure, 364
- Pentastomes in Australian Cattle, 623
- Pentastomid, New, 468
- Pentastomum of Python, 200
- Peressleginn, B., *Laminaria hyperborea*, 74
- Pérez, C., Beginning of Muscular Plagocytosis in Larval Muscids, 42
— Cuticular Warts of *Pilargis verrucosa*, 47
— Metamorphosis of Blow-Fly, 198
— — of Intestinal Musculature in Muscid Larvæ, 42
— New Microsporidian from Termite, 58
— Seasonal Retrogression of Ovaries in Starfish, 52
- Perianth, Premature Fall, 485
- Peridinium Plankton at Rovigno, 57
- Peridinidæ, Cuirass, 768
- Periodicity in Spirogyra, 231
- Peripatua from Grenada, New Species, 752
— Jamaica, 466
- Periplasmodium, Significance, 481, 488
- Perkins, G. H., Fossil Cetacea, 37
- Permin, C., Improved Form of Graduated Pipette, 553
- Peroxydase and Respiratory Pigments, 638
- Perrier, R., Mantle-cavity and Pallial Organs of Bullelidæ, 747
- Perrin, G., Prothallia of Equisetum, 645
- Pescher, A., Cryptomonadæ, 661
— Two Brown Flagellatæ, 664
- Petch, T., Note on the Biology of Septobasidium, 676
- Petch, T., Physiology and Pathology of *Herea brasiliensis*, 795
- Peters, L., *Pythium de Baryanum*, 508
- Petersen, C. G. J., Animal Life of Sea-bottom, 741
— Damage to Plaice-fishing by Whelks, 747
- Petersen, H. E., Ceramium, 669
— Danish Phycomyetes, 77
- Pethybridge, G. H., Experiments with *Phytophthora*, 507
— and another, Bacterial Disease of Potato-plant, 247
- Petiole, Removal of Starch through, 373
- Petkoff, S., Fresh-water Algæ from Macedonia, 390
- Petrenko, G. J., Alloys of Silver with Cadmium, 825
- Petromyzon, Injection Preparations, 263
- Petrunkévitch, A., Circulatory System of *Lycosa carolinensis*, 209
- Petit, A., Hæmogregarines, 214
— Mitosis in Grafted Tissue, 350
— New Hæmogregarine from the Horned Asp, 477
- Peyron, —, Pigmentation of the Nervous Lobe of the Hypophysis, 459
- Pfenninger, M., Carbohydrates in Seeds, 489
- Phaethammion confervicolum*, 233
- Phagocytosis, Muscular, Beginning in Larval Muscids, 42
— Occurrence in Root-nodules of Cycads, 60
— of Erythrocytes by Endothelial Cells, Method of Studying, 110
- Pharetronid Sponge, Remarkable, 365
— Sponges of Essen Greensand, 631
- Philichthyidæ, Affinities, 47
- Philonotis revised by Disner, 654
— *seriata* with Fruit, 494
- Phisalix, M., Bite of Heloderma, 741
- Phloem of Juglandacæ, 480
- Pholas cavilida*, Influence of Radium on the Development, 462
- Phomopsis, Genus, 510
- Phosphorescence of *Pleurotus japonicus*, 512
- Photogenic Function in Marine Organisms, 355
— Organs of Lampyridæ, 464
- Photographic Apparatus, New, of the Paris School of Mines, 103
- Photographing Fossils by Reflected Light, 257
- Photography, Easy Method of Treating Printing-out Paper for all Kinds of, 129
- Photomicrographic Apparatus, 273
— — for Photographing Insects, Leitz's, 543
— — Geometric Slide, 836
— — Leitz's New Large, 541

- Photomicrographic Apparatus, Leitz's Small, 540
- Photomicrographs, Instantaneous, Simple Method of Obtaining, 19
- Photomicrography, Instantaneous Exposure, 721
- Low-Power, with Special Relation to a Colouring Method for Tinting Lantern Slides, 419
- Practical, Barnard's, 545
- Simple Object-holder: Tables of Magnifications, 103
- Stereoscopic, 816
- Use of Metallic Electric Arc, 21
- with the Microscope standing in any Position, especially in Inclined Position, Apparatus, 423, 588
- Wratten and Wainwright's, 103
- See CONTENTS
- Photophores of Decapod Crustacea, 45
- Phototropism and Geotropism, in Fungi, 396
- Phryganea grandis*, Study, 750
- Phycocyanin, Phycoerytherin and, 784
- Phycoerytherin and Phycocyanin, 784
- Phycomycetes, Danish, 77
- Phyllirhoe bucephala*, 39
- Minute Structure, 196
- Glands and Luminescence, 196
- Phyllopod, New Antarctic, 47
- Phyllopora Anostraca, Monograph, 46
- Phylogeny of Algae, 498
- of Cerithiidae, 356
- Physalosporina, a New Genus of Pyrenomyces, 671
- Physcia and Anaptychia, Apothecial Development, 401
- Physiology of Seed Plants. See CONTENTS
- Phytophthora, Experiments, 507
- Phytoplankton of the Caspian Sea, 71
- of the Zeller See, 388
- Periodicity, of Leopoldstein Lake, 660
- Picramic Acid, Use for Staining, 118
- Piéron, H., Physiology of Sleep, 459
- Pigeons, Colour-inheritance, 738
- Webfoot Character in, 455
- Pigg, J. I., Stereoscopic Photomicrography, 816
- Pighini, G., Metabolism of Moulds, 79
- Pigment in the Human Neurohypophysis, 190
- Pigment-cells, Development in Teleostean Embryos, 187
- in Sheep's Cornea, 190
- Pigmentation of the Nervous Lobe of the Hypophysis, 459
- Pigments, Respiratory, and Peroxydase, 638
- Pilargis verrucosa*, Cuticular Warts, 47
- Pilger, R., Marine Algae of Kamerun, 790
- Pinussohn, L., Enzymes in Different Bacteria, 94
- Pinoy, M. E., *Sporotrichum beurnmanni* in Man, 404
- Pinto, M., Parasites of Leucocytes in Brown Rat, 633
- Pipette, Graduated, Improved Form, 553
- Pitard, J., Moss-flora of Tunis, 382
- Pits, Bordered, Staining, 709
- Placenta, Mole's, Giant-cells, 188
- Plagiothecium, 780
- Plague, Crayfish, 753
- Material, Method of Preserving, 120
- Rat, in East Anglia, 688
- Plaice-fishing, Damage by Whelks, 747
- Planaria, Regeneration in Short Head-pieces, 761
- Planarians, Effect of Starvation, 627
- Regeneration, 626
- Plankton, Arctic, 789
- from the Julischen Alps, 388
- of Lago Maggiore, 789
- of Prester See, 789
- of Spitzbergen, 39
- Organisms, Simple Arrangement for Determining Sinking-velocity, 122
- Peridinium, at Revigno, 57
- Scottish and Irish, 355
- Summer, of West of Scotland and Irish Sea, 614
- Plankton-algae, 71
- Plant-cells, Chondriosomes, 479, 637
- Mitochondries, 773
- Plant-disease, Sclerotinia, 670
- Plant-diseases, 84, 238, 678
- *Bacillus coli*, 804
- in South Africa, 678
- in the Tropics, 514
- Plant-forms, New, Traumatism in Relation to, 485
- Plant-organs, Cryoscopic Determination of Osmotic Pressure, 219
- Regeneration and Polarity, 219
- Plant-parasites, Wintering, 83
- Plants, Absorption of Alkaline Earth Salts, 218
- Actinomycosis, 92
- Complementary Chromatic Adaptation, 776
- Diseases, 238, 514, 796
- Economic, Diseases, 84
- Osmotic Pressure, and the Form and Structure of, 484
- Sea-side, Anatomical Researches, 216
- Vascular, Evolution of Conducting-tissues, 638
- — Mineral Nutrition, 482
- — Transitory Tissues, 216
- Plasma-membrane, Chemical Composition, 636
- Plasmodes, New Methods of Demonstrating, 119
- Plasmodia, Movements, 479
- Streaming, 520

- Plasmodiophora brassicæ*, Parasite of Rabies and, 803
 Plasmodiophoraceæ, New Genus, 243
 — — Research, 685
Plasmopara viticola, Infection of the Vine, 507
 Plastocondria, Role of, in Fertilization of *Ascaris megalocephala*, 759
 Platanaceæ, Ovule and Embryo-sac, 775
 Plate, L., Heredity and Evolution, 453
 Plates, Wax, Apparatus for Rolling, 112
 Platyhelminthes. See CONTENTS
 Playfair, G. I., Polymorphism and Life-history in the Desmidiaceæ, 389
 Plehn, M., Fish Disease, 799
Phodorina californica, 502
 — — at Banyuls, 768
 — *illinoisensis*, 70
 Plessis, G. du, Hermaphroditism in Nemerteans, 206
Pleurage zygospora, Development of the Spores, 671
Pleurococcus sulphurarius, 788
Pleurotus japonicus, Phosphorescence, 512
 Plexaurids of 'Siboga' Expedition, 55
Plica semilunaris in Hereros and Hottentots, 612
Plicaria planchonii, 670
 Plumage Changes in Red Grouse, 353
 Plumarids, Siboga, 765
 Plumularid Genus, New, 365
 Pneumococcus and Streptococcus, Virulence, 245
 Pocock, R. L., Carboniferous Arachnida, 467
 — Cutaneous Scent-glands of Ruminants, 351
 — Mimicry of Ant by Larval Mantis, 356
 Polpera, J., Moss-flora of Bulgaria, 657
 Pötter, E., Staining the Medullary Sheath in Brain-sections, 120
 Poisoning by Fungi, 677
 — Mushroom, 509
 Poisonous Mushrooms, 236
 Polacci, G., Parasite of Rabies and *Plasmodiophora brassicæ*, 803
 Polarity in Tubularia, 765
 Polarized Light, Interference Phenomena, 405
 Polarizing Apparatus, Model of the Vibration-planes of Light, 698
 — Prisms, Glass, 697
 Polishing Metallic Preparations for Microscopical Examination, 267
 Poll, H., Ovary in Hybrid Birds, 604
 Pollen-mother-cells, Heterotypic Division, 637
 Pollination Experiments with Anonas in South Florida, 374
 Polyblepharidæ, New Genus, 71
 Polycarpææ, Monocotyledonous Characters, 640
 Polychæta from the Delta of the Volga, 360
 Polychæta, Littoral, of Torquay, 48
 Polychæts, Incubation, 758
 — Notes, 360
 — Pelagic, of Irish Seas, 360
 Polychad, South African, New, 50
 Polychæds, Two-fold Function of Ovaries, 761
 Polyides and Furcellaria, Anatomy, 785
 Polymorphism and Life-history in the Desmidiaceæ, 389
 — in Flagellates, 768
 — of Zinc, 123
 Polynoids, Precision of Regeneration, 203
 Polypodiaceæ and Cyathaceæ, Relation to Woodsiæ, 486
Polypodium hydriforme, 365
 Polyspermy, 185
 Polytrichaceæ of North America, 383
Polytrichum, 781
 Polyxenus, Study, 199
 Polyzoa, Irish, 362
 Pond Life, Exhibition, 427
 Ponroy, M., Mushroom Culture, 82
Pontobdella muricata, Adipose Cells, 624
 Ponso, M., Simple Method of Making Drawings for Projection Purposes, 100
 Popoff, M., Chromidia in Cells of Muscidæ, 464
 Popoff, N., Buccal Apparatus of Hemiptera, 750
 — Scellionid Parasite of Spider's Eggs, 41
 Popovici-Bazosanu, A., Study of Sphégoïde, 357
 Poppe, K., Simple Shaker, 111
 Popta, C. M. L., Function of Swin-bladder, 194
 Porifera. See CONTENTS
 Porpita, Marginal Glands, 474
 Porter, A., Bee Disease due to *Nosema apis*, 769
 Portevin, A., Cementation by Gases, 269
 — Chromium Steels, 827
 — Iron-antimony Alloys, 558
 — Pseudo-binary Alloys, 561
 Portier, P., Digestion in Wood-eating Caterpillars, 464
 "Portuguese Man-of-war," Law of Budding, 473
 Potato-plant, Bacterial Disease, 247
 Potrzebowski, K., New Method of Demonstrating *Spirochaeta pallida*, 118
 Pougnet, J., Action of Ultra-violet Rays upon Green Vanilla-pods, 484
 Poultry, Hybrid, Inheritance in, 34
 — — — of Colour-pattern, 34
 Poyarkoff, E., Incubation of *Cycas* Embryos, 463
 Poyser, W. A., and others, *Asplenium alternans* in America, 777
 Prauss, S., Jointed Arm for Workshop Microscope, 715
 Prawn, Fresh-water, Primitive, 754
 Prawns, Behaviour, 623

- Preparing Objects. *See* CONTENTS
 Preservative Fluids. *See* CONTENTS
 Preserving Brain Sections, Method, 552
 President, The, 132, 137, 138, 277, 283,
 421, 423, 425, 427, 836-9
 President's Address: The Determination
 of Sex, 138, 141
 Pressure, Influence on Melting-points of
 Metals, 563
 Price, S. R., New Species of Debaria, 502
 Primrose, H. S., Metallography as an Aid
 to the Brassfounder, 418
 Pringsheim, H., Nitrifying Organisms in
 Soil, 405
 Printing-out Paper, Easy Method of Treat-
 ing for all kinds of Photography, 129
 Prisms, Polarising, Glass, 697
 Pritchard, F. J., Dissemination of
Puccinia graminis, 792
 Projection, Arc Lamps for, 96
 — Crystalloptic, Aids, 698
 — Purposes, Drawings for, Simple Method
 of Making, 100
 Proteus, Ovarian Ovum, 456
 Prothallia of Equisetum, 645
 Protist Parasites from Intestine of Trich-
 optera, 57
 Protistology, Vegetable, 387
 Protodermoptera, Position and Classifica-
 tion, 620
 Protolindsaya and other Bornean Ferns,
 65
 Protoplasm, Permeability, 773
 — Structure, 636
 Protoperus, Eye, 741
 Prototracheata. *See* CONTENTS
 Protozoa in the Alimentary Canal of House-
 fly, 634
 — of the Soil, 767
 — *See* CONTENTS
 Protozoan Parasites from Trichoptera, 476
 Protozoan Parasite from Mucous Mem-
 brane of Sheep's Abomasum, 57
 Pseudoscorpiones of Clare Island, 621
 Pteridophyta, Medullation, 643
 — Xylem Elements, 644
 — *See* CONTENTS
 Pteridophytal Origin of so-called Algal
 Coals, 221
 Pteripophytes, North American, 649
 — of Libya, 649
 — of Schleswig-Holstein, 778
 Pteris, Embedded Antheridia, 644
 Pteropsida, 378
 Pteropus, Eye, 189, 740
Puccinia graminis, Dissemination, 792
 — *polophylla*, Nuclear Phenomena, 675
Punctularia tuberculosa, 81
 Punnett, R. C., Mendelism, 453
 Pupil of an Optical System with regard to
 Perspective, 817
 Puschkarow, B., Studying Amœba, 821
 Pycnogonid, New Decapod, 467
 Pycnogonids of Clyde Area, 200
 — Pacific, 45
 — Sudanese, 467
 Pyrenomyces, Physalosporina, a New
 Genus, 671
 Pyridin Fixation, Effects upon Nervous
 Tissues, 702
Pythium de baryanum, 508
 Pythion, Pentastomum, 200
- Q
- Quekett Microscopical Club, 106, 259, 412,
 546, 819
 Quenching of Bronzes, 268
 Quereigh, E., Gold Tellurides, 557
 — Silver-cadmium Alloys, 123
 — Silver-sodium Alloys, 124
 — Tellurides of Sodium and of Silver, 416
 Queva, C., Anatomical Study of *Azolla*
filiculoides, 490
 Quidor, A., Affinities of Philichthyæ, 47
 Quintaret, G., Abnormality in Snail, 462
- R
- Rabbit, Spirochæt, 369
 Rabbit's Teeth, Development, 186
 Rabies and *Plasmoliphora brassicæ*, Para-
 site, 803
 Racovitz, E. G., Fossil Idoteid, 201
 Radium, Influence on the Development of
Pholas caudata, 462
 — Radiations, Action on Blood, 611
 — Rays, Influence on Ova and Sperms,
 185
 Railliet, A., Ascarids of Carnivores, 361
 Railliet, G., Oxyuris in the Appendix
 vermiformis, 470
 Raphidonema, 70
 Rat, Brown, Parasites of Leucocytes, 633
 — Cartilage in Thymus, 35
 — Plague in East Anglia, 688
 Rat-flea, Cysticeroids, 471
 — New Parasite, 476
 Ravenna, C., Metabolism of Moulds, 79
 Rawitz, B., Preparation of Kaiserling
 Material for Microscopical Purposes,
 703
 Rayleigh, —, Sensibility of the Eye to
 Variations of Wave-length in the
 Yellow Region of the Spectrum, 106
 Rays, Ultra-violet, Action upon Green
 Vanilla-pods, 481
 Rearing Sterile Flies, 261
 Recalescence, Historical Note, 270
 Reconstruction, Modification of Freiburg
 Method of putting on a Directing-
 plane, 549
 — Plastic, Utilising Organized Structures
 as Directing Marks, 116

- Red-snow, 500
 Reed, F. R. C., New Fossil Chiton from Girvan, 615
 Reese, A. M., Development of Enteron in American Alligator, 187
 Reflected Light, Photographing Fossils, 257
 Reflex-camera, Mirror, New, 534
 Regan, C. T., Synopsis of Lampreys, 354
 Regaud, C., Castration by X-Rays, 347
 — Sterilization by X-Rays, 347
 Regeneration and Polarity of Plant-organs, 219
 — in *Chondrosia reniformis*, 56
 — in *Corymorpha*, 210
 — in Nemerteans, 206
 — in Newts, 614
 — in Planarians, 626
 — Precision of in Polynoids, 203
 Reichenow, E., Life-history of *Hæmogrammaria stepanovi*, 771
 Reichert, C., Dark Ground Illuminator with Arrangement for Centring on a Plain Stage, 426
 — New Mirror Reflex-camera, 534
 — Rejtó's Metal-Microscope, 531
 Reichert's Dark-ground Illuminator, with Arrangement for Centring on a Plain Stage, 814
 — New Breath Screen, 408
 — — Metal-Microscope, 532
 Reinecke, G., Study of Polyxenus, 199
 Reinisch, O., Chryomonads, 661
 Reis, C., Development of Teleosts, 187
 Rejtó's Metal-Microscope, 531
 Remy, T., Methods of Agricultural Bacteriology, 521
 Renaut, J., Demonstrating the Presence of Mitochondria in Cartilage-cells, 264
 Renier, A., *Calamostachys ludwigii*, 489
 Reproduction in Paramecium, Effect of Excretion-products on Rate of, 767
 Reproductive Male Organs of Chelifer and Chernes, 467
 — Organs of Domestic Animals, 743
 — Period, Influence of Environment, 738
 Reptiles and Batrachians, Innervation of Heart, 458
 — and Birds, Development of Vertebral Column, 186
 — Hematozoa of Australian, 771
 Reptilian Scales, Evolution, 193
 Respiration and Circulation in *Tipula marima*, 749
 — in *Donaacia* and *Macroplea*, 198
 Retina of Birds, 610
 Retterer, E., Heal Cæcum of Birds, 192
 — Method for Studying Osseous Tissue, 551
 — Red Blood Corpuses of Mammals, 609
 — Tendons of Wing and Leg in Bats, 609
 — Union of Muscle-fibre and Tendinous-fibre, 458
 Reuter, E., Mites and Tumours, 200
 Revis, C., Artificial Production of a permanently atypical *Bacillus coli*, 803
 Reymond, C. du B., Tadpoles with Strongly developed Lips, 745
 Rhinoscleroma, Etiology, 525
 Rhizocephalous Crustacean from Fresh Water, 755
 Rhizome and Root of Delphinium, Splitting, 774
 Rhizopods, Antarctic, 366
 — from Lake District, 475
Rhizopus nigricans, Homothallic Conjugation, 507
 Rhizoxenia and Sarcodictyon, 54
 Rhodophyceæ, 668
 Rhopalocystis, New Genus, 799
 Riboisière, De la, Size of Spleen in Birds, 352
 Ricardo, G., Revision of Oriental Species of Tabanus, 749
Riccia Bischoffii, Structure, 225
 Richards, E. A., *Philonotis seriata* with Fruit, 494
 Richardson, H., New Parasitic Isopod, 755
 — Spiny Terrestrial Isopod, 755
 Richter, O., Nutriment of Algae, 498, 659
 Rick, J., Notes on Geaster, 237
 Ricken, A., German Agaricaceæ, 394
 Riddle, L. W., American Lichen Notes, 519
 — — Species of *Sterocaulon*, 89
 — *Cladonia*, 89
 Ridley, H. N., Ferns of Perak, 778
 Right- and Left-handedness, 192
 Riley, W. A., *Dipylidium caninum* in a Child, 49
 Ringenbach, —, Hematozoa from the Congo, 214
 Riquier, J. K., Reticular Apparatus in Cells of *Corpus Luteum*, 190
 Ritchie, J., *Barentsia benedeni* in British Waters, 762
 — Deep-sea Hydroids of Indian Museum, 52
 Ritter, W., Flying Apparatus of Blow-fly, 618
 Ritter-Zahony, R. v., Chætognatha from Ireland, 203
 — West Indian Chætognatha, 204
 Robertson, M., Cæcal Parasites in Fowls, 632
 Robin, F., Colour Etching of Steel, 561
 — Photo-micrographic Apparatus, 273
 — Resistance of Steels to Abrasion and to Crushing, 714
 Roehaix, A., New Types of Urobacteria, 93
 Rock-section Cutting Apparatus, Improvements, 703
 Rock-sections, Method of Slicing, Grinding and Mounting, 706
 Roehrich, O., New Species of Aleyonidium, 51

- Rogers, C. G., Effects of Starvation on *Necturus maculatus*, 613
- Röll, J., Adalbert Geheeb, 69
- Moss-flora of South Thuringia, 67
- Mosses of the Erzgebirge, 656
- Sphagnaceæ of the Rhöngebirge, 382
- Variable Leaf-border in *Fissidens*, 492
- Rolle, H., Abnormal Shells of *Achatina*, 196
- Romanowsky Staining, Apparatus, 550
- Romeis, B., Washing and Dehydrating Apparatus, 822
- Romieu, M., Plasmic Reduction in Spermatogenesis, 454
- — — — — of *Ascaris megaloccephala*, 625
- Root-diseases, Parasitic of Juncaceæ, 670
- Root-nodules of Cycads, Occurrence of Phagocytosis, 60
- Root-tubercles, Fungus, 237
- Roots of Conifers, Anatomy and Morphology, 371
- Reduction, 483
- Rorrer, G. B., Green Muscardine of Frog-hoppers, 673
- Rosaceæ, "Hypanth." 640
- Rose, L., Mycological Flora of Oak-tree Slime-flux, 516
- Rose-coral, Feeding Reactions, 53
- Rosenberg, F. T., Development of the Limbs in Grebes, 345
- Rosenblat, S., Methods of Staining Tubercle Bacilli, 550
- Rosenburgh, C. R. W. K. v. A. v., Malayan Ferns, 491
- Rosenhain, W., Alloys of Aluminium and Zinc, 711
- Rosenstadt, B., Protoplasmic Fibres in Epidermic Cells, 189
- Rösing, G., Methods of Agricultural Bacteriology, 521
- Roseter, T. B., New Tapeworm from a Duck, 471
- Rossi, L., Ferns of South Croatia, 222
- Roth, G., Andreaeaceæ, 65
- Illustrations of Exotic Mosses, 227, 381
- New and Rare European Mosses, 67, 227, 494
- Rotifera, Australian: Collected by the Shackleton Antarctic Expedition, 1909, 164, 284
- Bdelloid: a New Classification, 207
- Canadian: Collected by the Shackleton Antarctic Expedition, 1909, 285, 424
- Clare Island, 763
- Histology, 362
- Methods of Studying, 110
- New, 763
- of German East Africa, 208
- of New Zealand and South Africa, 572
- — — — — Collected by the Shackleton Antarctic Expedition, 1907-9, 573
- Rotifera, of some Pacific Islands: Collected by the Shackleton Antarctic Expedition, 1909, 427, 429
- South African: Collected by the Shackleton Antarctic Expedition, 1907- , 584
- See CONTENTS
- Rotifers, African; Bdelloids of Tropical Africa, 1
- Clare Island, 627
- Some African, Bdelloida of Tropical Africa, 129
- Roubaud, E., Leptomonad in Euphorbias, 367
- Oviparity and Viviparity in Dung-fly, 198
- Roudsky, D., Natural Immunity of White Mice to *Trypanosoma lewisi*, 459
- Rousselot, C. F., 130, 835
- Clare Island Rotifera, 763
- Microscope, Old, by A. Pritchard, 835
- New Rotifera, 763
- Old Microscope by J. Simons, 276
- Roviroso, J. N., Ferns of South Mexico, 63
- Rubber, Crude, Film Test, 416
- Rubinsky, B., Micro-organisms in Koumiss, 92
- Rückert, J., Polyspermy, 185
- Ruer, R., Iron-carbon System, 826
- Iron-nickel System, 126
- Rulings, Grayson's presented by Mr. C. Beck to the Royal Microscopical Society, Report, 421, 449
- Ruminants, Cutaneous Scent-glands, 351
- Rungius, H., Alimentary Canal of *Dytiscus*, 748
- Russ, E. L., Head-glands of Caddis-worms, 44
- Russ, S., Action of Radium Radiations on Blood, 611
- Russell, T. H., British Mosses and Liver-worts, 227
- Rusts of Cereals, 80
- Rutherford, N. C., Modification of the Freiberg Method of putting on a Directing-plane (Richtungs-Ebene) for Reconstruction, 549

S

- Sabouraud, R., Filtering by Aid of the Centrifuge, 267
- Sabraçes, J., Staining Blood-films, 264
- Saccus vasculosus in Fishes, Structure and Function, 194
- Saffron in Histological Technique, 414
- Sala, L., Distribution of the Muscle-fibres in Heart of Fishes, 741
- Salamander, Alpine, Development, 187
- Study of Chromosomes, 457
- Salamandrella kayserlingii*, Development of Limbs, 35

- Salimbeni, —, Resistance to passage of Microbes through Collodion Filters, 548
- Salivary Glands of Ticks, Examining, 109
- Salvo hucho*, Growth, 38
- Salmon Disease, Myxonema in, 663
- Salts, Alkaline Earth, Absorption by Plants, 218
- Metallic Fog in Fused Salts, 828
- Salvinia natans*, Life-history, 645
- — Spore-development, 490
- Samsonow, N. and another, Threads and Granules in the Cytoplasm, 189
- Sangiorgi, G., Mouse Epizootic due to a Coliform Bacillus, 246
- Sanzo, L., Cutaneous Papillæ in Gobius, 741
- Sap-flow and Transpiration, Living Cells in Relation to, 482
- Sapelin, A. A., Crimean Mosses, 637
- Mosses of the Crimea, 382
- South Russian Mosses, 229
- Saprolegnia, Notes, 234
- Saprophytism of Enteromorpha, 231
- Sarcina Citrea conjunctivæ*, 688
- Sarcocystis muris*, Development, 771
- Sarcodietyon and Rhizoxenia, 54
- Sartory, A., Pathogenic Fungi, 798
- Sasaki, C., Life-history of *Schlechtendalia chinensis*, 465
- Saunders, J., Distribution of Mycetozoa in the South Midlands, 401
- Sauveur, A., Apparatus for Microscopical Examination of Metals, 561
- Scales, F. S., 140, 282, 283, 284, 571, 834, 837
- Variable Eye-piece by M. J. Allan, 570
- Scales from *Thermobia domestica*, Structure, 717
- of Fishes, 38
- Reptilian, Evolution, 193
- Structure, from *Thermobia domestica*, 572
- Scalpellum and Ibla, Development and Minute Structure, 755
- Scarlet-fever Virus, 804
- Scelionid Parasite of Spider's Eggs, 41
- Scent-glands, Cutaneous, of Ruminants, 351
- Schaffer, J., Chordoid Tissue, 188
- Post-Natal Remains of the Notochord in Mammals, 603
- Schaffuit, E., Apparatus for Microscopical Observation of Frozen Objects, 693
- Simple Washing Apparatus, 702
- Schaxel, J., Cytoplasm, Chondriosomes, and Chromidia, 609
- Early Stages of Development in Echinoderms, 363
- Oogenesis in Pelagia, 473
- Scherffel, A., Raphidionema, 70
- Schiffnerlecker, P., Muscles of Lamprey, 611
- Schiffner, V., Amphigastrical Antheridia in some Ptilidioid Hepaticæ, 224
- Bryological Notes, 65
- Critical Forms of Aplozia, 225
- *Metzgeria*, 781
- and others, Hungarian Bryophytes, 229
- Schikorra, W., Development of Monascus, 77
- Schiller, J., Life-history and Physiology of Nueleï, 478
- Schilling, C., Apparatus for Romanowsky Staining, 550
- Schimkewitsch, L., and W., Development of *Ischnocolus*, 621
- Development of Tetrapneumones, 466
- Schizæopsis expansa*, a Fossil Fern, 489
- Schizomyces. See CONTENTS
- Schizophyta. See CONTENTS
- Schizopods from North-east Atlantic Slope, 359
- Schlechtendalia chinensis*, Life-history, 465
- Schlegel, C., Development of *Maia squinado*, 753
- Schlesinger, G., Electric Eels, 354
- Schlumberger, O., Relation of Woodsiææ to Cyathæacæ and Polypodiaceæ, 486
- Schmalhausen, J. J., Development of Limbs in *Salamandrella kayserslingii*, 35
- Schmaltz, R., Reproductive Organs of Domestic Animals, 743
- Schmidt, J., New Records of Hamburg Mosses, 67
- Schmidt, W., Mechanism by which Fern Fronds roll up, 378
- Schneider, K. C., Study of Chromosomes in Salamander, 457
- Schoen, M., Action of Proteolytic Diastases, 642
- Schoenau, K. v., Branch-formation in Mosses, 651
- Schols, C., Influence of Silicon on the Maximum Solubility of Carbide of Iron in γ -iron, 126
- Schorstein, J., Wood-destroying Fungi, 237
- Schouten, S. L., Pure Cultures from a Single Cell, 819
- Schreiner, O., Reduction by Roots, 483
- Schridde, H., Fixation and Embedding of Embryological Material, 111
- Schröder, O., New Mesozoon, 51
- Schroeder, H., Permeability of the Sheath in Wheat-grains, 612
- Schutshelkanowzew, J. P., Male Reproductive Organs of Chelifer and Chernes, 467
- Schuberg, A., Dissemination of Disease by *Stomoxys calcitrans*, 463
- Schulz, H., Glass Polarizing Prisms, 697
- Schulze, E., Carbohydrates in Seeds, 480
- Schultze, O., Direct Connexion between Muscle-fibrils and Tendon-fibrils, 348
- New Methods of Histological Technique, 549

- Schultze, O., Origin of Granules in Gland Cells, 349
- Schultze, W. H., Oxidizing and Reducing Properties of Bacteria, 244
- Schussnig, B., *Gonium pectorale*, 501
- Schüz, E., Iron-nickel System, 126
- Schwangart, —, Grape Moths, 461
- Schwartz, E. J., Life-history of *Sorosphaera graminis*, 685
- Parasites on the Roots of Juncaceæ, 90
- *Sorosphaera*, 520
- Sclerospora, Biology, 234
- Sclerotinia as a Plant-disease, 670
- Scorpena, Direct Division of Red Blood Corpuscles, 35
- Scorpions, False, of British Isles, 559
- Scott, D. H., Studies in Fossil Ferns, 61
- Scurfield, D. J., 133
- Screen, Breath, Reichert's New, 408
- Screw Threads, Objective, Anomalies, 175, 283
- Scriban, J. A., Adipose Cells of *Pontobella muricata*, 624
- Scutigera coleoptrata*, Habits, 752
- Scyphistoma, Fixation, 473
- Sea-bottom, Animal Life, 741
- Sea-side Plants, Anatomical Researches, 216
- Sea-urchin Ova, Extra-ovate Experiments, 363
- Seaver, F. J., North American Fungi, 392
- Seaweeds, Analysis, 231
- Sections, Celloidin Serial, New Method of making, 116
- of Urinary Calculi, Method of Obtaining, 263
- Paraffin, Manipulation, 113
- Seedling Development, Effect of Injury to Cotyledons, 60
- Seeds, Carbohydrates, 480
- of European Papaveraceæ, 218
- Segregation, Influence on the Strength of Mild Steel, 270
- Selaginella, Spore-distribution, 646
- Selenium-antimony System, 826
- Selenococcidium and the Relationships of the Sporozoa, 213
- Seminal Fluid in Man, Nature, 608
- Senescence in Hydroids, 211
- Senn, G., Studies on Flagellates, 634
- Sense of Direction in Blind, 612
- Sensilli and Eyes of Medicinal Leech, 203
- Septobasidium, Note on the Biology, 676
- Sevastos, R., Fossil Idoteid, 201
- Sex Characters, Secondary and Interstitial Testicular Cells, 348
- Determination of, President's Annual Address, 138, 141
- of Offspring, Effects of One-sided Ovariectomy, 454
- Origin, 454
- Sex-determination in Daphnids, 757
- Sexton, E. W., Genus *Leptocheirus*, 754
- Sexuality among the Mosses, 651
- Sexuality of Uredineæ, 792
- Seymour-Jones, A., Anthrax Sterilization Process applied to Hides in Dry State, 266
- Shackleton Antarctic Expedition, 1907, South African Rotifera Collected by, 584
- — — 1907-9, Rotifera of New Zealand, Collected by, 573
- — — 1909, Australian Rotifera, Collected by, 161
- — — — Canadian Rotifera, Collected by, 285
- — — — Rotifera of some Pacific Islands, Collected by, 429
- Shaker, Simple, 111
- Sharp, L. W., Nuclear Phenomena in *Puccinia podophylla*, 675
- Shattock, S. G., Method of Obtaining Sections of Urinary Calculi, 263
- Microscopic Structure of Uric Acid Calculi, 258
- Shaw, T. W. A., Solubility of Oxygen in Molten Silver, 125
- Shearer, C., Development of Trochophore of Hydroides, 360
- Sheep's Abomasum, Protozoon Parasite from Mucous Membrane, 57
- Shelford, R., Blattidæ in Amber, 465
- Shell, Molluscan, Layers, 746
- Shells, Abnormal, of *Achatina*, 196
- Sheppard, E. J., The Re-appearance of the Nucleolus in Mitosis, 423, 598
- Shibata, K., Chemotaxis of Fern-spermatozoids, 379
- Shipley, A. E., New Pentastomid, 468
- Shoebotam, J. W., New Collembola in England, 620
- Show-cases for Instruments, 284
- Shreve, P., Hymenophyllaceæ in Relation to Moisture, 487
- Shrew-mole, Food, 352
- Habits, 352
- Sidebottom, H., New Species of *Cassidulina*, 212
- Sieglbauer, F., Development of the Extremities of Birds, 345
- Sieverts, A., Behaviour of Copper towards Gases, 268
- Silicides, Metallic, 125
- Silicon Alloys with Metals, 712
- Influence on Cast Iron, 272
- — — on the Maximum Solubility of Carbide of Iron in γ -Iron, 126
- Silkworms, Moulting, 748
- Silver and Gold, Alloys of Sodium, 556
- and Sodium Tellurides, 416
- and Tin, Amalgams containing, 557
- Bismuth and Aluminium, Effect of upon Copper, 418
- Molten, Solubility of Oxygen, 125
- with Cadmium, Alloys, 825

- Silver-cadmium Alloys, 123
 Silver-copper Alloys, 124
 Silver-sodium Alloys, 124
 Silver-tin-lead, Ternary System, 556
 Silvestri, F., New Termitophilous Staphylinid, 41
 Simon, J., Old Microscope made by, 276, 528
 Sinking-velocity of Plankton Organisms, Simple Arrangement for Determining, 122
 Sinnott, E. W., Evolution of the Filicenean Leaf-trace, 376
 Siphon, Self-regulating, 267
 Skeleton, Sheep's, Influence of Malnutrition and Castration on Development, 186
 Skin-pigmentation, Inheritance in Man, 30
 Skull of Turtle, Development, 605
 Slag, Blast-furnace, Microscopical Examination, 275
 — in Steel, 271
 Sleep, Physiology, 459
 Sleeping and Waking, 611
 — Sickness, Inquiry, 476
 — — Transmission, 770
 Slicing, Grinding and Mounting Rock-sections, Method, 706
 Slides, New System of Filing, 129
 — Typical, proposed Collection, 138
 — See CONTENTS,
 Sluiter, C. P., *Chara contraria* and *C. dissoluta*, 69
 — West Indian Holothuroids, 209
 Smalley, F. W., Colour Inheritance in Pigeons, 738
 Smallwood, W. M., Effects of Starvation on *Necturus maculatus*, 613
 Smith, A. L., West of Ireland Lichens, 800
 Smith, E. F., *Bacterium tumefaciens*, 803
 Smith, G., Fluctuations in Growth of Fowl's comb, 604
 — Injection of Testis-extract into Hens, 348
 Smith, J. H., Fatigue of Metals, 274
 Smith, J. L., Staining of Fats, 549
 Smith, T. J., Models of Microscopic Fields of Bacteria, prepared by Dr. Chas. Leo, Birmingham, 426
 Smut Fungi, 675
 — New, in a New Genus of Grass, 793
 Smut-infection Experiments, 676
 — Study, 235
 Smuts of Australia, 81
 Snail, Abnormality, 462
 — Hibernating, Beating of the Heart, 462
 — Reduction in the Spermatogenesis, 462
 Snake, Grass, Blood-formation, 188
 Snake-poison and Yolk of Egg, 613
 Snow, J. W., Two Epiphytic Algae, 501
 Sour, C. D., Hydraclnids of East African Lakes, 200
 Sobotta, J., Early Development of White Mouse, 603
 Sobotta, Y., Coloured Plates of Microscopical Preparations, 258
 Sodium, Alloys with Silver and Gold, 556
 — and Silver Tellurides, 416
 Soil, Frozen, Bacteria, 92
 Sokolow, I., New Species of *Ctenodrilus*, 625
Solaster endeca, 268
 Sollas, I. B. J., Parasitic Castration of Earthworms, 360
 Sollaud, E., *Palæmon niloticus* in Lake Tchad, 753
 — Primitive Fresh-water Prawn, 754
 Solowiov, P., Tapeworms of Birds, 760
 Somerville, A. A., Temperature Coefficients of Electrical Resistance, 274
 Sommerfeldt, E., New Method for Microscopical Metallography, 253
 — Recent Progress in the Construction of Mineralogical and Metallurgical Microscopes, 693
 Sorensen, W., Fruit of Geraniaceæ, 641
 Sorosphæra, 520
 — *graminis*, Life-history, 685
 Southern, R., Pelagic Polychæts of Irish Seas, 360
 Southwell, T., Avicula and Gorgonid Association, 463
 — New Cestodes from Ceylonese Fishes, 471
 — Pearl-inducing Parasite, 470
 Spaulding, P., Fungi in Clay Mines, 397
 Spectral Apparatus, Leiss' Universal, 694
 Speer, J. M., Inflorescence of *Funaria*, 492
 Spence, S., Spores, 647
 Sperm Transfer in Certain Decapods, 753
 Spermaceti-organ of *Kogia breviceps*, 37
 Spermatogenesis in certain Hepaticæ, 652
 — in Currant-moth, 357
 — in Lepidoptera, 43
 — in the Bryophyta, 653
 — of *Ascaris megalocephala*, Plasmic Reduction, 625
 — of Lepidosiren, 608
 — of *Stenobothrus viridulus*, 617
 — of the Snail, Reduction, 462
 — Plasmic Reduction, 454
 Spermatozoon, Mammalian, 30
 Sperm and Ova, Influence of Radium Rays, 185
 Sphærospideæ, 672
Sphærotheca castagnei, 791
 — *mors-uvæ*, *Cicinnobolus* sp. Parasitic, 392
 Sphagnaceæ, Nomenclature, 653
 — of the Rhöngebirge, 382
 Sphagnum, North American, 782
 Sphegideæ, Study, 357
 Spicules, Hexactinellia, 212
 Spider's Eggs, Scelionid Parasite, 41
 — Male, Palpi, 44
 Spillman, L., Elimination by Leucocytes, 195

- Spindle-cells of Amphibian Blood, 740
 Spindler, M., *Hygrohypnum ochraceum*, 493
 Spiro, J., Alimentary Canal of *Helix pomatia*, 747
 Spirochaeta from Rabbit, 369
 Spirochaeta and Cristospira, 58
 — *pallida*, Cultivation, 820
 — — New Method of Demonstrating, 118
 Spirochaetes, Cultivation, 819
 — New and Quick Method of Staining in Smear Preparations, 265
 Spirochaets, Affinities, 369
 — of the Mouth, 369
 Spirogyra, 665
 — from the neighbourhood of Besançon, 389
 — Periodicity, 231
 Spiroplasmaeae, Free-living, 772
 Spirophyllum ferrugineum, 686
 Spitta, E. J., 281, 282, 421, 423, 571, 837, 857
 — A Report on the Grayson's Rulings presented by Mr. C. Beck to the Royal Microscopical Society, 421, 449
 — Diameter of the Disk of Confusion, 282
 — Low-Power Photomicrography, with special Relation to a Colouring Method for Tinting Lantern Slides, 419
 Splachnobryum in Greenhouses, 383
 Spleen in Birds, Size, 352
 — in Embryo Bird, Haemopoietic Function, 460
 Sponge, New Lithonine, from Christmas Island, 631
 — Phaneronid, Remarkable, 365
 Sponges associated with Vermetidae, 766
 — Degenerative Changes, 630
 — from Dissociated Cells, Development, 766
 — Pharetronid, of Eßen Greensand, 631
 Spongilla carteri, Oligochaet Commensals, 469
 Spongospora subterranea, 401, 685
 Spore-development in *Salvinia natans*, 490
 Spore-distribution in Selaginella, 646
 Spore-formation in Nidularia, 794
 Spores, Development in *Pleurage zygospora*, 674
 — Ergot, Infection by, 791
 — in *Aspergillus niger*, Influence of Iron on the Formation, 79
 — of Spencerites, 617
 Sporotrichum beurnmanni in Man, 404
 Sporozoa, Relationships, and Selenococci-dium, 213
 Sports, Mammalian, 348
 Spratt, E. R., Life-history of *Anabæna cycalæx*, 663
 Spulski, B., New Species of Odonopteryx, 613
 Sputum, New Method for the Detection of Tubercle bacilli, 823
 Stach, J., Development of Rabbit's Teeth, 186
 Staff, F., Development of *Criodrilus lacuum*, 202
 Stag-beetles, New, 748
 Staining and Fixing, Simultaneous, 702
 — Blood-films, 264
 — Bordered Pits, 709
 — Celloidin Sections of Nervous Tissue by the iron-haematoxylin Method, 119
 — Chromatin, New Method, 414
 — in bulk with Haematoxylin, 118
 — Iodine, Improve 1 Method, 551
 — Methods, Combined, for Tubercle bacilli, 118
 — of Bacteria, Negative, 823
 — of Fats, 549
 — of Glycogen, Fixation, 824
 — Rapid, with Giemsa's Azur-eosin Solution, 414
 — Romanowsky, Apparatus, 550
 — Spirochaetes in Smear Preparations, New and Quick Method, 265
 — the Internal Network in Nerve-cells, 119
 — the Medullary Sheath in Brain-sections, 120
 — Tubercle Bacilli, Methods, 550
 — Use of Pieramic Acid, 118
 — Objects. See CONTENTS
 Standard Thread, The Society's, 537
 Stands, Microscope. See CONTENTS
 Staniewicz, W., Fat in Ciliated Infusorians, 212
 Stapely, W., Guttural Pouches of Horse, 37
 Staphylinid, Ceylonese, Buccal Parts, 619
 — New, Termitophilous, 41
 Starch in a Leaf, Demonstrating Presence, 263
 — Removal through the Petiole, 373
 Starch-grains and Oil-drops in Conifer-wood, 638
 Starches, Principal, used as Food, 701
 Stareke, A., Preserving Brains, 824
 Starfish, Seasonal Retrogression of Ovaries, 52
 Starfishes, New, 209
 Starvation, Effects on *Necturus maculatus*, 613
 — — on Planarians, 627
 Statoblasts of Bryozoa, Development, 210
 Stawska, B., Toxins and Antitoxins, 744
 Stead, D. G., Fisheries of New South Wales, 195
 Stead, J. E., Welding up of Blowholes and Cavities in Steel Ingots, 713
 Steche, O., Law of Budding in "Portuguese Man-of-War," 473
 Steel, Action of Mercury at High Pressures, 272
 — and Iron, Commercial, Gases in, 270
 — Annealing, 559

- Steel, Cementation, 269
 — Colour-etching, 561
 — Crystallization, 828
 — Influence of Nitrogen on Cementation, 558
 — — of Vanadium on Iron and, 827
 — Ingots, Welding up of Blowholes and Cavities, 713
 — Internal Structure of Pearlite, 828
 — Mild, Influence of Manganese, 558
 — — Influence of Segregation on the Strength, 270
 — Nickel, Changes occurring in, 713
 — Slag, 271
 — Wire, Effect of Galvanizing on Strength, 559
 Steels, Alloys, Cementation, 713
 — Carbon, Theory of Hardening, 271
 — Chromium, 827
 — Magnetic Properties of Nickel, 827
 — Nickel, 827
 — Resistance to Abrasion and to Crushing, 714
 Stehli, G., Evolution of Reptilian Scales, 193
 Steinbrinck, C., Desiccation-phenomena in Mosses, 381
 Steiner, J., Lichens in Italy, 801
 Steinmann, P., Regeneration in Planarians, 626
 — Revision of Swiss Triclad, 627
 Stele, Development in Dipteris, 644
 Stelfox, A. W., Molluscs of Ireland, 356
 Stems, Effect of Longitudinal Compression upon the Production of Mechanical Tissue, 373
Stenobrothus viridulus, Spermatogenesis, 617
 Stephani, F., *Goebeliella*, a New Genus, 655
 — Species *Hepaticarum*, 227
 — and others, Bryophyta of German Central Africa, 496
 Stephenson, J., *Bothrioneurum iris*, 469
 — Littoral Oligochaeta of the Clyde, 758
 — Nemertines of Millport, 761
 — Oligochaet Commensals in *Spongilla carteri*, 469
 Stereo-photomicrography, Sliding Nose-piece for use in, 95
 Stereocaulon, American Species, 89
 — Systematic Position, 519
 Stereoscope, Phenomena of Visual Inhibition which may accompany the re-association of the two Retinal Images dissociated by the Prisms. Conditions and Determination of these Phenomena, 410
 Stereoscopic Illusion, 411
 — Photomicrography, 816
 Sterility, 30
 Sterilization by X-Rays, 347
 Sterilization Process, Anthrax, applied to Hides in Dry State, 266
 Sterling, S., Musculature of Pectoral Girdle and Flipper in Cetacea, 132
 Stevens, F. L., Diseases of Economic Plants, 84
 Stewart, F. H., Development and Minute Structure of Scalpellum and Ibla, 755
Stichococcus bacillaris, 387
 — — Effect of Coloured Light, 387
 Stiles, M. H., Algae of the Sheffield District, 230
 Stilesia and its Relatives, 362
 Stipes of Fossil *Asterochlæna*, 61
 Stirton, J., New Scottish Mosses, 228
 Stole, A., Encystation in *Pelomyxa*, 631
 — Studies on *Pelomyxa*, 631
Stomoxys calcitrans, Dissemination of Disease by, 463
 — Oriental Species, 618
 Strachan, J., On the Structure of Scales from *Thermobia domestica* (Packard), 572, 717
 Stratiomyidæ, Post-embryonic Development, 199
 Strecker, F., Simultaneous Fixing and Staining, 702
 Strecker, J. K., Notes on the Robber Frog, 460
 Streeter, E. C., Bacillus of Acne, 262
 Strephonema, Remarks, 485
 Streptococcus and Pneumococcus, Virulence, 245
 Streptothrix, Anaerobic, 803
 Streptotrichæ, Presence in Tuberculous Sputum, 522
 Stresses in Cold-worked Metals, 562
 Strickland, C., Development of *Trypanosoma lewisi* in Rat- flea, 58
 — Parasites of Biliary Fever in Horses, 369
 Stromberg, H., Change of Biological Characters in Bacteria, 522
 Stromer, E., Fossil Lepidosirenidæ, 460
 Stromsten, F. A., Lymph-hearts of Turtles, 455
 — Structure and Development of Posterior Lymph-hearts of Turtles, 346
Strongylus pingvicola, 205
 Structural Analogy, Interesting, 191
 Structure of Seed Plants, Reproduction. See CONTENTS
 — — — Vegetative. See CONTENTS
 — of Yeast-Cell, Demonstrating, 262
 Sub-microscopic Structures, Methods for the Identification, 810
 Suctoria, New Type, on a Copepod, 477
 Suctorial Disks of Male Dytiscids, 198
 Sulc. K., Symbiosis of Yeasts and Insects, 616
 Sullivan, M. X., Reduction by Roots, 483
 Sulphur, Influence on the Iron-carbon System, 418

- Sulphurous Acid as an Etching Medium, 273
- Summers, S. L. M., Oriental Species of *Stomoxys*, 618
- Sumstine, D. R., Studies in North American Hyphomycetes, 510
- Sun-fish, Large, 195
- Sunier, A. L. J., Development of Myotomes, 710
- Surface, F. M., Inheritance in Hybrid Poultry, 34
- — of Colour Pattern in Hybrid Poultry, 34
- Surirella elegans*, Method of Locomotion, 132
- Locomotion, 384
- Svedelius, N., Erythrocladia, 787
- Rhodophyceæ, 668
- Swarzewsky, B., Lankesteria, 477
- Swartzia inclinata* in Lancashire, 654
- Sweet, G., Blood Parasites, 57
- Microfilaria in Magpies, 48
- New Nematode in Eye of Queensland Fowl, 48
- — Species of Argas, 45
- — Tapeworm in Chicken, 49
- Swellingrebel, N. H., Development of *Trypanosoma lewisi* in Rat Flea, 58
- Swim-bladder, Function, 194
- of Teleosts, 461
- Sydow, H. and P., and others, Sphæropsideæ, 672
- — Uredineæ, 235
- Symbiosis of Yeasts and Insects, 616
- Synapsis of the Nucleus, 478
- Synchytrium-galls, Study, 76
- Szűcs, J., Permeability of Protoplasm, 773
- T
- Tabanids and Trypanosomes, 749
- Tabanus, Revision of Oriental Species, 749
- Tadpoles of *Alytes* and *Rana*. Lateral Line System, 614
- Thread-like Structures in Epidemic Cells, 189
- with Strongly-developed Lips, 745
- Tait, W. H., Self-regulating Siphon, 267
- Tammann, G., Alloys of Lithium, 123
- Changes in Properties of Metals upon Working, 828
- Limits of Elasticity and the Hardening of Metals, 562
- Tapeworm, New, from a Duck, 471
- — in Chicken, 49
- Tapeworms, Alleged Toxicity, 626
- from Mammals, 760
- of Birds, 760
- of South American Feline, 49
- Tardigrada, Antarctic and other, 359
- Notes, 468
- Tarsonemidæ, Monograph, 752
- Taste, Muddy, in Fresh-water Fishes, 37
- Tattersall, W. M., Schizopods from North-east Atlantic Slope, 359
- Taute, M., Trypanosome Studies, 476
- Tavanti, G., Malleable Cast-iron, 559
- Tavel, F. v., Mutations of *Asplenium rutamuraria*, 379
- Taylor, T. G., Archæocyathinæ, 56
- Tea, Presence of Yeast, 392
- Technique. See CONTENTS
- Teeth and Buccal Structures in *Conulus*, 209
- of Two Dentitions in a Dermoid Cyst, 604
- Rabbit's, Development, 186
- Teleostean Embryos, Development of Pigment-cells, 187
- Ova and Larvæ, 35
- Teleosts, Pectoral Girdle and Fins, 195
- Teleosts, Development, 187
- Swim-bladder, 461
- Tellurides, Gold, 557
- of Sodium and of Silver, 416
- Tellurium Alloys, 416
- Tend-Band Plate, Grayson's New, Measurement, 160
- Tench, Grouping of Nerve-cells in Spinal Cord, 610
- Tendon-fibrils and Muscle-fibrils, Connection, 348
- Tendons of Wing and Leg in Bats, 609
- Tennent, D. H., Echinoderm Hybridization, 363
- Structure of *Pentaceros reticulatus*, 364
- Termite Communities, Rhythms, 463
- New Microsporidian, 58
- Termites and Fungi, 397
- Ternary Systems, 269, 561
- Testes, Functioning, Abnormal Bone-growth in Absence of, 186
- Testicular Cells, Interstitial, and Secondary Sex Characters, 348
- — — Role, 740
- Testis-extract, Injection into Hens, 348
- Tetrapneumones, Development, 466
- Thalassicolla, Vegetative and Reproductive Processes, 475
- Thalheimer, W., New Method for Making Blood-agar for Cultivating *Bacillus influenzae*, 820
- Thallophyta. See CONTENTS
- Thaxter, R., Notes on Chilian Fungi, 395
- Theiler, A., Transmission of Amakebe by Brown Tick, 622
- Theissen, F., Myco-geography, 237
- Thermo-electric Forces of Solid Solutions, 560
- Thermobia domestica*, On the Structure of Scales, 572, 717
- Thermobiosis, 403
- Thoday, M. G., Medulla-cells of Laminariaceæ, 504

- Thomas, H. H., Leaves of Calamites, 188
 Thomas, J. T. N., *Aulacodiscus superbus*, 571
 Thomson, A. L., Migration of Birds, 743
 Thomson, J. A., Australian Alcyonarians, 364
 — Outlines of Zoology, 39
 — The President's Address: The Determination of Sex, 141
 Thorsphæra, 71
 Thread, Society's Standard, 537
 Thrips, Study, 750
 Thymus of Rat, Cartilage, 35
 Thyroscyphus, Structure and Affinities, 630
 Tick, Brown, Transmission of Amakebe, 622
 Ticks, Examining Salivary Glands, 109
 — Salivary Glands, 45
 Tilden, J. E., Myxophyceæ, 233
 Tilho, —, *Palæmon niloticus* in Lake Tchad, 753
Tilletia horrida in Rice-meal, 510
 Tillyard, R. J., Experiments with Dragonfly Larvæ, 750
 Tin and Silver, Amalgams containing, 557
 — Arsenides, 825
 — Flow-pressure, 557
 — Lead, and Antimony, Ternary Alloys, 556
Tipula maxima, Respiration and Circulation, 749
 Tison, A., Gnetales as Apetalous Angiosperms, 372
 — New Genus of Plasmodiophoraceæ, 243
 — — Research on Plasmodiophoraceæ, 685
 — Research on Chlochytriaceæ, 233
 Tissues, Animal, Artificial Cultivation, 107
 — — Reduction and Oxidation, 614
 — Culture outside the Organism, 188
 Toad, Artificial Parthenogenesis, 454
 — Experimentally Induced Parthenogenesis, 454
 Toad's Egg, Artificial Parthenogenesis, 454
 Tobler, F., *Codium tomentosum*, 666
 — Epiphytes of the Laminariæ, 386
 — Improved Method of Iodine Staining, 551
 — Nutrition of Lichens, 518
 Törne, O., Suctorial Disks of Male Dytiscids, 198
 Toldt, K., Different kinds of Hair, 742
 Tollinger, A., Geographical Distribution of Diatomidæ, 201
Tolypella intricata, 669
 Tomenthypnum, a new genus, 655
 Tomopteris, Structure, 758
 Toni, G. B. De, Clathrocystis, 788
 Tool-steels, Carbon and Low-tungsten, Hardening, 271
 Topsent, E., Classification of Halichondrina, 766
 Torka, V., and others, German Bryophytes, 494
 Torrend, C., *Punctularia tuberculosa*, 81
 Torrey, H. B., Effect of Light on Obelia, 212
 — Geotropism in Corymorpha, 211
 — Regeneration in Corymorpha, 210, 365
 — Senescence in Hydroids, 211
 Toxæmia, Acute Intestinal, in Infants, Morphology of Organisms concerned in the Production, 280
 Toxins and Antitoxins, 744
 Toyofuku, T., Cartilage in Thymus of Rat, 35
 Tracy, H. C., Directive Markings of Passerine Birds, 352
 — Swim-bladder of Teleosts, 461
 Transpiration and Sap-flow, Living Cells in Relation to, 482
 Traumatism in Relation to New Plant-forms, 485
 Trautman, C., Mosses of Tirol, 657
 Travis, W., Microscope Lamp, 128
 Trawinski, A., Penis of Drake and Gander, 353
 Treasurer, Cash Statement, 137
 Trees, Research on Diseases, 397, 677
 Trematodes from Tortugas, 205
Treponema pallidum, Cilium, 633
 "Trichites" in Didinium, 632
 Trichonympha, New, 477
 Trichoptera, Protist Parasites from Intestine, 57
 — Protozoan Parasites, 476
 Triclads, Swiss, Revision, 627
 Triepel, H., Model of the Vibration-planes of Light in the Polarizing Apparatus, 698
 Tritoniadæ and Æolididæ, Blood-vessels, and Nerves, 196
 Trochophore of Hydroides, Development, 360
 Trojan, E., Glands and Luminescence of Phyllirhœe, 196
 Troostite, 827
 Trophospongia and Chromidia, 457
 Tronessart, E. L., European Mammals, 36
 — Origin of Domestic Dog, 743
 Trout, Colouring, 739
 — Early Development, 607
 True, F. W., Beaked Whales, 192
 Trusehel, —, Sense of Direction in Blind 612
Trypanosoma Brucei, Developmental Forms, 770
 — *eransi*, 771
 — *gambiense*, Life-history, 770
 — *levisi* in Rat-flea, Development, 58
 — — Natural Immunity of White Mice, 459
 — *navium* (Laveran), 770
T. rhodesiense, Life-history, 770
 — *rotatorium*, 476

- Trypanosome and Leptomonad in Drosophila, 368
 — New, 770
 — Studies, 476
 Trypanosomes, Agglutination, 824
 — Frog, in Japan, 632
 — in Fresh-water Fishes, 632
 — in Mammals, Classification, 632
 — Studies, 213, 769
 — Tabanids and, 749
 Trypanotoxin of *Bacillus subtilis*, 522
 Tschirwinsky, N., Influence of Malnutrition and Castration on Development of Sheep's Skeleton, 186
 Tubercle Bacilli, Combined Staining Methods, 118
 — — Human and Bovine, Cultivation, 107
 — — in Sputum, New Method for the Detection, 823
 — — Methods of Staining, 550
 — — Penetration of the Normal Skin by, 803
 — Human and Bovine, 686
 Tuberculosis, 523
 — Mammalian and Avian, Relation between, 93
 Tubef, — v., and others, Uredineæ, 510
 Tubef, C. v., Wintering of Plant-parasites, 83
 — — Witches-brooms on Firs, 83
 Tubularia, Polarity, 765
 Tumour-cells, Nuclear Budding, 438
 Tumours and Mites, 200
 Tunicata. See CONTENTS
 Tur, J., Influence of Radium on the Development of *Pholas candida*, 462
 Turbellarian, New Commensal, 206
 Turbidometer for Counting Vaccines, 824
 Turner, T., Influence of Silicon on Cast Iron, 272
 — Shrinkage of the Antimony-lead Alloys, 418
 Turtle Skull, Development, 605
 Turtles, Lymph-hearts, 455
 — Structure and Development of Posterior Lymph-hearts, 316
 — Sympathetic Nervous System, 605
 Twiss, W. C., *Erythrophyllum delesserioides*, 504
 Twort, C., Trypanotoxin of *Bacillus subtilis*, 522
 Twort, F. W., Jöhne's Bacillus, 94
 — Method of Isolating and Growing the Lepa Bacillus of Man, 107
 Typhoid and Dysentery Bacilli, Variations, 526
 — and Paratyphoid Bacilli, Modified Method of Isolating, 108
 — Bacilli, Capsule-formation, 525
 — — Examination of Water by the Complement-fixation Method, 517
 — Fever, Experimental, 524
 — Stools, New Anaerobe, 688

Dec. 20th, 1911

U

- Ulchla, V., Cyathomonas, 661
 Ultra-condenser, Jentsch's, 97
 Ultra-violet, Opacity of Certain Glasses, 700
 Ultramicroscopical Study of Solutions of Iodine, 545
Uva latissima, 661
 Umagillidae and Dalyellidae, 472
 Unna, P. G., Reduction and Oxidation in Animal Tissues, 614
 Urasow, G. G., Gold-magnesium Alloys, 123
 Uredineæ, 79, 235, 510, 674
 — Experimental Researches with, 791
 — Research, 394
 — Sexuality, 792
 Ureters of Weaver, Variations, 38
 Urobacteria, New Types, 93
 Urodela, Ear, 193
 — Lungless, Heart, 460
 — Occipital Region, 456
 Usnea and its Linnaean Nomenclature, 242
 Ustilago Spores, Germination, 511
 — *Tragopogi-prutensis*, Conidial Fusion, 394

V

- Vaccines, Turbidometer for Counting, 824
 Vacuum, Cementation, 269
 Vanadium on Iron and Steel, Influence, 827
 Vaney, C., Acephalous Lepidoptera, 464
 — Influence of Weather Conditions on Frequency of Warbles, 719
 — Occurrence of Ox-warbles, 619
 Vanilla-pods, Green, Action of Ultra-violet Rays, 484
Varanus varius, Hæmogregarine in Blood, 57
 "Variable" Microscope, The, 284
 Vascular Plants, Evolution of Conducting-tissues, 638
 — — Transitory Tissues, 216
Vaucheria terrestris, 666
 Vegetation of Upper Rhine, 789
 Verderame, Ph., *Sarcina Citrea conjunctivæ*, 688
 Verhuist, A., Distribution of *Equisetum maximum*, 648
 Vermetidae, Sponges associated with, 766
 Vernes, A., Filtering by Aid of the Centrifuge, 267
 Vernoell, K. W., Studies on Millipedes, 752
Verruga peruana, 522
 Verson, E., Moulting in Silkworms, 748
 Versluys, J., Birds and Dinosaurs, 192
 Vertebral Column, Development in Reptiles and Birds, 186

- Vertebral Column, Penguin's, Mobility, 743
 Vertebrata. See CONTENTS
 Vertebrates, Morphology, 459
 Vessicelli, N., Structure of *Phyllirœ
bucephala*, 39
 Vialleton, L., Injection of Fusible Alloys
 in Microscopical Anatomy, 822
 — Morphology of the Vertebrates, 459
 Vincent, R., 282
 — The Morphology of the Organisms con-
 cerned in the Production of Acute
 Intestinal Toxiæmia in Infants, 280
 Vine, Infection by *Plasmopara viticola*,
 507
 — Mildew, in Poland, 508
 — Physical Conditions of Resistance
 against Mildew, 395
 Viper Venom, Immunity, 193
 Virchow, H., Conjunctival Epithelium in
 Man, 610
 — Mobility of Penguin's Vertebral
 Column, 743
 Viret, L., Swiss Desmids, 74
 Virieux, J., Dichotomosiphon and Mis-
 chococcus, 788
 — Spirogyra from the neighbourhood of
 Besançon, 389
 Viscous Flow in Metals, 274
 Vitiariæ, Genera, 487
 Viviani, E., Alloys of Copper, Antimony,
 and Bismuth, 124
 Viviparity and Oviparity in Dung-fly, 198
 Vogel, R., Gold-magnesium Alloys, 123
 Voges, E., Leaf-spots of Currant, 795
 — and others, Plant Diseases, 84
 Volpino, G., Examination of Water for
 Typhoid Bacilli by the Complement-
 fixation Method, 547
 Volvox, New African Species, 232
 Vouk, V., Alternation of Generations in
 Myxomycetes, 685
 — Movements of Plasmodia, 479
 — Streaming of Plasmodia, 520
 Vourmasos, A. G., Bismuthides, 825
 Vuillemin, P., *Cicinnobolus* sp. parasitic
 on Oak Mildew, 393
 — Classification of Hyphomycetes, 673
 — Studies in Hyphomycetes, 793
- W
- Wachter, W., Coremium-formation in
Penicillium, 79
 Wager, H., Demonstrating the Structure
 of the Yeast-cell, 262
 — *Euglena viridis*, 499
 — Yeast Cells and Fermentation, 509
 Wagner, E., Electrical Conductivity of
 Molten Metals, 563
 Wagner, F. v., Species and Varieties of
 Humble-bees, 197
 Wagner, K., Colouring of Trout, 739
 Wahl, B., Dalyellidæ and Umagillidæ, 472
 Wahlberg, A., Apothecial Development in
Anaptychia and *Physcia*, 401
 Waking and Sleeping, 611
 Walcott, C. D., Middle Cambrian Holo-
 thurians, 628
 — — — Medusa, 629
 — — — Merostomata, 622
 Walker, E. W. A., Variation and Adapta-
 tion in Bacteria, 689
 Walker, L. C., Chlorine Method of Water-
 purification, 244
 Walpole, G. S., Action of *Bacillus lactis
aerogenes* upon Glucose, 526
 Walther, A., Enzymes in Different
 Bacteria, 94
 Walton, C. L., Kiodioides, 53
 Warbles, Influence of Weather Conditions
 on Frequency, 749
 Warburton, C. W., Ergot on Oats, 391
 Warnstorf, C., Bryophytes of Southern
 Europe, 495
 — Nomenclature of Sphagnaceæ, 653
 Warren, E., Mammalian Sports, 348
 Warrington, Captain, 835
 Warts, Cuticular, of *Pilargis verrucosa*, 47
 Washing and Dehydrating Apparatus, 822
 — Apparatus, Simple, 702
 Water-bears, Clare Island, 622
 Water-ress Beds, Injury by Algae, 500
 Water-mites, Studying the Compound
 Eyes, 413
 Water-plants, Green, Liberation of Iron,
 484
 Water-purification, Chlorine Method, 244
 Waterston, J., New Flea from South Africa,
 617
 Watson, W., and Sons, Garjeanne's Simple
 Excursion Microscope, 690
 Wave-length, Sensibility of the Eye to
 Variations in the Yellow Region of
 the Spectrum, 106
 Wawrziniok, O., Fixing Objects to Stage,
 273
 Wax Plates, Apparatus for Rolling, 112
 Wax-solvents, Action of, and the Presence
 of Thermolabile Bacteriotoxins on
 Soil, 523
 Weather Conditions, Influence on Fre-
 quency of Warbles, 749
 Weever, Variations in Ureters, 38
 Wege, W., Anatomical and Experimental
 Study of *Asellus aquaticus*, 623
 Weissenberg, R., *Gluga tophii*, 634
 Welding up of Blowholes and Cavities in
 Steel Ingots, 713
 Welds, Some Studies, 714
 Welter, O. A., Pharetronid Sponges of
 Essen Greensand, 631
 Wesenberg-Lund, C., Study of *Phryganea
granulis*, 750
 West, G. S., Algological Notes, 386

- West, G. S., New African Species of *Volvox*, 232
- West, J. A., Food of Shrew-mole, 352
- Wester, P. G., Pollination Experiments with *Anonas* in South Florida, 374
- Westerdijk, J., Sclerotinia as a Plant-disease, 670
- Weyl, F., Cementation in a Vacuum, 269
- Weymouth, F. W., Californian Crabs, 468
- Whales, Beaked, 192
- Wheat-grains, Permeability of the Sheath, 642
- Wheeler, W. M., North American Species of *Camponotus*, 357
- Wheldon, J. A., New Lancashire Lichens, 243
- Social Groups and Adaptive Characters in the Bryophyta, 779
- Whelk's Kidney, New Coccidian from, 771
- Whelks, Damage to Plaice-fishing, 747
- *Spartzia inclinata* in Lancashire, 654
- Whetzel, H. H., Fungicides, 84
- Whitmore, E. R., Characters of Cholera and Cholera-like Organisms, 246
- Wietrzykowski, W., Development of Luchernarians, 629
- Wille, N., Algological Notes, 73
- Williams, E. M., *Leucobryum glaucum*, 780
- Williams, R. S., *Austinella*, a New Genus, 780
- Panama Mosses, 497
- Williamson, H. C., Ichthyological Notes, 746
- Larval Stages of Decapods, 468
- Retarding Development of Herring's Eggs, 739
- Wilna, A., Aluminium Alloys containing Magnesium, 711
- Wilmore, I. J., Hexactininiæ from New South Wales, 629
- Wilson, C. B., Development of Achtheres, 756
- New Parasitic Copepods, 755
- North American Ergasilidae, 756
- Wilson, E. A., Changes of Plumage in Red Grouse, 353
- Wilson, H. A. F., New Method for Differentiation of Bacteria, 109
- Wilson, H. V., Development of Sponges from Dissociated Cells, 766
- Wilson, J., 139
- Wilson, J. T., Manipulation of Paraffin Sections, 113
- Utilizing Organized Structures as Directing Marks for Plastic Reconstruction, 116
- Wilson, M., Spermatogenesis in the Bryophyta, 653
- Winge, O., Fungi from Venezuela and the West Indies, 395
- *Sphaerolucca castagnei*, 791
- Winkel, R., of Göttingen, New Objectives and Eye-pieces, 284, 451
- Winkel's Demonstration Microscope with Detachable Foot, 407, 692
- Dissecting Microscope, 251
- Drawing Microscope, 811
- Eye-piece with Screw Micrometer and Graduated Glass Diaphragm, 536
- Stand No. 1, 248
- — No. 1d, 406
- Travelling Microscope, 248
- Winkler, H., Ferns of Borneo, 64
- Winter, H., Effect of Galvanizing on Strength of Steel Wire, 559
- Wintrebert, P., Involution of Tail in *Alytes obstetricans*, 738
- Lateral Line System in Tadpoles of *Alytes* and *Rana*, 614
- Wislouch, S. M., *Stichococcus bacillaris*, 387
- Two Russian Chryomonads, 499
- Witches-brooms on Firs, 83
- Wolf, E., Metallic Fog in Fused Salts, 828
- Wolff, G., Regeneration in Newts, 614
- Wollenweber, H. W., Monograph of *Fusarium*, 393
- Study of Hyphomycetes, 79
- Wollman, E., Rearing Sterile Flies, 261
- Wollnya, a Genus of Bryaceæ, 654
- Woloszynska, J., Algæ of the Upper Pruth, 72
- Woltereck, R., Sex-determination in Daphnids, 757
- Wonisch, F., Algæ of Andritz, 390
- Wood, E., Phylogeny of Cerithiidae, 356
- Wood, F. E., Habits of Shrew-mole, 352
- Wood-destroying Fungi, 237
- Wood-eating Caterpillars, Digestion, 464
- Woodburn, W. L., Spermatogenesis in certain Hepaticæ, 652
- Woodlice of Ireland, 469
- Woodruff, L. L., Effect of Excretion-products on Rate of Reproduction in *Paramecium*, 767
- Two Thousand Generations of *Paramecium*, 367
- Woodsiæ, Relation to Cyatheaceæ and Polypodiaceæ, 486
- Woolwardia radicans* in Italy, 649
- Worm-nests in Australian Cattle, 626
- Woroniehin, N., Metachromatic Bodies in certain Green Algæ and Conjugatæ, 72
- *Physalosporina*, a New Genus of Pyrenomycetes, 671
- Woyciecki, Z., Mechanism of Movement in Gramineæ, 374
- Wratten and Wainwright's Photomicrography, 103
- Wright, C. H., Ferns of the Falkland Islands, 650
- Wright, Edward Perceval, 61, 506

- Wright, F. E., Transmission of Light through Transparent Inactive Crystal Plates, with Special Reference to Observations in Convergent Polarized Light, 109
- Wülker, G., Japanese Cephalopods, 615
- Wunderer, H., Development of Alpine Salamander, 187
- Wüst, F., Influence of Segregation on the Strength of Mild Steel, 270
- X
- X-rays, Action on Developing Chick, 455
- Castration, 347
- Sterilization, 347
- Xylem Elements of the Pteridophyta, 644
- Y
- Yasui, K., Life-history of *Salvinia natans*, 645
- Yatsu, N., Extra-ovate Experiments on Sea-urchin Ova, 363
- Polarity of Primary Oocyte of *Asterias forbesii*, 472
- Yawning in Fishes, 194
- Yeast, Presence on Tea, 392
- Yeast-cell, Demonstrating the Structure, 262
- Yeast-cells and Fermentation, 509
- Copulation, 392
- Yeast-juice, Alcoholic Ferment, 672
- Yeasts and Insects, Symbiosis, 616
- Young, W. J., Alcoholic Ferment of Yeast-juice, 672
- Z
- Zach, F., Occurrence of Phagocytosis in the Root-nodules of Cycads, 60
- Rusts of Cereals, 80
- Zacher, F., Position and Classification of Protodermaptera, 620
- Zaleski, W., Function of Nucleoproteid, 637
- Zalesski, M., *Lepidostrobos bertrandi*, 62
- Zander, E., and another, Studies on Bees, 197
- Zaphrentis delanouei*, Evolution, 54
- Zarnik, B., Kidney of Gecko, 190
- Life-cycle of *Dicroroelium lanceatum*, 361
- Zawarzin, A., Histological Study of the Innervation of the Heart of Larval Dragon-fly, 750
- Zeiss Apochromat, New, Some New Diatomic Structure discovered with, 700
- Zeiss, C., Directions for using Glass Micrometers, 538
- Zeiss Nernst Lamp, New, 810
- Zellner, J., Chemistry of the Higher Fungi, 396
- Zieglwaller, F., Fixation and Staining of Glycogen, 821
- Zinc Amalgams, 417
- and Aluminium Alloys, 711
- Magnesium and Cadmium, Ternary Alloys, 124
- Polymorphism, 123
- Zimmerman, H., Germination of Ustilago Spores, 511
- Zimmerman, K. W., Epithelial Cells of Mammalian Kidney, 609
- Zodda, J., Drepanocladus, 655
- Zoology, Outlines, 39
- Zulueta, A. de, Copepods Parasitic on Alcyonarians, 202
- Zygopterideæ, 61





MBL WHOI LIBRARY



WH 18WG K

206

