

Journal of the Royal Microscopical Society

CONTAINING ITS TRANSACTIONS AND PROCEEDINGS

AND

A SUMMARY OF CURRENT RESEARCHES RELATING TO
ZOOLOGY AND BOTANY

(principally Invertebrata and Cryptogamia)

MICROSCOPY, &c.

EDITED BY THE LATE

R. G. HEBB, M.A. M.D. F.R.C.P.

AND

CHARLES SINGER, M.A. M.D. F.R.C.P.

WITH THE ASSISTANCE OF THE PUBLICATION COMMITTEE AND

J. ARTHUR THOMSON, M.A. LL.D.

*Regius Professor of Natural History in the
University of Aberdeen*

A. N. DISNEY, M.A. B.Sc.

FELLOWS OF THE SOCIETY

AND

A. B. RENDLE, M.A. D.Sc. F.R.S. F.L.S.

Keeper, Department of Botany, British Museum

R. M. JONES, M.Sc.

Woolwich Arsenal

RALPH ST. JOHN BROOKS,

M.A. M.D. D.P.H. D.T.M. & H. (CAMB.)

Minimis partibus, per totum Naturæ campum, certitudo omnis innititur
quas qui fugit pariter Naturam fugit.—*Linnaeus.*

FOR THE YEAR

1918



TO BE OBTAINED AT THE SOCIETY'S ROOMS

20 HANOVER SQUARE, LONDON, W.1

OF MESSRS. WILLIAMS & NORGATE, 14 HENRIETTA STREET, LONDON, W.C.2

AND OF MESSRS. DULAU & CO., LTD., 34 MARGARET STREET, LONDON, W.1

Council Meetings are held on the third Wednesday, Meetings of the Biological Section on the first Wednesday in each month from October to June.

Fellows intending to exhibit any Instruments or Objects, or to bring forward any Communications at the Ordinary Meetings, are requested to inform the Secretaries a week before the Meeting if possible.

THE

Royal Microscopical Society.

Established in 1839. Incorporated by Royal Charter in 1866.

The Society was established in 1839 for the promotion of Microscopical and Biological Science by the communication, discussion, and publication of observations and discoveries relating to (1) Improvements in the construction and mode of application of the Microscope, and (2) Biological or other subjects of Microscopical Research.

It consists of Ordinary, Honorary, and Ex-officio Fellows of either sex.

Ordinary Fellows are elected on a Certificate of Recommendation signed by three Ordinary Fellows, setting forth the names, residence, and qualifications of the Candidate, of whom the first proposer must have personal knowledge. The Certificate is read at two General Meetings, the Candidate being balloted for at the second Meeting.

The Admission Fee is 2*l.* 2*s.*, payable at the time of election; and the Annual Subscription is 2*l.* 2*s.*, payable on election, and subsequently in advance on 1st January in each year, but the Annual Subscriptions may be compounded for at any time for 31*l.* 10*s.* Fellows elected at a meeting subsequent to that in February are only called upon for a proportionate part of the first year's subscription. The annual Subscription of Fellows permanently residing abroad is 1*l.* 11*s.* 6*d.*, or a reduction of one-fourth.

Honorary Fellows (limited to 50), consisting of Fellows eminent in Microscopical or Biological Science, are elected on the recommendation of five Ordinary Fellows and the approval of the Council.

Ex-officio Fellows (limited to 100), consisting of the Presidents for the time being of any Societies having objects in whole or in part similar to those of the Society, are elected on the recommendation of ten Ordinary Fellows and the approval of the Council.

The Council, in whom the management of the property and affairs of the Society is vested, is elected annually, and is composed of the President, four Vice-Presidents, Treasurer, two Secretaries, and twelve other Ordinary Fellows.

The Journal, containing the Transactions and Proceedings of the Society, and a Summary of Current Researches relating to Zoology and Botany (principally Invertebrata and Cryptogamia), Microscopy, etc., is published bi-monthly, and is forwarded post-free to all Ordinary and Ex-officio Fellows residing in countries within the Postal Union.

The Library, with the Instruments, Apparatus, and Cabinet of Objects, is open for the use of Fellows daily (except Saturdays), from 10 A.M. to 5 P.M. and also on Wednesday evenings, other than Meeting evenings, from 6 P.M. to 9 P.M., except during the vacations. It is closed for four weeks during August and September.

Forms of proposal for Fellowship, and any further information, may be obtained on application to the Secretary, at the Rooms of the Society, 20 Hanover Square, London, W.1

Patron

HIS MAJESTY THE KING.

Past-Presidents.

	Elected
*SIR RICHARD OWEN, K.C.B. D.C.L. M.D. LL.D. F.R.S.	1840-1
*JOHN LINDLEY, Ph.D. F.R.S.	1842-3
*THOMAS BELL, F.R.S.	1844-5
*JAMES SCOTT BOWERBANK, LL.D. F.R.S.	1846-7
*GEORGE BUSK, F.R.S.	1848-9
*ARTHUR FARRE, M.D. F.R.S.	1850-1
*GEORGE JACKSON, M.R.C.S.	1852-3
*WILLIAM BENJAMIN CARPENTER, C.B. M.D. LL.D. F.R.S.	1854-5
*GEORGE SHADBOLT	1856-7
*EDWIN LANKESTER, M.D. LL.D. F.R.S.	1858-9
*JOHN THOMAS QUEKETT, F.R.S.	1860
*ROBERT JAMES FARRANTS, F.R.C.S.	1861-2
*CHARLES BROOKE, M.A. F.R.S.	1863-4
*JAMES GLAISHER, F.R.S.	1865-6-7-8
*REV. JOSEPH BANCROFT READE, M.A. F.R.S.	1869-70
*WILLIAM KITCHEN PARKER, F.R.S.	1871-2
*CHARLES BROOKE, M.A. F.R.S.	1873-4
*HENRY CLIFTON SORBY, LL.D. F.R.S.	1875-6-7
*HENRY JAMES SLACK, F.G.S.	1878
*LIONEL S. BEALE, M.B. F.R.C.P. F.R.S.	1879-80
*PETER MARTIN DUNCAN, M.B. F.R.S.	1881-2-3
*REV. WILLIAM HY. DALLINGER, M.A. LL.D. F.R.S.	1884-5-6-7
*CHARLES THOS. HUDSON, M.A. LL.D. (Cantab.), F.R.S.	1888-9-90
*ROBERT BRAITHWAITE, M.D. M.R.C.S.	1891-2
ALBERT D. MICHAEL, F.L.S.	1893-4-5-6
EDWARD MILLES NELSON	1897-8-9
WILLIAM CARRUTHERS, F.R.S. F.L.S. F.G.S.	1900-1
HENRY WOODWARD, LL.D. F.R.S. F.G.S. F.Z.S.	1902-3
DUKINFIELD HY. SCOTT, M.A. Ph.D. LL.D. F.R.S. F.L.S.	1904-5-6
*THE RIGHT HON. LORD AVEBURY, P.C. D.C.L. LL.D. F.R.S., etc.	1907-8
SIR EDWIN RAY LANKESTER, K.C.B. M.A. LL.D. F.R.S. F.L.S. F.Z.S.	1909
J. ARTHUR THOMSON, M.A. F.R.S.E.	1910-11
*HENRY GEORGE PLIMMER, F.R.S., F.L.S., F.Z.S., etc.	1911-12
G. SIMS WOODHEAD, M.A. M.D. LL.D. F.R.S.E., etc.	1913-16

* Deceased.

COUNCIL.

ELECTED 16TH JANUARY, 1918.

President.

*JOSEPH E. BARNARD.

Vice-Presidents.

- *EDWARD HERON-ALLEN, F.L.S. F.Z.S., F.G.S. M.R.I.A., etc.
ARTHUR EARLAND.
*F. MARTIN DUNCAN, F.R.P.S.
*ROBERT PAULSON, F.L.S.

Treasurer.

*CYRIL F. HILL.

Secretaries.

- *J. W. H. EYRE, M.D. M.S. F.R.S. Edin.
*DAVID J. SCOURFIELD, F.Z.S.

Ordinary Members of Council.

- ALFRED N. DISNEY, M.A. B.Sc.
T. H. HISCOTT.
J. MILTON OFFORD.
PERCY E. RADLEY.
A. W. SHEPPARD.
*R. G. HEBB, M.A. M.D. F.R.C.P.
EDWARD J. SHEPPARD.
CHARLES SINGER, M.A. M.D.
CHARLES D. SOAR, F.L.S.
JOSEPH WILSON.
*BENJ. MOORE, M.A. D.Sc. F.R.S.
*B. B. WOODWARD, F.L.S. F.G.S.

EDITOR.

*R. G. HEBB, M.A. M.D. F.R.C.P.

LIBRARIAN.

PERCY E. RADLEY.

CURATOR OF INSTRUMENTS.

CHARLES SINGER, M.A. M.D., etc.

CURATOR OF SLIDES.

EDWARD J. SHEPPARD.

ASSISTANT SECRETARY.

A. E. BULL.

* Members of the Publication Committee.



CONTENTS.

TRANSACTIONS OF THE SOCIETY.

	PAGE
I.—Report on the Recent Foraminifera dredged off the East Coast of Australia. H.M.S. "Dart," Station 19 (14 May, 1895), Lat. 29° 22' S., Long. 153° 51' E., 465 fathoms. Pteropod Ooze. By Henry Sidebottom. [Communicated by E. Heron-Allen and A. Earland.] (Plates I-II) ..	1
II.—Microscopy at Ruhleben. By R. Paulson, F.R.M.S.	26
III.—A New Species of <i>Gongrosira</i> . By G. S. West, M.A., D.Sc., F.L.S. (One Plate)	30
IV.—Report on the Recent Foraminifera dredged off the East Coast of Australia. H.M.S. "Dart," Station 19 (14 May, 1895), Lat. 29° 22' S., Long. 153° 51' E. 465 fathoms. Pteropod Ooze— <i>continued</i> . By Henry Sidebottom. [Communicated by E. Heron-Allen and A. Earland.] (Plates III-V)	122
V.—The Royal Microscopical Society during the Great War—and After. Presidential Address, 1917-18. By Edward Heron-Allen, F.L.S., F.G.S., F.Z.S., etc.	153
VI.—On <i>Pyxidicula invisitata</i> , a Rhizopod new to Britain, and <i>Hedriocystis spinifera</i> , a new Heliozoon. By James Meikle Brown, B.Sc., F.L., F.C.S. [Communicated by John Hopkinson, F.L.S., F.R.M.S.] (One Plate) ..	170
VII.—Report on the Recent Foraminifera dredged off the East Coast of Australia. H.M.S. "Dart," Station 19 (14 May, 1895), Lat. 29° 22' S., Long. 153° 51' E., 465 fathoms. Pteropod Ooze— <i>concluded</i> . By Henry Sidebottom. [Communicated by E. Heron-Allen and A. Earland.] (Plate VI)	249
VIII.—On the Microstructure of Hypo-eutectoid Steel as contrasted with that of Normal Steel. With a Note on the Microscopical Methods adopted in the Examination of Steel Specimens. By E. Atkinson, A.M.Inst.L.E., F.C.S., F.R.M.S., etc. (Plates I-III, and One Text-fig.)	265
IX.—Two Valuable Methods of Staining in Bulk and Counter-Staining. By E. J. Sheppard	275
X.—Acetone as a Solvent for Mounting Media. By John Ritchie, Jun.	279
XI.—A New Type of Infusorian: <i>Arachnidopsis paradoxa</i> . By E. Penard, Sc.D. (One Plate)	283
XII.—An Improved Method of Apertometry. By E. Hartridge, M.A., M.D., F.R.M.S., Fellow of King's College, Cambridge. (Four text-figs.) ..	337

OBITUARY.

	PAGE
Richard Grainger Hebb, M.A., M.D.Camb., F.R.C.P. Lond. 1848-1918. Consulting Physician and Physician Pathologist to the Westminster Hospital. (One Plate)	173
Miss Ethel Sargant, F.L.S. By A. W. Sheppard	175
William Sydney Gibbons. By W. M. Bale	176
Professor Henry George Plummer, M.R.C.S., F.R.S., etc. (President R.M.S., 1911-12.) (Portrait)	349
Kate Marion Hall, F.L.S., F.Z.S.	358
Albert McCalla, M.A., Ph.D.	358

SUMMARY OF CURRENT RESEARCHES.

ZOOLOGY.

VERTEBRATA.

a. Embryology.

LIPSCHÜTZ, A.— <i>Internal Secretions of Gonads</i>	32
STREETER, GEORGE L.— <i>Development of Auditory Capsule in Man</i>	33
RABAUD, ETIENNE—"Dislocated" Mice	33
JORDAN, H. E.— <i>Hæmopoiesis in Mongoose Embryo</i>	34
" <i>Aortic Cell-clusters in Vertebrate Embryos</i>	34
MYERS, J. A.— <i>Development of Mammary Glands</i>	34
HAMMOND, J.— <i>Mammary Glands of Rabbit</i>	35
STOCKARD, CHARLES R., & GEORGE N. PAPANICOLAOU— <i>Œstrous Cycle in Guinea-pig</i>	35
MARSHALL, F. H. A., & E. T. HALNAN— <i>Post-Œstrous Changes in Dog</i>	36
PEARL, RAYMOND— <i>Effect on Progeny of Fowls after Treatment with Alcohol</i>	37
JENNINGS, H. S.— <i>Hereditary Characters and Evolution</i>	37
LILLIE, FRANK R.— <i>Study of Free-martin</i>	37
JORDAN, H. E.— <i>Germ-cells of Loggerhead Turtle</i>	38
VANNEMAN, AIMEE S.— <i>Germ-Cells of Armadillo</i>	177
CORNER, GEORGE W.— <i>Maturation of Ovum in Swine</i>	178
PATTERSON, J. J., & C. G. HARTMAN— <i>Polyembryonic Blastocyst in Opossum</i>	178
HARMAN, MARY T.— <i>Superfetation in Cat</i>	178
LEWIS, MARGARET REED— <i>Effect of Vital Stains on Eggs</i>	178
WENTWORTH, E. N.— <i>Inheritance of Fertility in Sheep</i>	179
MYERS, J. A.— <i>Development of Mammary Glands in Rat</i>	179
HOWELL, J. A.— <i>Effect of Stress and Strain on Bone Development</i>	179
JOHNSON, C. E.— <i>Development of Liver in Ground Squirrel</i>	180

	PAGE
BAUMGARTNER, E. A.— <i>Development of Serous Glands of Tongue</i>	180
SABIN, FLORENCE R.— <i>Angioblasts and Blood-vessels</i>	180
BORING, ALICE M., & RAYMOND PEARL— <i>Interstitial Cells in Reproductive Organs of Chicken</i>	180
PEARL, RAYMOND— <i>Effects of Pituitary Body and Corpus Luteum on Chicks</i>	181
BAMBER, RUTH C.— <i>Hermaphrodite Dogfish</i>	181
HOWLAND, RUTH B.— <i>Removal of Pronephros of Amphibian Embryo</i>	181
MORGAN, T. H.— <i>Inheritance in Fantail Pigeons</i>	181
PEARL, RAYMOND— <i>Sex-ratio in Domestic Fowl</i>	182
LOEB, JACQUES— <i>Further Experiments on Sex of Frogs developed from Artificially Activated Eggs</i>	290
THING, ALICE— <i>Zona Pellucida in Turtle Eggs</i>	290
GILCHRIST, J. D. F.— <i>Eggs and Embryos of Bdellostoma</i>	291
GOODRICH, EDWIN S.— <i>Development of Head-segments of Dogfish</i>	291
WINTREBERT, P.— <i>Earliest Movements of Dogfish Embryo</i>	291
WERBER, E. I.— <i>Morphogenesis of Duplicities</i>	291
HUBER, G. CARL— <i>Development of Mammalian Notochord</i>	292
BORING, ALICE M., & RAYMOND PEARL— <i>Hermaphrodite Fowls</i>	292
BADERTSCHER, J. A.— <i>Ultimobranchial Bodies in Pig</i>	292
CHAPMAN, W. B.— <i>Development of Blood-vessels without Heart</i>	293
BOYDEN, EDWARD A.— <i>Vestigial Gill-filaments in Saurapsida</i>	293
HERLANT, MAURICE— <i>Cyclic Variations in Permeability of the Activated Ovum</i>	293
PEARL, RAYMOND, & ALICE M. BORING— <i>Corpus Luteum in Ovary of Chicken</i>	293
DUESBERG, G.— <i>Chondriosomes in Testis-cells of Fundulus</i>	294
THOMPSON, HELEN B., & LAFAYETTE B. MENDEL— <i>Growth of Mice</i>	294
CLARK, ELIOT R.— <i>Growth of Blood-vessels in Frog Larvæ</i>	294
WHITING, P. W.— <i>Inheritance of Coat-colour in Cats</i>	294
DETWILER, S. R.— <i>Development of Shoulder-girdle and Fore-limb in Amblystoma punctatum</i>	295
HARRISON, ROSS G.— <i>Development of Fore-limb of Amblystoma punctatum</i>	295
MORRILL, C. V.— <i>Regeneration after Exarticulation in Diemyctylus viridescens</i>	295
SWINGLE, W. W.— <i>Effect of Starvation on Tadpoles</i>	295
.. .. .— <i>Thyroid Feeding of Tadpoles</i>	296
ALLEN, BENNET M.— <i>Removal of Thyroid from Tadpoles</i>	296
TERRY, GEORGE S.— <i>Effect on Ossification in Tadpoles of Extirpating Thyroid</i>	296
ROGERS, JAMES B.— <i>Effect of Thyroid Extirpation on Thymus and Pituitary Glands</i>	296
UHLENHUTH, EDUARD— <i>Influence of Thymus-feeding</i>	296
STEWART, CHESTER A.— <i>Effects of Underfeeding Young Albino Rats</i>	297
UHLENHUTH, E.— <i>Grafts in Amblystoma</i>	297
HAYS, FRANK A.— <i>Sexual Activity of Male Rabbit in Relation to Progeny</i>	297
LLOYD-JONES, ORREN, & F. A. HAYS— <i>Sexual Activity of Male Rabbit</i>	298
SMITH, BERTRAM G.— <i>Germinal Vesicle in Cryptobranchus</i>	359
HILL, J. P.— <i>Early Development of Opossum</i>	359
COLE, L. J., & L. J. BACHHUBER— <i>Lead-poisoning of Germ-cells</i>	360
CURTIS, G. M.— <i>Seminiferous Tubules of Mammals</i>	360
YOCUM, HARRY B.— <i>Spermatogenesis in Mouse</i>	360
MALONE, JULIAN Y.— <i>Spermatogenesis of Dog</i>	360
PAPANICOLAOU, GEORGE N., & CHARLES R. STOCKARD— <i>Idiosome in Spermatogenesis of Guinea-pig</i>	361
DANCHAKOFF, VERA— <i>Development of Red Blood Corpuscles</i>	361
STEWART, FRED. W.— <i>So-called Thymus IV. of Cat</i>	362

	PAGE
ATWELL, WAYNE J.— <i>Development of Hypophysis of Rabbit</i>	362
" " — <i>Development of Hypophysis of Anura</i>	362
RIDDLE, OSCAR— <i>Right and Left Testes of Pigeons</i>	363
PEARL, RAYMOND— <i>Influence of Age on Reproductivity of Fowls</i>	363
" " — <i>Age and Fertility in Fowls</i>	363
" " — <i>Sex-ratio in Domestic Fowl</i>	363
JORDAN, H. E.— <i>Case of False Hermaphroditism</i>	364
HARMAN, MARY T.— <i>Superfetation in Cow</i>	364
DANCHAKOFF, VERA— <i>Grafts of Spleen on Allantois</i>	364
SUNDARA, RAJ B.— <i>Notes on Fresh-water Fishes of Madras</i> (2 figs.)	364
HATAI, SHINKISHI— <i>Growth of Parts of Rats and of the Whale</i>	366
PEARL, RAYMOND— <i>Proportion of Sexes in Whitefish</i>	366

b. Histology.

DANCHAKOFF, VERA— <i>Differentiation of Cells in the Developing Organism</i>	39
LEWIS, WARREN H., & MARGARET R. LEWIS— <i>Behaviour of Explanted Striped Muscle in Cultures</i>	40
WALLIN, IVAN E.— <i>Thymus-like Structures in Larval Lamprey</i>	40
ERDMANN, RHODA— <i>Chicken Bone-marrow in Plasma Medium</i>	41
HEITZ-BOYER & SCHEIKEVITSCH— <i>Osseous Regeneration in the Adult</i>	41
DUSTIN, A. P.— <i>Epithelial Reversions in Human Thymus</i>	41
BARBIERI, NICOLA ALBERTA— <i>Structure of Optic Nerve</i>	41
JORDAN, H. E., & J. B. BANKS— <i>Intercalated Discs in Heart-muscle of Ox</i>	41
AREY, L. B.— <i>Shape of Red-blood Corpuscles in Mammals</i>	182
REESE, ALBERT M.— <i>Blood-corpuscles of Alligator</i>	183
RETFERER, ED., & H. NEUVILLE— <i>Fatty Tissue of Crocodilians</i>	183
LEWIS, WARREN H., & MARGARET R. LEWIS— <i>Time occupied in Mitosis</i>	183
FISHER, HOMER G.— <i>Minute Structure of Retractor Penis-muscle of Dog</i>	183
AREY, LESLIE B.— <i>Phagocytosis by Osteoclasts</i>	183
RASMUSSEN, A. T.— <i>Seasonal Changes in Interstitial Cells of Woodchuck</i>	184
AREY, LESLIE B.— <i>Shape of Mammalian Red Blood-corpuscle</i>	298
JOHNSON, FRANKLIN P.— <i>Lobules of Pig's Liver</i>	298
RUTH, E. S., & R. B. GIBSON— <i>Melanophores of Lizards</i>	298
WALLIN, IVAN E.— <i>Branchial Epithelium of Ammocoetes</i>	298
HOAG, L. A.— <i>Minute Structure of Sensory Root of Trigeminal Nerve</i>	299
DEWEY, KAETHE W.— <i>Lining of Perivascular Spaces</i>	366
CONGDON, E. D.— <i>Heart-muscle of Embryo Chick</i>	366
JORDAN, H. E.— <i>Giant-cells of Yolk-sac and Bone-marrow</i>	367
" " — <i>Histology of Lymph</i>	367
RAO, C. R. N.— <i>Iridocytes in Batrachian Larvæ</i>	367
CLARK, E. R., & E. L. CLARK— <i>Phagocytosis in Tadpole's Tail</i>	368
GARDINER, J. STANLEY, & G. H. F. NUTTALL— <i>Fish-freezing</i>	368
AMEMIYA, I.— <i>Telescope-eye of Goldfish</i>	368
WHITEHOUSE, R. H.— <i>Caudal Fin of Chaudhuria</i>	368

c. General.

NICE, L. B.— <i>Effect of Alcohol on White Mice</i>	42
COCKERELL, T. D. A.— <i>Auditory Ossicles of Aplodontia</i>	42
CALVET, LOUIS— <i>Atrophy of Right Superior Vena cava in Sheep</i>	43
BOUTAN, L.— <i>Rôle of Fins in Teleosts with Swim-bladder</i>	43

	PAGE
KOPACZEWSKI, W.— <i>Poison of Muræna</i>	43
" — <i>Serum of Muræna</i>	43
" — <i>Toxicity of Serum of Muræna</i>	43
ROULE, LOUIS— <i>Evolution of Salmonide</i>	44
PERRIER, EDMOND— <i>History of Faunas and its Relation to Sex</i>	4
PEARL, RAYMOND— <i>Measurement of Degrees of Kinship</i>	44
DONALDSON, HENRY H.— <i>Myelin and Advancing Age</i>	185
MAYER, A. G.— <i>Theory of Nerve Conduction</i>	185
BARRELL, JOSEPH— <i>Origin of Air-breathing Vertebrates</i>	185
HAGEDOORN, A. G., & A. L.— <i>Rats and Evolution</i>	185
KITTELSON, JOHN A.— <i>Post-natal Growth of Kidney of Albino Rat</i>	186
GOODRICH, EDWIN S.— <i>"Proboscis Pores" in Craniate Vertebrates</i>	186
STRONG, R. M.— <i>Origin of Melanin in Feather-germs of Fowls</i>	187
WALTON, CHAS. L.— <i>Agricultural Zoological Survey of Aberystwith Area</i>	187
SOUTHWELL, T., & B. PRASHAD— <i>Study of Hilsa</i>	187
HESS, WALTER N.— <i>Seasonal Changes in Kidney of Stickleback</i>	299
LEGENDRE, J.— <i>Study of Malagasy Perch</i>	299
DELPHY, JEAN— <i>Anomalous Pelvic Fins in Cottus bubalis</i>	299
WILLIAMSON, H. CHAS.— <i>Otolith-method of Estimating Age of Plaice</i>	300
CUTLER, D. WARD— <i>Rings in Scales of Plaice and Flounders</i>	300
LIPPINCOTT, W. A.— <i>Blue Andalusians</i>	300
POCOCK, R. I.— <i>Baculum or Os penis in some Genera of Mustelidæ</i>	300
PETERSEN, C. G. JOH.— <i>Fauna of Coastal Waters</i>	369
LEBOUR, MARIE V.— <i>Food of Post-larval Fishes</i>	370
SMITH, WILBUR C.— <i>Disappearance of Conus arteriosus in Teleosts</i>	370
NANTA, A.— <i>Note upon the large Mononuclear Leucocytes of the Peripheral Blood and the Macrophages at the Site of Injury amongst the Wounded</i>	370
BABLET, J.— <i>The Leucocytes in Experimental Spirochetosis ichthæmorrhagica in the Guinea-pig</i>	371

Tunicata.

HECHT, SELIG— <i>Sensory Reactions of Ascidia atra</i>	301
CROZIER, W. J.— <i>Photic Sensibility of Balanoglossids</i>	301
NAME, WILLARD G. VAN— <i>Philippine Ascidians</i>	371
HECHT, SELIG— <i>Vascular System of Ascidian</i>	371

INVERTEBRATA.

Mollusca.

a. Cephalopoda.

BOTAZZI, F.— <i>Posterior Salivary Glands of Cephalopods</i>	372
--	-----

γ. Gastropoda.

THOMPSON, ELIZABETH LOCKWOOD— <i>Experiments with Physa gyrina</i>	45
BARTSCH, PAUL— <i>Philippine Species of Amphidromus</i>	45
CONKLIN, E. G.— <i>Centrifuged Eggs of Crepidula</i>	188
TAYLOR, JOHN W.— <i>British Terrestrial and Fresh-water Mollusca</i>	188
CROZIER, W. J.— <i>Immunity Coloration in Nudibranchs</i>	188
GATENBY, J. BRONTÉ— <i>Cytoplasmic Inclusions in Germ-cells of Snail</i>	189

	PAGE
COPELAND, MANTON— <i>Smell and Taste in Marine Snails</i>	301
OLMSTED, J. M. D.— <i>Locomotion of Gastropods</i>	301
PARKER, G. H.— <i>Pedal Locomotion of Aplysia californica</i>	302

Arthropoda.

COCKERELL, T. D. A.— <i>Arthropods from Burmese Amber</i>	45
" " — <i>Arthropods in Burmese Amber</i>	46
RUEDEMANN, R.— <i>Median Eye in Trilobites</i>	189

a. Insecta.

MCINDOO, N. E.— <i>Recognition among Insects</i>	46
RABAUD, ETIENNE— <i>Paralyzing Habits of some Hymenoptera</i>	46
GATENBY, A. BRONTÉ— <i>Cytoplasmic Bodies in Germ-cells of Lepidoptera</i>	47
FAUCHÈRE— <i>Silkworms in Madagascar</i>	47
LÉCAILLON, A.— <i>Variations in Silkworms</i>	48
" — <i>Parthenogenesis in Silk-moths</i>	48
FEYTAUD, J.— <i>Parthenogenesis in Otiorhynchus sulcatus</i>	48
RITCHIE, WALTER— <i>Study of Myelophilus minor</i>	48
TAYLOR, MONICA— <i>Fertilization in Gnat</i>	49
MISRA, C. S.— <i>Sugar-cane Leaf-hopper</i>	49
NUTTALL, G. H. F.— <i>Bibliography of Human Lice</i>	49
" — <i>Lice and Disease</i>	49
" — <i>Biology of Lice</i>	50
HOWLETT, F. M.— <i>Notes on Lice</i>	51
MUIR, FREDERICK— <i>Philippine Derbidæ</i>	51
ROTHSCHILD, N. C.— <i>Convergence among Ectoparasitic Insects</i>	52
CHOPARD, L.— <i>Abdominal Extremity in Orthoptera</i>	52
FOUCHER, G.— <i>Longevity of Males of Carausius morosus</i>	52
GOLDSCHMIDT, RICHARD— <i>Intersexual Form of Gypsy-moth</i>	52
MACDOWELL, EDWIN CARLETON— <i>Bristle Inheritance in Drosophila</i>	53
TILLYARD, R. J.— <i>Monograph on Dragonflies</i>	55
NAKAHARA, WARO— <i>Nuclear Division in the Adipose Cells of Insects</i>	189
TILLYARD, R. J.— <i>Studies in Mecoptera</i>	190
BUXTON, P. A.— <i>Protocerebrum of Micropteryx</i>	190
COCKAYNE, E. A.— <i>Scales of Leaden Moles of Agriades thetis</i>	191
JOICEY, J. J. & G. TALBOT— <i>Gynandromorph of Papilio lycophron</i>	191
MOTTRAM, J. C.— <i>Protective Coloration in Lepidoptera</i>	191
HAWKES, ONERA A. MERRITT— <i>Inheritance in Silkworms</i>	191
HUIE, L. H.— <i>Study of Holly Tortrix Moth</i>	191
THOMPSON, W. R.— <i>Dipterous Parasite in Terrestrial Isopods</i>	192
WARREN, DON C.— <i>Mutations in Drosophila busckii</i>	192
HILL, G. F.— <i>Bionomics of the Buffalo-fly (Lyperosia exigua de Meijere)</i>	192
BROCHET, F.— <i>Circulation of the Blood in Insects</i>	193
NORTHOP, JOHN N.— <i>Growth-period and Duration of Life</i>	194
MUNRO, JAMES W.— <i>Study of Structure, Habits, and Life-history of Hyglustes</i>	194
SLOANE, THOMAS G.— <i>Endoskeleton of Head and the Coxal Cavities of Beetles</i>	194
HEGNER, R. W. & C. P. RUSSELL— <i>Germ-cell Cycle of Dinuetes nigrior</i>	194
MACGREGOR, MALCOLM E.— <i>Insects and Disease</i>	302
VAN BEMMELEN, J. F.— <i>Wing-markings of Arctiidæ</i>	302
TILLYARD, R. J.— <i>Wing-venation of Lepidoptera</i>	302

	PAGE
GAUTIER, CL.— <i>Observations on Caterpillars of Cabbage-white Caterpillars</i>	302
KEYS, JAMES H.— <i>Maritime Coleoptera</i>	303
CARPENTER, GEORGE H., & F. J. S. POLLARD— <i>Spiracles of Hypoderma Maggot</i>	303
PLOUGH, HAROLD H.— <i>Temperature and Crossing-over in Drosophila</i>	303
MC EWEN, R. S.— <i>Reactions of Drosophila to Light and Gravity</i>	303
SANFORD, ELDON W.— <i>Digestion in Cockroach</i>	304
NUTTALL, G. H. F.— <i>Pathological Effects of Phthirus pubis</i>	304
CARPENTER, GEORGE H.— <i>Collembola of Abor Expedition</i>	304
TILLYARD, R. J.— <i>Caudal Gills of Larvæ of Zygopterid Dragonflies (2 figs.)</i>	304
RABAUD, E.— <i>Reflex Immobilization in Arthropods</i>	372
.. — <i>Rôle of Ganglia in Immobilization</i>	373
WHEELER, W. M.— <i>Study of Ant Larvæ (2 figs.)</i>	373
PICTET, ARNOLD— <i>Dimorphic Colouring in Lepidoptera</i>	374
REEVES, EDNA M.— <i>Inheritance of Extra Bristles in Drosophila</i>	375
SHELFORD, VICTOR E.— <i>Coloration of Tiger-beetles</i>	375
CAMERON, A. E.— <i>Leaf-eating Crane-fly</i>	376
BACOT, A.— <i>Viability of Mosquito-eggs</i>	376
CAMERON, A. E., & R. C. TREHERNE— <i>The Pear Thrips</i>	376
CULLEN, ANNA M.— <i>Rectal Tracheation of Dragon-fly Larva</i>	376
JAMIESON, JANET P.— <i>Rectal Tracheæ of Dragon-fly Larva</i>	377
CARROLL, MITCHEL— <i>Hind-gut and Rectal Tracheæ in Dragon-fly Larva</i>	377
BODINE, JOSEPH H.— <i>Experiments on Respiration in Larval Dragon-flies</i>	377
MACHIDA, J.— <i>Spermatogenesis of an Orthopteron</i>	377
STEVEN, H. M.— <i>Biology of Chermes</i>	378
BRINDLEY, H. H.— <i>Notes on Earwigs</i>	378
NUTTALL, G. H. F.— <i>Biology of Phthirus pubis</i>	378

β. Myriopoda.

CARL, J.— <i>New Spirostreptidæ</i>	195
BRÜLEMANN, HENRY W.— <i>Peculiar Variation in Brachydesmus</i>	305

δ. Arachnida.

BERLAND, JEANNE— <i>Alteration of Instinct in Spider</i>	57
JORDAN, H. E.— <i>Cardiac and Skeletal Muscle of Scorpion</i>	57
WILLIAMSON, W.— <i>Rare Hydracarid</i>	57
HIRST, STANLEY— <i>New Parasitic Acari</i>	57
JORDAN, H. E.— <i>Leg-muscle of Sea-spider</i>	57
WILSON, EDMOND B.— <i>Chondriosomes of Scorpion Spermatozoa</i>	195
STENDALL, J. A. SIDNEY— <i>Ulster Spiders</i>	195
BADCOCK, H. D.— <i>Ant-like Spiders</i>	195
WALTER, C.— <i>Swiss Halucaridæ</i>	195
SOAR, CHARLES D.— <i>Hydracarina of Epping Forest</i>	306
WILLIAMSON, W., & CHARLES D. SOAR— <i>Lebertia sefzei</i> Walter	306
DE BEAUCHAMP, P.— <i>New Pentastomid from a Fish</i>	306
FAUST, ERNEST CARROLL— <i>Notes on Mussel-mite</i>	379
TROUËSSART, E. L.— <i>Manye Mites</i>	379
REICHENOW, ED.— <i>Intracellular Digestion in an Ararid</i>	379
TEODORA, G.— <i>Mites as Disease-carriers</i>	379
BERLESE, A.— <i>New Harrest Mite</i>	380

e. Crustacea.

	PAGE
CHILTON, CHARLES— <i>New Zealand Sandhoppers</i>	58
PEARSE, A. S.— <i>New Isopods from British Guiana</i>	58
HERRIOTT, E. M.— <i>Habits of Lepidurus viridis</i>	58
ALLEN, E. J., & E. W. SEXTON— <i>Loss of Eye-pigment in Gammarus chevreuxi</i> ..	195
STEBBING, T. R. R.— <i>Malacostraca of Natal</i>	196
CALMAN, W. T.— <i>Morphology of Bathynellu</i>	196
TAIT, JOHN— <i>Body-colour and Blood-colour in Amphipods</i>	196
BANTA, ARTHUR M.— <i>Sex Intergrades in Simocephalus</i>	197
LOEB, JACQUES, & JOHN H. NORTHOP— <i>Heliotropism of Barnacle Larvæ</i>	197
YATSU, NAOHIDE— <i>Maxillary Gland of Cypridina hilgendorfi</i>	198
GRAVIER, CH. J.— <i>New Parasitic Copepod</i>	306
MEAD, HAROLD T.— <i>Reactions of Sand Crab</i>	380
SALKIND, I.— <i>Sensory Structures of Crab's Claw</i>	380
CAULLERY, M., & F. MESNIL— <i>Further Observations on Xenocoeloma brumpti</i> ..	380
CHILTON, CHAS.— <i>Crustaceans from Interior of Australia</i>	381
" " — <i>Fossil Species of Phreatoicus</i>	381
" " — <i>Australian Isopods</i>	381
LIM, ROBERT K. S.— <i>Respiratory Mechanism of Shore-crab</i>	381
COLLINGE, WALTER E.— <i>New Isopod from British Guiana</i>	381
" " — <i>Oral Appendages of Isopoda</i>	381
TESCH, J. J.— <i>Siboga Crabs</i>	382
JORGENSEN, O. M.— <i>British Occurrence of Nematoscelis megalops</i>	382
" " — <i>Notes on Development of Shore-crab</i>	382

Annulata.

MESNIL, F., & M. CAULLERY— <i>Dimorphism in a Polychæt</i>	58
SOULIER, A.— <i>Segmentation of Ovary of Protula meilhaci</i>	58
MESNIL, F., & M. CAULLERY— <i>Peculiarly Adapted Annelid</i>	306
" " — <i>Notes on Syllids</i>	306
REDFIELD, ALFRED C., & ELIZABETH M. BRIGHT— <i>Effect of Radium on Fertilization</i> <i>Membrane of Nereis</i>	307
ELLIS, MAX M.— <i>Branchiobdellids from Michigan Crawfishes</i>	307
THAPAR, G. S.— <i>Lymph-glands of Pheretima</i>	382
STEPHENSON, J.— <i>Oligochaeta of Indé Lake</i>	383
HORST, R.— <i>Monograph on Polychæts</i>	383

Nematohelminthes.

LOPEZ-NEYRA, C. RODRIGUEZ— <i>New Nematode from Partridge</i>	198
COBE, N. A.— <i>Filter-bed Nematodes</i>	307
STEWART, F. H.— <i>Development of Ascaris lumbricoïdes and A. mystax in Mouse</i> ..	307
" " — <i>Life history of Ascaris lumbricoïdes</i>	307
VAN CLEAVE, H. J.— <i>Acanthocephala of North American Birds</i>	308
WELCH, PAUL S., & I. P. WEHRLE— <i>Reproduction in Nematodes</i>	383
SHIMAMURA, TORAI, & HAJIME FUJII— <i>Toxic Constituent of Nematodes</i>	383

Platyhelminthes.

	PAGE
RUDIN, E.— <i>Tapeicorms of Reptiles</i>	198
ZSCHOKKE, F.— <i>Dibothriocephalus parvus</i> Stephens	198
NICOLL, WILLIAM— <i>Hydatid Cysts in Monkeys</i>	199
JOHNSTON, S. J.— <i>Trematodes of Australian Birds</i>	199
ANDRÉ, EMILE— <i>Helminthological Notes from Switzerland</i>	199
HILARIO, J. S., & L. D. WHARTON— <i>Echinostoma ilocanum</i> (Garrison)	199
LEBOUR, MARIE V.— <i>Trematode Larva from Buccinum undatum</i>	308
GILCHRIST, J. D. F.— <i>Life-history of Distoma luteum</i> sp. n.	308
NICOLL, W.— <i>Trematodes of Queensland Reptiles and Frogs</i>	308
„ — <i>New Trematode from Australian Poison Snakes</i>	309
WEIDMAN, FRED D.— <i>Structure and Development of Cladorchis</i>	309
WALTON, C. L.— <i>Liver-rot</i>	309
OLMSTED, J. M. D.— <i>Regeneration in Planaria maculata</i>	309
SOUTHWELL, T., & BAINI PRASHAD— <i>Cestodes of Hilsa</i>	384
STEWART, F. H.— <i>Hymenolepis nana</i> Siebold and <i>H. murina</i> Dujardin	384
STUNKARD, H. W.— <i>North-American Trematodes</i>	384
GOTO, S., & Y. MATSUDAIRA— <i>New Amphistomid Trematode from a Fish</i>	385
FAUST, ERNEST CARROLL— <i>American Stephanophthalinæ</i>	385
WEIMER, BERNOL R.— <i>Reactions of Fresh-water Turbellarian</i>	385
KABURAKI, TOKIO— <i>Tricladus from Inlé Lake</i>	386

Incertæ Sedis.

LAMEERE, AUG.— <i>Life-history of Diegemids</i>	309
---	-----

Rotatorio.

WHITNEY, D. D.— <i>Controlling Sex in Rotifers</i>	310
--	-----

Echinoderma.

CROZIER, W. J.— <i>Multiplication by Fission in Holothurians</i>	59
HAWKINS, HERBERT L.— <i>Buccal Armature of Conulus</i>	59
LOEB, JACQUES— <i>Fertilization and Phagocytosis</i>	200
LILLE, RALPH S.— <i>Permeability of Sea-urchin Ova</i>	310
BATHER, F. A.— <i>Homologies of Anal Plate in Antedon</i>	310
PAINTER, THEOPHILUS S.— <i>Cell-division in Monaster and Narcotized Ora</i>	311
OLMSTED, J. M. D.— <i>Physiology of Synaptula hydriformis</i>	311
MACBRIDE, E. W.— <i>Experiments with Larval Echinoids</i>	386
CLARK, AUSTIN H.— <i>Unstalked Crinoids of Siboga Expedition</i>	386

Cœlentera.

BROCH, HJALMAR— <i>Australian Alcyonarians</i>	59
DEHORNE, YVONNE— <i>Skeleton of Stromatoporoids</i>	60
BROCH, HJALMAR— <i>Coppinia of Grammaria abietina</i>	60
VAUGHAN, T. W.— <i>Studies on Living Corals</i>	200
YATSU, NAOHIDE— <i>Physiology of Medusæ</i>	200
MAYER, A. G.— <i>Nerve Conduction in Cassiopea</i>	201
PARKER, G. H.— <i>Activities of Corymorpha</i>	311
„ „ — <i>Suction in Sea-anemone</i>	312
STEPHENSON, T. A.— <i>Antarctic Actiniaria</i>	312
BRIGGS, E. A.— <i>New Australian Hydroids</i>	387
BOURNE, GILBERT C.— <i>New Sea-anemones from New Guinea</i>	387

	PAGE
STEPHENSON, T. A.— <i>Irish Actinaria</i>	387
MATTHAI, G.— <i>Nature of Madreporarian Skeleton</i>	387
" — <i>Reactions of Astræid Corals</i>	388
YATSU, NAOHIDE— <i>Locomotion and Reactions of Charybdea</i>	388
Porifera.	
DENDY, ARTHUR— <i>Cheeseman Spicule of Latrunculia</i>	60
STEPHENS, JANE— <i>Irish Sponges</i>	61
VANEY, C., & A. ALLEMAND-MARTIN— <i>Larva of Horse-sponge</i>	201
CROZIER, BLANCHE B.— <i>Buds of Donatia</i>	201
HALLMANN, E. F.— <i>Desmacidonid Sponges</i>	201
JORGENSEN, OLGA M.— <i>Larvæ of Grantia compressa</i>	388
ANNANDALE, NELSON— <i>Sponges from Indé Lake</i>	389
Protozoa.	
MAST, S. O.— <i>Conjugation and Encystation in Didinium nasutum</i>	62
GEORGEVITCH, JIVOIN— <i>Life-history of Ceratomyxa herouardi</i>	62
LICHTENSTEIN, JEAN L.— <i>New Mode of Multiplication in Amœbidium</i>	63
ALEXEIEFF, A.— <i>Blastocystis enterocola</i>	63
LÉGER, L., & O. DUBOSCQ— <i>New Species of Pseudoklossia</i>	63
GEORGEVITCH, F.— <i>Life-cycle of Myxidium gadi</i>	63
" — <i>Leptotheca and Glugea</i>	63
DOBELL, CLIFFORD— <i>New Genus of Heliozoa</i>	201
MATHIS, C., & I. MERCIER— <i>Entamœba dysentericæ</i>	202
WOODRUFF, L. L.— <i>Rhythms in Endomixis</i>	202
" " — <i>Influence of Environment on Endomixis</i>	202
PENARD, E.— <i>Genus Lozodes</i>	202
FRANÇA, CARLOS— <i>Classification of Hæmosporidia</i>	203
HYMAN, LIBBIE H.— <i>Metabolic Gradients in Amœba and their Relation to Amœboid</i> <i>Movement</i>	312
KEPNER, W. A., & J. GRAHAM EDWARDS— <i>Reactions of Pelomyxa to Food</i>	313
DOBELL, CLIFFORD— <i>Entamœba histolytica and Entamœba ranarum</i>	313
" " & MARGARET W. JEPPE— <i>Races of Entamœba histolytica</i>	313
JEPPE, MARGARET W., & CLIFFORD DOBELL— <i>New Amœba from Man</i>	313
LUND, E. J.— <i>Intracellular Respiration in Paramecium</i>	314
YOUNG, R. T.— <i>Experimental Induction of Endomixis in Paramecium aurelia</i>	314
LUND, E. J.— <i>Reversibility of Morphogenetic Processes in Bursaria</i>	314
LEGER, M., & E. PARRY— <i>Trypanosomes in Monkeys</i>	314
PAILOT, A.— <i>New Microsporidian in Cabbage White Caterpillars</i>	314
KEILIN, D.— <i>New Cephaline Gregarine</i>	315
NEWTON, R. BULLEN— <i>Foraminifer and Nullipore Structures in some Tertiary</i> <i>Limestones from New Guinea</i>	315
SCHAEFFER, ASA A.— <i>New Amœbæ</i>	389
LUND, E. J.— <i>Respiration in Paramecium</i>	389
BUIHIGAS, RAMON SOBRINO— <i>Blood-red Seas</i>	390
SCHAEFFER, ASA A.— <i>New Diatom-eating Flagellate</i>	390
WERNER, H., & O. WIESE— <i>Relapsing Fever</i>	390
GOSH, EKENDRANATH— <i>Studies on Infusoria</i>	390
BHATIA, B. L.— <i>Protozoa of Lahore</i>	391

BOTANY.

GENERAL,

Including the Anatomy and Physiology of Seed Plants.

	PAGE
GUILLIERMOND, A.— <i>Mitochondrias of Plant-cells</i>	204
DANGÉARD, P. A.— <i>Nature and Function of Chondriomes</i>	204
GUILLIERMOND, A.— <i>Nature and Significance of the Chondriome</i>	316
TENOPYR, L. A.— <i>Constancy of Cell-Shape</i>	316

Structure and Development.

Vegetative.

JACCARD, P.— <i>Wood of Deciduous Trees</i>	64
SOUÈGES, R.— <i>Development of Root-tip in Sagittaria</i>	205
BRUSH, W. D.— <i>Distinctive Characters of Woods of North American Platanus</i> ..	205
FAUST, E. C.— <i>Resin Secretion in Balsamorhiza</i>	205
RENDE, DR.— <i>The Use of Microscopical Characters in the Systematic Study of the Higher Plants</i>	317
KRYSHTOFOVICH, A.— <i>On the Cretaceous Flora of Russian Sakhalin</i>	392

Reproductive.

BROWN, M. M.— <i>Embryogeny of Phaseolus</i>	64
SOUÈGES, R.— <i>Embryogeny of the Alismaceæ</i>	65
GUIGNARD, L.— <i>Ovule in Apocynaceæ and Asclepiadaceæ</i>	65
GUÉRIN, P.— <i>Development of Pollen in Salvia</i>	206
LE GOC, M. J.— <i>Effect of Foreign Pollination on Cycas Rumphii</i>	317
LA MARCA, F.— <i>Graft-hybrids</i>	318

Physiology.

Nutrition and Growth.

SMITH, E. F.— <i>Mechanism of Overgrowth in Plants</i>	207
YENDO, Y.— <i>Injection Experiments on Plants</i>	207

CRYPTOGAMS.

Pteridophyta.

WEST, C.— <i>Stelar System of the Marattiaceæ</i>	66
KASHYAP, S. R.— <i>Equisetum debile</i>	66
WATTS, W. W.— <i>Australian Ferns and Mosses</i>	67
WUIST, ELIZABETH D.— <i>Apogamy in Phegopteris and Osmunda</i>	67
FARWELL, O. A.— <i>Notes on Hippochæte</i>	68
BUTTERS, F. K.— <i>Pellæa in North America</i>	68
FARWELL, O. A.— <i>American Fern Notes</i>	68

	PAGE
KLEBS, G.— <i>Fern Prothullia</i>	68
HAYATA, B.— <i>Ferns of Formosa</i>	69
BOWER, F. O.— <i>Phylogeny of the Pteroidæ</i>	208
SAHNI, B.— <i>Evolution of Branching in the Filicales</i>	209
GHOSE, S. L.— <i>Cone of Selaginella pallidissima</i>	210
DIELS, L.— <i>Asplenium Scelosii Leyb.</i>	211
STIEL, W. N.— <i>Study of Some New Cases of Apogamy in Ferns</i>	318
DAVIE, R. C.— <i>Comparative List of Fern Pinna-traces, with some Notes on the Leaf-trace in the Ferns</i>	318

Bryophyta.

KASHYAP, S. R.— <i>Turpionia hypophylla</i>	69
MACLEOD, J.— <i>Statistics of Moss Structure</i>	69
JONES, D. A.— <i>Welsh Bryophyta</i>	70
HURST, C. P.— <i>Wiltshire Mosses</i>	70
MASON, T. G.— <i>Carbohydrates of Musci</i>	71
DOUIN, R.— <i>Water-conduction in Marchantiaceæ</i>	71
HERZOG, T.— <i>Multicellular Spores in Mosses</i>	71
SCHIFFNER, V.— <i>Lophozia Hatcheri and L. Baueriana</i>	72
MÜLLER, K.— <i>European Hepaticæ</i>	211
EVANS, A. W.— <i>North American Hepaticæ</i>	212
KASHYAP, S. R.— <i>Indian Liverworts</i>	212
SIM, T. R.— <i>South African Hepaticæ</i>	212
WARNSTORF, C.— <i>Pottia</i>	213
TIMM, R.— <i>Mosses of North-west Germany</i>	213
RIVETT, M. F.— <i>Structure of the Cytoplasm in the Cells of Alicularia scularis</i>	319
DOUIN, CH. ET R.— <i>Le Reboulia Raddi</i>	319
ROSS, J.— <i>Ptilidium pulcherrimum</i>	319
EVANS, ALEXANDER W.— <i>New Lejeunea from Bermuda and the West Indies</i>	320
MELIN, E.— <i>Archegonium of Sphagnum squarrosum</i>	320
WHELDON, J. A.— <i>Collection, Taxonomy, and Ecology of the Sphagna</i>	320
INGHAM, W.— <i>Moss Exchange Club</i>	320
FRYE, T. C.— <i>Iliacomitrium in North America</i>	320
DE LA VARDE, R. POTIER— <i>Ptychomitrium suberispatum Thér. & P. de la V.</i>	321
HARRIS, G. T.— <i>Schistostega osmundacea</i>	321
TIMM, R.— <i>Splachnaceæ</i>	321
ARNELL, H. W.— <i>Bryophyta of the Vega Expedition</i>	321
HARRIS, G. T.— <i>On Schistostega osmundacea Mohr</i>	322

Thallophyta.

Algæ.

WEST, G. S.— <i>Biology of Algæ</i>	72
PIERCY, ALMA— <i>Structure and Mode of Life of Hormidium flacidum</i>	72
HILL, J. BEN— <i>Staining of Marine Algæ</i>	73
GROVE, W. B.— <i>Pleodorina illinoensis</i>	73
CHEN, S. S.— <i>Spirogyra</i>	74
BOURQUIN, HELEN— <i>Starch-formation in Zygnema</i>	74
PUYMALY, A. DE— <i>Dichotomosiphon tuberosus</i>	74

	PAGE
OEHLKERS, F.— <i>Nuclear Division in Characeæ</i>	75
SVEDELIUS, N.— <i>Alternation of Generations in Florideæ</i>	75
MAZZA, A.— <i>Oceanic Algology</i>	76
COLLINS, F. S., & A. B. HERVEY— <i>Algæ of Bermuda</i>	76
MUENSCHER, W. L. C.— <i>Algal Associations of San Juan Island</i>	77
HURD, MISS, & OTHERS— <i>Puget Sound Algæ</i>	77
BÖRGENSEN, F., & M ^{ME} . PAUL LEMOINE— <i>Marine Algæ of the Danish West Indies</i>	78
YENDO, K.— <i>Japanese Marine Algæ</i>	78
TEILING, E.— <i>Caledonian Phytoplankton</i>	213
SCHILLER, J.— <i>Heterodinium in the Adriatic</i>	214
MANGIN, L.— <i>Chætoceros criophilus</i>	214
PETER, A.— <i>Diatoms from Hanover and the Harz</i>	215
ELMORE, C. J.— <i>Changing Diatoms of Devil's Lake, North Dakota</i>	215
TILDEN, J. E.— <i>Myzophyceæ of North America</i>	215
TRANSEAU, E. N.— <i>Algæ of Michigan</i>	215
HARRIS, G. T.— <i>Desmid Flora of Dartmoor</i>	215
SCHILLER, J.— <i>Meringosphæra</i>	216
MACCAUGHEY, V.— <i>Algæ of the Hawaiian Archipelago</i>	216
SAMSONOFF-ARUFFO, C.— <i>Calcareous Algæ from Malta</i>	216
ROSENVINGE, L. N.— <i>Marine Algæ of Denmark</i>	216
PASCHER, A.— <i>Rhizopodial Development of the Flagellatæ. I. Some Rhizopodial</i> <i>Chrysomonads with Chromatophores</i>	322
.. — <i>Rhizopodial Development of the Flagellatæ. II. Dinamœba varians</i> <i>—a Novelty with Dinoflagella-like Swimmers</i>	322
.. — <i>Rhizopodial Development of the Flagellatæ. III. Rhizopodial Nets</i> <i>as Capturing-apparatus in a Plasmodial Chrysomonal</i>	322
.. — <i>Rhizopodial Development of the Flagellatæ. IV. Fusion-plasmodia</i> <i>in Flagellatæ and their Significance in the Descent of Rhizopods</i> <i>from Flagellatæ</i>	323
LEBOUR, MARIE V.— <i>Microplankton of Plymouth Sound</i>	323
.. — <i>Peridinales of Plymouth Sound</i>	323
TSCHENZOFF, B.— <i>Nuclear Division in Euglena viridis</i>	323
HARTMANN, M.— <i>Nuclear Division in Chlorogonium elongatum</i>	324
SCHUSSNIG, B.— <i>Fresh-water Algæ of the Austrian Coast Districts</i>	324
OESTRUP, E.— <i>Marine Diatoms from the Coasts of Iceland</i>	324
OKUDA, Y., & S. NAKAYAMA— <i>The Quality of "Asakusanori"</i>	324
MATSUI, H.— <i>Relation between the Chemical Constituents of "Asakusanori" and its</i> <i>Quality</i>	324
OKUDA, Y., & P. ETO— <i>Iodine in Marine Algæ</i>	325
HOWE, MARSHALL A.— <i>Marine Algæ of Cuba</i>	325

Fungi.

EDISON, H. A.— <i>New Phycomycete</i>	79
GROVE, W. B.— <i>Rhizophidium aciforme</i>	79
MAIN, HUGH— <i>Entomophthora americana</i>	79
MELHUS, I. E.— <i>Peronosporaceæ</i>	79
HODGETTS, W. J.— <i>Discharge of Spores of Leptosphæria acuta</i>	79
STEVENS, F. L.— <i>Speezianian Meliola Types</i>	80
POOL, V. W., & M. B. MCKAY— <i>Infection by Cercospora beticola</i>	80
GROVE, W. B.— <i>Septoria Chenopodii</i>	80

	PAGE
COONS, G. H.— <i>Factors involved in the Growth of Pyenidia</i>	80
BIJK, P. VAN DER— <i>Notes on Coniothecium</i>	81
LONG, W. H., & OTHERS— <i>Uredinæ</i>	81
BROWN, W.— <i>Studies in the Physiology of Parasitism</i>	81
MUTA, ELISA, & GINO POLLACCI— <i>Morphological Variations of Fungi due to Environment</i>	81
SHEAR, C. L.— <i>Studies of the Schweinitz Collection of Fungi</i>	82
LLOYD, C. G.— <i>Mycological Notes</i>	82
DEARNESS, JOHN, & T. TANAKA— <i>New or Noteworthy Fungi</i>	82
BOTTOMLEY, AVERIL MAUD— <i>Natal Fungi</i>	82
MAITLAND, T. D., & E. M. WAKEFIELD— <i>Notes on Uganda Fungi</i>	83
WAKEFIELD, E. M.— <i>Nigerian Fungi. III.</i>	83
PRAEGER, R. LLOYD— <i>Irish Fungi</i>	83
SHARPLES, A.— <i>Rubber Disease</i>	83
WADE, H. WINDSOR— <i>Pathogenic Fungus</i>	84
CARPENTER, C. W.— <i>Tuber-rots caused by Fusarium</i>	84
STAKMAN, E. C.— <i>Immunity from Parasitic Fungi</i>	84
QUANER, H. H., & OTHERS— <i>Plant Diseases</i>	84
LONG, W. H., & OTHERS— <i>Disease of Trees</i>	88
DUFRENÓY, JEAN— <i>Endotrophic Mycorrhiza of Ericaceæ</i>	88
MURPHY, P. A.— <i>Morphology and Cytology of the Sexual organs of Phytophthora erythroseptica Pethyb.</i>	217
ROSENBAUM, J.— <i>Study of Phytophthora</i>	217
WESTON, W. H.— <i>Development of Thraustotheca</i>	217
MOREAU, F., & MADAME— <i>Anomalies in Mucorini</i>	217
LIFE-HISTORY and Poisoning Properties of <i>Claviceps Paspali</i>	217
HAWKINS, L. A.— <i>Effect of Fusarium on Potato Tubers</i>	218
THOM, C., & J. N. CURRIE— <i>Aspergillus niger Group</i>	218
MOREAU, F., & MADAME— <i>Endophyllum Spores</i>	218
POTTER, ALDEN A., & G. W. COONS— <i>Ustilaginæ</i>	219
STAKMAN, E. C., & OTHERS— <i>Uredinæ</i>	219
BOUDIER, E., & OTHERS— <i>New or Rare Fungi</i>	220
YATES, H. S.— <i>Fungi from Southern China</i>	220
HARPER, E. T.— <i>Two Remarkable Discomycetes</i>	220
SHANTZ, H. L., & R. L. PIEMEISEL— <i>Fungus Fairy Rings</i>	220
POOL, V. W., & M. B. MCKAY— <i>Climatic Conditions and Conidial Development</i>	221
THOM, C. H., & S. H. AYERS— <i>Effects of Pasteurization on Mould-spores</i>	221
STEVENS, NEIL E.— <i>Relation of Fungi to Host</i>	221
CULPEPPER, C. W., & OTHERS— <i>Effect of Black-rot Fungus on the Apple</i>	221
HAWKINS, L. A.— <i>Growth of Fungi in Concentrated Solutions</i>	222
WEIR, J. R.— <i>Altitudinal Range of Forest Fungi</i>	222
BROOKS, C. B., & J. S. COOLEY— <i>Apple-rot Fungi in Relation to Temperature</i>	222
WOLF, FREDERICK A.— <i>Citrus Canker</i>	222
MELHUS, I. E., & OTHERS— <i>Spongospora subterranea</i>	223
WEIR, J. R., & OTHERS— <i>Diseases of Plants</i>	223
WILSON, G. W.— <i>North American Peronosporales</i>	325
ERIKSSON, J.— <i>Development of Phytophthora</i>	325
STEVENS, F. L.— <i>Parasites on Meliola</i>	325
DOIDGE, ETHEL M.— <i>South African Perisporiales</i>	326
KILLIAN, KARL— <i>Development of Cryptomyces Pteridis</i>	326
FITZPATRICK H. M.— <i>Sexuality in Rhizina undulata</i>	326
LEHMAN, S. G.— <i>Sphaeronema fimbriatum</i>	327

	PAGE
GRAVATT, G. FILIPPO, & OTHERS— <i>Uredinæ</i>	327
FOOD PRODUCTION OFFICE— <i>Smuts of Cereals</i>	327
HARPER, E. T., & OTHERS— <i>Hymenomycetes</i>	328
MAIRE, L.— <i>Study of Tricholoma</i>	328
LONG, W. H., & R. M. HARSCH— <i>Cultures of Wood-rotting Fungi on Artificial Media</i>	328
NEGER, F. W.— <i>Honey-dew Fungi</i>	328
LLOYD, C. G.— <i>Mycological Notes</i>	329
FRAGOSO, R. G.— <i>New or Rare Fungi</i>	329
TANAKA, TYOZABURO, & ARTHUR S. RHOALES— <i>Diseases of Plants</i>	329
COTTON, A. D., & OTHERS— <i>Description and Treatment of Plant Diseases</i>	329
ELLIS, DAVID— <i>Phycomycetous Fungi from the English Coal Measures</i>	332

Lichens.

PORTER, LILIAN— <i>Attachment Organs of Corticolous Ramalinæ</i>	88
PAULSON, R.— <i>Varenne Collection of Lichens</i>	89
HERBE, A. C.— <i>Lichens of Whatcom County, Washington</i>	89
RIDDLE, L. W.— <i>Notes on Parmeliopsis</i>	89
VESTAL, A. G., & R. HEBER HOWE— <i>Lichen Ecology</i>	89

Mycetozoa.

STURGIS, W. C.— <i>Notes on New or Rare Myzomycetes</i>	90
REA, MARGARET W., & MARGARITA DE STELFOX— <i>Irish Mycetozoa</i>	90
KUNKEL, L. O.— <i>Contribution to the Life-history of Spongospora subterranea</i>	90
MEYLAN, C.— <i>New Mycetozoa</i>	393
„ --- <i>Mycetozoa from the Jura Mountains</i>	393

Schizophyta.

Schizomycetes.

GESSARD, C.— <i>Erythrogeous Variety of Bacillus pyocyaneus</i>	90
BURNET, E.— <i>Bacteria of Dust</i>	90
ELDERS, C.— <i>Intestinal Flora of Sprue</i>	91
MATSUEKA, Y.— <i>Actions of Micro-organisms on Bone-marrow</i>	91
LEYGUE, G., & J. HAGUENAU— <i>Epidemic Dysentery on the Somme</i>	92
CHAPMAN, A. C.— <i>Colouring-matter of Red Torulæ</i>	227
PETRI, L.— <i>Blepharospora cambivora</i>	227
BERTHELOT, A.— <i>Bacillus phenologenes</i>	227
DOIDGE, ETHEL— <i>Bacillus citromaculans</i>	227
DORENDORF— <i>Botulism</i>	393
PFEIFFER, R., & G. BESSAU— <i>Bacteria of Gas Gangrene</i>	394

MICROSCOPY.

A. Instruments, Accessories, etc.

(1) Stands.

BAUSCH & LOMB'S <i>Metallurgical Microscope, CCM</i> (Fig. 1)	PAGE 93
---	------------

(3) Illuminating and other Apparatus.

WILLIAMS, R. S.— <i>Interference Refractometer</i>	94
HUBERT, H.— <i>Use of the Stereoscope for Examining Superposed Projections</i>	94
CLARK, N. J.— <i>Microscope Illumination</i> (Fig. 1)	228
KEELEY, F. J.— <i>Polarization and Colour Effects exhibited by certain Diatoms</i> ..	332
GODSPEED, T. H.— <i>Modified Safety-razor Blade-holder for Temperature Control</i> ..	395
STRUTT, HON. R. J.— <i>Scattering of Light by Dust-free Air, with Artificial Reproduction of the Blue Sky</i> (1 fig.)	395
AINSLIE, M. A.— <i>Some Principles of Illumination</i>	397
REYNOLDS, F. C.— <i>The Polarization of Light</i>	397
ANGUS, H. F., & Co.— <i>The Barnard Incandescent Gas Lamp</i> (1 fig.)	397

(4) Photomicrography.

COLES, A. C.— <i>Spirochæta icterohæmorrhagica</i>	228
EGGLESTON, H. R.— <i>Photomicrographs in Colour</i>	229
KODAK, LIMITED— <i>Wratten "M" Filters</i> (4 figs.)	398
HALLIMOND, A. F.— <i>Telescopic Focussing Apparatus for Photomicrography</i> (1 fig.)	400

(5) Microscopical Optics and Manipulation.

GUILD, J.— <i>Spherometer of Precision</i>	95
GRAYSON, J. H.— <i>Dividing-engine for Ruling Diffraction Gratings</i>	229
MERWIN, H. E.— <i>Dispersion and other Optical Properties in Carborundum</i>	230
BALE, W. M.— <i>Measurement of Magnifying Power</i>	230
MERWIN, H. E.— <i>Optical Properties and Theory of Colour of Pigments and Paints</i>	401

(6) Miscellaneous.

FRENCH, J. W.— <i>Balsam Problem</i>	230
BOSWELL, P. G. H., & OTHERS— <i>British Resources of Sands and Rocks used in Glass Manufacture, with Notes on certain Refractory Materials</i>	231
WRIGHT, F. E.— <i>Petrographic Microscope</i>	231
CHAMOT, E. M.— <i>Chemical Microscopy</i>	402

B. Technique.

(1) Collecting Objects, including Culture Processes.

BAZIN— <i>Method for Discovering Fungi in the Sputum of Bronchitics</i>	96
CUTLER, D. W., & R. WILLIAMSON— <i>Rapid Differentiation of Amœbæ Cysts</i>	96
SCHNEIN, H.— <i>Studies in Cattle-plague</i>	96

	PAGE
SHILTON, A. W.— <i>Vitality of Rinderpest Virus outside the Animal Body</i>	97
TULLOCH, W. J.— <i>Medium for Cultivating Bacillus tetani</i>	231
BOQUET, A., & L. NÈGRE— <i>Cultivating the Parasite of Epizootic Lymphangitis</i>	232

(2) Preparing Objects.

MANALONG, C.— <i>Demonstrating Degeneration of Peripheral Nerves</i>	98
GATENEY, J. B.— <i>Demonstrating the Cytoplasmic Inclusion of Germ-cells</i>	98
HOLLANDE, A. C.— <i>Modification of Bouin's Fluid</i>	232
STRONG, L. W.— <i>Short Method of Preparing Histological Material</i>	232

(3) Cutting, including Embedding and Microtomes.

METCALF, H. E.— <i>Electrifying the Microtome</i>	232
---	-----

(4) Staining and Injecting.

SENEVET, G.— <i>Improvised Staining of Malarial Parasites</i>	98
ROUBAUD, E.— <i>Rapid Examination of Malarial Blood</i>	99
TRIBONDEAU, L.— <i>Staining Sporogenous Bacteria</i>	99
HORNLYOLD, A. GONDOLFI— <i>Staining Young Eels</i>	99
TRIBONDEAU, L.— <i>Staining Tubercle Bacilli</i>	100
BOTELHO, C.— <i>Simple Method for Double-staining Sporulating Bacteria</i>	233
CÉPÈDE, C.— <i>New Method of Staining the Tubercle Bacillus</i>	233
SPEHL, P.— <i>Staining Spirilla with Formol-violet</i>	403
„ — <i>Double Staining of the Tubercle Bacillus: a Modification of Speugler's Method</i>	403

(5) Mounting, including Slides, Preservative Fluids, etc.

KLOCKER, A.— <i>Preservation of Fermentation Organisms in Nutrient Media</i>	100
CROPPER, J. W.— <i>New Counting Chamber</i>	233

(6) Miscellaneous.

SÉZARY, A.— <i>Rapid Method for obtaining Hæmolytic Serum</i>	101
FOUCHET, A.— <i>Detection of Bile-pigments in Blood-serum</i>	101

Metallography, etc.

CHARPY, G., & S. BONNEROT— <i>Heterogeneity of Steels</i>	102
JEFFRIES, Z.— <i>Tungsten-Molybdenum Alloys</i>	102
COMSTOCK, G. F.— <i>Method for Distinguishing Sulphides from Oxides in Steel</i>	103
MATHEWSON, C. H., & P. DAVIDSON— <i>Annealing of Bronze</i>	103
RAWDON, H. S.— <i>An Unusual Feature in the Microstructure of Wrought-Iron</i>	103
ELLIS, O. W.— <i>Comparison Screen for Brass</i>	234
JEFFRIES, Z.— <i>Effect of Great Hydrostatic Pressure on Metals</i>	234
MILLER, S. W.— <i>Etching with Chromic Acid and Hydrogen Peroxide</i>	234
HURST, J. E.— <i>Heat-treatment of Grey Cast Iron</i>	235
MORGANS, T. D., & F. ROGERS— <i>Uniformity of a Cast of Acid Open-hearth Steel</i>	235
BROOKE, W. J., & F. F. HUNTING— <i>Microstructure of Commercially Pure Iron between</i> <i>Ar₃ and Ar₂</i>	235
BIBLIOGRAPHY	236
COOKE, C. J. BOWEN— <i>Testing Hardness of Metals by the Boyelle-Morin Apparatus</i>	403
ONSLow, H.— <i>Nature of Growths in Colloidal Silica Solutions</i>	404

Industrial Processes.

	PAGE
HARRISON, W.— <i>Investigations on Textile Fibres</i>	404

NOTICES OF NEW BOOKS

HARSHBERGER, JOHN W.— <i>A Text-book of Mycology and Plant Pathology</i>	330
CUSHMAN, J.— <i>The Foraminifera of the Atlantic Ocean. Part I. Astrorhizidæ</i> ..	405
WOOD, CASEY ALBERT— <i>The Fundus oculi of Birds, especially as viewed by the Ophthalmoscope: a Study in Comparative Anatomy and Physiology</i>	407
MILNER & PART— <i>Methods in Practical Petrology</i> (1 fig.)	408
SILBERSTEIN, LUDWIK— <i>Simplified Method of Tracing Rays through any Optical System</i>	409
„ „ — <i>Elements of the Electro-magnetic Theory of Light</i>	409

PROCEEDINGS OF THE SOCIETY.

Meeting, December 19, 1917	105
„ January 16, 1918	108
„ February 20, „	113
„ March 20, „	237
Special General Meeting, April 17, 1918	240
Meeting, April 17, 1918	241
„ May 15, „	244
„ June 19, „	333
„ October 16, „	410
„ November 20, „	420

GENERAL INDEX TO VOLUME	429
---------------------------------	-----

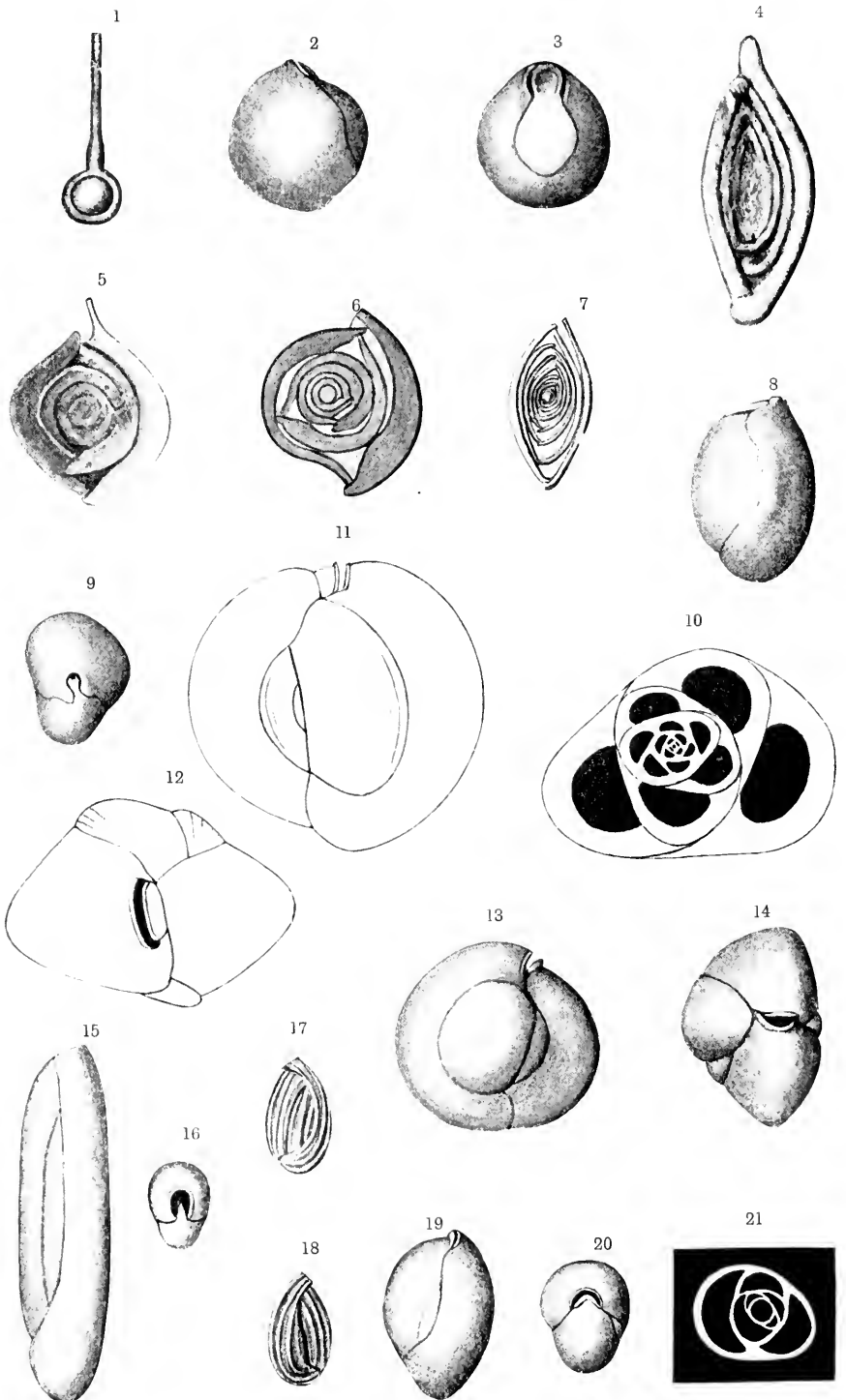

JOURNAL
OF THE
ROYAL MICROSCOPICAL SOCIETY.

MARCH, 1918.

TRANSACTIONS OF THE SOCIETY.

I.—*Report on the Recent Foraminifera dredged off the East Coast of Australia. H.M.S. "Dart," Station 19 (14 May, 1895), Lat. 29° 22' S., Long. 153° 51' E., 465 fathoms. Pteropod Ooze.*

By HENRY SIDEBOTTOM.

[Communicated by E. HERON-ALLEN and A. EARLAND.]

(Read October 17, 1917.)

PLATES I.-II.

INTRODUCTION.

THE material which forms the subject of this paper, and which had been already washed, was sent to me by Mrs. Thornhill after her husband's death. It had been examined, the *Lagenæ* picked out

EXPLANATION OF PLATE I.

FIGS.

- 1.—*Nubecularia tibia* Jones and Parker. × 75.
- 2, 3.—*Biloculina irregularis* d'Orbigny (?). Fig. 2, lateral view. Fig. 3, front view. × 50.
- 4.—*Spiroloculina nitida* d'Orbigny. × 25.
- 5-7.—*S. tenuiseptata* Brady. Fig. 6 mounted in Canada balsam, and viewed by transmitted light. × 75.
- 8-10.—*Miliolina valvularis* (Reuss). Fig. 9, oral view. × 25. Fig. 10, transverse section. × 75.
- 11-14.—*M. procera* Goës. Figs. 11, 13, lateral views. Figs. 12, 14, oral views. × 25.
- 15, 16.—*M. oblonga* (Montagu). Fig. 15, lateral view. Fig. 16, oral view. × 50.
- 17, 18.—*M. limbata* (d'Orbigny). Figs. 17, 18, lateral views. × 75.
- 19-21.—*M. circularis* (Bornemann) var. Fig. 19, lateral view. Fig. 20, oral view. × 50. Fig. 21, transverse section. × 75.

March 20th, 1918

B

(see Note p. 20) and slides of the other forms prepared, but owing to the absence of certain species on the slides, which I felt sure must be present in the material, I went carefully through it again, and filled in many omissions. The material weighed (after washing) a little over $2\frac{1}{2}$ drams avoirdupois.

I have to thank Messrs. Heron-Allen and Earland for assistance in the identification of some species, and in the preparation of the MS.; Mr. Joseph Wright, of Belfast, for lending me parts of the late Mr. Millett's album of drawings of published figures; and my daughter for finally writing out the MS.

H. S.

The scanty details furnished in the title of the paper constitute all the available records of the dredging, but are sufficient for a reconstitution of its origin.

The locality lies off the N.E. corner of the coast of New South Wales, roughly 250 miles north of Sydney, and more than 300 miles south of the extremity of the Great Barrier Reef. The distance from the coast-line is over 50 miles, which, coupled with the depth of 465 fathoms, show that the material was taken from the continental shelf beyond the mud line or limit of terrigenous deposits. The coast in this area slopes rapidly down to the "Thomson Basin," an isolated deep area lying between 24° and 52° S. and 149° and 165° E., and having a maximum depth of 3000 fathoms.

"Pteropod Oozes" are found only in tropical and sub-tropical areas at a considerable distance from land, and with a depth of less than 1500 fathoms. The late Sir John Murray and G. V. Lee in their report on "The Depth and Marine Deposits of the Pacific" (*Memoirs Mus. Comparative Zoology*, 1909, vol. xxxviii., No. 1, p. 155), draw attention to the absence of this type of deposit in the Northern and Eastern Pacific, and its extremely limited distribution in the few localities where it is to be found, viz. in the neighbourhood of the Great Barrier Reef, the Fiji, Paumotu and Marquesas groups.

H.-A. & E.

SUB-KINGDOM PROTOZOA.

CLASS RHIZOPODA.

ORDER FORAMINIFERA (RETICULARIA).

Family MILIOLIDÆ.

Sub-family Nubecularinæ.

Nubecularia Defrance.

Nubecularia tibia Jones and Parker. (Pl. I, fig. 1.)

Nubecularia tibia Jones and Parker, 1860, Quart. Journ. Geol. Soc., vol. xvi, p. 455, pl. xx, figs. 48-51.

N. tibia Millett, 1898, etc., 1898, Rept. Rec. Foram. Malay Archipelago, Journ. Roy. Micr. Soc., p. 261, pl. v, fig. 3.

Fragments occur consisting of from one to three segments. A solitary translucent specimen has the initial chamber attached. See illustration and Millett's remarks in the above reference under *Articulina conico-articulata* Batsch.

Sub-family Miliolinæ.

Biloculina d'Orbigny.

Biloculina depressa d'Orbigny.

Biloculina depressa d'Orbigny, 1826, Ann. Sci. Nat., vol. vii, p. 298, No. 7.

B. depressa d'Orbigny, Brady, 1884, Chall. Rept., p. 145, pl. ii, figs. 12, 15-17; pl. iii, figs. 1, 2.

The orifice, in some of the tests, is a long slit, in others it is oval and at the end of a short neck.

Biloculina depressa, var. *murrhyna* Schwager.

Biloculina murrhyna Schwager, 1866, Novara-Exp. Geol. Theil, vol. ii, p. 203, pl. vi, fig. 15 a-c.

B. depressa, var. *murrhyna*, Brady, 1884, Chall. Rept., p. 146, pl. ii, figs. 10, 11.

A solitary example. The basal spines are not pronounced.

Biloculina levis (Defrance).

Pyrgo levis Defrance, 1824, Dict. Sci. Nat., vol. xxxii, p. 273, Atlas, pl. lxxxviii, fig. 2.

Biloculina levis, Brady, 1884, Chall. Rept., p. 146, pl. ii, figs. 13, 14.

The specimens are of the "depressa" type. The subsidiary keel is not well developed.

Biloculina bulloides d'Orbigny.

Biloculina bulloides d'Orbigny, 1826, Ann. Sci. Nat., vol. vii, p. 297, No. 1, pl. xvi, figs. 1-4.

B. bulloides Brady, 1884, Chall. Rept., p. 142, pl. ii, figs. 5, 6.

Two typical tests occur, though one of them has a rather long, narrow flange projecting at its base.

Biloculina ringens (Lamarck).

Miliolites ringens, Lamarck, 1804, Ann. du Muséum, vol. v, p. 351, No. 1, vol. ix, pl. xvii, fig. 1.

Biloculina ringens Brady, 1884, Chall. Rept., p. 142, pl. ii, figs. 7, 8.

The orifice varies in shape. One test has the mouth composed, as it were, of two flanges, the opening being a narrow slit. Another test has its width greater than its height, and others again tend towards *B. elongata* d'Orb.

Biloculina irregularis d'Orbigny. (Pl. I, figs. 2, 3 (?).)

Biloculina irregularis d'Orbigny, 1839, Foram. Amer. Mérid., p. 67, pl. viii, figs. 20, 21.

Characteristic examples occur. There are also a number of small, polished globular tests, which I do not think are immature specimens of the above. They may be the *B. globulus* of Reuss. An interesting set, from which I have chosen one specimen for illustration.

Biloculina sphaera d'Orbigny.

Biloculina sphaera d'Orbigny, 1839, Foram. Amer. Mérid., p. 66, pl. viii, figs. 13-16.

B. sphaera Brady, 1884, Chall. Rept., p. 141, pl. ii, fig. 4, a, b.

A solitary example. Schlumberger treats this form as *Planispirina*, but until the consensus of opinion is more definite upon the subject, it is perhaps as well to keep it among the *Biloculinae*.

Biloculina comata Brady.

Biloculina comata Brady, 1881, Quart. Journ. Micr. Sci., vol. xxi, N.S., p. 45.

B. comata Brady 1884, Chall. Rept., p. 144, pl. iii, fig. 9, a, b.

The tests agree with the "Challenger" illustrations.

Spiroloculina d'Orbigny.*Spiroloculina excavata* d'Orbigny.

Spiroloculina excavata d'Orbigny, 1846, For. Foss. Vienne, p. 271, pl. xvi, figs. 19-21.

S. excavata Brady, 1884, Chall. Rept., p. 151, pl. ix, figs. 5, 6.

Four occur. They agree well with d'Orbigny's figures in the above reference.

Spiroloculina impressa Terquem.

Spiroloculina impressa Terquem, 1878, Mém. Soc. Géol. Fr., sér. 3, vol. i, p. 53, pl. x, fig. 8.

S. impressa Brady, 1884, Chall. Rept., p. 151, pl. x, figs. 3, 4.

S. impressa Sidebottom, 1904, Rec. Foram. Isl. Delos, Mem. Manchester Lit. Phil. Soc., vol. xlviii, p. 15, pl. ii, figs. 9-11.

The specimens are small, but agree well with the "Challenger" and "Delos" tests.

Spiroloculina nitida d'Orbigny. (Pl. I, fig. 4.)

Spiroloculina nitida d'Orbigny, 1826, Ann. Sci. Nat., vol. vii, p. 293, No. 4.

S. nitida, Millett, 1898, etc., For. Malay Archipelago, Journ. Roy. Micr. Soc., p. 265, pl. v, figs. 9-13.

The specimens are in a curious condition, looking as if they had been plastered over with débris, and it is difficult to make out the earlier chambers. The surface is dull. The final chamber is produced, and swollen near the orifice. Three found.

Spiroloculina tenuis Czjzek.

Quinqueloculina tenuis Czjzek, 1848, Haidinger's Naturw. Abhandl., vol. ii, p. 149, pl. xiii, figs. 31-34.

Spiroloculina tenuis Brady, 1884, Chall. Rept., p. 152, pl. x, figs. 7-11.

Two varieties. One typical, and the other similar to the "Challenger" illustration, pl. x, fig. 9.

Spiroloculina acutimargo Brady.

Spiroloculina acutimargo Brady, 1884, Chall. Rept., p. 154, pl. x, figs. 12-15.

Both forms as represented by the "Challenger" figures, 12, 13, are present.

Spiroloculina tenuiseptata Brady. (Pl. I, figs. 5-7.)

Spiroloculina tenuiseptata Brady, 1884, Chall. Rept., p. 153, pl. x, figs. 5, 6.

Figs. 5, 6.—This is an interesting, almost circular form. The "shelly septum" is concealed by granular substance in most cases, but a specimen mounted in Canada balsam reveals it clearly, as shown in fig. 6. The peripheral edge is channelled. The orifice is situated at the end of a produced neck. In fig. 6 the neck is broken off. Under the name *Spiroloculina dorsata* Reuss, var. *circularis*, Chapman (1915, Zool. Res. "Endeavour," Nat. Mus. Melbourne, vol. iii., pt. 1, p. 7, pl. i, fig. 1) figures a form which appears to be like that illustrated and described above, but he gives few particulars, and without seeing his specimens it is impossible to say whether our specimens are identical or not. The arrangement of the early chambers as viewed in balsam strongly

suggest *Ophthalmidium*, but the dorsal edge is double and grooved, and it may prove to be a transition form.

Fig. 7.—Five occur, but only one is in perfect condition. The tests are transparent and exceedingly fragile, showing no signs of the “shelly septum” mentioned by Brady. They are similar to the “Challenger” illustration, fig. 6, except that the “septum” is wanting. The chambers are tubular, and support each other by touching at the sides for a short portion of their length. It is astonishing that a perfect test should have been found, after the treatment of washing the material. The other four examples have their central chambers missing. Possibly this form is a local variation.

Spiroloculina (?) *convexiuscula* Brady.

Spiroloculina (?) *convexiuscula* Brady, 1884, Chall. Rept., p. 155, pl. x, figs. 18–20.

A single specimen, which appears to be typical.

Miliolina Williamson.

Miliolina valvularis (Reuss). (Pl. I, figs. 8–10.)

Triloculina valvularis Reuss, 1851, Zeitschr. d. deutsch. geol. Gesell., vol. iii, p. 85, pl. vii, fig. 56.

Miliolina valvularis Brady, 1884, Chall. Rept., p. 161, pl. iv, figs. 4, 5.

The overlapping of the chambers is so neatly finished off that in some of the examples the edges cannot be distinguished. The section shows the test to be triloculine and the shell-wall thick.

Miliolina seminulum (Linné).

Serpula seminulum Linné, 1767, Syst. Nat., 12th ed., p. 1264, No. 791.

Miliolina seminulum Williamson, 1858, Rec. Foram. Gt. Britain, p. 85, pl. vii, figs. 183–185.

Tests occur that are rather short and stout, but of good size. A few small semi-translucent specimens are also present.

Miliolina procera Goës. (Pl. I, figs. 11–14.)

Miliolina procera Goës, 1896, Bulletin, Mus. Comp. Zoölogy, Harvard College, U.S.A., vol. xxix, No. 1, p. 82, pl. vii, figs. 7–9.

Goës states that this is a short, inflated variety of *M. seminulum*, and makes further remarks as to its probable allies. One of the three specimens, figs. 11, 12, is very large, and shows the faint longitudinal striation on the antepenultimate segment to which Goës refers in his remarks. The aperture is rather narrow and lipped.

Miliolina oblonga (Montagu). (Pl. I, figs. 15, 16.)

Vermiculium oblongum Montagu, 1803, Test. Brit., p. 522, pl. xiv, fig. 9.

Triloculina oblonga d'Orbigny, 1839, Foram. Cuba, p. 175, pl. x, figs. 3-5.

Miliolina seminulum, var. *oblonga* Williamson, 1858, Rec. For. Gt. Br., p. 86, pl. vii, figs. 186, 187.

Only one is typical. Three are roughly triangular in cross-section, with the corners rounded off. Five are almost tubular, as shown in figs. 15, 16, pl. I.

Miliolina bosciiana (d'Orbigny).

Quinqueloculina bosciiana d'Orbigny, 1839, Foram. Cuba, p. 191, pl. xi, figs. 22-24.

Very rare and not well developed.

Miliolina tricarinata (d'Orbigny).

Triloculina tricarinata d'Orbigny, 1826, Ann. Sci. Nat., vol. vii, p. 299, No. 7, Modèle, No. 94.

Miliolina tricarinata Brady, 1884, Chall. Rept., p. 165, pl. iii, fig. 17.

Typical specimens occur, their edges being quite sharp.

Miliolina limbata (d'Orbigny). (Pl. I, figs. 17, 18.)

Quinqueloculina limbata d'Orbigny, 1826, Ann. Sci. Nat., p. 302, No. 20.

Q. limbata Fornacini, 1905, sp. Orb. Miliolidi, p. 66, pl. iii, fig. 9.

Miliolina limbata Heron-Allen and Earland, 1915, Foram. Kerimba Archipelago, Trans. Zool. Soc., London, vol. xx, pl. xvii, p. 577, pl. xliv, figs. 5-8.

I have some doubts in placing this form under the above heading. Heron-Allen and Earland, in the text, speak of it as being quinqueloculine. Miue may be the triloculine form. Of the four specimens found, one is much more elongate than the others and approaches the type-figure as regards length and breadth. The one I have figured is more oval in outline, and bears a strong resemblance to Heron-Allen and Earland's illustration, fig. 6. It also resembles *Triloculina reversa*, fig. 1, pl. ii, in Fornasini's work; see above reference. The orifice is almost circular, and has a small tooth.

Miliolina stelligera (Schlumberger).

Quinqueloculina stelligera Schlumberger, 1893, Mém. Soc. Zool., France, vol. vi, p. 68, pl. ii, figs. 58, 59.

Miliolina stelligera Sidebottom, 1904, Rept. Rec. Foram. Isl. Delos, Mem. and Proc. Lit. Phil. Soc., Manchester, vol. xlviii, pt. i, p. 14.

M. stelligera Heron-Allen and Earland, 1913, Clare Isl. Proc. Roy. Irish Acad., vol. xxxi, p. 31, pl. i, figs. 14, 15.

M. stelligera Heron-Allen and Earland, 1916, For. W. of Scotland, Trans. Linnean Soc., London, second series, Zool., vol. xi, pt. 13, p. 215, pl. xxxix, figs. 28-31.

The tests agree both with specimens sent me by M. Schlumberger, and those from the coast of Delos, and show the contrast in colour between the walls of the chambers and the keels.

Miliolina circularis (Bornemann).

Triloculina circularis Bornemann, 1855, Zeitschr. d. deutsch Geol. Gesell., vol. vii, p. 349, pl. xix, fig. 4.

Miliolina circularis Brady, 1884, Chall. Rept., p. 169, pl. iv, fig. 3, a, b, c, pl. v, figs. 13, 14?

The tests agree fairly well with the "Challenger" illustration, pl. iv, fig. 3, but they are built up more compactly.

Miliolina circularis (Bornemann) var. (Pl. I, figs. 19-21.)

This variation is roughly oval in outline and only slightly compressed, and the antepenultimate chamber is very little exposed. The orifice, which is arched, is nearly closed by the tooth, and the test is not polished. Mr. Earland kindly drew my attention to the *T. laevigata* of Bornemann, 1855, Zeitschr. deutsch. geol. Ges. vol. vii, p. 350, pl. xix, fig. 5, with which it appears to be almost identical.

Miliolina bucculenta (?) Brady. (Pl. II, figs. 1, 2.)

Miliolina bucculenta Brady, 1884, Chall. Rept., p. 170, pl. cxiv, fig. 3, a, b.

I am a little doubtful as to the identification of these curious forms, so have inserted a query. They are triloculine, and the antepenultimate chamber is very little exposed. The orifice, a narrow slit, is slightly lipped. The test is a little compressed at right angles to the mouth.

There are three examples. The only difference between the one illustrated and the others is that in the former the small,

EXPLANATION OF PLATE II.

FIGS.

- 1, 2.—*Miliolina bucculenta* (?) Brady. Fig. 1, lateral view. Fig. 2, front view. × 50.
 3, 4.—*Sigmoilina ovata* Sidebottom. Fig. 3, lateral view. Fig. 4, oral view. × 25.
 5-8.—*Ophthalmidium inconstans* Brady. Figs. 5, 6, lateral views. × 50. Fig. 7 × 50. Fig. 8 × 25.
 9.—*Reophae guttifera* Brady. × 50.
 10.—*Haplophragmium agglutinans* (d'Orbigny). × 50.
 11-14.—*H. globigeriniforme* (Parker and Jones). Figs. 11-13, superior views. Fig. 14, edge view. × 25.
 15, 16.—*H. sphaeriloculum* (Cushman). Fig. 15, lateral view. Fig. 16, edge view. × 50.
 17.—*Trochammima robertsoni* Brady. Fig. 17, lateral view. × 75.
 18.—*T. plicata* (Terquem) var. Fig. 18, superior view. × 75.
 19-21.—*Textularia inconspicua* Brady. Fig. 19, superior view. Fig. 20, inferior view. Fig. 21, lateral view. × 75.
 22, 23.—*Spiroplecta annectens* (Parker and Jones). Figs. 22, 23, lateral views. × 75.
 24, 25.—*Gaudryna siphonella* Reuss. Figs. 24, 25, lateral views. × 50.
 26.—*G. scabra* Brady. Fig. 26, lateral view. × 50.

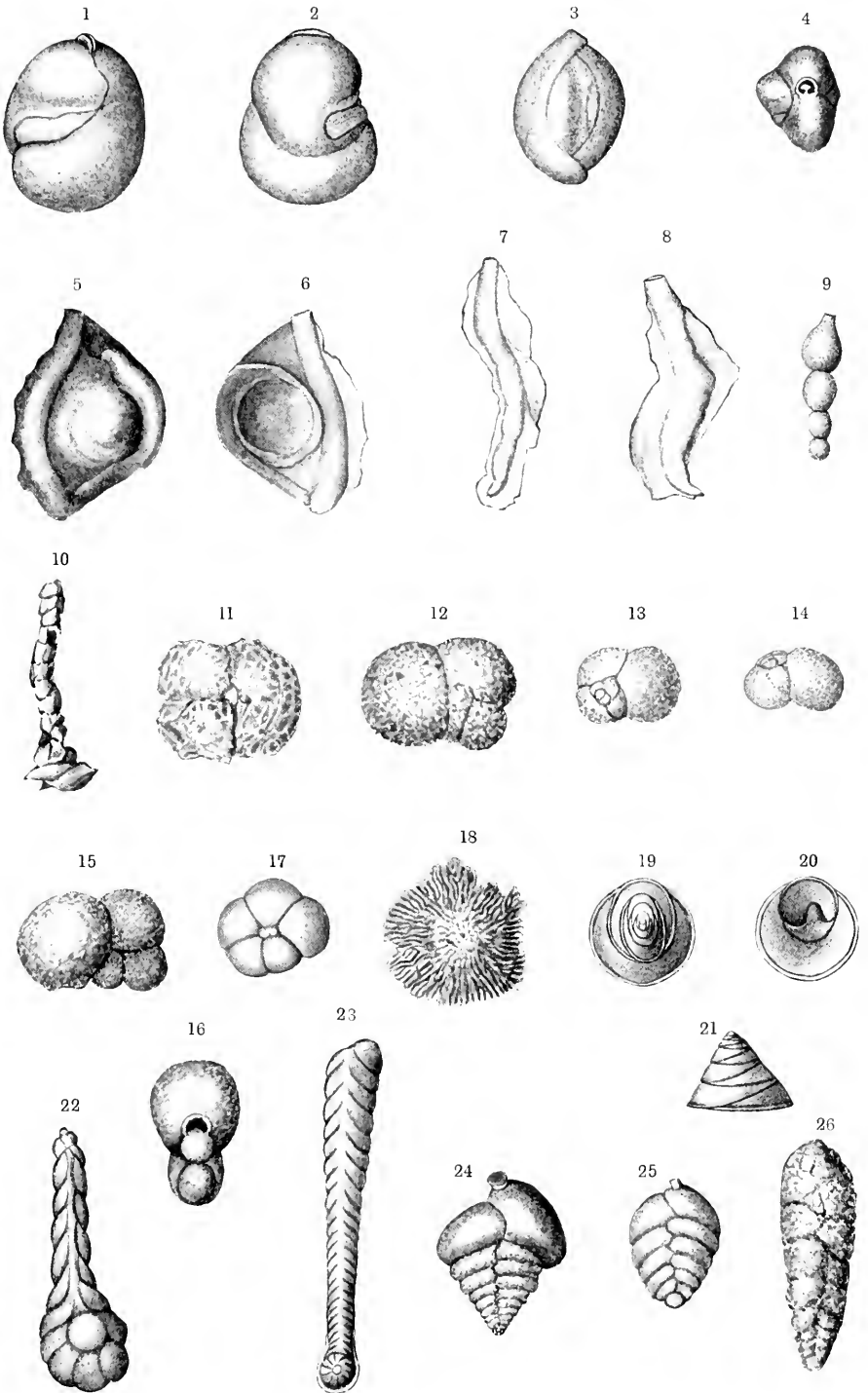

exposed chamber extends more to the front. There is a curious resemblance between my figure and Goës', fig. 374, pl. x, Ret. Rhiz. Caribbean Sea, 1882, except as regards the position of the aperture, but there is a great difference in the faces of our tests. Goës considers his form to be an irregular triloculine form of *M. ringens* Lamarck.

Sub-genus *Sigmoilina* (Schlumberger).

Sigmoilina edwardsi (Schlumberger).

Planispirina (*Sigmoilina*) *edwardsi*, Schlumberger, 1887, Bull. Soc. Zool., France, vol. xii, p. 483, text-fig. 8, pl. vii, figs. 15-18.

Sigmoilina edwardsi, Heron-Allen and Earland, 1915, Foram. Kerimba Archipelago, part ii, Trans. Zool. Soc., London, vol. xx, part xvii, p. 584, pl. xlv, figs. 19-21.

The tests are small and highly polished. Two appear to have no tooth in the aperture, and in this respect they agree with the type form, but the others have the aperture blocked with what looks like granular substance, and in these the aperture may be cribrate.

Sigmoilina ovata Sidebottom. (Pl. II, figs. 3, 4.)

Sigmoilina ovata Sidebottom, 1904, etc., Rec. Foram. Isl. Delos, Mem. Manchester Lit. Phil. Soc., 1904, p. 6, pl. ii, figs. 12, 13, text-fig. 1.

S. ovata, Heron-Allen and Earland, 1915, Foram. Kerimba Archipelago, part ii, Trans. Zool. Soc., London, vol. xx, part xvii, p. 584, pl. xlv, figs. 16-18.

Some of the tests are of larger size than the Delos specimens, and there is a slight difference in colour and in the appearance of the surface. The Delos specimens in my cabinet show signs of deterioration, and it appears to be a difficult species to preserve. My illustrations in the Delos paper are not satisfactory, and Heron-Allen and Earland in their Kerimba work give a much better representation. They consider *S. ovata* to be closely allied to *S. edwardsi* Schlumberger. The specimens in my collection, which I take to be typical *S. edwardsi*, differ from *S. ovata*, both in contour and in the texture of the surface. The former has a highly polished test to which Schlumberger draws particular attention.

Sub-family Hauerininæ.

Articulina d'Orbigny.

Articulina funalis Brady.

Articulina funalis Brady, 1884, Chall. Rept., p. 185, pl. xiii, figs. 6-11.

These call for no remarks. Rare.

Articulina funalis, var. *inornata* Brady.

Articulina funalis, var. *inornata* Brady, 1884, Chall. Rept., p. 186, pl. xiii, figs. 3-5.

A. funalis, var. *inornata* Millett, 1898, Foram. Malay Archipelago, Journ. Roy. Micr. Soc., 1898, p. 513, pl. xii, fig. 11.

The specimens agree with Millett's figure. Very rare.

Ophthalmidium Kübler.

Ophthalmidium inconstans Brady. (Pl. II, figs. 5-8.)

Ophthalmidium inconstans Brady, 1884, Chall. Rept., p. 189, pl. xii, figs. 5, 7, 8.

There are four tests, and they are not in a good state for examination. There is a certain amount of smooth shell-growth overspreading them. One tends towards the circular in outline, another is more elongate, while the two largest ones are convex on the face of the test and concave on the reverse side, as shown in the drawings (figs. 5, 6). I also illustrate two fragments (figs. 7, 8), which must have come from large specimens. At first I took these two to be a carinate form of *Nubecularia*, but on comparing them with large specimens of *Ophthalmidium inconstans* in my collection their true character was revealed.

Planispirina Seguenza.

Planispirina celata (Seguenza).

Spiroloculina celata Costa, 1855, Mém.-Accad. Napoli, vol. ii, p. 126, pl. i, fig. 14; 1856, Atti dell' Accad. Pont., vol. vii, pl. xxvi, fig. 5.

Planispirina celata Brady, 1884, Chall. Rept., p. 197, pl. viii, figs. 1-4.

The tests are rather more roughly built than is usual in the specimens I have hitherto found.

Planispirina sigmoidea Brady.

Planispirina sigmoidea Brady, 1884, Chall. Rept., p. 197, pl. ii, figs. 1-3; woodcut, fig. 5, c.

Most of the tests have a sharp edge.

Planispirina auriculata Egger.

Planispirina auriculata Egger, 1893, Abhandl. k. bayer. Akad. Wiss. Cl. ii, vol. xviii, p. 245, pl. iii, figs. 13-15.

P. auriculata Heron-Allen and Earland, 1915, Foram. Kerimba Archipelago, pt. ii, Trans. Zool. Soc., London, vol. xx, pt. xvii, p. 590, pl. xlvi, figs. 3-7.

The folding down of the circular orifice on one side of the test is a curious feature of this species.

Sub-family **Peneroplidinæ**.

Cornuspira Schultz.

Cornuspira involvens (Reuss).

Operculina involvens Reuss, 1849, Denkschr. d. k. Akad. Wiss. Wien, vol. i, p. 370, pl. xlvi, fig. 20.

Cornuspira involvens Brady, 1884, Chall. Rept., p. 200, pl. xi, figs. 1-3.

The tests are all of the microspheric form.

Cornuspira carinata (Costa).

Operculina carinata Costa, 1856, Atti dell' Accad. Pont., vol. vii, p. 209, pl. xvii, fig. 15.

Cornuspira carinata Brady, 1884, Chall. Rept., p. 201, pl. xi, fig. 4.

A solitary example, which it seems right to place under this heading. The edge of the test is sharp.

Family **ASTRORHIZIDÆ**.

Sub-family **Saccammininæ**.

Psammosphæra Schulze.

Psammosphæra fusca Schulze.

Psammosphæra fusca Schulze, 1874, II. Jahressb. Untersuch. deutsch. Meere in Kiel, p. 113, pl. ii, fig. 8.

P. fusca Brady, 1884, Chall. Rept., p. 249, pl. xviii, figs. 1-8.

The tests are small in size, and built up of clear sand grains. One only is of typical colour. Very rare.

Sub-family **Rhabdammininæ**.

Hyperammina H. B. Brady.

Hyperammina ramosa Brady.

Hyperammina ramosa Brady, 1879, Quart. Journ. Micro. Sci., vol. xix, N.S., p. 33, pl. iii, figs. 14, 15.

H. ramosa Brady, 1884, Chall. Rept., p. 261, pl. xxiii, figs. 15-19.

There are two fragments, which appear to belong to this species; also several branching fragments which are probably of the same kind.

Hyperammina vagans Brady.

Hyperammina vagans Brady, 1879, Quart. Journ. Micro. Sci., vol. xix, N.S., p. 33, pl. v, fig. 3.

H. vagans, Brady, 1884, Chall. Rept., p. 260, pl. xxiv, figs. 1-9.

One specimen, attached to a fragment of shell. It is almost white in colour, and imperfect in places.

Marsipella Norman.*Marsipella cylindrica* Brady.

Marsipella cylindrica Brady, 1882, Proc. Roy. Soc. Edin., vol. xi, p. 714.
M. cylindrica Brady, 1884, Chall. Rept., p. 265, pl. xxiv, figs. 20-22.

A solitary fragment.

Rhabdammina M. Sars.*Rhabdammina abyssorum* M. Sars.

Rhabdammina abyssorum M. Sars, 1868, Vidensk.-Selsk, 1868, p. 248.
R. abyssorum Brady, 1884, Chall. Rept., p. 266, pl. xxi, figs. 1-13.

Fragments. One is similar to the "Challenger" fig. 8. There are straight fragments which I think belong to this species. I cannot discover any constrictions in them. There are also two which consist of a large, irregular, coarsely-built chamber, very short portions remaining of what have probably been the branching arms. These arms would not have been in the same plane, but branching in all directions. These two fragments may possibly be a variety, or another species altogether. Until perfect tests are found, I think it cannot be decided with certainty.

Family LITUOLIDÆ.

Sub-family Lituolinæ.

Reophax Montfort.*Reophax scorpiurus* Montfort.

Reophax scorpiurus Montfort, 1808, Conchyl. System, vol. i, p. 330,
 83^e genre.

R. scorpiurus Brady, 1884, Chall. Rept., p. 291, pl. xxx, figs. 12-17.

The tests are rough and built of clear white sand-grains.

Reophax pilulifera Brady.

Reophax pilulifera Brady, 1884, Chall. Rept., p. 292, pl. xxx, figs. 18-20.

Two fragments. The tests are much more roughly built-up than the "Challenger" specimens. The pale yellowish-brown cement used is plainly shown.

Reophax fusiformis Williamson.

Proteonina fusiformis Williamson, 1858, Rec. Foram. Gt. Br., p. 1, pl. i,
 fig. 1.

Reophax fusiformis Brady, 1884, Chall. Rept., p. 290, pl. xxx, figs. 7-11.

One test agrees well with the "Challenger" fig. 8.

Reophax guttifer Brady. (Pl. II, fig. 9.)

Reophax guttifer Brady, 1881, Quart. Journ. Micr. Sci., vol. xxi, N.S., p. 49.
R. guttifer Brady, 1884, Chall. Rept., p. 295, pl. xxxi, figs. 10-15.

Not one of the tests consists of more than four chambers, and they do not show the separation of the chambers to anything approaching the extent figured in the "Challenger" Report, but they agree with some of the specimens which Mr. Earland has kindly sent me from the Faroe Channel.

Reophax distans Brady.

Reophax distans Brady, 1881, Quart. Journ. Micr. Sci., vol. xxi, N.S., p. 50.
R. distans Brady, 1884, Chall. Rept., p. 296, pl. xxxi, figs. 18-22.

Two fragments. They are built of clear, white sand-grains. The choice of this particular kind of sand-grain, for the formation of tests, is not at all uncommon at this locality.

Reophax spiculifera Brady.

Reophax spiculifera Brady, 1879, Quart. Journ. Micr. Sci., vol. xix, N.S., p. 54, pl. iv, figs. 10, 11.
R. spiculifera Brady, 1884, Chall. Rept., p. 295, pl. xxxi, figs. 16, 17.

A few fragments, each consisting of a single chamber.

Reophax difflugiformis Brady.

Reophax difflugiformis Brady, 1879, Quart. Journ. Micr. Sci., vol. xix, N.S., p. 51, pl. iv, fig. 3, a, b.
R. difflugiformis Brady, 1884, Chall. Rept., p. 289, pl. xxx, figs. 1-5.

A few specimens built of coarse sand-grains, similar to the "Challenger" fig. 5. One test is nearly globular, and might be taken for *Saccamina sphaerica*, but being an odd specimen, found in company with the above, and differing from them in no other respect, it is probably only a more globular form than is usual in this species. When damped, the tests easily disintegrate. They are shaded light brown.

Haplophragmium Reuss.

Haplophragmium calcareum Brady.

Haplophragmium calcareum Brady, 1884, Chall. Rept., p. 302, pl. xxxiii, figs. 5-12.

Very large specimens occur, built of coarse sand-grains. They are narrow in comparison with their length, the segments unusually high and depressed at their sutures. The outline is lobulated. They agree with the "Challenger" fig. 7.

Haplophragmium agglutinans (d'Orbigny). (Pl. II, fig. 10.)

Spirolina agglutinans d'Orbigny, 1846, For. Foss. Vien, p. 137, pl. vii, figs. 10-12.

Haplophragmium agglutinans Brady, 1884, Chall. Rept., p. 301, pl. xxxii, figs. 19-26.

Four varieties. One example typical. Four tests have the initial chambers well compressed, slightly sunk at the umbilicus, and the linear portion also flattened at its commencement. Two specimens have the planospiral portion rather large, and are very rough. One of the two has the linear portion twisted. The fourth variety, fig. 10, Pl. II, is very slender. Of the two examples found one is in perfect condition. The test is built of clear sand-grains, and the animal has used very few grains to each chamber, which gives an angular appearance. Sutures obscure.

Haplophragmium tenuimargo Brady.

Haplophragmium tenuimargo Brady, 1884, Chall. Rept., p. 303, pl. xxxiii, figs. 13-16.

Two fragments. I believe they belong to one another, and if so they complete the test. Their compression and their jagged edges seem to identify them with this species.

Haplophragmium latidorsatum (Bornemann).

Nomionina latidorsatum Bornemann, 1855, Zeitschr. d. deutsch. geol. Gesell., vol. vii, p. 339, pl. xvi, fig. 4.

Haplophragmium latidorsatum Brady, 1884, Chall. Rept., p. 307, pl. xxxiv, figs. 7-10, 14.

Four out of the five examples are small. One is attached to a portion of an arenaceous tube.

Haplophragmium globigeriniforme (Parker and Jones).

(Pl. II, figs. 11-14.)

Lituola nautiloidea, var. *globigeriniformis* Parker and Jones, 1865, Phil. Trans., vol. clv., p. 407, pl. xv, figs. 46, 47 (pl. xvii, figs. 96-98?)

Haplophragmium globigeriniforme Brady, 1884, Chall. Rept., p. 312, pl. xxxv, figs. 10, 11.

The two largest tests, figs. 11, 12, Pl. II, are white. The others are of a light rusty-red hue, the final segments being lighter than the rest. One variety is a neat, comparatively smooth form, of a rich ferruginous tint, with three to four chambers in the outermost whorl, Pl. II, figs. 13, 14. Another variety is larger, and roughly built. The large white specimen, fig. 11, might be passed for *H. sphaeroidiforme* Brady, referred to in the "Challenger" Report, p. 313, as isomorphous with *Sphaeroidina bulloides*, but a close examination hardly supports this view of it. This test is slightly flattened.

Haplophragmium sphaeriloculum (Cushman). (Pl. II, figs. 15, 16.)

Haplophragmoides sphaeriloculum Cushman, 1910, Foram. N.P. Ocean, pt. 1, Smithsonian Instit. Nat. Mus. U.S.A., Bull. 71, p. 107, fig. 163.

This solitary example answers well to Cushman's description of the species. It is rich in colour.

Haplophragmium nanum Brady.

Haplophragmium nanum Brady, 1881, Quart. Journ. Micr. Sci., vol. xxi, N.S. p. 50.

H. nanum Brady, 1884, Chall. Rept., p. 311, pl. xxxv, figs. 6-8.

The tests are typical and pale in colour.

Haplophragmium anceps Brady.

Haplophragmium anceps Brady, 1884, Chall. Rept., p. 313, pl. xxxv, figs. 12-15.

H. anceps Heron-Allen and Earland, 1913, Foram. Clare Island, Proc. Roy. Irish Acad., vol. xxxi, p. 47, pl. iii, fig. 4.

The examples are small but typical.

Haplophragmium glomeratum (Brady).

Lituola glomerata Brady, 1878, Ann. and Mag. Nat. Hist., Ser. 5, vol. i, p. 433, pl. xx, fig. 1.

H. glomeratum Brady, 1884, Chall. Rept., p. 309, pl. xxxiv, figs. 15-18.

Typical, but varying a good deal in size.

Placopsilina d'Orbigny.

Placopsilina cenomana d'Orbigny.

Placopsilina cenomana d'Orbigny, 1850, Prod. Paléont., vol. ii, p. 185, No. 758.

P. cenomana Sidebottom, 1902, etc., Rept. Foram. Isl. Delos, Mem. Manchester Lit. and Phil. Soc., 1905, p. 4, pl. i, fig. 7.

Three occur; two attached to a fragment of a shell, and the other found in company with a *Webbina clarata*.

Sub-family Trochammininæ.

Hormosina Brady.

Hormosina carpenteri Brady.

Hormosina carpenteri Brady, 1881, Quart. Journ. Micr. Sci., vol. xxi, N.S., p. 51.

H. carpenteri Brady, 1884, Chall. Rept., p. 327, pl. xxxix, figs. 14-18.

Fragments. One has four segments. All are of small size.

Ammodiscus Reuss.*Ammodiscus incertus* (d'Orbigny).

Operculina incerta d'Orbigny, 1839, Foram. Cuba, p. 71, pl. vi, figs. 16, 17.
Ammodiscus incertus Brady, 1884, Chall. Rept., p. 330, pl. xxxviii, figs. 1-3.

Three occur. One is large and two are of medium size. Of the latter, one is white.

Ammodiscus tenuis Brady.

Ammodiscus tenuis Brady, 1881, Quart. Journ. Micr. Sci., vol. xxi, N.S., p. 51.
A. tenuis Brady, 1884, Chall. Rept., p. 332, pl. xxxviii, figs. 4-6.

The two tests found appear to be Megalospheric, and although of fair size consist of only about four convolutions. The tests are rather flat, but the initial chamber of the first convolution is raised. Very pale in colour.

Ammodiscus charoides (Jones and Parker).

Trochammina squamata charoides Jones and Parker, 1860, Quart. Journ. Geol. Soc., vol. xvi, p. 304.
Ammodiscus charoides Brady, 1884, Chall. Rept., p. 334, pl. xxxviii, figs. 10-16.

Excellent specimens occur, highly polished, and of a rich ferruginous colour.

Trochammina Parker and Jones.*Trochammina conglobata* Brady.

Trochammina conglobata Brady, 1884, Chall. Rept., p. 341, pl. xl, fig. 8, 9.
T. conglobata Flint, 1899, Rec. Foram. Rept., W.S., Nat. Mus. for 1897, p. 281, pl. xxvi, fig. 2.

Four specimens occur, which I think I am right in placing under this heading. They agree better with Flint's than with the "Challenger" figure.

Trochammina trullisata Brady.

Trochammina trullisata Brady, 1884, Chall. Rept., p. 342, pl. xl, figs. 13-16.

The small form only occurs, similar to fig. 14 in the above reference.

Trochammina nitida Brady.

Trochammina nitida Brady, 1881, Quart. Journ. Micr. Sci., vol. xxi, N.S., p. 52.
T. nitida Brady, 1884, Chall. Rept., p. 339, pl. xli, figs. 5, 6.

A solitary, typical example.

Trochammina robertsoni Brady. (Pl. II, fig. 17.)

Trochammina robertsoni Brady, Journ. Roy. Micr. Soc., 1887, p. 893.

T. robertsoni Wright, 1891, Proc. Roy. Irish Acad., (3) vol. i, No. 4, p. 469, pl. xx, fig. 4.

I think I am right in my diagnosis of this form. Two specimens have five chambers showing in the outermost whorl, the rest having four. The umbilical cavity is more closed in than is usual. The tests are small, and not quite so highly polished or coloured as the British specimens in my cabinet, except for a few chambers of several of the tests.

Trochammina rotaliformis Wright.

Trochammina inflata (Montagu), var. Balkwill and Wright, 1885, Trans. Roy. Irish Acad., vol. xxviii. (Science), p. 331, pl. xiii, figs. 11, 12.

T. rotaliformis Heron-Allen and Earland, 1913, Clare Island, Proc. Roy. Irish Acad., vol. xxxi, pt. lxiv, p. 52, pl. iii, figs. 11-13.

The tests are small and built of fine sand-grains. They agree well with Balkwill and Wright's fig. 12 in the above reference. One of the four is dark coloured; the others are lighter, especially as regards the final chambers.

Trochammina ochracea (Williamson).

Rotalina ochracea Williamson, 1858, Rec. Foram. Gt. Britain, p. 55, pl. iv, fig. 112; pl. v, fig. 113.

Trochammina ochracea Millett, 1898, etc., Rept. Rec. Foram. Malay Archipelago, 1899, p. 363, pl. v, fig. 12.

A single example. The curving sutures on the under-surface are well defined, and "present the only means of distinguishing this species from the closely allied *T. plicata* of Terquem," as Heron-Allen and Earland remark (Foram. Clare Island, Proc. Roy. Irish Acad., 1913, p. 51).

Another variety appears to be present, that referred to by Heron-Allen and Earland, 1915, Foram. Kerimba Archipelago, pt. ii, Trans. Zool. Soc., London, vol. xx, pt. xvii, p. 619, pl. xlvi, figs. 27, 28; but the irregular chitinous carina is very much wrinkled and covered with fine grey matter. Three examples occur.

Trochammina plicata (Terquem), var. (Pl. II, fig. 18.)

Patellina plicata Terquem, 1876, Anim. Plage de Dunkerque, 2^{me} fasc. p. 72, pl. viii, fig. 9.

Trochammina plicata, Balkwill and Millett, 1884, Journ. Micr. Nat. Sci., vol. iii, p. 26, pl. i, fig. 8.

In this variety the whole of the upper surface of the shell is covered with irregular, branching, and interrupted costæ, closely

set together. Under a fairly high magnification, these costæ appear to be built of minute sand-grains and are of a light brown tint, showing up well against the dark background. The test is thin, and the under-surface is not so thickly covered with the same decoration. As far as I can tell from the inferior surface, the test has probably six or seven chambers in the final whorl, but the coiling of the chambers does not show on either surface. Two specimens occur.

Webbina d'Orbigny.

Webbina clavata (Jones and Parker).

Trochammina irregularis clavata Jones and Parker, Quart. Journ. Geol. Soc., 1860, vol. xvi, p. 304.

Webbina clavata Brady, 1884, Chall. Rept., p. 349, pl. xli, figs. 12-16.

W. clavata Wright, 1891, Rept. Foram. S.W. Ireland, Proc. Roy. Irish Acad., p. 470, pl. xx, figs. 2, 3.

Both the Megalospheric and Microspheric forms occur; the former having a large, oval, initial chamber, and the latter a much smaller, generally rounded chamber, highly domed. The tube of the Microspheric form is sinuous, and has a *Globigerina* shell attached in the hollow of each curve. This tube is much stouter than in the Megalospheric form.

A single white specimen occurs, which is in the Megalospheric condition.

Sub-family *Loftusinæ*.

Cyclammina Brady.

Cyclammina cancellata Brady.

Cyclammina cancellata Brady, 1879, Quart. Journ. Micr. Sci., vol. xix, N.S., p. 62.

C. cancellata Brady, 1884, Chall. Rept., p. 351, pl. xxxvii, figs. 8-16.

Three occur. They are rather small.

Family *TEXTULARIDÆ*.

Sub-family *Textularinæ*.

Textularia DeFrance.

Textularia gramen d'Orbigny.

Textularia gramen d'Orbigny, 1846, Foram., Foss. Vien., p. 248, pl. xv, figs. 4-6.

T. gramen Brady, 1884, Chall. Rept., p. 365, pl. xliii, figs. 9, 10.

Several varieties occur. In one variety the initial chambers have acute edges, this acuteness being lost as the test broadens out and thickens.

A single specimen is comparatively short and broad. The third variety is very stoutly built and very rough; the sutures not apparent.

Textularia agglutinans d'Orbigny.

Textularia agglutinans d'Orbigny, 1839, *Foram. Cuba*, p. 144, pl. i, figs. 17, 18, 32-34.

T. agglutinans Brady, 1884, *Chall. Rept.*, p. 363, pl. xliii, figs. 1-3, vars. figs. 4, 12.

Two occur.

Textularia sagittula Defrance.

Textularia sagittula Defrance, 1824, *Dict. Sci. Nat.*, vol. xxxii, p. 117, *Atlas Conch.*, pl. xiii, fig. 5.

T. sagittula Brady, 1884, *Chall. Rept.*, p. 361, pl. xlii, figs. 17, 18.

Two fairly good examples occur. Besides these, there are several large specimens, thin and rounded at the commencement, but soon thickening and broadening out until they become very stout, with rather square edges. The largest finishes with several very large chambers of equal width. The tests are very coarsely built and are probably spiroplectine in the arrangement of the initial chambers. These forms combine features that are characteristic of *T. sagittula* Defrance, *T. gramen* d'Orbigny, and *T. candeiana* d'Orbigny.

Textularia abbreviata d'Orbigny.

Textularia abbreviata d'Orbigny, 1846, *Foram. Foss. Vien.*, p. 249, pl. xv, figs. 7-12.

T. abbreviata Fornasini, 1887, *Boll. Soc. geol. Ital.*, vol. vi, p. 399, pl. xi, figs. 1-3.

T. abbreviata Brady, Parker and Jones, 1888, *Trans. Zool. Soc.*, vol. xii, pt. vii, p. 219, pl. xlii, figs. 4, 5.

Three examples, one of which has limbate sutures, and appears, although better developed, to be similar to Fornasini's *T. abbreviata*, *Boll. Soc. geol. Ital.*, vol. vi, 1887, p. 399, pl. xi, fig. 1.

Textularia concava (Karrer).

Plecanium concavum Karrer, 1868, *Sitzungsb. d. k. Wiss. Wien*, vol. lviii, p. 129, pl. i, fig. 3.

Textularia concava Brady, 1884, *Chall. Rept.*, p. 360, pl. xlii, figs. 13, 14; and pl. xliii, fig. 11.

Two examples occur, interesting inasmuch as they are typical in having the lateral face slightly concave and the peripheral margin square, while the orifice is quite upright. The specimens differ slightly in form. The one figured is the smaller of the two.

Textularia concava, var. *heterostoma* Fornasini.

Sagraia affinis Fornasini, 1883, Boll. Soc. Geol. Ital., vol. ii, p. 189, pl. ii, fig. 10.

Textularia heterostoma Fornasini, 1896, Mem. R. Accad. Sci. Istit. di Bologna, Ser. 5, vol. vi, p. 4, pl. figs. 6, 12, 13.

A single example, agreeing well with Fornasini's (1888) illustration, fig. 1, *a-c*, excepting that the orifice is not set at an angle, and is placed as in *T. concava* Karrer.

Textularia stricta Cushman.

Textularia stricta Cushman, 1911, Foram. North Pacific Ocean, Smithsonian Instit. U.S. Nat. Mus. Bull. 71, Text, p. 11, fig. 13.

Four occur, the largest having about forty chambers. They agree accurately with Cushman's description, excepting that the apertural end is not "somewhat acute." The same large tests occur at the "Challenger" St. 185, off Raine Island, but they are very roughly built.

Further investigation may prove that these are a variant of *Textularia agglutinans*, var. *porrecta* Brady.

Cushman's species appears to be identical with the forms recorded and figured by Chapman from Great Barrier Island, New Zealand, 110 fathoms, under the names *Spiroplecta sagittula* (DeFrance), and *S. sagittula*, var. *fistulosa* Brady (Chapman, 1906, Trans. N. Zealand Instit., vol. xxxviii (1905), p. 87, pl. iii, fig. 4). It is a very large form, typical of the "Thomson Basin," and abundant in dredgings from this area. The early structure is in our experience usually, if not invariably, Spiroplectine, and Cushman's figure suggests a Spiroplectine form, though his description contains no reference to this feature. But the "Dart" specimens are of a megalospheric Textularian type, and this would seem to be proof of dimorphism. The species deserves to be carefully worked out.

Textularia quadrilatera Schwager.

Textularia quadrilatera Schwager, 1866, Novara-Exped. Geol. Theil., vol. ii, p. 253, pl. vii, fig. 103.

T. quadrilatera, Brady, 1884, Chall. Rept., p. 358, pl. xlii, figs. 8-12.

Excellent specimens occur, none of which are spinous at the base.

Textularia inconspicua Brady. (Pl. II, figs. 19-21.)

Textularia inconspicua Brady, 1884, Chall. Rept., p. 357, pl. xlii, fig. 6.

T. inconspicua Millett, 1898, etc., Rept. Foram. Malay Archipelago, Journ. Roy. Micr. Soc., 1899, p. 557, pl. vii, fig. 1.

T. inconspicua Heron-Allen and Earland, 1915, Foram. Kerimba Archipelago, Zool. Soc. London, vol. xx, pt. xvii, p. 623, pl. xlvi, figs. 1-4.

Typical tests are present. Besides these, there are a few having the base irregular, or nearly so, in outline. One can see

by the shape of the earlier chambers that in the young state the base would be oval, but in maturity the outline becomes circular. I figure one of these tests. The umbilical cavity is deeply sunk. Millett remarks, in the above reference, p. 557, that "The Malay specimens are associated with a minute hyaline Discorbina, to which they bear a considerable resemblance." I can find no reference to this form under "Discorbina," and I wonder whether the variety I have illustrated is the one to which he refers. It appears to me to be a variant of *T. inconspicua*. At all events the chambers are Textularian in arrangement.

Textularia inconspicua, var. *jugosa* Brady.

Textularia jugosa Brady, 1884, Chall. Rept., p. 358, pl. xlii, fig. 7.

T. inconspicua, var. *jugosa*, Millett, 1898, etc., Foram. Malay Archipelago, Journ. Roy. Micr. Soc., 1899, p. 558, pl. vii, fig. 2.

A single ill-developed example of the form figured by Millett in the above reference.

Textularia folium Parker and Jones.

Textularia folium Parker and Jones, 1865, Phil. Trans., vol. clv, pp. 370 and 420, pl. xviii, fig. 19.

T. folium Brady, 1884, Chall. Rept., p. 357, pl. xlii, figs. 1-5.

Two occur; one in very poor condition.

Verneuilina d'Orbigny.

Verneuilina polystropha (Reuss).

Bulimina polystropha Reuss, 1845-6, Verstein, Böhm, Kreid., pt. ii, p. 109, pl. xxiv, fig. 53.

Verneuilina polystropha Brady, 1884, Chall. Rept., p. 386, pl. xlvii, figs. 15-17.

V. polystropha Heron-Allen and Earland, 1915, Foram. Clare Isl., Proc. Roy. Irish Acad., pt. lxiv, vol. xxxi, p. 55, pl. iv, figs. 1-5.

Two small tests; one white, the other partially coloured.

Verneuilina pygmaea (Egger).

Bulimina pygmaea Egger, 1857, Neues Jahrb. für Min., p. 384, pl. xii, figs. 10, 11.

Verneuilina pygmaea Brady, 1884, Chall. Rept., p. 385, pl. xlvii, figs. 4-7.

V. pygmaea Millett, 1898, etc., Rept. Rec. Foram. Malay Archipelago, 1900, p. 11, pl. i, fig. 13.

With two exceptions, the examples are comparatively small. They are more neatly built than the specimens figured in the "Challenger" Report, and the inflation of the chambers is not so marked.

The minute hyaline form is well represented, and the tests agree in every particular with Millett's figure in the above reference.

Verneuilina spinulosa Reuss.

Verneuilina spinulosa Reuss, 1850, Denkschr. d. k. Akad. Wiss. Wien, vol. i, p. 374, pl. xlvii, fig. 12.

V. *spinulosa* Brady, 1884, Chall. Rept., p. 384, pl. xlvii, figs. 1-3.

The two specimens found are in very poor condition.

Spiroplecta Ehrenberg.

Spiroplecta annectens (Parker and Jones). (Pl. II, figs. 22, 23.)

Textularia annectens Parker and Jones, 1863, Ann. Mag. Nat. Hist., Ser. 3, vol. xi, p. 92, woodcut, fig. 1.

Spiroplecta annectens Brady, 1884, Chall. Rept., p. 376, pl. xlv, figs. 22, 23.

S. annectens Millett, 1898, etc., Journ. Roy. Micr. Soc., 1900, p. 8, pl. i, fig. 7.

Both the megalospheric and microspheric forms are present. The initial planospiral portion of the test is much larger in the megalospheric than in the microspheric form, and the chambers of the Textularian series are more erect. The test also is very much shorter and its edges are markedly sinuous.

Fig. 23 shows the smallest of the specimens found in the microspheric condition, but it is the only one from which the planospiral chambers have not been broken off. The longest example consists of about seventy-two chambers, thirty-six in either series, exclusive of the planospherical portion which is missing.

Under the name *Spiroplecta bulbosa* Cushman (1911, Monograph N. Pacific Ocean, pt. ii, Textulariæ, p. 5, figs. 1, *a*, *b*) figures a form which seems to be the same as Millett's illustration in the above reference. If they are identical it will be a matter of opinion whether or not they should be treated as a new species.

Spiroplecta biformis (Parker and Jones).

Textularia agglutinans, var. *biformis* Parker and Jones, 1865, Phil. Trans., vol. clv, p. 370, pl. xv, figs. 23, 24.

Spiroplecta biformis Brady, 1884, Chall. Rept., p. 376, pl. xlv, figs. 25-27.

The examples are small and slender, similar to the "Challenger" fig. 25.

Spiroplecta wrightii Silvestri.

Textularia sagittula DeFrance, 1824, Dict. Sci. Nat., vol. xxxii, p. 177; Atlas, Conch., pl. xiii, fig. 5.

Spiroplecta sagittula (DeFrance) Wright, 1891, Rept. S.W. Ireland, p. 471.

S. sagittula (DeFrance) Wright, 1902, Foram. Rathlin Island, p. 211, pl. iii.

S. wrightii Silvestri, 1903, Atti d. P. Accad. Romana d. Nuovi Lincei, Ann. lvi, sess. iii, pp. 8, 1-5, woodcuts.

The tests are short, the Spiroplectine portion occupying about one-third of the length of the shell. All appear to be in the megalospheric condition.

Gaudryina d'Orbigny.

Gaudryina pupoides d'Orbigny.

Gaudryina pupoides d'Orbigny, 1840, Mém. Soc. Géol. France, vol. iv, p. 44, pl. iv, figs. 22-24.

G. pupoides d'Orbigny, 1846, Foram. Foss. Vien, p. 197, pl. xxi, figs. 34-36.

G. pupoides Brady, 1884, Chall. Rept., p. 378, pl. xlvi, figs. 1-4.

This species is very well represented.

Gaudryina pupoides, var. *chilostoma* Reuss.

Textularia chilostoma Reuss, 1852, Zeitschr. d. deutsch. geol. Gesell., vol. iv, p. 18 (fide Reuss).

Gaudryina chilostoma Reuss, 1865, Denkschr. d. k. Akad. Wiss. Wien, vol. xxv, p. 120, pl. i, fig. 5.

G. pupoides, var. *chilostoma* Brady, 1884, Chall. Rept., p. 379, pl. xlvi, figs. 5, 6.

With one exception the typical tests are small.

There are also specimens, both larger and thicker, which are probably intermediate between *G. pupoides* and the above.

Gaudryina baccata Schwager.

Gaudryina baccata Schwager, 1866, Novara-Exped. geol. Theil, vol. ii, p. 200, pl. iv, fig. 12.

G. baccata Brady, 1884, Chall. Rept., p. 379, pl. xlvi, figs. 8-11.

The tests are only slightly twisted, but the inflation of the chambers and the texture of the surface, which is not polished and has a tendency towards roughness, are sufficient to identify them.

Gaudryina subrotunda Schwager.

Gaudryina subrotunda Schwager, 1866, Novara-Exped. geol. Theil, vol. ii, p. 198, pl. iv, fig. 9.

G. subrotunda Brady, 1884, Chall. Rept., p. 380, pl. xlvi, fig. 13.

Two large specimens occur, also two in an immature stage, the biserial portion not having commenced. The tests are very rough, and the aperture is deeply sunk and placed at some distance from the inner border of the final chamber. The position of the aperture is well shown in Flint's illustration (1899, Rec. Foram. U.S. Nat. Museum, pl. xxxiii, fig. 1).

Gaudryina siphonella Reuss. (Pl. II, figs. 24, 25.)

Gaudryina siphonella, 1851, Zeitschr. d. deutsch. Gesell., vol. iii, p. 78, pl. v, figs. 40-42.

G. siphonella Brady, 1884, Chall. Rept., p. 382, pl. xlvi, figs. 17-19.

G. siphonella Millett, 1898, etc., Foram. Malay Archipelago, Journ. Roy. Micr. Soc., 1900, p. 9, pl. i, fig. 9.

Specimens similar to the "Challenger" figures occur.

In addition to the above there are two forms, one of which

(Pl. II, fig. 24) I take to be the same as that figured by Millett. The tests, however, are more pointed and the chambers more numerous and narrower than in Millett's example. Two occur. They appear to be in the microspheric condition.

The other form (Pl. II, fig. 25) may also be Millett's variety in the megalospheric condition. It is more oval in shape, and the final chambers are not so much inflated. Seven occur.

Under this name Reuss figured two very dissimilar forms. His fig. 40 agrees with Brady's figs. (Pl. xlv, figs. 17-19), and with recent specimens from the Indian Ocean. Millett's figure appears to be based on Reuss's fig. 42, but the structure is quite different. Millett's gaudryine chambers are confined to the apex, hardly noticeable, while the Reuss type shows a triserial cone from apex to aperture. The "Dart" specimens are very variable; one is similar to the "Challenger" type, the others approximate more nearly to Millett's figure, and may possibly represent only gaudryine varieties of *Textularia concava* (Karrer).

Gaudryina scabra Brady. (Pl. II, fig. 26.)

Gaudryina pupoides Brady, 1870, Ann. Mag. Nat. Hist., vol. vi, p. 300, pl. xii, fig. 5.

G. scabra Brady, 1884, Chall. Rept., p. 381, pl. xlv, fig. 7.

G. scabra Heron-Allen and Earland, 1915, Foram. Kerimba Archipelago, pt. ii, Trans. Zool. Soc. London, vol. xx, pt. xvii, p. 635, pl. xlvi, figs. 7-14.

The specimens are not typical, being more slender than the "Challenger" example. Several of the tests have six pairs of Textularian chambers of the typical ferruginous colour, except the final pair, which are of greyish hue. One specimen is grey throughout. The triserial portion is obscure, and the arrangement may be Textularian throughout the entire length of the test; but the irregularity of the initial portion suggests a different manner of growth. In addition to the above, there are two minute tests, one grey, the other brown, in which the triserial commencement is well marked and the biserial portion slightly twisted. These may or may not belong to this species.

Valvulina d'Orbigny.

Valvulina fusca (Williamson).

Rotalina fusca Williamson, 1858, Rec. For. Gt. Br., p. 55, pl. v, figs. 114, 115.

Valvulina fusca Brady, 1884, Chall. Rept., p. 392, pl. xlix, figs. 13, 14.

I believe I am right in placing these three tests under this heading. They are very minute, and the chambers (of which there are three in the last whorl) are slightly inflated. They are remarkable for their beauty. When lit up by a strong light, the

minute, transparent sand-grains, of which each test is built, sparkle brilliantly. The surface is rough, and the initial chambers are dark, cement of a beautiful ruby colour being used.

Clavulina d'Orbigny.

Clavulina communis d'Orbigny.

Clavulina communis d'Orbigny, 1826, Ann. Sci. Nat., vol. vii, p. 268, fig. 4.

C. communis d'Orbigny, 1846, For. Foss. Vien, p. 196, pl. xii, figs. 1, 2.

C. communis Brady, 1884, Chall. Rept., p. 394, pl. xlviii, figs. 1-13.

Two forms are present, both being long. One is comparatively smooth, and the later chambers are fitted on to each other in such a manner as to cause the lower edge of the chambers to project slightly. The other form is rough, and the individual chambers are scarcely discernible.

(*To be continued.*)

II.—*Microscopy at Ruhleben.*

By R. PAULSON, F.R.M.S.

(Read November 21, 1917.)

THOSE who are acquainted with the internal government of the civilian camp at Ruhleben through letters and printed matter, received from interned relatives and friends, know already something of the educational work that has been going on there for the past two and a half years.

Prisoners have been permitted to send a copy of the prospectus of the work of the organized classes for each successive term, and the various numbers of the camp magazine.

As an introduction to the prospectus of work for the autumn term, 1916, we find among other notices the following:—

“In most subjects the tuition provided at the school ranges from that required by absolute beginners to that required by Advanced University Students.”

“The Term consists of fourteen weeks; the total subscription of 3.50 marks should be paid in advance, if possible.”

Roughly the camp is made up of students from the Public Schools and Universities, numbers of our best pioneers in commerce, trade and industry—men who had gone to health resorts.

Some five months ago Mr. E. J. Sheppard received a letter from Dr. Lechmere in reference to a paragraph in “Nature,” respecting a slide exhibited at the Meeting in December 1916 of the Royal Microscopical Society.

It was the preparation of the anther of *Lilium candidum*, showing the extrusion of nuclear chromatin during mitosis in the pollen mother-cells.

As the letter was reported to the Council it was suggested that Dr. Lechmere should be communicated with, and that he should be asked to give some account of the microscopical work done in the camp.

A letter was written to this effect, and after a period of eighty-seven days an answer was received, together with a report by Mr. Michael Pease on “Biological Activities at Ruhleben.”

Before reading the report it might be well to mention that the camp is situated on a bleak plateau on the site of the well-known race-course to the west of Berlin. This fact will account for the mention of betting-booth, hay-loft and grand-stand. The rigours

of winter here are extreme. With inadequate heating it is impossible to carry on the necessary work of embedding and cutting with the microtome. Without knowing these facts the account of the equipment of the laboratory might conjure up a view of semi-luxuriance.

These men are living under most depressing conditions, and it is only due to a dogged determination to weather the storm that any scientific work is systematically carried on.

LETTER FROM DR. A. ECKLEY LECHMERE TO R. PAULSON, F.R.M.S.,
DATED AUGUST 14, 1917.

I am very pleased to supply further information as regards the microscopical equipment. When the laboratory started in the spring of 1915, we were fortunate enough to have several microscopes at our disposal. These were supplied by people in the Camp who had their instruments in Germany. I had been working at plant diseases in Munich with Prof. von Tubeuf, and at the cytology of sex in insects with Dr. Büchner, so I was fortunate in having both instruments and a certain amount of material at hand which Prof. von Tubeuf kindly sent me here. Since then several more instruments have been obtained by other students. We have now an excellent microscopical outfit for general laboratory work. The instruments include the following items:—

One Leitz binocular, two Leitz C, two Leitz GH, two Winkel, one Seibert, and one Nietsch, one Baker Diagnostic, and a set of eight dissecting lenses, two polariscopes, micrometer eye-pieces, camera lucida and microspectroscope, one Leitz Minot microtome.

For sitting accommodation we use a large deep bench, fitted under the windows in the wall of the loft. The windows themselves have been much enlarged, and this year we have had skylights let into the roof. For work in the evenings I have arranged a small transformer to work from the main electric supply, which gives sufficient current to run twenty 4-volt lamps; at the same time it can supply current for heating a small drying-box for the microtome slides, and is further used for an electric needle for orientation of sections in wax.

The general instruction in laboratory work and the preparation of lectures do not leave much time for original work. The only things I have attempted here have been a series of stages in the development of the Orange Scale Insect (*Aspidotus*), and a few preparations of a curious mite infesting the earwig. The body of each mite has a long stalk which forms a branching meshwork gradually covering the body of the host. I have never seen it before, and do not know the genus. During the months of May and June this year I kept a series of eggs of *Limnaea stagnalis*,

Planorbis corneus and *Valvata piscinalis* under observation for the early stages of development. I have a large number of eggs embedded for future cutting, after using pereny and acetic sublimate as fixing reagents. Towards the end of an egg-laying period in *L. stagnalis* I frequently found some of the egg-capsules with numerous eggs, up to fifteen in number, instead of the normal single egg. I also managed to hatch out several cases of two embryos from one capsule. A curious incident occurred with the aquarium in which there were specimens of *P. corneus*, and the only specimen of *Paludina vivipara* I have been able to find. One night five of these snails, including the *Paludina*, were dragged out of the aquarium and devoured by a rat. The aquarium is now removed to a safer place for protection from further invasion.

REPORT ON BIOLOGICAL ACTIVITIES IN RUIHLEBEN.

FROM MICHAEL S. PEASE, B.A. CANTAB., DATED AUGUST 14, 1917.

The first outward sign of biological activity in Ruhleben appeared in the spring of 1915, when Dr. A. E. Lechnere started a series of lectures on Elementary Biology. These were held in a disused betting-booth, and attended by half-a-dozen enthusiasts. In the summer, one of the grand-stands was set aside for lectures, and Dr. Lechnere continued his course on the Protozoa, while I contributed a course of twenty lectures on Heredity. At Christmas, 1915, the loft of Barracks 6 became available for educational purposes, and the first weeks of the new year saw the conversion of a corner of a somewhat dilapidated hay-loft into a biological laboratory. By the end of January the accommodation for eight microscopes was provided. The necessary glass-ware and reagents were got in from Messrs. Leitz, and practical botany, of a necessarily elementary character, was started with twenty-one students.

In the following terms regular lecture courses in botany were given by myself, and the corresponding practical work was of a more thorough and extensive nature. The ground covered has been as follows:—

Bryophytes and Pteridophytes (Summer, 1916).

Gymnosperms (Autumn, 1916).

Algæ (Lent, 1917).

Angiosperms (Summer, 1917).

Spirit material was kindly presented to us by Prof. A. C. Seward, Dr. Darbishire, and Prof. Tubeuf.

We are indebted to Prof. Engler for a weekly supply of flowers from the Kgl. Botanischer Garten, Dahlem, for the systematic course. A pond within the race-course has been our source of fresh material for Algæ and Protozoa.

The equipment of the laboratory has been continuously im-

proved. A cable was laid on to give us electric current day and night. A transformer was constructed on the premises, and each microscope provided with a 4-volt lamp for work after dark.

Several electrically heated incubators were also fitted up, and last Easter permission was obtained to put in sky-lights and to fit up a water-supply.

With the possibility of a continuous source of heat, we were able to consider paraffin embedding.

Serious difficulty has been encountered in the construction of a satisfactory automatic electric thermostat for the embedding bath. We have recently secured a Hearson's capsule, and an improved model of embedding bath is now being made. Nevertheless, a considerable quantity of material has been satisfactorily embedded, and a beginning is being made with the technique of Cytology. Last Christmas a first-class microtome (Minot model by Leitz, cutting to 1μ) was purchased, but the rigours of the winter, followed almost instantly by those of a phenomenally hot May and June, has made it impossible to start microtomy until recently.

It has been impossible to do practical work in Zoology, but Dr. Lechmere's lectures have continued to draw an enthusiastic band of students. His course so far has covered :—

Protozoa (one term).

Cœlenterata (one term).

Vermes (three terms).

Echinodermata (one term).

And he has just finished the second term of his course on Mollusca.

At the same time, he has also started a course on Invertebrate Embryology. Animal physiology has been very exhaustively treated (again only theoretically) by Mr. S. R. Edge, B.A. Cantab. Practical instruction has been given in the testing of agricultural seeds by Mr. A. Hill, B.Sc. Aberdeen, and for this course a large electrically-heated incubator was constructed.

This summer new space was allotted to Science, and this was made use of to accommodate a library, shared jointly by the biologists, chemists, and physicists. The library provides seating accommodation for working, and contains over 500 volumes, mostly the property of the science staff, but many also supplied by the Board of Education.

At present "Nature" is at once our only periodical and only link with scientific activity outside.

III.—*A New Species of Gongrosira.*

By G. S. WEST, M. A. D.Sc. F.L.S.

(Read December 19, 1917.)

ONE PLATE.

IN September, 1916, Mr. D. J. Scourfield forwarded me a lime-incrusted alga for examination and possible identification. This alga has proved of very great interest, and a detailed investigation of its characters shows that it belongs to the genus *Gongrosira*, but that it does not agree with any of the described species. It was found by Mr. D. J. Scourfield and Mr. G. T. Harris on wood in a stream at Weston Mouth, near Sidmouth, Devonshire, growing in such a position that it received the full force of the stream, the water falling about two feet on to the incrustated alga. The incrustation was from 4–9 mm. in thickness, somewhat nodular on its upper surface, and of a vivid green colour. Mr. Scourfield kindly provided me with a fine dried specimen of the calcified alga, one fixed in formalin, and a living example in good condition.

The genus *Gongrosira* was established by Kützing in 1843,* and belongs to the sub-family Microthamnieæ of the Chaetophoraceæ, the most important family of branched algae in the Ulotrichales. Fully half the known species of *Gongrosira* are incrustated with lime, but the alga collected by Mr. Scourfield and Mr. Harris differs in many particulars from those previously described.

The following is a diagnosis of the new alga :—

GONGROSIRA SCOURFIELDII sp. n.

G. aquatica, in rivulis rapidissimis vicens, stratum efformans vivide viridissimum circa 4–9 mm. crassum, calce valde incrustatum; thalli pars inferior e filamentis densis anastomosantibus constans, cellulis tumidulis irregularibusque, pars superior e filamentis plus minusve erectis ramulosis, cellulis apicalibus obtusis

* Kützing, *Phycologia generalis*, 1843, p. 281.

EXPLANATION OF PLATE.

Figs. 1–3.—*Gongrosira scourfieldii* sp. n. × 500.

1. Part of thallus, showing the nature of the branching. 2 and 3. Parts of the erect filaments, showing the intercalary zoogonidangia.
a. Cell in which there is no pyrenoid in the chloroplast. b. Cell with two pyrenoids in the chloroplast. zg. Empty zoogonidangia.

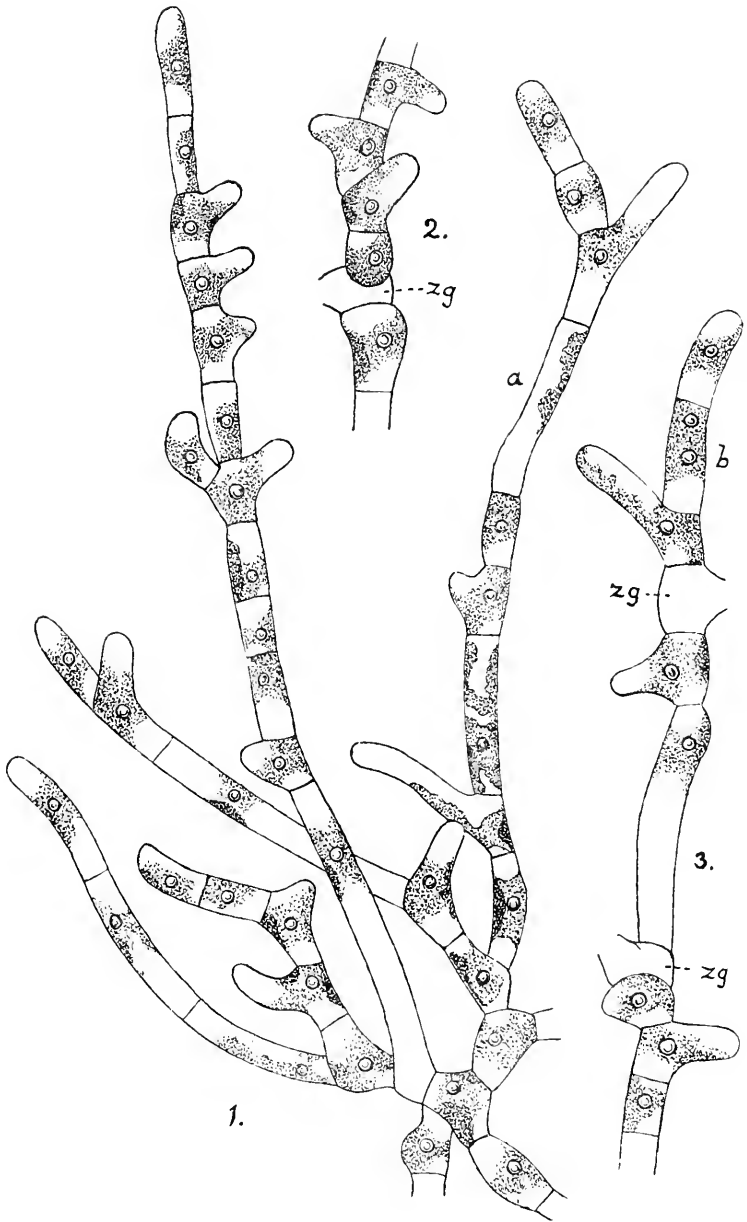

G. S. West del

GONGROSIRA SCOURFIELDII.

non attenuatis, apicibus filamentorum e crusta calcarea protrusis; filamentorum erectorum cellulæ ut plurimum omnes ramorum initia ostendunt. Cellulæ plerumque subcylindricæ, longitudine variables, diametro 1-9-plo longiores, omnes chromatophoro parietali, pyrenoide singulo (rarissime binis) instructæ.

Zoogonidangia intercalaria, ore laterali prædita, e cellulis brevissimis fere semper oriunda.

Crass. cell. fil. bas. 12-16 μ ; crass. cell. fil. erect. 7.5-9.5 μ ; crass. zoogonidang. 16-19 μ .

Hab.—Ad lignum vetustum in rivulis rapidissimum prope Sidmouth, Devon.

The thallus of *Gongrosira scourfieldii* may be roughly divided into an upper part and a lower part, although there is no sharp line of demarcation between these two layers. The lower part of the thallus cannot be described as consisting of procumbent filaments, since, although some of them are more or less creeping, they form a loose anastomosis of short irregular branches. Springing from this lower part of the thallus are numerous erect branches which are themselves branched. In fact, almost every cell of an erect branch exhibits a tendency to branch (*vide* fig. 1). The erect branches are not attenuated, the apical cells being bluntly rounded, and the tips of the branches project beyond the calcareous matrix. The cells vary considerably in length, long cells and short cells being indiscriminately mixed in the erect filaments. In the longer cells, which are usually cylindrical and show no trace of incipient branching, the parietal chloroplast is restricted to a part of the cell, either submedian or terminal. Every cell of the thallus contains a single parietal chloroplast with, as a general rule, one conspicuous pyrenoid. Occasionally two pyrenoids are found in the chloroplast (fig. 3*b*), and very rarely there are chloroplasts without any pyrenoids at all (fig. 1*a*). There are no empty cells—that is, cells which have died and are in consequence devoid of contents—in any parts of the filaments, either erect or procumbent.

The zoogonidangia arise from short cells and are always intercalary with a rather wide lateral aperture (figs. 2 and 3*g*).

There are two other incrustated species of the genus with which *Gongrosira scourfieldii* should be compared, namely, *G. trentepohliopsis* Schmidle* and *G. incrustans* (Reinsch) Schmidle.† From the first-named *G. scourfieldii* is distinguished by its somewhat larger size, its more irregular and on the whole more elongate cells, its different branching, and its intercalary zoogonidangia. From *G. incrustans* it differs in having less crowded erect filaments, which are not parallel and are much more branched, and in the fact that *all* the cells contain a large parietal chloroplast.

* Schmidle in Oesterr. botan. Zeitschrift, 1897, No. 2.

† Schmidle in Ber. Deutsch. Bot. Ges., 1901, xix. p. 12.

SUMMARY OF CURRENT RESEARCHES
RELATING TO
ZOOLOGY AND BOTANY
(PRINCIPALLY INVERTEBRATA AND CRYPTOGAMIA),
MICROSCOPY, ETC.*

ZOOLOGY.

V E R T E B R A T A.

a. Embryology.†

Internal Secretions of Gonads.‡—A. Lipschütz refers to the experimental evidence that the internal secretions of the sexual glands of mammals control the development of sex-characters. Steinach has shown that the internal secretion of the male gonad furthers the development of only male sex-characters, and inhibits the development of female sex-characters, and that the opposite holds of the internal secretion of the female gonad. By replacing ovary with testis Brandes masculinized a doe; by replacing testis with ovary Goodale feminized a cockerel. Lipschütz describes the transformation of the clitoris of a castrated and then masculated guinea-pig into a penis-like organ. The transformation is not due simply to the absence of ovaries, for the structure of the external urogenital organs of a sister of the masculated female, castrated at the same time as the latter, but not masculated, did not differ from the normal.

Steinach has suggested that the soma of the organism is non-sexual until after the puberty gland has become differentiated into male or female. This view is supported by the new experiments of Goodale and of Pézard on the hen. The castrated hen assumes the plumage and the spurs of a cock; the castrated cock keeps his plumage and spurs. It is inferred that the development of the male plumage and spurs does not depend on stimulation by the male sexual gland, whereas the female sexual gland transforms a male-like plumage into a female one, and

* The Society are not intended to be denoted by the editorial "we," and they do not hold themselves responsible for the views of the authors of the papers noted, nor for any claim to novelty or otherwise made by them. The object of this part of the Journal is to present a summary of the papers as *actually published*, and to describe and illustrate Instruments, Apparatus, etc., which are either new or have not been previously described in this country.

† This section includes not only papers relating to Embryology properly so called, but also those dealing with Evolution, Development, Reproduction, and allied subjects.

‡ Journ. Physiology, li. (1917) pp. 283-6.

inhibits the growth of the spurs. The male plumage and spurs are on this view regarded as organs which develop out of the characters of the hypothetic non-sexual embryonic form without any influence of the sexual glands. "The male plumage and the spurs become male sex-characters, not because they result from an action of the male sexual gland on the non-sexual soma, but because the development of these non-sexual characters is influenced in the female by the internal secretion of the female sexual gland." Generalizing Pézard's suggestion, Lipschütz proposes to divide the sex-characters of Vertebrates into two groups:—(1) Sex-characters not dependent on the puberty glands, but the outcome of the characters of the non-sexual embryonic form; and (2) sex-characters dependent on the puberty gland, which evokes them by acting on the non-sexual embryonic form, either by furtherance or by inhibition.

Development of Auditory Capsule in Man.*—George L. Streeter has studied this in human embryos. The changes in size and form during development are accomplished in part by a progressive and in part by a retrogressive differentiation of the constituent tissues. Throughout the entire period of growth, as far as material was available for study, it was found that the margins of the cartilaginous cavities undergo a process of continual transformation. They exhibit a state of unstable equilibrium, in respect to the opposing tendencies toward a deposit of new cartilage on the one hand, and toward the excavation of the old on the other. The margins are always either advancing or receding, and in this way are produced the progressive alterations in their size, shape, and position. In this manner suitable chambers are provided for the enlarging membranous labyrinth.

The general tissue-mass of the otic capsule, during the period represented by embryos from 4 mm. to 30 mm. in length, passes through three consecutive histogenetic periods—namely, the stage of mesenchymal syncytium, the stage of pre-cartilage, and the stage of true cartilage. In the subsequent growth of the capsule it is found that in areas where new cartilage is being deposited the tissues of the areas concerned follow the same progressive order of development. In areas, however, where cartilage previously laid down is being removed, the process is reversed. The tissue in such areas returns to an earlier embryonic state, that is, it undergoes de-differentiation. Tissue that has acquired all the histological characters of true cartilage reverts to pre-cartilage, and then to a mesenchymal syncytium. In the latter form it re-differentiates into some more specialized tissue—in this case for the most part into a vascular reticulum.

The perichondrium is a derivative of the periotic reticulum, and forms an outer limiting membrane along its cartilaginous margin. During the foetal period the perichondrium does not rest directly against the true cartilage, but is separated from it by a zone of transitional tissue consisting partly of pre-cartilage and partly of reticulum.

"Dislocated" Mice.†—Etienne Rabaud has studied the hereditary relations in a race of mice, arising as a mutation in a normal line.

* Amer. Journ. Anat., xxii. (1917) pp. 1-25 (12 figs.).

† Bull. Soc. Zool. France, xlii. (1917) pp. 87-97 (1 fig.).

which he calls "luxées." The bones of the second segment of the hind leg are delicate and short; the femoro-tibial articulation is very loose; the animal moves on the distal end of the femur; the rest of the limb is turned upwards. These peculiar forms bred true among themselves, and when crossed with normal forms yield offspring normal and dislocated in the 3:1 proportion. In short, the peculiarity is recessive. But after some months it was observed that a pair of dislocated mice gave rise to a normal type. Seventeen normal forms were obtained from eight recessive pairs. These behave as dominants, but besides normal offspring they yielded forms dislocated on only one side. When they were paired with normal forms they behaved as recessives. When paired with bilaterally dislocated forms they showed a relative recessivity. When inbred they yield unilaterally dislocated, bilaterally dislocated and normal forms. The author indicates some of the difficulties in using the factor hypothesis in interpreting his observations. He inclines to regard the mutation as a quite novel physico-chemical change in the constitution of gametes, probably induced by some peculiarity in the amphimixis.

Hæmopoiesis in Mongoose Embryo.*—H. E. Jordan has studied the development of the blood in the yolk-sac and in intra-embryonic mesenchyme. The mesenchyme is a fundamental hæmogenic tissue. It produces (by mechanical differentiation) endothelium and mesothelium, which retain its differentiative capacity. In early stages both give rise to hæmoblasts. In the young embryo these hæmoblasts differentiate into erythrocytes. The hæmoblasts seem to be identifiable with lymphocytes or primitive leucocytes, which are regarded as progenitors of granulocytes. If this be so, it follows that the primitive leucocytes appear before the erythrocytes. Such an ontogenetic sequence is in accord with the principle of progressive differentiation and with the phylogenetic history. It will be seen that Jordan strongly supports the monophyletic theory of blood-cell origin.

Aortic Cell-clusters in Vertebrate Embryos.†—H. E. Jordan discusses in a variety of cases (embryos of mongoose, turtle, etc.) these endothelial derivatives with hæmogenic significance. They illustrate the inherent capacity of endothelium to produce hæmoblasts. "The explanation of the limited distribution of the clusters is to be found in a relationship to young or newly formed, only slightly differentiated, epithelium, rather than in a connexion with regressive blood-vessels and an associated toxic substance."

Development of Mammary Glands.‡—J. A. Myers describes the foetal development of the mammary gland in the female albino rat (*Mus norvegicus albinus*). The early development has been previously described by Henneberg, and the post-natal development by Myers. In foetuses at fifteen days and nine hours the glands are in the club-shaped

* Carnegie Inst. Washington, Publication No. 251 (1917) pp. 291-312 (4 pls.).

† Proc. Nat. Acad. Sci., iii. (1917) pp. 149-56.

‡ Amer. Journ. Anat., xxii. (1917) pp. 195-222 (12 figs.).

stage, the epithelial primordium forming an ellipsoidal body attached to the epidermis by a constricted neck. The formation of the primary duct, the secondary, tertiary, and quaternary ducts, the epithelial hood, and the mammary pit are described. The primordium of the nipple was first observed on the twentieth day as a papilla at the bottom of the mammary pit. The lumina of the ducts were first observed on the eighteenth day; they do not reach their definitive stage in the fœtus. They are apparently formed by re-arrangement of the cells. In the earliest stages studied the mesenchymal cells are condensed around the gland primordium; they subsequently elongate and develop long fibrous processes; at twenty days and six hours these cells and fibres form the greater part of the gland stroma, which includes (1) the thin mantle layer immediately surrounding the ducts, and (2) the true stroma between the ducts and outside of the mantle layer. The true stroma contains the larger blood-vessels and nerves of the glands.

Mammary Glands of Rabbit.*—J. Hammond finds that the development of the mammary gland of the rabbit during the second half of pregnancy is under the same influence as that which controls the development during the first half—namely, the corpus luteum. Contrary to the generally accepted opinion, the corpus luteum is active during the second half of pregnancy. The further development of the corpus luteum, which takes place during the latter part of pregnancy, is due to the influence of the fœtus. Hammond's experiments do not uphold the view of Ancel and Bouin that the glandular phase of the mammary gland is due to something entirely different from that which causes the growth-changes, but confirm the views previously expressed by Hammond and Marshall, that milk-secretion in pseudo-pregnancy takes place in correlation with the involution of the corpus luteum. Apparently the secretion of milk results whenever the influence causing the glandular growth (the corpus luteum) is removed or lessened in amount, provided that the initial development has gone far enough.

Œstrous Cycle in Guinea-pig.†—Charles R. Stockard and George N. Papanicolaou have shown that a typical œstrous cycle occurs in this much-studied animal, and have followed the histological and physiological changes. The terminology proposed by Heape is used:—ancestrum, period of rest in the female; pro-œstrum, the first part of the sexual season; œstrum, especial period of desire in the female; metœstrum, the short period when the activity of the generative system subsides, and the normal condition is resumed in case conception did not occur; diœstrum, the short period of rest which in some mammals lasts only a few days. The cycle in the guinea-pig, consisting of the four periods—pro-œstrum, œstrum, metœstrum, and diœstrum—is known as a diœstrous cycle.

The regular diœstrous cycle repeats itself in non-pregnant females about every sixteen days throughout the entire year. During each

* Proc. Roy. Soc., Series B, lxxxix. (1917) pp. 534-46 (1 pl.).

† Amer. Journ. Anat., xxii. (1917) pp. 225-82 (9 pls. and 1 fig.).

cycle typically corresponding changes are occurring in the vagina, the uterus, and the ovary. Each period of sexual activity lasts about twenty-four hours, and is characterized by a vaginal fluid changing in composition with the several stages. These changes are described in detail. Ovulation seems to occur spontaneously in every heat. During the diœstrum there is very little fluid in the vagina. A marked correlation exists between the œstrous changes in the uterus and the developmental cycle of the corpora lutea. It looks as if the secretion from the corpora lutea exerted a protective influence over the uterus and vagina, while its absence permitted the breaking down and degeneration of the uterine epithelium typical of the heat period.

Post-œstrous Changes in Dog.*—F. H. A. Marshall and E. T. Halnan have studied the post-œstrous changes occurring in the generative organs and mammary glands of the non-pregnant dog. There is a pronounced post-œstrous development under the influence of the corpora lutea, there being a definite pseudo-pregnant period. Retrogressive changes do not set in with any of these organs until about thirty days after ovulation, and in the case of the mammary glands a somewhat later period. The developmental changes are of a similar kind to those taking place during pregnancy, but do not reach the same degree of development. The entire series of changes is physiologically homologous with the series shown by the uterus and mammary glands of the pseudo-pregnant rabbit and marsupial cat.

The relatively long persistence of the corpora lutea in the bitch is probably correlated with the monœstrous habit. This persistence, which is possibly greater in some individuals than in others, elucidates the not uncommon phenomenon of bitches which have not been impregnated secreting milk at or near the end of the pseudo-pregnant period.

The changes which occur in the generative organs and mammary glands after œstrus are now brought into relation with the rest of the œstrous cycle. The complete cycle in the bitch may be summarized in the following scheme :—

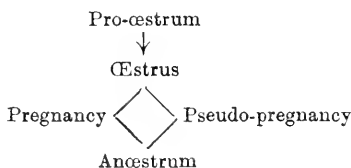

The terms pro-œstrum, œstrus, and anœstrum are used as defined by Heape. The first part of the anœstrum is generally occupied by the nursing or lactation period, but in the case of animals which have experienced pseudo-pregnant conditions the lactation period is usually only very imperfectly represented. The metœstrous period must now be regarded as unrepresented in the bitch. It exists in those animals which do not experience pseudo-pregnancy (e.g. in those rabbits in which corpora lutea are not formed after œstrus).

* Proc. Roy. Soc., Series B, lxxxix. (1917) pp. 546-59 (3 pls.).

Effect on Progeny of Fowls after Treatment with Alcohol.*—Raymond Pearl continues his experiments on the effect of alcohol on fowls and their progeny. The parents were treated with ethyl-alcohol, methyl-alcohol and ether. The proportion of fertile eggs was reduced in the matings of dosed parents. The prenatal mortality was reduced; the postnatal mortality was reduced; the sex-ratio was not sensibly affected; there was no significant difference in mean hatching weight when only the male parent was treated; the offspring of alcoholized parents showed a higher mean hatching weight and mean adult weight; the proportion of abnormal chicks was not affected; many germ-cells of treated parents did not form zygotes, but those that did were not injured in any way. There is much to be said in support of the hypothesis that alcohol and similar substances act as selective agents upon the germ cells of treated animals.

Hereditary Characters and Evolution.†—H. S. Jennings takes a survey of his own observations on *Dictyodia*, and compares his results with those reached by others working with *Drosophila*, rats, *Oenothera* and other forms. The general impressions are the following:—
 “1. Experimental and observational study reveals that organisms are composed of great numbers of diverse stocks differing heritably by minute degrees. 2. Sufficiently thorough study shows that minute heritable variations—so minute as to represent practically continuous gradations—occur in many organisms; some reproducing from a single parent, others by biparental reproduction. 3. The same thing is reported from palæontological studies. 4. On careful examination we find even that the same thing is revealed by such mutationist work as that on *Drosophila*; single characters exist in so many grades due to minute alterations in the hereditary constitution as to form a practically continuous series. 5. It is *not* established that heritable changes must be sudden large steps; while these may occur, minute heritable changes are more frequent. 6. It is *not* established that heritable variations follow a definite course as if predetermined; they occur in many directions. 7. It is not established that all heritable changes are by disintegration; although many such do occur, they cannot be considered steps in progressive evolution from the visibly less complex to the visibly more complex. Evolution according to the typical Darwinian scheme, through the occurrence of many small variations and their guidance by natural selection, is perfectly consistent with what experimental and palæontological studies show us; to me it appears more consistent with the data than does any other theory.”

Study of Free-martin.‡—Frank R. Lillie has studied the sterility which is the rule, subject to a few exceptions, in the female of the two-sexed twins of cattle. In such females, commonly known as free-martins, the internal organs of reproduction are usually predominantly male in character, and the external organs are usually, at least, of the female type. There are however considerable variations. The general

* Journ. Exper. Zool., xxii. (1917) pp. 241-310 (7 figs.).

† Journ. Washington Acad. Sci., vii. (1917) pp. 281-301.

‡ Journ. Exper. Zool., xxiii. (1917) pp. 371-452 (29 figs.).

idea reached is that the sterile free-martin is zygotically a female, modified by the sex-hormones of the male twin, which circulate in both individuals during the fetal life owing to secondary fusion of the chorions and anastomosis of the foetal circulation of the two individuals.

The author argues that the free-martin is zygotically a female. 1. The only basis on which it could be logically interpreted as male is that it is co-zygotic with its male mate, because it is impossible to suppose that the association of two males *in utero* should cause the transformation of one of them into a free-martin in a certain definite proportion of cases. But the free-martin and its male mate arise from separate zygotes. From this point of view the free-martin must be interpreted as zygotically female. 2. The somatic resemblances between the free-martin and its mate are not of the order of identical twins. 3. The assumption that the free-martin is male leads to an absolutely incomprehensible sex-ratio, while the interpretation that it is female comes nearer fulfilling the expected sex-ratio. From this point of view also the free-martin is female. The only argument for its male nature rests on the internal organs of reproduction, which are more or less of the male type. But the external genitals and the mammary gland are almost invariably of the female type.

Lillie discusses a large number of cases and gives figures of great excellence. The facts suggest the theory that the course of embryonic differentiation is largely determined by sex-hormones, circulating in the blood. This secondary differentiation must be distinguished from the primary zygotic determination of the male and female sex. The question why the sex-hormones of the mother do not affect the reproductive system of male offspring shows the need of further investigation. It is unlikely that there is any cessation of production of sex-hormones during fetal life; it may be that they are neutralized in some way; more probably, the placenta is impervious to them.

The intersexual condition of the free-martin is, on Lillie's theory, comparable to the intersexual condition in some Gypsy Moths. It is due, however, to an acceleration or intensification of the male factors of the female zygote by the male hormones. There are many grades of transformation, the ovary approximating towards a testis. Thus, sex in mammals cannot be diagnosed by the character of the gonads alone, because a testis-bearing individual may develop from a female zygote. The unexpected result is reached that the external genitalia and the mammary gland are more reliable criteria of the female sex than the internal parts.

Germ-cells of Loggerhead Turtle.*—H. E. Jordan has studied twenty-five embryos of the Loggerhead Turtle (*Caretta caretta*) from the second day (five somites, 2 mm. in length) to the thirty-second day of incubation. He found that the early history of the primordial germ-cells is very similar to that described by Allen for the turtle *Chrysemys* and by Woods for the dog-fish. The primordial germ-cells migrate during the second day from the yolk-sac endoderm into the lateral border of the area pellucida on each side of the embryonic disk. By

* Carnegie Inst. Washington, Publication No. 251 (1917) pp. 313-44 (6 pls.).

the beginning of the third day they are sharply segregated into two bilateral cords situated in the endoderm of the area pellucida, laterally, in the caudal half of the disc. In the two-day embryo they extend from the neurenteric canal to the end of the primitive streak; in the three-day embryo from the sixth somite to the caudal extremity of the streak. The cords become more linearly placed, make a linear connexion with the overlying visceral mesoderm, and their cells migrate during the fifth day into this mesoderm and thence medially (during the sixth and seventh days) towards the root of the forming mesentery of the closing hind-gut. Individual cells migrate medially also within, or back into, the endoderm of the gut. The germ-cells in the medial endoderm become included in the mucosa of the closed hind-gut, those in the mesoderm in the enveloping mesenchyma and the gut-end of the mesentery. From these locations the majority of the germ-cells subsequently (seventh to twelfth day) migrate up the mesentery and across the cœlomic angle into the future sex-gland. They become incorporated among the mesenchymal cells of the gland and the covering peritoneal epithelium, where they suffer no striking change in form, size or content, at least up to the thirty-second day of incubation. The germ-cells migrate by amoeboid activity, probably assisted in small part by the factor of unequal growth. The migration period is not sharply limited, but practically ceases by the sixteenth day. A certain number of migrating germ-cells go astray, and most of these probably degenerate *in situ*, but some may persist to form, under appropriate stimulus, a focus of neoplastic growth. The total number of germ-cells counted in a twelve-day embryo was 352, the number within the gonads being about equally divided (118 left, 127 right). Occasional cells may divide by mitosis or undergo degeneration at any stage. No germ-cells were found contributing to the formation of the Wolffian duct. The germ-cells do not differ from young somatic cells in character of mitochondrial content. No transition stages between cœlomic epithelial cells and germ-cells appear up to the thirty-second day, and no secure histological basis can here be found for separating the germ-cells of the gonads into large "primary genital cells" and smaller "secondary genital cells" (Felix) or "gonocytes" (Dustin).

The evidence derived from a study of the *Caretta* embryos is in complete harmony with the idea of a single uninterrupted line of sex-cells from primordial germ-cells to oogonia and spermatogonia, and with the hypothesis of a vertebrate Keimbahn or continuous germinal path. The fact of fundamental significance with respect to the primordial germ-cells is their original extra-regional distribution, and their genetic independence of the soma-cells.

b. Histology.

Differentiation of Cells in the Developing Organism.*—Vera Dancharoff discusses the problem whether the relations of differently organized tissue which work together in symbiosis are definitely determined by their constitutional specificity, or whether there exist in the

* Amer. Nat., li. (1917) pp. 419-28.

organism plastic factors which from a homogeneous cell material may mould differently organized products. On the basis of descriptive histogenetic studies it seems plausible to admit that environment can modify isolated cells; that the metabolic processes of the cells are the resultant of their physico-chemical constitution plus physico-chemical conditions of the environment (including hormones, enzymes, and so forth), and do not depend exclusively upon their physico-chemical constitution; that different substances arise in the cell-body (hæmoglobin, various specific granules) in polyvalent cells as the result of changes, determined by differences in the environment.

Behaviour of Explanted Striped Muscle in Cultures.*—Warren H. Lewis and Margaret R. Lewis have experimented with muscle fragments explanted from a chick embryo and placed in tissue cultures like Locke's solution. The muscle-buds show de-differentiation or return to a more embryonic condition. The de-differentiation never proceeds to an indifferent stage. The initial stages in regeneration of muscle in mammals and amphibians are much like those observed in these culture-experiments. In both there is (1) a formation of young myoblasts, a return to a more embryonic condition; (2) the formation of protoplasmic buds which grow out from the ends of the old fibres. Such buds contain many nuclei and lack cross-striations. Their formation is inherent in the muscle-fibre itself, and becomes manifested when the fibre is cut across or injured. Although the initial stages are much the same in cultures and in ordinary regeneration, it is not to be expected that even after prolonged cultivation *in vitro* there will be a re-differentiation of the muscle-buds. This requires more complex developmental conditions. It is interesting that anastomosis of muscle-buds may occur in cultures.

Thymus-like Structures in Larval Lamprey.†—Ivan E. Wallin finds that the lymphocyte accumulations, or placodes, in the lateral branchial wall of the larval lamprey do not represent primitive thymus primordia. Similar formations are present in other parts of the pharyngeal epithelium. An important component of the thymus of higher animals is a reticulum; there is no indisputable evidence of a reticulum in the placodes. They are apparently patches of degenerating epithelium.

The branchial "epithelium" does not represent a pure endodermic epithelium. This "epithelium" devotes hæmopoetic properties in the advanced larva. "Epithelium" from the gill arches invades the ciliated epithelium of the epipharyngeal ridge and produces placodes. These placodes have a relationship to the gill arches and gill pouches which make them homologous with the thymus placodes of Elasmobranchs and are to be considered primitive thymus structures. The lymphocyte-like cells which originate in the primitive thymus placodes differ in structural characters, and in mode of origin from the lymphocytes which are formed in the gill arches and lamellæ.

* Amer. Journ. Anat., xxii. (1917) pp. 169-94 (14 figs.).

† Amer. Journ. Anat., xxii. (1917) pp. 127-67 (4 pls. and 3 figs.).

Chicken Bone-marrow in Plasma Medium.*—Rhoda Erdmann describes a first period (first to third day) of a somewhat regressive character—including the degeneration of the erythrocytes and the nearly full-grown erythroblasts, the ripening of the granulocytes implanted with the bone-marrow into the tissue culture, the decay of the bone-marrow into a network. In the second period (third day to death of culture) there is an adaptation of surviving cells to the conditions of the medium. The surviving cells are modified fat cells and newly formed wandering cells of the mesenchyme-like type. After fourteen days' cultivation, they are, except elongated connective tissue cells, the only living cells. They belong to the connective tissue cell type, and may, when the medium is renewed, grow indefinitely.

Osseous Regeneration in the Adult.†—Heitz-Boyer and Scheikevitch maintain that ossification in adult man, effecting regeneration, is always a pathological process, inflammatory from beginning to end. It is not a re-awakening of the latent powers of the periosteum. The *primum movens* of the ossification of the periosteum in an adult is always accidental, and originates in a bone affected by osteitis. The periosteum offers an eminently favourable soil, but it has no generative action. This belongs exclusively to the bone.

Epithelial Reversions in Human Thymus.‡—A. P. Dustin has studied the intrathymic epithelial formations which occur in varying degrees in the thymus. They are due to reversionary involution of the primary cells of the thymus. They may last a long time, but they do not give rise to any other structure.

Structure of Optic Nerve.§—Nicola Alberta Barbieri describes the optic nerve in various types. In fishes it has two forms, cylindrical and laminar. In Gadidae, Murænidae, and cartilaginous fishes it is cylindrical; in the others it is laminar. A deep groove (also seen in Ruminants) marks the end of the cylindrical optic nerve; it is absent in the laminar optic nerve. In *Labrax lupus* the optic nerves form a plaited membrane. In birds the optic nerve is laminar in diurnal birds of prey and web-footed birds; it is cylindrical in nocturnal birds of prey and other birds. Barbieri contrasts the Vertebrate optic nerve with what occurs in Cephalopods, where very short optic nerves lead into large optic ganglia, surrounded by a capsule, and are not continued into the retina.

Intercalated Discs in Heart-muscle of Ox.||—H. E. Jordan and J. B. Banks have made a careful study of the intercalated discs in heart-muscle, which have been interpreted as (1) intercellular cement substance: (2) regions of muscle-growth or differentiating sarcomeres;

* Amer. Journ. Anat., xxii. (1917) pp. 73-126 (9 pls. and 2 figs.).

† Comptes Rendus, clxv. (1917) pp. 518-20.

‡ Arch. Zool. Expér., lvi. (1917) Notes et Revue, No. 4, pp. 73-87 (7 figs.).

§ Comptes Rendus, clxv. (1917) pp. 677-80.

|| Amer. Journ. Anat., xxii. (1917) pp. 285-339 (4 pls.).

(3) of the nature of tendons ; (4) and local modifications of the myofibrils, of the nature of irreversible contraction phenomena following unusual functional conditions or stresses, i.e. in essence, irreversible contraction bands (Jordan and Steele). Another view, allied to the interpretation of the discs as tendinous, is Dietrich's co-ordination mechanism theory. The authors adhere to the interpretation of the discs as secondary modifications of the myofibrils at certain areas characterized by unusual functional conditions, probably excessive stresses. These involve an inability on the part of the contraction bands to revert to the relaxed condition. The myofibrils are subsequently modified chemically and mechanically. Much histological and embryological evidence is submitted.

c. General.

Effect of Alcohol on White Mice.*—L. B. Nice found in a previous series of experiments that white mice were not markedly affected when given alcohol in their food. But Stockard has brought forward some striking and conclusive results demonstrating that guinea-pigs are very sensitive to fumes of alcohol and are decidedly injured by it. Nice, therefore, subjected mice to fumes of alcohol every day of the week, except Sunday, keeping them breathing the fumes until they became intoxicated. This took about an hour at first ; after a month a certain tolerance had been acquired, for it took about two hours.

The results of the inhalation method were much the same as those of the feeding experiments. The mice were not much the worse of the treatment. The fecundity of the alcohol mice was greater than that of the control mice. Six p.c. of the young of the male alcohol line, 6·8 p.c. of the double alcohol line, 9·8 p.c. of the female alcohol line, and 4 p.c. of the second generation alcohol line died from lowered vitality, while none of the control young died. Similar results were obtained in the previous feeding experiments, except that the alcohol line had a higher death-rate—11·1 p.c. in the first generation, and 12·5 p.c. in the second generation.

The growth of the young of all the alcohol lines exceeded that of the controls, as in the former feeding experiments. The young of the second generation alcohol line outgrew all the others. There were no abortions, no stillbirths, and no monsters obtained either in the inhalation or in the feeding experiments.

A comparison with Stockard's experiments on guinea-pigs shows the danger of drawing far-reaching conclusions from data obtained on a single species. It is well known in other connexions that mice are very resistant in comparison with guinea-pigs. Mice are immune to the toxin of the tetanus bacillus, and it is not surprising that they have a considerable degree of resistance to the effects of alcohol.

Auditory Ossicles of Aplodontia.†—T. D. A. Cockerell has studied the ear-ossicles in this genus, the only representative in the modern fauna of an ancient series of Sciuriform rodents which, in one of its

* Amer. Nat., li. (1917) pp. 596-607.

† Bull. Amer. Mus. Nat. Hist., xxxv. (1916) pp. 531-2 (3 figs.).

families, dates back as far as the Wasatch Eocene. It seemed probable that the ear-ossicles, hitherto undescribed, would throw interesting light on the relationships of the genus. It was found that the incus and stapes, while possessing marked characters, are not fundamentally different from those of the Sciuridae. The malleus, on the other hand, possesses the lamina and processus cephalicus so characteristic of the Myomorpha, but, lacks the orbicular apophysis. The presence of the cephalic process and lamina fits in with the view that *Aplodontia*, in spite of some obvious specializations, is probably the most primitive living Sciuromorph.

Atrophy of Right Superior Vena cava on Sheep.*—Louis Calvet calls attention to a case of the complete obliteration of the right superior vena cava. A similar abnormality has been recorded in man. The variation recorded is the only one which Calvet observed in about 3,000 hearts supplied to his students for dissection, but he notes that in many cases they were supplied with the vessels a good deal cut.

Rôle of Fins in Teleosts with Swim-bladder.†—L. Bontan has experimented with *Mugil capito*, *Labrus bergylla*, and *Carassius auratus*, and finds that the fins (paired and unpaired) are not indispensable for securing equilibrium. Even in fishes, with the centre of gravity very high, and equilibrium in the normal position very unstable, balance is maintained by movements at the end of the trunk or of the opercula.

Poison of *Muræna*.‡—W. Kopaczewski finds that a dose of 1.5 milligrammes of the poison of *Muræna helena* is fatal to a guinea-pig; that violent shocks are produced, but death is never instantaneous; that the poison is very stable in heat, retaining its virulence after 15 minutes' warming at 75° C.; that boiling destroys the toxicity; that the strong hæmolytic power is conserved even after heating at 75° C.

Serum of *Muræna*.§—W. Kopaczewski finds that when the toxic serum of this eel (*Muræna helena*) has been rendered inactive, by exposure to physical influences (such as heat, ultra-violet rays, and prolonged preservation), there are profound changes in its ultra-microscopic structure. The micellæ, separate from one another and exhibiting a lively Brownian movement, form united groups and lose their movement. By artificial alterations in the surface tension of the serum subjected to the influence of destructive physical agents it is possible to facilitate or retard the appearance of micellar agglomerations, and *ipso facto* facilitate or retard the disappearance of the toxicity.

Toxicity of Serum of *Muræna*.||—W. Kopaczewski finds that the serum of this fish lowers the surface tension of the serum of animals

* Bull. Soc. Zool. France, xli. (1917) pp. 81-5 (2 figs.).

† Comptes Rendus, clxv. (1917) pp. 801-3.

‡ Comptes Rendus, clxv. (1917) pp. 513-5.

§ Comptes Rendus, clxv. (1917) pp. 725-7.

|| Comptes Rendus, clxv. (1917) pp. 803-6.

into which it is injected. The serum of dogfish, skate, and torpedo is also toxic for guinea-pigs, but not so markedly as that of *Muræna*, which is extraordinary. The toxicity of the serum of *Muræna* is not due to the presence of the poison as such, for the serum loses its toxicity almost entirely at 65°, while the poison resists this. The toxicity is supposed to reside in a molecular structure, *sui generis*, such that injection into another blood induces a break-down of molecular equilibrium, marked by the appearance of micellar agglomerations and a lowering of the surface tension of the serum of the poisoned animal. It must be understood that, while the toxicity depends on something besides the poison, it is exaggerated by the poison.

Evolution of Salmonidæ.*—Louis Roule admits that the distant ancestors of Salmonidæ may have been marine fishes, but argues that Salmon (*Salmo salar*) and Sea-trout (*Salmo trutta*) are fresh-water forms which have taken secondarily and partially to the sea where they have a growing period. They are not to be thought of as marine species which have become adapted to fresh-water conditions.

History of Faunas and its Relation to Sex.†—Edmond Perrier accepts the theory that fresh-waters are peopled from the sea, but calls attention to the frequent return to marine life, e.g. in reptiles. Passage from the sea to fresh-water tends to be followed by disappearance of males, and the assumption of hermaphroditism (usually protandrous) on the part of the females, e.g. in Oligochaeta, Hirudinea, Limnæidæ. Maleness is always dangerous; in fresh-water conditions it may be fatal. The disappearance or reduction of males in Tunicates and Cirripedes is noted. Nematodes show all transitions—separate sexes, useless males, hermaphroditism, and parthenogenesis. It is probable that the hermaphrodite marine Opisthobranchs are derived from Pulmonates which in turn were derived from Prosobranchs which left the sea for the fresh-waters. From Opisthobranchs returning, via the littoral zone, to open sea life, the likewise hermaphrodite Pteropods are derived.

Measurements of Degrees of Kinship.‡—Raymond Pearl adds to his previous studies of inbreeding a re-definition of the fundamental concepts involved. On the basis of these definitions he proposes a new and more accurate method of measuring, and expressing numerically, the degree of kinship between any two individuals whatsoever whose pedigrees are known. A new constant, the partial inbreeding index, is described. Its purpose is to indicate numerically the part of the total inbreeding exhibited in the pedigree of any individual which is due to relationship between the sire and the dam of that individual.

* Comptes Rendus, clxv. (1917) pp. 721-3.

† Comptes Rendus, clxv. (1917) pp. 748-51.

‡ Amer. Nat., li. (1917) pp. 545-59.

INVERTEBRATA.

Mollusca.

γ. Gastropoda.

Experiments with *Physa gyrina*.*—Elizabeth Lockwood Thompson has thought out a modification of Pavlov's method of testing the power of association-forming. When the snail, gliding under the surface film with foot and mouth up, is touched close to the mouth with a particle of food, there follows a repeated opening and closing of the mouth. This food-stimulus was synchronously associated with pressing on the foot with a clean glass rod. After 60–110 trials, the snails gave the mouth response when there was synchronous application of the two kinds of stimuli. After forty-eight hours' rest the snails thus "trained" were tried with the foot-pressure stimulus only, and responded with the mouth reaction. The association had been established. It persists for a maximum of 96 hours, and then suddenly ceases. An interesting waning of response in some of the series of trials was indicated by a reduction in the number of mouth movements. This indicated that the snails were becoming adapted to the stimulus which is not followed by its wonted reward. Interesting experiments with a very simple labyrinth anchored to the foot of the tank showed that the snails have no power of learning how to deal with it, how to take the right path leading to air instead of the wrong path which led to no reward, but sometimes to the punishment of an electric shock. The most that they learned was to associate the warning stimulus of an irritating hair with the ensuing punishment of a shock, for 15 p.c. out of a total of 930 trials showed a turning from the wrong to the right path when the warning stimulus of the hair operated. But "selective" ability was a-wanting.

Philippine Species of *Amphidromus*.†—Paul Bartsch has made a study of the Philippine species of this genus of land snails, which presents some interesting zoo-geographic problems. Thus some of the groups—e.g. *A. quadrasi*—show a northward migration from Borneo into the Philippine Archipelago. The group *A. maculiferus* divides up into a series of geographic races, "beautifully accounted for by the separate habitats which they occupy."

Arthropoda.

Arthropods from Burmese Amber.‡—T. D. A. Cockerell describes from a single large piece of amber—a Millipede, *Polyzenus burmiticus* sp. n.; an Acarine, *Cheyletus burmiticus* sp. n.; a Dipteron, *Winnertziola burmitica* sp. n.; a beetle, *Dermestes larvalis* sp. n.; and two Hymenoptera, *Scleroderma* (?) *quadridentatum* sp. n. and *Apenesia electrophila* sp. n. The amber was found in clay of Miocene age, but was derived from elsewhere, and may be much older.

* Behaviour Monographs, Cambridge, Mass., iii, No. 3 (1917) pp. 1–89 (8 pls. and 12 tables).

† U.S. Nat. Museum, Bull. No. 100 (1917) pp. 1–47 (22 pls.).

‡ Psyche, xxiv. (1917) pp. 40–5 (6 figs.).

Arthropods in Burmese Amber.*—T. D. A. Cockerell reports on some Arthropods in amber found in Miocene clay, but perhaps much older, conceivably Upper Cretaceous. The collection includes *Electrobisium acutum* g. et sp. n., a Pseudoscorpion; a new Lepismatid; two new Hemiptera; *Electroformus gracilipes* g. et sp. n., a Hymenopteron, appearing to connect the Fœninæ with the Aulacinæ; *Bethylitella cylindrella* g. et sp. n., in the family Bethyridæ, related to *Mesitius*; *Burmitempis halleris* g. et sp. n., a Dipteron with enormous halteres, apparently nearest to *Microsania* in the family Empididæ; and a small Impid beetle, *Cryphalites rugosissimus* g. et sp. n.

a. Insecta.

Recognition among Insects.†—N. E. McIndoo finds evidence that among bees there is a particular queen-odour, drone-odour, family-odour, hive-odour, and even individual odour among the workers. The hive-odour is supposed to be composite odour, due to the workers chiefly, but supplemented by odours from queens, drones, combs, frames. It is different if the queen be absent. It is carried among the hairs. It serves for recognition. Thus worker-bees returning from the field pass the guards unmolested, though their hive-odour is fainter than when they left, and is also masked in some measure by what they carry. Bees kept in the open air for three days lose the hive-odour, but retain their individual odour. The queen's odour lasts in the hive for some time after she has left. The social life is dependent on the hive-odour and the queen-odour.

As to the scent-producing structures, there are glandular cells in the epidermis. (1) There may be no special device for disseminating the odour or storing the secretion; (2) the gland-cells may be associated with hairs and scales which help to scatter the odour more effectively; (3) there may be "evaginable" sacs lined with hairs connected with gland-cells, thus securing both storage and distribution; (4) there may be articular membranes serving as pouches for storing and preventing a too rapid evaporation of the secretion; and (5) there may be specialized tubes and sacs acting as reservoirs for storing and discharging the secretion. There are thus five types of arrangement. The scent-producing organ of the honey-bee belongs to the fourth type, and is one of the most highly developed organs of its kind. It is a pouch of articular membrane between the fifth and sixth abdominal terga. Gland-cells below the membrane secrete a volatile substance.

Paralyzing Habits of some Hymenoptera.‡—Etienne Rabaud refers to the current opinion that the poison of those Hymenoptera that stab their victims has only a local action, or, at least, that it diffuses very slowly. Thus it is that the insect has to sting the ganglia, and that with great precision. Marchal pointed out in 1887 that statements as to the precision of the stinging should not be accepted without some

* Amer. Journ. Sci., xlv. (1917) pp. 360-8 (8 figs.).

† Smithsonian Misc. Collections, lxxviii. (1917) pp. 1-78.

‡ Comptes Rendus, clxv. (1917) pp. 680-3.

reserve. Rabaud has made some experiments. He put into a narrow tube a Pompilid, *Prionemis variabilis* Rossi, and a spider, *Misumenavatia* Clerck. The Hymenopteron did not sting. It seemed that the sting could not perforate the abdominal cuticle, for when a smaller spider was supplied, one stab proved sufficient to produce paralysis. In some cases a large spider was dealt with effectively by stinging at a weak spot near the anus or the spinnerets. The paralysis followed almost instantaneously, although the place of stinging was at some distance from the nerve centres. Six species of Pompilids and nineteen species of spiders were tried. The Hymenopteron poison, in the case of spiders at least, diffuses very rapidly. So it is not necessary to sting the ganglia. Indeed the ganglia in spiders are well protected. The Hymenopteron does not seek for places corresponding to ganglia, but for places which are weak spots. Some paralysed spiders lived for eight days. The distinction between dead provender and paralysed provender is not very important. Some victims are vulnerable all over, some have but few weak points. There seems to be no seeking for a particular spot, but rather for any vulnerable spot. The position of the ganglia is of secondary importance.

Cytoplasmic Bodies in Germ-cells of Lepidoptera.*—A. Bronté (Gatenby) has made a careful study of the cytoplasmic inclusions in the germ-cells of Lepidoptera, e.g. *Smerinthus populi*, *Pieris brassicæ* and *Orygia antiqua*. A little body, the micromitosome, apparently quite different from chromatin, has been followed from the spermatocyte back into the secondary spermatogonium. It is very probably present in the primordial germ-cell. It has been definitely found in the female. It seems to divide in all divisions, and it appears to be a constant factor in the spermatids of *Smerinthus*.

It is shown that in early stages the cytoplasmic bodies of the female resemble those of the male. There is a definite period, judged to be about the beginning of the growth stage, when the subsequent fate of the mitochondria in the male becomes different from that in the female. The remarkable formation of chromophobe and chromophile zones in the male mitochondrial body is described, and the author discusses the use of these zones.

The formation of the macromitosome (middle piece of the spermatozoon) from the mitochondria is described. The acrosome of the spermatozoon is formed from several acroblasts, which are traced back to the early growth period of the spermatocyte. The centrosome has been shown to divide in the young spermatid, and one centrosome is probably lost, but definite evidence is not forthcoming.

Silkworms in Madagascar.†—Fanchère finds that the races of *Serivaria mori* introduced from the South of Europe to the centre of Madagascar were originally "monovoltine," i.e. with one generation in the year, and that after about two years they were "polyvoltines," with six generations in the year. Their cocoons were not inferior to those

* Quart. Journ. Micr. Sci., lxii. (1917) pp. 407-63 (3 pls. and 5 figs.).

† Comptes Rendus, clxv. (1917) pp. 676-7.

of monovoltines. The eggs of monovoltines must hibernate if they are to hatch out regularly; those acclimatized in Madagascar hatch out very regularly twelve to thirteen days after being laid, without any exposure to cold, which is indeed injurious. The author describes a method of dealing with the pairing methods and the eggs which seems to lessen the risk of pebrine. There is an indigenous silk-moth, *Borocera madagascariensis*, which produces a coarse silk, and has quite different habits.

Variations in Silkworms.*—A. Lécaillon has inquired into the characters of "bivoltine" variations which crop up accidentally in normal races of *Bombyx mori*. In three sets of eggs showing "bivoltinism," there was so little yellow colouring matter that the eggs seemed almost white. There is some chemical peculiarity in the vitellus distinguishing them from normal "univoltines." During embryonic development, the colour-changes in the bivoltine eggs were quite different from the usual succession, which is yellow, rose, reddish, dark red, greyish, slatey-grey. Four days after laying a few of the pale bivoltine eggs showed a faint rose; on the fifth day a good many were of this colour; on the sixth day most of them had still their original coloration.

Past experience in rearing accidental bivoltine variations has been very unsuccessful. They seemed to have little vitality or resisting power. But Lécaillon has not confirmed this. He found them easy enough to rear, and the mortality from disease was not greater than usual. There was nothing peculiar in chrysalis or moth, in the pairing or in the number of eggs laid.

Parthenogenesis in Silk-Moths.†—A. Lécaillon finds that diverse races or varieties of *Bombyx* differ in their liability to parthenogenetic development. In some cases the parthenogenetic changes in the egg may stop at a very early stage; in others they result in a vigorous larva. Actual cases are cited.

Parthenogenesis in Otiorynchus sulcatus.‡—J. Feytaud finds that this formidable vine-beetle is in general parthenogenetic. Among 3000 he found no males; he has never seen a male. Each female produces about 150 eggs. Parthenogenesis is known to be the rule in the allied species *O. turca*, *O. cribricollis*, *O. ligustici*.

Study of Myelophilus minor.§—Walter Ritchie gives an account of the structure and habits of this beetle, rare in Britain, which attacks pine plantations. It is contrasted in detail with the well-known *M. piniperda*. The slight differences between the sexes of *M. minor* are indicated. The brood galleries of *M. minor* are very characteristic, and it is quite easy to distinguish them clearly from those of *M. piniperda*. The specificity of habit is very interesting. The reproductive

* Comptes Rendus, clxv. (1917) pp. 683-5.

† Comptes Rendus, clxv. (1917) pp. 799-801.

‡ Comptes Rendus, clxv. (1917) pp. 767-9.

§ Trans. R. Soc. Edinburgh, lii. (1917) pp. 223-34 (2 pls.).

organs of both sexes are described, and the life-history and the natural enemies are dealt with. The adult beetles, after the laying of the eggs from which the first brood will develop, leave the parent galleries and return to the young pine-shoots at the top of the tree with their reproductive organs in an exhausted state. On a nutritious diet the organs are restored, and a second egg-laying may follow in a new-made mother-gallery. If the beetles, the parents of the first brood, recuperate in time, then from their second laying it is possible that a second issue of adults may take place in a calendar year.

Fertilization in Gnat.*—Monica Taylor notes that the egg-rafts of *Culex pipiens* are laid most copiously between 10.30 p.m. and 12.0 p.m. They are also laid between 4.0 a.m. and 6.0 a.m. The process of fertilization is normal. Segmentation begins in less than an hour after the deposition of the last egg. The chromosome number in the segmenting nuclei is six. A tendency to parasynsidesis (side-to-side pairing of homologous chromosomes) is exhibited by the segmenting nuclei. "Parasynsidesis probably effects the condition of the chromosomes in the nuclei of larva, pupa and imago, i.e. is responsible for the presence of the apparently 'haploid' character of the nuclei in the somatic cells."

Sugar-cane Leaf-hopper.†—C. S. Misra has made an admirable detailed study of *Pyrilla aberrans* Kirby, which attacks the sugar-cane, both as a nymph and as an adult. It belongs to the family Fulgoridæ, sub-family Lophopinæ. Descriptions are given of the eggs, the hatching, the five instars of the nymph, the last moult, and the adult. Account is taken of the few predatory enemies, e.g. occasional ants and dragon-flies, and of the parasitic Chalcididæ, Dryinidæ, and Stylopidæ. Much attention is given to practical questions. The memoir is very well illustrated.

Bibliography of Human Lice.‡—G. H. F. Nuttall has compiled a very useful annotated bibliography of the zoological and medical publications relating to the two species of lice (*Pediculus humanus* Linn., 1758, and *Phthirus pubis* Leach, 1815) infesting man, the part they play in pathology, the prophylactic measures and means of destruction employed against them, their structure, functions, habits, and inter-relations. The bibliography enumerates 639 publications, of which 404 have been consulted in the original, 81 in the form of abstracts or quotations by other authors, whilst 154 are cited by title only, being either inaccessible or still to be consulted.

Lice and Disease.§—G. H. F. Nuttall gives a critical summary of the evidence which shows that *Pediculus humanus* (*corporis* and *capitis*) is the carrier of typhus and relapsing fever. Infection with the typhus

* Quart. Journ. Micr. Sci., lxii. (1917) pp. 287-301 (1 pl. and 1 fig.).

† Mem. Depart. Agric. India, v. (1917) pp. 73-133 (6 pls. and 17 figs.).

‡ Parasitology, x. (1917) pp. 1-42.

§ Parasitology, x. (1917) pp. 43-79.

virus occurs through the bite of infective lice, or through such lice being crushed upon the skin when it is scratched. Lice remain infective for at least eleven days. Lice are invariably present in connexion with typhus outbreaks. The destruction of lice upon a typhus patient renders him innocuous. The prophylaxis of typhus consists in louse destruction. Bed-bugs and fleas do not convey the disease.

Epidemiological evidence, as in the case of typhus, points to relapsing fever being louse-transmitted. The microbe (*Spirochæta recurrentis*) passes from parent louse to its offspring. As Nicolle and others have shown, lice do not convey relapsing fever by their bites. Infection occurs through the lice being crushed on the skin, or infective material may be carried on the fingers to nose or eye. The spirochæte can invade the system through intact mucous membranes. The author discusses miscellaneous infective diseases which lice may spread, and the primary effects of biting. The secretion of the salivary glands has some degree of toxicity. The secretions of the two sets of salivary glands contain, Nuttall found, a substance which retards the coagulation of the blood.

Biology of Lice.*—G. H. F. Nuttall has gathered together the observations which have been made on the life and habits of *Pediculus humanus*, adding here and there his own. The species is restricted to man, its nearest relative occurring on monkeys. It lives solely on blood, for sucking which the mouth-parts are adapted. After the nit or egg-stage, there are three larval stages and the adult; from the first larval stage to the adult there are three moults. The single sharp claw on each leg is suited for progression on hair. Body-lice (*P. corporis*, *P. vestimenti*) and head-lice (*P. capitis*) are at most merely racial forms of *Pediculus humanus* Linnæus. The distribution appears to be world-wide, but there is some dearth of precise data.

In modern times lousiness is largely confined to the poorer classes and to soldiers in the field. It seems that *capitis* occurs more frequently on females than on males, and that the reverse holds to a certain extent for *corporis*; there is a greater prevalence of *capitis* in children and old people. There may be over 10,000 lice of *corporis* about one person and over 1,000 of adult and larval *capitis*; there appears to be an increase in winter and a decrease in summer. Man becomes infested by contact with verminous healthy people; by contact with infected sick, dying, and dead; by contact with infested clothing, bedding, brushes; and by stray lice. Lice may be casually carried by wind and by flies.

The rate of locomotion varies with temperature, illumination, and the nature of the surface. Nuttall observed on sateen a rate of 1 metre in 2 minutes 43 seconds; on hair 20 cm. in 1 minute 24 seconds to 3 minutes 10 seconds, or more. Lice can cover in a few minutes a distance equal to the length of a man's body.

The second part of Nuttall's paper gives an account of the methods of raising lice experimentally—notably the felt-cell method and the wristlet method—and some other practical points. With a questionable

* Parasitology, x. (1917) pp. 80–185 (2 pls. and 12 figs.).

exception of rearing on pigs, there is no record of successful raising of *Pediculus humanus* except on man.

There is notable variation in the proportion of the sexes in the offspring of different parents. There are broods in which one sex predominates. Oviposition lasts 17 seconds at most. The female walks backwards along a hair, which glides within the fork formed by the posterior lobes of the last abdominal segment. The gonopods are flexed away from the body and against the hair, gripping it; a minute drop of hyaline fluid is exuded; the egg is liberated and cemented; the female releases her grip with the gonopods and moves forwards. Full details are given. A female in optimum natural conditions may lay 9 to 12 eggs a day, 275 to 300 in all. There is, especially in *corporis*, a marked tendency to oviposit where eggs have been previously laid. Unfertilized eggs may be laid, but they do not develop.

The eggs of *corporis* do not hatch at 22° C., or below; the development is about 16 days at 25° C., 5 to 6 days about 36°–37°; they die without hatching at 40°–45° C. The eggs of *capitis* on the wrist at 32°–35° C. hatched in about 7 days.

An account is given of the obvious changes within the egg, the emergence of the larva, and the moults. The development from egg to egg may be passed through in about 17 days—7 in the egg, 4 in the first larval stage, 3 in the second, 2 in the third, and 1 day before oviposition. A female may have 1918 descendants during her lifetime, and the offspring of her daughters, during their lifetime, would number 112,778—48 days after the original female began ovipositing. A female may live up to 30 days at 28° C., if fed once daily; 45 days, if fed twice and kept at 24° by day and 34° by night; with more feeding a male may live 32 days and a female 46. When kept continuously on the wrist, a male may live 23 days, a female 22 days.

Descriptions are given of the mode of feeding, the gorging when very hungry, the reactions to various stimuli, the "sham death," and many other interesting details of behaviour.

Notes on Lice.*—F. M. Howlett found in India that specimens of *Pediculus capitis* bred on the body showed in the second generation a modification of chitinization and colour in the direction of *P. corporis*. Previous experiments with an unidentified species of *Culex* showed that a warm surface stimulated the female to bite. The proximity of a hot body (e.g. a warmed comb) stimulated rapid and excited movement in *Pediculus* and *Phthirus*, which made for the warm surface.

Philippine Derbidæ.†—Frederick Muir reports on large collections of these delicate little insects (Rhynchota), and brings the Philippine list up to ninety-eight species in thirty-nine genera. Many of the species have been erected on characters of the male genitalia, e.g. the form of the pygophor, anal segment, and genital styles. The eggs of Derbidæ have never been described, and the author has failed to find them.

* Parasitology, x, (1917) pp. 186–8.

† Philippine Journ. Sci., xii, (1917) pp. 40–104 (1 pl. and 4 figs.).

Convergence among Ectoparasitic Insects.*—N. C. Rothschild discusses the repeated occurrence in different orders of similar structural details. There may be convergence in reduction of mouth-parts, in reduction of wings, in reduction of eyes, and so on. The degree of parasitism in adult epizoic insects seems to be of less importance in connexion with the reduction of eye than the absence of light. Many similarities are found in the adaptations which enable the parasite to hold on to its host, or to move about on it with safety. Many epizoic insects “glide through the fur of the host as quickly as a seal travels through water or a corncrake through grass.” “The medium in which a species exists exercises a most powerful influence on its evolution.”

Abdominal Extremity in Orthoptera.†—L. Chopard has made a study of the various structures at the end of the abdomen in Orthoptera. (1) The term suranal plate should be applied to the last tergite in Blattidæ, Mantidæ, and adult Locustidæ. The eleventh tergite of other Orthoptera should be called the superior anal valve. (2) There are two inferior anal valves, which, in some cases at least, are due to fusion of the tenth and eleventh sternites. (3) The “subgenital plate” is of heterogeneous nature, differing in different types. (4) The “oviscapt” with six or four valves is found in all female Orthoptera except Cur-tillinæ. Its superior valves are homologous with the lobes of the male subgenital plate.

Longevity of Males of *Carausius morosis*.‡—G. Foucher obtained two males among the numerous offspring which he reared from this parthenogenetic Orthopteron. The male is 60 mm. in length as contrasted with 80 mm. for the female. It was very delicate and agile. Its pairing with the female was observed. One lived for seven months and three days, a long time for a male Orthopteron. There is some indication that starving the parthenogenetic females induces the appearance of males, but more data are required.

Intersexual Forms of Gypsy-Moth.§—Richard Goldschmidt continues his study of the Gypsy-Moth (*Lymantria dispar*) as regards intersexuality. Each sex contains the factors of both sexes. Which factors become potent depends upon the quantitative relation of the two sets of factors. Both of them possess a quantitatively definite strength of action or potency. In normal sex-distribution the right combinations are regulated by the heterozygosis-homozygosis mechanism. Different races differ, it is assumed, in regard to the absolute potencies of these factors. Cross-breeding results in abnormal combinations, seen in the intersexual forms.

There is a remarkable seriation in both male and female intersexuality. The series is the inverse of the order of differentiation of

* *Trans. Entomol. Soc. London*, 1916, part v. (publ. 1917) pp. cxli-clvi (30 figs.).

† *Arch. Zool. Expér.*, lvi. (1917) *Notes et Revue*, No. 5, pp. 105-12 (7 figs.).

‡ *Comptes Rendus*, clxv. (1917) pp. 511-3.

§ *Journ. Exper. Zool.*, xxii. (1917) pp. 593-617 (53 figs.).

the organs in development. Thus the last organs to differentiate in the pupa and the first to be intersexual are the branching of the antennæ and the coloration of the wings. The first imaginal organ differentiated in the caterpillar, and the last in the series to be changed toward the other sex, is the sex-gland.

The theory that best fits the facts is that the sex-factors are enzymes (or bodies with the properties of enzymes) which accelerate a reaction according to their concentration. In the fertilized egg the enzymes which govern the differentiation of the organism towards one of the two alternatives, maleness and femaleness, are both present. They may be called gynase and andrase. The mechanism of sex-distribution—i.e. through the sex-chromosomes—results in the formation of two kinds of fertilized ova, differing in the relative concentration of the two enzymes. Higher concentration results in greater rapidity of reaction, and the more rapid reaction wins. The dominating enzyme, present in higher concentration, will first succeed in furnishing the necessary amount of specific substance acting as determiner, which may be called the hormone of male or female differentiation. In intersexual forms, which result in conditions of abnormal concentrations of enzymes, development must go on under the influence of one enzyme up to a certain point and then continue under the influence of the other. "A given organ develops, in the case of female intersexuality, on female lines up to a given point, when suddenly the male stimulus starts, and the rest of the development is purely male. The degree of intersexuality is determined by how long the development has been in progress before the turning-point occurs."

As regards the cytological aspect of the case, Goldschmidt makes the following suggestion. The chromosomes cannot be regarded as built up from chromatin particles, which are themselves the chemical basis of heredity. The chromatin is rather a skeletal substance which works as an "adsorbens" for the enzymes, which really constitute the chemical basis of heredity. The quantitative behaviour of the enzymes is of fundamental importance for the process of heredity. "The quantity of adsorption of an enzyme by an adsorbens depends upon the qualities of both and the surface of the adsorbens. The wonderful uniformity of size and shape of the chromosomes of a given animal appears, therefore, as a minute mechanism to guarantee the typical quantity of enzymes of heredity to be assembled at the moment of fertilization. And all the strange processes preceding the maturation of the sex-cells appear easily understandable, as well as the meaning of the peculiar mechanism of mitosis. The formation of a chromosome means, physically, the same thing as the dropping of a piece of charcoal into a solution containing enzymes."

Bristle Inheritance in *Drosophila*.*—Edwin Carleton MacDowell has worked with a race of flies with extra bristles. Selection was continued for forty-nine generations for the production of high numbers of extra bristles. In any generation after the early ones the distribution of a single family is similar to that of the distribution of all the families

* Journ. Exper. Zool., xxiii. (1917) pp. 109-46 (10 figs.).

taken together in that generation. For about eight generations the means rose; following this were two periods not comparable with each other, within neither of which was there any evidence of further advance. Continued selection did not produce any high extremes that were not obtainable near the beginning of the experiment. The range of variation changed only very slightly; the low limits being most frequently at 0 or 1, the high limit at 9 for the females, at 7 for the males. The standard deviations rose and fell together with the means; as the means of the females are higher than those of the males, so the standard deviations of the females are higher than those of the males. These relationships do not hold true when the complete yields of the bottles are not included (generations 33-49). Changes in the means of the parents are not accompanied by changes in the means of their offspring, except at the beginning of the experiment.

By selecting low-grade parents from the second generation of the extra-bristled race it was found possible to establish a race of flies which had markedly lower means than the high-selected race.

By selecting low-grade flies from the fifteenth generation of the high race and continuing to select for low grades, it was found impossible in eight generations to establish a race that was distinguishable from the high race. The attempt was repeated, starting from the twenty-sixth generation of the high race, and continued for six generations with similar results. Return selection does not reverse the progress made by the advance selection. Flies with high and low bristle grades appear to have very similar offspring.

By selecting low-grade parents from the F_2 of a cross between normals and flies from the sixteenth generation of a high race, a low race was established (extracted low). One selection was sufficient to establish this race as distinct from a high race; for four generations the curves of the parents and offspring were parallel, and after that completely independent; for four generations the low selection continued to lower the means; except in the first few generations the curves of the progeny rise and fall in harmony with the curves of the high race, when families raised at similar times are compared; besides being lower than the high race, the variability of the extracted race is less than that of the high race; in response to the same improvement in conditions it does not advance as far.

Comparing the different races, it is found that, no matter what the percentage, they all exhibit high points and low points at the same time. This means that environment is accountable for the variations in most of the generations. But the initial rise in the high race was not due to environment, as this rise resulted in a genetic change in the race.

The supposition of a single varying factor to explain the above results cannot be justified; it would require numerous other assumptions. All the results are simply explained on the assumption that there were genetic differences present among the original flies with extra-bristles; that these genetic differences (or genes) are entirely independent of the main factor that occasions the monohybrid ratio in crosses with normal flies.

Monograph on Dragonflies.* — R. J. Tillyard has provided an admirable monograph on Odonata, correlating morphological, phylogenetic, and physiological data, and including numerous personal observations. It is in every way a first-class piece of work. The Odonata form a singularly isolated group, marked by high specializations of structure, superimposed upon an exceedingly archaic foundation. No near relatives exist to-day, nor since Palæozoic times. The Plectoptera or May-Flies are nearest to the Odonata, but the affinity is slight. The Protodonata of the Upper Carboniferous were the ancestors of the present-day Odonata, but an unfortunate gap in the Trias hides the exact line of descent from our view.

The leading characters of the order are summarized; a detailed account is given of the external features of adult and larva. In the male of *Hemiphysalis mirabilis* the anal appendages of the male are rather long, white, and very conspicuous. The inferior pair are like white ribbons. The male uses them to attract the attention of the female by waving them about while at rest on a reed stem. The female replies to his signals by showing the whitened underside of the tip of her abdomen.

A full account is given of the general structure, histology and development of the wings. The wing-bud is an ectodermic evagination, in the form of a small bag lined internally with hypoderm cells and externally with the cuticle. Between the layers of hypoderm is a narrow prolongation of the hæmocœle, filled with blood. Into this space the tracheæ soon penetrate and fine nerves accompany them. At the metamorphosis the wings appear as crumpled bags; blood is forced in and the bag expands, is smoothed out, and dries. The fluid persists for an hour or two or for several days, according to the weather and other factors, and gives the wings a pale greenish colour, while the additional refraction of the rays of light through the still separated media gives a beautiful iridescence to the surface.

The author gives an account of the macroscopical and microscopical structure of the various systems. Various authors have stated that the mushroom bodies of the dragonfly's brain are rudimentary, and that the intelligence is of a low order, but the fact is that the mushroom bodies are very well developed, though of a generalized type, and the assumption that they are the sole seat of intelligence is unwarranted. The movements of feeding are almost certainly controlled from the sub-œsophageal ganglion, and many facts show that the ventral ganglia have much independence. The vision is probably the keenest among invertebrates, and its range for the detection of movements may be ten to twenty yards. A dragonfly sees objects best at distances from a few inches to five or six feet, but this is long-sighted compared with other insects. The number of facets in the compound eye ranges from about 10,000 in the smaller Zygoptera to 28,000 or more in the largest *Æschyninae*. The so-called "internal light" of a dragonfly's eye, which is beautifully coloured, is a reflection from the interior. The compound eyes are large and functional in the newly-hatched larva; the ocelli

* *The Biology of Dragonflies*. Cambridge: 1917, xii and 396 pp. (4 pls. and 188 figs.).

appear late in larval life or only at metamorphosis. Clean-cut removal of the antennæ does not disturb dragonflies in the least. Smell seems to be practically absent. Hearing is dubious, and is probably represented by a sense of equilibration or poise. The larvæ may have a chemical sense.

Tracheal gills are developed in the larvæ of dragonflies in three places: (1) in all Anisoptera, within the anterior portion of the rectum, by specialization of the rectal epithelium and pads (forming the beautiful branchial basket); (2) in most Zygoptera, on the two caudal cerci and the appendix dorsalis; and (3) on a few archaic Calopterygidae (which have also caudal gills), on the sides of certain abdominal segments. Besides these the rectal pads or folds of Zygopterid larvæ probably function as blood-gills. The structure of the various types of gill is described with great care. The spiracles of the larva are either closed or only partly functional.

"The dragonfly differs from all other insects in the fact that the great muscles of the synthorax are directly connected with the wing-bases by means of tendons. In all other insects the muscles by means of which the action of the wings is controlled are not directly connected with those organs, but are connected with the notum. . . . The direct attachment to the wing-bases has been brought about by the development of special sclerites, derived from the notum, in the formation of those bases." The fore and hind wings work quite independently. There is only one true axillary or wing-pivot.

The copulatory apparatus of the male dragonfly is one of the most remarkable structures in the animal kingdom. It "is not homologous with any known organ; it is not derived from any pre-existing organ; and its origin, therefore, is as complete a mystery as it well could be." A careful description is given.

The egg, when laid, consists of the nucleus, the formative protoplasm in the yolk, the periplasm around the yolk, the yolk, the vitelline membrane, the chorion with one micropyle, and some gelatinous matter. The embryonic development is described.

Out of the egg comes a "pronymph" enveloped in a cuticular pronymphal sheath. It swells very rapidly and moults, liberating the free-swimming larva. There are eleven to fifteen instars, each with an ecdysis. The larva may reach maturity in a year, or not for five years. The "mask" is a transformation of the second maxillæ. The changes during larval life include the appearance of ocelli, the increase in the number of elements in the compound eye, the increase in the number of joints in the antennæ from three to seven, the development of wings, the correlated changes in the thorax, the increase in the number of Malpighian tubes, and so on. The final metamorphosis is described, with some reference to the peculiarities in *Petalura gigantea*.

After discussing the classification (429 genera, 2457 species), the geographical distribution, the fossil forms, the author concludes his fine monograph with a very interesting paper on bionomics, an account of British species, and practical advice as to collecting and preserving. .

5. Arachnida.

Alteration of Instinct in Spider.*—Jeanne Berland observed that females of *Nemoscolus lauræ*, which were induced to make webs in Borel tubes, altered the plan from an orb with a large diameter to a sector elongated vertically and with few rays (as in the genus *Hyptiotes*). In adaptation to a narrow space the characteristic form of web was profoundly altered.

Cardiac and Skeletal Muscle of Scorpion.†—H. E. Jordan finds that the striped muscle of the Florida scorpion is very similar to that of *Limulus*, and accordingly conforms more closely to the Vertebrate type of striped muscle than to the Arthropod type as exemplified by certain insects and by the sea-spider. The cardiac muscle of scorpion and of *Limulus* conforms with Vertebrate heart muscle in its syncytial structure, in the more or less regular radial arrangement of the myofibril bundles (lamellæ), and in the definite character of the relatively less complex cross striping. The skeletal muscle also of these forms agrees with Vertebrate skeletal muscle with regard to the major stripes, and in the absence (or extreme tenuity) of the mesophragma and the accessory disc (N-disk) of Engelmann and Rollet, conspicuous in certain insect muscles. There is in the scorpion an essential identity in microscopic structure between the cardiac and skeletal muscle. The axial location of the nuclei, the radial lamellar arrangement of the myofibrils, and the relative simplicity of the striations all indicate a relatively low degree of differentiation. Many details as to structure are communicated.

Rare Hydracarid.‡—W. Williamson reports the occurrence of a female of *Lebertia densa* Koen. at Craigallian Loch, and gives a description and figures. The rare species does not seem to have been recorded since Koénike found it at Harburg in 1902. Its discovery at Craigallian brings the number of British species of *Lebertia* up to eleven.

New Parasitic Acari.§—Stanley Hirst describes *Chirodiscoides curviæ* g. et sp. n., a curious minute mite found on the hairs of the posterior region of the guinea-pig's back. As in *Chirodiscus* the anterior legs are adapted to form hair-clasping organs. During copulation the male attaches himself to the generative nymph by little suckers on the venter and also by the elongated legs of the fourth pair, the hook of the tarsus becoming fixed in the projecting posterior margin of the second epimeron. A description is also given of *Demodex muscardini* sp. n., from a dormouse, and *D. erinacei* sp. n., from a hedgehog.

Leg-muscle of Sea-spider.||—H. E. Jordan finds material of exceptional clearness in the leg-muscle of *Anoplodactylus lentus*. It differs from that of *Limulus* in being of the typical insect type, while that of

* Arch. Zool. Expér., lvi. (1917) Notes et Revue, No. 5, pp. 134-7 (4 figs.).

† Anat. Record, xiii. (1917) pp. 1-20 (21 figs.).

‡ Scottish Nat., 1917, pp. 271-4 (2 figs.).

§ Ann. Mag. Nat. Hist., xx. (1917) pp. 431-4.

|| Anat. Record, x. (1916) pp. 493-508 (7 figs.).

Limulus corresponds more closely to the Vertebrate type. The microscopic structure is described in detail, but it is difficult to give an intelligible summary without a figure showing the discs, lines, and other differentiations.

6. Crustacea.

New Zealand Sandhoppers.*—Charles Chilton describes three New Zealand species of *Talorchestia*, and gives a diagnostic key and excellent figures. In the male of *T. telluris* there is an extraordinary process on the fifth peraeopod (hind margin of the carpus). There is a suggestion of dimorphism among the males, for there are two forms with very different second gnathopods. It is possible, however, that the second form should be ranked as a separate species.

New Isopods from British Guiana.†—A. S. Pearse describes some new species, and establishes a new genus, *Circoniscus*, which is closely allied to *Sphæroniscus* Gerstaecker, but differs in having only two segments in the flagellum of the second antenna.

Habits of *Lepidurus viridis*.‡—E. M. Herriott has studied this interesting Phyllopod, common in shallow pools in New Zealand. Their sudden appearance is due to the rapid development of the "winter" or "resting" eggs, which are able to survive desiccation for months. When feeding they usually lie on their back, moving all their limbs. They bite at the caudal setæ of their neighbours, and devour the dead bodies of their fellows. There is considerable diversity of coloration and size. The exhausting process of moulting is described, and the rapid movements—mostly with ventral surface downwards—are also dealt with.

Annulata.

Dimorphism in a Polychæt.§—F. Mesnil and M. Caullery find that *Spio martinensis* is dimorphic. Some sets of eggs develop into a typical Spionid larva of pelagic habit; other sets develop within the spawn-mass, directly and without any pelagic stage. In the second case there is cannibalism or adelphophagy. The phenomenon requires further study; it seems to be similar to what Giard called pœcilogony.

Segmentation of Ovum of *Protula meilhaci*.||—A. Soulier notes that after the eight-cell stage there are two vertical cleavages in new planes, at angles of 45° with the first vertical planes. The two planes do not appear simultaneously, though, in general, the posterior elements are formed before those anteriorly. In the fifth stage there is the same lack of simultaneity in the formation of two more cleavage

* Trans. New Zealand Inst., xlix. (1917) pp. 292-303 (18 figs.).

† Mus. Zool. Univ. Michigan, Occasional Papers, No. 46 (1917) pp. 1-8 (3 figs.).

‡ Trans. New Zealand Inst., xlix. (1917) pp. 284-91.

§ Comptes Rendus, clxv. (1917) pp. 646-8.

|| Arch. Zool. Expér., lvi. (1916) Notes et Revue, No. 4, pp. 100-3 (6 figs.).

planes parallel to the first equatorial plane. Thirty-two cells are thus established, but Soulier explains how it is that, as a matter of fact, there are thirty-four.

Echinoderma.

Multiplication by Fission in Holothurians.*—W. J. Crozier observed nine cases in which *Holothuria surinamensis* divided itself into two parts. The animals concerned seemed healthy, and bore no visible signs of having been in any way injured. In no case did the halves divide again, although in two cases the resulting portions lived in the laboratory for a month, during which time, even in the absence of food, missing parts were regenerated. In one case the division occupied five days; in another, twenty-four hours. It begins midway in the body with a deep insinking of the dorsal bivium. A powerful circular constriction, accompanied by some local disintegration of the integument, completes the separation. During the progress of division the animal is quiescent, although it may be adhering firmly by its tube feet to the vertical wall of the aquarium. When the constriction and separation of the skin and muscle-layers is completed, a short length of intestine usually remains for a time connecting the two pieces; it may rupture close to one of them, or may disintegrate completely. The resultants of the division do not move apart, but remain quiescent. Many regenerating specimens were observed. There is thus good reason to believe that *Holothuria surinamensis* in the adult state normally multiplies by a process of binary fission.

Buccal Armature of Conulus.†—Herbert L. Hawkins describes the buccal plates and girdle of *Conulus albogalerus*, an Echinoid from the Upper Chalk. The perignathic girdle is very like that of *Discoidea*, with modifications due to the greater degree of thickening of the inter-radial coronal plates and to the massive character of the buccal plates. The existence of a lantern is inferred, the arguments being based upon the known characters of the girdle, and upon analogy with related types. Certain imperfect ossicles within the test of a small specimen are considered to represent portions of the lantern.

Cœlentera.

Australian Alcyonarians.‡—Hjalmar Broch reports on a collection of Alcyonarians made by E. Mjöberg's Swedish Scientific Expeditions to Australia (1910-13). There were twenty-five species, fourteen new. The representation of the different families is curious, but finds its explanation in the bathymetrical conditions of the locality (a pearl-bank west-south-west of Cape Jaubert) where the collection was made. Of considerable interest was the following:—*Nephythygorgia kükenthali* sp. n., *Studeriotis crassa*, *Suberiopsis australis* g. et sp. n. (near *Anthothela*), *Titanidium mjobergi* sp. n., and *Alertigorgia orientalis* (Ridley).

* Amer. Nat., li. (1917) pp. 560-6 (2 figs.).

† Geolog. Mag., iv. (1917) pp. 433-41 (1 pl.).

‡ K. Svensk. Vetensk. Handlingar, lii. (1916) pp. 1-48 (4 pls. and 62 figs.).

Skeleton of Stromatoporoids.*—Yvonne Dehorne finds that the minute structure of the skeleton of these extinct Hydrozoa is apt to lead to fallacious conclusions. Thus that of the typical *Actinostromaria stellata* is like that described by Ogilvie in the Madrepora *Porites incrustans*. The zoecia of some Polyzoa show a similar structure. The minute structure of the wall depends greatly on the mode of fossilization and on subsequent transformations of this. Definition must depend rather on the individualization of the zooids, on the mode of arrangement, and on the growth of the whole colony, which permits of a reconstruction of the aspect of the living hydrorhizal surfaces.

Coppinia of Grammaria abietina.†—Hjalmar Broch has studied in this hydroid the aggregates of gonangia which are known as coppinia. The formation begins with the appearance of secondary stolons, which form a feltwork over the primary twigs and give off the tubes and gonothecæ of the coppinia. The primary and secondary stolons are united by numerous anastomoses. Into the coppinia the hydrothecæ also project, but they grow so that the oral apertures project beyond the feltwork. After the reproduction is completed the secondary parts of the coppinia are discarded, and the elongated hydrothecæ are left for a time conspicuously projecting.

An account is given of the stinging-cells of the protective polyp. In the lumen of the protective polyp traces of ova were sometimes found, and these were traced through the stolons to the nutritive polyps. It seems that the latter may devour liberated ova—a danger at the very threshold of life. The author discusses the migration of the young ova from the ectoderm of the primary and secondary stolons to the gonangia. They may move in the endoderm as well as in the ectoderm in amœboid fashion, and they readily penetrate the middle lamella. The reproductive individuals show sex-dimorphism. The male gonophores are cryptomedusoid in structure, the female heteromedusoid.

Porifera.

Chessman Spicule of Latrunculia.‡—Arthur Dendy discusses the development of the "discorhabd" of *Latrunculia bocagei* and *L. apicalis*. In the former species it consists of a straight, stout shaft, expanded at the lower end to form a knob-like base (the "manubrium") ornamented with two circles of short spines. A little beyond the middle of the shaft there is a whorl of three flattened lobes with denticulate or crenate margins, followed after a short interval by a similar whorl, and then, after another short interval, by a third whorl which differs from the other two in not being subdivided into three lobes. Immediately after the third whorl comes the broad, hemispherical apex, provided with a number of short, capitate spines, and forming a sort of crown. The whorls may be called median, subsidiary, and apical. The length or height of the fully-grown spicule is about 0.07 mm.

In *L. apicalis* the spicule is continued beyond the apex into a slender

* Comptes Rendus, clxv. (1917) pp. 764-6.

† K. Norske Vidensk. Selskabs. Skrifter, 1916, No. 1, pp. 1-16 (2 pls. and 3 figs.).

‡ Journ. Quekett Micr. Club, xiii. (1917) pp. 1-16 (3 pls.).

tapering process like the "leader" of a growing fir-tree, with a single or double circlet of small spines at the base. The median whorl is a little farther from the apical whorl than in *L. bocagei*, being approximately midway between the apical whorl and the manubrium. The length of the fully-grown spicule is about 0.126 mm.

The spicules are well adapted to protect the surface against parasites and other enemies. They are arranged in a dense forest, with their manubria firmly implanted in the cortex. They are developed, however, in the interior of the body, far removed from their final position.

A siliceous spicule contains an axial thread or "protorhabd," outside which is the coating of hydrated silica or opal. Very slender protorhabds were found, which were at any rate near the initial stage. The protorhabd is responsible for the spicule's growth in length, and may continue its activities independently of any possible mother-cell. With the protorhabds minute formative cells were found associated; they are probably responsible for the arrangement of the silica around the protorhabd foundation. There are also larger accessory cells, probably silicoblasts, which supply the formative cells with the necessary material.

The author describes the development of the discorhabds, and advances the theory that the position of the whorls corresponds with the nodes in a vibrating rod, the vibration being due to the stream of water through the canal system. The coincidence of the positions of the median and subsidiary whorls with those of the rings of formative cells is noted. It may be that the formative cells have a sort of tropism; that they are sensitive to vibrations in such a way that they are induced to avoid the internodes and take up their positions at the points of comparative rest of the vibrating rod, with which they are doubtless at first in immediate contact. The difference in the position of the median whorl in the two species can be mechanically accounted for. It is unlikely that natural selection has had to do with the differences in the apices of the spicules in the two species. The facts support the view that the characters separating species are usually of little or no importance to their possessor in the struggle for existence, while adaptations are usually shared by many different species.

Irish Sponges.*—Jane Stephens reports on the sponges collected by the dredging expeditions of the Royal Irish Academy and the Royal Dublin Society. The number of species is thirty-eight, including two species new to science—*Mycale (Paresperella) atlantica* and *Forcepia fragilis*. The first is especially interesting, because it is the first representative of the sub-genus *Paresperella* found in the Atlantic Ocean. The following five species are noted for the first time within the Irish area:—*Laxosuberites ectyoninus* Topsent, *Desmacidon fruticosum* (Montagu), *Hymenancora conjungens* Lundbeck, *Microciona lævis* Bowerbank, *Tragosia polypoides* Schmidt. The first and third have not been taken previously off any part of the British Isles; each, in fact, has only been recorded once before—the former in the Mediterranean, the latter off the south coast of Iceland. A plate of spicules is given.

* Proc. R. Irish Acad., xxxiv. (1917) pp. 1-16 (1 pl.).

Protozoa.

Conjugation and Encystation in *Didinium nasutum*.*—S. O. Mast has studied various groups of pure lines of this Ciliate, between April, 1910, and May, 1914. During this time there were produced without conjugation an average of 1646 generations per line, and without encystment an average of 1035 generations per line. At the close the stock was very weak, but it did not die out. It is not likely that either conjugation or encystment is necessary for continued existence in this Infusorian.

From time to time new groups of lines were started from old ones, some after conjugation, others after encystment, and still others without either conjugation or encystment. There were, consequently, continuously present a number of groups of lines which differed in the number of generations produced since conjugation or encystment had occurred.

The rate of fission varied greatly throughout the experiment, owing largely to changes in temperature, but at any given time there was approximate uniformity in the fission-rate (and also in the death-rate) in all the groups of lines regardless of the distance removed from conjugation or encystment. There was, therefore, no evidence indicating the presence of cycles related to these processes.

There was no evidence that conjugation or encystment has any appreciable effect on death-rate, fission-rate, or variation in fission-rate. This would indicate that neither conjugation nor encystment is a rejuvenating process, at least not in the sense in which Calkins uses the term.

In one of the groups of lines, 721 generations after conjugation and 197 generations after encystment, some of the offspring suddenly began to divide more rapidly than others. The difference in the rate of fission in these two sets of individuals remained fairly constant throughout the remainder of the experiment, 315 days. During this time one set produced an average of 838 generations per line, $2\frac{2}{3}$ per day; the other, an average of 634 generations per line, 2 per day.

Life-history of *Ceratomyxa herouardi*.†—Jivoïn Georgevitch gives an account of this interesting Myxosporidium which he found in the gall-bladder of *Boz salpa*. Ripe spores from another host enter the gall-bladder from the food canal. The spores, which have lost their capsular filaments (used in their pilgrimage), liberate the sporoplasm which is binucleate. The sporoplasm emits a pseudopodium; the two nuclei unite completely, forming a zygote or pansporoblast which fixes itself by pseudopodia to the wall of the gall-bladder. The nucleus divides twice, forming a large vegetative nucleus and two smaller germinative nuclei.

The pansporoblast may exhibit schizogony, or schizogony with repeated divisions of the germinative nuclei, or it may exhibit direct sporulation. In a very complicated fashion, of which the author gives an indispensable diagrammatic illustration, there is an alteration of a sexual phase and numerous asexual phases.

* Journ. Exper. Zool., xxiii. (1917) pp. 335-59.

† Arch. Zool. Expér., lvi. (1917) pp. 375-99 (2 pls. and 3 figs.).

New Mode of Multiplication in Amœbidium.*—Jean L. Lichtenstein describes in a species of *Amœbidium* from *Simocephalus retulus* how an active amœboid unit, which emerged along with seven others from a fragmenting "tube," became after a time fixed on the host and elongated into a "tube" or "endoconidium." This lends support to the view that Amœbidiaceæ are Thallophytes, not Protozoa.

Blastocystis enterocola.†—A. Alexeieff discusses the reserve albuminoid bodies of this organism (consisting of paravolutin or metachromatin), the mitochondria and what they give rise to, the nuclear origin of the mitochondria, and the amœboid parasite *Mitraria dangeardi* Alexeieff, which penetrates the *Blastocystis* cysts and feeds on the reserves. The conclusion that *Blastocystis* is fungoid is confirmed.

New Species of Pseudoklossia.‡—L. Léger and O. Duboscq describe a new Coccidian, *Pseudoklossia pectinis* sp. n. from the kidney of *Pecten maximus*. They give an account of the gamonts, the macrogametes, and the formation of sporozoites. No microgametocyte was found. The relationships of Adeleidæ and Eimeridæ are discussed.

Life-cycle of Myxidium gadi.§—F. Georgevitch describes the life-history of this parasite, which he found in the gall-bladder of *Gadus pollachia*. From the ripe spore there emerges a binucleate sporoplasm; the zygote exhibits schizogony, and there are several generations of schizonts; these exhibit sporogony with one spore or two spores or many spores. When there are many spores, there are often phenomena of plasmotomy. The parasites are never intracellular.

Leptotheca and Glugea.||—J. Georgevitch describes *Leptotheca elongata* Thélohan, a Myxosporidian, from the gall-bladder of *Motella tricirrata*, the three-bearded rockling. An account is given of the spores, the vegetative forms, the schizogony, and the sporulation. In the sporulation a vegetative (plasmodial) nucleus is to be distinguished from a dozen (germinative) spore-nuclei. The author also gives a minute account of the spore of *Glugea marionis* from the gall-bladder of *Julis*.

* Arch. Zool. Expér., lvi. (1917) Notes et Revue, No. 4, pp. 95-9 (1 fig.).

† Arch. Zool. Expér., lvi. (1917) Notes et Revue, No. 5, pp. 113-28 (3 figs.).

‡ Arch. Zool. Expér., lvi. (1917) Notes et Revue, No. 4, pp. 88-94 (3 figs.).

§ Comptes Rendus, clxv. (1917) pp. 797-9.

|| Bull. Soc. Zool. France, xlii. (1917) pp. 99-107 (10 figs.).



BOTANY.

GENERAL,

Including the Anatomy and Physiology of Seed Plants.

Structure and Development.

Vegetative.

Wood of Deciduous Trees.*—P. Jaccard has studied the changes brought about in the wood of dorsal-ventral branches of deciduous trees, by subjecting the branches to alternative pressures, varying in duration, direction, and intensity. The anatomic characters of the wood were compared with those of the wood of normal branches, and the following results were obtained:—Under the influence of longitudinal tensions and compressions the wood of the upper and lower surfaces differed greatly in morphology and chemical composition. An analogous difference may also be brought about by other causes, such as geotropism, or by any force which creates a longitudinal tension or pressure. The difference is characterized by the formation of typical tension-fibres and compression-fibres. Such fibres are only formed in trees, and are never found in shrubs or woody annuals; they must not be regarded as specific in character, since they only occur in response to external mechanical pressure. It is not possible to ascribe to them the value of an acquired character which can be transmitted by heredity; neither have they any phylogenetic significance.

Reproductive.

Embryogeny of Phaseolus.†—M. M. Brown has studied the development of the embryo-sac and of the embryo in five varieties of *Phaseolus vulgaris*. The chief features of interest are as follows:—At an early stage in the growth of the ovule, a large hypodermal cell takes on the functions of a macropore-mother-cell, and when fully grown forms part of the third or fourth layer from the micropylar end of the nucellus; ultimately an axial row of three macropores is formed, the innermost of which forms the embryo-sac. All the nucellar tissue is absorbed except that at the base of the sac, where it undergoes some changes, but finally disappears. The polar nuclei approach each other at an early stage, and after remaining in contact for some time, finally fuse just below the egg. At the time of fertilization the three antipodal cells disappear, but the synergids form a conspicuous filiform apparatus. The pro-embryo is composed of three cells, of which the two basal ones

* Rev. Gén. Bot., xxix. (1917) pp. 225-43 (2 pls.).

† Bull. Torrey Bot. Club, xlv. (1917) pp. 535-44 (2 pls.).

form the suspensor and the terminal one the embryo proper. Dermatogen is cut off at the fourth division of the embryo; the suspensor consists of four rows of cells, the two basal rows of which are swollen and elongated. The primary endosperm nucleus divides before the egg; the subsequent divisions give rise to endosperm on each side of the egg and in the outer parts of the embryo-sac; these divisions may be simultaneous, or represent all stages in different parts of the sac. Endosperm forms near the embryo, but is soon absorbed.

Embryogeny of the Alismaceæ.*—R. Souèges publishes a short note upon the embryogeny of the Alismaceæ, dealing more especially with the development of the apex of the stem of *Sagittaria sagittæfolia*. The present work appears to show that the monocotyledonous condition cannot be derived from the dicotyledonous condition, for the cotyledon in the former originates in a different and much more extended pro-embryonic region than in the latter. In the monocotyledons the two upper cells of the tetrad give rise to the quadrants, and the eight cotyledonary octants; the two cotyledons of the second group arise solely from the four upper embryonic octants, which are identical with the four upper cotyledonary octants of the monocotyledons. The author regards these observations as supporting Worsdell's theory, that the organization of the apex of the embryo, by a phenomenon of acceleration, represents a very reduced image of the organization of the stem of the adult plant. In the dicotyledons the arrangement of the cotyledons around the embryonic axis recalls the general arrangement of the leaves around the stem. In the monocotyledons the mode of growth is monopodic and is seen in the embryo, where the main axis aborts, giving rise to a single terminal cotyledon, while a new axis develops laterally.

Ovule in Apocynaceæ and Asclepiadaceæ.†—L. Guignard publishes a short account of his studies of the development and structure of the ovule in the Apocynaceæ and the Asclepiadaceæ. After describing the work previously done and the indefinite results obtained in the examination of these two groups, the author gives an account of the ovule based upon the examination of twenty species. In the Apocynaceæ the number of ovules is variable and the development is not always identical. Each ovule arises as a hemispherical papilla which elongates more or less until it is cylindrical in form, the apex being conical and directed towards the top of the carpellary cavity. The primordial mother-cell of the embryo-sac or archesporium is formed just below the epidermis of the apex; subsequent development is variable. In the greater number of species the nucellus is represented by a minute protruberance, and since the tegument develops early and rapidly, the nucellus is frequently imperceptible. In some cases the archesporium is completely enveloped in an epidermal layer, which is quite distinct from the tegument, and the nucellus may be regarded as complete. In other cases the epidermis gradually disappears towards the base of the archesporium, and in others it is only represented by a few cells. Thus, in the Apocynaceæ the

* Comptes Rendus, clxv. (1917) pp. 1014-17.

† Comptes Rendus, clxv. (1917) pp. 981-87.

nucellus varies considerably and may exhibit all degrees of reduction; the archesporium, however, is more uniform, and consists of four cells, the lowest of which forms the embryo-sac. In the Asclepiadaceæ, the bicarpellary ovary has numerous ovules which exhibit remarkable uniformity of structure and development. The twelve genera studied all exhibit the same characters as has been observed in *Apocynum*. The nucellus is represented by the archesporium and rudimentary epidermis, but the latter disappears during the development of the tegument. Such peculiarities as are found in this group leave no reason to suppose that it does not follow the normal course of development in the Gamopetalæ. The reduction of the nucellus must be regarded as a condensation of development adapted to the rapid formation of the tegument of the ovule. This is a constant and interesting character of the Asclepiadaceæ, marking a very high degree of differentiation. The author will publish shortly a complete account of the investigations reviewed in this preliminary paper.

CRYPTOGAMS.

Pteridophyta.

(By A. GEPP, M.A. F.L.S.)

Stelar system of the Marattiaceæ.*—C. West, in giving the results of a comparative study of the structure and development of the stelar system in the Marattiaceæ, with special reference to the adult sporophyte of *Danæa*, discusses the question of the symmetry of the sporophyte in the Marattiaceæ. He states that: 1. A primitive radially symmetrical type of shoot is distinctly suggested. 2. The single apical cell of the stem of the young sporeling is later replaced by a group of equivalent initial cells or by a meristematic region. 3. A single large apical cell occurs at the apex of the primary and earliest adventitious roots. At the apex of the later adventitious roots of moderate size a group of about four equivalent initial cells is found, while the more robust roots generally possess a definite meristem consisting of a number of independent initial cells. In brief, the number of initial cells found at the apex of the Marattiacean roots is clearly related to the bulk, and not necessarily to the age of these roots. 4. The six genera which comprise the Marattiaceæ show remarkable uniformity in their morphological, anatomical, and histological characters, and constitute a very homogeneous and natural family, which probably occupies an isolated position amongst modern Vascular Cryptogams.

Equisetum debile.†—S. R. Kashyap publishes some notes on the endodermis and the prothallium of *Equisetum debile* Roxb. 1. The endodermis in this species is very unstable. At the nodes it surrounds each vascular bundle of the underground and of the aerial sterile shoot; but in the internodes of these shoots there is a transition from this con-

* Ann. Bot., xxxi. (1917) pp. 331-414 (2 pls. and figs.).

† Ann. Bot., xxxi. (1917) pp. 439-45 (figs.).

dition to a condition of two endodermal layers, one external and the other internal, round the ring of bundles as a whole. This transition is independent of the distance at which it occurs from the node. The two rings of endodermis fuse here and there, leaving islands of parenchymatous tissue in the interfascicular region. At the point of junction of the two layers a single cell may show radial bands on three or four of its walls or two bands on the same wall. 2. As to the prothallium, if the spores are sown thickly the prothallia remain small and show one growing point only and usually bear only one kind of sex-organ. If the spores germinate at a distance from each other, leaving enough space for the prothallia to develop fully, the latter become very large and develop a meristem all round on the circular margin, and produce archegonia first and antheridia later. It is possible to prolong the life of the prothallia beyond their normal span, by removing the embryo and protecting them from heat; quite possibly they could be kept growing for over a year.

Australian Ferns and Mosses.*—W. W. Watts publishes notes on cryptogamic matters. 1. He proposes and defines a new tribe of Polypodiaceæ—namely, *Dryopteridæ*—in order to avoid (a) the unscientific separation of *Phegopteris* from the vicinity of *Dryopteris*; (b) the inclusion of exindusiate ferns among the Aspidiaceæ; and (c) the growing cumbersome of the genus *Dryopteris* as defined in Christensen's "Index Filicum." This new tribe includes *Lastrea*, *Nephrodium*, *Phegopteris*, *Goniopteris* and *Meniscium*, all regarded as genera. Twenty-seven Australian species fall within the limits of the new title. 2. He describes and figures a new fern, *Athyrium humile*, from the Ellenborough River. 3. He publishes notes and records of the following ferns—*Hymenophyllum peltatum* (Poir) (the British *H. Wilsoni*); *H. rarum* R. Br.; *Dryopteris acuminata* (Lowe) and var. *cristata* (a new variety); *Platyzoma microphyllum*. 4. He also gives a description and figures of *Fissidens* (*Amblyothallia*) *humilis* Dixon & Watts, a new moss from Newcastle, New South Wales; and publishes notes and records of the following two mosses—*Leptostomum inclinans* R. Br. and *Hampeella pallens* (Lacoste) Fleischer, with the interesting synonymy and distribution of the latter.

Apogamy in Phegopteris and Osmunda.†—Elizabeth D. Wuist describes the production of apogamous embryos on prothallia of *Phegopteris polypodioides*, *Osmunda cinnamomea*, and *O. Claytoniana* in cultures on Prantl's and Knop's full solutions, and certain modifications of the Prantl's solution. The first cases of apogamy were observed about six months after the spores of *Phegopteris* were sowed on Prantl's solution from which ammonium nitrate had been omitted. Similar cases of apogamy were obtained on Knop's full solution in six months. The development and morphology of the embryos are described. Apogamous embryos of the two species of *Osmunda* were obtained on Prantl's full solution, and on the solution with ammonium nitrate and magnesium sulphate respectively omitted.

* Proc. Linn. Soc. New South Wales, xli. (1916) pp. 377-86 (1 pl.).

† Bot. Gaz., lxiv. (1917) pp. 435-7.

Notes on Hippochæte.*—O. A. Farwell, who prefers the name *Hippochæte* for the scouring-rush section of *Equisetum*, publishes notes on *Hippochæte lævigata* and *H. prealta*. The type of the former is *Equisetum lævigatum* A. Br., which has been misunderstood through Braun's error in regarding it as a perennial-stemmed species. But a careful analysis of the original description identifies the plant with the smooth annual stemmed species, *E. kansanum* Schaffner. In clearing away some errors with reference to *H. prealta* (Raf.) he finds a variety without a valid name, and proposes for it the varietal name *pseudohyemalis*.

Pellæa in North America.†—F. K. Butters publishes some notes on *Pellæa atropurpurea* (L.) Link and *P. glabella* Mett. ex Kuhn. From a careful study of herbarium specimens and living material he is able to show that the ranges of these two species barely overlap, *P. glabella* having a northern, and *P. atropurpurea* a southern range in North America. They are perfectly distinct species, as F. L. Pickett‡ has indicated. To the specific differences brought out by Pickett some further points are added by Butters in respect of the structure of the scales and the spores. There are two western varieties of *P. glabella*—one, var. *simplex*, a novelty which the author describes; and the other, var. *occidentalis* (E. Nelson), which has been confused with *P. Breweri* and *P. atropurpurea*. Finally, the author gives the distinctive characters and the range of *P. Breweri* Eaton.

American Fern Notes.§—O. A. Farwell, in publishing a series of notes on ferns, calls attention to Sir John Hill's "Family Herbal" (1755) and to his use of *Filix* (p. 171) in a generic sense, and gives a list of new combinations of North American species transferred from *Dryopteris* to *Filix*. The notes on Ophioglossaceæ include a number of new varietal combinations, and a new variety *Botrychium multifidum*, var. *dichotomum*, which is described and figured. *Lycopodium obscurum* L. is discussed, and a new variety (*hybridum*) is constituted, which represents *L. dendroideum* Willd. (non Michaux). *L. complanatum* and its varieties are discussed, and a key to the latter is provided.

Fern Prothallia.||—G. Klebs has made a study of the physiology of the developing fern prothallia. The first part deals with the influence of light and temperature upon development. Experiments were made principally with the spores of *Pteris longifolia*, and the results were as follows: 1. Light is, with few exceptions, necessary for the germination of the spores, and the resulting organism develops differently according to the intensity of the light. These are described in detail, with the corresponding degree of candle-power. 2. The primary rhizoid arises

* Amer. Fern Journ., vii. (1917) pp. 73-6.

† Amer. Fern Journ., vii. (1917) pp. 77-87.

‡ Amer. Fern Journ., iv. (1914) p. 97.

§ Eighteenth Annual Report, Michigan Acad. Sci., 1916, pp. 78-94.

|| Sitzungsber. Heidelberg Akad. Wiss. Math.-Naturw. Kl. B., 4 Abhandl. (1916) pp. 3-82 (figs.). See also Bot. Centralbl., cxxxiv. (1917) pp. 220-2.

with the earlier germination, its growth being accelerated by increasing intensity of light. Secondary rhizoids need higher intensity for their development, and their number increases with increase of light. 3. From a certain degree of light onwards, no further increase affects the development. 4. The duration of light of a certain intensity need not be long. Experiments were made with intermittent lighting, and the results are given. 5. Daylight has in the main the same result as electric light, though the relation between germination and formation of the prothallium on the one hand, and light intensity on the other, differs in daylight from that in electric light, the difference being due to different composition of the spectrum. Further experiments in the effect of light on the germinating filaments are described under varying conditions of culture; other fern species gave analogous results.

Ferns of Formosa.*—B. Hayata publishes descriptions of some new or rare mosses collected in Formosa. *Archangiopteris Somai* is described and figured, and is shown to be an interesting link between *Archangiopteris Henryi* and the old genus *Angiopteris*. Though eight species of *Alsophila* have been recorded from Formosa, three of them seem referable to *A. latebrosa* and two to the genus *Dryopteris*; thus leaving only *A. formosana*, *A. podophylla*, and *A. latebrosa* in the list; sterile specimens are difficult to distinguish. Ten species new to science are described in the paper, and a plate is devoted to the illustration of the characters of *Blechnum (Blechnidium) plagiogyriifrons*. The determination of the Formosan species of *Vittaria* is facilitated with the help of a key.

Bryophyta.

(By A. GEPP.)

Targionia hypophylla.†—S. R. Kashyap publishes a supplementary note on *Targionia hypophylla*. He has thoroughly re-examined the Mussooree material for which he proposed the varietal name *integerrima* in 1914, and finds that the two main differential characters, upon which he relied, are not sufficiently constant to maintain the variety. The peculiar male shoots described for the Indian plant have been shown by O'Keeffe to occur in British specimens; and the absence of tooth-like interlocking processes from the involucreal valves is but a variable condition.

Statistics of Moss Structure.‡—J. MacLeod raises the question whether it is possible to identify a species by means of numbers that represent the value of the specific characters. Having obtained satisfactory results with insects, he has applied the method to the genus *Mnium*, and limiting himself to a study of the leaves of the fertile stem of ten British species. The successive leaves of a given stem from the

* *Icones Plantarum Formosarum*. Taihoku: (1916) vi. pp. 154-63 (2 pls.).

† *New Phytologist*, xvi. (1917) pp. 228-9.

‡ *Journ. Linn. Soc.*, xlv. (1917) pp. 1-58 (9 figs.).

base upwards gradually increase in length to a maximum and then diminish gradually. MacLeod limits his work to that part of the stem which extends from the lowest leaf up to the longest one. This part of the stem (as the number of leaves is very variable) he divides into ten intervals, and measures the minimal, medium, and maximal value of each character in the leaves of each interval. The measurements of each given interval are thus made comparable with those of the same interval in all the stems and species. The description of a species according to the author's method consists of a number of tables giving the gradation of each character. For each species he has recorded in a series of tables the following characters:—Length, breadth, breadth at the base, number of cells and breadth of the cells at the place of greatest breadth, breadth of the border and number of cells of the border at the same place, number of teeth at the border and on the nerve, length of the nerve (reaching the summit or not), tooth at the summit of the leaf (present or absent), total number of leaves of the fertile stem. For purposes of identification he gives a series of tables showing the minimal and maximal values of each character of the leaves of the tenth interval (longest leaves), together with other characters. Usually four of these numerical characters suffice for the determination of a specimen, but twelve to fifteen characters are available if necessary.

Welsh Bryophyta.*—D. A. Jones gives an account of the mosses and hepatics of the south-west of Anglesey, where he has succeeded in finding several rare and interesting species. He describes the geology and physical geography of Newborough Sands, giving lists of the species which characterize the different soil-formations, and an enumeration of 181 species of mosses and 55 hepatics.

The same author † publishes an enumeration of the mosses and hepatics of Denbighshire, prefaced by an account of the geology and physical geography of the county, and of the moss-floras characteristic of the various rocks; and also of the injurious effects of the smoke of such industrial centres as Ruabon and Wrexham upon vegetation. The number of mosses recorded is 229, and of hepatics, 61.

Wiltshire Mosses.‡—C. P. Hurst gives an account of the mosses of East Wiltshire, collected mostly in Savernake Forest, and to the south-east of it. The moss-flora of the sarsen stones is interesting; these siliceous rocks are found on chalk downs at Marlborough and Aldbourne, and bear such interesting silicicolous species as *Grimmia trichophylla*, *G. subsquarrosa*, *Hedwigia ciliata*, *Orthotrichum rupestre*, *Ulotia Hutchinsiae*—the first and last of which would probably be found no nearer than on the granite rocks of Cornwall and South Wales; and it has been suggested that the spores have been carried thence by westerly winds. In Savernake Forest fruiting specimens occur of certain specimens which are usually sterile elsewhere. About 150 species are enumerated.

* Lancashire and Cheshire Naturalist, Aug. 1917, pp. 141-51.

† Naturalist, 1917, pp. 285-92, 321-7.

‡ Wilts. Archæolog. & Nat. Hist. Mag., xxxix. (1917) pp. 449-55.

Carbohydrates of Musci.*—T. G. Mason describes the methods of detecting the different sugars in the three mosses—*Polytrichum commune*, *Thuidium tamariscinum*, and *Sphagnum cymbifolium*, and the storage and translocation of carbohydrates in these plants. He found dextrose, levulose, and sucrose in all three species, and maltose in *Polytrichum* and *Sphagnum* wherever starch is present. Sucrose is the first sugar to appear after illumination; and the author is of opinion that sucrose is the first formed sugar in the chloroplast, and that in *Polytrichum commune* and *Sphagnum cymbifolium* it is in the form of hexoses that the sugars undergo translocation.

Water-conduction in Marchantiaceæ.†—R. Douin points out that the female capitulum and the male disc of the Marchantiaceæ present three methods of water-absorption more and more perfect in correspondence with the apparatus employed by the plant. In the first case, the water rises to the posterior cavity, and then spreads into the others by means of lateral fascicles (*Grimaldia*, etc.). In the second case, quite a special one (*Fegatella*), the capitulum is everywhere in contact with the cylindrical felt-work of absorbing hairs. In the third case (Marchantiaceæ with two-furrowed stalk), the water is distributed directly among the cavities.

Multicellular Spores in Mosses.‡—T. Herzog describes two new species of *Cryphæa*, *C. macrospora*, and *C. gracillima*, which are characterized by having very large and multicellular spores, a character hitherto confined to Dicnemonaceæ. The ripe spores measure 44–48 μ and 44–52 μ respectively. They are irregularly globular to shortly cylindrical, and provided with clearly developed longitudinal and transverse walls. Division does not take place until the spore has reached its full size. In *C. macrospora* division is fairly regular and takes place in quadrants; in *C. gracillima* division is more irregular and takes place in stages of four to eight cells. The tough exospore does not split finally as in Dicnemonaceæ, but remains preserved. The author considers the *Cryphæa* spores as an intermediate form between the usual spores and the highly specialized multicellular type of the Dicnemonaceæ, in which not only the division but also the germination of the giant spores begins inside the capsule. The author also discusses the spores of *Macromitrium macrosporum*, which measure as much as 70 μ , but are always unicellular; as well as the spores of his genus *Wernerobryum*, which is in various ways allied to the Dicnemonaceæ, and has spores 120 μ long and about 60 μ broad, but unicellular. A note states that Fleischer's *Sphærotheciella sphærocarpa*, which has abnormally large multicellular spores, was not known to the author when he wrote this paper.

* Notes Bot. School Trin. Coll. Dublin, ii. (1916) pp. 319–34. See also Bot. Centralbl., cxxxii. (1916) p. 541.

† Comptes Rendus, clvii. (1913) pp. 997–9. See also Bot. Centralbl., cxxxii. (1916) p. 567.

‡ Flóra, cix. (1916) pp. 97–9. See also Bot. Centralbl., cxxxiv. (1917) p. 87.

Lophozia Hatcheri and **L. Baueriana**.*—V. Schiffner discusses the two species of *Lophozia*, *L. Hatcheri* and *L. Baueriana*, which he has studied from original specimens, and decides that the species are not identical, notwithstanding their remarkable likeness. The two nearest habitats of the respective species are 11,000 kilom. apart and separated by the tropical zone. The extraordinary morphological resemblance may be explained in three ways:—1. Both are of common origin, the original ancestor having been distributed over an enormous area, but owing to geological and climatic changes it has died out in the intermediate regions. 2. Carriage of the spores or gemmæ, which is only possible in species of *Riccia* which inhabit water. 3. Convergence, which is probably the solution of the problem under consideration.

Thallophyta.

Algæ.

(By MRS. ETHEL S. GEPP.)

Biology of Algæ.—G. S. West publishes the first volume of a treatise on Algæ in which he gives a biological account of all the Algæ included in the Myxophyceæ, Peridinieæ, Bacillariæ and Chlorophyceæ, both fresh-water and marine. In a future volume it is proposed to give a complete systematic account, with illustrations, of all the British Fresh-water Algæ, with the exception of Desmids and Diatoms. In the present work the chief space is allotted to the Chlorophyceæ. These are arranged under four sections—Isokontæ, Akontæ, Stephanokontæ, Heterokontæ. Under Isokontæ are six orders:—*Protococcales*, including all the unicellular and colony-forming types; *Siphonales*; *Siphonocladiales*; *Urtales*; *Schizogoniales*; *Ulotrichales*. The Akontæ comprise the *Conjugatæ*: the Stephanokontæ, the *Eldogoniales*; and the Heterokontæ comprise the orders *Heterococcales*, *Heterotrichales*, and *Heterosiphonales*. A chapter is devoted to the occurrence and distribution of fresh-water Algæ, describing Sub-aërial Associations, Associations of Irrigated Rocks, and Aquatic Associations.

Structure and Mode of Life of *Hormidium flaccidum*. †—Alma Piercy gives a general account of the life of a form of *Hormidium flaccidum* A. Braun in its native habitat. The survival of the vegetative filaments throughout successive seasons of the year is described, and their modification during drought, chiefly in the accumulation of refractive granules, and in changes of the longitudinal walls and septa. A detailed description is given of the two common methods of reproduction, viz.: (1) transverse splitting of the filaments at the septa; and (2) production of aplanospores. Regarding (1), a general breaking up of the filaments into isolated cells or few-celled pieces has not been

* Oesterr. Bot. Zeitschr., lxvi. (1916) pp. 83-8 (figs. in text). See also Bot. Centralbl., cxxxiv. (1917) p. 187.

† Algæ. Cambridge University Press: (1916) i., x and 475 pp. (271 figs.).

‡ Ann. Bot., xxxi. (1917) pp. 513-37 (figs.).

observed; the splitting occurs at somewhat distant points in a filament, though in favourable circumstances a minor proportion of the filaments become divided into few-celled fragments. It is suggested that splitting is due to the effects of renewed turgor on desiccated filaments in which degeneration of the cuticle or a weakening, due to the development of mucilage between the two lamellæ of the septa, has taken place. (2) The production of aplanospores occurs in all seasons of the year, but is dependent on an ample supply of water. Cells that give rise to aplanospores usually contain an abundance of a special substance and also granules. A white refractive substance is described; it appears in the cells under certain conditions in the form of granules and rounded masses. It arises chiefly in the region of the polar vacuoles, but also sparsely distributed in the peripheral protoplasm. Two conditions favour its production, viz. drought, and a plentiful supply of carbohydrates, e.g. glucose. It appears to be associated with a second special substance (referred to above), and possibly is formed as a result of concentration of this substance. Since, in suitable circumstances, the cells are capable of eventually absorbing the granules, these evidently serve as a food-store. During the first weeks of a period of drought the death-rate decreases, while the abundance of granules increases to a maximum. When growing in its native habitat, this alga in all probability rarely passes beyond this first stage of desiccation, as the spells of dry weather in temperate regions are comparatively short, and dew is continually deposited, especially in summer when the drought is most extreme.

Staining of Minute Algæ.*—J. Ben Hill describes a satisfactory method of manipulating microscopic organisms in staining, to prevent the loss of such minute objects as *Sphaerella*, *Pandorina*, *Volvox*, *Pediastrum*, and the Desmidiæ. From the killing solution the material is transferred to a filter, and there washed with distilled water from a wash-bottle. It is then treated with 0.1 p.c. iron-alum solution, and washed as before: then stained cautiously with 0.1 p.c. aqueous hæmatoxylin, and thoroughly washed as before. The stain is carefully differentiated with 0.1 p.c. iron-alum solution; and once more a thorough washing with distilled water from the wash-bottle follows. Then the filter-paper is punctured, and the material is dehydrated in an open vessel with glycerin, followed by washing on a filter with 95 p.c. and absolute alcohol. The material is then quickly transferred to 10 p.c. Venetian turpentine for concentration and mounting.

Pleodorina illinoiensis.†—W. B. Grove publishes a supplementary note on *Pleodorina illinoiensis*, which he recorded as occurring in cart-ruts at Harborne, Warwickshire, in the spring of 1915. He found it in the same place in 1916 and 1917; but in April 1917 it was in larger quantity, and associated with equal quantities of *Pandorina Morum* and *Eudorina elegans*, and with other Algæ. And, though the elliptical

* Bot. Gaz., lxiii. (1917) pp. 410-12.

† New Phytologist, xvi. (1917) p. 180.

form and the posterior protuberances were as marked as ever, yet a greater number of stages transitional between it and *Eudorina* were found intermixed. And the author claims these as an entire justification of his suspicion that this *Pleodorina* is merely a well-marked mutation of *Eudorina*—on the way to becoming a species.

Spirogyra.*—S. S. Chien describes the peculiar effects of barium, strontium, and cerium on *Spirogyra*. He summarizes his results as follows:—1. The chloroplasts of certain species of *Spirogyra* contract away from the cell-wall in a peculiar and characteristic fashion in solutions of CeCl_3 , BaCl_2 , and SrCl_2 (in the case of the smaller kind in the last two only). The effect is observed in dilutions as great as 0·00005 M of CeCl_3 (in the case of the larger species), and in 0·0001 M of BaCl_2 . SrCl_2 also produces this effect, but not at such great dilutions as CeCl_3 and BaCl_2 . 2. In the smaller species of *Spirogyra* the effect of BaCl_2 is inhibited when BaCl_2 is mixed with CeCl_3 or CeCl_2 in proper proportions.

Starch-formation in Zygnema.†—Helen Bourquin has studied the subject of starch-formation in algae, and has chosen *Zygnema* for investigating the process, on account of the large size and the typical nature of its chromatophore. She gives a résumé of previous work on the subject, describes her own material and methods, and then gives an account of her work, which she summarizes as follows:—The chromatophore of *Zygnema* is a plastid containing embedded in its substance a pyrenoid which lies near the middle, and starch-grains which usually lie radially about the pyrenoid. The pyrenoid cannot take part in starch-formation because it is always confined to the centre of the plastid and is separated from the starch by the plastid, and because the small young grains of starch are always found in the periphery of the plastid. The plastid, therefore, must form these minute starch-grains. The starch-grains come to lie radially about the pyrenoid in the following manner:—The plastid adds to them in such a way that they become cuneate in shape. In this manner they grow down between the starch-grains already formed until they are of the same length as the large grains. The plastid then broadens them at the base until they become rectangular in shape.

Dichotomosiphon tuberosus.‡—A. de Puymaly writes on *Dichotomosiphon tuberosus*, which he has studied from living material collected by him near Bagnères-de-Bigorre, at a height of about 600 metres. It was growing in a small basin, 10 by 20 metres, in which the water was continually being renewed and was tepid to the touch, being 20° C. The alga was growing so luxuriantly that it almost covered the bottom of the basin, which was 1 to 2 metres deep. The plant evidently requires warmth, in which it resembles its near allies, the Udotea group. In contrast to *Vaucheria*, the filaments of *D. tuberosus* are upright and

* Bot. Gaz., lxiii. (1917) pp. 405-9 (figs. in text).

† Bot. Gaz., lxiv. (1917) pp. 426-34 (1 pl.).

‡ Bull. Soc. Bot. Genève, 1917, pp. 120-5.

bushy, 5 to 10 cm. high, and disposed fairly regularly; they often form small loose bundles, resembling locks of hair. These upright filaments emerge from a creeping substratum which grows on the slime, and is composed of entangled rhizomatoid filaments. It is at the expense of the creeping part that the tubercles are developed which play so great a part in the multiplication of the plant. The rhizomatoid filaments produce here and there irregular swellings provided with papillae, some of which develop into new green shoots and others into rhizomatoid filaments. These latter are capable of producing in their turn new swellings, and so on. Thus the plant is able to spread over large surfaces, and the thallus of separate plants becomes intermixed. The author found plants bearing the sexual organs which have seldom been observed, and only once previously in Europe, under natural conditions. They are sufficiently rare when they do occur, and a search of several square decimetres barely produced ten, while the same material furnished easily more than a hundred tubercles. The oospores apparently remain inside the oogonia, and the latter adhere for several months to the individuals which produce them. It is evident that multiplication by means of the tubercles and the rhizomatoid filaments is very much more usual than sexual reproduction, and is possibly in course of taking its place. In *D. pusillus*, described by Collins, sexual organs have not been found. As regards the structure of the cells, the author finds that Mirande alone of previous writers is correct in his conclusions. The membrane is constituted like that of the Udoetea, and consists of a callus associated with pectic components. The author proposes in a further work to discuss the germination of the oospores.

Nuclear Division in Characeæ.*—F. Oehlkers discusses nuclear division in Characeæ. The number of chromosomes in *C. fragilis* is twenty-four, in *C. fetida* sixteen, and in *Nitella syncarpa* twelve. At the germination of the zygote of *C. fetida*, the zygote nucleus divides into two daughter-nuclei, which then undergo further division. Of the three transverse walls, two are dissolved, while the third, which separates off the fourth nucleus in a protoplasmic cup, remains. Only this last nucleus survives, while the other three gradually go to pieces. This fourth nucleus divides into two by a wall parallel to the longitudinal axis of the zygote. Through further divisions of these two cells, two knobs are formed above the first transverse wall, and these are the point of issue of the new *Chara* plant. The number of the chromosomes in the second division was sixteen, the same as that of the vegetative division. Reduction-division takes place, therefore, at the actual germination of the zygote.

Alternation of Generations in Florideæ.†—N. Svedelius discusses the problem of the alternation of generations in Florideæ. The significance of the reductions-division does not lie entirely in the restoration

* Ber. Deutsch. Bot. Gesell., xxxiv. (1916) pp. 223-7. See also Bot. Centralbl. cxxxiv. (1917) p. 279.

† Naturw. Wochenschr., n.f. xv. (1916) pp. 353-9, 372-9. See also Bot. Centralbl., cxxxiv. (1917) pp. 314-5.

of the number of chromosomes, but also in that it brings about new combinations of chromosomes in the daughter-nuclei, which in the somatic equal division cannot take place. The reductions-division plays as important a part in the new combination of chromosomes in the nucleus as fertilization itself, and may be regarded as its final act. By the reductions-division there is formed as great a possibility for new combinations of chromosomes inside the nucleus, as by the fertilization itself a possibility is given of new combinations of nuclei, and thereby of the number of chromosomes. In Florideæ, which are treated in special detail by the author, reductions-division takes place in the tetraspore formation. Here the life of the diploid generation divides into two different phases: the first, the gonimoblast phase in the cystocarp, in intimate connexion with the gametophyte, as in the moss-sporogonium; the second, the tetraspore-forming phase, which takes its origin from the germinating carpospore and arises here as an independent form of life, entirely resembling externally the gametophyte. Florideæ, on the other hand, which do not produce tetraspores have a reductions-division which follows immediately on fertilization; and the monospores which are produced by this type are purely germinating cells, and are not an integral part of the alternation of generations. These two types of reduction show also this difference—in the latter type only one sort of individual is produced, namely monœcious or diœcious sexual individuals with or without monospores; while the former type produces two sorts of individuals, sexual (monœcious or diœcious) and asexual (tetrasporic). The former type is called by the author the *haplobiontic*, the latter the *diplobiontic*. He regards the haplobiontic as the original, from which the diplobiontic has sprung, by the delay for some reason of the reductions-division.

Oceanic Algology.*—A. Mazza continues his description of types of oceanic algae. Completing his account of the non-articulate Corallineæ by a description of the structure of *Mastophora*, he passes on to a consideration of the articulate Corallineæ, describing *Amphiroa* and five of its species, together with four varieties of *A. tuberculosa*, also *Metagoniolithon* with three of its species.

Algæ of Bermuda.†—F. S. Collins and A. B. Hervey publish a Flora of the Algæ of Bermuda, omitting the families Rhizophyllidaceæ, Squamariaceæ and Corallinaceæ. In the introduction they discuss the geological formation of the small group of islands, refer to previous published work on the algæ, and give a comparison of the flora with that of nine of the best known regions where a similarity might be expected. This is drawn up in tabular form, but is not intended to be in any way exhaustive, owing to the impossibility of producing a complete comparison at this time of world-wide chaos. A list of important stations is then given, with an indication of the characters of each, for the use of future collectors. Concise keys have been drawn up for all the species in a genus, and a number of new species are described and figured. In

* La Nuova Notarisia, xxix. (1918) pp. 1-34.

† Proc. Amer. Acad. Arts and Sci., liii. No. 1 (1917) 195 pp. (6 pls.).

the case of other species, details additional to previous knowledge have been added where possible, but no full descriptions. Full notes are given as to character of station, with exact localities. Full synonymy is omitted, but reference is made where possible to a good figure, and to *exsiccata*.

Algal Associations of San Juan Island.*—W. L. C. Muenscher publishes a study of the Algal Associations of San Juan Island. He describes them carefully with the aid of maps and a vertical section of the coast, and concludes that the rocky shores of the island possess a very dense algal flora, whilst the sandy beaches and bays are almost free from algæ. From the high-tide line to the *Nereocystis* beds he distinguishes five distinct associations:—(1) *Endocladia*, (2) *Fucus*, (3) *Ulva*, (4) *Laminaria*, (5) *Zostera*. The number of species common to each increases in the lower associations, and the algæ are larger. The different groups of algæ are not restricted to any definite associations.

Puget Sound Algæ.†—Puget Sound Marine Station issues a fascicle of papers on marine algological work done in Friday Harbour, Washington, in 1916.

Miss Hurd finds that young *Nereocystis* plants can accommodate themselves gradually to 55 p.c. of fresh water. The rapid elongation of the stalk of this species she states to be due to the low intensity of light in deep water, the growth of the stipes being greatly retarded by strong light near the surface of the water; and there is no relation between rate of growth and mechanical stretching in the stalk.

In another paper she shows that the *Codium adhærens* Ag. of San Juan Islands and Puget Sound is *C. dimorphum* Sved., since it has no utricle hairs and has two types of utricles, the one with unmodified end-wall, and the other with thickened, striated end-wall. She believes the different end-walls to be due to environment: the thick-walled type sometimes predominates over the whole thallus, sometimes only around the margin and beneath the lobes, and sometimes is wanting entirely.

W. L. C. Muenscher enumerates the marine algæ of Shaw Island, giving their zonal distribution and relative abundance, and discussing the ecological factors involved.

Miss Kibbe investigated the parasitic fungus (*Chytridium alarium*, a new species) that infests *Alaria fistulosa* in Alaska, but apparently does not attack any other brown alga.

Miss Karrer throws some light on the metabolism of *Nereocystis* by means of microchemical reactions. The cell-walls are composed of cellulose and algin. Inorganic substances (Ca, Mg, Na, K, Cl, sulphates, carbonates, phosphates, iodine) can be demonstrated in the cell by the methods of Tummann and Molisch.

Miss Clark, by methods of titration, found all the thirty-one marine algæ that she tested to be acid.

* Puget Sound Marine Station Publications, i. (1915) pp. 59-84. See also Bot. Centralbl., cxxxiv. (1917) pp. 195-6.

† Puget Sound Marine Station Publications, i. Nos. 17-24 (1916) pp. 185-243 (pls.) See also Bot. Gaz., lxiii. (1917) pp. 415-17.

Langdon made the important discovery that carbon monoxide is present in the bladder of *Nereocystis*, in varying quantities; but carbon dioxide is rarely present, and in minute quantity. This carbon monoxide, as the anhydride of formic acid, may well have a bearing on the theories of photosynthesis, and may occur more generally in plant tissues than has been supposed.

Marine Algæ of the Danish West Indies.*—Under this title F. Börgesen continues the work begun some time ago before the sale of the islands, which he feels very grievously. The last pages of Squamariaceæ are followed by the treatment of Melobesiaceæ by Madame Paul Lemoine. After an introduction, in which she discusses the distribution and affinities of the species collected by Börgesen, she gives a key of the genera and species which amounts to a synopsis. This is followed by a full description of each species, with many text figures. The treatment of the Corallineæ is continued by Börgesen, who then begins Ceramiales, which is carried into the sixth sub-family, Spyridiaceæ. The work is interspersed with numerous drawings of the structure of the species described.

Japanese Marine Algæ.†—K. Yendo publishes Part VII. of his Notes on Algæ new to Japan. He records twenty-five species, adding important and enlightening notes to each on synonymy, geographical distribution, and structure. *Bryopsis corticulans* Setch. is reduced to a form of *B. plumosa*, as foreshadowed by Setchell in his original description, the rhizoidal cortication in the genus being possibly indicative more of a state of robustness of an individual plant than of a specific character. *Chætomorpha antennina* Kütz. is now truly recorded from Japan, the original record by Martens having proved to be erroneous. It occurs on the Bonin Islands. *Boodleia siamensis* also occurs there, and makes the third out of five known species to be recorded from Japan. Under *Sargassum Sandei* the author discusses the duplicated or turbinarioid leaf found in that species, and in *S. duplicatum* and others, and so closely resembling the turbinarioid form in the genus *Turbinaria* as to suggest a link between the genera. The result of a study of *S. Sandei* shows that the degree of duplication in that species (1) is gradual in a range of species; (2) differs according to the stages of development of the thallus; (3) varies according to the parts of the thallus; (4) differs according to the sex of the plant. Male plants have, as a rule, luxuriant foliage, and poorly, or not at all, duplicated leaves. *Gracilaria lingua*, only recorded in a few specimens from the Arabian Sea and from Amoy and now from the Bonin Islands, may possibly represent a state of *G. corticata*, a variable species.

* Marine Algæ of the Danish West Indies. III. Rhodophyceæ. Copenhagen: (1917) pp. 145-240 (figs. 149-230).

† Bot. Mag. Tokyo, xxxi. (1917) pp. 183-207 (figs.).

Fungi.

(By A. LORRAIN SMITH, F.L.S.)

New Phycomycete.*—H. A. Edison describes a new genus and species, *Rheosporangium aphanidermatus*, which causes damping off of seedlings of sugar-beet and of radishes, to which he referred in a previous paper as an undescribed member of the Saprolegniaceæ. The new fungus resembles *Pythium Debaryanum* except in the asexual fruiting stage. The mycelium is aerial or aquatic; reproduction is by zoospores under aquatic conditions and by oospores. From the hyphæ is cast off a terminal swollen portion termed the prezoosporangium, which ruptures and allows the escape of the contents: this body becomes surrounded by a delicate wall, and by cleavage forms zoospores.

Rhizophidium acuforme.†—This minute Phycomycete was found by W. B. Grove on cells of *Chlamydomonas intermedia* in a cart-rut. He describes the growth and development of the parasite, the bursting of the sporangia, and the reinfection of the algæ by the zoospores. No resting spores were seen.

Entomophthora americana.‡—Hugh Main reports this species, new to Britain, from Epping Forest. It was collected in August, 1916, on the trunk of a horubeam, about three feet from the ground. It consisted of a mass of white hyphæ growing from the body of a large fly which has been identified by K. G. Blair as *Hytodesia erratica*. J. Ramsbottom examined the fungus and found it identical with the above species of *Entomophthora*.

Peronosporaceæ.§—I. E. Melhus comments on the reported perennial condition of *Phytophthora infestans* in the Irish potato, and he points out that perennial species have been determined belonging to four genera, the mycelium passing the winter either in the aerial or the underground organs of winter annuals, biennials, or perennials.

In a further paper Melhus|| describes his culture experiments with *Phytophthora infestans*, and he claims to have proved that the mycelium persists in the tube, and from it passes into the shoots. The planting of diseased tubers may thus give rise to an epidemic. He found no evidence that conidia in the soil gave rise to new infections.

Discharge of Spores of Leptosphæria acuta.¶—W. J. Hodgetts has followed the process of spore discharge by mounting ripe perithecia in water and withdrawing the hymenium. The outer wall of the ascus is burst by the spores still enclosed in the inner gelatinous wall, which

* Journ. Agric. Research, iv. (1915) pp. 279-91 (4 pls.).

† New Phytologist, xvi. (1917) pp. 177-80 (1 fig.).

‡ Essex Naturalist, xviii. (1917) pp. 107-8 (1 fig.).

§ Journ. Agric. Research, v. (1916) pp. 59-69 (1 pl. and 1 fig.).

|| Journ. Agric. Research, v. (1916) pp. 71-102 (5 pls.).

¶ New Phytologist, xvi. (1917) pp. 139-46 (14 figs.).

issue explosively, and are then carried away by rain or dew. The writer describes the changes that take place in the ascus, and compares spore discharge in this fungus with others.

Spegazzinian *Meliola* Types.*—F. L. Stevens has received a number of packages containing Spegazzini's types, descriptions and drawings of *Meliola*. He has had the drawings carefully copied and compared with the type material, and he now publishes them, with references to the original publication. There is a long list of these species. Stevens values very highly the work Spegazzini has done, and desires to emphasize the great indebtedness of mycology to his careful work.

Infection by *Cercospora beticola*.†—V. W. Pool and M. B. McKay have made a study of the leaf infection by this fungus with reference to penetration by the germ-tubes of the stomatal opening. For this purpose they have made a prolonged study of the beet stomata, and have stated the various conditions influencing stomatal movements, and therefore infection. Penetration occurs only through open stomata, and most frequently on mature leaves. Infection probably takes place during the day-hours. The fungus forms a dense mycelium in the air-chamber below the stoma; it then grows towards the parenchyma cells and flattens out against their walls. It may immediately grow out again by the pore and form conidia, but usually it penetrates deeper. The host-cells may mass material and remain turgid, thus isolating the invading parasite, but usually they collapse and allow its further growth.

***Septoria Chenopodii*.‡**—W. B. Grove publishes an account of the synonymy of this fungus, which is large and varied. The differences in view have arisen primarily from the spore conditions. They are for a long time simple, in which condition the fungus has been naturally classified under *Phyllosticta*. In time the spores become one or more septate, and have been placed in other genera. The species was found in this country by M. C. Cooke at Holloway. It has since been found on *Chenopodium* and on *Atriplex* at various other localities. Grove adds a variety *emaculata* when it occurs on stems without any distinct "spots" being formed.

Factors involved in the Growth of Pycnidia.§—G. H. Coons has made a large series of cultures of the fungus *Plenodomus fuscomaculans* to determine the conditions that favour pycnidial formation or the reverse. He employed a great variety of media, chemical and others, and took note of temperature and light conditions. The different results obtained in the various foods supplied were due to their acid or alkaline nature. Aeration is essential for reproduction. Pycnidia were only found in cultures exposed to light; the ordinary room temperatures were sufficient.

* Bot. Gaz., lxiv. (1917) pp. 421-5 (3 pls.).

† Journ. Agric. Research, v. (1916) pp. 1011-38 (2 pls.).

‡ Journ. Bot., lv. (1917) pp. 346-8.

§ Journ. Agric. Research, v. (1916) pp. 713-69.

Notes on Coniothecium.*—P. van der Bijk has had occasion to examine *Coniothecium chomatosporum* as an apple-blister and apple-cracking disease. He now gives the results of cultural studies of the species. He describes the type of mycelial growth from the spores. He produced in the cultures pycnidia of *Phoma Mali*, and has demonstrated, as others had done, that *Coniothecium* is a form genus. Whether all species of *Coniothecium* are related to *Phoma* remains to be proved. It is the *Coniothecium* stage that causes the disease on apple. The author describes the growth of the mycelium, noting the peculiar formation of buds on the mycelium.

Uredineæ.†—W. H. Long records the finding of *Peridermium pyriforme* (the æcidial stage of *Cronartium pyriforme*) on *Pinus rigida*. The fungus causes three forms of disease on pines—one with slight or no hypertrophy on *P. divaricata*, *P. pungens*, and *P. ponderosa* var. *scopulorum*; a second forming a fusiform swelling; and a third causing spheroid galls, the latter very like those caused by *Peridermium cerebrum*.

A serious disease of the seedlings of *Pinus ponderosa* was traced by J. R. Weir‡ to the fungus *Peridermium filamentosum*. The æcidio-spores taken from the *Pinus* were sown on *Custilleja micicata*, and produced the *Cronartium* stage. Advice is given as to dealing with the disease.

H. S. Jackson§ signals the establishment of a species of *Rastelia* on a Japanese pear-tree in Oregon. The tree (*Pyrus sinensis*) grew in the yard of a Japanese family. It was found to be the same as *Rastelia koreanis*; the *Gymnosporangium* stage was cultivated on *Juniperus chinensis*.

Studies in the Physiology of Parasitism.¶—W. Brown summarizes his paper (No. 4), and the results are as follows:—1. Two types of enzymic preparations derivable from cultures of *Botrytis cinerea* are: (a) watery extracts of the ground mycelium, and (b) the media in which germination and growth have taken place. 2. The amounts of (a) enzyme and (b) enzyme-retarding substances in the media depend on the density of sowing, age of culture, and nature of medium. An account of these is given. 3. A discussion is given of the bearing of these results on the technique of enzyme extraction, on the one hand, and on the process of enzyme extraction by fungi, on the other.

Morphological Variations of Fungi due to Environment.¶¶—Elisa Muta and Gino Pollacci find in the study of *Coniothyrium tirolense* that a change in culture media influences the dimensions and shades of colour of the conidia. In *Phyllosticta pirina* a change of medium brought

* Agric. Journ. Sci., xvi. (1916) pp. 649-57 (6 pls. and 2 figs.).

† Journ. Agric. Research, v. (1915) pp. 289-90 (1 pl.).

‡ Journ. Agric. Research, v. (1916) pp. 781-5.

§ Journ. Agric. Research, v. (1916) pp. 1003-9 (2 pls.).

¶ Ann. Bot., xxxi. (1917) pp. 489-98.

¶¶ Bull. R. Accad. Lincei Rome, xxvi. (1917) p. 498-502. See also Bull. Agric. Intell. Rome, viii. (1917) p. 1319.

about a delicate septation of the spores, and in the same medium (lemon-juice neutralized by caustic soda with gelatin) the septa persisted in new generations: they disappeared when the nutritive medium was changed. They found in the culture, club-shaped muriform bodies formed which they have termed "macrosporioide," from their resemblance to *Macrosporium* or *Alternaria* spores. These have also been observed in cultures of *Phoma Richardiæ*.

Studies of the Schweinitz Collection of Fungi.*—C. L. Shear and N. E. Stevens publish a second contribution on this subject. Schweinitz's herbarium passed to the Academy of Natural Sciences, Philadelphia, at his death in 1834. Since that date various fungologists have worked at the collections, and the writers of the paper here give an account of these men and the results of their labours. They also trace the Schweinitz specimens that were sent to other workers. These are to be found at Berlin, Kew, Paris, and Upsala. A bibliography of papers referring to Schweinitz is appended.

Mycological Notes.†—Three sets of these notes have been issued recently by C. G. Lloyd, each prefaced by information concerning some active fungologist, with a photograph. The first indicates the branch of fungological work undertaken by J. Barton Cleland, an Australian botanist. In the pages following, the genus *Cytharia* is discussed, a small but peculiar genus of Ascomycetes, found so far only in South America and Australasia. Notes are also given on some peculiar *Xylariæ* and on some Basidiomycetes from South America or from Australia.

In the second pamphlet there is a sketch of Spegazzini and his work on the fungi of South America, and an account of various little-known genera and species from Australia, Africa, Japan, etc.

The third series gives a photograph and some few details as to the life and activity of Karsten, who died recently. He collected over practically the same region as Fries. This series of notes deals mainly with South African and Australian fungi, and includes the description of a new genus, *Pyrenopolyporis*, a Pyrenomycete that simulates a Polypore.

New or Noteworthy Fungi.‡—John Dearnness gives a descriptive list of fifty microfungi from various regions of North-West America. A considerable number are new to science. The list includes both parasites and saprophytes.

A further contribution of new Japanese microfungi is published by T. Tanaka.§ He describes four species, *Massaria moricola*, *M. japonica*, *Mycosphærella Horii*, *Phyllosticta citricola*, all of which grow on living material and cause more or less of disease.

Natal Fungi.¶—Averil Maud Bottomley has revised and issued a list of the fungi collected by J. Medley Wood. The specimens, amounting

* *Mycologia*, ix. (1917) pp. 333-44.

† Cincinnati, Ohio, 1917, Notes No. 48-50, pp. 670-716 (83 figs.).

‡ *Mycologia*, ix. (1917) pp. 345-64.

§ *Mycologia*, ix. (1917) pp. 365-8.

¶ *South African Journ. Sci.*, xiii. (1917) pp. 424-6.

to some 550, have been incorporated with the Mycological Herbarium, Pretoria. The various families and genera are well represented, from the Myxomycetes, with six species, down to the Hyphomycetes, with four different genera. The author mentions as of particular interest a species of *Rodwaya* and *Woodiella*; the latter, named after the collector, is a member of the Patellariaceæ.

Notes on Uganda Fungi.*—T. D. Maitland and E. M. Wakefield publish a long list of fungi, mainly collected by the former during two years spent in the forests of Uganda. There are, in the introduction, copious notes and observations on the ecological features of the forest lands, in which the rainfall is greater and the humidity higher than in the surrounding country. The larger species are mainly saprophytes, belonging to the more woody Agaricaceæ or to the Polyporaceæ, etc. A large number of microfungi are included in the list.

Nigerian Fungi. III.†—The present contribution by E. M. Wakefield is based on collections by C. O. Farquharson in South Nigeria during the period 1914–16. Several species are new to science. One species, *Ustilina zonata*, on diseased *Hevea brasiliensis*, has been described as a rubber disease in the Malay States. A long account is given of *Monilia carbonaria*, which appears very quickly on charred wood; no ascigerous form has been identified with certainty, but a note is appended describing *Melanospora erythræa*, which developed in a culture of *Oospora gilva*, which latter fungus may be the same as *Monilia carbonaria*.

Irish Fungi.‡—R. Lloyd Praeger records the collection of several aquatic fungi: *Fibrisea truncorum* in three feet of water at Lake Brandon, and in one foot of water at Lough Dan, Wicklow, and elsewhere. *Mitrella phalloides* grew on dead heather in several inches of water near Hare's Gap, Mourne Mountains.

The same writer also gives an account of a number of species of *Clavaria*, and other unusual fungi collected in Co. Leitrim. One of them, *Otidea grandis*, was the first record for Ireland.

Rubber Disease.§—A. Sharples writes on bark canker in *Hevea brasiliensis*, very largely due to *Phytophthora Faberi*. He describes the results of several workers on canker disease, and quotes the opinion of Dastur, that there are two species of *Phytophthora* causing bark-disease, one identical with the pod-disease of Cacao, the other causing "Black-thread Disease."

In a second article he discusses the special significance of these diseases for Malayan rubber. He thinks that there is serious danger of bark-diseases spreading there. Fungus diseases are most dangerous when there are large acreages under one crop, and the whole of the Malay peninsula is planted with rubber-trees.

* Kew Bull., No. 1 (1917) pp. 1-19.

† Kew Bull., No. 3 (1917) pp. 105-11.

‡ Irish Naturalist, xxvi. (1917) pp. 55-6.

§ Kew Bull., No. 6 (1917) pp. 211-5 and 225-9.

Pathogenic Fungus.*—H. Windsor Wade has studied in Manila a new type of fungus, causing a peculiar chronic skin infection. Cultures were made, and in time the mycelial form of the fungus was obtained. Various growth-phases were observed that are not generally recognized as occurring among fungi, but it is believed that under certain conditions fungi might revert to these forms—gelatinous and vesicular-body formations, etc. The classification and name of the new fungus are left in abeyance to await the results of further study.

Tuber-rots caused by *Fusarium*.†—C. W. Carpenter has devoted much attention to this subject, with regard to the rotting of potatoes. He describes his method of testing parasitism, and gives a general account of the various strains, with descriptions of the different species. In his summary he notes a new species, *Fusarium eumartii*, which causes stem-end and wound-invading dry-rot, a wide-spread disease in Pennsylvania. It is similar in action to *F. radicicola*. The latter, associated with *F. oxysporum*, gives rise to jelly-end rot, "a serious trouble in the tule lands of California." *F. oxysporum* and *F. hyperoxysporum* may entirely destroy potato-tubers.

Immunity from Parasitic Fungi.‡—E. C. Stakman, following in the lines of previous workers, has made a study of infection by *Puccinia graminis*. He found that the host-plant in many instances is hypersensitive to the fungus, the cells being killed by the invasion, and the further progress of the true parasite being prevented. He carried out a large series of inoculations of *P. graminis* from one host to another, from oats to rye, oats to barley, etc. In almost every case the parasite succumbed. He found that the germ-tubes gained entrance, but that the cells very soon became disintegrated, their death promptly following the invasion by the hyphae. The death of the hyphae themselves follows sooner or later, probably from lack of the nourishment required by the parasite, or from some definite antagonism between the host and the parasite which requires further explanation.

Plant Diseases.§—A report on wart-disease of potatoes as regards the immunity of certain varieties is now published. The immunity trials were carried on at Ormskirk during the years 1915–1917. It had been already proved that any fungicide, such as lime, sulphur, formalin, etc., to be of service had to be employed in such strength that the potato-plants themselves were killed. Immunity is an inherent quality of the variety, and is not affected by outward conditions, and it has been proved that such variety retains its immunity an indefinite number of years. Reports have been received to the contrary, but investigation has always shown that the diseased plants were "rogues" of susceptible varieties present amongst the crop. A detailed account is given of various plantings, and the results are carefully tabulated, so

* Philippine Journ. Sci., xi. (1916) pp. 267–83 (5 pls.).

† Journ. Agric. Research, v. (1915) pp. 183–209 (4 col. and 6 photo. pls.).

‡ Journ. Agric. Research, iv. (1915) pp. 193–9.

§ Journ. Board Agric., xxiv. (1917) pp. 801–18.

that the grower may choose without difficulty the variety that is adapted to special soils as well as being immune. The article is also issued as a Food Production Leaflet, No. 21, by the Board of Agriculture.

An account of phloem necrosis has been published by H. H. Quanjer,* assisted by Van der Lek and O. Botjes. Potato-plants which were affected showed the disease in the curling of the leaves; the phloem was found to be abnormal, the cell-walls being swollen and discoloured, the injury being most marked in the older portions of the tissue near the bast-fibres. The trouble could be traced from the leaf-midrib to the underground parts of the stem near the seed-tuber. No specific organism has been detected as the origin of the necrosis.

A paper by Van der Lek † gives the results of his investigations on *Rhizoctonia violacea*, a fungal disease of beet-root, carrot, etc. He has proved by culture experiments that it is not identical with *R. Solani*. In the cultures on artificial media a fine mycelium was produced, which in time became purple; minute sclerotia were found, but no definite reproductive bodies were observed.

A. Cendner ‡ describes an attack on *Mathiola ralesiaca* by *Sclerotinia*. The effect of the fungus was to wither the inflorescences, the petals changing from the normal violet colour to red, as if they had been acted upon by an acid. Other Crucifers in the neighbourhood were similarly affected. The disease was traced to a species of *Sclerotinia* not hitherto described; small black sclerotia were detected within the stems.

A. Osterwalder § describes the fungus causing a disease of Raspberry in Switzerland. It is due to an Ascomycete, *Didymella appianata*, which attacks the young stems and branches, and is easily recognized by the reddish-brown or purple patches of the diseased areas.

V. B. Stewart || describes a leaf-disease of *Kerria japonica*, due to a species of *Cylindrosporium*. He describes the development of the fungus, with its effect on the leaf, in which it forms a mass of tissue or stroma. The leaves turn yellow and fall prematurely; there is no shot-hole effect; the twigs which are also affected become black. In the autumn the stroma increases, and early in the spring the perfect fruiting-form develops. Stewart has determined that it is an Ascomycete, belonging to the Phacidiales, *Coccomyces Kerriæ* sp. n. He also found on the leaf small pycnidia-like spermogonia with minute spermatia.

L. M. Massey ¶ describes a crown-canker disease of rose that has caused great damage in the United States to plants grown under glass. Lesions are formed just at the surface of the soil, and may extend several inches up the stem. Massey has determined the fungus as *Cylindrocladium scoparium*, only known hitherto as a saprophytic Hyphomycete. Cultures

* Meded. Nijks Hoog. Land-Luin-Bosch-bouwsch., x. (1916) 138 pp. (12 pls.). (Dutch, with English translation.)

† Meded. Nijks Hoog. Land-Luin-Bosch-bouwsch., xii. (1917) 112 pp. (9 pls.). (French translation.)

‡ Bull. Soc. Bot. Genève, ser. 2, ix. (1917) pp. 21-9 (3 figs.). See also Bull. Agric. Intell. Rome, viii. (1917) p. 1198.

§ Schweiz. Obst.-Gartenbau-Zeit., No. 12 (1917) pp. 175-7 (1 fig.). See also Bull. Agric. Intell. Rome, viii. (1917) p. 1199.

|| Phytopathology, vii. (1917) pp. 399-405 (7 figs.).

¶ Phytopathology, vii. (1917) pp. 408-17 (3 figs.).

and inoculation experiments were successfully carried out. The writer finds that the fungus is "low in parasitism, and that conditions of moisture are important factors in its development."

A. H. Gilbert and C. W. Bennet* have made a descriptive and cultural study of *Sclerotinia Trifoliorum*, the cause of stem-disease in Clovers; it causes the wilting of the leaves and the final destruction of the clover crop. Sclerotia are formed in spring and germinate in autumn, to form apothecia. The ascospores from this form hyphæ, which live in the soil and attack the clover-plants in spring. Rotation of crops is the cure most frequently recommended. Deep ploughing and liming of the soil have also had good results. It is not yet known whether, or how long, the mycelium can live in the soil on other plants than alfalfa.

B. Peyronel† records the presence of *Spondylocladium atrovirens*, a Hyphomycete parasite on potato-tubers in Italy. It is of very widespread occurrence, but its pathogenic importance is limited. It invades the corky cells of the outer periderm of the potato, but it does not reach the inner starch-layers.

J. R. Weir‡ has confirmed the finding of Sturgis that *Herpotrichia nigra* and *Neopeckia Coulteri* are not allied. The latter always attacks Pines; the former grows on other Conifers. The fungi differ not only morphologically, but in their effect on the host-plants. Weir describes another fungus, *Herpotrichia quinquesepitata* sp. n., which attacks *Picea Engelmanni*.

W. O. Glover§ describes a disease of *Clematis* causing stem-rot and leaf-spot as due to *Ascochyta clematidina*. The plants are killed by the growth of the fungus down the petiole into the stems, thus girdling the plants at the node. The development of the fungus is given in detail, and means of cure suggested.

The only known parasitic fungus of leafless mistletoes, *Wallrothiella Arceuthobii*, has been described by J. R. Weir||. It is of common occurrence in Montana and Idaho on the false mistletoes of Conifers, and is of economic value in affecting the control of the mistletoes. It is a Pyrenomycete, the spores of which are globose, thick-walled, and hyaline at first, but become brown-black. An account is given of the ecology of the fungus and the conditions influencing its development.

H. A. Edison¶ has found that four different fungi cause damping-off of seedlings of sugar-beet in America; these are *Phoma Betæ*, *Rhizoctonia* sp., *Pythium Debaryanum*, and a member of the Saprolegniaceæ. The latter has not been identified, but it is not *Aphanomyces laevis*, which has caused damping-off in other localities.

A study of *Phoma Betæ* was made by V. W. Pool and M. B. McKay.** It forms light brown spots on the leaves. An account is given of its

* Phytopathology, vii. (1917) pp. 432-42 (5 figs.).

† Rend. R. Accad. Lincei Rome, xxvi. (1917) pp. 509-12. See also Bull. Agric. Intell. Rome, viii. (1917) p. 1320.

‡ Journ. Agric. Research, iv. (1915) pp. 251-3.

§ Journ. Agric. Research, iv. (1915) pp. 331-42 (5 pls.).

|| Journ. Agric. Research, iv. (1915) pp. 359-78 (2 pls.).

¶ Journ. Agric. Research, iv. (1915) pp. 135-68 (10 pls.).

** Journ. Agric. Research, iv. (1915) pp. 169-77 (1 pl.).

distribution, and of experiments to test the vitality of the spores. The thermal death-point of *Phoma* on leaves exposed to dry-heat for half-an-hour was 80° to 90° C. It dies after three months' storage in soil. It does not survive the process of ensiling the beet-tops.

H. A. Edison* has also studied *Phoma Betæ* from a histological point of view. The period that the host is susceptible to infection is the seedling stage. The cells of the plant attacked were often nearly filled with the fungus, and it seems probable that though the middle lamella is dissolved the parasite does not live on it. Heavily invaded cells are consumed; the cytoplasm disappears, and the nuclei disintegrate. There may exist also less virulent infections, in which, though the fungus is established in the tissues, the beet continues a healthy growth; the balance is, however, not a healthy one, and in storage the activity of the parasite may be renewed.

A root-rot of Ginseng has been determined by J. Rosenbaum † as due to the Hyphomycete *Alternaria panax*: it results in yellowing and wilting of the leaves. Cultures and inoculations were made.

As a result of cultural and morphological studies, J. Rosenbaum ‡ has established the pathogenicity of a *Sclerotinia* causing the white-rot of Ginseng, and he has proved its identity with *S. libertiana*, which occurs on lettuce, celery, and a number of other hosts. He has also studied the *Sclerotinia* that causes black-rot of Ginseng, and finds it identical with *S. Smilacina*.

W. D. Valleau § has studied the resistance of plums to brown-rot, *Sclerotinia cinerea*. Infection may take place at any time through the skin, but different varieties have different powers of resistance after infection, due to parenchymatous plugs of the stomatal cavity, the production of corky walls, etc., rather than to any peculiar content of the fruit. Brown-rot is essentially a rot of ripe plums, at the stage when the fruits are softening. The hyphæ are intercellular, but do not dissolve the middle lamella. It was not possible to extract an enzyme from the fungus. The internal hyphæ lend support to the plums, hence it is a firm rot and the plums mummify. *Penicillium expansum*, on the contrary, produces a soft rot by dissolving the middle lamella.

Die-back of apple-trees has been traced to the fungus *Cytospora leucostoma* by Van der Byl. || It also occurs on other fruit-trees of the Rosaceæ. It begins as a brownish-black coloration near the soil and spreads upwards. Diseased trees usually die the second summer after attack. Species of *Cytospora* have been determined as the pycnidial stage of *Valsa*, but the writer was unable to produce any higher fruiting form in his cultures. He gives a detailed description of the disease and suggests methods of cure.

A disease of Sweet-Potato known as scurf was studied by Halstead ¶

* Journ. Agric. Research, v. (1915) pp. 55-7 (2 pls.).

† Journ. Agric. Research, v. (1915) pp. 181-2 (2 pls.).

‡ Journ. Agric. Research, v. (1915) pp. 291-7 (2 pls. and 1 fig.).

§ Journ. Agric. Research, v. (1915) pp. 365-95 (3 pls.).

|| African Journ. Sci., xvi. (1915) pp. 545-57 (4 pls. and 4 figs.).

¶ Journ. Agric. Research, v. (1916) pp. 787-91 (2 pls.).

and found by him to be due to a fungus, *Monilochaetes infuscans* g. et sp. n. He gave no technical account of the fungus. The disease has again been examined by L. L. Harter, who now describes both the disease and the fungus. The latter, a member of the Dematiaceæ, is superficial on the potato and causes a brown discoloration, but does not penetrate the epidermis.

Disease of Trees.*—W. H. Long has investigated the heart-rot of oaks caused by *Stereum subpileatum*. The fungus enters the wood of the host only through wounds that expose the heart-woods, through fire-scars or through branch stubs. The heart-wood is delignified by the action of the fungus. The sporophores were found only on dead trees or on dead areas of living trees. The rot is very widely distributed in America.

A root-rot of apple-trees in North Carolina has been determined by F. Wolf and R. O. Cromwell † to be due to *Xylaria* sp. The disease has been notified from various parts of the State and elsewhere. The roots are covered with black fungus incrustations, from the margins of which radiate minute black rhizomorphs. The cortex becomes corroded, and the disintegration of the wood follows, although slowly.

P. A. van der Byl ‡ has given an account of *Polyporus lucidus* which has caused the death of many acacia trees around Pretoria. He gives a systematic résumé of allied or synonymous species, and a description of the fungus itself and of its development within the tissues. The hyphæ do not pierce the walls of the wood vessels, they gain entrance by the pits. The fungus is a wound parasite, and the trees attacked are mostly in a previously enfeebled condition.

Endotrophic Mycorrhiza of Ericaceæ.§—Jean Dufrénoy has made a study of Mycorrhiza in *Arbutus Uuedo*. He finds that the roots are clothed with a dense mantle of hyphæ, some branches of which penetrate the tissues of the root, and haustoria are formed in the living cells of the host. Rootlets which have been inoculated early cease to grow apically and form tubercles. The base of the shoot also develops into a very large tubercle from which many lateral stems spring. The fungus penetrates into every part of the tree, even into the assimilating and reproductive tissues. The writer discusses the relations between the host-plant and the invading parasite.

Lichens.

(By A. LORRAIN SMITH, F.L.S.)

Attachment Organs of Corticolous Ramalinæ.||—Lilian Porter gives a historical account of work done on the anatomy of the *Ramalinæ*, especially with regard to their organs of attachment. She then describes

* Journ. Agric. Research, v. (1915) pp. 421-8 (1 pl.).

† Journ. Agric. Research, ix. (1917) pp. 269-76 (3 pls. and 4 figs.).

‡ South African Journ. Sci., xiii. (1917) pp. 506-15 (5 pls. and 6 figs.).

§ New Phytologist, xvi. (1917) pp. 222-8 (4 figs.).

|| Proc. Roy. Irish Acad., xxxiv. (1917) pp. 17-32 (3 pls.).

her own methods of work. The species she examined were *R. calicaris*, *R. fraxinea*, *R. fastigiata*, and *R. pollinaria*. She finds that the attachment organs are strands of closely-woven hyphæ longitudinally arranged, and continuous with the cortical tissues. They penetrate the periderm by cracks or lenticels, and by wedge action cause extensive splitting. New plants arise from the horizontal branches of these strands. She finds that the living tissues of the tree may be penetrated and injured. She also found evidence to prove that hypertrophy of the peridermal tissue of the host arises, and erosion of the wood by ingrowths of hypertrophied tissue. Methods of clearing the trees from lichen growths are suggested.

Varenne Collection of Lichens.*—This collection formed part of the herbarium of the late E. G. Varenne, who died in 1887. R. Paulson has made a systematic study of the lichens, which amount to 440 specimens. He has verified the determinations, and renamed them according to modern requirements. The Essex lichens among them, to the number of 124, form a nucleus for a lichen flora of the county. They are now in the possession of the Essex Field Club.

Lichens of Whatcom County, Washington.†—A. C. Herre gives a descriptive and ecological account of the county, as well as of the lichens found there. Originally the district was covered by typical dense coniferous forest, but intermingled with the Conifers are various deciduous trees, especially on low ground. Lichens are less prominent a feature in the region than mosses and hepatics: there are practically none of the very large species, but crustaceous forms on rocks, soil or trees are fairly abundant.

Notes on Parmeliopsis.‡—L. W. Riddle writes a full description of all the plants of this genus (or section of *Parmelia*). He gives a careful historical account of each species, and bases his conclusions on his examination of types as far as possible. The species occur in America as well as in Europe, and all have the same habitat—old fence-rails and the bark of Conifers.

Lichen Ecology.§—In discussing the ecology of the Foothills vegetation of the Rocky Mountains, A. G. Vestal includes lichens as an Association; the various members of the Association have been determined and described by R. Heber Howe. The rocks are dry surfaces much exposed to sun and wind, and they are first invaded by primitive xerophytic stages of fine-grained crustose species, notably the black-grey *Kinodina radiata*; coarser species follow, and later *Parmelia conspersa* becomes established as the dominant lichen. Notes on moist surface lichen species are also given.

* Essex Naturalist, xviii. (1917) pp. 133-4.

† Bryologist, xx. (1917) pp. 76-84.

‡ Bryologist, xx. (1917) pp. 69-76 (1 pl.).

§ Bot. Gaz., lxiv. (1917) pp. 360-2 (1 fig.).

Mycetozoa.

(By A. LORRAIN SMITH, F.L.S.).

Notes on New or Rare Myxomycetes.*—W. C. Sturgis has been studying a series of interesting Mycetozoa collected mainly by himself in Colorado. He describes and figures three new species, and gives many notes on the habitat and developments of other forms.

Irish Mycetozoa.†—The records of all Irish Mycetozoa up to the present date have been compiled by Margaret W. Rea and Margarita de Stelfox. The list, which includes thirteen species not previously reported from Ireland, is followed by notes on the habitat and occurrence of a number of species. The species *Physarum pulcherripes* was found in a larch plantation at Rostrevor; it is the first European record. The writers have also found the typical form of *Stemonitis splendens*, all other collections in the British Isles being the variety *Webberi*. *Licia minima* is also a new British record.

Contribution to the Life-history of *Spongospora subterranea*.‡ L. O. Kunkel finds that infection of potato-tubers by this organism is accomplished, not by separate amœbæ, but by creeping plasmodium which passes down through and between the epidermal cells. Usually a number of cells are killed at the point of entrance. Once beneath the epidermis it spreads out in all directions, and forms a rather flat disc-shaped mass, which separates the epidermis from the tissue beneath. The subsequent developments of the organism and its influence on the host are followed and described. In cultures allowed to become dry "the plasmodium encysts, as is common among the Myxomycetes. In many respects it accords with members of the Dictyosteliaceæ; branched sporophores are formed and spores as in *Dictyostelium*. The spores on germinating give rise to amœbæ each with one nucleus."

Schizophyta.**Schizomycetes.**

Erythrogenous Variety of *Bacillus pyocyaneus*.§—C. Gessard received a culture of *B. pyocyaneus* obtained from a wound. After a time on special media the organism developed a red pigment. The most favourable medium appears to be a mixture of pepton, glycerin, and agar. This medium became stained a bright red throughout.

Bacteria of Dust.||—E. Burnet has made an investigation of the bacteriology of dust collected from various sources, such as tramcars, railway carriages, theatres, and cinematographs, and from the interior of

* *Mycologia*, ix. (1917) pp. 323-32 (2 pls.).† *Irish Naturalist*, xxvi. (1917) pp. 57-65.‡ *Journ. Agric. Research*, iv. (1915) pp. 265-78 (5 pls.).§ *Comptes Rendus*, clxv. (1917) pp. 1071-3.|| *Ann. Inst. Pasteur*, xxxi. (1917) pp. 593-600.

vacuum-cleaners. The tubercle bacillus was recovered from three out of eighteen cultures from fresh dust, and was found to be full of virulence. Other organisms isolated were *B. subtilis*, various representatives of the *Mesentericus* group, and putrefactive organisms such as *B. aerogenes capsulatus*, *B. enteriditis sporogenes*, *B. tetani*, and the bacillus of Rodella. The anaerobic bacteria of the dust are derived from the earth, smoke, and faecal matter. They are the ordinary intestinal flora of man and the domestic animals. The author states that from the point of hygiene it is important to preserve our food and respiratory mucous membranes from the spores of such microbes. He thinks, indeed, that many cases of tetanus, in which the portal of entry cannot be found, are due to the action of contaminated dust acting on slightly abraded surfaces.

Intestinal Flora of Sprue.*—C. Elders has isolated an organism with the following characters from a case of typical sprue. With Neisser's stain the bacilli gave blue-staining polar bodies, with brown coloration of the bodies of the organisms. On glycerin-agar, after twenty-four hours at 37° C., a growth of small grey colonies with wavy edges was obtained. Milk curdled and soured in four days. The bacteria were non-motile and did not form spores. Mannite, lactose, and glucose were fermented. The bacteria grew best anaerobically, and glucose-agar stab-culture gave colonies having branching outgrowths. There was no growth in gelatin. It is possible that these diphtheroid bacilli may be lactic-acid bacilli derived from the milk-diet on which the patient had been placed.

Actions of Micro-organisms on Bone-marrow.†—Y. Matsueka records the results of his experiments on the effect of infection with staphylococci, streptococci, and tubercle bacilli on bone-marrow transplanted into the spleen. From previous experiments (1916) it was seen that bone-marrow transplanted autoplastically into the spleen is completely healed over five months after transplantation, there being no evidence of connective tissue reaction. The present experiments were designed with the view of finding if various forms of functional stimulation of the graft could call forth a distinctive active manifestation of function. Bouillon cultures of streptococci and staphylococci, or cultures of tubercle bacilli, were injected into the auricular veins of rabbits, which had previously been treated with marrow-grafts. Bone-marrow autoplastically transplanted into the spleen is converted mainly into cellular marrow and partly into gelatinous marrow by chronic streptococcal and staphylococcal infection, which eventually causes the death of the rabbit. The uninjured marrow in the femur shows exactly the same changes. The graft of bone-marrow is in part converted into cellular marrow by slight irritation of a tuberculous infection, whereby the reaction in the graft and in the marrow itself is identical. Bone-marrow autoplastically transplanted into the spleen is enclosed and healed over in strange surroundings without loss of its functional capacities, and, when infected, it shows the same

* Nederl. Tijdschr. v. Geneesk., i. (1917) pp. 17-20.

† Journ. Path. and Med., xxi. (1917) pp. 501-10.

reactions as the non-transplanted bone-marrow. Biologically, bone-marrow can therefore be transplanted into the spleen. In chronic infections with streptococci and staphylococci extra-medullary deposits make their appearance: these, however, are neither so large nor so numerous as in chronic anæmia.

Epidemic Dysentery on the Somme.*—G. Leygue and J. Hagnenau have studied an epidemic of 449 cases of bacillary dysentery which occurred among French colonial troops to the south of the Somme during the autumn of 1916. *B. dysenteriæ* Shiga was isolated in thirty-six cases, *B. dysenteriæ* Flexner in five cases, and *B. dysenteriæ* Hiss in twenty cases. In a smaller group of cases three other groups of organisms were isolated, with the following group characteristics:—

—	Motility	Bouillon	Gelatin	Agar	Litmus Milk	Neutral red	Indol	Lactose	Glucose	Levulose	Mannite	Maltose	Galactose	Succharose	Lead
Type I	0 -	Slight turbidity	No liquefaction	Colonies a little thicker than Flexner	Slightly redded	+	+	-	+	+	+	+	+	±	-
Media not fragmented															
Type II	0 -	ditto	ditto	ditto	ditto	+	+	-	+	+	+	+	+	-	-
Media fragmented															
Type III	0 -	ditto	ditto	ditto	ditto	+	+	-	+	-	+	-	+	+	+

Agglutination was tried in 325 cases, with 190 positive results (175 - to Shiga and 15 - to Flexner). Complement fixation was performed in ten cases, with negative results. Mixed infections with the enteric group were observed, *B. paratyphosus* A being isolated on four occasions and *B. paratyphosus* B twice. Agglutination was positive with *B. typhosus* in three cases and with *B. paratyphosus* A on one occasion.

* Presse Méd., xxv. (1917) pp. 4214.

MICROSCOPY.

A. Instruments, Accessories, etc.*

(1) Stands.

Bausch and Lomb's Metallurgical Microscope, CCM.†—This instrument (fig. 1) which has been made after the design of Dr. Albert Sauveur, of Harvard University, has a foot of horseshoe form. The

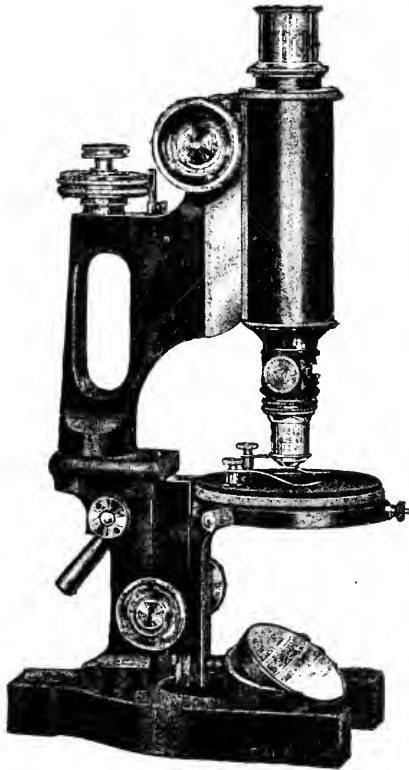

FIG. 1.

* This subdivision contains (1) Stands; (2) Eye-pieces and Objectives; (3) Illuminating and other Apparatus; (4) Photomicrography; (5) Microscopical Optics and Manipulation; (6) Miscellaneous.

† Catalogue, Microscopes, Bausch and Lomb Optical Co., New York, pp. 70-1.

pillar, rectangular in section, is provided with inclination joint and clamping lever to secure the instrument in any position by means of vertical and horizontal stops. The arm is of handle type and of enlarged design; it provides ample space for manipulation of object. The body-tube has 39 mm. of outside diameter, and is provided with society screw thread; the oculars are the Bausch and Lomb standard sized eye-pieces. The draw-tube is graduated in single millimetres, with every tenth line numbered. The coarse-adjustment is by standard rack and pinion, and has a stop to prevent pinion from over-riding rack. The fine-adjustment is of lever type, with milled micrometer screw head in two parts for slow and rapid movement, the larger graduated into 100 divisions, each equal to 0.0025 mm. in vertical movement, and provided with hinged indicator, which may be turned back from head; the fine-adjustment ceases to operate when objective touches specimen. The vertical illuminator is a plane glass reflector, readily adjustable, provided with three different sizes in revolving sleeve. The stage is adjustable vertically by standard rack and pinion to increase working distance and allow focusing without displacing vertical illuminator with reference to light; it is circular in shape, 102 mm. in diameter, with distance of 75 mm. from centre to base of arm; it is made of metal with vulcanite top, and is provided with centring screws and spring clips, removable for substitution of attachable mechanical stage. The mirror is plane and concave, 50 mm. in diameter, and adjustable in two planes in a fork mounting.

(3) Illuminating and other Apparatus.

Interference Refractometer.*—R. S. Williams, in pointing out the importance of measuring the refractive index of liquids in estimating their purity, observes that the effect of temperature can be best eliminated by measuring, not the absolute refractive index, but the index relatively to some standard liquid in the same bath. But while a refractometer of the Abbe type, for absolute values, gives results reliable to two units in the fourth decimal place, much greater accuracy can be obtained from an instrument which depends on the interference of light waves. The author finds that with such a refractometer a refractive index may be measured with an accuracy of from 0.00006 to 0.000003, which is, of course, far beyond the capabilities of a refractometer of the Abbe or Pulfrich type.

Use of the Stereoscope for Examining Superposed Projections.†—H. Hubert believes that his application of the stereoscope to the examination of suspended orthogonal projections is a novelty, and he seems to find it very successful. As an example he quotes the superposition of a topographical surface and an underlying geologic layer. In the ordinary manner superposition of such surfaces would be very confused, while the superposition of three surfaces would be hopeless. But stereoscopic

* Journ. Inst. Brewing, xxiii. (1917) pp. 457-60 (3 figs.).

† Comptes Rendus, clxv. (1917) pp. 1059-60.

fusion of two views renders the superposed projections absolutely independent of each other, because they appear in relief. The transformation of the superposed orthogonal projections into stereoscopic views is very simple, because in constructing each contour curve, it is only necessary to concern oneself with the scale of reduction, and with the position of the centre of the sheet of paper containing the projections. Each contour curve being, in regard to a surface immediately under it, supposed brought near to the observer by a quantity proportional to the graphic equi-distance (a quantity chosen arbitrarily once for all), the scale of reduction is given by the formula a/f , in which a is a variable equal to the distance of the sheet of paper from the observer's eyes, and f a constant equal to the distance between the observer's eyes and the stereoscopic views. As to the centre M of the sheet of paper, it will always lie at that normal to the stereoscopic views which passes through the middle of the line joining the optic centres O, O' of the two eyes. Consequently its projection in is always in the plane xy passing through the centres S, S' of the stereoscopic views. Moreover, it is as much to the left (for the right eye) or more to the right (for the left eye) of S and of S' as the variable a is proportionally smaller. Its position may be obtained either by construction (intersection of DM and of $O'M$ with xy) or by the calculation $mS = df/a$, where d is a constant equal to $\frac{OO'}{2}$. The construction of the two views is so much the more simplified, inasmuch as the projection of each curve intended for the left eye is rigorously superposable on the corresponding projection intended for the right eye. The only difference between two corresponding curves is that the projection of the centre M , instead of having the same relation with regard to S and to S' , is placed symmetrically with regard to the middle of the straight line joining these two points. In practice there is advantage in drawing much enlarged the stereoscopic images and in reducing them photographically. There is also a gain in not putting the two corresponding views on the same mount: partly, because each observer can then place them at the most favourable separation, and, partly, because the position of the two views can be also arranged for inversion, which will sometimes be more convenient for the observation of certain details.

(5) Microscopical Optics and Manipulation.

Spherometer of Precision.*—The chief feature of this instrument, says J. Guild, is the method employed for detecting the exact contact between the micrometer screw and the surface under test. The micrometer terminates in a small sphere of about 1.5 mm. diameter. A microscope with a suitable illuminating apparatus is mounted above, and the Newton's rings surrounding the point of contact are observed. By watching the behaviour of the rings when the screw is brought up the exact point of contact is determined. The sensitivity is about one-tenthousandth of a millimetre.

* Trans. Optical Soc., January 10, 1918.

B. Technique.*

(1) Collecting Objects, including Culture Processes.

Method for Discovering Fungi in the Sputum of Bronchitics.† Bazin, after alluding to the difficulty of finding fungi in non-tuberculous sputum, states that if the sputum be cultivated in a suitable medium at 37° C. for forty-eight hours colonies of fungi will be found to have developed. Raulin's fluid as a culture medium does well, but the author prefers glucose-glycerin water. For examining lactophenol was used. By the foregoing procedure he has identified five species of *Aspergillus* and two of *Sterigmotocystis*. He adds a note to the effect that iodide of potassium gives remarkable curative results.

Rapid Differentiation of Amœbæ Cysts.‡—D. W. Cutler and R. Williamson, with the intention of facilitating the rapid recognition of intestinal amœbæ, have applied the following method of examination :—A loopful of fæces is emulsified in a drop of 1 in 1000 solution of neutral-red in 0.85 p.c. sodium chloride solution. The preparation is covered with a cover-slip, and examined with $\frac{1}{8}$ -inch objective and No. 10 eyepiece. A warm stage is an advantage, but is not essential. In such a preparation the vegetative form of *E. histolytica* takes up the neutral-red, and the stained amœbæ can be readily seen and recognized. The pink dye is uniformly distributed throughout the endoplasm, while the ectoplasm remains unstained. *Entamoeba coli* is not stained, and appears as a light grey body. The method forms an easy and satisfactory means of differentiation between the two micro-organisms. The neutral-red method presents no disadvantage in looking for cysts, which appear as colourless refractile bodies. When difficulty has arisen in deciding to what species of entamoeba the cysts belong, the well-known iodine method can be employed. The large amœbæ of the "tetragena" type are usually easily recognized without the neutral-red method. It is the smaller form of *histolytica*, known as the "minuta" form, which appears only in the fæces in numbers as acute symptoms abate, which offers great difficulty in diagnosis. This type, however, reacts in exactly the same way to the neutral-red as does the "tetragena" type.

Studies in Cattle-plague.§—H. Schein has conducted a series of researches on the etiology and treatment of cattle-plague in Indo-China, and has arrived at the following conclusions with reference to this disease :—1. The goat is a good subject for experimentation. Its

* This subdivision contains (1) Collecting Objects, including Culture Processes; (2) Preparing Objects; (3) Cutting, including Embedding and Microtomes; (4) Staining and Injecting; (5) Mounting, including slides, preservative fluids, etc.; (6) Miscellaneous.

† C.R. Soc. Biol. Paris, lxxx. (1917) pp. 771-3.

‡ Journ. Path. and Bact., xxi. (1917) pp. 511-3.

§ Ann. Inst. Pasteur, xxxi. (1917) pp. 571-92.

susceptibility to bovine plague is nearly the same as the buffalo, in Indo-China at all events. 2. $\frac{1}{10000}$ c.cm. of virulent blood constitutes a certain lethal dose. 3. $\frac{1}{250000}$ c.cm. of blood is the smallest infective dose. 4. $\frac{1}{10}$ c.cm. of plasma is comparable to the minimal lethal dose. 5. The virus of bovine plague resides in the leucocytes, though it is sometimes found free in the plasma. 6. There are about 25,000 microbes, or groups of microbes, per c.cm. in the whole virulent blood. 7. There are about 10 organisms per c.cm. in the centrifuged citrated plasma. 8. Sensitization of the virus has not given good results in the author's hands. 9. Anti-pest serum does not act upon the virus itself but upon the organism of the experimental animal. 10. "Sero-infection" appears to give good results with the buffalo, provided a sufficient quantity of serum is injected (50 c.cm. per 100 kilos. body-weight for adults, more for young animals), and infecting with the least possible quantity of virus, in order to retard the rapid growth of the parasite.

Vitality of Rinderpest Virus outside the Animal Body.*—A. W. Shilton has carried out a series of elaborate investigations, at Mukhtasar in Northern India, with reference to the viability of the rinderpest virus outside the animal body under natural conditions, and has come to the following general conclusions :—

1. At the Mukhtasar Laboratory rinderpest infection was found to persist in certain buildings for forty-eight hours after the removal of sick animals, but not for longer periods of time ; frequently infection was absent after shorter intervals. Ground which was shaded by trees, when contaminated by cattle suffering from rinderpest, was found to be infective to healthy stock eighteen hours after the removal of the sick animals, but not for longer intervals. Ground entirely exposed to direct sunlight did not remain infective beyond eight hours.

2. In the plains, buildings were found to remain infective for twenty hours after the removal of the sick animals, but non-infective after longer intervals. Areas shaded by trees remained infective for twenty-four hours, and those exposed to direct sunlight for six hours after the removal of the sick animals, but not for longer periods of time.

3. The rinderpest virus was found to survive in mixed faeces and urine protected from direct sunlight for periods of fifty-four hours after excretion by sick animals, but when exposed to direct sunlight the virus did not survive for longer periods than eight hours. Saliva and nasal discharge from sick animals did not remain infective beyond forty-four hours.

4. It may be concluded, therefore, that in buildings and on areas infected by the natural discharges of sick animals, the rinderpest virus is unable to survive for more than two or three days, and when air and sunlight are freely admitted its destruction is even more rapid.

5. The carcasses of animals which have died from the disease must, however, be regarded as possible sources of infection for some considerable time after death, especially when the air-temperature is low, as it

* Mem. Dept. Agric. India, Veterinary Series, iii. No. 1 (1917).

has been shown that the virus can survive for fifty-one days in blood from a sick animal when this has been freely exposed to the air and allowed to become putrid; in meat and bones also the virus may persist for many days.

Further observations are necessary to determine the factors influencing the duration of the vitality of the rinderpest virus in dead animals' tissues.

(2) Preparing Objects.

Demonstrating Degeneration of Peripheral Nerves.*—C. Manalong adopted the following technique:—From 2–4 centimetres of the vagus and posterior tibial nerves are laid on a strip of cardboard and treated as follows: 1. Harden in equal parts of Müller's fluid and formaldehyde (10 p.c.) for twenty-four hours. 2. Replace by Müller's fluid for fifteen days. 3. Wash in running water for from twelve to twenty-four hours. 4. Transfer the tissue for fifteen days to the following solution: Müller's fluid 2 c.cm., 2 p.c. osmic acid solution 0.5 c.cm., distilled water 0.5 c.cm. 5. Wash in running water for from twelve to twenty-four hours. 6. Dehydrate in graded alcohols, changing the absolute alcohol twice. 7. Clear in origanum oil, tease under a dissecting microscope and mount in chloroform balsam.

Demonstrating the Cytoplasmic Inclusions of Germ-cells.†—J. B. Gatenby in his work on the snail used the following fixatives: 1. Modification of Flemming's strong formula without acetic acid. 2. Same fluid diluted one-sixth. 3. Champy's fluid. 4. Flemming's strong solution, the acetic acid being replaced by nitric acid. For staining, Ehrlich's hæmatoxylin and eosin, Mayer's acid hæmalum, iron-hæmatoxylin, with Orange G, Bensley's acid fuchsin, methyl-green, and alizarin-toluidin-blue. The following was the best of the fixing and staining methods:—The animals were anaesthetized in chloroform vapour, and after the shells were removed the ovotestis is cut out. This is cut in half longitudinally, and thrown into Flemming without acetic acid, diluted one-sixth with distilled water. Next day they are washed in running water for two hours, then passed through upgraded alcohol to absolute and xylol. Sections, 6 μ , are stained in iron-alum-hæmatoxylin by the long method—i.e. ten to twelve hours in iron-alum, ten to fourteen in hæmatoxylin. After differentiation the sections are stained with Orange G or van Gieson. The mitochondria and nebenkern are intense black and beautifully clear.

(4) Staining and Injecting.

Improvised Staining of Malarial Parasites.‡—G. Senevet used the following improvised eosin-azure stain for malarial blood, in the absence of special stains for this purpose:—

Two solutions are used: 1. Methylen-blue 1 gram, sodium borate

* Philippine Journ. Sci., xii. (1917) p. 171.

† Quart. Journ. Micr. Sci., lxii. (1917) pp. 562-4.

‡ Bull. Soc. Path. Exeta, x. (1917) pp. 510-2.

3 gram, distilled water 100 grams. The solution is left to ripen for eight to fifteen days at a temperature of 37° C. 2. Watery eosin 1 gram, distilled water 100 grams. Stain for two or three hours, for preference, with a weak solution of the stain—one drop of the eosin stain, and one or two drops of the blue stain to 20 c.cm. of neutral distilled water.

Rapid Examination of Malarial Blood.*—E. Roubaud recommends the following rapid method of detecting malarial parasites:—A thick blood-film is quickly dried by heat (45°–55° C.) and then hæmolyzed for five to ten minutes in distilled water. This technique destroys the parasite but leaves the distinctive yellow-brown pigment, which can be shown up more clearly if the film is stained for a few seconds with carbol-violet or thionin. In benign tertian infection the irregular streaks of small pigment-granules of the schizont can be distinguished with ease from the masses of pigment of the female gamete and the dense platelets of the male. The form of the other species of parasite are not so easily demonstrated. For the rapid detection of crescents the author places the dried thick film in a solution of thionin in distilled water, of the strength of 1 to 10,000, for ten to fifteen minutes. The hæmolysis of the film and the staining of the crescents occur simultaneously.

Staining Sporogenous Bacteria.†—L. Tribondeau makes a film from the culture in the usual way, and then fixes it by passing through the flame of a Bunsen six to ten times. When cool the slide is covered with Lugol's solution and then heated to vaporization. Next the film is covered with carbol-crystal violet and then heated to vaporization. After a wash in tap-water, the slide is covered with an aqueous solution of vesuvin (1 to 500). This is allowed to act for one to two minutes. After a wash in tap-water it is dried. The spores stand out a dark violet against the yellow-brown bodies of the bacteria. Instead of the foregoing, carbol-fuchsin and methylen-blue may be used as stain and counterstain.

Staining Young Eels.—A. Gandolfi Hornyold sends the following method, which he hopes may interest readers of the Journal. He writes from the Marine Biological Laboratory, Mallorca:—"In small eels the ovaries and the testicles have exactly the same appearance, namely, that of a very fine transparent band or ribbon, and it is only when the eels are about 24–26 c.cm. long that it is possible to distinguish the two sexes with a pocket-lens. Walter, in his monograph, 'Der Tenpaal,' advises to examine a fragment of the organ under the microscope with a low-power $\times 50$. If no eggs can be distinguished, the eel is most probably a male. The following method gives good results: I pour a little alcohol (90 p.c.) on the organs, and it is then quite easy to detach a fragment with a fine forceps, as coagulation renders

* Bull. Soc. Path. Exot., x. (1917) pp. 702–3.

† C.R. Soc. Biol. Paris, lxxx. (1917) pp. 880–1.

them white and more visible. I then put it on a slide in water to which is added a small drop of Loeffler's methylen-blue. I watch the staining under the microscope with a low power (I use Zeiss AA. with eye-piece No. 2 or 4). Staining takes place rapidly, and it is much more easy to distinguish the eggs than in an unstained fragment. One can afterwards mount in glycerin or in Apathy's gum-syrup. By this method I have been able to distinguish the sexes in eels 23·5 c.cm. long. I have tried vital staining on elvers. Neutral broth gives very good results, and does not appear to harm them. These stained elvers are very pretty in aquaria."

Staining Tubercle Bacilli.*—L. Tribondeau adopts the following procedure: The dried films of sputum are flooded with carbol-fuchsin, and heated to vaporization thrice. The stain is then thrown off and the film treated with nitric acid (acid 1, water 2) until it is yellow. It is then washed in running water, followed by alcohol (90 to 100 p.c.), until the film is of a pink colour. After a rapid wash in tap-water, it is treated with a saturated aqueous solution of picric acid (1 vol. plus alcohol 90–100 p.c. 1 vol.), or with a solution of methylen-blue (medicinal M.B. gr. 0·50, distilled water 150 c.cm.). These counter-stains are allowed to act for five to ten seconds. The slide is then quickly washed and dried. The picric acid treatment is preferable if tubercle bacilli only are sought for; the methylen-blue if the cell-elements, etc., are to be shown.

(5) **Mounting, including Slides, Preservative Fluids, etc.**

Preservation of Fermentation Organisms in Nutrient Media.†—A. Klocker makes an important communication on this subject. Hansen's conclusion that a 10 p.c. solution of cane-sugar forms an excellent medium is confirmed, but beer-wort is also very good. The Pasteur flask is undoubtedly the best form of vessel for prolonged preservation. The present observations were made, during a period of more than thirty years, on 820 cultures of yeasts and moulds. These included Saccharomycetes, Schizosaccharomycetes, Torulæ, Mycoderma, Endomyces, Monilia, Chalara, *Oidium*, and *Mucor*. For the most part the nutrient medium employed was a 10 p.c. solution of cane-sugar, in which 461 cultures were grown, but 290 cultures were made on beer-wort and 69 on other media. Of the 461 cultures on cane-sugar solution (231 of these being Saccharomycetes) 403 survived, whilst 58 perished. In the case of the 290 cultures grown on beer-wort (190 Saccharomycetes) 268 survived and 22 perished. Thus it must be concluded that fermentation organisms can be kept alive for upwards of thirty years. The exceptions to this rule are:—(1) The asporogenic varieties of Saccharomycetes; (2) *Saccharomyces Ludwigi*; (3) Schizosaccharomycetes; and (4) *Aspergillus glaucus*. Of the first only 44 p.c.

* C.R. Soc. Biol. Paris, lxxx. (1917) pp. 780–2.

† C.R. des Travaux du Laboratoire de Carlsberg, ii. pt. 6 (1917). See also Nature, Dec. 13 (1917) pp. 289–90.

survived on cane-sugar and 21 p.c. on beer-wort; of the second only one in nine survived on cane-sugar for more than 7·5 years, but all five cultures on beer-wort survived for twenty-five years. Only two out of five cultures of *Schizosaccharomyces* on cane-sugar survived, but ten out of eleven of those on beer-wort were living. Of six cultures of *A. glaucus* only one survived, and two of the remaining five perished in less than two years.

(6) **Miscellaneous.**

Rapid Method for obtaining Hæmolytic Serum.*—A. Sézary recommends the following rapid method:—Into the peritoneal sac of a rabbit a single injection of washed sheep's-corpuscles is made. The quantity of red corpuscles is that which is found in 35 c.cm. of defibrinated blood. The animal is bled eight days afterwards. The hæmolytic serum is just as powerful as if the animal were injected four or five times.

Detection of Bile-pigments in Blood-serum.†—A. Fonchet obtains blood by venous puncture (5 c.cm.). The serum is obtained by centrifuging or by leaving it to exude. Five drops are placed on some white surface, and then a similar quantity of the following reagent is added: Trichloroacetic acid, 5 grm.; water, 20 c.cm.; perchloride of iron, officinal, 2 c.cm. The two are thoroughly mixed with a glass rod. In less than twenty minutes a colour is obtained; this is greenish-blue and stable. If there be $\frac{1}{1000}$ of bilirubin the colour comes out at once.

* C.R. Soc. Biol. Paris, lxxx. (1917) pp. 797-8.

† C.R. Soc. Biol. Paris, lxxx. (1917) pp. 826-8.

Metallography, etc.

Heterogeneity of Steels.*—By treating polished sections of steel with a cupric reagent and then removing the deposited copper by solution in ammonia, G. Charpy and S. Bonnerot find that pearlite appears white and ferrite dark, i.e. the appearance is the reverse of that obtained by etching with ordinary reagents, such as nitric or picric acid. The parts which are darkened are those which receive the first deposit of copper, even in samples which appear to have received an almost uniform coating of copper. The selective action of the cupric reagent is determined mostly by the phosphorous and other elements in the ferrite, and not by the carbon, as with acid reagents. The dendritic structure of cast-steel is shown very clearly by this method of etching, the dendrites appearing white and the remainder of the mass, which has solidified later and contains the greater part of the foreign elements, dark; and the authors have used it to trace the progressive deformation of the dendrites during rolling of the steel. The dimensions of the dendrites and their variation with conditions of cooling were also studied. Variations in size of ingot have little effect on the size of the fine dendrites formed by contact with the walls of the ingot-mould; those which form in the centre of the ingot increase considerably in size with increase in size of ingot. In ingots of relatively pure steel and of medium size, variations of 1 to 10 in the relative size of the dendrites in the peripheral and central portions were observed.

Tungsten-Molybdenum Alloys.†—Alloys of tungsten and molybdenum were prepared by Z. Jeffries by mixing the powdered metals (obtained by reduction of the oxides in hydrogen) in the requisite amounts, pressing into briquettes and sintering in hydrogen at 1300° C., and then heating just below the fusion temperature (previously determined approximately) for twelve minutes. After such treatment the alloys were completely crystalline, and could be rolled or drawn. The melting-points were determined by a novel electrical method, depending on the number of watts consumed in melting a wire in an atmosphere of hydrogen, the melting-points and fusion-wattage of the pure metals being known. The melting-point curve shows that the alloys form a continuous series of solid solutions. This was confirmed by microscopical examination of the structure of the alloys. When properly prepared, all consisted of homogeneous polygonal crystals. The alloys were etched with a boiling solution of hydrogen peroxide. Examination of etching-pits in the pure metals showed that they both crystallized in the isometric system, the crystal units being cubes.

* Comptes Rendus, clxv. No. 17 (1917) pp. 536-40 (6 figs.).

† Trans. Amer. Inst. Mining Engineers, No. 115 (1916) pp. 1225-36 (11 figs.).

Method for Distinguishing Sulphides from Oxides in Steel.*—

It is shown by G. F. Comstock that light grey inclusions seen in polished unetched sections of steel do not always indicate manganese sulphide, as commonly believed. Iron oxide occasionally presents a similar appearance. In cases of doubt the nature of the inclusions can be definitely determined by the use of boiling alkaline-sodium picrate, the reagent used to darken cementite. This reagent attacks sulphide inclusions, changing the colour from light grey to black, while oxide inclusions are quite unattacked. Numerous photomicrographs are given illustrating the use of the reagent. It is made by dissolving 25 gm. sodium hydroxide in 60–70 c.cm. water, adding 2 gm. picric acid, and heating till the acid is dissolved, when the volume is made up to 100 c.cm. with water. To etch, the solution is brought to boiling, the specimen immersed, and boiling continued for ten minutes. Then the specimen is removed, washed, and dried.

Annealing of Bronze.†—An elaborate study has been made by C. H. Mathewson and P. Davidson of the combined effects of time and temperature of annealing and of cold-working with regard to the production of uniform structures and growth of recrystallized grain in bronzes containing 4 to 8 p.c. tin. The time necessary for the removal of the cored structure of the solid solution by diffusion is the same whether the alloys have or have not been cold-worked after casting. A given grain-size produced by annealing after deformation corresponds to the same degree of diffusion whatever the combination of time and temperature used in the annealing. Alloys which have been rendered homogeneous by a preliminary annealing develop a coarser grain on subsequent cold-working and annealing than alloys which are similarly treated but receive no preliminary annealing before cold-working. Numerous photomicrographs are shown in support of these conclusions.

An Unusual Feature in the Microstructure of Wrought-Iron.‡—A peculiar structure sometimes shown by wrought-irons high in phosphorus is described by H. S. Rawdon. The ferrite crystals present a mottled appearance after prolonged etching with an acid reagent such as 5 p.c. nitric acid in alcohol, which extends in streaks over the surface of the specimen. This intra-crystalline etch-pattern is quite distinct from the etching-pits which result from prolonged etching of ordinary wrought-iron. It is considered to be due to the non-uniform distribution of dissolved phosphorus in the ferrite, the area constituting the mottled etch-pattern being relatively high in phosphorus. By using Stead's cupric chloride reagent the patterns can be more strikingly developed. The fractures in some wrought-iron articles which had failed in use, and which showed these features in their structure, ran parallel to the

* Trans. Amer. Inst. Mining Engineers, No. 120 (1916) pp. 2103–10 (17 figs.).

† Int. Zeitschr. Metallographie, viii. (1916) pp. 181–218 (28 figs.).

‡ Engineering, cv. (1918) pp. 77–9 (18 figs.).

mottled bands, and are considered to have been caused by them owing to the brittle character of ferrite rich in phosphorus. Attention is drawn to the slowness of diffusion of phosphorus in ferrite, which accounts for the persistence of the non-uniform structure during the heating and rolling operations undergone by the wrought-iron articles before reaching the finished condition.

PROCEEDINGS OF THE SOCIETY.

AN ORDINARY MEETING

OF THE SOCIETY WAS HELD AT NO. 20 HANOVER SQUARE, W., ON WEDNESDAY, DECEMBER 19TH, 1917, MR. E. HERON-ALLEN, PRESIDENT, IN THE CHAIR.

The Minutes of the last Meeting, having been circulated, were taken as read, confirmed, and signed as correct by the President.

Mr. Feudick was elected a Fellow, and the names of four gentlemen were proposed for Fellowship, to be balloted for at the next Meeting.

Donation.—The President announced the receipt of a model of the diatom *Surirella bifrons*, made by the late Mr. John D. Hardy in 1888. It was very interesting as an early specimen, and had been presented by Mr. Rousselet, to whom a cordial vote of thanks was unanimously accorded.

Mr. Martin Duncan exhibited two photomicrographs of bacteria, which he took in 1896, by dark-ground illumination. Makers always insisted upon the necessity for using high-power immersion dark-ground condensers; but as these were now unobtainable, it would probably interest many, and particularly medical men, to realize that the ordinary achromatic condenser could be used if the correct stop was cut out and adjusted. Dr. Dallinger, in 1896, suggested the feasibility of these methods, and the two photomicrographs now shown were obtained in that way.

Mr. Martin Duncan was thanked for his exhibit.

A paper by Prof. G. S. West, M.A. D.Sc., on "A New Species of *Gongrosira*," was read by Mr. Scourfield. The new species was described as a lime-incrusted alga forming somewhat nodular masses, 4-9 mm. thick, of a vivid green colour, which had been found by Mr. Scourfield and Mr. Harris at Weston Mouth, Devon, growing in such a position

that it received the full force of a stream of water falling about 2 feet. It proved to be new, and was described as *G. Scourfieldii*.

Mr. Scourfield then called attention to three specimens of the new species which he was exhibiting.

Under one microscope was a mounted specimen of a free growth of this alga, which took place in a Petri dish, in which some little pieces of the lime-incrusted specimen were placed.

Under another microscope could be seen an edge view of a piece of the incrusted alga, showing that it grew somewhat spasmodically. A layer of intense growth, represented by the amount of chlorophyll in the algal threads, was succeeded by a layer of carbonate of lime without so much chlorophyll in the threads penetrating it; then, again, there was more chlorophyll in the threads, and so on, causing a banded appearance. He did not think the alternating bands represented long seasonal periods, but there was evidently some periodic difference in the intensity of growth of the alga and the deposit of lime. The incrusted specimen was not now of the vivid green it was when first collected; at that time it looked like a piece of polished malachite.

Under a third microscope a decalcified section of the incrusted specimen was shown.

Mr. Paulson asked how long Mr. Scourfield had had the alga growing in a free state. He assumed that it was growing in water containing no great proportion of lime, and it would be interesting to know whether any difference had been noticed in the growth, or whether the piece now being shown was exactly like the plant as he got it when dissolving the lime away.

Mr. Scourfield replied that he thought there might be slight differences between the decalcified specimen and that grown freely. The latter had been growing for a month or so, and in water containing a good deal of lime, in ordinary tap-water in fact.

The Meeting accorded a vote of thanks to Professor West for his paper.

Prof. W. Bateson, M.A. F.R.S., then gave an address on "Cytology and Genetics," in which he said that attempts to find regularity in the distribution of chromosome numbers had generally been unsuccessful; but called attention to the recent work of Winge, who, by preparing a graph of these numbers in plants, had shown that simple multiples of two and three occur with special frequency, while prime numbers are rare and exceptional. A survey was given of the phenomena of linkage between genetic factors as demonstrated in breeding experiments, with a discussion of Morgan's suggestion that this linkage is due to a linear arrangement of the linked factors in the same chromosome. Whether the proposition in its entirety was established or not might be doubtful, but the factors certainly behaved as if arranged in lines, and, as represented by the theory, a great diversity of genetic and cytological observations relating to the heredity of sex and other characters assumed an orderly form.

Mr. E. J. Sheppard referred in this connexion to two new fixatives that had recently been introduced. One of them contained Boyne's fixative with the addition of chromic acid and urea. In the second there was a combination of urea with Flemming's solution, used at different temperatures. He had employed the first of these, and so far had found it possessed great power of separation of the chromosomes in the synaptic stage; he had not worked with any material which showed very few chromosomes, such as hydrophalla. With other fixatives, the chromosomes were found tremendously compacted.

The President, in his usual happy phraseology, proposed a very cordial vote of thanks to Prof. Bateson for his address, which was carried by acclamation, and Prof. Bateson replied.

Colonel Clibborn was duly proposed, seconded, and agreed to as Fellows' Auditor for the current year.

The President announced that the next Meeting would be held on January 16th, 1918, and the next Meeting of the Biological Section on January 2nd.

The following Objects, etc., were exhibited:—

Mr. D. J. Scourfield:—Specimens of the new species of *Gongrosira* (*G. scourfieldii*) described in Prof. West's paper:—

1. Mounted slide of free-growing alga.
 2. Lime-incrusted mass of alga, showing banded structure.
 3. Decalcified section.
-
-

AN ORDINARY MEETING

OF THE SOCIETY WAS HELD AT 20 HANOVER SQUARE, W., ON WEDNESDAY, JANUARY 16TH, 1918, MR. E. HERON-ALLEN, F.L.S. F.Z.S. F.G.S., PRESIDENT, IN THE CHAIR.

The Minutes of the previous Meeting, having been circulated, were taken as read, confirmed, and signed by the President.

Mr. Blood and Mr. David were appointed as Scrutineers of the ballot for the election of Officers and Council for the ensuing year.

The President announced that the following gentlemen had been proposed for membership, and would be balloted for at the next Meeting:—Messrs. Adams, Seymour Jones, Ross, and Young.

The President announced that he had received a communication from the Conjoint Board of Scientific Societies, as the Society's delegate, asking him to bring it before the Fellows of this body:—

“The Publication of Scientific Information.”

“It has been brought to the knowledge of the Executive Committee that the publications of Scientific and Technical Societies sometimes include papers containing information which might be of value to the enemy.

“It is exceedingly difficult to control the transmission to neutral countries of publications or of information that might be extracted from them. The Executive Committee therefore desire to impress upon the constituent Societies the desirability of minimising the risk, so far as possible, by postponing till the end of the war, the publication of any paper containing information which might be of use to the enemy.

“As experience has shown that authors are themselves occasionally unaware of the use that could be made of their writings for purposes connected with the conduct of the war, the Executive Committee is considering whether any steps could be taken to assist, when desired, in cases of doubt and difficulty, the Publication Committee of the Constituent Societies.”

That was a matter which only needed to be brought before the Society to be acted upon.

He also referred to another matter *à propos* of the commandeering of the museums by the various Government departments. He had received a communication from Dr. Smith Woodward, of the Natural

History Museum, and from Sir Edward F. Kenyon, of the British Museum, asking whether he would act immediately as President of this Society, and in the name of the Society. He therefore protested against the proposed commandeering of these buildings in a communication to the Prime Minister, which was duly acknowledged, and he now reported what had been done.

Mr. D. J. Scourfield read the Report of the Council for 1917, as follows :—

FELLOWS.

The number of Ordinary Fellows elected and reinstated during the year 1917 was 15, while 9 died, 6 resigned or were removed. One Honorary Fellow has been lost by death.

	Hon. Fellows.	Ex-officio Fellows.	Ordinary Fellows.	Corresponding Fellows.	Total.
January 1, 1917	29	81	396	1	507
Enrolled during year	0	0	15	0	
Died	1	0	9	0	
Resigned or removed	0	0	6	0	
January 1, 1918	28	81	396	1	507

The List of Fellows now stands as follows :—396 Ordinary, 1 Corresponding, 26 Honorary, and 81 Ex-officio, or 507 in all.

JOURNAL.

In the Transactions are recorded nine original communications.

The Summary of Current Researches relating to Zoology, Botany, and Microscopy has been maintained as far as has been practicable under the circumstances brought about by the war.

The Council takes this opportunity of thanking the Editorial Staff for its work during the past year.

LIBRARY.

The condition of the Library continues to improve, and during the past year greater advantage has been taken by the Fellows of their privilege in regard to borrowing books from it.

The Society continues to subscribe to Lewis's Circulating Scientific Library, and the Council is glad to note that increasing use is being made of the volumes thus rendered accessible to the Fellows.

INSTRUMENTS AND APPARATUS.

The instruments and apparatus are in excellent condition, and during 1917, in addition to the New Optical System for the projection

of lantern slides, microscopical slides, fresh specimens, and book-plates or photographs purchased by the Society, the following donations were received :—

March 21st :—

Stand for the Society's 1917 projection apparatus. Presented by Mr. J. E. Barnard and Mr. C. F. Hill.

October 17th :—

An old Microscope of the Ellis Aquatic type. Presented by Mr. P. E. Radley.

A small collection of Accessories. Presented by Mr. Ingpen :—

1. An Immersion Paraboloid Illuminator devised by Dr. James Edmunds.
2. A Substage Condenser for Oblique Light.
3. An Abbe Diffraction-plate, Diaphragm, and Carrier.
4. The Abbe "aa" Objective used by Professor Abbe in demonstrating his Diffraction Theory.

CABINET.

The work of re-organizing the collection, with a view to weeding out the useless slides and making the valuable ones more easily accessible to Fellows, has been entrusted to Messrs. Earland and Sheppard, and has already made considerable progress.

The following additions have been made to the Slide Cabinet during the past year :—

March 21st :—Four slides of Mycetozoa. Presented by Mr. H. J. Howard.

MEETINGS.

The full number of Ordinary Meetings has been held during the year, and have, on the whole, been well attended by Fellows and visitors, despite travelling difficulties and lighting restrictions.

Original communications, probably owing to the fact that Fellows are becoming more deeply involved in war work, have been less numerous and voluminous than in 1916, although quite as important.

The Council is pleased to note that the miscellaneous exhibits, dealt with prior to the evening's "paper," have increased in number and interest. This is a particularly valuable feature of the Meetings, and one which should especially appeal to research workers as affording a means of discussing observations and testing theories during the progress of their work, and before their main results are ready for publication.

Of the Sectional Meetings, those devoted to Biology have alone survived the strain of war conditions: indeed the Biology Section may be congratulated on a very good Session's work. Eight Meetings have been held, with an average attendance of 22·4—the highest recorded since the Section was instituted.

CONJOINT BOARD OF SCIENTIFIC SOCIETIES.

An attempt has now been made to correlate the activities of the various Scientific Societies of Great Britain, and to prevent loss of energy

through overlapping of work, by means of a Conjoint Board of Scientific Societies that has been formed under the auspices of the Royal Society of London. The Royal Microscopical Society having been invited to nominate to one seat on this Board, the Council commissioned Mr. E. Heron-Allen to represent its interests during 1917, and has now requested him to continue to occupy this important post during the year 1918.

FINANCE.

Owing to various difficulties, it has again proved impossible to prepare a statement of the Society's financial position in time for the Annual Meeting. Comment must therefore be reserved for the February Meeting.

The President announced that the Scrutineers reported the unanimous election of the following Fellows to fill the various offices:—

President.—Joseph E. Barnard.

Vice-Presidents.—Edward Heron-Allen, F.L.S., F.Z.S., F.G.S., M.R.I.A., etc.; F. Martin Duncan, F.R.P.S.; Arthur Earland; Robert Paulson, F.L.S.

Treasurer.—Cyril F. Hill.

Secretaries.—J. W. H. Eyre, M.D., M.S., F.R.S. Edin.; David J. Scourfield, F.Z.S.

Ordinary Members of Council.—Alfred N. Disney, M.A., B.Sc.; R. G. Hebb, M.A., M.D., F.R.C.P.; T. H. Hiscott; Benj. Moore, M.A., D.Sc., F.R.S.; J. Milton Offord; Percy E. Radley; Edward J. Sheppard; A. W. Sheppard; Charles Singer, M.A., M.D., F.R.C.P.; Charles D. Soar, F.L.S.; Joseph Wilson; B. B. Woodward, F.L.S., F.G.S.

Librarian.—Percy E. Radley.

Curator of Instruments, etc.—Charles Singer, M.A., M.D.

Curator of Slides.—Edward J. Sheppard.

The President then delivered his valedictory Address, in which he gave a review of the war-conditions under which the Society had met since August, 1914, and of such part of the work of the Society as is ripe for publication in connexion with the war. He gave an analysis of the work of the Society's Abstractors during the periods 1901–1913 and 1914–1917, and adumbrated a contraction and specialization in the activities of the Society in the future, in the direction of the technical optics of the microscope and its application to all branches of industry and research.

Mr. Blood moved that the President be asked to allow his most interesting address to be printed in the Journal, and so follow precedent for similar occasions during many years. No words of his were needed to emphasize the desirability of that.

Mr. Earland seconded the proposal, and it was carried.

The President said he was very much obliged to the Meeting for the kind way in which his address had been taken, and would, of course, be proud to see it published in the Journal.

The President asked the Meeting to record a hearty vote of thanks to the Honorary Officers of the Society for their services during the past year.

The resolution was carried by acclamation.

Mr. Wilson gave notice of the following resolution :—

“That this Meeting instructs the Council to take the necessary action to remove all alien enemy Honorary, Ex-officio, and Ordinary Fellows from the Society’s Roll.”—(By-Law 34.)

Mr Hiscott seconded **Mr. Wilson’s** proposal, and pointed out that it was not proposed to put the resolution for decision on the present occasion ; according to the By-Laws (78, 86) the resolution would have to be posted for a period of two months. At the second Meeting, therefore, in March, Fellows would have an opportunity of discussing and voting upon it.

Messrs. Earland, Bruce Capell, Dr. Singer, and Col. Clibborn having spoken briefly,

The President reminded the Meeting that the subject was not before it for discussion at the moment.

Mr. Earland proposed the adoption of the Annual Report of the Council.

Mr. Blood seconded, and it was carried.

Dr. Eyre reminded Fellows that the Financial Statement had had to be deferred.

The President announced that the next Meeting of the Society would be held on February 20, and of the Biological Section on February 6.

AN ORDINARY MEETING

OF THE SOCIETY WAS HELD AT 20 HANOVER SQUARE, W., ON WEDNESDAY, FEBRUARY 20TH, 1918, MR. J. E. BARNARD, PRESIDENT, IN THE CHAIR.

The President, before proceeding to the formal business, expressed his thanks to the Fellows of the Society for the honour done him in electing him to the Presidential Chair.

The Minutes of the last Meeting, having been circulated, were taken as read, confirmed, and signed by the President.

The President directed that ballot should be taken for the four candidates for Fellowship, and read the nomination papers of Messrs. Bourke and Mortimer.

The President made sympathetic reference to the death of Miss Ethel Sargent, F.L.S., F.R.M.S., who was well known to the Fellows as a botanist of considerable distinction. He proposed, and the meeting carried, a vote of sincere condolence with the lady's relatives.

Mr. Scourfield read a letter from the son of the well-known microscopist Mr. Henry Van Heurck, of Antwerp, who was at present in England, but was unable to continue his studies from lack of necessary apparatus. He wished to know if any Fellow of the Society could help him in procuring a modern microscope and a few accessories.

The President remarked that whilst many Fellows had already done their utmost, as individuals, to further the national interests since the outbreak of war an opportunity had now occurred for action by the Society in its corporate capacity. As a preliminary it was proposed to prepare a new list of members which should be a members' directory, indicating the branch of work each Fellow was specially interested in.

March 20th, 1918

He had ascertained from the Venereal Diseases Committee that considerable difficulty was experienced in getting certain pathological material examined, particularly in country places, in some cases owing to lack of apparatus, and in others owing to lack of technical skill in its use, since the medical general practitioner was not, of necessity, an expert microscopist. Fellows of this Society could render the greatest possible assistance in work which was of great national importance, by advising the local medical man all over the country in the use of the microscope and the dark-ground illuminator, perhaps even setting it up for him. It would not entail very much time and labour, and probably one or two sittings would suffice to set matters in working order.

It had been further suggested to him just before the meeting, by a well-known Fellow, that the Society might issue some kind of certificate or guarantee that certain Fellows were competent to assist in this way : that a mild form of examination might be instituted, to which Fellows could submit themselves, to enable that guarantee to be given. In this connexion, it had been proposed to devote the March meeting to the subject of dark-ground illumination, and he was pleased to be able to announce that Professor Conradi, of South Kensington, had agreed to deal with the theoretical side of the subject. That gentleman was, of course, the authority on microscopical optics in this country, and he would invest the evening with great interest. Especially was that a pleasant announcement as Professor Conradi had not been among the Fellows at meetings for a long time. He (the President) would say a few words on the practical side, and would also try to get the English makers to send microscopes and dark-ground illuminators. He hoped that any Fellow who possessed similar apparatus would bring it along. Invitations would be extended to the members of the Venereal Diseases Committee, medical men and others, so as to make that meeting as representative as possible. If Fellows had any suggestions or criticisms to offer on this matter, he would be glad to hear them now. There being no dissentients, he assumed that his propositions were approved.

Mr. Wilson exhibited a Heliozoon (*Acauthoerystis*) and a Rhizopod (*Lesqueretisia*) to call attention to the fact of their abundance at this time of year.

The Society's thanks were accorded to Mr. Wilson.

The President expressed the regret with which the Council heard of the serious illness of Professor Moore, in consequence of which he was unable to give the demonstration announced for the evening. Though progressing satisfactorily, he would be unable to attend for some weeks. His contribution was, therefore, deferred, and Fellows would look forward with pleasure to it at no very distant date.

Col. H. E. Rawson, C.B., R.E., F.L.S., who had arranged an exhibit of mounted specimens to illustrate some of the points dealt with in Professor Moore's communication, was also unable to be present. His notes, however, were read by Mr. Scourfield, and from them it appeared that the specimens were drawn chiefly from *Tropæolum majus*, but they were typical of the responses made by several other species to the action of sunlight. The changes of colour and structure were produced by a system of selective screening under an English sun—full sun being screened from the plant at selected intervals of daylight, while paying due attention to the background. The screens might be at a distance of thirty feet and more. All the colouring-matters of *T. majus* were affected, and analysis of the observations of the past thirteen years justified the statement that changes of colour and structure were produced at different altitudes of the sun. Low sun of the early morning fostered the yellow colouring-matter, and the highest sun of mid-day the violets, blues, and purples, while middle sun stimulated the reds. Thus by giving a self-crimson form a maximum of low sun the flowers had been changed to yellow, with only fine red honey-guides showing in the posterior petals. Such changes reappeared in the plants raised from the seed if similarly screened. In this way a new purple form was obtained from other red and yellow forms which now came true in the open garden. The colour of the foliage also changed, as well as the lobing of the leaves. The scent of the flowers varied with the colour. When individual branches of the same plant were differently screened and the seed allowed to fall and sow itself, two new forms appeared which were well known to gardeners, but had not been previously seen in these experiments, suggesting that "sports" were the response of a plant to peculiar screening of a selective character. While plants were being screened to obtain new colours, changes of structure appeared, which also became identified with low, middle, and high sun, and could be repeated at will. Flowers grew with six, seven, and eight petals instead of the normal five, and their shapes were altered. The spurs were formed in a way which is stated to be unique, for they extend a petal instead of a sepal, and the number was increased to four. Experience soon enabled such extra spurs to be reproduced at will, together with the changes in the number and shape of the petals which were correlated with them. In addition to spur peloria, other "sports" well known to botanists appeared, such as proliferation, fasciation, leaf-division, synanthly, etc., and were illustrated in the exhibit. They had been produced repeatedly, and a specimen of *T. tuberosum* had just been deposited in the Natural History Museum, South Kensington, whose leaves were kept entire, or were divided into two, three, four, or five lobes as pre-arranged. The microscope had been used assiduously throughout these experiments, the growing flowers being arranged under the objective as the changes were in progress, and some very simple explanations of certain apparently complex phenomena had been obtained. Many of the colour-changes depended upon the form, size, and number of the epidermal papillæ, upon the turgidity of the living cells, and the concentration of their contents. In the leaf-division of

T. tuberosum a precipitation of the cell-contents was first observed which blocked the cord conveying the nutrition to the margin. An investigation by trained microscopists would undoubtedly bring most valuable information, and would advance our knowledge of the photo-synthetic action induced in living cells and their products.

Mr. Scourfield and Dr. Rudd Leeson commented upon some of the points raised by Col. Rawson.

Mr. F. I. G. Rawlins made a short communication on the Technique of the Vertical Illuminator, in which he pointed out that from experience in metallography it had been found unnecessary to use objectives in special short mounts with the vertical illuminator up to and including $\frac{1}{4}$ th powers, provided the objectives were corrected for work on uncovered objects. Obviously, this was an advantage in war time, when specially mounted lenses were unobtainable. It was quite possible to use the illuminator diaphragmed down to its smallest aperture, and so increase the definition. An illuminant such as the electric arc, giving light of short wave-lengths of considerable energy within the visible spectrum, was preferable for this work. Great importance was attached to the levelling of specimens, since failure to achieve this threw a large part of the reflected light outside the tube of the microscope. Levelling was best done by pressing the specimen face downwards on to a piece of plate-glass with a small quantity of plasticine on a common 3 in. by 1 in. slip. The latter was rested on the two edges of an accurately cut ring, and held there until the preparation had become embedded in the plasticine. For preserving metal specimens, a thin coating of a concentrated solution of gun-cotton in amyl-acetate was recommended—a method originally due to Professor Le Chatelier—as a preventive against rust. This was dropped on to the surface, and the section tilted until the drop found its own level, and set quite evenly to a thin layer, sufficiently transparent for use with a $\frac{1}{4}$ th objective. The varnish must not be applied with a brush, or ridges resulted which gave brilliant interference colours when viewed under the microscope. In any case it was important to line the inside of the tube with black velvet (such as was done in microphotography), to lessen the reflection as the light returned from the specimen to the observer, and in the cover-glass pattern illuminator to obviate the flare caused by that portion of the light which did not suffer reflection at the surface of the glass disc of the illuminator, but which penetrated the glass and struck the opposite wall of the tube.

Fellows were referred to a paper in the "Philosophical Magazine" for November, 1917, for employment of the vertical illuminator for biological work, where Lord Rayleigh dealt with the optical properties of collodion films (suggesting a possible analogy with a cover-glass).

Perhaps, also, a microscope such as Swift's "Arsenal," with tilting-stage, might assist in securing a level field of view. These two suggestions, however, had not been tested by the author, but are given for what they might be worth.

The President, in inviting discussion on the communication, said this was a subject which the Society had need to have brought before it. Mr. Rawlins had given enough openings, and he hoped some Fellows would discuss it.

Mr. Blood asked how Mr. Rawlins secured absolute uniformity and evenness of the layer of collodion or gum-cotton. Also, was it thick enough to give a cover-glass effect, and necessitate the tube-length correction? Further, did it give complicated reflections between the upper and lower surface?

Mr. Rheinberg said that recently he had occasion to measure up some films of collodion in other solvents which acted similarly to amyl-acetate. They were stripped off the glass and were found to be about $\frac{1}{3000}$ th of an inch. He thought it might be possible to get amyl-acetate or collodion almost as thin as that.

Dr. Leeson asked whether ordinary thin balsam would not do as well.

Mr. Scourfield said he had obtained striking effects with the vertical illuminator on living organisms. But there was the difficulty of reflections from the cover-glass, and some internal reflections from the objective, which produced haze and rendered observation of the specimens difficult. If that difficulty could be overcome, there would be a great field for biologists working with the vertical illuminator.

The President said the balsam would take a long time to dry, and there were dust possibilities. Evaporation took place quickly with amyl-acetate, and the film was more or less homogeneous. It was impossible that any amyl-acetate film could dry to anything like the thickness of a cover-glass. A 5 p.c. solution put on of appreciable thickness would dry down to very thin dimensions. He would have liked to hear Mr. Rawlins say something about the relative advantages and disadvantages of the type of vertical illuminator in which the prism was used, as compared with that employing a cover-glass, or a mica film. He considered that the difference in effect was, that with the prism illuminator one did not get the illumination truly normal to the surface, and one was only using half-aperture of the objective; while with the other type there was the possibility of aberrations induced owing to irregularities of the cover-glass, unless it were an optically-worked one. He knew that practical metallurgists varied in their opinion as to the relative advantages of these two types. The object of covering with celluloid was not clear to him. If it was simply to prevent tarnishing, the thinnest form would do, but if it was to take the place of a cover-

glass, he did not see why the thin cover-glass, cemented on with Canada balsam would not be better, as the irregularity of surface would not obtain.

Mr. Rawlins replied that his method was to take the section to be varnished, with an old photographic plate, and on to that he put a blob of plasticine, and set up the metal specimen. Usually it had a jagged under-surface, and stuck readily to the plasticine. He then poured the solution on to the polished surface. Observation was kept of any spot at which there was a tendency for it to settle. The plate was tilted backwards and forwards until the liquid settled in the centre. In thirty minutes, especially if placed in a draught, it became quite dry, and free from laminations or ridges, and penetrable up to $\frac{1}{4}$ th lens. The thickness would be up to three-quarters of a cover-glass. If more than one drop were put to a cover-glass, it would be far too thick, and the correction would be upset. This method, with $\frac{1}{4}$ th lens, did not land him into any difficulties, and it preserved the specimen for an indefinite time. There were no other inconvenient reflections. If a blob were allowed to be in any one place, especially as it was apt to be gummy at an angle of something like 57° , it might start plane polarization. At first he had difficulties because he used a camel-hair brush, which set up ridges. With a concentrated solution, the preserving effect would not be so good. He agreed that ordinary thin balsam would probably do as well. He tried the method he had described because of a recipe he got from a French photographer. He had, so far, only tried to use the film as a preservative: he could see the possibilities of trying it with a cover-glass.

A hearty vote of thanks was accorded to Mr. Rawlins for his communication.

A paper by **Mr. Ritchie** (Acetone as a Solvent for Mounting) was read in abstract by Mr. Scourfield. On the motion of the President the Society thanked the author for his communication.

The President, as required by the By-laws, again read the motion proposed at a previous meeting by Mr. Wilson, to empower the Council to remove all alien enemy Fellows from the Society's roll.

The President announced that the hour of the Meeting on March 20th would be 5.30, on account of the uncertainties in the conditions for an evening Meeting during a bright moon. The alteration seemed specially desirable as it was hoped the next Meeting, a special one, would be largely attended.

Mr. Wilson requested that in view of the alteration in the hour of the Meeting the discussion of his motion might be postponed until the April Meeting, at the usual hour. In April summer time would be operative, and the conditions would probably be more favourable for an evening Meeting than now.

This was agreed.

JOURNAL
OF THE
ROYAL MICROSCOPICAL SOCIETY.

JUNE, 1918.

TRANSACTIONS OF THE SOCIETY.

IV.—*Report on the Recent Foraminifera dredged off the East Coast of Australia. H.M.S. "Dart," Station 19 (14 May, 1895), Lat. 29° 22' S., Long. 153° 51' E., 465 fathoms. Pteropod Ooze—continued.*

By HENRY SIDEBOTTOM.

[Communicated by E. HERON-ALLEN and A. EARLAND.]

(Read October 17, 1917.)

PLATES III-V.

Sub-family **Bulimininae**.

Bulimina d'Orbigny.

Bulimina pyrula d'Orbigny.

Bulimina caudigera d'Orbigny, 1826, Ann. Sci. Nat., vol. vii, p. 270, No. 16, Modèle No. 68.

B. pyrula d'Orbigny, 1846, For. Foss. Vien, p. 184, pl. xi, figs. 9, 10.

B. pyrula Brady, 1884, Chall. Rept., p. 399, pl. 1, figs. 7-10.

Fair examples are present.

EXPLANATION OF PLATE III.

FIGS.

1-3.—*Bulimina ovata* d'Orbigny. Figs. 1-3, lateral views. × 25.

4-6.—*B. declivis* Reuss. Figs. 4-6, lateral views. × 50.

7.—*B. subcylindrica* Brady. Fig. 7, lateral view. × 50.

8-10.—*B. elegantissima* d'Orbigny, var. *fusiformis* nov. var. Figs. 8-10, lateral views. × 50.

11.—*B. elegantissima* d'Orbigny, var. *apiculata* Chapman. Fig. 11, lateral views. × 50. [continued.]

Bulimina ovata d'Orbigny. (Pl. III, figs. 1-3.)

Bulimina ovata d'Orbigny, 1846, For. Foss. Vien, p. 185, pl. xi, figs. 13, 14.
B. ovata Brady, 1884, Chall. Rept., p. 400, pl. 1, fig. 13.

The specimens are very large and in excellent condition. I believe that both the forms I have figured belong to the same species, the one (fig. 1) being in the megalospheric, the other (figs. 2, 3) in the microspheric condition.

Bulimina subteres Brady.

Bulimina presli, var. *elegantissima*, Parker and Jones, 1865, Phil. Trans. vol. clv, p. 374, pl. xv, figs. 12-17.
B. subteres Brady, 1884, Chall. Rept., p. 403, pl. 1, figs. 17, 18.

The tests agree with the "Challenger" figures of this species.

Bulimina declivis Reuss. (Pl. III, figs. 4-6.)

Bulimina declivis Reuss, 1863, Sitzungsab. d. k. Ak. Wiss. Wien, vol. xlviii, p. 55, pl. vi, fig. 70; pl. vii, fig. 71.
B. declivis Brady, 1884, Chall. Rept., p. 404, pl. 1, fig. 19.

Two found, both of which I have illustrated. Fig. 4 is very nearly the same as Reuss's fig. 71.

Bulimina subcylindrica Brady. (Pl. III, fig. 7.)

Bulimina subcylindrica Brady, 1881, Quart. Journ. Micr. Sci., vol. xxi, N.S., p. 56.
B. subcylindrica Brady, 1884, Chall. Rept., p. 404, pl. 1, fig. 16.
B. subcylindrica Millett, 1898, etc., Rept. Rec. Foram. Malay Archipelago, 1900, p. 377, pl. ii, fig. 6.

Typical examples occur.

Bulimina elegantissima d'Orbigny.

Bulimina elegantissima d'Orbigny, 1839, For. Amér. Mérid., p. 51, pl. vii, figs. 13, 14.
B. elegantissima Brady, 1884, Chall. Rept., p. 402, pl. 1, figs. 20-22.

A single small specimen, which I unfortunately flicked off the slide after examination

EXPLANATION OF PLATE III.—*continued*.

FIGS.

- 12-15.—*B. magdaleniforme* (Schwager). Figs. 12, 13, two views of the test. Fig. 14, half section of the test. Fig. 15, section viewed by transmitted light. $\times 25$.
 16.—*Virgulina schreibersiana* Czjzek. Fig. 16, lateral view. $\times 50$.
 17, 18.—*Bijarina mackinnoni* Millett, var. *robusta* nov. var. Fig. 17, lateral view. Fig. 18, edge view. $\times 50$.
 19.—*Bolivina textularioides* Reuss. Fig. 19, lateral view. $\times 50$.
 20, 21.—*B. lobata* Brady. Fig. 20, lateral view. Fig. 21, oral view. $\times 75$.
 22.—*Cassidulina calabra* (Seguenza). Fig. 22, ventral view. $\times 25$.
 23-25.—*Nodosaria radicularis* (Linné). $\times 50$.

Bulimina elegantissima d'Orbigny, var. *fusiformis*, nov. var.
(Pl. III, figs. 8-10.)

The test is fusiform, opaque and polished. The sutures show feebly. Five found. The specimens may be compared with *Bulimina pupa*, Terquem.

Bulimina elegantissima d'Orbigny, var. *apiculata* Chapman.
(Pl. III, fig. 11.)

Bulimina elegantissima d'Orbigny, var. *apiculata* Chapman, 1907, Tert. Foram. Victoria, Australia, pt. i. Journ. Linn. Soc. Zool., vol. xxx, p. 31, pl. iv, fig. 77.

B. elegantissima d'Orbigny, var. *apiculata* Chapman, 1915, Zool. Res. "Endeavour," Nat. Mus. Melbourne, vol. iii, pt. i, p. 18.

Two tests, somewhat more elongated than that figured by Chapman in the above reference. The basal spine is well developed. This species occurs also off Pernambuco, "Challenger" Station 120.

Bulimina rostrata Brady.

Bulimina truncana Hanken, 1875, Mittheil, Jahrb. d. k. Ung. geol. Anstalt. vol. iv, p. 61, pl. vii, fig. 5.

B. rostrata Brady, 1884, Chall. Rept., p. 408, pl. li, figs. 14, 15.

The species is well represented.

Bulimina aculeata d'Orbigny.

Bulimina aculeata d'Orbigny, 1826, Ann. Sci. Nat., vol. vii, p. 269, No. 7.

B. aculeata, Brady, 1884, Chall. Rept., p. 406, pl. li, figs. 7-9.

The examples are rather small.

Bulimina marginata.

Bulimina marginata d'Orbigny 1826, Ann. Sci. Nat., vol. vii, p. 269, No. 4. pl. xii, figs. 10-12.

B. marginata Brady, 1884, Chall. Rept., p. 405, pl. li, figs. 3-5.

A single, good example.

Bulimina inflata Seguenza.

Bulimina inflata Seguenza, 1862, Atti del' Accad. Gioenia, vol. xviii, Ser. 2. p. 109, pl. i, fig. 10.

B. inflata Brady, 1884, Chall. Rept., p. 406, pl. li, figs. 10-13.

Excellent specimens occur.

Bulimina contraria (Reuss).

Rotalina contraria Reuss, 1851, Zeitschr. d. deutsch. geol. Gesell., vol. iii, p. 76, pl. v, fig. 37.

Bulimina contraria Brady, 1884, Chall. Rept., p. 409, pl. liv, fig. 18.

There are beautiful examples of this very interesting form.

Bulimina convoluta Williamson.

- Bulimina pupoides*, var. *convoluta* Williamson, 1858, Rec. Foram. Gt. Britain, p. 63, pl. v, figs. 132, 133.
B. convoluta Brady, 1884, Chall. Rept., p. 409, pl. cxiii, fig. 6.
B. convoluta Millett, 1898, etc., Foram. Malay Archipelago, Journ. Roy. Micr. Soc., 1900, p. 279, pl. ii, fig. 9.

The specimens are small, but typical, and rather more erect than is usual in this species. The secondary chambers are well developed. Frequent.

Bulimina Williamsoniana Brady.

- Bulimina williamsoniana*, 1884, Chall. Rept., p. 408, pl. li, figs. 16, 17.
B. williamsoniana Millett, 1898, etc., Foram. Malay Archipelago, Journ. Roy. Micr. Soc., 1900, p. 279, pl. ii, fig. 8.
B. williamsoniana (*Buliminoides*) Cushman, 1910, etc., Foram. N. Pacific Ocean, 1911, U.S. Nat. Mus. Bull. 71, pt. ii, Textulariidae, p. 90, fig. 144.

Two very short tests occur.

Bulimina magdalidiforme (Schwager). (Pl. III, figs. 12-15.)

- Ataxophragmium magdalidiforme* Schwager, 1866, Geol., ii, p. 194, pl. iv, fig. 1.

I was quite unable to decide to which genus the specimens should be allocated, and therefore submitted examples and sections to Mr. Earland, who is of opinion that they are the same as Schwager's species. After reading a translation of Schwager's description and remarks I am in agreement with Mr. Earland.

Test rough, subcylindrical or ovate, superior end rounded off, inferior end tapering to a blunt point. Colour, a light yellowish grey.

In the following remarks the quotations are from Mr. Earland's letter to me: "The walls are built up of fine calcareous and siliceous mud on a basis of calcareous cement." The sutural lines do not show on the surface of the test owing to a "certain amount of overlapping external shell deposit masking the sutural lines." In the section the sutural lines can be seen between the later chambers. The aperture in fig. 12 differs from the type-form (which is comma-shaped and erect), and is arched and horizontal, and situated as shown. In some of the tests it is more or less indefinite and depressed. Nine occur.

This is a very curious and abnormal form differing widely in structure from any of the associated species of *Bulimina*. It does not appear to have been recorded since its discovery by Schwager in the Tertiary of the Nicobar Islands, and a further investigation of its structure may necessitate its removal to a new genus.

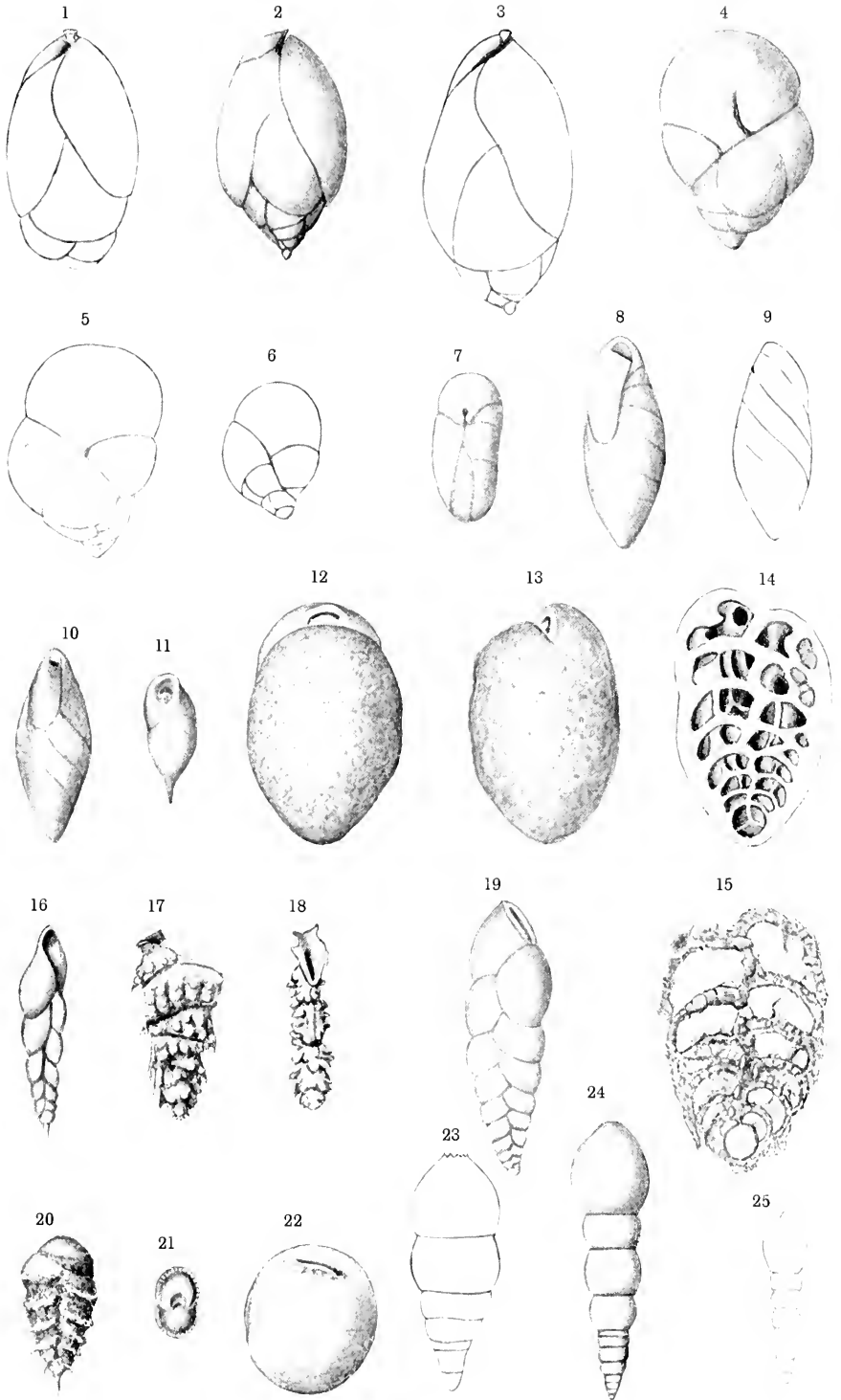

Pleurostomella Reuss.

Pleurostomella alternans Schwager.

Pleurostomella alternans Schwager, 1866, Novara-Exped. geol. Theil, vol. ii, p. 238, pl. vi, figs. 79, 80.

P. alternans Brady, 1884, Chall. Rept., p. 412, pl. li, figs. 22, 23.

A solitary, immature specimen.

Virgulina d'Orbigny.

Virgulina schreibersiana Czjzek. (Pl. III, fig. 16.)

Virgulina schreibersiana Czjzek, 1848, Haidinger's Naturwiss. Abhandl., vol. ii, p. 147, pl. xiii, figs. 18-21.

V. schreibersiana Brady, 1884, Chall. Rept., p. 414, pl. lii, figs. 1-3.

This variable species is only represented by a long, slender, compressed form. The chambers are upright, slightly inflated, and textularian throughout the entire length of the test. The basal chamber is armed with a long stout spine. The orifice is compressed. Six occur.

Virgulina subsquamosa Egger.

Virgulina subsquamosa Egger, 1857, Neues Jahrb. für Min., etc., p. 295, pl. xii, figs. 19-21.

V. subsquamosa Brady, 1884, Chall. Rept., p. 415, pl. lii, figs. 7-11.

The tests are somewhat similar to the "Challenger" fig. 10.

Virgulina squamosa d'Orbigny.

Virgulina squamosa d'Orbigny, 1826, Ann. Sci. Nat., vol. vii, p. 267, No. 1; Modèle No. 64.

V. squamosa Millett, 1898, etc., Foram. Malay Archipelago, Journ. Roy. Micr. Soc., 1900, p. 281, pl. ii, fig. 14.

The examples agree with Millett's figure in the above reference.

Bifarina Parker and Jones.

Bifarina mackinnonii Millett, var. *robusta*, nov. var. (Pl. III, figs. 17, 18.)

This variety is much more heavily built than the type-form. The tubercles are large and the virguline cluster of chambers also are tuberculate. The test is opaque, and all the interstices of the later chambers are rough. I have a somewhat similar test from the "Challenger" Station No. 185. Two occur.

Bolivina d'Orbigny.

Bolivina textularioides Reuss. (Pl. III, fig. 19.)

Bolivina textularioides Reuss, 1862, Sitzungsab. d. k. Ak. Wiss. Wien., vol. xlvi, p. 81, pl. x, fig. 1.

B. textularioides Brady, 1884, Chall. Rept., p. 419, pl. lii, figs. 23-25.

B. textularioides Heron-Allen and Earland, 1908, etc., Rec. and Foss. Foram. Selsey Bill, Journ. Roy. Micr. Soc., 1911, p. 316, pl. 10, figs. 10-12.

Some of the tests agree fairly well with Reuss's figure, and others with the "Challenger" fig. 23. The longer specimens

appear to be in the microspheric, and the shorter in the megalospheric condition.

Another set is of the same variety as that figured by Heron-Allen and Earland in the above reference, having the roughened, granular deposit in the neighbourhood of the sutures referred to by them.

There are also two large tests which appear to be intermediate between *B. textularioides* and *V. texturata* Brady. I have illustrated one of these (fig. 19).

Bolivina punctata d'Orbigny.

Bolivina punctata d'Orbigny, 1839, Foram. Amér. Mérid., p. 63, pl. viii, figs. 10-12.

B. punctata Brady, 1884, Chall. Rept., p. 417, pl. lii, fig. 18, 19.

Good examples are present. They are long and narrow.

Bolivina robusta Brady.

Bolivina robusta Brady, 1884, Chall. Rept., p. 421, pl. liii, figs. 7-9.

B. robusta Heron-Allen and Earland, 1915, Foram. Kerimba Archipelago, Zool. Soc., vol. xx, pt. xvii, p. 646.

The type-form is well represented. Most of the tests have the spine at the base; in the other cases it has most probably been broken off.

There are more numerous specimens of what appears to be a weak form. These are much narrower, and the edges of the test are rounded off. There is no basal spine. Probably this is one of the forms referred to by Heron-Allen and Earland in the above reference.

Bolivina beyrichi Reuss.

Bolivina beyrichi Reuss, 1851, Zeitschr. d. deutsch. geol. Gesellsch., vol. iii, p. 83, pl. vi, fig. 51.

B. beyrichi Terrigi, 1880, Atti dell' Accad., Pont. ann. xxxiii, p. 198, pl. ii, fig. 44.

Fair specimens occur.

Bolivina beyrichi, var. *alata* Seguenza.

Valculina alata Seguenza, 1862, Atti dell' Accad., Gioenia, ser. 2, vol. xviii, p. 113, pl. ii, figs. 5, 5a.

Bolivina beyrichi, var. *carinata* Terrigi, 1880, Atti dell' Acad., Pont. ann. xxxiii, p. 198, pl. ii, fig. 43-45.

B. beyrichi, var. *alata* Brady, 1884, Chall. Rept., p. 422, pl. liii, figs. 2-4.

Three fair specimens and two short ones.

Bolivina nobilis Hantken.

Bolivina nobilis Hantken, 1875, Mittheil. Jahrb. d. k. ung. geol. Anstalt, vol. iv, p. 65, pl. xv, fig. 4.

B. nobilis Brady, 1884, Chall. Rept., p. 424, pl. liii, fig. 14, 15.

Two rather feeble specimens.

Bolivina hantkeniana Brady.

Bolivina hantkeniana Brady, 1881, Quart. Journ. Micr. Sci., vol. xxi, N.S., p. 58.
B. hantkeniana Brady, 1884, Chall. Rept., p. 424, pl. liii, figs. 16-18.

Three rather small tests and a large one were found.

They are of the elongate type. In the case of the large specimen the chambers on one side of the alternating series are much more inflated than on the other.

Bolivina plicata d'Orbigny.

Bolivina plicata, 1839, Foram. Amér. Mérid., p. 62, pl. viii, figs. 4-7.
B. plicata Halkyard, 1889, Trans. and Ann. Rept. Manchester Micr. Soc., p. 65, pl. i, fig. 13.

Four occur, but they are not quite characteristic. Perhaps the usual markings are concealed through age.

Bolivina tortuosa Brady.

Bolivina tortuosa Brady, 1879, etc., Quart. Journ. Micr. Sci., 1881, N.S., p. 57.
B. tortuosa Brady, 1884, Chall. Rept., p. 420, pl. lii, figs. 31-34.
B. tortuosa Heron-Allen and Earland, 1915, Foram. Kerimba Archipelago, pt. ii, Trans. Zool. Soc., London, vol. xx, pt. xvii, p. 645.

One typical specimen, and one which is probably identical with the variation mentioned by Heron-Allen and Earland in the above reference. As they remark, "the test is covered with raised and contorted lines of shell-substance." I have also four examples of this variation from South Australia, so that it appears to be a definite form.

Bolivina karreriana Brady.

Bolivina karreriana Brady, 1881, Quart. Journ. Micr. Sci., vol. xxi, N.S., p. 58.
B. karreriana Brady, Chall. Rept., p. 424, pl. liii, figs. 19-21.

Three typical specimens.

Bolivina lobata Brady. (Pl. III, figs. 20, 21.)

Bolivina lobata Brady, 1881, Quart. Journ. Micr. Sci., vol. xxi, N.S., p. 58.
B. lobata Brady, 1884, Chall. Rept., p. 425, pl. liii, figs. 22, 23.
B. lobata Heron-Allen and Earland, 1915, Foram. Kerimba Archipelago, pt. ii, Trans. Zool. Soc., vol. xx, pt. xvii, p. 647.

The examples are not so fully developed as the "Challenger" specimens, being shorter. The aperture is situated in a depression and is not "a long oval slit contracted at the middle" as stated by Brady in his description of the species.

Millett, in his Malay Rept., 1898, etc., Journ. Roy. Micr. Soc., 1900, p. 6, pl. i, fig. 2, figures an example showing a further development, under the name *Bigenerina fimbriata*. Eight occur.

Bolivina decussata Brady.

Bolivina decussata Brady, 1881, Quart. Journ. Micr. Sci., vol. xxi, N.S., p. 58.
B. decussata Brady, 1884, Chall. Rept., p. 423, pl. liii, figs. 12, 13.

There are excellent specimens of this interesting form, but they are rough, and the protuberances are not rounded off smoothly, as shown in the "Challenger" illustrations.

Mimosina Millett.*Mimosina echinata* Heron-Allen and Earland.

Mimosina echinata Millett, var. *Sidebottom*, 1904, etc., Rec. Foram. Isl. Delos, Mem. Manchester Lit. Phil. Soc. 1905, p. 16, pl. iii, fig. 9.
M. echinata Heron-Allen and Earland, 1915, Foram. Kerimba Archipelago, pt. ii, Trans. Zool. Soc., London, vol. xx, pt. xvii, p. 651, pl. 1, figs. 12-18.

A few found. They have all the characteristics of the Delos specimens, and vary in the same manner in size and shape.

Sub-Family Cassidulininæ.

Cassidulina d'Orbigny.*Cassidulina levigata* d'Orbigny.

Cassidulina levigata d'Orbigny, 1826, Ann. Sci. Nat., vol. vii, p. 282, pl. xv, figs. 4, 5, Modèle No. 41.
C. levigata Brady, 1884, Chall. Rept., p. 428, pl. liv, figs. 1-3.

The tests are rather small.

Cassidulina crassa d'Orbigny.

Cassidulina crassa d'Orbigny, 1839, Foram. Amér. Mérid., p. 56, pl. vii, figs. 18-20.
C. crassa Brady, 1884, Chall. Rept., p. 429, pl. liv, figs. 4, 5.

Good examples, varying in size.

Cassidulina bradyi Norman.

Cassidulina bradyi (Norman M. S.) Wright, 1880, Proc. Belfast Nat. Field Club, App., p. 152.
C. bradyi Brady, 1884, Chall. Rept., p. 431, pl. liv, figs. 6-10.

A solitary example.

Cassidulina subglobosa Brady.

Cassidulina subglobosa Brady, 1879, etc., Quart. Journ. Sci., 1881, vol. xxi, N.S., p. 60.
C. subglobosa Brady, 1884, Chall. Rept., p. 430, pl. liv, fig. 17.

Good examples.

Cassidulina calabra (Seguenza). (Pl. III, fig. 22.)

Bursulina calabra Seguenza, 1879, Formaz. Terz. Reggio., p. 138, pl. xiii, fig. 7.
Cassidulina calabra Brady, 1884, Chall. Rept., p. 431, pl. cxiii, fig. 8.

Fine specimens occur. The tests are highly polished, and in some of the examples the sutural lines can hardly be distinguished.

Ehrenbergina Reuss.

Ehrenbergina serrata Reuss.

Ehrenbergina serrata Reuss, 1849, Denkschr. d. k. Akad. Wiss. Wien., vol. i, p. 377, pl. xlviii, fig. 7.

E. serrata Brady, 1884, Chall. Rept., p. 434, pl. lv, figs. 2-7.

There are eight good examples of this interesting form.

Family CHILOSTOMELLIDÆ.

Chilostomella Reuss.

Chilostomella ovoidea Reuss.

Chilostomella ovoidea Reuss, 1849, Denkschr. d. k. Akad. Wiss. Wien. vol. i, p. 380, pl. xlviii, fig. 12.

C. ovoidea Brady, 1884, Chall. Rept., p. 436, pl. lv, figs. 12-23.

With one exception the tests are narrow.

Seabrookia Brady.

Seabrookia carlandi J. Wright.

Seabrookia carlandi Wright, 1891, Rept. Foram. S.W. Ireland, Proc. Roy. Irish Acad., p. 477, pl. xx, figs. 6, 7.

S. carlandi Heron-Allen and Earland, 1913, Foram. Clare Island, Ireland, Proc. Roy. Irish Acad., p. 72, pl. v, figs. 10-12.

This interesting and minute foraminifer is well represented.

Family LAGENIDÆ.

Sub-family Lageninæ.

Lagena Walker and Boys.

Note.—All the Lagenæ found in this material have been described or referred to in my paper: Rept. Lagenæ S. W. Pacific Ocean, 1913, Journ. Quekett Micr. Soc. Club, ser. 2, vol. xii, 1913, No. 73, pp. 161-210, pls. xv-xviii. This station is indicated by the No. 43 in the localities. In the following list references are also made to my 1912 work: Lagenæ S. W. Pacific, H.M.S. "Waterwitch," Journ. Quekett Micr. Club, ser. 2 vol. xi, No. 70, pp. 375-434, pls. xiv-xxi. Most of the specimens have been transferred to the collection of Lagenæ described in the above papers, and are deposited in the South Kensington Museum under Mr. Thornhill's name. A few duplicates remain in my hands.

Lagena globosa (Montagu). Varying in size and shape.—Sidebottom, 1913, p. 164.

L. globosa (Montagu). Single and bilocular form.—Sidebottom, 1913, p. 164.

L. globosa (Montagu), var. *emaciata* Reuss.—Sidebottom, 1913, p. 165.

L. apiculata (Reuss).—Sidebottom, 1913, p. 165.

L. apiculata (Reuss), var. *punctulata* Sidebottom.—Sidebottom, 1913, p. 165; and 1912, p. 382, pl. xiv, figs. 21-23.

- L. ovum* (Ehrenburg).—Sidebottom, 1913, p. 166.
- L. botelliformis* Brady.—Sidebottom, 1913, p. 166; and 1912, p. 383, pl. 14, figs. 24, 25.
- L. levis* (Montagu). Various forms.—Sidebottom, 1913, p. 166.
- L. levis* (Montagu), var. *distoma* Silvestri.—Sidebottom, 1913, p. 167.
- L. elongata* (Ehrenburg).—Sidebottom, 1913, p. 167.
- L. aspera* Reuss.—Sidebottom, 1913, p. 167.
- L. ampulla-distoma* Rymer Jones.—Sidebottom, 1913, p. 168.
- L. hispida* Reuss.—Sidebottom, 1913, p. 168.
- L. striata* (d'Orbigny). Various forms.—Sidebottom, 1913, p. 169; and 1912, p. 386, pl. xv, fig. 8.
- L. striata* (d'Orbigny), var. *tortilis* Egger.—Sidebottom, 1913, p. 169.
- L. lineata* (Williamson).—Sidebottom, 1913, p. 170. Costæ curved, 1912, p. 387, pl. xv, fig. 15.
- L. costata* (Williamson).—Sidebottom, 1913, p. 170; and 1912, p. 388, pl. xv, figs. 16, 19.
- L. acuticosta* Reuss.—Sidebottom, 1913, p. 171.
- L. hexagona* (Williamson). Several forms present.—Sidebottom, 1913, p. 171.
- L. sulcata* (Walker and Jacob).—Sidebottom, 1913, p. 172. Apiculate forms likewise occur.
- L. plumigera* Brady.—Sidebottom, 1913, p. 173.
- L. gracilis* Williamson. Various forms.—Sidebottom, 1913, p. 173.
- L. semistriata* Williamson.—Sidebottom, 1913, p. 174.
- L. crenata* Parker and Jones, var.—Sidebottom, 1913, p. 174.
- L. stelligera* Brady, var. *eccentrica* Sidebottom. Compressed form.—Sidebottom, 1913, p. 175.
- L. striato-punctata* Parker and Jones. Several forms.—Sidebottom, 1913, p. 175.
- L. striato-punctata* Parker and Jones, var. *spiralis* Brady.—Sidebottom, 1913, p. 176.
- L. foveolata* Reuss. Sculpture of the test exceedingly fine.—Sidebottom, 1913, p. 177.
- L. foveolata* Reuss, var.—Sidebottom, 1913, p. 177; and 1912, p. 395, pl. xvi, figs. 16, 17.
- L. lamellata* Sidebottom.—Sidebottom, 1913, p. 177.
- L. hertwigiana* Brady.—Sidebottom, 1913, p. 178.
- L. hertwigiana* Brady, var. *undulata* Sidebottom.—Sidebottom, 1913, p. 178; and 1912, p. 397, pl. xvi, figs. 26-28.
- L. spumosa* Millett.—Sidebottom, 1913, p. 179.
- L. spumosa* Millett, var.—Sidebottom, 1913, p. 179; and 1912, p. 398, pl. xvi, fig. 30.
- L. chasteri* Millett (var.?).—Sidebottom, 1913, p. 180; and 1912, p. 398, pl. xvi, figs. 32-34.
- L. lovigata* (Reuss). Various forms, including *Fissurina oblonga* Reuss.—Sidebottom, 1913, p. 181.
- L. lovigata* (Reuss).—Sidebottom, 1913, p. 181, pl. xvi, fig. 5.
- L. acuta* (Reuss).—Sidebottom, 1913, p. 182.
- L. lucida* (Williamson).—Sidebottom, 1913, p. 183.
- L. multicosta* (Karrer).—Sidebottom, 1913, p. 183.
- L. fasciata* (Egger).—Sidebottom, 1913, p. 183.
- L. staphyllearia* (Schwager).—Sidebottom, 1913, p. 185.
- L. quadrata* (Williamson).—Sidebottom, 1913, p. 185.
- L. marginata* Walker and Boys. Several forms.—Sidebottom, 1913, p. 186.
- L. marginata* Walker and Boys, var. *striolata* Sidebottom.—Sidebottom, 1913, p. 188; and 1912, p. 408, pl. xviii, figs. 10, 11.
- L. marginata-perforata* Seguenza.—Sidebottom, 1913, p. 189.
- L. wrightiana* Brady.—Sidebottom, 1913, p. 189.

- L. lagenoides* (Williamson). Several forms.—Sidebottom, 1913, p. 190; and 1912, p. 411, pl. xviii, fig. 22.
L. formosa Schwager. Several forms.—Sidebottom, 1913, p. 191.
L. orbignyana (Seguenza). Several forms.—Sidebottom, 1913, p. 194.
L. orbignyana (Seguenza), var. *lacunata* Burrows and Holland.—Sidebottom, 1913, p. 194.
L. orbignyana (Seguenza), var. *walleriana* Wright.—Sidebottom, 1913, p. 195.
L. orbignyana (Seguenza), var. *clathrata* Brady.—Sidebottom 1913, p. 196.
L. bicarinata (Terquem), var.—Sidebottom, 1913, p. 197, pl. xvii, fig. 19.
L. auriculata Brady.—Sidebottom, 1913, p. 198; and 1912, p. 420, pl. xx, figs. 4, 7, 8, 13.
L. auriculata Brady, var. *circumcincta* Sidebottom. — Sidebottom, 1913, p. 199.
L. auriculata Brady, var. *clypeata* Sidebottom.—Sidebottom. 1913, p. 199.
L. auriculata Brady, var.—Sidebottom, 1913, p. 199, pl. xviii, fig. 6.
L. fimbriata Brady.—Sidebottom, 1913, p. 201.
L. protca Chaster.—Sidebottom, 1913, p. 203.
L. invaginata Sidebottom.—Sidebottom, 1913, p. 204, pl. xviii, fig. 13.
Eighteen occur. I omitted to record the specimens from this station in the 1913 report.

Sub-family Nodosarinae.

Nodosaria Lamarek.

Nodosaria (*Glandulina*) *levigata* d'Orbigny.

- “*Cornu Hammonis erectum globosius*” Plancus, 1739, Conch. Min., p. 16, pl. ii, fig. 3.
N. (Gl.) levigata d'Orbigny, 1826, Ann. Sci. Nat., vol. vii, p. 252, pl. x, figs. 1-3.
N. (Gl.) levigata Brady, 1884, Chall. Rept., p. 490, pl. lxi, figs. 20-22.

One large and three small specimens.

Nodosaria calomorpha Reuss.

- Nodosaria calomorpha* Reuss, 1865, Denkschr. d. k. Akad. Wiss. Wien., vol. xxv, p. 129, pl. i, figs. 15-19.
N. calomorpha Brady, 1884, Chall. Rept., p. 497, pl. lxi, figs. 23-27.

Most of the tests are slightly curved, and consist of from three to five transparent chambers.

Nodosaria radricula (Linné). (Pl. III, figs. 23-25.)

- “*Cornu Hammonis erectum*” Plancus, 1739, Couch. Min., p. 14, pl. i, fig. 5.
Nodosaria radricula Haensler, 1890, Abhandl. schweiz. pal. Gesell., vol. xvii, p. 92, pl. xiii, figs. 41-45, 47, 48, 50, and pl. xiv, figs. 3, 4.
N. radricula Brady, 1884, Chall. Rept., p. 495, pl. lxi, figs. 28-31.

The specimens are unsatisfactory, the chambers varying very much, as will be seen from the figures. They appear to be in the microspheric condition. Fig. 23 is not far from Haensler's illustration of *Glandulina levigata* in the above reference, pl. xiii, fig. 62.

Nodosaria radícula (Linné), dentaline form. (Pl. IV, figs. 1-5.)

This form, which I have found at several localities, has puzzled me for a long time. I have sent specimens to various authorities and obtained different opinions regarding them. Most of the tests are transparent, the others slightly clouded. I am treating them as a dentaline form of *N. radícula*. *Dentalina obesa* Costa, 1856 (Atti. Accad. Pontaniana, vol. vii, fasc. 2, pl. xxvii, fig. 13, not described) agrees best with my specimens. Excellent examples occur at Darval Bay, lat. 4° 11' N.; long. 118° 37' E.; 315 fms.

Nodosaria simplex Silvestri.

Nodosaria simplex Silvestri, 1872, *Nodos. Foss. e Viv. d'Ital.*, p. 95, pl. xi, figs. 268-272.

N. simplex Brady, 1884, *Chall. Rept.*, p. 496, pl. lxii, fig. 4, 5, 6 (?).

A single typical example.

Nodosaria sp.? (Pl. IV, fig. 6.)

The tests are slender. The orifice is phialine in those specimens which have a perfect final chamber. There are no signs of spines, but the surface of the last two segments is roughened in several examples. It is possible this may be a nude form of *sagrina virgula* which is often without the uvigerine segments. Somewhat similar forms are: *N. egregia* Franzenaw (Math. termész. értesítő, 1889, vol. vii, p. 253, pl. 4, fig. 7), and *N. uniuulifera* Gümbel (Abh. m-pl. Cl. k-bayer. Ak. Wiss. x. 1868 (1870), p. 614, pl. i, fig. 21).

Nodosaria pyrula d'Orbigny.

Nodosaria pyrula d'Orbigny, 1826, *Ann. Sci. Nat.*, vol. vii, p. 253, No. 13.

N. pyrula Williamson, 1858, *Rec. Foram. Gt. Br.*, p. 17, pl. ii, fig. 39.

There are fairly long fragments of well-developed specimens.

EXPLANATION OF PLATE IV.

FIGS.

- 1-5.—*Nodosaria radícula* (Linné), dentaline form. × 50.
 6.—*Nodosaria* sp. (?). × 75.
 7.—*N. (D) pauperata* d'Orbigny. × 25.
 8, 9.—*N. catenulata* Brady. × 50.
 10, 11.—*N. (D) obliquistriata* Reuss. Fig. 10 × 25. Fig. 11 × 50.
 12, 13.—*N. raphanistrum* (Linné). × 50.
 14, 15.—*Fronicularia spathulata* Brady. Fig. 14 × 50. Fig. 15 × 75.
 16, 17.—*F. pacifica* sp. n. Fig. 17, oral view. × 50.
 18.—*F. nitida* Terquem, var. × 75.
 19.—*F. tenera* (Bornemann). × 75.
 20-25.—*Rhabdogonium carinatum* sp. n. Fig. 21, oral view. × 50.
 26-31.—*Marginalina glabra* d'Orbigny. × 50.

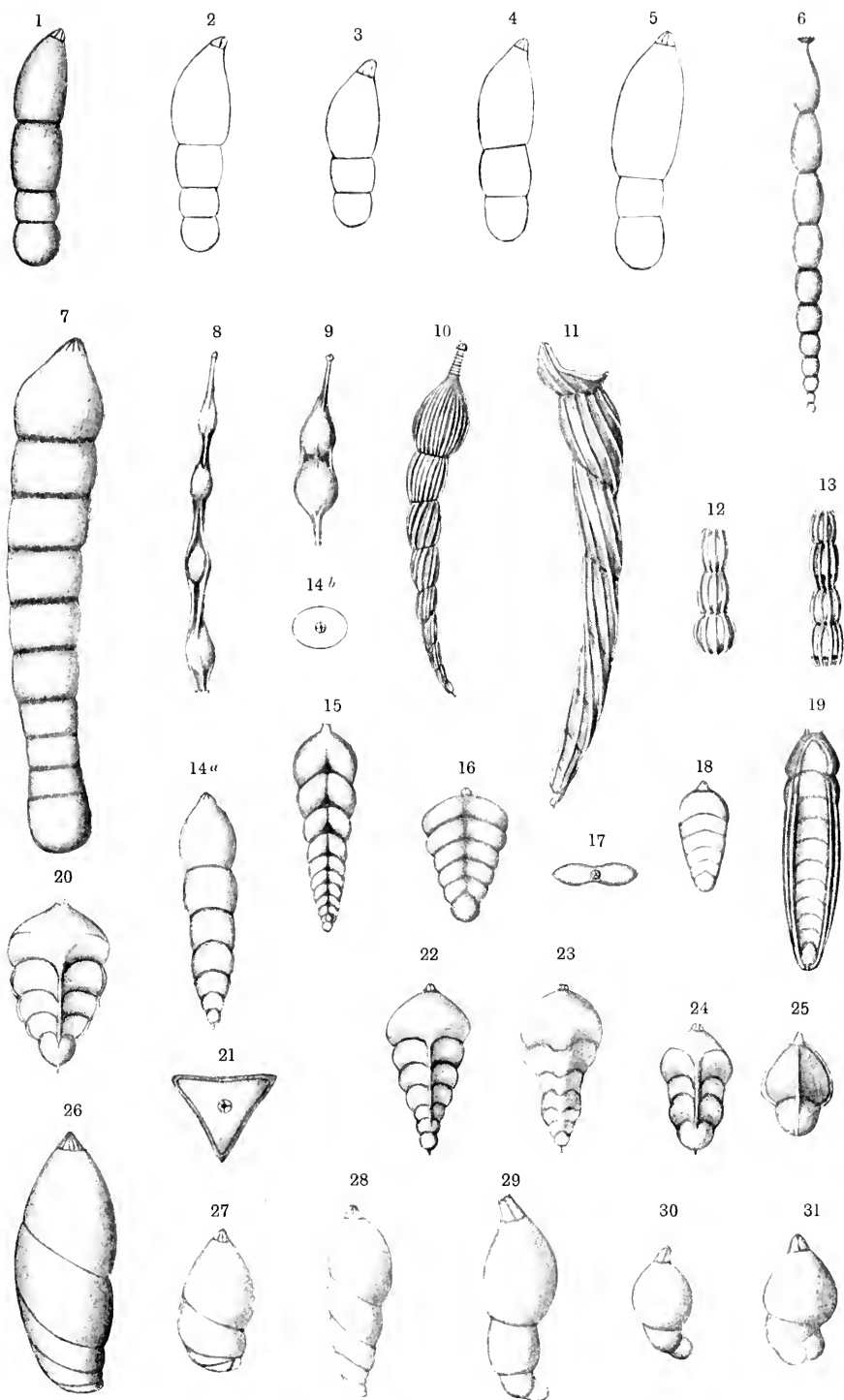

Nodosaria soluta Reuss.

- Nodosaria (D) soluta* Reuss, 1851, Zeitschr. d. deutsch. geol. Gesellsch., vol. iii, p. 60, pl. iii, fig. 4.
N. soluta Brady, 1884, Chall. Rept., p. 503, pl. lxii, figs. 13-16.

Two large fragments, and one of fair size.

Nodosaria inflexa Reuss.

- Nodosaria inflexa* Reuss, 1866, Denkschr. d. k. Akad. Wiss. Wien, vol. xxv, p. 131, pl. ii, fig. 1.
N. inflexa Reuss, 1870, Sitzungsber. d. k. Ak. Wiss. Wien, vol. lxii, p. 472, No. 16; Schlicht, 1870, Foram. Pietzpuhl, pl. xxxviii, fig. 3.
N. inflexa Brady, 1884, Chall. Rept., p. 498, pl. lxii, fig. 9.

A single test, very near to the "Challenger" figure.

Nodosaria (D) farcimen (Soldani).

- "*Orthoceras Farcimen*" Soldani, 1791, Testaceographia, vol. i, pt. ii, p. 98, pl. cv, fig. o.
Nodosaria farcimen, Brady, 1884, Chall. Rept., p. 498, pl. lxii, figs. 17, 18.

Two capital examples, similar to the "Challenger" form, fig. 18; also a fragment, consisting of five chambers, which more nearly resembles Soldani's figure.

Nodosaria (D) communis d'Orbigny.

- Nodosaria (D) communis* d'Orbigny, 1826, Ann. Sci. Nat., vol. vii, p. 254, No. 35.
N. communis Brady, 1884, Chall. Rept., p. 504, pl. lxii, figs. 19-22.

The best examples are very near to those figured in the Chall. Rept., although one or two have a tendency towards *N. roemeri*. There are also several slender tests which may be brought under this heading.

Nodosaria (D) pauperata d'Orbigny. (Pl. IV, fig. 7.)

- Dentalina pauperata* d'Orbigny, 1846, For. Foss. Vien, p. 46, pl. i, figs. 57, 58.
N. pauperata Brady, 1884, Chall. Rept., p. 500, woodcuts, fig. 14, *a, b, c*.

Good examples occur. Several have a tendency towards *N. roemeri* in the later chambers. One large test (fig. 7) has the initial chamber inflated and the shell slightly compressed for a short distance. I have a similar specimen from the "Challenger" Station No. 3.

Nodosaria (D) filiformis d'Orbigny.

- "*Orthoceratia filiformia ant capillaria*" Soldani, 1798, Testaceographia, vol. ii, p. 35, pl. x, fig. *e*.
Nodosaria filiformis d'Orbigny, 1826, Ann. Sci. Nat., vol. vii, p. 253, No. 14.
N. (D) filiformis Brady, 1884, Chall. Rept., p. 500, pl. lxiii, figs. 3-5.

A long example and two shorter ones. They tend towards *N. consobrina*, var. *emuciata* Reuss. The sutures are horizontal.

Nodosaria (D) roemeri Neugeboren.

Dentalina roemeri Neugeboren, 1856, Denkschr. d. k. Akad. Wiss. Wien, vol. xii, p. 82, pl. ii, figs. 13-17.

Nodosaria roemeri Flint, 1899, Rept. U.S. Nat. Mus. for 1897 (1899), p. 310, pl. lvi, fig. 2.

N. (D) roemeri Brady, 1884, Chall. Rept., p. 505, pl. lxiii, fig. 1.

A fine example, agreeing with the "Challenger" illustration; and two others not so long, but stouter.

Nodosaria (D) mucronata (Neugeboren).

"*Orthoceras intortum*" Soldani, 1791, Testaceographia, vol. i, pt. ii, p. 98, pl. ev, fig. 5.

Nodosaria (D) obliqua d'Orbigny, 1826, Ann. Sci. Nat., vol. vii, p. 254, No. 36, Modèle No. 5.

Dentalina mucronata Neugeboren, 1856, Denkschr. d. k. Akad. Wiss. Wien, vol. xii, p. 83, pl. iii, figs. 8-11.

Two occur, one of which is apiculate.

Nodosaria catenulata Brady. (Pl. IV, figs. 8-9.)

Nodosaria catenulata Brady, 1884, Chall. Rept., p. 515, pl. lxiii, figs. 32-34.

Three fragments, two having four chambers.

They are not typical, the chambers being farther apart than is shown in the "Challenger" illustrations, but the four costæ are present, bridging the depressions between the segments. Fig. 8 is from the specimen that has the segments most widely separated. Fig. 9 is more typical.

Nodosaria vertebralis (Batsch).

Nautilus (Orthoceras) vertebralis Batsch, 1791, Conchyl. des Seesandes, p. 3, No. 6, pl. ii, fig. 6, a, b.

Nodosaria vertebralis Flint, 1899, Rept. U.S. Nat. Mus. for 1897, p. 312, pl. lvii, fig. 5.

N. vertebralis Brady, 1884, Chall. Rept., p. 514, pl. lxiii, fig. 35; pl. lxiv, figs. 11-14.

Three occur. The final chambers are more or less inflated and without decoration.

Nodosaria scalaris (Batsch).

Nautilus (Orthoceras) scalaris Batsch, 1791, Conchyl. des Seesandes, No. 4, pl. ii, fig. 4, a, b.

Nodosaria scalaris Brady, 1884, Chall. Rept., p. 510, pl. lxiii, figs. 28-31; var. pl. lxiv, figs. 16-19.

Six occur. Only one has three chambers, the rest being in the bilocular condition. Four have the embryonal chamber smaller than the one following. Millett, in his Malay Rept. Journ. R. Micr. Soc., 1902, p. 520, draws attention to the fact that the multiocular forms have the embryonal chamber sometimes smaller and sometimes larger than the next; and discusses the question as to

the probable relationship of both *N. proxima*, *O. silvestri*, and *N. simplex* Silvestri to *N. scalaris* Batsch.

Nodosaria raphanus (Linné).

"*Cornu Hammonis erectum striatum*" Plaucus, 1739, Conch. Min., p. 15, pl. i, fig. 6.

Nautilus raphanus Linné, 1767, Syst. Nat., 12th ed, p. 1164, No. 283.

Nodosaria raphanus Jones, Parker and Brady, 1866, Foram. Crag. Pal. Soc., p. 49, pl. i, figs. 4, 5, 22, 23.

N. raphanus Brady, 1884, Chall. Rept., p. 512, pl. lxiv, figs. 6-10.

A single, small specimen, similar to the "Crag" illustration, fig. 4.

Nodosaria hispida d'Orbigny.

"*Orthoceratia quasi hispida*" Soldani, 1798, Testaceographia, vol. ii, p. 15, pl. ii, fig. P.

Nodosaria hispida Brady, 1884, Chall. Rept., p. 507, pl. lxiii, figs. 10, 11, 12-16.

A single specimen, similar to the "Challenger" illustrations, pl. lxiii, figs. 10, 11.

Brady remarks that "it is difficult to say whether they are arrested individuals of the present species, or belong to one of the allied forms like *N. setosa* Schwager (Novara-Exped. geol. Theil, vol. ii, p. 218, pl. v, fig. 40), to which in some respects they bear greater resemblance."

Two examples similar to the "Challenger" fig. 12, and five fragments of tests resembling figs. 14, 15.

Nodosaria (D) obliquestriata Reuss. (Pl. IV, figs. 10, 11.)

Dentalina obliquestriata Reuss, 1851, Zeitsch. Deutsch. Geol. Gesell., vol. iii, p. 63, pl. iii, figs. 11, 12.

Dentalina obliquestriata Jones, Parker and Brady, 1866, Foram. Crag. Pal. Soc., vol. xix, p. 56, pl. i, fig. 19.

This is an interesting variety of *N. (D) obliqua*. As will be noticed in the illustration, the obliquity of the striae is lost in the final chamber.

Two found, of which one is imperfect.

Nodosaria raphanistrum (Linné). (Pl. IV, figs. 12, 13.)

Nautilus raphanistrum Linné, 1767, Syst. Nat., 12th ed, p. 1163, No. 282.

Dentalina subarcuata. var. *jugosa* (parte) Williamson, 1858, Rec. For. Gt. Br., p. 20, pl. ii, fig. 44.

Nodosaria raphanistrum Jones, Parker and Brady, 1866, Foram. Crag. Pal. Soc., p. 50, pl. i, figs. 6-8.

This is a rare form in the recent condition. It is apparently fragile. Seven fragments occur, five of which have the initial chamber intact. In some there is a dark band showing just above the sutures.

*Lingulina d'Orbigny.**Lingulina pellucida* Sidebottom.

- Lingulina pellucida* Sidebottom, 1904, etc., Rept. Rec. For. Delos. Manchester Memoirs, 1907, vol. li, No. 9, p. 4, pl. i, figs. 22-25.
L. pellucida Heron-Allen and Earland, 1913, Clare Island Survey, Proc. Roy. Irish Acad., pt. 64, Forams., p. 96, pl. viii, fig. 10.
L. pellucida Sidebottom, 1910, Rep. Rec. For. Bay of Palermo, Manchester Memoirs, vol. liv, No. 16, p. 20.
L. pellucida Heron-Allen and Earland, 1916, Forum. South Cornwall, Journ. Roy. Micr. Soc., p. 47, pl. vii, fig. 4.

Two typical tests, one of which has three chambers. This species occurs also at Marseilles, and Heron-Allen and Earland report it at Noss Head in the Moray Firth.

Fronicularia DeFrance. (Pl. IV, figs. 14, a, 14, b, 15.)*Fronicularia spathulata* Brady.

- Fronicularia spathulata* Brady, 1879, Quart. Journ. Micr. Sci., vol. xix, p. 270, pl. viii, fig. 5.
F. spathulata Brady, 1884, Chall. Rept., p. 519, pl. lxxv, fig. 18.
F. spathulata Sidebottom, 1904, etc., Rept. Rec. Forum. Isl. Delos, Mem. Proc. Manchester, Lit. Phil. Soc., 1907, vol. li, No. 9, p. 5, pl. i, fig. 26.
F. spathulata, 1910, Rept. Rec. For. Bay Palermo, Mem. Proc. Manchester Lit. Phil. Soc., vol. liv, No. 16, p. 21, pl. ii, fig. 22.

Fig. 14a is somewhat similar to the "Challenger" illustration of *Lingulina carinatu*, pl. lxxv, fig. 16, but the sutures of the earlier portion of the test are arched. The initial chamber is inflated, and the four following chambers are well flattened.

Fig. 15 has a continuous depression running down the centre of the test similar to the "Palermo" example in the above reference. Bruckmann (1904, Forum. der litanisch-kurischen Jura, pl. i, figs. 18, 19) figures specimens with depressions under the name *F. spatulata* Terquem, but the curving of the sutures is not the same as in the example I figure. Besides the above there are nine other tests, varying in minor details from fig. 14. Most of these are more compressed.

Fronicularia pacifica, sp. n. (Pl. IV, figs. 16, 17.)

Test compressed, chambers arched, sutures sunk. Initial chamber circular and inflated. Immediately above the initial chamber a depression commences, which is continued throughout the length of the test. The orifice is slightly produced and stellate. The edges of the test are rounded and lobulate. The chambers, as they are added, increase rather rapidly in width. The nearest published figure to this form appears to be *F. woodwardi* Howchin, 1895, Carb. Forum. Western Australia, p. 197, pl. x, fig. 4 (Rept. Aus. Ass. Sci., Adelaide, 1893, p. 366); but my specimen chiefly

differs in having the sutures sunk, and the central depression referred to above. Howchin remarks that his form "somewhat resembles *F. complanata* Defrance," and states in what way it differs. Mine, I think, is more nearly related to *F. spathulata* Brady.

A solitary example.

Fronidicularia nitida Terquem, var. (Pl. IV, fig. 18.)

Fronidicularia nitida Terquem, 1858, Mém. Acad. Imp. de Metz, vol. xxxix, p. 592, pl. i, fig. 9.

F. nitida Millett, 1898, etc., Foram. Malay Archipelago, Journ. Roy. Micr. Soc., 1902, p. 525, pl. xi, fig. 19.

This little specimen (Pl. IV, fig. 18), is nearer to Millett's example than to the original. It differs chiefly from Millett's in having the final chamber neither so large nor so much pointed. Another example is not quite so regular in outline, and a third is doubtful.

Fronidicularia tenera (Bornemann). (Pl. IV, fig. 19.)

Lingulina tenera Bornemann, 1854, Lias von Göttingen, p. 38, pl. iii, fig. 24, a-c.

L. tenera Tate and Blake, 1876, Yorkshire Lias, p. 455, pl. xviii, figs. 15, 15a.

Fronidularia pupa Terquem and Berthelin, 1875, Mém. Soc. Géol. France, p. 26, pl. iii (xiii) fig. 1, a-o.

F. pupa Terquem, 1883, Cinquième Mém. Foram. Oolithique, p. 346, pl. xxxviii, fig. 7a, b.

F. milletii Brady, 1884, Chall. Rept., p. 524, woodcut fig. 16, a, b.

There are six tests on the slide, and I have chosen the largest one for illustration. The mouth is fractured, but it has evidently been circular. There are five costæ on either edge of the test. The remaining five specimens vary in size and in minor details. One is in the microspheric condition. I find that the curving of the sutures is best seen when the light falls directly down the test.

Messrs. Heron-Allen and Earland, in the above reference, state fully their reasons for placing this varying form under the name *F. tenera* Bornemann. I have a similar test from the "Challenger" St. 185, and also from Cebu, Philippine Islands, 120 fms.

Rhabdogonium Reuss.

Rhabdogonium tricarinatum (d'Orbigny).

Vaginulina tricarinata d'Orbigny, 1826, Ann. Sci. Nat., vol. vii, p. 258, No. 4, Modèle No. 4.

Rhabdogonium pyramidale Karrer, 1861, Sitzungbr. d. k. Ak. Wiss. Wien, vol. xvi, p. 19, pl. i, fig. 34.

R. tricarinatum Brady, 1884, Chall. Rept., p. 525, pl. lxvii, figs. 1-3.

Good examples occur, similar to the "Challenger" figures.

Rhabdagonium carinatum, sp. n. (Pl. IV, figs. 20-25.)

The test is triangular in cross-section, and the orifice is stellate and somewhat produced. The chambers are narrow and slightly embracing, and each successive chamber increases very little in height. The sutural depressions are arched. Each chamber is carinate at its angles. Sometimes the carination is continuous. The tests are transparent, and vary a good deal in outline. Probably both the megalospheric and microspheric forms are present.

Ten occur; one is very much malformed, and two are not carinate; these latter are probably immature. The specimens appear to be closely allied to Chapman's *Rhabdagonium tricarinatum* d'Orbigny, sp., var. *acutangulum* Reuss, var. (Journ. Roy. Micr. Soc., 1894, p. 159, pl. iv, fig. 8), and may prove to be nothing more than a local form. I have two examples of this form from the "Challenger" Station No. 185, Raine Island, one of which is identical with my fig. 20, and which I submitted to the late Mr Millett for his opinion. He wrote: "The clear shelled *Rhabdagonium* is a splendid specimen, and you must figure it—Chapman gives something like it from the Gault, he calls it *acutangulum*, but I doubt if yours is that species."

I have also a specimen that I found in material received from the U.S. Nat. Museum, marked "U.S. steamer 'Albatross,' St. 2150; 382 fms., near Old Providence Island."

Fig. 25 is no doubt a young shell, and is somewhat similar to Reuss' *R. globiferum*, Sitz. d. k. Ak. Wiss. Wien., vol. xl, 1860, p. 201, pl. vii, fig. 6, and *R. pygmaum*, Denkschr. d. k. Ak. Wiss. Wien, vol. xxv, 1865, p. 138, pl. ii, fig. 32, and *R. pygmaeum* (Reuss) Terquem, Ess. Anim. Plage Dunkerque, pt. i, 1875, p. 22, pl. 1, fig. 8.

Marginulina d'Orbigny.

Marginulina glabra d'Orbigny. (Pl. IV, figs. 26-31, and Pl. V, figs. 1 (?), 2, 3.)

Marginulina glabra d'Orbigny, 1826, Ann. Sci. Nat., vol. vii, p. 259, No. 6, Modèle, No. 55.

M. pedum d'Orbigny, 1846, For. Foss. Vien, p. 68, pl. iii, figs. 13, 14.

M. similis, d'Orbigny, 1846, For. Foss. Vien, p. 69, pl. iii, figs. 15, 16.

M. glabra, Flint, 1899, Rept. U.S. Nat. Mus. for 1897 (1899), p. 313, pl. lx, fig. 1.

One hesitates to add to the numerous figures of this species and its varieties, but the specimens I have figured are interesting as being recent examples, and I am bringing them all under the above heading. Other tests are more characteristic of the species.

Fig. 26 is not far removed from *M. subcrassa* Schwager, 1866,

Novara-Exped. Geol., p. 240, pl. vi, fig. 82, and *M. glabra* Fornasini, 1890, Mem. Acc. Sc. Bologna, ser. iv, vol. x, p. 470, fig. 29.

Fig. 28 is not far removed from *M. similis* d'Orbigny, fig. 15 in the above reference.

Figs. 29, 30, 31, 32 (?) are somewhat similar in character to *M. bullata* Reuss, 1845-6, p. 29, pl. xiii, figs. 34-38; and to *M. subbullata* Hanken, 1875 (1876), A magy. Kir. földt. int. évkönyve, p. 39, pl. iv, figs. 9, 10, and pl. v, fig. 9; and *M. glabra* Terrigi, 1891, Mem. Reg. Com. Geol. d'Ital. vol. iv, p. 93, pl. iii, fig. 5.

Fig. 1, Pl. V may be a malformed test or a "cluster" of *Lagena globosa*.

Figs. 2, 3, Pl. V. The nearest figures to these that I can find are *Glandulina adunca* Costa, 1856, Atti Accad. Pontaniana, vol. vii, p. 128, pl. xi, fig. 24; *Pseudium ovatum* Seguenza, 1880, Atti. R. Acc. Lincei, vol. vi, p. 139, pl. xiii, fig. 8.

A few very small tests occur, which I am also placing under *M. glabra*.

Vaginulina d'Orbigny.

Vaginulina legumen (Linné).

Nautilus legumen Linné, 1788, Syst. Nat., p. 3373, No. 22, ed. xiii.

Vaginulina legumen Brady, 1884, Chall. Rept., p. 530, pl. lxvi, figs. 13-15.

A single, long, narrow specimen.

Vaginulina costata (Cornuel). (Pl. V, figs. 4, 5.)

Planularia costata Cornuel, 1848, Mém. Soc. Géol. France, Sér. 2a, vol. iii, p. 253, pl. ii, figs. 5-8.

Vaginulina patens Brady, 1884, Chall. Rept., p. 533, pl. lxvii, figs. 15, 16.

V. costata Silvestri, 1904, Atti della Pont. Acc. Rom. dei Nuovi lincei Lincei, anno lvii, p. 142, woodcuts 3, a-d.

V. costata Chapman, 1907, Rec. For. Victoria, p. 130, pl. 9, fig. 10.

The three specimens found agree best, as regards outline, with Chapman's figure in the above reference. They are in good condition. The sutures appear to be limbate. The initial chamber is inflated, but when viewed with the light falling directly down the test it has the appearance of being grooved (see fig. 4).

Chapman and Silvestri bring *V. patens* Brady under *V. costata* Cornuel, and my examples appear to me to be nearer to theirs than to Brady's *V. patens*. In my cabinet I have two specimens from Raine Island, which have the sides of the test more nearly parallel than those of the "Challenger" examples.

Vagulina rheophagica sp. n. (Pl. V, figs. 6, 7.)

Test elongate, slightly compressed and curved. Each segment bears four costæ, two on either side. The segments appear to be bottle-

shaped, with rounded base and produced neck. The neck of each segment is longer than that of the one preceding it. Each segment is fitted on to the back of the preceding one in such a manner as to conceal the produced neck of the latter when viewed from the back of the test. On the lateral sides of the initial chamber there is a short costa. Sutures oblique and deeply sunk, orifice marginal.

Only one occurs. In some respects the specimen bears a resemblance to Chapman's *Vaginulina neocomiana*, Quart. Journ. Geo. Soc., 1894, p. 711. pl. xxxiv., figs. 10, 11, but the description of his species shows that there are marked differences between the two forms.

Cristellaria Lamarck.

Cristellaria crepidula (Fichtel and Moll).

Nautilus crepidula Fichtel and Moll, 1803, Test. Micr., p. 107, pl. xix, figs. g-i.

Cristellaria crepidula d'Orbigny, 1839, Foram. Cuba, p. 64, pl. viii, figs. 17, 18.

C. crepidula Flint, 1899, Rept. U.S. Nat. Mus. for 1897 (1899), p. 316, pl. lxiii, fig. 2.

There are twenty-two tests, which I have brought together under the above heading. They are small, with the exception of two or three. Several are typical. One clearly resembles *C. crepidula* d'Orbigny in the above reference, but has fewer chambers. Intermediate forms are present, linking this species to *C. schloenbachi* Reuss, 1862, Sitzungsab. d. k. Ak. Wiss. Wien., vol. xlvi, p. 65, pl. vi, figs. 14, 15.

Cristellaria tenuis (Bornemann).

Marginulina tenuis Bornemann, 1855, Zeitschr. d. deutsch. geol. Gesellsch., vol. vii, p. 326, pl. xiii, fig. 14.

C. tenuis Brady, 1884, Chall. Rept., p. 535, pl. lxvi, figs. 21-23.

C. tenuis Flint, 1899, Rept. U.S. Nat. Mus. for 1897 (1899), p. 315, pl. lxi, fig. 2.

A single, excellent example.

Cristellaria latifrons Brady.

Cristellaria latifrons Brady, 1884, Chall. Rept., p. 544, pl. lxviii, fig. 19; and pl. cxiii, fig. 11.

The two tests found are not typical; they are more compressed than the type-form. One has the orifice at the end of a produced neck, and the other has probably been in the same condition, but it is fractured. They represent, I think, a weak form of the above species.

I have typical examples of this rare species from Cebu, Philippine Islands, 120 fms.

Cristellaria variabilis Reuss. (Pl. V, fig. 8.)

Cristellaria variabilis Reuss, 1850, Denkschr. d. k. Akad. Wiss. Wien., vol. i, p. 369, pl. xlvi, figs. 15, 16.

C. variabilis Brady, 1884, Chall. Rept., p. 541, pl. lxxviii, figs. 11-16.

C. variabilis Heron-Allen and Earland, 1916, Foram. West of Scotland, Trans. Linn. Soc. London, vol. xi, pt. 13, p. 263.

Beautiful specimens occur, both in the young and adult stage. The carinate variety is similar to the "Challenger" examples. The non-carinate is elongate and much narrower than the other variety, also the initial portion is smaller. This may possibly be the microspheric form. Twelve of the carinate and nine of the non-carinate variety were found.

Cristellaria articulata Reuss.

Robulina articulata Reuss, 1863, Sitzungsab. d. k. Akad. Wiss. Wien., vol. xlviii, p. 53, pl. v, fig. 62.

Cristellaria articulata Reuss, 1870, Sitzungsab. d. k. Akad. Wiss. Wien., vol. xlvi, p. 483; Schlicht, Foram. Pietzpuhl., 1870, pl. xvii, figs. 5-12.

C. articulata Brady, 1884, Chall. Rept., p. 547, pl. lxxix, figs. 1-4, 10-12.

One only found, and it is of the wild, growing variety, having two angular chambers in the linear series. The specimen is small and carries a small keel as far as the commencement of the upright chambers.

Cristellaria acutaureolaris (Fichtel and Moll).

"*Hammonia subrotunda*," etc., Soldani, 1879, Testaceographia, vol. i, pt. i, p. 61, pl. xlix, fig. x.

Nautilus acutaureolaris Fichtel and Moll, 1803, Test. Micr., p. 102, pl. xviii, figs. g-i.

Cristellaria acutaureolaris Flint, 1899, Rept. U.S. Nat. Mus., for 1897, p. 316, pl. lxxiii, fig. 5.

Three occur. The smallest is near to the "Challenger" figure, the other two are broader and more heavily built.

Cristellaria dentata Karrer(?). (Pl. V, fig. 9.)

Cristellaria dentata Karrer, 1867, Sitzungsab. d. k. Ak. Wiss. Wien., vol. lv, p. 348, pl. i, fig. 1.

C. dentata Brady, 1884, Chall. Rept., p. 540, pl. cxiii, fig. 12.

Although my drawing bears a strong likeness to Chapman's *C. tricarinella*, 1909, Rept. Foram. Sub-antarctic Islands, New Zealand, p. 343, pl. xvi, fig. 3, it seems to me to be better placed under *C. dentata*, with a query against it. The test, however, is keelless, and may be an immature specimen. Except in the matter of the keel, it agrees almost perfectly with Brady's "Challenger" figure of *C. dentata*. The test is not flattened as in *C. tricarinella*, and when placed alongside of the many fine specimens I possess of the "Challenger" form of *C. tricarinella*, it can be seen at once that it differs from them in many respects.

Cristellaria echinata (d'Orbigny).

"*Nautili echinati sive Papilloso, & circumradiati*" Soldani, 1780, Saggio Oritt., p. 98, pl. i, fig. 6.; 1789, Testaceographia, vol. i, pt. i, p. 65, pl. lix, figs. qq, rr.

Cristellaria echinata Brady, 1884, Chall. Rept., p. 554, pl. lxxi, figs. 1-3.

One small example in poor condition.

Cristellaria convergens Bornemann.

Cristellaria convergens Bornemann, 1855, Zeitschr. d. deutsch. geol. Gesellsch., vol. vii, p. 327, pl. xiii, figs. 16, 17.

C. convergens Brady, 1884, Chall. Rept., p. 546, pl. lxix, figs. 6, 7.

One specimen is typical, and the other has a tendency towards *C. gibba* d'Orbigny.

Cristellaria rotulata (Lamarck).

Lenticulites rotulata Lamarck, 1804, Ann. Mus., vol. v, p. 188, No. 3; and 1806, vol. viii, pl. lxii, fig. 11.

Cristellaria rotulata Brady, 1884, Chall. Rept., p. 547, pl. lxix, fig. 13.

A few occur. They are rather stoutly built.

Cristellaria cultrata (Montfort).

Robulus cultratus Montfort, 1808, Conchyl. Systém, vol. i, p. 214, 54^e genre.

Cristellaria cultrata Brady, 1884, Chall. Rept., p. 550, pl. lxx, figs. 4-8.

Excellent examples occur. A few have a tendency towards *C. orbicularis* (d'Orbigny).

There is one magnificent specimen, measuring about three-sixteenths of an inch in diameter.

Cristellaria orbicularis (d'Orbigny).

Robulina orbicularis d'Orbigny, 1826, Ann. Sci. Nat., vol. vii, p. 288, pl. xv, figs. 8, 9.

R. imperatoria d'Orbigny, 1846, For. Foss. Vien., p. 104, pl. 5, figs. 5, 6.

Cristellaria orbicularis Brady, 1884, Chall. Rept., p. 549, pl. lxix, fig. 17.

A single example.

Cristellaria crassa d'Orbigny.

Cristellaria crassa d'Orbigny, 1846, For. Foss. Vien., p. 90, pl. iv, figs. 1-3.

C. crassa Brady, 1884, Chall. Rept., p. 549, pl. lxx, fig. 1.

This solitary specimen is not typical, but, judging by the number of chambers and the thickness of the test, it appears to be nearer to *C. crassa* than to *C. gibba*.

Amphicoryne Schlumberger.*Amphicoryne bradyi* (Silvestri).

"Intermediate specimen with Vaguline commencement and final Nodosarian chamber," Brady, 1884, Chall. Rept., explanation of plate, pl. lxvi, fig. 20.

- Nodosariopsis bradii* A. Silvestri, 1902, Atti Accad. Pontif. Nuovi Lincei, anno lv, p. 53.
Amphicoryne bradyi Millett, 1898, etc., Foram. Malay Archipelago, Journ. Roy. Micr. Soc., 1903, p. 260, pl. v, fig. 3.

Three typical tests occur. The spines on the final chamber are conspicuous.

Sub-family Polymorphininae.

Polymorphina d'Orbigny.

Polymorphina amygdaloides (Reuss).

- Globulina amygdaloides* Reuss, 1851, Zeitschr. deutsch. geol. Gesell, vol. iii, p. 82, pl. vi, fig. 47.
Polymorphina amygdaloides Reuss, 1855, Sitzungsber. k. Akad. Wiss. Wien, vol. xviii, p. 250, pl. viii, fig. 84.

One found.

Polymorphina lactea, var. *oblonga* Williamson.

- Polymorphina lactea* (W. and J.), var. *oblonga* Williamson, 1858, Rec. Foram. Gt. Britain, p. 71, pl. vi, fig. 149.

Four occur, three of which are small.

Polymorphina regina Brady, Parker and Jones.

- Polymorphina regina* Brady, Parker and Jones, 1870, Trans. Linn. Soc., vol. xxvii, p. 241, pl. xli, fig. 32.
P. regina Brady, 1884, Chall. Rept., p. 571, pl. lxxiii, figs. 11-13.

A single, small specimen.

Polymorphina acuminata (d'Orbigny). (Pl. V, figs. 10-11.)

- Pyrulina acuminata* d'Orbigny, 1840, Mém. Soc. Géol. Fr., vol. iv, p. 43, pl. iv, figs. 18, 19.
Atractolina, sp. von Schlicht, 1869, Foram. Septar. Pietzpuhl, p. 70, No. 397, pl. xxv, figs. 9, 10.
Pyrulina, sp. id. *ibid.*, No. 422, pl. xxv, fig. 53.
Polymorphina acuminata Brady, Parker and Jones, 1870, Trans. Linn. Soc., vol. xxvii, p. 219, pl. xxxix, fig. 4.

There are eight tests on the slide, and, although not quite typical, I think they may be brought under the above heading. All are pointed at the base, except one, which happens to be fractured, and four taper to a point at the upper portion of the shell. They are, however, not so symmetrically built up as in the type-form. With two exceptions, the way in which the final chamber is set on causes the test to be slightly lopsided.

It is possible that this variety may be related to some of the forms which are more or less pointed at both ends, and figured in von Schlicht's work. Brady, Parker, and Jones state in the above

reference that "although it is probable that *P. acuminata* might be found wherever *P. gutta* occurs, it is, so far as our present knowledge goes, a rare species, and, like its close ally, unknown in a recent condition." It may be that the former is the microspheric and the latter the megalospheric form.

Polymorphina gutta d'Orbigny. (Pl. V, fig. 12.)

Polymorphina (*Pyrulina*) *gutta* d'Orbigny, 1826, Ann. Sci. Nat., vol. vii, p. 267, No. 28, pl. xii, figs. 5, 6, Modèle No. 30.

P. gutta Jones, Parker and Brady, 1866, Monogr. Crag. Foram. Pal. Soc., vol. xix, p. 256, pl. i, figs. 46, 47.

Rostrolina, sp. von Schlicht, 1869, Foram. Septar. Pietzpuhl., p. 72, Nos. 408, 409, 411, pl. xxvi, figs. 1-6, 10-12.

Pyrulina, sp. id. ibid, Nos. 423, 424, pl. xxv, figs. 55, 56; pl. xxvii, figs. 13-15.

Polymorphina gutta Brady, Parker and Jones, 1870, Trans. Linn. Soc., vol. xxvii, p. 218, pl. xxxix, fig. 3.

If I am right as regards *P. acuminata*, most likely I am also right in putting these forms under *P. gutta*, as Brady, Parker and Jones speak of their probable association. There are four tests, two of which are rather stouter in build than the others.

Polymorphina, sp. *Fistula* form.

There is a single specimen of fair size. The inflated, fistulose chamber is roughly globular and spinous, with a few straight tubular processes also covered with minute spines. The body of the test, which is only half revealed, is nearly round in section; the chambers are only very slightly inflated, and they also bear numerous short, fine spines.

EXPLANATION OF PLATE V.

FIGS.

- 1 (?), 2, 3.—*Marginulina glabra* d'Orbigny. × 50.
- 4, 5.—*Vaginulina costata* (Cornuel). × 75.
- 6, 7.—*V. rheopagica* sp. n. Fig. 6, lateral view. Fig. 7, back view.
- 8.—*Cristellaria variabilis* Reuss. × 50. Non-carinate form.
- 9.—*C. dentata* Karrer (?). × 75.
- 10, 11.—*Polymorphina acuminata* d'Orbigny. × 50.
- 12.—*P. gutta* d'Orbigny. × 50.
- 13, 14.—*Polymorphina* (?) *complexa* Sidebottom. Fig. 14, oral view. × 50.
- 15, 16.—*Dimorphina millettii*. Fig. 16 is drawn from a Seychelles Island specimen. × 50.
- 17.—*D. lingulinoides* Millett. × 75.
- 18-22.—*D. nodosaria* d'Orbigny. × 50.
- 23.—*Uvigerina porrecta* Brady, var. *fimbriata* var. nov. × 75.
- 24.—*Sagrina columellaris* Brady. × 50.
- 25-27.—*Globigerina dutertrei* d'Orbigny (?) Fig. 25, superior view. Fig. 26, inferior view. Fig. 27, edge view. × 75.
- 28, 29.—*Spirillina denticulo-granulata* Chapman, var. Fig. 28, superior view. Fig. 29, inferior view. × 75.

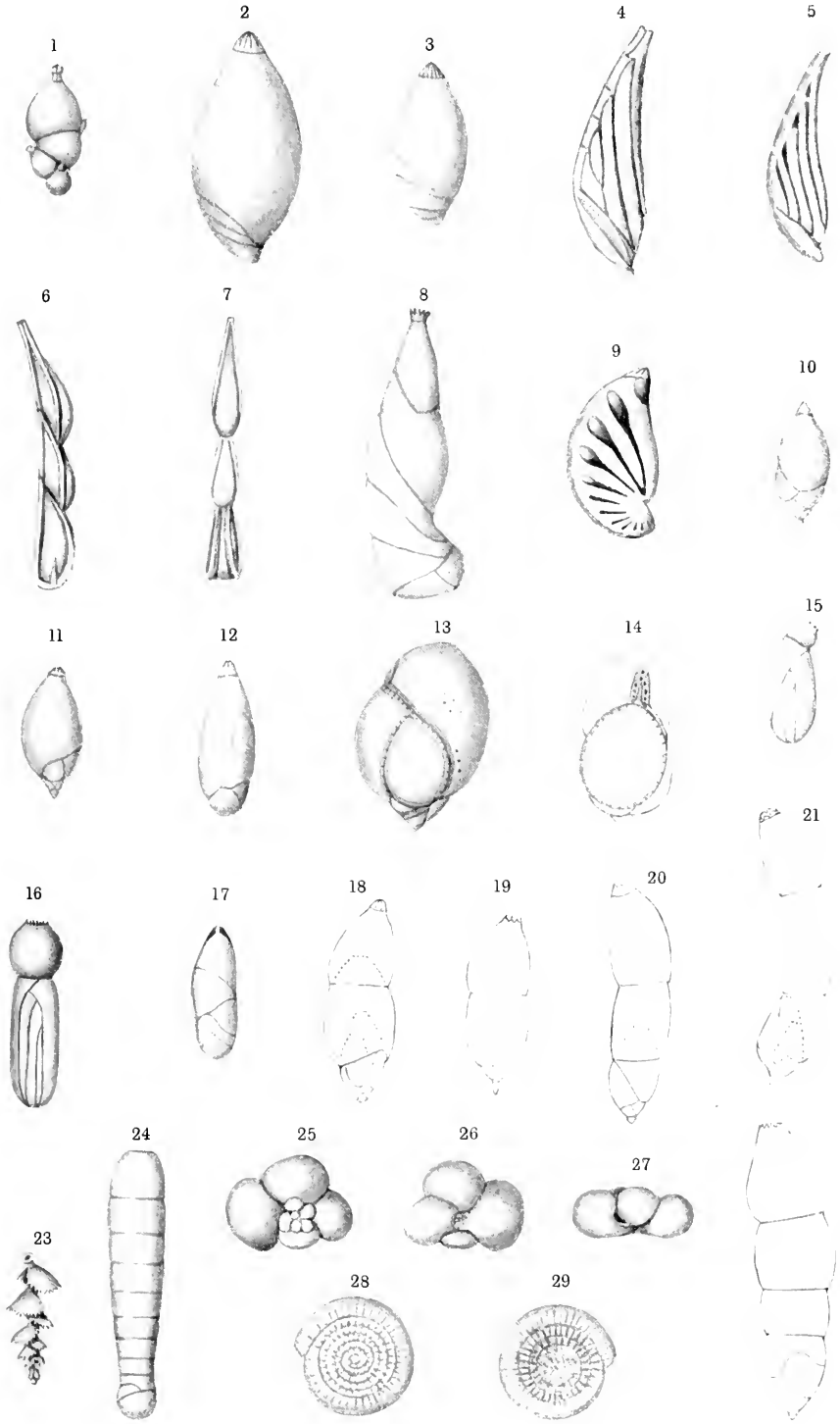

Polymorphina (?) *complexa* Sidebottom. (Pl. V, figs. 13, 14.)

Polymorphina (?) *complexa* Sidebottom, 1904-1909, Rept. Rec. Foram. Isl. Delos. Mem. Proc. Manchester Lit. Phil. Soc., 1907, vol. li, No. 9, p. 16, pl. iv, figs. 1-9, and p. 16, figs. in text, 3-7.

P. complexa Sidebottom, 1910, Rept. Rec. Foram. Bay of Palermo, Sicily, Mem. Proc. Lit. Phil. Soc. Manchester, vol. liv, No. 16, p. 22.

P. complexa Heron-Allen and Earland, 1915, Foram. Kerimba Archipelago, Trans. Zool. Soc. London, vol. xx, pt. xvii, p. 673, pl. li, figs. 1-3.

P. complexa Heron-Allen and Earland, 1916, Foram. South Coast, Cornwall, Journ. Roy. Micr. Soc., p. 48, pl. viii, figs. 5-7.

A solitary specimen, well-developed and typical. It is curious that single specimens of this species have been found at various localities, Heron-Allen and Earland reporting odd examples from four stations in the Kerimba Archipelago, and from the coast of Cornwall.

Dimorphina d'Orbigny.

Dimorphina millettii, sp. n. (Pl. V, figs. 15, 16.)

Polymorphina lactea, var. *oblonga* (Williamson), Millett, 1898, etc., Foram. Malay Archipelago, Journ. Roy. Micr. Soc., 1903, p. 262, pl. v, fig. 5.

With regard to this form, Millett writes in the above reference as follows:—"The example figured well represents the normal form with the exception that it possesses a supplementary chamber of a Nodosarian character. This is evidently a monstrosity, otherwise the specimen would have to be assigned to the genus *Dimorphina*. This chamber appears to have nothing in common with the fistulose extraneous growths so frequently found in the *Polymorphina* generally, but rare or unknown in the examples from the Malay Archipelago."

This solitary specimen has the added chamber bent to one side, as seen in fig. 15. I have broken the test, but luckily the drawing was made before the accident occurred. Fig. 16 is from a Seychelles Island specimen.

As I have also found four excellent examples from Mahé Harbour, Seychelles Islands, 14 fms., it is evident that this form is not a monstrosity, and must be assigned, as Millett said, to the genus *Dimorphina*, so I name it after my old friend.

Dimorphina lingulinoides Millett. (Pl. V, fig. 17.)

Dimorphina lingulinoides Millett, 1898, etc., Foram. Malay Archipelago, Journ. Roy. Micr. Soc., 1903, p. 266, pl. v, fig. 6.

D. (?) *lingulinoides* Chapman, 1910, Foram. Funifuti, Journ. Linn. Soc., vol. xxx, p. 414.

Except that the orifice is not quite typical, the specimen agrees well with Millett's description and figure. I think the aperture is a short slit, with the central opening slightly oval.

Dimorphina nodosaria d'Orbigny. (Pl. V, figs. 18-22.)

Dimorphina nodosaria d'Orbigny, 1846, Foram. Foss. Vienne, p. 221, pl. xii, figs. 21, 22.

The tests are in excellent condition, some of them quite transparent; but even in these latter ones I am not able to indicate in the drawings all the chambers of the polymorphine commencement. The specimens are curved and round in section, and all are in the microspheric condition. I am of opinion that they are closely related to, if not identical with, those I have described (and figured) under *Nodosaria radricula*, dentaline form. I have excellent examples of both forms from Darvel Bay, lat. 4° 11' N., long. 118° 37' E., 315 fms. Some of the specimens of the two forms are practically identical apart from the polymorphine commencement.

Uvigerina d'Orbigny.

Uvigerina pygmaea d'Orbigny.

Uvigerina pygmaea d'Orbigny, 1826, Ann. Sci. Nat., vol. vii, p. 269, pl. xii, figs. 8, 9, Modèle No. 67.

U. pygmaea Brady, 1884, Chall. Rept., p. 575, pl. lxxiv, type, figs. 11, 12; Elongate variety, figs. 13, 14.

Two or three are typical, the rest lying between *U. pygmaea* and *U. aculeata*.

Uvigerina aculeata d'Orbigny.

Uvigerina aculeata d'Orbigny, 1846, For. Foss. Vien, p. 191, pl. xi, figs. 27, 28.

U. aculeata Brady, 1884, Chall. Rept., p. 578, pl. lxxv, figs. 1, 2.

I have brought four specimens under this heading, three of which, however, have a tendency towards *U. pygmaea*.

Uvigerina asperula Czjzek.

Uvigerina asperula Czjzek, 1848, Haidinger's Naturwiss. Abhandl., vol. ii, p. 146, pl. xiii, figs. 14, 15.

U. asperula Brady, 1884, Chall. Rept., p. 578, pl. lxxv, figs. 6-8.

Two small examples. The spines are not well developed.

Uvigerina asperula, var. *ampullacea* Brady.

Uvigerina asperula, var. *ampullacea* Brady, 1884, Chall. Rept., p. 579, pl. lxxv, figs. 10, 11.

U. asperula, var. *ampullacea* Flint, 1899, Rept. U.S. Nat. Mus. for 1897 (1899), p. 320, pl. lxxviii, fig. 5.

Capital examples occur. Some of them are more drawn out than the "Challenger" specimens, and all have the earlier chambers more compact.

Uvigerina interrupta Brady.

Uvigerina interrupta Brady, 1879, Quart. Journ. Micr. Sci., N.S., vol. xix, p. 274, pl. viii, figs. 17, 18.

U. interrupta Brady, 1884, Chall. Rept., p. 580, pl. lxxv, figs. 12-14.

Seven typical tests occur.

Uvigerina angulosa Williamson.

Uvigerina angulosa Williamson, 1858, Rec. Foram. Gt. Britain, p. 67, pl. v, fig. 40.

U. angulosa Brady, 1884, Chall. Rept., p. 576, pl. lxxiv, figs. 15-18.

The examples are rather short, and the triangular contour of the tests is not pronounced.

Uvigerina angulosa, var. *spinipes* Brady.

Uvigerina spinipes Brady, 1881, Quart. Journ. Micr. Sci., vol. xxi, N.S., p. 64.

U. angulosa, var. *spinipes* Brady, 1884, Chall. Rept., p. 577, pl. lxxiv, figs. 19, 20.

The tests are more elongate and less angular than in the species previously mentioned, and they occur more frequently.

Uvigerina porrecta Brady.

Uvigerina porrecta Brady, 1879, Quart. Journ. Micr. Sci., vol. xix, N.S., p. 274, pl. viii, figs. 15, 16.

U. porrecta Brady, 1884, Chall. Rept., p. 577, pl. lxxiv, figs. 21-23.

A single example.

Uvigerina porrecta Brady, var. *fimbriata*, var. nov.
(Pl. V, fig. 23.)

Test elongate; earlier chambers biserial and compact; later chambers subspiral, more or less distinct, interrupted, and alternating irregularly. Peripheral edges of the chambers angular and minutely serrate; surface free from markings; aperture situated in a produced tubular neck with everted lip.

This is an interesting variation. The test is transparent, and smaller than the type-form. The chambers are free from surface decoration.

Rather rare. The species occurs in the Dimor Sea, Java, 50 fms., also rare.

Uvigerina auberiana d'Orbigny, var. *glabra* Millett.

Uvigerina auberiana d'Orbigny, var. *glabra* Millett, 1898, etc., Foram. Malay Archipelago, Journ. Roy. Micr. Soc. 1903, p. 268, pl. v, figs. 8, 9.

- U. auberiana* (d'Orbigny), var. *glabra* Sidebottom, 1904, etc., Rec. Foram. Isl. Delos, Mem. Proc. Manchester Lit. and Phil. Soc. 1908, p. 2, pl. i, figs. 5, 6.
- U. auberiana* (d'Orbigny), var. *glabra* Sidebottom, 1910, Foram. Bay of Palermo, id. *ibid.*, p. 23.
- U. auberiana*, var. *glabra* Heron-Allen and Earland, 1915, Foram. Kerimba Archipelago, pt. ii, Trans. Zool. Soc. London, vol. xx, pt. xvii, p. 674.

Short and long forms are present, the former being more stoutly built than the latter. Some of the specimens are slightly twisted, all are smooth.

Sagrina (d'Orbigny) Parker and Jones.

Sagrina columellaris Brady. (Pl. V, fig. 24.)

- Sagrina columellaris* Brady, 1881, Quart. Journ. Micr. Sci., N.S., vol. xxi, p. 64.
- S. columellaris* Brady, 1884, Chall. Rept., p. 581, pl. lxxv, figs. 15-17.
- Siphogerina glabra* Schlumberger, 1883, Feuille Jeunes Nat., p. 118, pl. iii, fig. 1.

Fine specimens; both of the megalospheric and microspheric forms are present. Those in the microspheric condition are more frequent, and have the commencement of the test flattened and turned to one side. The initial chamber of the megalospheric form is large, as shown in the figure. The specimens are semi-transparent and show the syphon.

Sagrina dimorpha Parker and Jones.

- Uvigerina* (*Sagrina*) *dimorpha* Parker and Jones, 1865, Phil. Trans., vol. clv, p. 420, pl. xviii, fig. 18.
- Sagrina dimorpha* Brady, 1884, Chall. Rept., p. 582, pl. lxxvi, figs. 1-3.

Typical and in good condition.

Sagrina raphanus Parker and Jones.

- Uvigerina* (*Sagrina*) *raphanus* Parker and Jones, 1865, Phil. Trans., vol. clv, p. 364, pl. xviii, figs. 16, 17.
- Sagrina raphanus* Brady, 1884, Chall. Rept., p. 585, pl. lxxv, figs. 21-24.

A single small example occurs.

Sagrina virgula Brady.

- Sagrina virgula* Brady, 1879, Quart. Journ. Micr. Sci., N.S., vol. xix, p. 275, pl. viii, figs. 19-21.
- S. virgula* Brady, 1884, Chall. Rept., p. 583, pl. lxxvi, figs. 4-10.
- S. virgula* Heron-Allen and Earland, 1915, Foram. Kerimba Archipelago, pt. ii, Trans. Zool. Soc. London, vol. xx, pt. xvii, p. 676, pl. li, figs. 4, 5.

Some of the specimens are well developed, but the uvigerine initial chambers are wanting.

Sub-family **Ramulininæ.**

Ramulina Rupert Jones.

Ramulina globulifera Brady.

Ramulina globulifera Brady, 1879, Quart. Journ. Micr. Sci., vol. xix., N.S., p. 272, pl. viii, figs. 32, 33.

R. globulifera Brady, 1884, Chall. Rept., p. 587, pl. lxxvi, fig. 22-28.

Three large fragments and a small one.

Family **GLOBIGERINIDÆ.**

Globigerina d'Orbigny.

Globigerina bulloides d'Orbigny.

Globigerina bulloides d'Orbigny, 1826, Ann. Sci. Nat., vol. vii, p. 277, No. 1. Modèles Nos. 17 and 76.

G. bulloides Brady, 1884, Chall. Rept., p. 593, pl. lxxvii, pl. lxxix, figs. 3-7.

The forms figured in the Chall. Rept. (pl. lxxix, figs. 5-7) are present. Besides these there are small tests similar to fig. 5, of a rosy tint. Two other tests have some coarse spines on the earlier chambers.

Globigerina rubra d'Orbigny.

Globigerina rubra d'Orbigny, 1839, Foram. Cuba, p. 82, pl. iv, figs. 12-14.

G. rubra Brady, 1884, Chall. Rept., p. 602, pl. lxxix, figs. 11-16.

None of the specimens show signs of the colour from which they take their name.

Globigerina helicina d'Orbigny.

Globigerina helicina d'Orbigny, 1826, Ann. Sci. Nat., vol. vii, p. 277, No. 5.

G. helicina Brady, Chall. Rept., p. 605, pl. lxxxi, figs. 4, 5.

G. helicina Sidebottom, 1904, etc., Rept. Rec. Foram. Isl. Delos, Mem. Proc. Manchester Lit. Phil. Soc., 1908, p. 4, pl. i, fig. 9.

Three capital examples of this unsatisfactory species.

Globigerina dubia Egger.

Globigerina dubia Egger, 1857, Neues Jahrb. für Min., p. 281, pl. ix, figs. 7-9.

G. dubia Brady, 1884, Chall. Rept., p. 595, pl. lxxix, fig. 17.

The tests are rather more flattened than the "Challenger" specimens.

Globigerina sacculifera Brady.

Globigerina sacculifera Brady, 1884, Chall. Rept., p. 604, pl. lxxx, figs. 11-17; pl. lxxxii, fig. 4.

The examples are good.

Globigerina digitata Brady.

Globigerina digitata Brady, 1879, Quart. Journ. Micr. Sci., vol. xix, N.S., p. 286.

G. digitata Brady, 1884, Chall. Rept., p. 599, pl. lxxx, figs. 6-10; pl. lxxxii, figs. 6, 7.

There are a few good examples of this beautiful form.

Globigerina conglobata Brady.

Globigerina conglobata Brady, 1879, Quart. Journ. Micr. Sci., N.S., vol. xix, p. 286.

G. conglobata Brady, 1884, Chall. Rept., p. 603, pl. lxxx, figs. 1-5; pl. lxxxii, fig. 5.

There are fine specimens of this thick-walled and coarsely perforated variety.

Globigerina acquilateralis Brady.

Globigerina acquilateralis Brady, 1879, Quart. Journ. Micr. Sci., N.S., vol. xix, p. 285.

G. acquilateralis Brady, 1884, Chall. Rept., p. 605, pl. lxxx, figs. 18-21.

Only a few specimens of this planospiral form.

Globigerina triloba Reuss.

Globigerina triloba Reuss, 1849-1850, Denkschr. d. k. Akad. Wiss. Wien, vol. i, p. 374, pl. xlvii, fig. 11.

G. bulloides, var. *triloba* Brady, 1884, Chall. Rept., p. 595, pl. lxxxix, figs. 1, 2; pl. lxxxix, figs. 2, 3.

Occurs occasionally.

Globigerina inflata d'Orbigny.

Globigerina inflata d'Orbigny, 1839, Foram. Cuba, p. 134, pl. ii, figs. 7, 9.

G. inflata Brady, 1884, Chall. Rept., p. 601, pl. lxxxix, figs. 8-10.

The examples are normal.

Globigerina dutertrei d'Orbigny.

Globigerina dutertrei d'Orbigny, 1839, Foram. Cuba, p. 84, pl. iv, figs. 19-21.

G. dutertrei Brady, 1884, Chall. Rept., p. 601, pl. lxxxix, fig. 1.

The tests are not quite typical, the final whorl consisting of only three or four chambers and the arched orifice (with one exception) being sealed up.

Globigerina dutertrei d'Orbigny (?). (Pl. V, figs. 25-27.)

Test much compressed, transparent, outline lobulated. Five chambers in final whorl.

I was, and am still, doubtful as to the identification of this variety. I submitted specimens to A. Earland, who thinks,

judging from the aperture, that they are young examples of *G. dutertrei*. They differ so much, however, from the specimens which I have placed under that name that I think it best to put a query after it. Twelve are on the slide.

Orbulina d'Orbigny.

Orbulina universa d'Orbigny.

Orbulina universa d'Orbigny, 1839, Foram. Cuba, p. 3, pl. i, fig. 1.
O. universa Brady, 1884, Chall. Rept., p. 608, pl. lxxxviii; pl. lxxxix, figs. 8-26; pl. lxxxii, figs. 1-3.

The examples are in good condition and well developed.

Hastigerina Wyville Thomson.

Hastigerina pelagica (d'Orbigny).

Nonionina pelagica d'Orbigny, 1843, Foram. Amér. Mérid., p. 27, pl. iii, figs. 13, 14.
Hastigerina pelagica Brady, 1884, Chall. Rept., p. 613, pl. lxxxiii, figs. 1-8.

Two occur, both bearing short spines.

Pullenia Parker and Jones.

Pullenia spheroides (d'Orbigny).

Nonionina spheroides d'Orbigny, 1826, Ann. Sci. Nat., vol. vii, p. 293, No. 1, Modèle No. 43.
Pullenia spheroides Brady, 1884, Chall. Rept., p. 615, pl. lxxxiv, figs. 12, 13.

Excellent examples, some of which have five chambers in the final whorl.

Pullenia quinqueloba Reuss.

Nonionina quinqueloba Reuss, 1851, Zeitschr. d. deutsch. geol. Gesellsch., vol. iii, p. 71, pl. v, fig. 31.
Pullenia quinqueloba Brady, 1884, Chall. Rept., p. 617, pl. lxxxiv, figs. 14, 15.

The number of chambers in the final whorl varies in the different specimens from four to seven.

Pullenia obliquiloculata Parker and Jones.

Pullenia obliquiloculata Parker and Jones, 1865, Phil. Trans., vol. clv, p. 368, pl. xix, fig. 4.
P. obliquiloculata Brady, 1884, Chall. Rept., p. 618, pl. lxxxiv, figs. 16-20.

The tests are typical and normal in size.

Sphaeroidina d'Orbigny.

Sphaeroidina bulloides d'Orbigny.

Sphaeroidina bulloides d'Orbigny, 1826, Ann. Sci. Nat., vol. vii, p. 267, No. 1, Modèle No. 65.
S. bulloides Brady, 1884, Chall. Rept., p. 620, pl. lxxxiv, figs. 1-7.

Rare, but normal.

Sphaeroidina dehiscens Parker and Jones.

Sphaeroidina dehiscens Parker and Jones, 1865, Phil. Trans., vol. clv
p. 369, pl. xix, fig. 5.

S. dehiscens Brady, 1884, Chall. Rept., p. 621, pl. lxxxiv, figs. 8-11.

Rare, but typical.

Candcina d'Orbigny.*Candcina nitida* d'Orbigny.

Candcina nitida d'Orbigny, 1839, Foram. Cuba, p. 108, pl. ii, figs. 27, 28.

C. nitida Brady, 1884, Chall. Rept., p. 622, pl. lxxxii, figs. 13-20.

Fair examples occur.

(To be continued.)

V.—*The Royal Microscopical Society during the Great War—
and After.*

Presidential Address, 1917-18.

By EDWARD HERON-ALLEN, F.L.S., F.G.S., F.Z.S., &c.

(*Read January 16, 1918.*)

ON the 17th of June in the year 1914 the Meetings of the Royal Microscopical Society were suspended as usual for the summer recess. To all outward seeming the whole world appeared to be passing through, or, more accurately speaking, to have arrived at a general condition of ease and peaceful luxury that had hitherto been unknown in its history. Indeed there were not lacking serious thinkers who saw, in the unprecedented luxury and competitive hedonism of the times, signs of the Writing on the Wall. The gradually increasing extravagance and lavish expenditure both in public and in private life, the apparently ever-decreasing influence of home and family ties, the almost frenetic pursuit of pleasure at all costs which was gradually permeating every class of society, gave cause for anxious thought, and occasion for ominous prophecy to the more far-seeing student of political and domestic economy. If a notable extravagance in dress, in amusements, in sports and in travel might be taken to be a proof of a firmly-founded national prosperity, we were living in a Golden Age—and if the gold rang sometimes false, and sometimes stood revealed as a gilding upon baser metal, the shadow seemed to satisfy the vast majority of the world's population as fully as a more real substance might have done.

It was only eleven days later—on the 28th—that, in the Bosnian capital, Sarajevo, the Archduke Francis Ferdinand, heir to the throne of Austria-Hungary, and his wife were assassinated. On that day the stone was flung upon the apparently placid waters of the world's prosperity, whose resultant ripples were destined to assume the proportions of a tidal wave that should eventually fall with shattering force upon the shores of the whole habitable universe.

We met again on the 21st October, and met as inhabitants of a world altered indeed, but, though dazed by the events which had crowded the fateful weeks since the 4th August, few of us, if any, would have admitted the possibility of the changes which were impending—and which are not yet fully developed. So full indeed

have been the months, which since then have lengthened into years of varying struggle, that it is not amiss sometimes to look back and recapitulate the events of those early days. The Retreat from Mons was already a thing of the past, and on the 6th September we had begun to breathe more fully with the commencement of the Battle of the Marne, followed by that of the Aisne on the 16th. But Antwerp had fallen on the 9th October, and the day before we met (on the 20th) Death had begun to ply his sickle with renewed fury in the flower of Britain's manhood at Ypres. We met, it seemed to me at the time, as it were, in an atmosphere of dream—of nightmare—for the opening acts of the German Army had fulfilled the promise of their Emperor to "stagger humanity." It seemed as though, with the savage and sacreligious humour that has distinguished many of his declarations, he was echoing the words put by Milton into the mouth of the Arch-Fiend:—

“ ‘Honour and Empire, with revenge enlarged
By conquering this new world, compels me now
To do what else, though damned, I should abhor.’
So spake the Fiend, and with Necessity,
The Tyrant's plea, excused his devilish deeds.”—(IV., 390).

Few of us probably remember to-day that on that 21st October we were to have held a *Conversazione*, one of a series that had bidden fair to go far towards consolidating both the social and scientific sides of our Society's activity. In the absence of our President, Dr. Sims Woodhead, I had the honour of presiding over the Meeting on this occasion, and it fell to me to announce the postponement of that *Conversazione*—few, if any of us, realized for how long. It was difficult to adumbrate at that time the extent to which the necessarily individual efforts of Fellows of the Society would or could be thrown into the struggle before us. It was for Dr. Woodhead to observe in the following January: "We go into this fight with a magnificent fighting force; to be efficient that force must be healthy. It must be well fed, it must be protected from disease, and its wounded must be well cared for. How much of the knowledge, the application of which ensures all this, do we owe to the Microscope?"

The ensuing three years were destined to be pregnant with circumstances in which the specialized knowledge of individual Fellows was to become of vital importance to the nation. I have no hesitation in saying that every such juncture has produced a Man. On that first occasion, before the scientific resources of the Empire had been sorted out, marshalled and organized, the Man was to the fore, and I look back to the fact with pride, as the first episode in our Society's grapple with forthcoming events. The Man was James Wilson Ogilvy, who came to the Council Meeting with a plan ready cut and dried, the successful execution of which

has produced results which only those in command of our Camps at home and abroad can estimate at their enormous value. He had already formulated his scheme to provide simply expressed Lectures and Demonstrations in our Camps; Lectures on Natural and Physical Science, and on the Medical and Hygienic problems which confront the soldier at every turn. We do not require to be reminded to-day of how the Young Men's Christian Association has "made good" in this War. When the History of the War comes to be written the historian will endorse every word of unstinted gratitude, admiration and praise—and they have been neither few nor far between—uttered by our Commanders, from successive Commanders-in-Chief down to the most harassed and obscure Company Officer. I wish that time would permit me to give a full abstract of Ogilvy's reports to the Y.M.C.A. on the work of his Microscopical Section, and I am proud to think that from this Chair it was my privilege to help him to set the ball rolling at our first Meeting during the War.

The first Fellow of the Society to respond to my announcement was Dr. Rudd Leeson, who with Mr. A. M. Allison as demonstrator, and J. W. Ogilvy as Chauffeur, paid a visit by motor car to Frensham Camp and delivered a lecture on "The Common Fly," after a journey the disastrous incidents of which fully entitle these gentlemen to honourable "mention in despatches." From this beginning, neither small nor unimportant, nor, I may say, devoid of personal bravery, sprang a series of lectures and demonstrations which in the following season reached the number of fifty-nine.

These demonstrations were given, not only in and near London, but far afield. In January 1916 Ogilvy had sixty-five active microscopists on his list, many of them having surpassed our allotted span of three score years of age; later the number was increased to seventy-nine, of whom only twenty-six had less than ten attendances to their credit. From October 1916 to May 1917, 188 exhibitions were held, and 89 lectures delivered. This last Easter twenty-one of Ogilvy's Band visited the Camp on Salisbury Plain and in three days gave twenty-five Exhibitions and delivered five lectures. All of his Band are not Fellows of this Society—we should welcome them all with honour—but I have made it my business to ascertain that among his workers are twenty-three Fellows of the Society, who have been responsible for 354 lectures and demonstrations.

In addition to this there have been as many or more lectures and demonstrations given by Microscopists who, though not Fellows of the Society, are such regular attendants at our Meetings that we almost count them as such.

That these demonstrations are of vital value needs no words of mine to impress. Almost every branch of science has been represented in their scope, the most important from a military point of

view being those dealing with medical and hygienic subjects in general and with venereal diseases in particular. We hear of one lecture upon Syphilis which was delivered at a camp near London, with immediately beneficial results, to an audience of between three and four hundred men. Lately Ogilvy has extended his activities among the Hostels for Mmunition Boys at Woolwich and elsewhere, and there is abundant resultant proof that these Scourges of the Army to which I have referred flourish almost entirely by reason of the ignorance of the men and boys with regard to the nature of the dangers to which they are exposed.

I have no hesitation in saying that even if no other Fellow of the Society had devoted his time and his knowledge to War work, the work of James Wilson Ogilvy is in itself a complete answer to those critics who have expressed the opinion that the Royal Microscopical Society "has not risen to the occasion."

So much for the outcome of the first Meeting of the Society during the War. Whilst that Meeting was in progress it is not too much to say that the Nation was passing through perhaps the most anxious moments that it has known since the War began. There seemed no reason to suppose on the 21st October, 1914, that the Germans would not reach Calais and occupy the northern French Ports—so imminent indeed was the danger that the inspired Press was telling us almost daily that these Ports were of no strategic importance, and that their loss would be, from a military point of view, a matter of no real moment. But a week later that terrifying advance was checked—at a terrible cost indeed, but checked definitely. By the end of the year, however, the War "had been brought home to us." On the day of our Meeting in December—the 16th—Hartlepool, Scarborough, and Whitby had been bombarded by the German Fleet, with a casualty list of 127 killed and 567 wounded. The Air Raids, with which we are now familiar, almost to the regrettable verge of contempt, had begun, tentative at first, but on the day before our January Meeting in 1915—the 19th—we had our first Zeppelin Raid on the East coast, and learned the opening words of a lesson destined later to be bitterly driven home, that the inhabitants of these Islands could be murdered from the air with comparative immunity to the murderers. Earlier in the month the world had been staggered by the Report of the Commission upon the Atrocities committed by the Germans in Belgium. On the day on which we met in February 1915 the Submarine Policy of Germany was declared, and we had experienced six months of a War which our optimists had declared could not last more than six weeks. I have often been reminded since then of a phrase of a modern novelist—R. W. Chambers—who, in describing one of his characters, observed, "He was a natural-born swindler, not only of other people, but of himself—in other words, an optimist."

It was, therefore, with feelings something akin to awe that we met on the 17th February to hear Dr. Sims Woodhead's Presidential Address "On some of the Microbiological Problems of the Present War." That address—reading it to-day in the light of later and bitter experiences—throws a significant light upon the then really commencing War-work of many of our most active and prominent Fellows. The President referred to the preventive inoculation against enteric fever associated with the name of our Fellow, Sir Almroth Wright, and dealt with the origin of, and remedies for, frost-bite, which by that time was looming large in the medical history of the War. He explained the rapid sterilization of water by the use of hypochlorous acid as a preventive of typhoid fever, cholera, and bacillary dysentery, and it is satisfactory to-day to reflect that some of the problems connected with the life-history of the meningococcus which he adumbrated have been solved by the researches of himself and his fellow-labourers.

The War-work of individual Fellows finds no published expression in our Transactions for that year for two obvious and unanswerable reasons. In the first place, the work of our Society's Fellows was primarily of a nature which could not be published during the War, and in the second, they had no time to write. We met from month to month, the dates of our Meetings being punctuated by great happenings which have formed landmarks in history. Air-raids by Zeppelin and Aeroplane had become "incidents of our job," as King Humbert remarked to his aide-de-camp, when he narrowly escaped assassination on the Pincian Hill. On the day of our March Meeting our blockade of Germany began; in April our casualties had reached the total of 140,000, and the Government had decided only the day before that universal military service was neither necessary nor desirable. When we met on the 19th of May, the world had been staggered again by a new feature in warfare—the use of poisonous gas at the front (and, in the opinion of some, of a considerable amount of "poison gas" at home), and by the sinking of the "Lusitania." But a few days before the Meeting we had decided to intern alien enemies in this country. Three days later Italy joined the Allies, in the midst of one of the most severe crises of the war.

During the recess of 1915 Bulgaria declared against us, Lord Selborne told us that the submarine menace "was well in hand," and by the time we meet on November 17th Serbia was virtually annihilated. The day of our December Meeting, the 15th, was marked by the retirement of Sir John French and the assumption of the command of our armies by Sir Douglas Haig; and General Townshend had retired to Kut-el-Amara.

On January the 19th in 1916 I occupied this Chair for the first time as President. Gallipoli had been evacuated, and Montenegro over-run, and I am informed that some of our critics have com-

plained that I did not pronounce for a programme of organized War-activity by the Society as a Society. Perhaps I may be allowed to reply after this interval of time that when I took this Chair I was already fully aware of the tremendous amount of work which was being done in devoted silence by all our best men ; I considered, and rightly as I still think, that it was no part of my duty as your President either to expose the activity of these workers, or to advertise the efforts of some who were pushing and pulling in various directions to reap personal advantage and renown from the turmoil of scientific and commercial activity which flung them, at intervals, to the surface of things. During the whole of that year, 1916, it will be remembered that our Meetings attained a numerical as well as a scientific importance, that contrasted vividly with the immediately antecedent period, and that we met always with the sensational reflection that our Meetings might be broken up, in more senses than one, by the attacks of hostile aircraft. In March the Battle of Verdun had entered upon its epoch-making course, and lasted through the year with fluctuating fortunes. When we met in May Kut-el-Amara had fallen ; and the grave problem, as yet unfortunately unsolved, of Irish disaffection and doubtful neutrality had introduced a new and disturbing factor. In June the Battle of Jutland had been fought, Lord Kitchener had perished at sea, and we parted for the recess, asking ourselves under what circumstances we should meet again. When we did meet again the Battle of the Somme had hardened the nation to grimmer effort, and Roumania had joined the Allies, only, alas ! to meet with disaster before the date of the November Meeting, by which date (the 15th) we ourselves on the Ancre, the French at Verdun, and the Italians on the Carso, had effected results which made our hearts beat higher with hope than had been the case for many a weary month.

In December we met under the Premiership of Mr. Lloyd George, but the day of our Meeting was punctuated by President Wilson's Peace Note, to which, by the time we met in January 1917, the Allies, sure of their powers to prevail in and to the end, had replied with no uncertain voice. By February our conviction of ultimate triumph had been strengthened by the intervention of the United States and the contribution of over a thousand millions of "new money" by the public to the sinews of war. In March we had begun to reap the fruits of these efforts ; Baghdad had fallen to our arms, and the German retreat had begun, but we met under the shadow of the Russian Revolution—on the 12th—which was destined to alter all preconceived plans, and sensibly modify the ultimate aims of the Allies.

The rest is modern history, and requires no recapitulation. Since that Meeting in March we have seen the entry of the United States into the War, with all its gigantic possibilities ; our advance in

Flanders; the collapse of Russia; the danger of Italy. But we meet to-day more hardened, more determined to win, to endure, to suffer, if necessary, than ever before; more convinced than ever before of the righteousness of our cause, and of the ultimate triumph of peaceful civilization, founded by, and reposing upon, the solidarity and the world-influence and power of the combined English-speaking race. More than ever to-day we can realize the fundamental truth expressed by Dr. Sims Woodhead in that Presidential Address to which I have already referred, when he said, "We had no alternative, we must fight or be content to see the weak trampled upon, the free fettered, liberty restricted, and brute force worshipped as a fetish by a nation hypnotized by the concentration of a self-conscious gaze upon its own intellectual achievements and material prosperity, and led, or misled, by a small, but powerful, if not intellectual, caste of self-seeking and overbearing Prussian militarists."

Meanwhile, it has become possible for some of the workers upon War-problems to publish to the world a certain portion of their results, and the Transactions of the Royal Microscopical Society afford significant evidence of the work that has been done. At our February Meeting, Dr. Cropper exhibited to the Society the results of his work upon dysenteric cysts; in March, Mr. (now Sir) Kenneth W. Goadby read a paper on the "Bacteriology of Septic War Wounds"; in April, Dr. Hort read a remarkable—if controversial—paper on the "Life-history of the Meningococcus." These are papers, to which we have given the considered and deliberate authority of publication in our Journal, on departments of War-work that can properly be published during the War. But I ask you to reflect for a moment upon the other—the as yet unwritten papers, dealing with even more important War-work for which Fellows of this Society are responsible. With a view to confuting the *obiter dicta* of some of our critics, I have made it my duty to follow the activities of many of our Fellows, and I deeply regret that at the present moment of time it is not permissible to do more than hint—and often not even that—at work to which we shall be able proudly to look back after the War. We all know—often to our inconvenience and cost—the widespread and jealous powers of the Defence of the Realm Act, referred to by its irreverent critics as "Dora." This pragmatistical Force, as well as the sense of decency and becoming modesty of the most important workers, prohibits more than a passing reference to the real and solid work of the Society during the War, but we may hope that the day is not far distant when the lips of our working Fellows will be unsealed, and we shall be enabled to make revelations which must, and will, deeply impress the scientific world.

At this juncture it has seemed to me that it would not be uninteresting to make a detailed examination into the effect of the War

upon the main feature of our Journal—the Abstracts of Current Researches which give to it a world-wide value—and for this purpose I have, with the help of the Assistant Secretary, analyzed the figures since 1900. The results of this analysis are printed *in extenso* as an Appendix to this Address.

From this document of record it will be seen that from the year 1900, up to and including 1913, the Society published abstracts of 21,295 papers dealing with researches primarily dependent upon Microscopic Manipulation and Technique, an average of 1,638 in every year, and made up as follows:—

Vertebrata	3019
Invertebrata	5723
Botany	8500
Microscopy	3286
Metallurgy	817
		<hr/>
		21,295

During the four years affected by the War (though perhaps the effect of the War should not have been seriously felt before 1915) the Society published abstracts of 3925 papers, an average of 981 in each year, made up as follows:—

Vertebrata	599
Invertebrata	1224
Botany	1500
Microscopy	391
Metallurgy	211
		<hr/>
		3925

This gives us a total of 25,220 papers abstracted in our Journal since the beginning of the Twentieth Century.

This reduction in the number of abstracts since 1913 is, however, not so significant of War conditions as would appear at first sight to be the case. In that year it had been decided to reduce the number of published abstracts for several reasons, principal among them being that many Societies were by that time publishing abstracts of papers dealing with the microscopical side of the subjects especially included in the scope of their work. In that year, 1913, accordingly, the number of abstracts—excluding Microscopy and Metallurgy—fell to 855, and in 1914 numbered 863. It will therefore be observed by a reference to the Table that since the beginning of the War such abstracts have only fallen off on an average by about 20 or 30 per annum, which speaks well for the activity of our Abstractors, regard being had to the increased difficulty in obtaining the foreign journals which afforded a major portion of the material submitted to them. It will be observed that the most noticeable falling off is in the number of papers abstracted dealing with pure Microscopy and

Metallurgy, but this is readily explained by the national, and for obvious reasons unpublishable, nature of researches in Technical Optics and Metallurgy and their application during the War, practically the whole work of labourers in these fields of Science having been devoted to the solution of problems arising out of the War itself. We may properly look forward to the publication of a great body of work in these directions as soon as circumstances will permit. I think it a matter for sincere self-congratulation that, in spite of the difficulties to which I have referred and of the fact that our Abstractors have had unprecedented calls made upon their time, this feature of our Journal has been maintained at such a high level of quantitative and qualitative excellence. That the War should have so little affected the work of the Society in this respect is, in itself, an answer to those who suggest—from insufficient knowledge—that we have not “risen to the occasion.” We have not required or condescended to fall back upon one of the most prominent curses of the War—the War Excuse. A recent writer has said :—“The war has given a great and grievous fillip to that most pitiful of all prevarications—the Excuse. . . . War is the super-excuse, the quibble democratic, the ubiquitous ululation of inefficiency. . . . On the face of it, we might reasonably suppose that it would be those who are taking an active part in the War that would be most in need of its Excuse. Yet the word for them has gone right out of the Dictionary. They are busy enough to do without it, . . . but to those who are comfortably sheltered, or comparatively immune from the dangers and discomforts of these times, the word is a veritable leaning-post—a loll-wall against which their shortcomings can lounge luxuriously and till all is blue.”

I repeat that I very deeply regret that I am unable to give you precise and concrete details of the War-work of many individual Fellows of the Society, but this is impossible again for two major reasons. In the first place, a recital in the shortest form of such activities would constitute a volume of matter far beyond the limits of time and space allowable to a Presidential Address. In the second, however communicative our Fellows may be under normal social conditions, an enquiry as to the details of the work they are known to be engaged upon has the instantaneous effect in almost all cases of inducing a condition akin to aphasia. You might just as well ask a soldier home on leave why he got the Military Cross, the Distinguished Service Order, or any other meritorious decoration ; their answer takes only two forms—in my experience—it is either “I don’t know” or “Just for walking about.” It is therefore only by lucky happening upon a paragraph or article in some technical or scientific journal that one learns that some Fellow of the Society has executed some work of supreme national importance. The day may come when Professor Benjamin Moore

will tell us at first hand how, by deliberately poisoning himself with Trinitrotoluene he acquired the primary stages of the too-often fatal Toxic Jaundice, which, in the early days, sorely afflicted our Munition workers, and so discovered not only the method of its acquirement but the means of its prevention and cure. There is consequently to-day no reason why those who handle high explosives should not do so with perfect immunity from any deleterious results. The work of Professor Plimmer, our penultimate President, upon the prevention and cure of Tetanus is at present (like the origin of Mr. Jeames Yellowplush) wrapped in insoluble mystery, but the day will come when it will prove a landmark in prophylactic medicine. There is other work associated with his name, the value of which is incalculable, but as to the nature of which it is not even permissible to drop a hint. The new department of Technical Optics which has come into being at the Imperial College of Science under our Fellow, Prof. F. J. Cheshire, as its first Director, is perhaps one of the most important outcomes of the War. It has entered upon its labours with every indication of a robust vitality, and I only regret that the series of Lectures being delivered before that body by our new President on Microscopic Technique, as well as those being delivered by our sometime Fellow, Prof. A. E. Conrady, Professor of Optical Design in the Department, on the Theory of the Microscope, are not being delivered from this platform, valuable—indeed essential—though they be in the place that has claimed them. We may hope, however, that the connexion of our new President with the Department will result in a co-ordination of the work of the Department and of this Society which cannot fail to be of benefit and advantage to both organizations, and to Science in general. It is a matter of common knowledge that our new President, Mr. J. E. Barnard, has practically devoted the whole of his time since 1914 as a member of the Medical Research Committee to the solution of optical problems connected with the War, the practical results of which have contributed in a hitherto unknown degree, because unpublishable, to the work of the Ministry of Munitions, and so to the efficiency of our fighting force. It must be quite unnecessary to refer to the great stress which War conditions have imposed upon nearly all of us in connexion with, and in addition to, our ordinary pre-War occupations—this alone amounts to a vast volume of essential War-work done by the Society, represented by volunteer work of all kinds: in organization, relief work, and that somewhat shadowy and misdirected sphere of usefulness vaguely described upon the hoardings as “National Service.” These are incidents of the War which, whilst contributing largely to the efficiency of the national machine, have necessarily militated against the progress of the purely scientific work of a large proportion of our most active Fellows.

Many of us have become members of the Volunteer Force, and, speaking from personal experience, those of us who have been selected to take commissioned rank in that force find that to do our duty properly to our companies and platoons makes consecutive and systematic research work an impossibility. Again, in this connexion, I may be allowed to paraphrase an opening sentence of Professor Sims Woodhead's Address, and say on my own behalf, that when I should have been continuing, or perhaps even completing, certain work on the nature and behaviour of the protoplasmic bodies of Foraminifera, the results of which I thought might be placed before you in the form of a Presidential Address this evening, I have had to devote much of my time and energy to military organization, and to that subject which is of paramount importance in the minds of many of us, the promotion of science teaching in schools, and the applications of pure and applied science to the industries both of war and peace in this country. I have felt that the position to which you elected me two years ago gave to my efforts in this direction an authority which they would otherwise have lacked, and that though my own work has had to suffer neglect, the opportunities which have been afforded me of speaking on all available occasions, as it were from this chair, upon this vital matter should not be, nor have they been, neglected.

Many of us have been at one or other of the Fronts, and though for the most part our ages have kept us from the fighting line, we have been able to render significant services to the Army. Among such I need only mention Dr. Singer, who has spent most of his time in one of the most "unhealthy" areas of the War. It is permissible to refer to our late President, now Colonel Sims Woodhead, who has returned from the charge of a great convalescent hospital at Tipperary to take up a post of great importance at Headquarters in London; and to our late Secretary, Dr. Shillington Scales, who, in addition to his normal X-ray and electro-therapeutical work, has developed during the War into the position of general handy-man, and substitute for medical colleagues called to the Front from the Cambridge hospitals. I would that it were politic or possible to speak of the work of Dr. Eyre, Professor Hewlett, Mr. Denne, Mr. Rheinberg, Mr. Pledge, Colonel Clibborn, and many others whose modesty, no less than the nature of their work, forbids me to do more than merely to mention their names, but whose industry during the War in various Government Departments is destined to live in the annals of this pan-clastic struggle in the cause of freedom, justice, and civilization.

The future is a word which it requires some courage to-day to pronounce. It is a subject which appears premature—in a new and ominous acceptation of the term—as never before in our history it has been premature, to discuss; but, amid the welter of change and event, it is not difficult to distinguish one or two points in

connexion with the future of the Royal Microscopical Society which are ripe for postulation if not for discussion. You have conferred upon me the honour of nomination, and of re-nomination, as your representative upon the Conjoint Board of Scientific Societies, a body whose labours constitute, in the opinion of many, perhaps the most important work of the Royal Society of Great Britain in the present War, and I have been afforded opportunities of observing in what direction some of the activities of that body seem most likely to develop. I think it is clear from the deliberations of the "Sub-Committee on the Catalogue of Scientific Literature," of which I have the honour to be a member, that the established Scientific Societies of this country will be asked to develop a policy of closer concentration upon the subjects which constitute the primary reasons—the *rationale*—of their existence; and each Society will be expected to become responsible for the record, the catalogue, and the index of the literature of its special subject. As far as the Royal Microscopical Society is concerned, the effect of this policy of concentration will probably be most marked in our Journal. I have already alluded to the contraction of our spheres of work dating from the year 1913. I think that that contraction must, in the future, from the nature of things, become more pronounced. There is a widely felt, and widely expressed, opinion, that the work of many Societies, and, consequently the subjects dealt with in their publications, overlap. In years gone by, when the possession of a microscope and a knowledge of its technique and application to scientific research may almost be said to have constituted a science by itself, there was no branch of microscopical research which was not essentially and of itself a field for our especial enquiry and record. It is to enunciate the baldest of truisms to say that those times have changed. The microscope, which has properly been described as the most important of all optical instruments, and the one for which there is the greatest commercial demand, has become almost as universal a tool as the scissors; it enters into the daily life of all scientific laboratories and of all trades, from that of the protozoologist to that of the linen-draper. It becomes, therefore, daily and hourly more apparent that the results of microscopic manipulation tend to become decentralized, and that most of the subjects which naturally found a place in our Journal in the first half-century of its existence, are, at the present day, amply and fully discussed in the publications of other Societies founded for the promotion of special—perhaps somewhat over-specialized—branches of science. The science of Technical Optics, to which allusion has been made, has become a concrete entity, of which all that appertains to theoretical microscopy and microscopic technique is only a branch, but a branch which possesses an importance equalled by few and excelled by none other. I cannot help thinking that in the future we shall have to

concentrate still farther, and to devote our pages to the record, catalogue, and index, primarily, of the progress and development of the instrument itself, the methods of its application to every branch of science, and to the highly technical problems connected with that progress and development, and with those methods.

I have heard the opinion expressed at the meetings of the Catalogue Sub-Committee of the Conjoint Board that our records are not of themselves such as to demand a separate section in the Catalogue of Scientific Literature: to take a concrete instance, that the record of a new method of observation such as a development in the polarization of rock-sections, or even the remarkable results of Mr. J. E. Barnard's work in connexion with the examination of the internal structure of the Foraminifera by means of the X-rays, should be included in the sections of the Catalogue devoted to Mineralogy, Zoology, or Palæontology. With this view I entirely disagree, and against it I have consistently fought, and am persistently fighting. Workers, in whatever the branch of science that may be in question, wishing to know what has been done towards the perfection of manipulative methods, must be able to see at a glance what has been, and what can be, done by a reference to the index of our Journal. It is idle to suggest that they must search the indices of every scientific journal to see whether any technical process has been described which may be applicable to the problem immediately before them. The proper—and only—place which is clearly indicated as the storehouse of the records of such facts is the Journal of the Royal Microscopical Society. I agree that a new fact in relation to rock-structure, discovered by the ability and manipulative skill of a worker making use of established methods, may properly be relegated to the Journal of the Mineralogical Society; but a new fact resulting from the use of a new optical combination, or method of illumination, belongs to us, and to our journal, for the reason—if for no other—that the new process may, and probably will, be applicable to research in directions very far removed from the study of minerals.

Not to labour the point—which might indeed be pressed by object-lessons derived from every branch of research—I return to the main question, the future of our Journal. I cannot help thinking that we shall best justify our continued existence as a separate Scientific Society by sparing no efforts to keep track of, and to record, the progress of Microscopic Technique, the development and improvement of the instrument and of its accessories, and the expert manipulation of the apparatus already existing, or destined to be called into existence by the necessities of progressive enquiry. In a word, upon the Zoological, Biological, and other branches of our work will rest the foundation of that sense of social good-fellowship and *camaraderie* which, in the main, holds

scientific societies together, and upon that foundation will arise the central fortress within which will be developed and protected, encouraged and recorded, the methods of microscopical research, and to which workers in all branches of science will fly when confronted with the technical difficulties inseparable from their work. The main object of our Journal in the future must, in my opinion, be the publication of the means, and not of the ends. The ends will find their proper place for publication in the journals of other societies.

You will observe that I have based the expression of my views on the future of our Society primarily upon the text of its Journal. But it is not only in our Journal that our future must express and justify itself; it is—of necessity in the first instance—in our active work, and in the proceedings at our Meetings. There are prominent Fellows of the Society who have shaken their heads at me dismally when I have adumbrated these views in the past; they have warned me that if the “Bug and Slug” men are asked to retire and leave the field to the “Brass and Glass” men, our Meetings will become so dull and technical that our President will be reduced—like the unsuccessful Theatrical Manager—to addressing his audience as “Respected Individual in the Pit.” But this is by no means a prospect to be seriously looked forward to as even remotely probable—for the “Brass and Glass” man cannot indulge in his beloved physical experiments and mathematics unless provided with material by the “Bug and Slug” man. Without going so far as the Technical Optician who asserted that the Diatomaceæ were created solely for the purpose of testing object-glasses, I do look forward to a happy combination of effort, when the Biological Fellow will be pouring out his woes of limitation on the sympathetic bosom of the Purely-optical Fellow, and the latter will be hailing with glee the difficulties of the former as providing him with new worlds to conquer, and new equations with which to overawe the mere research student.

One task which we have set before ourselves as a body corporate is especially of interest to me, and to its due performance I intend, as I announced at the February Meeting in 1916, to devote my special energies and all the resources at my command as soon as the conditions allow, and that is the Society’s authoritative History of the Microscope and Catalogue of the Society’s collection of instruments and apparatus. It will be within the recollection of Fellows that a committee of the Council—with power to add to the number—was formed for this purpose early in 1916 under the Chairmanship of Dr. Charles Singer, than whom there is no greater authority upon the subject living to-day. We have the material and the men, and the men have the energy and the enthusiasm required to bring the work to a successful issue. This work will be, when completed, a landmark in our history destined

to carry conviction of the value of our Society's energy throughout the length and breadth of the Scientific World.

In our new President—nominated, if I may be allowed to say so, in a lightning flash of prophetic inspiration by the Council, a nomination ratified by his election at your hands—we have the man above all others best fitted and equipped to grasp the helm which will direct the course of our Society's progress at this moment of departure along a specialized and strengthened line of endeavour. I believe that I may say—though I say it with all humility—that the experiment of electing to this Chair an enthusiast from the "Bug and Slug" section within the Society, has not resulted in any retrogression in our history; on the contrary some echoes of our work during the past two years have disturbed the serenity of several learned bodies—from the Royal Society downwards—which had fallen almost into the habit of forgetting our existence. I take it as a reward for any efforts I have made for the welfare and the development of the Society that you have repeated the experiment. You have elected an enthusiast from the "Brass and Glass" section within the Society, and under his cautious and capable influence I look forward to seeing the Society take the place which is ours by right—a place the importance of which it would be impossible to overestimate among the Scientific Societies of the whole world.

Gentlemen, I have done. My last words from this Chair have been spoken, and I will conclude with an expression of my conviction that both as a body corporate, and in our individual capacities as citizens of this great Empire, we shall go on to the end of the present strife, our mental vision fixed upon the dawn of better things, and, in the immortal words of Abraham Lincoln, "With malice towards none; with charity for all; with firmness in the right as God gives us to see the right—let us strive to finish the work we are in; to bind up this nation's wounds; to care for him who shall have borne the battle and for his widow and orphan; to do all which may achieve and cherish a just and lasting peace."

ANALYSIS OF THE SUMMARIES OF CURRENT RESEARCHES PUBLISHED IN THE JOURNAL OF THE ROYAL
MICROSCOPICAL SOCIETY SINCE 1900.

	1901	1902	1903	1904	1905	1906	1907	1908	1909	1910	1911	1912	1913	Section Totals	Class Totals	1914	1915	1916	1917	Sec- tion To- tals	Totals 1900- 1917	
<i>Vertebrata:</i>																						
Embryology	106	99	68	65	82	99	76	74	61	79	83	65	53	1,010		51	82	62	72	267		
Histology	56	45	50	48	68	51	49	51	30	55	53	80	55	691		66	40	34	31	171		
General	89	94	91	103	127	146	127	86	85	101	103	37	33	1,222		34	38	44	30	146		
Tunicata	16	6	6	6	10	9	8	12	9	4	1	5	4	96	3,019	7	6	2	—	15	599	3,618
<i>Invertebrata:</i>																						
Mollusca	14	12	16	2	3	1	1	3	1	3	1	8	—	63		1	2	1	4	8		
Cephalopoda	5	5	—	3	5	5	3	8	6	8	3	3	3	57		3	2	1	2	8		
Gastropoda	21	22	29	23	27	23	17	24	21	22	16	12	11	268		10	5	2	11	28		
Lamelibranchiata	8	10	10	13	12	9	18	10	9	8	10	9	5	131		9	5	2	5	21		
<i>Arthropoda:</i>																						
Insecta	77	73	107	98	108	110	118	94	88	107	94	83	49	1,206		61	85	85	96	327		
Myriopoda	11	12	8	3	—	5	5	4	8	7	7	1	2	73		2	1	1	1	5		
Prototracheata	5	3	2	—	2	3	—	—	—	—	—	—	—	21		4	2	—	1	7		
Arachnida	16	23	14	16	30	31	25	23	27	23	34	17	4	283		11	8	15	15	49		
Crustacea	38	36	31	35	51	56	54	56	57	62	47	26	35	584		26	27	36	37	126		
<i>Annulata:</i>																						
Nematohelminthes	43	25	25	29	42	41	34	25	47	44	34	23	12	424		14	21	21	19	75		
Platyhelminthes	9	10	9	9	19	22	20	10	24	25	23	20	19	219		25	12	20	25	82		
Incerte sedis	47	29	37	22	41	46	37	41	34	39	39	27	18	457		23	24	26	17	90		
Rotatoria	9	15	11	13	9	15	17	20	13	10	9	2	7	150		6	5	9	6	26		
Echinoderma	6	7	3	10	2	16	8	7	11	4	13	6	7	100		—	3	3	2	8		
Cœlenterea	18	16	10	22	26	17	17	23	24	22	22	21	12	250		12	20	11	11	54		
Porifera	24	23	27	25	31	38	40	43	50	55	46	26	11	439		24	20	22	24	90		
Protozoa	6	9	11	3	6	9	10	23	11	11	10	2	122		8	10	9	9	36			
	61	55	43	38	56	85	94	48	70	83	106	88	54	876	5,723	38	37	49	60	184	1224	6,947

<i>Botany:</i>																			
General	14	28	39	46	34	17	13	13	9	16	7	1	3	240	10	1	5	10	26
Structure	164	149	98	62	54	32	51	36	49	35	43	34	44	851	31	18	26	9	84
Physiology	143	92	55	33	46	31	27	21	23	13	20	7	—	511	3	—	—	4	7
<i>Cryptogams:</i>																			
Pteridophyta	28	39	17	22	16	50	62	50	90	103	84	56	37	654	28	30	23	23	104
Bryophyta	—	29	92	77	38	110	115	120	147	164	144	93	68	1,197	69	59	43	37	208
<i>Thallophyta:</i>																			
Algae	50	64	115	104	86	95	125	110	147	134	146	161	113	1,450	94	87	90	86	357
Fungi	95	153	272	191	184	161	149	145	165	179	175	161	122	2,152	115	87	103	143	448
Lichens	—	—	—	18	27	29	22	18	20	28	28	17	19	226	13	12	14	13	52
Mycetozoa	8	—	2	4	1	—	11	13	10	10	18	8	4	89	5	1	5	3	14
<i>Schizophyta:</i>																			
Schizomycetes	148	124	92	66	68	108	92	78	75	60	85	67	47	1,130	59	61	36	44	200
1335 1307 1390 1209 1311 1470 1445 1289 1424 1532 1514 1161 855 17,242 17,242 863 811 799 850 3323 3323 20,565																			
<i>Microscopy:</i>																			
Instruments and Acces-	53	71	69	55	94	64	83	81	58	55	56	60	40	839	33	20	9	17	79
ories																			
Photomicrography	12	21	17	12	13	14	10	11	13	12	16	10	2	163	4	3	5	4	16
Optics and Manipula-	2	7	23	23	27	20	25	16	10	27	11	11	14	216	3	6	5	4	18
tion																			
Miscellaneous	3	11	7	16	18	16	17	15	17	15	18	19	11	183	8	5	7	11	31
Technique	75	113	100	112	142	194	137	128	100	142	81	106	78	1,508	88	43	63	53	247
Miscellaneous	94	53	28	25	11	25	17	11	14	17	16	8	8	327	—	—	—	—	391
Metallography	—	—	18	25	45	56	93	116	27	145	145	78	69	817	96	56	29	30	211
239 276 262 268 350 389 382 378 239 413 343 292 222 4,053 4,053 232 133 118 119 602 602 4,655																			
Total 21,295																			
Totals 3925 25,220																			

VI.—On *Pyxidicula invisitata*, a Rhizopod new to Britain, and
Hedriocystis spinifera, a new Heliozoon.

By JAMES MEIKLE BROWN, B.Sc., F.L.S., F.C.S.

[Communicated by JOHN HOPKINSON, F.L.S., F.R.M.S.]

(Read April 17, 1918.)

ONE PLATE.

DURING the examination of material collected in different parts of the country for the purpose of studying the distribution of fresh-water Rhizopods, I have frequently come across small, inconspicuous species whose identity is difficult to determine, partly owing to their diminutive size and partly to their almost transparent nature. For these reasons it is also difficult to obtain a clear idea of their structure. Naturally these minute creatures are frequently overlooked.

Amongst such there commonly occurs a species of *Pyxidicula* which has not yet been reported as occurring in this country. It seems to be referable to the species *P. invisitata* Averintzeff, described very briefly in 1906 ("Arch. f. Protistenk.," Bd. viii. pp. 86-7).

Since the publication of that paper I have seen no further reference to this species. As it appears to be widely distributed in Britain, a fuller description of it should be of interest.

EXPLANATION OF PLATE.

Figs. 1-4.—*Pyxidicula invisitata* Averintzeff.

FIGS.

- 1.—Dorsal view of living animal.
- 2.—Transverse section of empty test.
- 3, 4.—Different forms of the marginal flanges. *p.v.*, pulsating vacuole; *fl.*, flange margin of test.

All $\times 1000$.

Figs. 5-7.—*Hedriocystis spinifera* Brown.

- 5.—Active individual. $\times 2400$.
- 6.—Portion of capsule, with spines. $\times 5000$.
- 7.—Portion of capsule and plasma, with nucleus and contractile vacuole. $\times 5000$.



1-1. PYXIDICULA INVISITATA.

5-7. HETEROCYSTIS SPINIFERA Sp. nov.

SUB-CLASS RHIZOPODA.

Order CONCHULINA.

Pyxidicula invisitata Averintzeff.

Test watch-glass shaped, often flattened dorsally, delicate, chitinous; middle region (disc) varying in colour from light yellow to dark brown; marginal region (flange) always lighter in colour and frequently almost colourless; middle region in surface-view punctate; marginal flange showing radial striations.

In transverse section the margin of the test appears to be double, owing to the flange being inserted above the edge of the disc, which is turned inwards slightly, thus contracting the mouth-aperture. Protoplasm greyish in colour, granular, containing numerous green and brown bodies (food-particles); nucleus indistinct (Averintzeff figures it with dark prominent central nucleolus); contractile vacuole usually single, prominent.

Diameter of test 25–50 μ , most often about 40 μ (Averintzeff gives 45–50 μ).

Habitat.—Wet moss and moorland pools.

Distribution.—Derbyshire, Westmorland, Cumberland, Inverness-shire, Argyllshire, Perthshire, Elginshire, Ross-shire.

It appears to be common, but is easily overlooked.

The margin of the test is distinctive. In dorsal view it appears as a transparent flange, as in *P. cymbalum* Penard. In optical section the edge of the darker disc shows a marginal thickening triangular in section, and from the two lower corners of the triangle arise an outer and an inner flange, the outer one being that seen from above, and the inner one being, perhaps, merely a continuation oral-wards of the disc. Some tests show the outer flange curved ventrally inwards, while others show both flanges curved together.

In surface-view the animal might easily be mistaken for a small specimen of *P. cymbalum*.

Amongst a quantity of damp moss from the Isle of May, Firth of Forth, and reported on in the "Scottish Naturalist" for 1912 (pp. 108–14), a small number of individuals of a minute Heliozoon related to *Hedriocystis reticulata* Penard ("Les Heliozoaires d'eau douce," 1904, p. 284) were discovered. They present sufficiently important differences from that species, however, to warrant regarding them as belonging to a new species.

SUB-CLASS HELIOZOA.

ORDER DESMOTHORACA.

Hedriocystis spinifera sp. n.

Capsule very minute, transparent, thin, colourless or of a pale yellow, spherical, having numerous facets more or less regularly polygonal, of usually five or six sides, with raised borders from the junction of many of which arise slender spines; no pedicel observed; body spherical, nearly filling the capsule; plasma bluish in colour, granular; nucleus single, placed sub-centrally; a single contractile vacuole normally present; pseudopodia long, radiating, straight, tenuous; habit solitary.

Diameter of capsule, 8–12 μ .

Habitat.—Wet moss.

Locality.—Isle of May, Scotland (Brown).

The other fresh-water members of this genus (*H. pellucida* H. & L., and *H. reticulata* Penard) are provided with a stalk or pedicel, but so far no individuals of this species have been found with this appendage. In collecting from a material like wet moss they may easily have been broken off.

In the well-known genus *Clathralina* the chitinous capsule is a reticulated framework, also spherical in shape, the openings in which are of such a comparatively large size that a mere latticework separates them from one another; but in the genus *Hedriocystis* the test is continuous, the pseudopodia passing through a minute pore in the centre of each facet. The presence of these pores can only be recognized when the animal is alive, by the pseudopodia emerging from them; but in specimens treated with sulphuric acid Penard observed small bubbles of gas escaping, by which their presence was indicated.

The capsules in this genus are so transparent and colourless that only the thickened portions can be distinguished.

The smaller size and the presence of spines at the angles of the facets of the capsule distinguish this species from *H. reticulata* Penard (about 25 μ diam.), which likewise has only been recorded from one locality in the British Isles, namely, Craigeaffie, Scotland (Brown, in "Scottish Naturalist," 1916).

H. pellucida H. & L. has not till now been recorded from the British Isles; it is distinguished by the small pore in each of the facets being surrounded by a conical boss or nipple.

Propagation by means of division taking place within the test has been observed in *H. reticulata*, but it is not known how the individuals so formed escape from the capsule.

The author is much indebted to Mr. G. H. Wailes for assistance in drawing up the descriptions of these species.



RICHARD GRAINGER HEBB, M.A., M.D.Camb., F.R.C.P.Lond.,
Consulting Physician and Physician Pathologist to the Westminster Hospital,
Secretary to the Royal Microscopical Society, 1898-1911. Editor of the 'Journal
of the Royal Microscopical Society,' 1902-1918.

OBITUARY.

RICHARD GRAINGER HEBB, M.A., M.D. Camb., F.R.C.P. Lond.

1848-1918.

Consulting Physician and Physician Pathologist to the
Westminster Hospital.

THE announcement of the death, on May 12, 1918, of Dr. R. G. Hebb brought a deep sense of personal loss to a wide circle of scientific colleagues and friends, felt with particular keenness by the Fellows of the Royal Microscopical Society, to whom Dr. Hebb had endeared himself by his tact and geniality, no less than by his erudition and intimate acquaintance with microscopical lore during the thirty-three years he had been connected with the Society.

His association with the Society was not only lengthy, it was particularly close and intimate. Elected an Ordinary Fellow in November, 1885, he was appointed a few years later to a seat on the Council, and soon became a powerful factor in guiding the deliberations of that body.

In 1892 he became co-Secretary with Dr. Dallinger, and for nearly twenty years he was virtually responsible for the conduct of the Society's affairs. After the resignation of Dallinger, in 1907, Hebb became in name, as he had long been in fact, the senior Secretary, and had as associate secretaries, first, Mr. Gordon, and subsequently F. Shillington Scales. In 1911 ill-health compelled him to resign his post, and he was elected a Vice-President. During the time he held office, Hebb proved himself an ideal Secretary, and the Society, which has lost a devoted officer, has hardly yet realized the extent of the debt it owes to his exertions.

But his work for the Society ante-dated his Fellowship by many months, for it was quite early in 1885 that the then Secretary, Sir Frank Crisp, who was engaged in re-organizing the Journal, enlisted Hebb's services on his staff, and henceforth he was a consistent and regular contributor, and personally prepared nearly all the abstracts dealing with "Technique" that appeared in its pages. On the death, in 1902, of A. W. Bennett—the Lecturer on Botany at St. Thomas's Hospital—Hebb succeeded to the editorship of the Society's Journal (a post which he continued to hold at

the time of his death), and by his strenuous exertions and the exertions he incited in the faithful band of contributors he gathered around him, he succeeded in raising the prestige of the Journal to a unique position, and constituted it a most valuable asset to the Society.

The first number of the Journal for which he was solely responsible was that for April, 1902, whilst the passing of the proofs for the present one occupied his latest working hours.

A graduate in Arts and Medicine of Cambridge, King's College Hospital shared with the University in fostering that keenness in Microscopy which occupied so large a share of his life's work. Pathology, both naked-eye and microscopical, early claimed his energies, and he was undoubtedly seen at his best in the post-mortem room or laboratory; but, at the same time, he was a sound clinical teacher, and made his mark in the Out-patient Department and in the wards of the Westminster Hospital—the staff of which he joined in 1888, and where for many years he held the dual posts of Physician and Physician Pathologist. He was also Pathologist to Queen Charlotte's Hospital.

In the Medical School of Westminster Hospital he held successively the posts of Lecturer in Forensic Medicine, in General Medicine, and finally in General Pathology. Some years ago he was appointed "Reader in Morbid Anatomy" in the re-constituted London University.

Dr. Hebb leaves behind him a widow, but no children, since his only daughter died a little over a year ago.

An appreciation written by a medical colleague, and which appeared in the "British Medical Journal" of May 29, contains the following paragraph, which so exactly describes the man and his work that we cannot refrain from quoting it:—

"Of his own work in pathology, none but those who worked with him will ever appreciate its worth; he wrote but little, though his experience was great and his memory very remarkable. His modesty was so ingrained that the value of his observations was discounted by a reluctance to publish that owed something also to a rather cynical sense of the fleeting value of many contributions to the professional press. . . . Scholar and gentleman, his teaching will long bear fruit in the work of generations of students who owe their fundamental ideas to him."

MISS ETHEL SARGANT, F.L.S., F.R.M.S.

It is with great regret we have to record the death of Miss Sargent, which occurred on January 16 after a brief illness, at the early age of fifty-four. By her death botanical science sustains a severe loss, as she had obtained a well-merited position amongst botanists.

Miss Sargent was educated at the North London Collegiate School and at Girton College, Cambridge; she took the two parts of the Natural Sciences Tripos in 1884 and 1885. In 1913 she was elected to an honorary fellowship of Girton College. She was the first woman to preside over a Section of the British Association—Section K at the Birmingham Meeting in 1913—and she was also the first woman to serve on the Council of the Linnean Society of London. Miss Sargent's earlier botanical work was chiefly cytological, and dealt with the formation of the sexual nuclei in *Lilium martagon*. These researches into the structure of the embryo-sac led at a later date to an interesting theory regarding the meaning of "double fertilization" in Angiosperms, on which subject she made a contribution to the "Annals of Botany" in 1900. She was a lady of some means, and established a private botanical laboratory, first at her mother's home at Reigate, and later at the "Old Rectory," Girton, Cambridge. Miss (now Dr.) Ethel N. Thomas was at this time her assistant, and together they did some very valuable work, chiefly on the anatomy of the bulbous Monocotyledons. This research led Miss Sargent to conclude that that group was derived from the Dicotyledons, as a result of an adaptation to a geophilous habit. At the British Association Meeting at Southport in 1903 Miss Sargent opened a discussion on the "Evolution of the Monocotyledons," in which she put forward her views on the subject.

Miss Sargent's most important research, and one which she made peculiarly her own, was the vascular anatomy of monocotyledonous seedlings. She applied microtome technique with great skill to the elucidation of the transition from root to stem in the hypocotyl, the extreme shortness of which in the majority of monocotyledonous seedlings renders the elucidation one of great difficulty. Her contributions on the anatomy of seedlings, and her well-known theory of the origin of the Monocotyledons, appeared in the "Annals of Botany." As President of Section K (British Association, 1913) she gave a masterly résumé of "The Development of Botanical Embryology since 1870."

Miss Sargent was elected F.R.M.S. in 1910.

A. W. SHEPPARD.

WILLIAM SIDNEY GIBBONS.

By the death of William Sidney Gibbons, of Melbourne, which occurred in July last, the Society loses one of its oldest Fellows, Gibbons' fellowship dating from 1858. The deceased gentleman was ninety-two years of age at the time of his death, which was the result of an accident. William Gibbons was a patriarch among Australian microscopists, having been one of the first to encourage the popular knowledge of microscopy in the early days of Victoria. In 1852 he was carrying on investigations into the adulteration of foods, and, like Hassall, he combined these researches, which came more particularly within the scope of his activities as an analytical chemist, with excursions into various branches of natural science. In 1856 the "Quarterly Journal of Microscopical Science" printed some notes of his on several points of microscopical manipulation, and figured a section-cutting instrument which was considered an improvement on those then in use. Later he contributed several papers on microscopical subjects to local journals, and in 1858 he furnished to the "Microscopical Transactions" a description of a new method of micrometry. This involved the use of a series of slips of card, one for each combination of powers. Laying one of these on the stage of the microscope, which was focussed on a stage micrometer, and observing the micrometer-image with one eye, and the card with the other, he marked off the micrometer-divisions on the card, which thus became a rule of one-hundredths or one-thousandths, so that whenever he wished to measure an object which he was observing with that combination, it was only necessary to lay the scale on the stage beside the object, and read off the measurement. The method had the advantage over all others of simplicity, and cost nothing, but, of course, was not suited for conditions requiring a high degree of accuracy.

Mr. Gibbons was mainly instrumental in founding, in the later fifties, the first microscopical society in Victoria, possibly in the British Colonies. This, which was quaintly named the "Microscopic Society of Victoria," was somewhat premature, and had but a short existence. In 1873 another attempt was made, and the "Microscopical Society of Victoria" was founded, Mr. Gibbons being one of the most prominent of its promoters. This Society survived till 1887, when it amalgamated with the Royal Society of Victoria.

Mr. Gibbons had long since retired from the active practice of his profession, and was little known to the younger generation of microscopists, but he retained his interest in science, and was present at a meeting of the Royal Society not long before his death.

W. M. BALE.

SUMMARY OF CURRENT RESEARCHES
RELATING TO
ZOOLOGY AND BOTANY
(PRINCIPALLY INVERTEBRATA AND CRYPTOGAMIA),
MICROSCOPY, ETC.*

ZOOLOGY.

VERTEBRATA.

a. Embryology. †

Germ-Cells of Armadillo. ‡—Aimee S. Vanneman has studied the germ-cells of *Tatusia novemcincta*, and finds that they are conspicuously large, and first discernible along the endodermic wall of the blastocyst, just preceding the primary bud-stages. They are extremely few in number. The active, embryonic germ-cells, however, probably do not arise until the time of the secondary bud-stage, appearing in the vicinity of each of the four embryonic areas.

During early primitive streak stages germ-cells are seen dividing, previous to pushing a way into the endoderm of the future gut region. After gaining entrance into the gut endoderm, the germ-cells are carried in the thickening intestinal wall as, during the somite stages, it rounds up to form a closed tube. By the time the embryo has attained a length of 4 mm., and has a pronounced cervical bend, the germ-cells may be seen in the act of leaving the ventral, intestinal wall to enter the surrounding mesenchyme tissue. They are amœboid.

In embryos of 5 and 6 mm., the germ-cells appear at the base of the well-developed mesentery, usually not below the level of the three blood-vessels of that region. They are also present in the loose mesenchyme under the aorta, and en route to the germinal epithelium which has not yet thickened.

In the 10 mm. embryo the germ-cells are established in the indifferent gonad. They are slightly enlarged, preparatory to division.

A study of early stages suggests that germ-cells may arise from

* The Society does not hold itself responsible for the views of the authors of the papers abstracted. The object of this part of the Journal is to present a summary of the papers *as actually published*, and to describe and illustrate Instruments, Apparatus, etc., which are either new or have not been previously described in this country.

† This section includes not only papers relating to Embryology properly so called, but also those dealing with Evolution, Development, Reproduction, and allied subjects.

‡ Amer. Journ. Anat., xxii. (1917) pp. 341-63 (3 pls. and 2 figs.).

certain cells of the blastocyst endoderm (yolk-sac endoderm) during secondary bud formation. The path of the migration is from the embryonic endoderm into the intestinal wall, thence into the surrounding mesenchyme to the mesentery, and onward into the germinal epithelium. No germ-cells are found at any stage in the blood-vessels. It may be concluded that the germ-cells of the four embryos of one vesicle do not have a common origin, in the sense of having arisen from a pre-localized region of the early blastocyst.

Maturation of Ovum in Swine.*—George W. Corner has studied the maturation phenomena in swine. This is the first case in which the maturation of the ova of an Ungulate has been observed. The sequence is the same as in previously-studied forms of other orders, the first polar body being extruded, and the second polar division proceeding as far as spindle formation before fertilization occurs, the second polar body being cut off only after the entrance of the spermatozoon.

Polyembryonic Blastocyst in Opossum.†—J. J. Patterson and C. G. Hartman describe a blastocyst of *Didelphys virginiana* which contained four embryos, three abnormal and one normal. The arrangement of these on the blastoderm suggests a certain similarity to the condition in the armadillo (*Tatusia novemcincta*), where four are normal. It is possible that the rare occurrence of multiple-embryo formation in *D. virginiana* has become a permanent phenomenon in the development of *D. marsupiales*, as reported by Bluntschli. In any case we have here the rare case of a polyembryonic blastocyst in a multiparous mammal.

Superfetation in Cat.‡—Mary T. Harman notes that the word "superfetation" has been used to denote that condition in which the uterus contains embryos of different degrees of development. This condition may result from a second coition, or a second conception may have taken place without a second coition. Although superfetation is rare and abnormal, many cases have been reported in man and in other mammals which do not seem to be satisfactorily explained, except on the supposition that a second conception has taken place. It is possible that all cases of superfetation are not attributable to the same cause. In the case of the cat described in this paper it seems as reasonable to think of the less advanced embryo of the four as the result of delayed fertilization, as to account for it on the ground of delayed development or a second coition.

Effect of Vital Stains on Eggs.§—Margaret Reed Lewis finds that the eggs of the Nemertean *Cerebratulus lacteus* may take up Janus green in their gelatinous membrane, and may thereafter develop up to the fourth or eighth cell-stage before they are killed by the stain. The membrane keeps the stain back. Unprotected eggs are at once killed by

* Anat. Record, xiii. (1917) pp. 109-12.

† Anat. Record, xiii. (1917) pp. 87-95 (2 pls. and 1 fig.).

‡ Anat. Record, xiii. (1917) pp. 145-57 (2 pls.).

§ Anat. Record, xiii. (1917) pp. 21-35.

Janus green. In the case of the sand-dollar (*Echinorachnius parma*) slightly stained spermatozoa were in a few cases able to fertilize ova; slightly stained eggs were occasionally fertilized by stained or unstained spermatozoa; in most cases Janus green was fatal, but brilliant cresyl-blue and neutral red proved true vital stains, for development went on, though the cells showed stained granules. The ova of the angler (*Lophius piscatorius*) developed into embryos in neutral-red solution, and the cells showed stained granules. Many details are given in regard to ova and spermatozoa and the influence of various stains.

Inheritance of Fertility in Sheep.*—E. N. Wentworth finds evidence that sheep of high birth-rank tend to produce offspring of high birth-rank. Data referring to Southdowns indicate that the highest record of a ewe is a better selection standard for high fertility than a random record. The frequency of multiple births in sheep varies with the breed. Inheritance is affected by the vigour of the ewe, the feeding and age of the ewe, the season and region. There seems to be no relation between high fertility and additional mammæ. There is no evidence of a sex linkage of fecundity factors in the pedigrees tabulated. Evidence from Shropshire triplet pedigrees suggests that triplets are genetically different from twins and singles, which two are probably genetically alike.

Development of Mammary Glands in Rat.†—J. A. Myers has studied this in male and female albino rats from the late fetal stages to ten weeks old. When the gonads are in the indifferent embryonic stage, there is no apparent difference in the primordia of the mammary glands in the two sexes. At eighteen days the primordia in the male differ from those of the female in possessing no mammary pit; at twenty days, when the nipple primordia are present in the female, they are absent in the male; the nipples fail to develop in the males; the epithelial hood is also absent. Until about the fifth post-natal week the milk-ducts of the two sexes are much the same; in the ninth week (age of puberty) the ducts of the female branch very profusely, while those of the male show little change. The second inguinal gland in the male is rudimentary or absent. The number of glands is more variable in the male than in the female.

Effect of Stress and Strain on Bone Development.‡—J. A. Howell followed Pottorf in observing the effect of cutting the main nerves of the branchial plexus on the right side of puppies (about four weeks old) in order to produce paralysis of the muscles. To the question whether all bone-growth is dependent upon the amount of stress and strain, the answer is definitely in the negative. Bones deprived of the action upon them of all but a negligible amount of stress and strain grow considerably. But the answer to the question whether bone-growth is entirely independent of the action of stress and strain is also definitely in the negative. This is shown conclusively by the very

* Amer. Nat., li. (1917) pp. 662-82.

† Anat. Record, xiii. (1917) pp. 205-26 (7 figs.).

‡ Anat. Record, xiii. (1917) pp. 233-52 (7 figs.).

much smaller diameter, thickness of compacta, size of trabeculæ, and greatly reduced weight of bones which were experimentally deprived of the influence of mechanical stress and strain. The growth in diameter is particularly affected.

Development of Liver in Ground Squirrel.*—C. E. Johnson has studied the development of the liver in two species, *Citellus tridecemlineatus* and *C. franklini*, and finds that it does not differ essentially from that observed in other mammals. The earliest primordium is a ventral thickening of the gut; it becomes an outpouching of the wall; it shows three lobe-like divisions; it becomes spindle-shaped and smooth-walled; trabeculæ make their appearance; to the primary hepatic diverticulum or pars hepatica there is added the pars cystica, which arises as an evagination of the gut wall, occupying the angle between the pars hepatica and the yolk stalk; this pars cystica is not a separate area so much as a caudal extension of that thickened part of the tube which has already given rise to the pars hepatica. The development of the ducts is described.

Development of Serous Glands of Tongue.†—E. A. Baumgartner finds that serous glands first appear in the 8.5 human fœtus as outgrowths of the vallate papilla of the tongue, usually from the lower border, sometimes from the outer wall. The first outgrowth is knob-like. Soon a stalk develops giving rise to lateral branches with enlarged end-pieces. In a 19 cm. fœtus these enlargements present bulgings of the surface and beginnings of alveoli. In the newborn the serous gland is alveolar, with some anastomoses between the alveoli. In the adult some of the glands are tubular, with some anastomoses. In the newborn, many knob-like outgrowths appear on the large ducts, probably primordia or potential primordia of future glands. Cystic dilatations of the serous ducts may occur. Mucous end-pieces occasionally open into the ducts of the serous glands of the vallate papillæ. Maziariski referred the serous glands of the vallate papillæ of man to the branched tubular type. They belong to the branching tubulo-alveolar type.

Angioblasts and Blood-vessels.‡—Florence R. Sabin has studied in chick embryo the differentiation of angioblasts from the mesoderm. They are vaso-formative cells, more granular and more refractile than the mesoderm cells; their daughter-cells form dense syncytial masses. Blood-vessels arise within the bodies of angioblasts, not between them. The angioblasts produce blood-plasma, endothelium, and red blood-cells. Red blood-cells arise from the endothelial lining of blood-vessels, and also from angioblasts directly.

Interstitial Cells in Reproductive Organs of Chicken.§—Alice M. Boring and Raymond Pearl discuss the conflicting results: interstitial cells are reported present and absent for male birds of practically every

* Anat. Record, xiii. (1917) pp. 169-75 (4 figs.).

† Journ. Amer. Anat., xxii. (1917) pp. 365-83 (3 pls.).

‡ Anat. Record, xiii. (1917) pp. 199-204.

§ Anat. Record, xiii. (1917) pp. 253-68 (6 figs.).

age. It appears to be definitely established that true interstitial cells are always present in the ovary; it is in regard to the testes that the discrepancy exists between observers. The authors find interstitial cells in the testes of just-hatched chicks. But they may be, and usually are, totally absent from the testes of males over six months of age and of full sexual maturity, both in respect of primary and secondary characters. It is difficult to suppose that they have any causal influence upon secondary sex-characters. The true interstitial cells are not merely homologous, but indeed structurally identical in the male (when present) and in the female.

Effects of Pituitary Body and Corpus Luteum on Chicks.*—

Raymond Pearl finds that feeding with corpus luteum and the anterior lobe of the pituitary body retarded the growth. The retardation was greater with corpus luteum. After forty-three days the birds fed with pituitary substance weighed on the average 4.01 p.c. less than the control birds, those fed on corpus luteum substance 9.31 p.c. less. There was no apparent difference in the time of attaining sexual maturity. There is no evidence that the administration of pituitary substance hastened in any way the initial activation of the pullet ovary. The corpus luteum treatment does not produce any physiological disturbance.

Hermaphrodite Dogfish.†—Ruth C. Bamber describes a case of hermaphroditism in *Scyllium canicula*, which showed two testes, and on the dorsal anterior of the right one a small mass of ova. Except for the absence of sperm-sacs, the animal had the complete genital systems of both male and female. Externally it was a typical male.

Removal of Pronephros of Amphibian Embryo.‡—Ruth B. Howland removed the pronephros from both sides of *Amblystoma* larvæ. This induced œdema and death. The presence of one sufficed to keep the embryo in health. Excision of one was followed by an increase in the size of the other, and in the diameter of the segmental duct. Removal of one pronephros has no essential effect on the development of the pronephric glomerulus of that side, but the segmental duct appears in varying stages of atrophy. Anterior and posterior nephrostomes may regenerate from the cœlomic epithelium. Early developmental stages of the mesonephros are normal after the excision of one hind-kidney.

Inheritance in Fantail Pigeons.§—T. H. Morgan crossed fantails with 29, 30 and 32 tail feathers and ordinary homers with 12. In the F_1 generation the range of variation was 12 to 20, with the highest frequency in the 14-feather class. "Evidently one or more of the factors of the fantail act as partial dominants, producing tails that have

* Proc. Nat. Acad. Sci. U.S.A., ii. (1916) pp. 50-53.

† Proc. Zool. Soc., 1917, pp. 217-9 (2 pls.).

‡ Proc. Nat. Acad. Sci. U.S.A., ii. (1916) pp. 231-4 (1 fig.).

§ Amer. Nat., lii. (1918) pp. 5-27 (14 figs.).

for the most part more tail feathers than has the common pigeon, but less than the fantail." In the F_2 generation the 12-feather tail reappeared in considerable numbers; the "curve" is at least bimodal with one apex in the 14, 15, 16 rows, and the other in the 12 row; a few individuals approached the lower range of variation of the fantail, viz. those with 24, 25 and 26 tail feathers. It is probable that a gene for more than 12 feathers, and the gene for no oil gland, and a gene for white colour are linked, i.e. are carried by the same chromosome.

Sex-ratio in Domestic Fowl.*—Raymond Pearl considers data representing 22,000 chicks. The ratio of males per 1000 females is 944, or 48.57 p.c., and it is interesting to notice that Darwin's figure was 48.64. There is variability from stock to stock and from year to year. Before aberrant sex-ratios can be considered indicative either of environmental or hereditary effects, it is necessary to show that they occur with such frequency as to exceed considerably that expected on the basis of chance alone. Prenatal mortality in the fowl is not differential in respect to sex, and in consequence the observed sex-ratio at birth is to be regarded as substantially the same as the initial zygotic sex-ratio.

b. Histology.

Shape of Red Blood-corpuscle in Mammals.†—L. B. Arey has made a series of experiments to solve the much-disputed problem of the normal shape of the red blood-corpuscle in mammals. He discusses the evidence derived from (1) drawn blood, (2) circulating blood, and (3) fixed tissues or smears, by other investigators, and supplemented by his own experiments. He finds that the shape of the mammalian red blood-corpuscle depends largely on the osmotic pressure of the examining medium. In solutions corresponding to about 0.9 p.c. sodium chloride the erythroplastid possesses a biconcave form. In progressively less concentrated (hypotonic) solutions water is imbibed, and the corpuscles swell to thin-walled cups, thick-walled cups, dimpled spheres, and finally lake-forming "shadows." In hypertonic solutions crenation results. Between the limits of form induced by a 0.3 p.c. sodium chloride solution and by mild crenation the shape of the red blood-corpuscle is repeatedly reversible. Individual variability exists in the response of erythroplastids to diluting media; this is perhaps referable to diverse elasticities of the corpuscular membranes. Undiluted drawn blood and blood diluted with human serum show the corpuscles to be bi-concave discs. Human serum must be diluted about one-third with water before cups begin to form. The study of circulating-blood in non-anæsthetized living mammals corroborates the view of the normality of the disc. The results gained by the use of fixatives, although seemingly adverse to the disc view, can be satisfactorily interpreted in terms of unequal fixation; this is supported by experiment. The several lines of experiment seem to justify the conclusion that the bi-concave disc represents the normal

* Proc. Amer. Phil. Soc., lvi. (1917) pp. 416-36 (3 figs.).

† Amer. Journ. Anat., xxii. (1917) pp. 440-74 (1 fig.).

shape of the mammalian erythroplastid, the concavo-convex cup being merely an occasional modification.

Blood-corpuscles of Alligator.*—Albert M. Reese has studied the blood of *Alligator mississippiensis* as regards the corpuscles. The average dimensions of the fresh erythrocytes were 20·77 micra in length, 12·78 in width, 4·17 in thickness. The cytoplasm was transparent, and seemed to be homogeneous. The nucleus was in most cases ellipsoidal. Hints of amitotic division were seen. There were various types of leucocytes, which are described.

Fatty Tissue of Crocodilians.†—Ed. Retterer and H. Neville find that the fat in Crocodilians, as in mammals, is due to an elaboration or transformation of the hyaloplasm of the cells of reticulate connective tissue. The hyaloplasm changes into fatty corpuscles, which are separated by trabeculæ which stain readily with hæmatoxylin. The adipose cells are bound together by reticulate septa, which also stain readily with hæmatoxylin, and are in part elastic. The perinuclear portion of the cytoplasm of an adipose cell is capable of developing with the nucleus so as to form a blood-corpuscule.

Time occupied in Mitosis.‡—Warren H. Lewis and Margaret R. Lewis have observed the time required for mitosis in mesenchyme cells from embryo chicks four to eleven days old, and cultivated in Locke's solution with or without the addition of bouillon. The time required for the complete process of mitotic cell-division was within the following limits: Prophase, 30 to 60 minutes; metaphase, 2 to 10 minutes; anaphase, 2 to 3 minutes; telophase, 3 to 12 minutes; and the reconstruction period, 30 to 120 minutes; total, 70 to 180 minutes. A fair estimate would be between two and three hours. In more normal conditions—namely, a four-day chick with the amnion intact in Locke's solution—the division of the smooth muscle-cells was observed: Prophase, 33 minutes; metaphase, 2 to 15 minutes; anaphase, 1 to 3 minutes; telophase, 3 to 5 minutes; and the first part of the reconstruction period, 4 to 10 minutes. It seems very probable that the duration of mitosis is not very different in different types of cell.

Minute Structure of Retractor Penis-muscle of Dog.§—Homer G. Fisher refers to the discrepant histological descriptions of this muscle. The fact seems to be that the muscle is mixed. In the anterior three-fifths the fibres are wholly smooth, while in the posterior two-fifths the fibres are both smooth and cross-striated.

Phagocytosis by Osteoclasts.||—Leslie B. Arey finds that bone cells laid bare by the resorptive process may be engulfed by osteoclasts. The phagocytic inclusion of a bone-cell by an osteoclast is described and figured.

* Anat. Record, xlii. (1917) pp. 37-44 (8 figs.).

† C.R. Soc. Biol. Paris, lxxx. (1917) pp. 795-7.

‡ Anat. Record, xiii. (1917) pp. 359-67.

§ Anat. Record, xiii. (1917) pp. 69-79 (2 pls.).

|| Anat. Record, xiii. (1917) pp. 269-72 (4 figs.).

Seasonal Changes in Interstitial Cells of Woodchuck.*—A. T. Rasmussen publishes the results of a study of the changes in the interstitial cells of the testis in thirty-five woodchucks (*Marmota monax*) examined at different seasons of the year. The woodchuck is sexually active only in spring, the female bringing forth a single litter in late April or early May. Hibernation is profound and lasts for four months; no food is stored up. For purposes of investigation the testes were usually removed from the living animal under ether, but in some cases they were removed immediately after death, and in a few several hours after the animal was shot. During late summer and autumn the interstitial cells of the testis are minimal in size and probably reduced in number. The scanty cytoplasm of these cells contains numerous pigment granules, some fine lipid granules, but only a few cells contain coarser, more fat-like granules. There are a number of large interstitial cells which are gorged with prominent pigmented granules, and which have resulted from the degeneration of other and more numerous types of interstitial cells. A new spermatogenic cycle is in progress. The testis is small, dark in colour, and abdominal in position. There is no sudden change in the interstitial cells with the onset of hibernation, and little or no change during dormancy, except that there is a slight gradual decrease in pigmentation. Spermatogenesis remains much the same during the torpid state as just before the winter-sleep sets in. The tubules are filled with spermatocytes showing open maturation figures during the entire winter. In the spring, as the animal is waking up, the interstitial cells rapidly enlarge and apparently increase in number. The nucleus increases only slightly. The great increase is primarily in the cytoplasm, and is due to the development of a dense central mass of cytoplasm and the accumulation of fatty globules in the more peripheral portion. Fine lipid granules are also abundant in the central cytoplasm. The great interstitial cell-development forces apart the tubules and doubles the diameter of the testis, which descends into a pouch essentially representing a scrotum, remaining in communication with the abdominal cavity proper. Spermatogenesis suddenly shows renewed activity, and free sperms are seen two or three weeks after the woodchick has waked up. The interstitial cells do not reach their maximal size till the end of April. There is a distinct decrease in pigmentation. Regressive spermatogenesis begins in late April and a new cycle begins early in May, but the interstitial cells remain well developed for two months longer. By July the testes have returned to the abdominal position, the interstitial cells show signs of decreasing, and by August they are little more than naked nuclei. A few cells do not decrease, their lipid content having been transformed into pigment granules. The testis as a whole is reduced to about an eighth of its former size, and is darker in colour than at any other stage. Spermatogenesis is slowly progressing uninterruptedly. Interstitial cell-growth seems more uniformly related to the later and regressive stages of spermatogenesis than to the initial stages, but there is evidence of variability even in regard to these.

* Ann. Journ. Anat., xxii. (1917) pp. 475-513 (3 pls.).

c. General.

Myelin and Advancing Age.*—Henry H. Donaldson has inquired into the fact that, starting from birth, the water-content of the mammalian body as a whole, and in certain systems, diminishes with age. In the albino rat he finds that there is a progressive loss in the percentage of water in the brain and in the spinal cord. This proceeds thirty times faster than in man. Donaldson's observations show further that the diminution is not in the cell-bodies and their unmyelinated axons, but is mainly due to the accumulation of myelin—with a water-content of about 60 p.c. The myelin must be regarded as a more or less extraneous substance, having but little significance for the characteristic activities of the neurons. Myelin formation is a function of age.

Theory of Nerve Conduction.†—A. G. Mayer has been led by experiments on the jelly-fish, *Cassiopea ramachana*, to the theory that adsorption may play a fundamental rôle in nerve-conduction, and that the only cations which are necessary to the reaction are the adsorbed sodium, calcium, and potassium ions, the rate of nerve-conduction being proportional to the concentration of these adsorbed ions. There is a change in the rate of nerve-conduction in *Cassiopea* in successive dilutions of sea-water. Nerve-conduction is probably a phenomenon of *adsorption* combined with an ordinary chemical reaction.

Origin of Air-breathing Vertebrates.‡—Joseph Barrell accepts Chamberlin's theory that fishes arose in land-waters, and constituted primarily a river fauna. The lung-fishes arose under semi-arid climates and in seasonal waters. The evidence is strong that the air-bladder was originally a supplemental breathing-organ, although in modern fishes it has been mostly diverted to other uses. "Among certain Devonian fishes, living under more and more strenuous climatic conditions of seasonal dryness, the use of the air-bladder for respiration became essential, and with the diminishing availability of the waters of certain regions the gills in those species became correspondingly atrophied. The amphibians thus arose under the compulsion of seasonal dryness." "Climatic oscillation is a major ulterior factor in evolution."

Rats and Evolution.§—A. G. and A. L. Hagedoorn, dealing particularly with rats, define a species as "a group of individuals which is so constituted genotypically, and which is so situated, that it automatically tends to restrict its total potential variability." The "total potential variability" is "the quantity of genes which not all the members of a group have in common, or for which they are not pure (homozygous), and the variability which this impurity makes possible in

* Proc. Nat. Acad. Sci. U.S.A., ii. (1916) pp. 350-6.

† Proc. Nat. Acad. Sci. U.S.A., ii. (1916) pp. 37-42.

‡ Bull. Geol. Soc. America, xxvii. (1916) pp. 345-436. See also Proc. Nat. Acad. Sci. U.S.A., ii. (1916) pp. 499-504.

§ Amer. Nat., li. (1917) pp. 385-418.

the descendants." Crossing or recombination of genes by mating of individuals of unequal genotype is the only real cause of variability. Mutation exclusively consists of an occasional loss of a gene without visible cause. No matter where we find rats of the *Rattus* group there are never more than one kind of tree-rat of this group, one house-rat, and one field-rat simultaneously present in one locality. The three kinds cross with facility and produce fertile hybrids; colonies of aberrant forms thus arise. In seaports new types are continually arising by crossing with imported rats. There is no real antagonism between *Mus rattus* and *M. norvegicus*, but these do not mate together, or, if they do, no offspring result.

Evolution is the result of a combination of all those causes which heighten variability and which limit it. The only cause of inheritable variability in Metazoa is amphimixis. All those causes that tend to reduce the potential variability of a group tend to make varieties or species of these groups. Such causes are isolation, migration, adaptation, selection, and especially the fact that either periodically or regularly the number of individuals of one generation is very much smaller than that of the preceding one. This cause of purification of the type occurs everywhere, and operates quite regardless of adaptation or fitness. To this cause, working upon variation, may be ascribed numerous characteristics for which we can invent no use, for which species are nevertheless pure.

Post-natal Growth of Kidney of Albino Rat.*—John A. Kittelson has made a minutiose series of measurements and enumerations. The post-natal growth of the cortex of the kidney is fairly uniform, showing in comparison with the entire body a relative increase between birth and two weeks, decreasing slightly thereafter. The growth of the medulla is more varied. The volumetric ratio of medulla to cortex changes greatly in the course of growth.

The new-born rat has 10,465 fully-formed renal corpuscles, or 15,533 including those incompletely formed. The similar numbers at one week are 19,682 and 26,598; at two weeks, 24,061 and 24,091. At three weeks 25,930 were counted, at seven weeks 28,583, at twelve weeks 28,863; so that practically the total number is reached during the third post-natal week. The average diameter increases from about 62 micra in the new-born to about 127 in the adult. In the adult human kidney there are about 1,040,000 renal corpuscles.

"Proboscis Pores" in Craniate Vertebrates.†—Edwin S. Goodrich gives an account of the complex minute structure of the epithelium lining Hatschek's pit on the roof of the buccal cavity in *Amphioxus*, and of the development of this pit and of the pre-oral pit from the left anterior coelomic sac and an ectodermal ingrowth respectively. The pre-oral pit becomes the wheel-organ of the adult. The ciliated cells of Hatschek's pit are of mesodermic origin, but the rod-bearing

* Anat. Record, xiii. (1917) pp. 385-408.

† Quart. Journ. Micr. Soc., lxii. (1917) pp. 539-54 (1 pl. and 3 figs.).

cells appear to come from the ectoderm. The evidence favours Bateson's comparison of the opening of Hatschek's pit with the proboscis pore in *Balanoglossus* and the water-pore of Echinoderms. The anterior cœlomic sacs of *Amphioxus* are homologous with the pre-mandibular somites of Craniates, and the tubular outgrowths of the latter opening into or fusing with the hypophysis correspond to "proboscis pores." All are of the nature of cœlomostomes. The hypophysis of Craniata is represented in *Amphioxus* by the wheel-organ, and it is suggested that its original function was to drive food into the mouth.

Origin of Melanin in Feather-germs of Fowls.*—R. M. Strong has re-investigated the development of melanin pigment in feather-germs of Plymouth Rock and Brown Leghorn fowls. Melanin granules occur occasionally in the so-called cylinder and inner-sheath cells of feather-germs from the common fowl. Further evidence was obtained that the melanin pigment of feathers is epidermal in origin. Melanophores were found in the dermal pulp at the proximal end of the feather-germs. They are presumably homologous with the dermal melanophores of the skin. Some of these pulp melanophores have processes which are usually relatively short, but they do not appear to distribute pigment to other cells, and they have no part in the histogenesis of the feather or its pigment. A few of these dermal melanophores were found in contact with the basement membrane, but none had penetrated it.

Agricultural Zoological Survey of Aberystwith Area.†—Chas. L. Walton makes a very interesting report on the agricultural zoology of this area, which includes mountain upland, coastal plateau, and the intermediate fall line. He deals with the occurrence of gid (*Multiceps multiceps*), *Echinococcus*, the tapeworms (*Moniezia expansa* and *M. trigonophora*) of sheep and lambs, "husk" or verminous bronchitis (in part at least due to *Strongylus filaria*), gape-worm (*Syngamus trachealis*), *Ascaris suilla*, various Ixodidae, Red Water or Bovine Piroplasmiasis, scab, scaly leg, ten blood-sucking flies, sheep maggot-fly, sheep nostril-fly, and so on. This excellent and suggestive Report should be used as a model for other districts.

Study of Hilsa.‡—T. Southwell and B. Prashad have made a study of *Hilsa ilisha* (= *Clupea ilisha*), the highly esteemed Indian shad. It has a wide distribution in the Indian Ocean, where it is hardy and powerful; but it ascends rivers to breed, and is then delicate and easily killed. They swim rapidly in the river, near the bottom, and seem to fast. The females are much larger than the males. An account is given of the eggs, which swell in water after fertilization from 0.8 mm. to 1.8 mm.; of the fungoid parasite that attacks them; of the enemies and parasites of the adults; and so on.

* Anat. Record, xiii. (1917) pp. 97-108 (6 figs.).

† Parasitology, x. (1917) pp. 206-31.

‡ Dept. Fisheries Bengal, Bihar, and Orissa, Bull. No. 11 (1918) pp. 1-12.

INVERTEBRATA.

Mollusca.

γ. Gastropoda.

Centrifuged Eggs of Crepidula.*—E. G. Conklin subjected the eggs of this marine Gastropod to centrifugal force approximately two thousand times gravity. The yolk is thrown to the distal or centrifugal pole, the oil and other light substances to the centripetal pole, while the nucleus and centrosphere, together with most of the cytoplasm, occupy the middle zone between the other two. If there is time in fertilized eggs before the first cleavage, there is a restoration of the normal positions. If cleavage occur before restoration, the two daughter-cells have an abnormal distribution of substances. But in them there is speedy restoration to something like the normal. By organic regulation there is a restoration of the normal polarity and pattern. There seems to be a "ground substance" which is not moved by the centrifuging—a framework of protoplasmic strands which preserve the relative positions of nucleus and centrosphere in the cell-axis.

British Terrestrial and Fresh-water Mollusca.†—John W. Taylor deals, in Part 23 of his Monograph, with *Hygromia*, *Ashfordia*, and *Theba*, and announces, we regret to see, that the work must be suspended until the conclusion of the War.

Immunity Coloration in Nudibranchs.‡—W. J. Crozier refers particularly to the large brilliant *Chromodoris zebra* of Bermudas. Its pattern is an irregular streaking of yellow or orange upon a field of blue. Large numbers are found in quite shallow water, though they go down to 10 fathoms. The skin secretions are repugnant to many animals, and the odour is penetrating and disagreeable. The repelling material contains globules of the blue pigment, but the main constituent is a coagulated white substance containing only globules. Cloth bags containing the nudibranch are avoided by fishes, and blinded fishes are also repelled. The success of *Chromodoris* in the shoal waters of the coral-reef region is conditioned by the secretion and the odour, and by the unpalatable nature of the jelly surrounding the eggs. The eggs develop slowly, but the animals reproduce throughout the year. Crozier accepts Reighard's reasonable theory that the startling colours have arisen for internal physiological reasons under conditions of immunity which have been attained by characters other than those of coloration. "The coloration of *C. zebra* is a metabolic accident, at least in regard to its protection, for a single experience with a normally coloured specimen is sufficient to cause snappers, turbot, and groupers to have nothing to do with subsequent individuals offered to them, even though these

* Proc. Nat. Acad. Sci. U.S.A., ii. (1916) pp. 87-90.

† Monograph of the Land and Fresh-water Mollusca of the British Isles, Part 23, pp. 65-112 (4 pls. and many figs.).

‡ Proc. Nat. Acad. Sci. U.S.A., ii. (1916) pp. 672-5.

individuals are stained red or blue." This view does not exclude the possibility that the colour may at times serve to warn predatory foes; but the conspicuous coloration did not evolve as the result of its selection as a warning.

Cytoplasmic Inclusions in Germ-cells of Snail.*—J. Bronté Gatenby finds that the ovotestis of *Helix aspersa* consists of finger-like diverticula, which are hollow at the lower ends connecting with the hermaphrodite duct, while the upper ends contain more yolk and are filled with metamorphosing male cells. The elements differ in nucleus, mitochondria, nebenkern, and volume according to nutritive conditions and number of divisions. The minute structure is described. Macro-mitochondria and micromitochondria are distinguished, and the function of the nebenkern is discussed. Only confusion will result, we think, if the author persists in the terminology indicated in the following sentence: "The determination of the sex of the indifferent cell seems to be brought about by a variety of causes. The explanation of femaleness by presence of yolk-cells is held to be inadequate, for male progerminative cells also appear in regions choked with yolk."

Arthropoda.

Median Eye in Trilobites.—R. Ruedemann calls attention to the presence of a median eye on the glabella. It appears as a tubercle in upwards of thirty genera. There is sometimes a lenticular cavity below a thin cornea; this may have been filled with sea-water or with some body-fluid. It is comparable to the median eye of some Phyllo-pods. Indirect evidence for the visual function of the tubercle is submitted. There is least trace of the tubercle in forms with highly-developed lateral eyes; in genera usually considered as blind because of reduced or absent lateral eyes the median tubercle is most distinctly developed.

a. Insecta.

Nuclear Division in the Adipose Cells of Insects.†—Waro Nakahara makes a preliminary note on amitotic division in adipose cells. There is good evidence that amitosis does not mean the approach of degeneration or aberration, as Flemming believed. It is a kind of nuclear division which, as Chun suggested, secures the increase of surface to meet the physiological necessity which is due to active metabolic interchanges between nucleus and cytoplasm. It occurs in the adipose cells preparatory to and simultaneous with certain metabolic changes in which the nuclei take the rôle of essential importance, viz. the formation of albuminous granules. It appears that acidophile granules are extruded from the nucleus into the cell-body, forming the characteristic albuminous granules.

* Quart. Journ. Micr. Sci., lxii. (1917) pp. 555-611 (6 pls. and 5 figs.).

† Proc. Nat. Acad. Sci. U.S.A., ii. (1916) pp. 234-7.

‡ Anat. Record, xiii. (1917) pp. 81-5 (11 figs.).

Studies in Mecoptera.*—R. J. Tillyard has made an interesting study of a new family, Nannochoristidæ, in the ancient order of Mecoptera, or Scorpion-flies. The Nannochoristidæ are minute insects, represented by four new Australian species of the new genus *Nannochorista*, which is “an example of a highly specialized reduced type based upon a very archaic foundation,” and by an allied New Zealand new genus, *Choristella*, with one species. The archaic characters of *Nannochorista* include the high roof-like manner of folding the wings, and the presence of a wing-coupling apparatus, with frenulum well developed. The cœnogenetic characters include the reduction of size, the loss of macrotrichia from the wing-membrane, the reduction of the sub-costal vein, the loss of the first apical fork, the high specialization of the mouth-parts. To students of Panorpid orders the new type will be of great interest. The male closes his anal forceps on the tip of the abdomen of the female in a lock-grip. The New Zealand type has a wing-venation even more reduced than in *Nannochorista*. The distribution of this highly-specialized family derived from a very ancient stock (in Tasmania, the Eastern Highlands of Australia, and New Zealand) can only be explained by dispersal from an original common Antarctic ancestor.

Protocerebrum of Micropteryx.†—P. A. Buxton has made a thorough study of the protocerebrum of *Micropteryx* (*Eriocéphala calthella*), the smallest insect of which the brain has been investigated in any detail. Most entomologists regard *Micropteryx* as a primitive Lepidopteron; there is good ground for regarding it as a Trichopteron. Chapman has raised it to ordinal rank (Zeugoptera).

The neurilemma, which covers the whole of the central nervous system in one continuous sheath, is a thin syncytium. Beneath it are found the ganglion-cells and the axonic parts of the nervous system. Over the protocerebrum the layer of ganglion-cells is deep, and four types can be distinguished: the normal type, the mushroom-body cells, the cells of the optic lobes, and the giant cells. Neuroglia cells are found in the substance of the protocerebrum in small numbers, and the tracheal system of the brain is very slightly developed. The protocerebral lobes exceed in bulk the rest of the protocerebrum. A mid-dorsal protocerebral lobe is specially described as the tumulus. The mushroom-bodies are small and simple, with a spherical head which contains minute glomerular masses of nerve-fibres regarded as association-centres. An account is given of the stem of the body and its division into three roots (inner, forward, and backward). The central body is large, and consists of an outer and an inner capsule, the latter containing a number of minute glomerular bodies. The tracts passing from or to the central body are numerous, and some of them are large. The nerves from the ocelli run inwards across the front of the head of the mushroom-body and pass gradually into the substance of the protocerebral lobes, and a few fibres pass into the bridge. Two small bodies beneath the central body are probably the ocellary glomeruli

* Proc. Linn. Soc. N.S.W., xlii. (1917) pp. 284-301 (2 pls. and 3 figs.).

† Trans. Entomol. Soc. London, 1917, pp. 112-53 (4 pls. and 3 figs.).

of other observers. The bridge is simple and straight; its ends are rounded and consist of "Punktsubstanz," and into these pass the axons of a few cells which are situated in the immediate neighbourhood. The middle of the bridge is formed of a large number of fibres which pass across the middle line.

Scales of Leaden Males of *Agriades thetis*.*—E. A. Cockayne finds that in these aberrant forms the smoky scales and androconia are of the normal shape, size, and colour, but all the colour scales are very thin, and have their distal part rolled up to form a tube. "By reflected light the curled-up edges and tubular ends of these scales look silvery, and under a low-power of the microscope appear as ghostly triangles overlying the dark scales, which are much exposed to direct view and give the leaden colour to the wings." The peculiarities of the scales are probably due to some inborn error of development. Similar aberrations are widespread through the blue *Lycænids*. Breeding experiments with the leaden males would be interesting.

Gynandromorph of *Papilio lycophron*.†—J. J. Joicey and G. Talbot describe and figure a remarkable specimen of this Peruvian butterfly in which the right hind wing above is normal.

Protective Coloration in *Lepidoptera*.‡—J. C. Mottram shows how concealment may be effected by the apparent disruption of surface in a plane at right-angles to the surface. Outline may be concealed by disruptive coloration and solidity by counter-shading. Many small details of pattern are of value in concealment, and one should be slow to conclude on negative evidence that small differences such as often distinguish species can have no value in the struggle for existence.

Inheritance in Silkworms.§—Onera A. Merritt Hawkes has studied inheritance in the hybrid *Philosamia (Attacus) ricini* (Boisd.) male and *Philosamia cynthia* (Drury) female. The plain or non-spotted condition of the larva of *P. ricini* is recessive to the spotted condition of the larva of *P. cynthia* (Ning-po variety). The domination in the F_1 generation is incomplete; all the larvæ are spotted, but not all have the full complement. The spots are probably represented by a group of related genes in the chromosome, not by one gene. The dominant homozygous and the heterozygous forms can be distinguished only by breeding, as both may be either full-spotted or partly-spotted. A number of abnormal larvæ with reduced tubercles occurred in the F_2 generation; when these were mated with normal larvæ the character behaved as a recessive. A careful account is given of the minute structure of a tubercle.

Study of Holly Tortrix Moth.||—L. H. Huie has made a study of *Eudemis nævana*, the larva of which eats off the young leaves of holly

* Trans. Entomol. Soc. London, 1917, pp. 165-8 (1 pl.)

† Proc. Zool. Soc., 1917, p. 273 (1 pl.).

‡ Proc. Zool. Soc., 1917, pp. 253-7 (4 figs.).

§ Journ. Genetics, vii. (1918) pp. 135-54 (1 pl. and 2 figs.).

|| Proc. Roy. Phys. Soc. Edinburgh, xx. (1917) pp. 164-78 (1 pl.).

and usually destroys the growing point. The moths emerge after pupation about the end of July and beginning of August. The eggs are laid in August on the under sides of holly leaves; the larvæ hatch out in late April or early May of the following year, and proceed at once to the apices of the shoots to feed on the young leaves of the opening buds. Four moults take place. During the third and fourth instars the larvæ protect themselves when feeding by fastening the leaves together by a silken webbing, which prevents the buds from unfolding. Under this cover the larva devours the youngest leaves and often gnaws the growing point. The caterpillar is full fed about the end of June or beginning of July. About the same time the surviving leaves break the webbing and the apex of the shoot becomes exposed. The caterpillar seeks a retreat lower down, and after the fourth moult passes into the pupal state about a week after it has ceased to feed. The moths emerge in two to three weeks. Nicotine spray was very effective.

Dipterous Parasite in Terrestrial Isopods.*—W. R. Thompson found in *Porcellio scaber* and *Oniscus asellus*, two common wood-lice, the larvæ of a fly, *Phyto melanocephala*, of which three stages are described. The first stage is elongated, covered with minute chitinous plates, with very long antennary organ, with well-developed sensory structures, with a very remarkable bucco-pharyngeal armature. The second stage is colourless, with reduced sensory structures and antennary organ, with an ordinary form of bucco-pharyngeal armature. The third stage has a two-jointed bucco-pharyngeal apparatus, and is amphipneustic, the two preceding stages being metapneustic. The larva castrates its female hosts at least. It probably enters the wood-louse towards autumn; the fly emerges in early summer.

Mutations in *Drosophila busckii*.†—Don C. Warren reports the occurrence of two mutations in eye colour—"red eye" and "chocolate eye"—in *D. busckii*, apparently the first mutations that have occurred in this species. This is the eighth species of *Drosophila* in which mutations have been recorded. The "red eye" acts as a non-sex-linked recessive character, with the red class falling a little short. The same is true of the "chocolate eye," but the chocolate class falls considerably below expectation.

Bionomics of the Buffalo-fly (*Lyperosia exigua* de Meijere).‡—G. F. Hill gives an account of the habits and life-history of *Lyperosia exigua* de Meijere, known to stock-owners in the northern territory of Australia as the Buffalo-fly. Though it is less voracious and causes less loss of blood than the larger flies of the genera *Tabanus* and *Silvius* it is a more formidable pest because of the great number of individuals of the species and the longer period of its seasonal occurrence. Unlike the larger blood-sucking flies, too, *Lyperosia* attacks abraded surfaces, and

* C.R. Soc. Biol. Paris, lxxx. (1917) pp. 785-8 (7 figs.).

† Amer. Nat., li. (1917) pp. 699-703.

‡ Proc. Linn. Soc. N.S.W., xli. (1916) pp. 763-8 (1 pl.).

congregates in great numbers on a small area where by repeated bites it produces a practically constant state of irritation. Old, poor-conditioned and sickly stock suffer most. Hair-colour appears to make no appreciable difference, but some individuals are not molested. Goats are seldom attacked: dogs, pigs, sheep, and kangaroos are apparently immune. Horses, cattle, and buffaloes are the most frequent victims, but the characteristic sores are less severe on the buffalo, probably because of its thicker skin and its habit of standing up to the neck in mud or water for long periods.

The eggs of *Lyperosia* are usually deposited in the fresh droppings of cattle and horses; accumulated heaps of stable-manure are not favourable to their development, but milking yards are great centres of infection. The eggs are pale brown in colour, and are laid singly on the wet surface of the dung, oviposition taking two to four minutes. The young larvæ descend into the dung and pupation takes place there. In those reared under laboratory conditions the life-cycle was completed on an average in 169 hours. The species is believed to have been introduced into Australia since 1824 with some of the earlier importations from the East Indies of buffaloes, cattle and horses. Its distribution coincides, on the whole, with the range of the introduced buffaloes. Few indigenous birds pick food from dung, and *Lyperosia* has not many natural enemies except some species of ant which gathers the eggs, and a small Hymenopteron which captures the flies while feeding or at rest.

Circulation of the Blood in Insects.*—F. Brochet has followed up his paper on the circulation of the blood in the larva of *Dyticus marginalis* by a study of Agrionid larvæ. These are particularly well adapted for study because they are transparent after moulting, and can be kept so in clean water. Before examination under the microscope they were not fed for twenty-four hours, so that the alimentary canal should not be opaque. In the Agrionid larva, as in *Dyticus*, the dorsal vessel functions mainly as an inspiratory pump; it tends continually to drain the abdominal cavity, and thus indirectly acts as exhauster for all the blood in the body. The circulation of blood in the wings is effected by two special pulsating organs in the meso- and meta-thorax. In the legs the mechanism is quite different, the circulation of the blood in them depending on the *respiratory* action. Certain structural and physiological facts were clearly observed: the presence in the thorax of the larvæ of *Aeschna* of two transverse diaphragms provided with a sphincter through which the œsophagus passes; the presence in the femur of a true blood-vessel; the presence in the tibia of a longitudinal partition pierced by two small orifices; and the presence of two pulsating organs in the meso- and meta-thorax. It was possible to observe, especially in Agrionid larvæ, the relation between the movements of rectal expulsion and the gush of blood into the femur, and the fact that, in anæsthetized insects, the blood flows towards the abdomen and towards the dorsal vessel under negative pressure, therefore as a result of an inspiration, and not under positive pressure, as would be the case if it were a question of propulsion.

* Arch. de Zool. Expér. et Gen., lvi. (1917) pp. 445-90.

Growth-period and Duration of Life.*—John N. Northop has experimented with larvæ of *Drosophila*, whose growth can be greatly retarded by growing them on sterile fruit or other substances containing no yeast. The deficiency is probably in "vitamines," or growth-promoting substances. The prolongation of the larval period is without effect on the duration of the pupal period, but the total duration of life can be prolonged. This shows that the relative durations of the larva, pupa, and imago stages are independent. It is probable that the duration of each of the stages is determined by the formation (or by the disappearance) of a definite specific substance.

Study of Structure, Habits, and Life-history of Hylastes.†—James W. Munro has made a valuable study of this genus of Scolytid beetles, three-species of which are of considerable interest to the forester, namely *Hylaster ater*, *H. palliatus*, and *H. cunicularius*. All the three attack Conifers. A well-illustrated account is given of the external features, the appendages, the alimentary canal, and the reproductive organs. The mother-galleries and the larval-galleries in the roots of the Conifers are described. The life-histories of the three are carefully contrasted, and the economic importance of the insects is discussed. The illustrations of this very useful paper are of great merit.

Endoskeleton of Head and the Coxal Cavities of Beetles.‡—Thomas G. Sloane has studied the endoskeletal plate and its supports inside the head of Carabidæ and Cicindelidæ. They serve for the support of the muscles of the mouth-parts. Their differences in the two families are indicated. He also deals with the structure of the anterior coxæ, and with the different forms of anterior coxal cavities in the Carabidæ. The facts do not seem to the author to support the current view that the open anterior coxal cavities are more primitive than the closed cavities.

Germ-cell Cycle of *Dineutes nigrior*.§—R. W. Hegner and C. P. Russell find that in this whirligig beetle an ultimate oogonium divides into two daughter-cells of unequal size. The smaller gives rise to nurse-cells only. The larger, "the oocyte grandmother-cell," contains an oocyte determinant. Its division into four cells is differential, for one product, "the oocyte mother-cell," receives all of the oocyte determinant, the other three lack this body and become nurse-cells. Each of these four cells undergoes a single mitotic division resulting in the formation of seven nurse-cells and one oocyte, the latter containing the oocyte determinant. In *Dytiscus* there are four differential divisions, and the oocyte is accompanied by fifteen nurse-cells; in *Dineutes nigrior* there are three differential divisions, and the oocyte is accompanied by seven nurse-cells.

* Journ. Biol. Chemistry, xxxii. (1917) pp. 123-6.

† Proc. Roy. Phys. Soc. Edinburgh, xx. (1917) pp. 123-58 (28 figs.).

‡ Proc. Linn. Soc. N.S.W., xlii. (1917) pp. 339-42.

§ Proc. Nat. Acad. Sci. U.S.A., ii. (1916) pp. 356-6 (6 figs.).

β. Myriopoda.

New Spirostreptidæ.*—J. Carl describes new species of *Poratophilus*, *Thyropygus* and *Doratogonus*, and establishes two new genera, *Stennurostreptus* and *Stenostreptus* in this family of Diplopoda. Particular attention is paid to the structure of the gonopods, which is of great diagnostic value.

δ. Arachnida.

Chondriosomes of Scorpion Spermatozoa.†—Edmond B. Wilson contrasts the nuclear chromosomes and the cytoplasmic chondriosomes carried by the spermatozoon into the egg. He has studied them in two scorpions, *Opisthacanthus elatus* and *Centrurus exilicauda*. In the latter it is possible to conclude with certainty that the chondriosome material is divided with exact equality among all the spermatozoa. It is concentrated into a ring-shaped body which is equally divided, so that each spermatid gets a quarter. In *Opisthacanthus* the chondriosome material has the form of about twenty-four fairly large, separate, hollow spheroidal bodies scattered without discernible order in the protoplasm. In division each spermatid receives six chondriosome spheres as a rule, but sometimes five or seven—a sort of hit-or-miss segregation. On its face the contrast would seem to indicate that a wide distinction should be drawn between chondriosomes and chromosomes in respect to their power of division and their relation to heredity.

Ulster Spiders.‡—J. A. Sidney Stendall gives a list of what remains (twenty-five species) of the late Mr. Thomas Workman's collection of Ulster spiders. In Workman's list sixty-four species were recorded. The author has made a fresh collection from Ulster, and gives a list of sixty species. Of these, one species, *Leptyphantes nebulosus* Sund, is new to Ireland, and five are new to Ulster.

Ant-like Spiders.§—H. D. Badcock reports on a collection of ant-like spiders from Malaya, including eight new species of *Myrmarachne*. Many of the specimens were accompanied by ants from the same localities.

Swiss Halacaridæ.||—C. Walter describes, from Swiss lakes, *Limnohalacarus walkeri* (Walter), synonymous with *Halacarus walkeri* Walter; *Soldanellonyx chappuisi* g. et sp. n., a blind form with a very remarkable calyx-like claw on the first leg; *S. parviscutatus* sp. n.; and *Lohmanella violacea* (Kramer).

ε. Crustacea.

Loss of Eye-pigment in Gammarus chevreuxi.¶—E. J. Allen and E. W. Sexton have made a Mendelian study of the progressive degenera-

* Rev. Suisse Zool., xxv. (1917) pp. 383-409 (26 figs.).

† Proc. Nat. Acad. Sci. U.S.A., ii. (1916) pp. 321-4 (11 figs.).

‡ From Proc. Belfast Nat. Hist. and Phil. Soc., 1915-16, pp. 1-7.

§ Proc. Zool. Soc., 1917, pp. 277-321 (12 figs.).

|| Rev. Suisse Zool., xxv. (1917) pp. 411-23 (13 figs.).

¶ Journ. Marine Biol. Assoc., xi. (1917) pp. 273-353 (7 pls.).

tion of the eye in this Amphipod. It took place in a series of definite steps or stages, each of considerable magnitude. The end was an entire loss of the eye-pigment, a broken irregular arrangement of the ommatidia, and a great reduction in their number. The continuation of the process for a few steps further may be thought of as likely to lead to the complete absence of eyes seen in Amphipod genera from subterranean waters. The changes all took place in exact conformity with Mendel's Law. The mutation from black to red pigment arose only once in the course of the work; the complete loss of the inter-retinal coloured pigment occurred four times in one family of 733, and never again; the loss of the white, extra-retinal pigment originated on several occasions and in apparent independence. The experiments give striking illustrations of the way in which the offspring of two abnormal parents may be quite normal in their characters, and yet transmit the abnormalities.

Malacostraca of Natal.*—T. R. R. Stebbing reports on the higher Crustaceans of Natal, and deals especially with *Platylambrus quemvis* sp. n., *Atergates floridus* (Linn.), *Macrophthalmus grandidieri* A. Milne-Edwards, *Uca lacteus* de Haan, *Dotilla clepsydra* sp. n., and *Rhynchocinetes typus* Milne-Edwards.

Morphology of Bathynella.†—W. T. Calman discusses some of the structural peculiarities of *Bathynella natans*, one of the most remarkable of living Crustacea. It is undoubtedly a degenerate member of the Syncarida, a group of Crustacea which has persisted from Carboniferous times, and of which the only other living representatives are found in Australia and Tasmania. It was found in 1882 in a well in Prague; it has been recently rediscovered in Switzerland. In some features, such as the absence of eyes, it shows degeneracy, which may be correlated with life in subterranean waters, though mere minuteness of size may also be a factor. The division Syncarida, and the order Anaspidacea include five families:—Anaspidæ, Koonungidæ, Acanthotelsonidæ, Bathynellidæ, and Uronectidæ. The Syncarida form by themselves a division of equal rank with the Eucarida and Peracarida, but allied more closely with the former than with the latter.

Body-colour and Blood-colour in Amphipods.‡—John Tait finds that some of the Gammaridea owe their body-colour in a large degree to the colour of their blood. In Isopods this is the case to a much less degree. A dark green *Gammarus* has greenish blood plasma, a slate-grey specimen bluish plasma, a brown has brown, while a brownish-red has violet plasma. Pale yellow and white specimens of *Gammarus* have plasma that is almost colourless, while the blood of some of them, viewed in bulk, is actually milk-white. Specimens of *Orchestia* in which a blue tint is visible have bright blue plasma; those in which no blue is to be seen, yellow-brown specimens, have yellow plasma. The external covering of these shore Amphipods being devoid of chromatophores, and

* Ann. Durban Museum, ii. (1917) pp. 1-33 (6 pls.).

† Quart. Journ. Micr. Sci., lxii. (1917) pp. 489-514 (14 figs.).

‡ Proc. Roy. Phys. Soc., xx. (1917) pp. 159-63.

being more transparent than that of most Isopods, the hue of the blood largely determines the colour of the animal. For this reason their colour is not subject to reflex alteration, but remains fixed in spite of the change of eye illumination. Even Isopods that possess chromatophores may derive part of their colour from that of the blood. Tait finds that pale specimens of *Gammarus marinus* are infected with what seems to be a very large bacterium, which circulates in large numbers in the blood. The infected animals become white in colour, owing to their blood being deprived of pigment, and to reflection of light from the bacteria. The animals were apparently healthy in spite of the overwhelming infection. The length of the rice-grain-shaped organisms was about equal to the diameter of a human red blood corpuscle. Vejdovsky has described, in spirit specimens of *Gammarus zschokkei* from Garschina Lake, Switzerland, the occurrence of a "gigantic" nucleate micro-organism, which he has named *Bacterium gammari*. It causes some change in metabolism, whereby already-formed blood pigment is destroyed, or the manufacture of new pigment is inhibited.

Sex Intergrades in *Simocephalus*.*—Arthur M. Banta has found intermediate sex forms in the Phyllopod *Simocephalus vetulus*, which reproduces for long periods parthenogenetically. It may be noted that gynandromorphs are really *sex-mosaics*, inasmuch as a definite portion of the body, frequently one half, possesses *in toto* the definite characters of one sex, while the rest of the body is distinctively of the other sex. But sex intergrades are intermediate not as sex-mosaics but quantitatively, and are as a whole different from either the normal male or the normal female. Banta found forms of *Simocephalus* which were male with one or more female secondary sex characters, females with one to several male characters, and some hermaphrodites with various combinations of male and female secondary sex characters.

Eight secondary sex characters distinguish the female of *Simocephalus vetulus* from the male—larger size, position and size of the eye, outline of the head, absence of the nuchal protuberance, features of the first (rudimentary) antennæ, outline and armature of the lateral post-abdomen margins.

The sex intergrades are of almost all possible sorts. More than half the individuals are neither whole male or wholly female, but possess definite morphological sex characters of both sexes. Sex here reveals itself not as a fixed and definite state but as a purely relative thing. The usual sex balance is disturbed. Environmental factors probably wield the determining influence. The disturbance influences not only the individual, but also its germ-plasm, and the disturbed balance is evident throughout succeeding generations. Noteworthy is the production from sex intergrades of strains which produce only normal females, and on occasion only normal males.

Heliotropism of Barnacle Larvæ.†—Jacques Loeb and John H. Northrop have experimented with these larvæ, which move in a straight

* Proc. Nat. Acad. Sci. U.S.A., ii. (1916) pp. 578-83.

† Proc. Nat. Acad. Sci., iii. (1917) pp. 533-44 (2 figs.).

line towards or away from a single source of light and at right angles to the line connecting two lights of equal intensity. The experiments go to show that the "instinctive" movements of these animals are phenomena of automatic orientation (heliotropism), and a function of the constant intensity of light. The exact expression of the function is the Bunsen-Roscoe law of photo-chemical action.

Maxillary Gland of *Cypridina hilgendorfi*.*—Naohide Yatsu describes the minute structure of the group of unicellular glands which forms the maxillary gland. The gland-cells are not differentiated into gland proper and duct. There are two kinds of elements—mucous, with granular cytoplasm; and yellow gland-cells, with fibrillar cytoplasm. The yellow secretion, which emits light, is in the form of coarse, somewhat angular granules. There is no common reservoir for the gland-cells, but the lower part of each gland-cell functions as a temporary reservoir of the secreted products.

Nematohelminthes.

New Nematode from Partridge.†—C. Rodriguez Lopez-Neyra describes *Cyrnea seuratii* sp. n. from the gizzard of the red partridge (*Caccabis rufia*). The genus, one of the Spiroptera, occurs in burrows in the median tunic of the gizzard, between the muscle and the horny lining, and is characterized by the displacement of the vulva towards the posterior end of the body. The body of the new species is robust, translucent white, with a finely striated cuticle, with two strong lateral lips besides a dorsal and a ventral. A contrast is made between the two sexes, and between the new species and the allied *C. eurycerca* Seurat.

Platyhelminthes.

Tapeworms of Reptiles.‡—E. Rudin describes eleven species of Ichthyotæniidæ from reptiles, discusses their common characteristics, and gives a sketch of a natural classification of the family. He deals with eight new species of *Ophiotænia*, and two of *Acanthotænia*, besides *O. racemosa*. Altogether there are now known thirty-nine Ichthyotæniidæ from reptiles and amphibians. They are Tetraphyllids with small head, with sessile suckers without appendices; the apical sucker may be present, absent, or rudimentary; there is no rostellum; they are confined to fishes, amphibians, and reptiles. The family includes six genera:—*Ichthyotænia*, *Choanoscolex*, *Batrachotænia* g.n. *Crepidobothrium*, *Acanthotænia* and *Ophiotænia*. Many details in regard to the minute structure of the new species are communicated.

Dibothriocephalus parvus Stephens.§—F. Zschokke has made a study of this tapeworm from man, which J. J. W. Stephens described

* Journ. Morphology, xxix. (1917) pp. 435-40 (4 figs.).

† Comptes Rendus, clxvi. (1918) pp. 79-82 (2 figs.).

‡ Rev. Suisse Zool., xxv. (1917) pp. 179-381 (3 pls. and 26 figs.).

§ Rev. Suisse Zool., xxv. (1917) pp. 425-40.

in 1908 as a new species. He also discusses the variety *tenellus*, which Grassi established within the species *Bothriocephalus* (or *Dibothriocephalus*) *latus*. He describes his own observations on forms of this species, and comes to the conclusion that *D. parvus* and *D. latus* var. *tenellus* are just cripped forms of *D. latus*.

Hydatid Cysts in Monkeys.*—William Nicoll describes from the abdominal cavity of *Cynocephalus porcarius* a hydatid with numerous scolices attached to the wall of the cyst. It seems to be the hydatid cyst that occurs in cattle, sheep, pigs, deer, and about forty hosts in all, the adult occurring in Carnivores, particularly dogs. The author does not name it.

Trematodes of Australian Birds.†—S. J. Johnston describes no fewer than twenty-one new species, belonging to nine families or sub-families. In connexion with *Scaphanocephalus australis* sp.n., it is suggested that the "cone-shaped" body of Jägerskiöld may assist to form a cavity at the genital sinus, whereby self-fertilization may be secured. Notably minute is the new species *Levinseniella hovensis*, specimens of which are less than a millimetre long. A new genus, *Austrobilharzia*, is established, and is compared in detail with the other genera of the family. Many interesting notes are communicated on the new species; a list of the previously described Australian Trematodes is given; the parasites are also classified under their avian hosts.

Helminthological Notes from Switzerland.‡—Emile André gives a list of Trematodes, Acanthocephala, and other worm parasites which he has observed for the most part near Geneva. The Trematodes include *Diplodiscus subclavatus* (Goeze) from Amphibians (and its cercaria from the grass snake), *Allocreadium isoporum* (Looss) from *Gobio gobio*, *Cryptocotyle concavum* Crepl. from the eider duck, *Plagiorchis mentulatus* from *Lacerta viridis*, *Strigea variegata* (Crepl.) from the bursa Fabricii of a crested grebe, and many more. The Acanthocephala include *Polymorphus minutus* from the swan, *Pomphorhynchus lævis* from *Silurus glanis*, and some others. The Cestodes include *Cænurus serialis* from the rabbit, where it formed a mass the size of a very large apple. The Nematodes noted are *Agamonematodum tritonis* v. Linstow, in *Triton alpestris*, and *Ancyranthus demudatus* v. Linstow from *Phoxinus lævis*.

Echinostoma ilocanum (Garrison).§—J. S. Hilario and L. D. Wharton report the occurrence of this minute fluke in the intestine of patients of the Manila Hospital, natives of Zambales. Garrison's specimens came from Ilocos Sur. The fluke is a blood-sucking parasite, and some anæmia is always associated with its presence. A description is given of its structure and ova.

* Parasitology, x. (1918) pp. 288-9.

† Journ. Proc. Roy. Soc. N.S.W., I. (1916) pp. 187-261 (11 pls. and 10 figs.).

‡ Rev. Suisse Zool., xxv. (1917) pp. 169-77.

§ Philippine Journ. Sci., xii. (1917) pp. 203-13 (2 pls.).

Echinoderma.

Fertilization and Phagocytosis.*—Jacques Loeb suggests that the absorption of the spermatozoon by the ovum may be regarded as a kind of phagocytosis. He bases his suggestion on a study of the conditions which make it possible to fertilize the ova of a sea-urchin, *Strongylocentrotus purpuratus*, with the spermatozoa of a starfish, *Asterias ochracea*. It is not proved that the entrance of the spermatozoon into the ovum depends on processes of phagocytosis (or surface-tension), but the idea of phagocytosis facilitates the interpretation of the phenomena which condition penetration.

Cœlentera.

Studies on Living Corals.†—T. W. Vaughan distinguishes two sub-faunas in the West Indies coral reef: (1) the strong, firmly-attached, usually massive forms, which can withstand breakers and the pounding of the surf, e.g. *Orbicella annularis* and *Acropora palmata*; and (2) the weakly-attached and branching forms, which can only survive in quiet water, e.g. *Mæandra areolata* and *Porites furcata*.

The depth to which the more massive forms extend is between 18 and 31 metres; in general, the lower depth of the shoal-water coral fauna of the West Indies is about 37 metres, approximating to conditions in the Pacific.

All the corals studied have the capacity of removing sediment from their surfaces. This is effected by the non-nutrient particles becoming imbedded in mucus, and by cilia wafting off both.

The food-catching depends on ectodermic nematocysts, ectodermic cilia, mucus secretion, tentacular action, and mesenteric filaments, which in many species can be extruded through the column walls. The food is purely animal plankton.

Strong light is essential for the vigorous growth of shoal-water corals. The minimum temperature for viability is about 18·15° C. Reef-corals are usually, if not always, confined by temperature to water less than 180 metres deep. The limiting of downward growth is also affected by sediment, illumination, and food supply. The salinity limits are between 27 and 38 p.c.

The larval forms are able to swim for two to twenty-three days, which explains the wide distribution. The growth of *Orbicella annularis* is from 5–7 mm. per year. Any known living coral-reef might have formed since the disappearance of the last continental ice-sheets.

Physiology of Medusæ.‡—Naohide Yatsu has made interesting observations on *Charybdea rastonii*, a Cubomedusa common at Misaki. Transference from diffused light to direct sunlight evokes no change in the swimming. The concretion is always at the lowest end of the rhopalium, whatever be the position of the animal. Extraction of the concretion does not cause any change in swimming. Medusæ deprived

* Ann. Inst. Pasteur, xxxi. (1917) pp. 437–41.

† Proc. Nat. Acad. Sci. U.S.A., ii. (1916) pp. 95–100.

‡ Journ. Coll. Sci. Univ. Tokyo, xl. (1917) pp. 1–11 (5 figs.).

of all the rhopalia usually ceased to pulsate. The pulsation centre is between the eye part and the stalk of the rhopalium. The nerve plexus is probably absent in the upper third of the bell and in the region near the velarium. The phacellæ are nine to ten in number in each inter-radial corner of the gastral cavity. They are not dendritic. Each consists of a very elastic stalk and a terminal tuft.

Nerve Conduction in Cassiopea.*—A. G. Mayer finds that the rate of nerve conduction in this Medusa may be independent of the electrical conductivity of the solution surrounding the nerve, but is proportional to the concentration of the sodium, calcium, and potassium cations in the sea-water. R. S. Lillie is right in stating that the rate of nerve conduction in *Cassiopea* in diluted sea-water does not decline in accord with Freundlich's law of adsorption.

Porifera.

Larva of Horse-sponge.†—C. Vaney and A. Allemand-Martin discuss the larval development of *Hippospongia equina* on the Tunis coast. The larvæ escape from the oscula between the end of March and the third week in June. They are covered with short cilia, except on a limited pigmented ring posteriorly, where there are very long locomotor flagella. They seek shade, but not darkness. They are very sensitive to changes in salinity. The whole surface is covered with minute cylindrical epithelial cells. Beneath these is a zone of crowded nuclei. The rest of the body consists of cells mostly fusiform and a number of muscular and elastic fibrils. There is no cavity.

Buds of Donatia.‡—Blanche B. Crozier has studied Bermudian species of *Donatia* (*Tethya*) and their budding. In *D. seychellensis* a typical full-grown bud is spherical or egg-shaped, 2–5 mm. in diameter, of a bright clear orange colour, borne on a stalk projecting on the distal side. They contain, like the body of the sponge, megascleres of the Strongyloxea type, spherasters, oxyasters, and chiasters. The buds drop off and settle on the bottom. A description is also given of two varieties of *D. ingalli* and *D. lycurium*.

Desmacidonid Sponges.§—E. F. Hallmann defines, with much detail as regard the siliceous spicules, the genera *Echinaxia* and *Rhabdosigma*, with remarks on their probable relationships, and re-descriptions of their type-species.

Protozoa.

New Genus of Heliozoa.||—Clifford Dobell describes *Ornerella maritima* g. et sp. n., an Aphrothoracan Heliozoon of very small size (10 μ to 22 μ in diameter). It is a solitary form, free-floating or

* Proc. Nat. Acad. Sci. U.S.A., ii. (1916) pp. 721–6.

† Comptes Rendus, clxvi. (1918) pp. 82–4.

‡ Ann. and Mag. Nat. Hist., i. ser. 9, pp. 11–18.

§ Proc. Linn. Soc., xlii. (1917) pp. 391–405 (2 pls. and 2 figs.).

|| Quart. Journ. Micr. Sci., lxii. (1917) pp. 515–38 (1 pl.).

creeping, feeding chiefly on vegetable matter. It is spherical, with numerous very fine radiate pseudopodia (axopodia), with streaming granules and with axes rooted in a centrally-placed centroplast. It has no stalk, no contractile vacuole, no gelatinous investment, no spicular skeleton, no sharply-differentiated ectoplasm and endoplasm. The nucleus is single, large, excentric, vesicular, with a large karyosome. The reproduction is by equal binary fission, in which the nucleus divides by mitosis, the centroplast playing the part of a centrosome.

Entamœba dysenteriae.*—C. Mathis and L. Mercier discuss the great differences in the dimensions of the cysts in this species. The most frequent dimensions are between 12.5μ and 14μ , but there are some of 10μ and others of 15μ . Some have suggested that there are different races within the species, but the authors are inclined to regard the differences of size as modificational fluctuations, depending on the food or the like.

Rhythms in Endomixis.†—L. L. Woodruff has met the criticism that the re-organization process called endomixis may be peculiar to his long-pedigreed race of *Paramœcium aurelia*. Data from every culture studied, isolated from diverse localities (as widely separated as Germany and Ohio), prove that endomixis is a normal periodic phenomenon which occurs in all races of the species.

Influence of Environment on Endomixis.‡—L. L. Woodruff finds that general changes in the environment of different races of *Paramœcium aurelia*—e.g. markedly different culture media and temperatures—do not permanently alter the length of the rhythm or the time between successive endomictic periods which is characteristic of the species. Sudden marked changes in the normal culture conditions may initially hasten the endomixis, but this is soon compensated for. There is a remarkable synchronism of the endomictic process in all the races bred simultaneously, regardless of the environmental conditions. The length of the rhythm and the rhythmic periods are synchronous. But the "generation-periodicity"—i.e. the number of cell divisions between one occurrence of endomixis and the next—may be modified to a considerable extent by the culture conditions which lower the division-rate. The cessation of endomixis in the experiments was always followed, usually within a rhythm or two, by the death of the culture involved. Everything points to the conclusion that a periodic occurrence of the definitive endomictic phenomena is a *sine qua non* for the continued life of the race.

Genus Loxodes.§—E. Penard discusses some of the peculiarities of this remarkable Ciliate. In reference to *L. rostrum*, he describes, for instance, the external envelope, the buccal area, the attaching filaments, the vacuolation of the cytoplasm, the twenty to thirty nuclei, the abrupt

* C.R. Soc. Biol. Paris, lxxx. (1917) pp. 791-3.

† Biol. Bulletin, xxxiii. (1917) pp. 51-6.

‡ Biol. Bulletin, xxxiii. (1917) pp. 437-62 (12 figs.).

§ Rev. Suisse Zool., xxv. (1917) pp. 453-89 (12 figs.).

disintegration which, after a few hours, leaves no trace of the creature. In reference to *L. striatus*, he deals especially with Müller's vesicle (a statocyst with an enclosed statolith), and with the peculiar nuclei and their division. Penard remains sceptical in regard to Kasanzeff's theory that *L. rostrum* can change in *L. striatus*. As to the unique position of the genus Penard asks whether it is a relict type like *Spirula*.

Classification of Hæmosporidia.*—Carlos França defines the sub-order Hæmosporidia as consisting of Protozoa inhabiting the blood-corpules, either erythrocytes or leucocytes; with a schizogonic phase in a Vertebrate and a sporogonic phase in an Invertebrate. The Invertebrate, in which the sexual part of the cycle occurs, represents the primary host, and is the vehicle of transmission. Along with Coccidia, the Hæmosporidia form the order Coccidiomorpha in the class Sporozoa. The author goes on to define the four families—Hæmogregarinidæ, Plasmodidæ, Piroplasmidæ, and Toxoplasmidæ, and the genera they contain. A list is given of the various species recorded, these being arranged so as to show the hosts.

A provisional classification is submitted:—

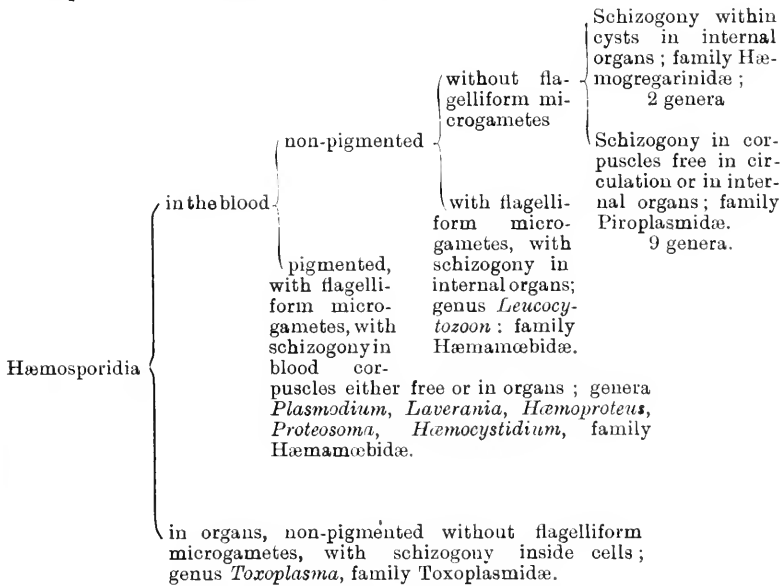

* Journ. Sci. Acad. Sci. Lisboa, i. n.s. (1917) pp. 26-65 (many figs.).

BOTANY.

GENERAL,

Including the Anatomy and Physiology of Seed Plants.

Cytology,

Including Cell-Contents.

Mitochondrias of Plant-cells.*—A. Guilliermond publishes a reply to some of the objections made to recent theories as to the nature and function of the mitochondrias of plant-cells. The writer endeavours to show that the plastids of plant-cells are of the same nature as the mitochondrias of animal-cells, and that such being the case, they are "organisms of elaboration." After prolonged study of these structures in the cells of *Tulipa* and *Iris germanica*, the author is convinced that they are identical with those found in animal-cells. They fall into two categories—viz. short, granular or rod-like bodies, which usually represent a purely vegetative or resting stage; or elongated, thin, flexuose chondriocotes having the power of elaborating pigment, starch, or fat. When osmotic equilibrium is disturbed these latter structures swell and assume the form of vesicles or vacuoles with a thick wall enclosing an aqueous liquid with numerous refractive granules held in suspension. The author points out that these observations are identical with those made by zoologists in connexion with animal-cells. Moreover the behaviour towards staining reagents is the same. Finally, it appears as a result of the present work, that the so-called plastids of plant-cells are of the same nature as the mitochondrias, and share the elaborating functions of the latter. They are not to be regarded as organisms restricted to chlorophyll-producing cells, but as definite organisms of the cytoplasm and the seat of most diverse elaborations both in plant- and animal-cells.

Nature and Function of Chondriomes.†—P. A. Dangeard publishes a summary of his observations, based upon several years' study of chondriomes, which induce him to discredit the theories of those writers who regard chondriomes as living entities giving rise to the various plastids and to cell-contents such as starch, oil, etc. According to the author, the cell encloses (apart from the nucleus) two "sorts of formations—viz. the *plastidome*, composed of plastids, or plastids; and the *chondriome*, or vacuolar system. The latter contains in solution a more or less thick substance—the metachromatin; both the chondriome and the contained metachromatin are entirely independent of the plastidome, and differ from the latter in becoming bright red when stained with Crésyl-blue. This

* C.R. Soc. Biol. Paris, lxxx. (1917) pp. 917-24 (2 pls.).

† Comptes Rendus, clxvi. (1918) pp. 439-46 (4 figs.).

peculiarity in staining makes it possible to follow the different transformations of the vacuolar system, and it is found that mitochondrias, chondriocotes, and chondriomites are transformed so rapidly into each other, often ramifying and anastomosing into a fine network, that it is impossible to regard them as being of the nature of plasts. On the other hand, it is easy to trace the transformation of the elements of the chondriome into ordinary vacuoles. The metachromatin solution is conveyed to those parts of the cell where there is least resistance, and during cell-division is transferred from one cell to another; it is opposite in action to the cytoplasmic fluid, and has a certain osmotic power. The metachromatic corpuscles are formed in the vacuoles at the expense of the metachromatin.

Structure and Development.

Vegetative.

Development of Root-tip in *Sagittaria*.*—R. Souèges contributes a further note upon the embryogeny of the Alismaceæ. The writer has studied the development of the root-tip of *Sagittaria sagittæfolia*, and finds that the lower cell of the pro-embryonic tetrad gives rise to the greater part of the hypocotyl, the hypophysis, and the suspensor. The hypophysis is of complex origin, for it arises from two cells of different ages. The four initial-cells of the root-cap serve only for the increase of the number of layers of this tissue; they divide first by vertical and subsequently by tangential walls. It would appear that those authors are wrong who regard these cells as having the same functions as in other Angiosperms.

The present note will be followed shortly by a full account of the work done in connexion with the embryogeny of *Sagittaria*.

Distinctive Characters of Woods of North American *Platanus*.† W. D. Brush has studied the wood of three species of North American "sycamores"—viz. *Platanus occidentalis*, *P. Wrightii*, and *P. racemosa*—in order to discover some distinguishing characters which would serve for identification. The chief of these characters are the sapwood, the heartwood, and the size of the pith-rays. There is no well-defined limit between the sapwood and the heartwood, but the former occupies only a thin zone and is usually of a different colour. In the first species the sapwood is light brown and the heartwood is of a reddish tinge; in the other species the sapwood is yellowish and the heartwood is darker, but slightly tinged with red. In the eastern species the annual rings are less well-defined than in the other species, but the pith-rays are larger and darker. In tangential section the pith-rays are broadest horizontally and lowest vertically in *P. occidentalis*; in *P. racemosa* they are narrowest horizontally and highest vertically. In *P. occidentalis* the

* Comptes Rendus, clxvi. (1918) pp. 49-52.

† Bot. Gaz., lxiv. (1917) pp. 480-96 (7 pls. and 3 figs.).

average width of the pith-rays is 14 cells, or 0·29 mm., with an average height of 1·36 mm., or 60 cells. In *P. Wrightii* the average width is 8 cells, or 0·16 mm., with average height of 84 cells, or 1·84 mm. In *P. racemosa* the average width is 5 cells, or 0·9 mm., with an average height of 107 cells, or 2·36 mm.

Resin Secretion in Balsamorhiza.*—E. C. Faust has studied the secretion of resin in *Balsamorhiza sagittata* in order to discover the origin of the secretory tissues and the cause of the secretion. This species is the most prominent plant of the inter-mountain of Wyoming (British Columbia), and depends upon the growth of the root-stock for propagation; flowers are produced in the third or fourth season. The radicle is of the tetarch type. The resin-canals arise in two concentric rows above and within the root-stock, with radial canals between the longitudinal ones of the primary series. In the lowest parts of the root-stock and in the subsidiary roots only the outer series of canals is found. There is also a double series of canals in the stem and leaves, viz. an outer series in cavities of the cortex opposite the interfascicular regions, and a second inner series. The root-canals and the stem-canals have a separate origin, and remain distinct. The canals do not appear until resin has been formed in the meristem. Balsamoresene and balsamoresinic acid are formed from inulin in this species, probably by polymerization and reduction. The resene and the resinic acid derived from it are both toxic in character. Secretion is dependent on physiological activity in the meristem, inulin being used in anabolism, and the resene and the resinic acid being waste products. The two latter substances are transferred to schizogenously-formed secretory-canals. It thus appears that "a polysaccharide, inulin, produced during photosynthesis, is broken down, thus causing a bye-product, balsamoresene, to be produced. This resene is then changed to resinic acid."

Reproductive.

Development of Pollen in Salvia.†—P. Guérin contributes a short note upon the stamen and the development of the pollen in *Salvia*. As the result of studying the different stages of growth in numerous species, the writer concludes that the development of the pollen varies with the species. Sometimes the pollen mother-cells form one layer and at other times two layers. The inferior branch of the connective may or may not be fertile; in *S. splendens* it is rarely so; in *S. canariensis* it is frequently so; while in a number of other species it is the normal condition. The loculus is always smaller than that of the upper branch and may be reduced to a single pollen-sac, as in *S. canariensis*, in *S. officinalis*, *S. interrupta*, *S. triloba*, *S. plebeia*, etc., there are two sacs. A number of species, including *S. officinalis*, must therefore be regarded as having bilocular anthers with loculi of unequal size.

* Bot. Gaz., lxiv. (1917) pp. 441-79 (4 pls. and 2 figs.).

† Comptes Rendus, clxv. (1917) pp. 1009-12.

Physiology.

Nutrition and Growth.

Mechanism of Overgrowth in Plants.*—E. F. Smith has experimented with *Bacterium tumefaciens*, the crown-gall organism, with the object of ascertaining if the growth of tumours in plants and animals is due to chemical substances liberated in the tissues of the host by parasites. By means of careful injections from specially prepared cultures the author has succeeded in causing abnormal growths in sufficient quantity to allow of chemical analysis, and has proved that with this species of bacterium the following substances are produced and conveyed to the host-plant:—Ammonia, amines, aldehyd, alcohol, acetone, acetic acid, formic acid, carbonic acid. It has also been proved that ammonia, amines, aldehyd, acetic acid and formic acid are able to induce the growth of tumours. The growths produced were small, but it seems reasonable to believe that if the stimulus were continuous, as would be the case if a living organism were attacked by a bacterium, the growth would continue. The actual mechanism of these growths is primarily due to a physical cause—namely, “to an increase in the osmotic pressure due to the heaping up locally of various soluble substances excreted by the bacteria as a result of their metabolism.” These growths may be regarded as continually modified wound-reactions due to the presence of a parasite.

In conclusion, the writer draws attention to the important bearing which these discoveries may have upon such problems as plant-diseases and monstrosities, various problems of modification by environment, the distribution of dormant germ-cells among somatic cells, and the etiology of various human and other animal tumours.

Injection Experiments on Plants.†—Y. Yendo has experimented with numerous vascular and non-vascular plants in order to discover whether “a certain amount of a substance injected into a certain part of the plant-body is conducted through the entire plant”; also, if “the effect of injection differs according to the kinds of plants, organs, and tissues.” The injections were carried out by means of a medical syringe, and aqueous solutions of lithium-nitrate, copper-sulphate, eosin, and aniline-violet were used. The author finds that the rate of conduction of an injected fluid varies according to the nature of that fluid, lithium-nitrate being the most easily conducted and aniline-violet the least. Injected liquids usually pass to those organs where transpiration is most active; lithium-nitrate when injected into the stem travels more frequently to the leaves than to the inflorescences; when injected into the root or cotyledon it passes to the shoot; when injected into water-plants it passes chiefly to the aerial portions, little or none going to the submerged parts. Injections into deciduous trees during winter travel much less freely than when the tree is in full leaf. Upward conduction is most frequent, downward conduction less so, and transverse conduction

* Proc. Amer. Phil. Soc. (Philadelphia) lvi. No. 6 (1917) pp. 437-44.

† Journ. Coll. Sci. Tokyo, xxxviii. No. 6 (1917) pp. 1-46 (2 pls.).

is very feeble. Injections are conducted mainly through the xylem, less through the phloem, and to a limited extent through other tissues. The rate of conduction varies according to the concentration of the injection, the solution of least concentration travelling at the slowest rate. A few fungi were able to conduct injections, but the algæ scarcely conduct any of them, although a certain amount of diffusion may take place. It is possible to trace the course of vascular bundles by means of injection.

CRYPTOGAMS.

Pteridophyta.

(By A. GEPP, M.A., F.L.S.)

Phylogeny of the Pteroidæ.*—F. O. Bower, continuing his studies in the phylogeny of the Filicales, discusses the Pteroidæ. In summarizing his results, he states that : 1. The stelar ontogeny of *Schizæa* and *Anemia* starts from protostely (*Lygodium*), and shows successive steps of stelar advance, namely, medullated monostele (*S. pusilla* and *S. rupestris*); ectophloic siphonostely (*S. dichotoma*); amphiphloic siphonostely or solenostely (*Anemiorrhiza*); dictyostely (*Eu-anemia* and *Mohria*). In *Schizæa rupestris* and *S. digitata* the sporangia are of marginal origin; and the later-formed indusium originates superficially below the sporangia. 2. Within the *Pteridæ* of Prantl are two probably distinct lines of phyletic—the first called "*Pteridæ* bi-indusiatae," the second "*Pteridæ* uni-indusiatae." With the latter (Cheilanthoid) series the present paper is not concerned; the former (Pterid) series includes *Lindsaya*, *Pæsia*, *Pteridium*, *Lonchitis*, *Histiopteris*, *Anopteris*, *Pteris*, *Acrostichum*, and is traceable from a two-lipped Dicksonioid origin. 3. *Lindsaya* has a primitive type of stele, and also has a fusion-sorus which is actually marginal; and the indusial flaps originate superficially below it; and the sporangia, at first gradate, later become mixed. In *Dictyoxiphium* the fusion-sorus differs in the absence of the upper (adaxial) indusium. 4. The fusion-sorus of *Pteridium* is marginal in origin, with two indusial flaps; the gradate sporangia soon assume a mixed condition. 5. *Pæsia* has a typical solenostele; the marginal sorus is usually two-lipped, but shows inconstancy of the inner (abaxial) indusium. 6. *Lonchitis* is intermediate between the bi-indusiate types and the genus *Pteris*. 7. *Pteris* (*Histiopteris*) *incisa* closely resembles *Pteridium* in habit; it is advanced as regards scales and venation, but less complex in stelar condition. Its fusion-sorus fluctuates from exact marginal origin, and the inner indusium is absent. The sporangia, at first basipetal, become mixed. 8. *Pteris* (excluding *Doryopteris*) has scales as well as hairs, is more or less solenostelic, has a single or double strap leaf-trace, and reticulate venation. The fusion-sorus is superficial in origin; and the inner (abaxial) indusium is absent. The succession of sporangia is mixed. In all these characters there is an advance from the *Lindsaya-Pæsia* type. 9. *Acrostichum præstantissimum* and

* Ann. Bot., xxxii. (1918) pp. 1-63 (43 figs.).

A. aureum appear to be acrostichoid derivations of *Pteris*, from some *Litobrochia* type. 10. Thus, in the Pterid series either the outer (adaxial) or the inner (abaxial) indusium may be abortive. Steps of abortion of the inner indusium are seen in the following Dicksonioideæ—*Dennstædtia*, *Hypolepis*, *Polypodium punctatum*, and *Monachosorum subdigitatum*. In *Hypolepis* and *Monachosorum* the outer (adaxial) indusium may receive a vascular supply from the receptacle, and appear flattened as a marginal lobe of the pinnula. Phyletically *Hypolepis* and *Monachosorum* are derivatives of the Dicksonioid-Dennstædtioid series. (*Acrophorus* and *Cystopteris* are distinguished from these by their scales and advanced dictyostely, and are related to the Nephrodioid ferns.) 11. The large series of the Dicksonioids are characterized by the sori maintaining their identity as discrete developments on the separate endings of the veins. They have dermal hairs, not scales, excepting their Davallioid derivatives. The Dicksonioids probably sprang ultimately from some Schizæoid source, through types of the nature of *Lorsonopsis* and *Thyrsopteris*, and culminated in the Davallioid sequence. 12. The Pterid series are distinguished from the Dicksonioids by the lateral fusion of their marginal sori, which are linked together by lateral commissures. They are related to the Dicksonioids as a collateral branch, attaching probably in the neighbourhood of *Microlepia*; and they culminated in *Acrostichum*. 13. The Cheilantheoids, though usually ranked with the Pterids, have yet to be studied as to whether they have any near phyletic relationships. 14. All the ferns studied for the present memoir belong to the Marginales. In some cases the sorus has slid from a marginal to a superficial position. 15. In the Superficiales the sorus-slide occurred so early in their descent that the two sequences must be regarded as phyletically distinct, notwithstanding all analogies.

Evolution of Branching in the Filicales.*—B. Sahni publishes some observations on the evolution of branching in the Filicales. The most important progress of this evolution has been in specialization for vegetative propagation; but subsidiary efforts have been made in the direction of epiphytism (*Nephrolepis volubilis*) and of food or water storage (*N. tuberosa*, etc.). It is found that the branching of ferns may be arranged in a series beginning with those in which the rhizome divides into two more or less equal branches, and ending with forms in which the proximal part of one of the branches attains a great length and bears either reduced leaves (*Struthiopteris*, etc.), or none at all (*Nephrolepis*). This portion, a stolon, serves to remove the leafy branch-apex away from the mother-axis and sustain it until it forms an independent root-system. The process is carried to an extreme in *Nephrolepis* by the production of a large number of lateral branches, each of which is a potential individual plant. The view that this elaborated form of branching is derived from the simple dichotomous type, and is connected with it by an unbroken series of transitions, is corroborated by a study of the branching of ferns from the point of view of their vascular anatomy. In the latter case a series of transitions is found parallel to the former. When the growing apex of a

* *New Phytologist*, xvi. (1917) pp. 1-23 (figs.).

fern stem divides, the resulting growing points may continue to grow simultaneously (dichotomy), or one of them may at once become dormant, while the other continues its growth in the line of the original axis (monopodial axis); or, thirdly, the dormancy of one of the growing points may be delayed for a variable period. The second case is derived from the first and involves the sacrifice of one branch for the good of the other; the third case is intermediate. But there is no parallelism between the evolution of the modes of branching on the one hand and the evolution of the plants themselves on the other; the two processes have been independent of each other. Dichotomy still persists among the higher ferns, while some of the most primitive ferns (Ophioglossaceæ) show an advanced monopodial type of branching. The monopodial type of branching has been derived from the dichotomous by a process of retrogressive evolution in the basipetal direction, involving the successive intercalation, at the base of the branch, of a series of stages, each morphologically less complex than the preceding. This process naturally finds its full illustration in ferns with reticulate steles. The basal protostele of the specialized branch is therefore a cœnogenetic feature, not strictly primitive. The departure from dichotomy was entered upon at a very early period in the history of the Filicales.

Viewing the group of Filicales as a whole it may be said that the branches do not hold any regular position with respect to the leaves, and where the branches do arise in some relation to leaves, this association is, in its evolutionary origin, a secondary phenomenon attributable to possible biological advantages, one of which may be the protection of the young bud. In such cases the stele of the axillary branch may arise independently of the subtending leaf-trace, or may sometimes be confluent with it at base. As to adventitious buds on the fronds and the formation of new individuals from them, this is the most recently evolved method of branching; but it is difficult to relate it to the usual method, in which the branches always spring from buds laid down at the growing apex of the mother-axis.

Cone of *Selaginella pallidissima*.*—S. I. Ghose describes the external morphology of the cone of *Selaginella pallidissima*. It is a branched structure up to 5 cm. long. The sporophylls are very little differentiated from the ordinary vegetative leaves and are inserted quite loosely on the axis, so that the cone does not at all form a separate compact structure. The sporophylls of the upper plane are quite sterile, and only those of the lower plane have sporangia, one in the axil of each sporophyll. Megasporangia and microsporangia are distributed indiscriminately on the cone. Sometimes megasporangia are unequal in size. Microsporangia are saddle-shaped. The cone can be regarded as a very primitive one on account of its big size, branched nature, loose insertion of sporophylls, little differentiation of the latter from ordinary foliage leaves, and indiscriminate distribution of megasporangia and microsporangia on the axis. The absence of any dorsal flap or ridge on the comparatively simple sporophylls of *S. pallidissima* and a comparison of the more complex sporophylls of *S. spinosa*, *S. Emmeliana*, *S. serpens*,

* Journ. Bombay Nat. Hist. Soc., xxv. (1917) pp. 284-9 (1 pl.).

S. Martensii, *S. Kraussiana*, *S. chrysocaulos* and *S. chrysorrhizos*, tend to show that the presence of the dorsal flap in the sporophylls of *Selaginella* is not primitive, but has been evolved in the genus

Asplenium Seelosii Leyb.*—L. Diels discusses the ecology of *Asplenium Seelosii*, having studied the earlier development stages in the Dolomites. The hairs of the primary leaves consist of cylindrical cells of equal diameter, and contain chlorophyll grains; they serve for the absorption of dew. A necessary condition for the development of the fern is the association of algae and moss, namely, *Eucladium verticillatum* and colonies of *Nostoc* in the clefts of the Dolomite. The young plant turns its leaves to the illuminated surface of the rock-wall, the orientation being brought about by means of the stipes. It curves itself downwards in the upper third, and thereby brings the lamina into the light. A plant 6 cm. high has a root system which penetrates 20 cm. deep into the rock. The luxuriantly produced spores are mostly distributed by small animals (wood-lice). The dead fronds remain long on the plant. The prothallium grows in clefts containing clay, the fronds accommodating themselves to the dry rock surface. The species appears to have a defined habitat between Ètsch and Tagliamento. Since the species belongs to the genetic Mediterranean element of the Alpine flora, it is possible that it occurs as Christ states in the Catalonian Pyrenees.

Bryophyta.

(By A. GEPP.)

European Hepaticæ. †—K. Müller publishes a further part of his Liverworts of Germany, Austria and Switzerland. In it he deals with the puzzling genus *Cephaloziella*, following Douin's grouping, but without according generic rank to the separate groups. Critical remarks are given for *C. striatula*, *C. Limprichtii*, *C. Bryhnii*, *C. bifidioides*, and *C. dentata*. A new diagnosis and figures are given of *C. obtusa*, an ally of *C. integerrima*. Under *Calyptogeia* it is shown that *C. paludosa* is in no way worthy of specific rank, and that the sporogonium-valves of *C. sphagnicola* are liable to many variations of cell-structure. Under *Pleurozia* it is stated that the sterile tubular-organs are also found on the European species. In this part begins Section VIII of the whole work, which is devoted to the geographical and ecological distribution of the European liverworts. Up to the present time lack of definite knowledge as to the limits and true relations of the various species, as well as their general and European distribution, has prevented a complete treatment of their distribution as a whole. The author shows that liverworts, like the higher plants and the ferns, have strictly limited areas, and that only a few are cosmopolitan. One of the most important results of this study of distribution is the conclusion that liverworts

* Verh. Bot. Ver. Prov. Brandenburg, lvi. (1914) pp. 178-83. See also Bot. Centralbl., cxxxiv. (1917) p. 330.

† Rabenhorst's Kryptogamen-Flora, Band. vi.: Lebermoose. Leipzig: 1916, pp. 785-848 (figs.). See also Bot. Centralbl., cxxxiv, (1917) pp. 345-7.

differ as regards their geographical distribution absolutely from phanerogams and mosses, and follow more the lines of the lower organisms, notably algæ. For in contrast to the two higher groups named they have hardly developed a single endemic mountain species since early Tertiary times. Another point of interest is the markedly large number of species common to Europe and N. America, and apparently to Asia. The various regions are discussed and compared with the flora of similar regions in other continents and islands; and the results are given in tabular form at the end.

North American Hepaticæ.*—A. W. Evans publishes notes on the structure, life-history and distribution of *Scalia Hookeri*, *Haryanthus Flotowianus*, and *Calypogeia fissa*, which are recorded for the first time from New England, and on the structure and systematic position of *Riccia Frostii*, whether or not it should be transferred to *Ricciella*.

Indian Liverworts.†—S. R. Kashyap publishes an account of thirty-one thalloid hepatics collected by him in the Western Himalayas from Mussoorie to Kashtwar in 1912-14. Structural and systematic details have already been published in vols. xiii, xiv of "The New Phytologist." Among the novelties in the present paper are two new genera:—1. *Mindal pangiensis*, named after Mindal temple in Pangie, where it occurs commonly at an altitude of 8000 feet; it has affinities with *Reboulia* and *Plagiochasma*. (2) *Sauchia spongiosa*, named after Sauch Pass, 10,000 feet, forms a connecting link between the *Astroporeæ* of Leitgeb and the *Ezormotheca* line. Two new species of *Fimbriaria*, one each of *Grimaldia* and *Athalamia*, and five of *Riccia* are described. The author holds that his view as to the origin of the *Ricciæ* from a *Targionia*-like ancestor is confirmed by a comparative study of these new species of *Riccia*. *Cyathodium* represents one step in the shifting of the archegonia to the dorsal surface. By a further forward growth of the thallus in *Riccia pathankotensis* the archegonia become shifted into a broad dorsal channel, and the involucre is suppressed. The most reduced stage is represented by *R. sanguinea*, which has no trace of a dorsal channel, and an absence of scales and tuberculate rhizoids. But it is possible that *Riccia* has originated from two sources, for the structure of the section *Ricciella* resembles that of *Corsinia*.

The author ‡ in completing his paper gives a list of fifteen more species, among which is a new species of each of the following genera: *Fimbriaria*, *Plagiochasma*, *Riella*, *Aneuræ*, *Metzgeria*, *Anthoceros*.

South African Hepaticæ.§—T. R. Sim, while collecting materials for a handbook of South African Bryophyta, gives a general introductory account of the macroscopic structure of the native hepaticæ, and of their ecology and reproduction, with a discussion of the questions of variation and migration, and a history of South African hepaticology.

* Rhodora, xix. (1917) pp. 263-72.

† Journ. Bombay Nat. Hist. Soc., xxiv. (1916) pp. 343-50 (5 figs.).

‡ Journ. Bombay Nat. Hist. Soc., xxv. (1917) pp. 279-81.

§ South African Journ. Sci., xii. (1916) pp. 426-47.

He has also drawn up a synopsis of 47 genera and 163 species, furnishing short descriptions of the orders, families and genera, but not of the species.

Pottia.*—C. Warnstorf publishes some studies on the genus *Pottia*, as a preliminary to a monograph of *Pottia* Ehrh. (sens. str.). In an introduction the author gives a general account of the distribution and organization of *Pottia* in a restricted sense, and then deals with the systematic arrangement. Material from the Berlin Botanical Museum is discussed, including *Gomphonuron Lorentzii* Warnst., and *Didymodon argentiniensis* Warnst., a new species, as well as a large number of specimens which lack sporogonia. *Pottia Macleana* Rehm. is placed in *Pterygoneurum*, and is described and figured. In a Latin key the genus is divided into Rhynchostegiæ and Conostegiæ, and each is further divided into Gymnostomæ and Odontostomæ; thus arranging the species under four distinctly marked morphological groups. Diagnoses of each species follow with critical notes, and figures of the distinguishing characters. The circle of *P. Heimii* is made to include as new varieties or forms six hitherto independent species. Four species are sunk into *P. truncata* as varieties. Three new species are described.

Mosses of North-west Germany.†—R. Timm gives a list of species new to the region of Hamburg, Schleswig-Holstein, Lübeck, and the Lüneburg Heath, including a few Liverworts. *Fontinalis laxa* Warnst. is recorded in fruit for the first time. To many of the records are appended notes of a morphological and biological character, notably *Campylopus brevipilus*, *Cratoneuron decipiens*, *Fissidens exilis*, *F. pusillus*, and *Tetraplodon mnioides*. *Oligotrichum hercynicum* is recorded from a clayey ditch on the Lüneburg Heath.

Thallophyta.

Algæ.

(By MRS. ETHEL S. GEPP.)

Caledonian Phytoplankton.‡—E. Teiling publishes a preliminary account of Caledonian phytoplankton. Wesenberg-Lund has divided Europe into four regions, one of which is N. and W. Europe. The author regards England as being typical of this region, as the English fresh-waters contain quantitatively little, qualitatively very rich, phytoplankton. A large number of Desmids and Protococcoideæ are present, a considerable Diatom flora, and a quite inconsiderable Myxophyceæ flora. The Baltic plankton contains fewer species of algæ, which almost all occur in England; the association, however, shows a quite distinct

* Hedwigia, lviii. (1916) pp. 35-80, 81-152 (67 figs). See also Bot. Centralbl., cxxxiv. (1917) pp. 332-3.

† Allgem. Bot. Zeitschr., xxii. (1916) pp. 17-27. See also Bot. Centralbl., cxxxv. (1917) pp. 45-6.

‡ Svensk. Bot. Tidskr., x. (1916) pp. 506-19. See also Bot. Centralbl., cxxxv. (1917) pp. 83-4.

picture. Very few species of Desmids and green algæ occur, and these almost disappear in summer. On the other hand, a Diatom flora flourishes in spring, autumn and winter, poor in quality, but very rich in quantity. In summer the Baltic fresh-waters are characterized by a monotonous Myxophyceæ flora, very rich in quantity, which mostly appears as water-bloom. The author has examined waters in the neighbourhood of Stockholm and finds therein both types of plankton. Most of them are typically Baltic, but two contained English and Norwegian species. The author maintains that this difference of plankton vegetation depends on the peculiar composition of the lakes. Waters in thickly inhabited districts are fouled by nitrogen-containing matter, which encourages the development of Myxophyceæ. The Baltic waters are in districts which have been built over for a long time; while the mountain waters in the highlands of England, Norway and Sweden are poor in nitrogen, and are therefore not inhabited by Myxophyceæ, but by Chlorophyceæ. The author regards the following species as the most leading features of the Caledonian plankton-formation:—*Arthrodesmus Incus*, *A. quiriferus*, *A. crassus*, *Cosmarium contractum* var. *ellipsoideum*, *Spoudiplosium planum*, *Staurastrum aretiscum*, *S. lunatum* var. *plancticum*, *Xanthidium antilopæum*, *Crucigenia rectangularis* and var. *irregularis*, *Quadrigula closterioides*, *Stichoglossa Deederleini*, *Ceratium curvirostra*, and *Tabellaria flocculosa* var. *pelagica*.

Heterodinium in the Adriatic.*—J. Schiller describes the differences between the genera *Peridinium* and *Heterodinium*. Two new species are described: *H. crassipes*, which occurs in very salt water in Dalmatian waters, rarely in the high seas, never on the Italian coast waters, stenohaline; *H. Kofoidi*, with very transparent frustule, found throughout the entire middle and south Adriatic, at a depth of 10 m., in autumn and winter, strongly euryhaline and stenotherm, and, therefore, with a wide power of physiological adaptation.

Chætoceros criophilus.†—L. Mangin, having studied the plankton of the Antarctic Expedition of the "Pourquoi-pas?" and of the "Scotia," finds that the true *Chætoceros criophilus* Castr., has nothing to do with the Arctic forms attributed to it, and he denies the presence of the true *C. criophilus* in the Arctic zone. He gives a detailed description of the species, with figures, illustrating among other points the insertion of the horns. In a later paper the author treats of the forms designated by authors as *C. criophilus*. The *C. criophilus* of Gran is considered a new species, to which the author gives the name of *C. concavicornis*, with a variety *curvus* (Cleve). The only true *C. criophilus* is the species described by Castracane in the Diatoms of the "Challenger" Expedition, and it differs from the Arctic *C. concavicornis* by the mode of the insertion of the horns. The latter species is most closely allied to *C. peruvianus*, and its synonyms are: *C. criophilus* Joerg., *C. Brightwellii* Gran, *C. borealis* var. *Brightwellii* Cleve, and *C. peruvianus* Vanhöffen.

* Arch. Protistenk., xxxvi. (1916) pp. 209-13 (4 figs.). See also Bot. Centralbl., cxxxv. (1917) p. 52.

† Comptes Rendus, clxiv. (1917) pp. 704-9 (4 figs.); 770-4 (3 figs.).

Diatoms from Hanover and the Harz.*—A. Peter gives a list of Diatoms from Southern Hanover and the Harz Mountains, with their distribution. Comparisons are made between the different localities, and critical remarks are given. Twenty-eight genera and 173 species and many forms are recorded.

Changing Diatoms of Devil's Lake, North Dakota.†—C. J. Elmore discusses the phenomenon of the changing diatoms in Devil's Lake, North Dakota. The lake is passing through a rapid transition, having been formerly a fresh-water lake fed by streams. The water is now becoming salt, but the salinity is quite different from that of the sea. The author identified 56 species of diatoms. Of these, 25 are genuine fresh-water species; 20 are found in fresh or brackish water; 2 in fresh, brackish, or salt-water; 2 in brackish or salt-water; and 4 marine only. The importation of the marine species can be explained by the action of migratory birds. The greatest anomaly is presented by the 25 species of fresh-water diatoms, for there is nothing in their appearance to indicate that they have been in any way modified by their change of environment. This fact would tend to confirm what has been observed elsewhere, namely, that diatoms adapt themselves readily to changes in environment.

Myxophyceæ of North America.‡—J. E. Tilden publishes a synopsis of the Blue-green algæ. The first part of her work is devoted to an account of the group under the following headings: Collecting Blue-green algæ, structure, reproduction, water-supply algæ, thermal algæ, calcareous algæ. Descriptions are then given of the families, Chroococcaceæ, Oscillatoriaceæ, Nostocaceæ, Scytonemaceæ, Stigonemaceæ, and Rivulariaceæ. Then follow keys to the genera and species, with references to the figures on the plates. A glossary and bibliography complete the work.

Algæ of Michigan.§—E. N. Transeau publishes a list of algæ collected by himself and others in the ponds, lakes, and streams. The species are for the most part new records for the State. In addition to the records, there are some indications regarding the distribution of the fresh-water algæ that are of interest. The variety and abundance of the Green algæ decrease notably as we go northward, while the Blue-green algæ form an increasingly conspicuous part. *Zygnema cyano-spermum* Cleve, previously reported only from Greenland, is recorded. One new species and two new varieties are described.

Desmid Flora of Dartmoor.||—G. T. Harris has explored five districts of middle and north Dartmoor—Metherall, Gidleigh, Lydford, Haytor, Postbridge—and gives a tabular census of the 399 species and varieties, with their distribution and relative frequency; also a general

* Nachr. kgl. Gesell. Wiss. Göttingen, 1913, pp. 1-83. See also Bot. Centralbl., cxxxv. (1917) pp. 68-9.

† Bot. Gaz., lxxv. (1918) pp. 186-90.

‡ Trans. Amer. Micr. Soc., xxxvi. (1917) pp. 179-266 (13 pls.).

§ Ohio Journ. Sci., xvii. (1917) pp. 217-32.

|| Journ. Quekett Micr. Club, xiii. (1917) pp. 247-76 (2 pls.).

introduction, a number of special notes. About a score of the plants are figured. Previous literature on the subject is very scanty, and the species recorded very few. The bogs explored by the author are mostly situated at altitudes of about 12–1300 ft.

Meringosphæra.*—J. Schiller writes on new species of *Meringosphæra* and the deposition of silica in the membrane. The species described by Lohmann are discussed and partly figured. *M. mediterranea* was found by the author in the northern part of the Adriatic, descending to 20 metres deep, sparingly distributed, living also in brackish water. Two new species, *M. Henseui* and *M. trisetata* (with three bristles) are described. The former is a stenohaline, purely salt-water species, the latter a typical brackish-water form. *M. divergens* at Messina is not euryhaline. Wille places the genus in Chlorophyceæ (Oocystaceæ). It is the first green alga recorded with a siliceous membrane. *Phæodactylum* Bohlin has a weakly silicified membrane and hardly belongs to the Chlorophyceæ. The three species of *Meringosphæra* recorded from the Adriatic are described and figured.

Algæ of the Hawaiian Archipelago.†—V. MacCaughey has made a study of the algæ of the Hawaiian Archipelago, during a residence of ten years in the islands, and publishes here his results. He quotes also the records of other collectors, notably Tilden, Reed and Lemmermann. In the first part of his paper he discusses coral reefs, Kauai and Oahu, ecological zones on reef, tides, coralline algæ, tidal pools, coral reefs on other islands, Taro loi and rice-fields, ditches and flumes, caves, mountain streams, hot springs and thermal waters, summit bogs, brackish waters, halophytes, fish-ponds, phytoplankton, deep-water forms, and endemism. In the second part he gives a list of all the species recorded, with the habitat and geographical distribution. Items of special interest, such as economic uses, are also noted. The chief aim of the whole paper is to summarize available data, and thus to indicate the need for more detailed and intensive investigations.

Calcareous Algæ from Malta.‡—C. Samsonoff-Aruffo publishes the result of her examination of four samples of calcareous colonies of *Lithothamnion* collected by Prof. de Stefani in different localities in Malta, especially in the Helvetian limestone of the Middle Miocene. The paper also contains an account of the first sample coming from Kala (Gozo), in which the authoress recognizes the existence of *Lithothamnion intermedium* Kjellm., and of *Goniolithon Martellii* Sams.

Marine Algæ of Denmark.§—L. N. Rosenvinge publishes the second part of the Rhodophyceæ in his important monograph on the

* Arch. Protistenk., xxxvi. (1916) pp. 198–208 (9 figs.). See also Bot. Centralbl., cxxxv. (1917) p. 53.

† Bot. Gaz., lxxv. (1918) pp. 42–57, 121–49.

‡ Rend. R. Accad. Lincei, ser. 5, xxvi. (1917) pp. 564–9. See also Nuova Notarisa, xxix. (1918) pp. 48–9.

§ D. kgl. Dansk. Vidensk. Selsk. Skrift., ser. 7, vii. (Kjøbenhavn, 1917) pp. 154–284 (2 pls. and 128 figs. in text).

marine algae of Denmark. In the notes appended to each record the author discusses their structure and development in great detail, and adds a large number of new figures to illustrate his full descriptions. New species are described in several genera.

Fungi.

(By A. LORRAIN SMITH, F.L.S.)

Morphology and Cytology of the Sexual Organs of *Phytophthora erythroseptica* Pethyb.*—P. A. Murphy has made a careful cytological study of the whole process of fertilization in this fungus. He confirms the work done by Pethybridge, and adds further details.

Study of *Phytophthora*.†—J. Rosenbaum has published a systematic study of the various species of each genus, giving the morphological and other characters that are of importance in determination of the species. He decides that the separation and relationship of species should be made on the aggregate of characters, it being borne in mind that the proportionate value to be attached to each character must necessarily vary. In measuring conidia, the ratio of length to width is of extreme importance. On the lines indicated he has drawn up a key for the determination of the various species.

Development of *Thraustotheca*.‡—This water-mould, which was first discovered in Germany, appeared recently at Great Barrington, Mass., and a cultural development study of it has been made by W. H. Weston. The results include the formation of sporangia and spores, and of the sexual organs and their spores. The writer finds a resemblance to *Achlya* rather than to *Dictyuchus*.

Anomalies in *Mucorini*.§—F. and Madame Moreau have experimented with *Sporodinia grandis* on a variety of culture media, and have shown the very great variations in spore sizes and forms thus produced. Great differences in size were also noted in the sporangiophores and in the zygosporoes.

In cultures of *Mucor Mucedo* a sporangium was produced without a columella, and with spores occupying the upper parts of the stalk as well as the sporangium.

Life-history and Poisoning Properties of *Claviceps Paspali*.||—The forage grass *Paspalum dilatatum* is much used for feeding cattle in the States, but it has been found that the cattle are liable to be poisoned

* Ann. Bot., xxxii. (1918) pp. 115-53 (2 pls.).

† Journ. Agric. Research, viii. (1917) pp. 233-76 (7 pls. and 13 figs.).

‡ Ann. Bot., xxxii. (1918) pp. 155-73 (2 pls. and 2 figs.).

§ Bull. Soc. Mycol. France, xxxiii. (1918) pp. 34-49 (12 figs.).

|| Journ. Agric. Research, vii. (1916) pp. 401-5 (2 pls. and 1 fig.).

by the sclerotia of *Claviceps* which develop in the grass heads. In some pastures 90 p.c. of old grass heads showed infection. The sclerotia when mature are globular in shape. They fall to the ground in autumn, and germinate in spring when the grasses begin to flower, the pistil of the flower being attacked by the germinating spores, which are probably carried by insects. The fungus produces a peculiar nervousness, and in the end may be fatal. Moving pastures one or more times, as mature sclerotia threaten to become abundant, is an effective method of preventing poisoning.

Effect of Fusarium on Potato Tubers.*—L. A. Hawkins has shown by a series of experiments in connexion with the nutrition of fungi, that generally the fungi in the potato "reduce the contents of sugar, both sucrose and reducing sugar, pentosans, galactans and dry matter. The starch and methyl pentosans are apparently not affected appreciably, and the crude-fibre content was not reduced." It was shown that the two species *Fusarium radicolica* and *F. oxysporum*, both of them tuber-rot fungi, secrete sucrose, maltase, xylanase and diastase, and that the diastase is apparently incapable of acting on unaltered starch grains. When potato starch is gelatinized it is then readily hydrolyzed by the enzymes. The fungi grow for the most part in the cell-walls and are thus set in close contact with the starch grains.

Aspergillus niger Group.†—C. Thom and J. N. Currie give us a cultural study of the species grouped round *Aspergillus niger*. They grow under a wide range of cultural conditions. The range of morphological characters point to the existence of a series of closely related strains in which the differences are shown in measurement of parts, intensities of colour, and quantitative differences in the production of particular reactions. The writers gather from their results that *A. niger*, as commonly understood, belongs to an unstable or mutating group, comparable to *Enothera* spp. They reject the generic name "*Sterigmatocystis*," based on the character of the sterigmata; they see no evidence for separating the species of that genus from *Aspergillus*. They have grouped the many species described under representatives of sections. These are: *A. nuuus*, the diminutive form; *A. niger*, with primary sterigmata, 20–30 μ in length; *A. phoenicis*, with three sterigmata, about 50 μ in length; *A. pulverulentus*, or *A. Strychui*, with very long sterigmata; *A. Carbonarius*, with long sterigmata and very long conidia, from 5.5 μ to 10.5 μ in diameter.

Endophyllum Spores.‡—F. and Madame Moreau find that the acidiospore of *E. Euphorbiæ-silvaticæ* is constantly bi-nucleate. The two nuclei pass into the promycelium, and there divide. There is at no time any karyogamy.

* Journ. Agric. Research, vi. (1916) pp. 183–96.

† Journ. Agric. Research, vii. (1918) pp. 1–15.

‡ Bull. Soc. Mycol., France, xxxiii. (1918) pp. 97–9 (5 figs.).

Ustilagineæ.*—Alden A. Potter and G. W. Coons give notes on the differences between *Tilletia lævis* and *T. Tritici*. These consist in their effect on the flowering-stalk, and in the sori on the smutted grains. The distribution of the two species is also discussed.

Uredineæ.—E. C. Stakman † has carried out a series of infections of Timothy-grass by *Puccinia graminis* in order to study the possible origin and developmental tendencies of biologic forms. The uredine of Timothy-grass, *Puccinia Phlei-pratensis*, resembles very closely the biologic form *P. graminis-avenæ*, and the latter was used in the inoculations. It was found possible to infect with this fungus, but the spores produced were considerably reduced in size. Practically the same results were obtained when barley was used as the host-plant. Stakman considers that *P. Phlei-pratensis* may thus have been evolved through *P. graminis-avenæ*.

R. H. Colley ‡ has found the teliospores of *Cronartium ribicola* developing internally in the petioles of *Ribes*, chiefly in the pith and pericycle region. Such development has been recognized in the rusts, and should be regarded, he says, as a rather common teratological phenomenon.

R. E. Stone § gives a note as to the distribution of *Gymnoconia interstitialis* in Canada, an orange-rust of *Rubus* spp. Notes are also given of the germination of the spores of the *Cœoma* stage.

J. R. Weir and E. E. Hubert || have made a series of inoculation experiments with the spores of *Hyalospora Polypodii*, which grows frequently on *Woodsia*, and of *H. aspidiotus* on *Phegopteris*. The results of their experiments went far to prove that these rusts have no alternate hosts, that they winter over by means of teliospores, and are propagated during the summer by uredinia.

E. C. Stakman and F. J. Piemeisel ¶ give descriptions and results of experiments with the biologic forms of *Puccinia graminis* on cereals and grasses. Tables are given showing the inoculation results from one host to another, and the effect of external conditions. A long summary of the results obtained is appended.

Paul C. Standley ** publishes a list, with copious notes, of rusts and smuts collected in New Mexico in 1916. The species are not new, but in some the hosts are new.

J. R. Weir and E. E. Hubert †† have made observations on the over-wintering of rusts on forest trees, and find that a number continue growth by means of the uredineal stage.

The same writers †† also publish results of cultures of *Melampsorella*

* Phytopathology, viii. (1918) pp. 106-13 (4 figs.).

† Journ. Agric. Research, vi. (1916) pp. 813-16.

‡ Journ. Agric. Research, viii. (1917) pp. 329-32 (1 pl.).

§ Phytopathology, viii. (1918) pp. 27-9 (1 fig.).

|| Phytopathology, viii. (1918) pp. 57-8.

¶ Journ. Agric. Research, x. (1917) pp. 429-95 (8 pls.).

** Mycologia, x. (1918) pp. 34-42.

†† Phytopathology, viii. (1918) pp. 55-9.

‡‡ Phytopathology, viii. (1918) pp. 114-8.

spp. and *Melampsora* sp. on trees. *M. elatina* causes witches'-broom and a dwarfing of tips and branches of *Picea excelsa*.

New or Rare Fungi.—E. Boudier* has described a number of new species under the title "Dernières étincelles mycologiques." He is on the eve of his ninetieth year, and explains that the species now described have accumulated during his work on the "Icones." The list includes Basidiomycetes and Ascomycetes, all of them illustrated in colour.

F. and Madame Moreau† describe a Pyrenomycete, *Epicymatia aphthosæ* sp. n., which was growing as a parasite on the lichen *Peltidea aphthosa*. It occurs in the region of the cephalodia.

A new species, *Melanospora Manginii*, has been described and figured by F. Vincens,‡ obtained in a gelatine culture of "blue wood."

A new Discomycete, *Tricophæa Boudieri* has been described by L.-J. Grelet.§ It grew on shaded marshy soil.

N. Patouillard has described a series of fungi from Tonkin, a number of them new to science.

Fungi from Southern China.||—H. S. Yates publishes the fungi of a small collection made by E. D. Merrill. Most of them were forms already known, and of wide distribution. Only microfungi had evidently been collected. There is a new species of *Trabutea* (Phyllachoraceæ), and a new Uredine, *Uredo cantonensis*. *Cercospora personata*, recognized as a serious disease of pea-nut in the West Indies, was also collected.

Two Remarkable Discomycetes.¶—E. T. Harper describes fully two large Ascomycetes from Michigan and Illinois. These are *Underwoodia columnaris*, a new member of the Helvellaceæ, the ascophores of which are columnar, and the hymenium covers the exterior. The second, *Pustularia gigantea*, was previously described, but is now published with more details and with photographs.

Fungus Fairy Rings.**—A study of these rings in Eastern Colorado, especially those caused by *Agaricus tabularis*, and their effects on vegetation, has been made by H. L. Shantz and R. L. Piemeisel. They give a long list of fungi which have been observed to form the rings, due to the centrifugal growth of the mycelium from the point of departure. The effect of the fungus filaments on the soil is to reduce a part of the organic matter to ammonia, which forms ammoniacal salts, or becomes converted by bacteria from nitrites to nitrates. The increase in nitrogen stimulates the growth of grasses, etc., making larger demands on the soil-moisture. When this is exhausted by *A. tabularis*, the felt of hyphæ prevents the penetration of rain-water, and the surface-plants die of drouth. The area is thus left bare, but in a few years the

* Bull. Soc. Mycol. France, xxxiii. (1918) pp. 7-22 (6 pls.).

† Bull. Soc. Mycol. France, xxxiii. (1918) pp. 23-7 (2 figs.).

‡ Bull. Soc. Mycol. France, xxxiii. (1918) pp. 67-9 (1 fig.).

§ Bull. Soc. Mycol. France, xxxiii. (1918) pp. 94-6 (1 pl.).

|| Phil. Journ. Sci., xii. (1917) pp. 313-16.

¶ Bull. Torrey Bot. Club, xlv. (1918) pp. 77-86 (3 pls.).

** Journ. Agric. Research, xi. (1917) pp. 191-245 (31 pls.).

mycelium dies and moisture again penetrates the soil. The succession of vegetation on the bare area is then (1) an early-weed stage, (2) a late-weed stage, (3) a short-lived grass stage, (4) a perennial stage, which in time gives way to (5), the original short-grass cover. A copious bibliography is appended.

Climatic Conditions and Conidial Development.*—V. W. Pool and M. B. McKay have carried out a research on this subject, with special reference to the wintering of *Cercospora veticola*, the fungus of sugar-beet leaves. During the winter the conidia remained viable for about eight months in dry conditions; in a moist atmosphere they died in from one to four months. Humidity is of much more influence than temperature on the development, and conidia are therefore more abundant on the lower surface of the leaves, but also partly because they are washed off the upper surface by rain.

Effects of Pasteurization on Mould-spores. †—C. H. Thom and S. H. Ayers have directed their attention to the success attained in destroying spores of fungi in milk by various stages of heating. The different processes are described, with the results obtained. The "holder process," in which milk is heated to 145° F. for a duration of thirty minutes, killed the conidia of every species investigated except those of *Aspergillus repens*, *A. flavus*, and *A. fumigatus*, and these occur very rarely in milk. After the "flash process" (165° F. for thirty seconds) very few mould-spores survived. *Oilium lactis* and *Mucors* are killed by the low temperature of the former process.

Relation of Fungi to Host. ‡—Neil E. Stevens has published the results of an investigation as to the effects of *Botrytis* on strawberries, as compared with that of *Rhizopus*. With the former the mycelium invades the cells of every part of the fruit, filling them up and producing somewhat of a mummified condition. The *Rhizopus* hyphæ grew between the cells, chiefly in the outer portions of the berry, separating them and apparently extracting the cell-sap, but if grown on berries in a dry atmosphere the mycelium penetrates to the centre of the berry, and hyphæ are frequently found inside cells. The berries attacked by *Rhizopus* are soft and easily flattened. Stevens cites from literature a parallel case where a *Mucor* reduced the pulp of a tomato to a fluid-mass, the mycelium in this case also growing between the cells, while *Fusarium*, which penetrated the cells, produced a dry-rot.

Effect of Black-rot Fungus on the Apple. §—C. W. Culpepper, J. S. Caldwell, and A. C. Foster record results of their investigation as to the effect produced by *Sphæroopsis malorum* on the tissues and cell-contents of the apple. The fungus attacks branches, twigs, leaves and fruit; their attention was restricted to the fruit. The loss of water, they found, was small, but there was a very considerable reduction of

* Journ. Agric. Research, vi. (1916) pp. 21-60 (2 pls. and 10 figs.).

† Journ. Agric. Research, vi. (1916) pp. 153-66 (3 figs.).

‡ Journ. Agric. Research, vi. (1916) pp. 361-6 (2 pls.).

§ Journ. Agric. Research, vii. (1916) pp. 17-40.

total solids, and the substances that are removable by extraction with alcohol, ether or water were very much reduced. Other substances, such as lipoids, proteids, etc., are discussed and the results given. Finally, they state that there is progressive decrease of the acid-content, and a large increase of alcohol-content in the tissues.

Growth of Fungi in Concentrated Solutions.*—As a result of experimental cultures and research, L. A. Hawkins has found that parasitic fungi are able to grow in relatively high concentrations of salts and sugars, higher even than the concentrations present in the cell-sap of the host-plant. A large selection of parasites were tested, including *Fusarium*, *Rhizopus nigricans*, *Sphærospis malorum*, etc.

Altitudinal Range of Forest Fungi.†—Most of these, as observed by J. R. Weir, have a very great range, from sea-level to the extreme limit of timbered zones, though they are less abundant on the heights, and though certain species “predominate in particular forest zones or types.” The altitude also affects the form and structure, etc., of the fungi, especially of certain timber sporophores, but may not materially influence their development within the substratum.

Apple-rot Fungi in Relation to Temperature.‡—C. B. Brooks and J. S. Cooley have conducted a series of cultural studies of *Alternaria* sp., *Botrytis cinerea*, *Fusarium radicicola*, *Sphærospis malorum*, etc., on apples at varying temperature. They give a résumé of similar researches undertaken by previous workers, and then describe in detail their own results.

All the fungi grew at 0°, except *Fusarium* and *Glomerella*, but with most of the fungi the initial incubation stages of growth on the fruits had been more inhibited by low temperatures than the later ones, which shows the risks run when storage is unduly delayed; but there is great variation according to the prevalent fungus, and the variety and maturity of the fruit.

Citrus Canker.§—Frederick A. Wolf describes a disease of *Citrus* recently introduced into the citrus-growing sections of the Gulf Coast States. The attack is a very severe one, many varieties and species being affected, and probably none are immune. Grape-fruits are especially liable to injury, but oranges, lemons, and limes are also susceptible to the disease. The primary cause of *Citrus* canker is a bacterial parasite, *Pseudomonas Citri*, and a full account is given of the development of the bacterium and of its effect on the host-tissues. Fungi belonging to the genera *Phoma*, *Fusarium*, and *Glucosporium* have also been isolated from *Citrus* cankers. *Phoma* sp. was the most active in the disintegration of the tissues; it has been described as *Phoma socia* sp. n. The destruction of diseased trees and the observance of proper sanitary precautions are strongly advised.

* Journ. Agric. Research, vii. (1916) pp. 255-60.

† Mycologia, x. (1918) pp. 4-14.

‡ Journ. Agric. Research, viii. (1917) pp. 127-63 (6 pls. and 25 figs.).

§ Journ. Agric. Research, vi. (1916) pp. 69-99 (4 pls. and 8 figs.).

Spongospora subterranea.*—I. E. Melhus, J. Rosenbaum, and E. S. Schultz have made an exhaustive study of the geographical extension of this fungus in the United States, of the nature of the soils which become infected by the disease, and also of the disease-galls and accompanying fungi. It has been known in the States for some time, and is capable of persisting in the soil for five years. The roots are generally attacked, and the presence of the fungus gives rise to small white galls. The canker of the tuber is more rare, as the growth of the potato is fairly rapid.

The histology of the galls which occur on other hosts than *Solanum tuberosum* bears considerable resemblance to the histology of *Plasmodiophora Brassicæ*.

Several types of dry-rot follow *Spongospora*; the most serious is caused by *Phoma tuberosa* sp. n. Many other fungi accompany or follow the disease, and traces of them abound in or on the tubers, notably the bulbils of *Papulospora coprophila*, which bear a great resemblance to the spore-balls of *Spongospora*.

Treatment of seed-tubers lessens the disease, as does treatment of the soil with sulphur, but no radical cure has yet been discovered.

Work has been done on this disease also by G. B. Ramsey.† He had observed that the hot dry season of 1916 was unfavourable for the development of the disease, so he undertook a series of parallel cultures of potato-plants in soil known to be infected with *Spongospora*. The pots containing the plants were grown in different conditions of temperature and moisture, and the results showed that a cool moist season or climate is most favourable to the development of the disease. There was no infection when the temperature was high or when the soil was too dry.

Diseases of Plants.‡—J. R. Weir describes a new fungus, *Hypoderma deformans*, which causes a serious disease of the needles of the Western yellow pine (*Pinus ponderosa*) in Idaho, Washington, and Montana. It induces a conspicuous hypertrophy by the extension of its mycelium into the tissues of the twigs, and also through the destruction of the youngest needles, thereby impairing very seriously the vitality of the trees. Another effect of the fungus is the formation of spherical-shaped witches'-brooms on trees past the seedling stage. The brooms may weigh 100 lb., and measure 5 or 6 feet in diameter.

E. S. Schultz § has investigated the disease of Silver-scurf on potatoes, caused by the black mould *Spondylocladium atrovirens*. He found it to be a slow-growing fungus, taking ten days for development in culture media. The spores vary enormously in size, measuring from 18–64 μ in length in the same culture. The fungus enters the tuber by the lenticels or through the epidermal layers, and destroys the outer layers of corky cells; owing to the products of the coloured spores the whole tuber may become sooty-black. Infection may take place at any time throughout the storage season.

* Journ. Agric. Research, vii. (1916) pp. 213–53 (9 pls. and 1 fig.).

† Phytopathology, viii. (1918) pp. 29–31.

‡ Journ. Agric. Research, vi. (1916) pp. 277–88 (1 pl. and 4 figs.).

§ Journ. Agric. Research, vi. (1916) pp. 339–50 (4 pls.).

O. A. Pratt* calls attention to the frequency of storage-rot in potatoes, in the majority of cases these being due to surface-wounds caused in harvesting. He has investigated the worst of these rots, due to the attack of *Fusarium trichothecioides*, which produces "powdery dry-rot." It does not attack any part of the growing plant, and as to the tubers it is entirely a wound-parasite. The diseased portion usually presents a wrinkled sunken appearance, and in advanced stages may show a pinkish-white growth of the fungus. The decayed tissue varies in colour from light brown to nearly black; internal cavities partially filled with the mycelium and spores of the fungus are frequently found in decayed tubers. The fungus does not develop under 2° C., and in dry well-ventilated storage-houses loss would be very slight. The disease may also be effectively checked by disinfecting the stock with mercuric chloride or formaldehyde, provided the disinfection is done within twenty-four hours of digging.

J. A. McClintock† has described a disease of peanut (*Arachis hypogæa*) due to *Sclerotium Rolfsii*, a fungus that attacks the plants when one to two months old, and continues to develop during the season. The disease shows itself in the wilting of the leaves, while round the shoots at or near the surface of the soil appears, first, the white mycelium, and later the brownish sclerotia, about the size of a mustard-seed.

C. W. Edgerton‡ has explained his method of testing disease-resisting varieties of plants in order to secure such plants on the least possible acreage of ground. He experimented with tomato-wilt, a disease due to a *Fusarium* which lives in the soil. He selected the seed of such plants as had resisted the disease though grown in badly infected soil, and these he subjected also to diseased conditions. A limited extent of soil was also sterilized and reinfected with tomato-wilt, and the plants were then reared on this soil; by this method it was possible to collect data as to the varietal resistance to disease, the virulence of the fungi, and the influence of the different soils.

C. Jagger and V. B. Stewart§ have studied the various types of *Verticillium* disease in a series of cultures of the fungus from various hosts. They noted in all the ultimate formation of numerous black sclerotia-like bodies. The cultures differed mainly in the rate of growth of these bodies. Experiments were conducted in the field by inoculation and by mixing healthy with diseased plants.

L. M. Massey|| records the results obtained in the use of various fungicides. The tests were made on diseases of roses due to *Diplocarpon Rosæ* (blackspot) and on *Sphærotheca pannosa* (powdery mildew). In both cases he found that dusting the bushes with a mixture of ninety parts of finely-ground sulphur and ten parts powdered arsenate of lead was the most effective remedy, and also less unsightly than the sprays generally used.

F. A. Wolf and E. E. Stanford¶ describe a disease of fig-trees in

* Journ. Agric. Research, vi. (1916) pp. 817-31.

† Journ. Agric. Research, viii. (1917) pp. 441-8 (2 pls.).

‡ Phytopathology, viii. (1918) pp. 5-14 (4 figs.).

§ Phytopathology, viii. (1918) pp. 15-9.

|| Phytopathology, viii. (1918) pp. 20-3.

¶ Phytopathology, viii. (1918) pp. 24-7 (2 figs.).

North California caused by *Macrophoma Fici* which has been recorded from Africa. It causes cankers on the larger branches, and fruits inoculated with the spores were destroyed by development of the fungus. The pycnidia grew well in cultures; the great variation in the size and shape of the spores is noted.

A disease of Squashes, due to *Choanephora cucurbitarum*, has been studied by F. A. Wolf.* It causes a blight of the flowers and a rot of the fruit, considerable loss having resulted from its presence. It is the only known species of the genus recorded in America, and a full account of the fungus is given. Sporangial, chlamydosporic and zygosporic stages were developed in artificial cultures.

A new strain of *Rhizoctonia Solani* and its effects on potato tubers forms the subject of a paper by J. Rosenbaum.† He claims that the different strains can be distinguished with accuracy in macroscopic growth on various media as well as by morphological comparisons. Strain R5, the new fungus, is more pathogenic on the stems and produces a distinct necrosis of the tubers. Differences were found in the size, etc., of the sclerotia and of the hyphal cells.

A *Rhizoctonia* potato disease has also been examined and described by G. B. Ramsey.‡ It attacks the tubers and seems to have been confused with potato-scab. The tubers are attacked through the lenticels, and the scab formed may penetrate to the core of the tuber, or, in another phase, the shrinkage of the tissues causes the formation of a pit or canal, frequently suggesting wire-worm injury.

A needle-blight of Douglas fir has been described by J. R. Weir § which has caused great damage in forest and nursery. The needles affected develop spots in early winter of a slightly yellow colour on the under surface. The infected needles fall at all seasons of the year, and the trees may become entirely defoliated. The fungus is as yet undescribed, but seems to be a member of the Stictidaceæ. Spraying with soap and Bordeaux mixture is recommended.

F. D. Fromme and H. E. Thomas || describe a *Xylaria* root-rot of apple-trees that is becoming a serious menace in the chief orchard sections of Virginia. It is marked by black encrustations on the surface of the roots, with dark zonations in the internal bark and wood. The progress of the fungus (*X. Hypoxylon*) is comparatively slow, but two years of infection may produce the death of the tree.

A new leaf-spot on turnip has been reported in various localities in Georgia and has been identified by B. B. Higgins ¶ as due to *Colletotrichum Brassicæ*, or to a new species, *C. Higginscanum* Sacc. Inoculation experiments were made on seed-pods with the results indicated that though the pods were infected and many seeds destroyed, the fungus was not carried over in the seed.

A nursery blight of Cedars (*Juniperus*, *Thuja* and *Cupressus*) has

* Journ. Agric. Research., viii. (1917) pp. 319-27 (2 pls.).

† Journ. Agric. Research, ix. (1917) pp. 405-19 (2 pls.).

‡ Journ. Agric. Research, ix. (1917) pp. 421-6 (4 pls.).

§ Journ. Agric. Research, x. (1917) pp. 99-103 (1 pl. and 3 figs.).

|| Journ. Agric. Research, x. (1917) pp. 163-73 (2 pls. and 1 fig.).

¶ Journ. Agric. Research, x. (1917) pp. 157-61 (2 pls.).

been traced by G. G. Hahn, C. Hartley and R. G. Pierce* as due to the attack of a *Phoma* sp. It is primarily a disease of seedlings; trees of over four years old generally escape. Inoculation and control experiments were carried out with success. The fungus occurs on lesions in the stems.

An "end-rot" disease of the cranberry is described by C. L. Shear.† It attacks the cranberry at the blossom end and causes a softening of the tissues. The diseased part is lighter coloured than the sound portion of the berry, and the discoloration spreads as the rot develops. The cause of the rot is a Sphaeropsidaceous fungus, *Fusicoccum putrefaciens* sp. n., and it is surmised that it is a stage of a *Cenangium* sp. The disease has been found to occur in all the cranberry-growing sections of the United States, and has caused considerable damage.

A. D. Cotton‡ is the author of Leaflet No. 56 recently issued by the Board of Agriculture, which deals with apple canker due to a minute fungus, *Nectria ditissima*. The influence of the soil is discussed.

J. R. Jolewalaie and S. C. Bruner§ have described *Phyllachora Roystoneæ* sp. n. as a disease, though unimportant, of the royal palm, *Roystonea regia*.

G. H. Godfrey|| records the occurrence of *Sclerotium Rolfsii* as a disease of wheat. The lesions occurred on the crown and lower portions of the culms. The heads on the diseased culms, though normal in general appearance, were entirely devoid of grain.

L. Garbowski¶ has noted the presence of *Sclerospora macrospora* on corn in Podolia (Russia). Oospores were found in the tissues of the leaves. In a further communication the same author gives a long list of parasitic fungi collected by himself in the same region during the summer of 1915. He determined four new species of microfungi and new hosts for others. The list extends to 121 species.

R. C. Faulwetter** describes a leaf-spot of cotton due to an *Alternaria* not unlike *A. tenuis*. It is a weak parasite, and only infects healthy tissues in favourable conditions; it is most prevalent on leaves already affected by red spider or by *Bacterium malvacearum*.

M. B. McKay and Venus W. Pool†† have made a field study of *Cercospora beticola*. They record the different plants on which it occurs, its effect on the host-plant, and the methods of dealing with the disease. Placing the diseased leaves in silo was found to be effective, as the fungus did not survive the silage process for even two weeks.

E. Schaffnit and G. Voss‡‡ have repeated their field experiments with black-wart of potatoes (*Synchytrium endobioticum*). After eight years the spores survived in infected ground and caused a severe attack of the disease.

* Journ. Agric. Research, x. (1917) pp. 533-9 (2 pls.).

† Journ. Agric. Research, xi. (1917) pp. 35-41 (1 col. pl.).

‡ Journ. Board Agric., xxiv. (1918) pp. 1263-5 (1 pl.).

§ Mycologia, x. (1918) pp. 43-4 (1 pl.).

|| Phytopathology, viii. (1918) pp. 64-6 (3 figs.).

¶ Bull. Soc. Mycol. France, xxxiii. (1918) pp. 33 and 73-91 (4 figs.).

** Phytopathology, viii. (1918) pp. 98-105 (3 figs.).

†† Phytopathology, viii. (1918) pp. 119-36 (2 figs.).

‡‡ Zeitschr. Pflanzenkr., xxvii. (1918) pp. 339-46.

Schizophyta.**Schizomycetes.**

Colouring-matter of Red Torulæ.*—A. C. Chapman investigated the colouring-matter of red torulæ. Surface-colonies on agar were scraped off, ground with sand and extracted with various solvents. Chloroform and carbon-bisulphide dissolved the colouring-matter, forming deep-red solutions. Chloroform solutions when warmed and exposed to light became colourless; this suggested that the substance might be related to carrotene, but it was found that the absorption spectra were different. The solubility of the substance in light petroleum would indicate that it does not belong to the xanthophyll group.

Blepharospora cambivora. †—L. Petri transferred from carrot-cultures mycelium to the following solution:—Nitrate of calcium, 0·4; sulphate of magnesium, 0·15; acid phosphate of potassium, 0·15; chloride of potassium, 0·6; water, 1000. Ciliated zoosporangia formed in this medium, and by cultivating in the humus of chestnuts zoosporangia and oogonia were formed. Inoculation experiments on healthy plants were successful.

Bacillus phenologenes. ‡—A. Berthelot gives a description of this organism, of which the following is a summary:—The most important feature of this organism is its presumed relationship to sclerosis of arteries, as was suggested in 1910 by Metchnikoff. It apparently derives its subsistence from tyrosin, which it splits up, forming phenol. Its principal characters are as follows:—It is a short plump bacillus, the elements of which are longer on solid than in liquid media. It is ciliated and only faintly motile. It does not form spores, and is stained by Gram's method. It is a potential anaerobe, and its optimum temperature is 37°. The author gives numerous appearances of cultures made in different media. In media containing tyrosin it grows well, with formation of phenol. Its pathogenic action on laboratory animals is nil.

Bacillus citromaculans. §—Ethel Doidge has ascertained that the citrus "spot" disease, which attacks not only the fruit but also the leaf and branch of the tree, is due to a bacterium, *Bacillus citromaculans*. The organism apparently invades the tree through wounds, though stomatal infection cannot be altogether excluded.

* Biochem. Journ., x. (1916) pp. 548-50.

† Atti. R. Accad. Lincei, xxvi. (1917) pp. 297-9.

‡ Ann. Inst. Pasteur, xxxii. (1918) pp. 17-36.

§ Ann. Applied Biol., iii. (1917) pp. 53-81 (10 pls.).

MICROSCOPY.

A. Instruments, Accessories, etc.*

(3) Illuminating and other Apparatus.

Microscope Illumination.†—N. J. Clark has patented an apparatus for illuminating microscope specimens by means of a low-voltage electric lamp which is supported immediately below or within the substage condenser and is adjustable for focussing. As shown (fig. 1), the lamp B and a reflector A are carried by an arm C, clamped to a vertical rod E by a

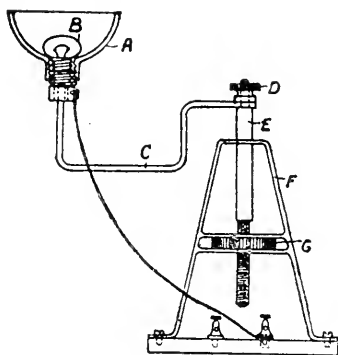

FIG. 1.

nut D, the rod E being mounted on a stand F so that it may be rotated or may be raised or lowered by means of a nut G. The illumination of the specimen may be regulated by means of an adjustable resistance in the lamp circuit. The lamp may be used with a dark-ground condenser to obtain oblique illumination or dark-ground effects.

(4) Photomicrography.

Spirochæta icterohæmorrhagica.‡—A. C. Coles has succeeded in photographing the minute spirals, 10–12 to each 5μ , in spirochætes obtained from the common rat in England. They are diagnostic of the newly-created genus, the *Leptospira* of Noguchi.

* This subdivision contains (1) Stands; (2) Eye-pieces and Objectives; (3) Illuminating and other Apparatus; (4) Photomicrography; (5) Microscopical Optics and Manipulation; (6) Miscellaneous.

† English Mechanic, Feb. 1, 1918, p. 16.

‡ Lancet, March 30, 1918, pp. 463–9 (6 figs.).

Photomicrographs in Colour.*—H. R. Eggleston describes the process of making lantern-slides representing photomicrographs of stained sections. The process is as follows:—Lantern-plates are sensitized by bathing for five minutes in a $2\frac{1}{2}$ p.c. solution of ammonium bichromate containing 5 c.cm. of ammonia to the litre, the temperature of the bath being not above 60° F. The plates are then rinsed for two or three seconds in clean water, drained and dried as uniformly as possible, being kept in the dark while drying. The sensitized plates are then exposed through the glass under the negative to the light of an arc lamp, the average exposure being about three minutes at 18 inches distance. The exposed plates are then developed by rocking in trays of water at about 120° F. until all soluble gelatin is removed. The plates are then rinsed in cold water, fixed in hypo, and washed free of the hypo. They are then ready for staining. The staining is done with a 1 p.c. solution of dye containing 1 p.c. of acetic acid, the dye being selected to simulate most closely the original stain of the section. When sections stained with two different colours are being photographed, negatives are made through suitable colour-filters, and are then dyed in the two stains and placed face to face, so that a two-colour slide is obtained. Suppose a section is stained red and green. Two negatives are made on panchromatic plates—one with a red filter, which will cause the green to appear as clear spaces in the negative and will not record the red, and the other with a green filter, which will record the red and not the green. The slides made from bichromated gelatin are stained—that from the red negative with the original green stain, and that from the green negative with the original red stain. The filters used are Wratten M filters. The choice of the filter is decided by visual trial. Thus photographing a section stained with hæmatoxylin and eosin the A (red) filter shows no trace of the eosin and gives a good strong negative of the hæmatoxylin. The B and C filters are used together for the other negative, giving a blue-green colour and recording the eosin and hæmatoxylin both fully, and from these two negatives positives are made and stained with a blue and a red dye.

(5) Microscopical Optics and Manipulation.

Dividing-engine for Ruling Diffraction Gratings.† — "Nature" records that part 1 of vol. xxx. of the Proceedings of the Royal Society of Victoria contains a description of a new dividing-engine for ruling diffraction gratings by J. H. Grayson, of the University of Melbourne. The design and construction of this machine have occupied Grayson, whose skill in work of this type is well known, for seven years, and the completion of the task places spectroscopists under a great debt of gratitude to him. His paper contains a detailed description of the machine, and gives full particulars of the methods used for grinding and testing the screw. The machine is set up in a room of its own in the basement of the University, and is driven by a $\frac{1}{40}$ h.-p. hot-air engine placed in an adjoining room. Ruling-diamonds are broken stones, in which the fracture along a cleavage-plane intersects an outer

* Trans. Amer. Micr. Soc., xxxvi. (1917) pp. 279-81.

† Nature, March 21, 1918, p. 51.

crystalline face and gives a good knife-edge. Grayson finds the stones from the diamondiferous drift of New South Wales best for this purpose, and when ruling properly such a diamond makes no noise. The photographs which accompany the paper show that the rulings are extremely regular, and warrant the hope that gratings ruled on the machine will give exceptionally clear spectra. The verdict of spectroscopists on the gratings will be awaited with considerable interest. In the meantime all will congratulate Grayson on the completion of his work, and the University of Melbourne on the public-spirited way in which it has provided facilities for that work.

Dispersion and other Optical Properties of Carborundum.*—H. E. Merwin's investigations on carborundum show that for wave-lengths ranging from $755 \mu\mu$ to $416 \mu\mu$, w ranges from 2.616 and ϵ from 2.654 to 2.812 . Microscopical study of several samples of granular carborundum revealed no definite variations in the refractive index for red light, even in grains of different colour.

Measurement of Magnifying Power.†—W. M. Bale describes a simple method of measuring the magnifying power of a microscopical combination. His procedure is:—(A) Measure with the camera lucida the exact diameter (at 10 inches) of the magnified field; (B) measure with the stage micrometer the actual diameter of the field. Then A divided by B is the magnifying power. At the same time there are sundry precautions to be taken to ensure success, especially if the investigation does not concern the centre of the field. These difficulties the author fully deals with.

(6) Miscellaneous.

Balsam Problem.‡—At a Meeting of the Optical Society on April 11 J. W. French stated that for cementing optical parts together Canada balsam is almost invariably employed. Although on starting or starting of the balsam-layer actual separation of the parts or deformation of the optical surfaces frequently occurs, there is no appreciably better substance known. Optical parts may be combined with an air-space between the surfaces by optical contact, with or without sealed edges, by optical welding or by cementing. The disadvantages of the various methods were enumerated, the loss of light at transmission surfaces being particularly discussed. A considerable number of balsam specimens, of ages varying up to ten years, had been opened, and photomicrographs of the balsam-layer were exhibited. In all cases there were fluid layers between the harder balsam and the glass surface, and the photographs demonstrated particularly the smallness of the adhesion to the glass. Specimens artificially produced were also exhibited. In many cases the age of the specimen was shown to be deducible from the configuration. So-called granulation of balsam was stated to be due to the action of moisture on the balsam surface. No trace of crystallization of glass-

* Journ. Washington Acad. Sci., vii. No. 14 (1917) pp. 445-7.

† Journ. Quekett Micr. Club, xiii. (1917) pp. 1-8 (1 fig.).

‡ Nature, April 18, 1918, p. 139.

quality balsam was found in any of the experiments, but a number of the photographed specimens showed definite right-angled fractures occasionally observed in torn gelatin films.

British Resources of Sands and Rocks used in Glass Manufacture, with Notes on certain Refractory Materials.*—The above is the title of a valuable Supplementary Memoir, by P. G. H. Boswell, with contributions by W. B. Wright, H. F. Harwood, and A. A. Eldridge. The title gives a clear guide to the contents, seven chapters of which deal exhaustively with the raw materials suitable for glass manufacture found in the British islands; there is also one chapter devoted to American grade glass-sands. The book includes elaborate tables of mechanical and chemical analyses, and some of the plates are microphotographs of British and American glass-sands.

Petrographic Microscope.†—F. E. Wright's contribution on this subject is an interesting exposition of the possibilities of petrographic examination. He does not deal much with constructional principles, but limits himself to a description of the results which can be obtained with the view of advocating a wider use of the instrument.

B. Technique.‡

(1) Collecting Objects, including Culture Processes.

Medium for Cultivating *Bacillus tetani*.§—W. J. Tulloch has discovered the following selective medium for the enrichment of *B. tetani* against other organisms accompanying it. The preparation of the medium is as follows:—Take 1 lb. of chopped meat, add 1 litre of water, boil 30 minutes, cool to 45° C., adjust reaction of fluid so that it is slightly alkaline to litmus. Trypsinize as for Douglas's broth; incubate in open vessel for five days at 37° C. Filter products of putrefaction through paper, add sodium formate 1 p.c. of total, adjust reaction of fluid to neutral point for phenolphthalein. Fluid is then filtered through a Berkefeld and Doulton filter in series, stored under paraffin in sterile flask mounted with a hooded delivery pipette, so that medium may be distributed into tubes. Before use each tube of 10 c.cm. is enriched by addition of $\frac{1}{8}$ part of fresh rabbit kidney, removed (after killing animal) by sterile operation. Author usually employs tubes containing 5 c.cm. of medium and adds $\frac{1}{16}$ part of kidney to each. To ensure sterility, 5, 1, 0.5, 0.1, and 0.01 c.cm. are inoculated into meat tubes which are incubated anaerobically for fourteen days and should show no evidence of growth.

* Longman, Green and Co., London, 1917, 92 pp. (7 pls. and maps).

† Trans. Optical Soc. Amer., i. No. 1, Jan. 1917, pp. 15-21 (1 pl.).

‡ This subdivision contains (1) Collecting Objects, including Culture Processes; (2) Preparing Objects; (3) Cutting, including Embedding and Microtomes; (4) Staining and Injecting; (5) Mounting, including slides, preservative fluids, etc.; (6) Miscellaneous.

§ Lancet, April 20, 1918, p. 578.

Cultivating the Parasite of Epizootic Lymphangitis.*—A. Boquet and L. Nègre first obtained cultures of *Cryptococcus farcinosus* in horse-dung agar, but after two or three passages the organism was transferred to Sabourand's medium, potato and carrot. After a time the coccus develops a mycelium which forms spores and chlamydo-spores. The cultures were successfully inoculated on horses.

(2) Preparing Objects.

Modification of Bouin's Fluid.†—A. C. Hollande, after praising the eminent qualities of Bouin's picro-aceto-formalin mixture, states that it may even be improved by the addition of neutral acetate of copper. He gives the following formula: Picric acid, 4 grm.; neutral acetate of copper, 2.5 grm.; 40 p.c. formalin, 10 c.cm.; glacial acetic acid, 1.5 c.cm.; distilled water, 100 c.cm. The acetate of copper is dissolved in 100 c.cm. of distilled water; then are added 4 grm. of picric acid. After the picric acid is dissolved the fluid is filtered, and to the filtrate are added 10 c.cm. of the 40 p.c. formalin and the acetic acid. The pieces to be fixed are immersed in the fixative for three days. They are next washed several times in distilled water during twenty-four hours. They are afterwards passed through upgraded alcohols. This is important, as direct passage to strong alcohol gives rise to a precipitate. The author gives a list of eight fluids through which the fixed tissue should be passed.

Short Method of Preparing Histological Material.‡—L. W. Strong publishes a modification of the usual routine by which the time is reduced to three days, with considerable saving in labour and reagents: 1. Fix in 10 p.c. formalin in 80 p.c. alcohol overnight. 2. 95 p.c. alcohol, eight to ten hours. 3. Acetone, from one-half to two hours. 4. Chloroform-paraffin, overnight in warm place. 5. Paraffin, four hours; 48° C. m.p., two hours; 52° C. m.p., two hours. 6. Embed.

(3) Cutting, including Embedding and Microtomes.

Electrifying the Microtome.§—H. E. Metcalf derived his inspiration from an electric sewing-machine. The device consists of a small motor with a cork friction-wheel, and mounted on a base, so that when put underneath a sewing-machine fly-wheel a strong spring in the base will press the cork friction-wheel against the fly-wheel of the sewing-machine. The motor was turned on its side with its base bolted to a block, and the block bolted to the table. The microtome-wheel was then backed up on to the cork friction-wheel of the motor until the requisite tension was secured, and then it was bolted to the table. Thus both motor and microtome are both rigidly fastened down.

Variations in speed are obtained by means of the foot-controller which accompanies the motor. Although this controller allows only six

* Comptes Rendus, clxvi. (1918) pp. 308-11.

† C.R. Soc. Biol. Paris, lxxxi. (1918) pp. 17-20.

‡ Trans. Amer. Micr. Soc., xxxvi. (1917) pp. 280-1.

§ Trans. Amer. Micr. Soc., xxxvi. (1917) pp. 267-9 (1 fig.).

variations in speed, it is regulated satisfactorily. While cutting serial sections the assistant never has to touch the fly-wheel with his hands, as he is able merely by using the foot-control to move the paraffin-block a fraction of an inch at a time, as well as being able to cut sections one by one if necessary. In this manner colloidin sections have been cut with a slanting knife. Much time and expense are saved by this device.

(4) Staining and Injecting.

Simple Method for Double-staining Sporulating Bacteria.*—C. Botelho recommends the following procedure:—Dissolve light green $\frac{1}{4}$ gm. and acid-fuchsin 2 gm. in a solution of glacial acetic acid and distilled water, 50 c.cm. of each. The material, with a drop of water, is placed on a slide and fixed by heat. The film is then covered with the stain and heated to vaporization. This procedure is repeated three or four times. When cool wash with distilled water. Dry and examine. Spores are stained red, the bacilli green.

New Method of Staining the Tubercle Bacillus.†—C. Cépède recommends the following procedure:—The sections or smears are first treated with carbol-fuchsin, heated for five minutes. They are then immersed in the following solution for two to three minutes:—Methylen-blue in excess; lactic acid, 40 c.cm.; distilled water, 160 c.cm., 1 part; alcohol 95 p.c., 4 parts. The preparation is then washed in tap-water, and if any red remain the blue solution must be reapplied. Then dry and examine. In urine the technique is slightly different. Before colouring with fuchsin the preparation is treated with a soda solution to which 5 p.c. alcohol has been added. This removes the fat from the smegma bacillus, and prevents confusion.

(5) Mounting, including Slides, Preservative Fluids, etc.

New Counting Chamber.‡—J. W. Cropper read a note on a "New Counting Chamber for the Enumeration of Protozoa and other Organisms" (from the Marcus Beck Laboratories, Royal Society of Medicine). The chamber was designed on the principle of the hæmocytometer, but with a considerably larger area—namely, 5×5 mm.—of the platform ruled in squares, the latter also being increased in size. For various practical reasons the depth of the chamber was retained as $\frac{1}{10}$ mm. as in the older chambers. Thus the organisms or cells in a comparatively large volume—namely, 2.5 c.mm.—could be counted, and in cases where the number present was scanty it was possible to count a sufficient number of organisms to minimize the statistical errors which were inseparable from a small count. The size of the smallest squares had been so arranged that they occupied the central half of the diameter of the field of the microscope, using a $\frac{1}{8}$ -in. objective and a $\times 7$ eyepiece, this permitting a rapid count being made. In cases where the organisms or cells could be easily recognized with a low-power magnifica-

* C.R. Soc. Biol. Paris, lxxx. (1918) pp. 183-4.

† Comptes Rendus, clxvi. (1918) pp. 357-9.

‡ Lancet, March 2, p. 337.

tion, it had been found preferable to employ an extemporized device, consisting of a large-sized microscope-slide on which columns $\frac{1}{2}$ mm. in width had been ruled. On this a ring of paraffin-wax, applied while molten by means of a turn-table, was placed. A definite volume—say, 10, 20, or more c.mm.—of the suspension of organisms to be counted was expelled from a graduated capillary pipette on to the ruled slide, and a cover-slip was allowed to fall upon it. The organisms in the *whole of the drop* were easily and rapidly counted by working along the columns from end to end. The chamber and ruled slides could be obtained from Messrs. H. F. Angus and Co., Wigmore Street, W.

Metallography, etc.

Comparison Screen for Brass.*—A simple method for determining approximately the grain-size of annealed brass is described and illustrated by O. W. Ellis. A glass screen is employed carrying prints on transfer-paper of photomicrographs of standard samples which have been subjected to different but known heat-treatments, arranged in the form of a ring. The image of the structure of the sample under examination is projected on to the centre of the screen, and direct comparison is then readily made with the standard samples.

Effect of Great Hydrostatic Pressure on Metals.†—Z. Jeffries has found that cylinders of pure aluminium and of an aluminium-copper alloy (88 p.c. aluminium), after subjecting to hydrostatic pressure up to 12,400 kilograms per square centimetre at temperatures of 25° and 40°C., are practically unchanged in dimensions, or in regard to hardness, strength, and microstructure. Both the metals tested had fine-grained structures, and owing to the haphazard orientation of the crystals it is considered that the resistance to deformation would be equal in all directions, and hence no permanent deformation would result from great hydrostatic pressure. A single crystal or a piece of metal composed of a few larger grains, on the other hand, would show different degrees of resistance to deformation in different directions, and might suffer permanent deformation under great hydrostatic pressures.

Etching with Chromic Acid and Hydrogen Peroxide.‡—This mixture is stated by S. W. Miller to be a useful etching reagent for all bronzes and brasses, and also for silver. The reagent is made by adding a few drops of hydrogen peroxide to a very dilute solution of chromic acid. Addition of hydrogen peroxide causes strong effervescence, and turns the solution a very dark brown colour. If the chromic acid solution is too strong large gas-bubbles are evolved which prevent uniform etching. The specimen is immersed in the effervescent solution for a few seconds and then washed immediately in running water. Photo-

* Journ. Inst. Metals, xviii. (1917, 2) pp. 171-2 (1 fig.).

† Journ. Inst. Metals, xviii. (1917, 2) pp. 243-7.

‡ Journ. Inst. Metals, xviii. (1917, 2) pp. 253-5 (2 figs.).

micrographs of a brass and a bronze are given illustrating the effects of the reagent. The reagent is recommended particularly for the etching of brass welds.

Heat-treatment of Grey Cast Iron.*—The behaviour of cast iron under the influence of heat has been studied by J. E. Hurst in connexion with the cracking of Diesel engine piston-heads, which during working attain a temperature of at least 900° C. Chemical analyses of different parts of cracked piston-rods show that the combined carbon is gradually all converted into the graphitic form in the portion exposed to high temperature. Microscopical examination showed an increase in the dendritic structure and in the number of graphite plates in the portion subjected to the influence of heat; while the extreme edge of the piston is directly in contact with the flame the extent of the dendritic structure is less, the graphite is more finely divided, and numerous small holes appear. Experiments with samples of a high phosphorus grey cast iron showed that under certain conditions—annealing at high temperatures (above 900° C.)—a portion of the free carbon is reabsorbed. The structure at the extreme edge of the piston-head is connected with this phenomenon. Fracture ensues from the internal strain caused by the slight volume-changes which accompany these changes in the condition of the carbon, as well as from the weakening of the iron caused by the separation of carbon.

Uniformity of a Cast of Acid Open-hearth Steel.†—The results of an investigation to determine the general quality and uniformity of a cast of steel from a 40-ton acid open-hearth furnace are given by T. D. Morgans and F. Rogers. The steel was made for the manufacture of H.E. shell, and contained approximately 0.5 p.c. carbon. Chemical analyses, tensile and hardness tests, and microscopical examinations were made on the top, middle, and bottom billets of each of twenty-one ingots. The manganese-content showed a slight decline from the first to the last ingot poured. Beyond this and the usual slightly higher percentage of elements found in the upper parts of the ingots, all properties approached a high degree of uniformity. The structure consisted of a ferrite network, whose meshes were filled with generally lamellar pearlite. Towards the edge of the billets the network size was smaller, and was largest towards the centre. No variation in structure which would prove detrimental to the steel in use was found.

Microstructure of Commercially Pure Iron between Ar₃ and Ar₂.‡ The very pure iron (99.84 p.c. iron) known as "Armco" iron, which is made in the ordinary basic open-hearth furnace, is peculiar in showing brittleness when subjected to mechanical treatment between 900° and 800° C.; at any other temperature outside this range the material is remarkably ductile and malleable. The cause of this unusual red-shortness has been investigated by W. J. Brooke and F. F. Hunting by

* Journ. Iron and Steel Inst., xcvi. (1917, 2) pp. 121-8 (8 figs.).

† Journ. Iron and Steel Inst., xcvi. (1917, 2) pp. 209-18 (21 figs.).

‡ Journ. Iron and Steel Inst., xcvi. (1917, 2) pp. 233-9 (14 figs.).

heating samples above 1000° C., allowing to cool slowly, and quenching individual samples at various temperatures. Photomicrographs of all the quenched samples are given. The microstructures of all samples quenched above 900° or below 800 C° were as normally obtained with pure iron, but those quenched between these temperature-limits showed a peculiar "eutectoid" constituent, with double boundaries at the junctions of many of the crystal boundaries. The composite character of the constituent was always characteristic, the central structure being more or less pearlitic, surrounded by a ferrite zone which connected up in a definite manner with the adjacent crystal grains. The composition of the "eutectoid" has not been determined by the authors, but a combination of sulphide, phosphide, and carbide is suggested. Increasing the oxygen-content of the iron was not found to increase the amount of the eutectoid. From the coincidence of the temperatures of appearance and disappearance of the constituent with those of the brittle range, it is considered very probable that the constituent is the cause of the red-shortness shown by "Armco" iron.

FAY, HENRY—**Microscopic Examination of Steel.**

[A guide to others engaged in the inspection of steel.]

Wiley & Sons and Chapman & Hall: iv and 18 pp. (55 photos.).

PROCEEDINGS OF THE SOCIETY.

AN ORDINARY MEETING

OF THE SOCIETY WAS HELD AT 20 HANOVER SQUARE, W., on
WEDNESDAY, MARCH 20TH, 1918, AT 5.30 P.M., MR. J. E.
BARNARD, PRESIDENT, IN THE CHAIR.

The Minutes of the last Meeting, having been circulated, were taken as read, confirmed, and signed by the President.

The President reviewed the purpose of the Meeting, and, after welcoming Professor Conrady, requested him to address the Meeting on "The Theory of Dark-ground Illumination."

Professor Conrady's address, which was freely illustrated by sketches and diagrams on the blackboard, may be briefly summarized as follows:—

Objects lying in a perfectly transparent medium are seen on a dark ground when illuminated exclusively by rays at a greater obliquity than the objective can receive, because the only light which can then enter the instrument is that which has been scattered by the objects.

Some objects only scatter the light in directions *close* to that of the illuminating rays; hence the *gap* between the latter and the most oblique rays which the objective can receive should be as *small* as possible. Other objects scatter the light in distinct, *widely-separated* beams; to accommodate these, very oblique illuminating rays are also necessary.

The scattering may be in any direction; the entrance of light into the instrument therefore depends upon uniform distribution of the illumination with reference to the axis of the instrument—in other words, a perfectly centred hollow cone of rays is essential.

The realization of these conditions by a condenser with dark-ground stop depends on the condition that the stop is depicted in the limiting aperture of the objective. This condition is not even approximately fulfilled by the condensers of high N.A. and short focal length, hence the bad effects obtained and the call for reflecting condensers.

The theory of microscopic resolution under dark-ground illumination is simple only in the case of regular structures treated on Abbe's principle. It then leads to the conclusion that the condenser should have three times the N.A. of the objective, and that full resolving power is therefore only obtainable with objectives up to 0.35 or 0.45 N.A.

The President (Mr. J. E. Barnard) prefaced his remarks on Dark ground Illumination by stating that in this method the object had to be illuminated in such a way that no direct light entered the microscope. This could be achieved by placing a "stop" at the back of an ordinary achromatic or any suitable condenser, or, preferably, by using either a paraboloidal or a spherical surface-reflecting condenser made specially for the purpose. He did not propose to discuss the relative merits of particular dark-ground illuminators; each had its good points, and most of them were capable of producing satisfactory dark-ground effects. (At the close of the meeting several of the best-known illuminators were shown, and the particular type of beam projected by each was demonstrated.)

He then pointed out that success or failure depended upon:—

1. Selection of illumination.
2. Exact centrality of all the optical parts of the microscope.

The selection of the illuminant was a difficult problem. The tendency was to employ a source of light of too great intensity. An ordinary electric filament lamp gave light of large dimension in one direction and small in the other. The result was to fill the condenser in one direction and not in the other, so that with such objects as *Spirochaetes* perfect illumination of the convolutions throughout the length of the organisms was lacking. An arc lamp could be employed, but with its use many inconveniences were experienced. The background was not so black as it should be; the image was not so well shown, and, especially when dealing with blood-plasma, minute particles, usually described as "ultra-microscopic," become annoyingly obvious. The ideal source of light for this method was the "Pointolite" lamp of the Ediswan Co. It consisted of a 4-mm. tungsten sphere, and when incandescent its image could be projected into the object-plane and perfect uniform illumination secured.

Another point which had an important bearing on this question of the intensity of the source of light was this: If one took an objective, such as a 4-mm. Apo. N.A. 0.95, and illuminated the object by means of an arc light, one was unable to get satisfactory dark-ground illumination with four condensers out of five. With some it was possible, but only when the obliquity of the light was at its maximum. Take a weaker source of light—he had one which he had been using for the last day or two—and it became possible to use a 0.95 N.A. objective with any condenser, and, while the ground was not *black*, it was dark enough to enable *Spirochaeta pallida* to be seen with all its characteristic features. It was true a fair amount of direct light came through, as well as an oblique beam which went to form the dark-ground image. He had been criticized for using only a dry lens for dark-ground work, but Professor Conrady had now justified the method. On theoretical grounds, it was clear that an objective of 0.65 N.A. was doing all that could be done, although it might, under certain circumstances, be advisable to use an objective of higher numerical aperture. Therefore the use of a very powerful source of light was to be avoided.

The next point was that of centration. The matter was really a very simple one. The method he advocated, though not the only one

or perhaps the best, was at least effective, and it had the advantage of simplicity. The one part of the microscope which was at the bottom of the trouble in centration, either for dark-ground illumination or for direct illumination, was the mirror. He had made a board on which there was an acetylene lamp, a condensing lens, and a fixed mirror which was inclined at the proper angle to project a beam of light which was vertical to the board. This he thought would be a valuable method for microscopic work, and would do away with many of those errors of centration which arise. Mr. Barnard then gave the following directions:—Remove the sub-stage mirror from the microscope, and place the microscope centrally over the mirror on the board (unless set within narrow limits of accuracy nothing will be seen). To adjust the instrument remove the dark-ground illuminator from the microscope, put in a low-power ocular only, and put the source of light at such a position in relation to the condensing lens—which must be used between the mirror and the source of light—that a rough image of the illuminant is thrown on to the centre of the mirror. Then project this light up through the microscope tube, there being nothing intervening between the mirror and the ocular, and throw on to the ceiling a disc of light, and that disc is a perfect indication of centration. If there is any want of centration, some reflection may be seen from either the inside of the tube of the microscope or the inside of the ocular, or from the sub-stage fitting if there is considerable lack of concentration. When centrality is secured do not touch the light, the condensing lens or the mirror in any way. Put the objective on, put on to the stage the object to be observed, having previously put in the dark-ground illuminator, with either oil or glycerin to secure immersion. Next get the object into view with a low-power objective, focus up the image of the radiant, getting as sharp and as small an image of it as possible. When viewed, if not at the centre of the field, bring to the centre by means of the sub-stage centring-screws. Then replace the low-power ocular by the higher power, $\times 12$ or $\times 18$, and all should be in order.

Finally, slides and cover-glasses should be carefully calibrated, and cleanliness of these two essential accessories was of the greatest importance.

Messrs. Akehurst, Heron-Allen, Sheppard, Scourfield and Dr. Rudd Leeson took part in the discussion that followed.

Colonel Harrison, M.D., on the invitation of the President, dealt briefly with the difference between various Spirochaetes. In distinguishing *S. pallida* from other varieties, the points he laid stress upon were: first, the extreme fineness of the pallida; secondly, its pallidity. If the focus was shifted, even a little, other varieties assumed a rusty hue, whereas the *S. pallida* retained its delicate pallor. *S. perfringens*, too, was much more dazzling than *S. pallida*. Hence the illumination which sufficed fairly well for other Spirochaetes was not enough for *S. pallida*. Another feature was the great flexibility of *S. pallida*,

which was very active in a small radius. The only *Spirochæta* which might cause differential difficulty was *S. microdentium*, an organism obtained from the mouth of certain cases. But this had black portions on its body, so that it was naturally demarcated into luminous and dark portions, as against the uniform pallor of *S. pallida*. Also the body was thicker. He recommended examination of material from the syphilitic papule, rather than from any other part of the patient, to those who were endeavouring to become familiar with the microscopical appearance of *S. pallida*.

Professor Conrady and the **President** briefly replied to points which had been raised on their respective communications, and the meeting resolved itself into a series of practical demonstrations.

A SPECIAL GENERAL MEETING

OF THE SOCIETY WAS HELD AT 20 HANOVER SQUARE, W., ON APRIL 17TH, 1918, AT 7.55 P.M., TO CONSIDER THE FOLLOWING MOTION BY MR. WILSON :—

“That this Meeting instructs the Council to take the necessary action to remove all alien enemy Honorary, Ex-officio, and Ordinary Fellows from the Society’s Roll”—

of which due notice had been given on January 16th, 1918, and a copy of the resolution itself hung in the Society’s Rooms during the prescribed period of at least two months, in accordance with By-law 34.

The **President** opened the Special General Meeting, and called upon Mr. Wilson to propose the resolution standing in his name.

Mr. Wilson then read out the terms of his motion, and explained that there were twelve honorary alien enemy Fellows, and made a short speech in support of the resolution.

The **President** pointed out that the matter was in no sense a political one, since the individuals concerned were elected to the Society on account of their scientific attainments and eminence, and requested Fellows to confine their comments strictly to the terms of the resolution.

Mr. Hiscott, the Honorary Solicitor to the Society, seconded the resolution.

Dr. Rudd Leeson, who rose to support the resolution, was ruled out of order by the President.

There being no amendment proposed to the Meeting, the resolution was put and enthusiastically carried by the necessary two-thirds majority.

The **President** then declared the resolution carried, and instructed the Secretary to make an entry in the Minute Book to that effect (By-law 7:3).

AN ORDINARY MEETING

OF THE SOCIETY WAS HELD AT 20, HANOVER SQUARE, W., ON
WEDNESDAY, APRIL 17, 1918.

The Minutes of the preceding Meeting, having been circulated, were taken as read, confirmed, and signed by the President.

The nomination papers of Messrs. Lancaster and Whitaker were read.

The Financial Statement for the year 1917, which should have been included in the Annual Report of the Council, was now presented by the Treasurer and read by the Secretary, and is here inserted.

FINANCE.

The Revenue Account shows an excess of expenditure over income of £141 16s. 9d.

Compared with last year, the income of the Society again shows a decrease, the revenue from subscriptions having again fallen, while the total expenditure has increased by some £182; the increased cost of the Journal alone being some £151.

The value of the Society's Securities has been left at the same figure as last year, the investment account therefore remaining at £1981 14s.

The Society's holding of £400 of 4½% War Loan was converted to £421 of 5% War Loan.

During the year the sum of £75 19s. 6d. was expended on the purchase of a Zeiss Optical Bench and Projection Apparatus, and this amount has been added to the Property Account.

During the year one Life Composition fee has been received, and the Council has decided to open a special Life Compositions Account.

The balance from the Revenue Account has been charged against the Reserve Fund, and this fund is therefore reduced by £141 16s. 9d., and now stands at £71 18s. 8d.

The Council regret that the high cost of printing and the growing scarcity of paper have compelled them to reduce the issue of the Journal to four numbers per annum instead of six, and the first quarterly number will be issued in March.

The Balance-Sheet, which had been audited by Col. Clibborne and Mr. Wilson, was exhibited, and is here inserted.

Dr. REVENUE ACCOUNT FOR THE YEAR ENDING 31st DECEMBER, 1917. Cr.

	£	s.	d.	£	s.	d.
To Journal—						
Editing	136	4	6			
Illustrating	40	9	6			
Printing	514	3	11			
Postages	35	8	6			
Rent and Insurance	726	6	5			
Salaries and Reporting	162	14	0			
Library, Books, Papers and Binding	148	9	3			
Refreshments at Meetings	10	7	3			
Sundry Expenses—						
Stationery, Printing, etc.	47	4	1			
Petty Expenses and Postages	21	0	0			
Donation to Board of Scientific Societies	10	10	0			
				78	14	1
				£1136	11	0

Dr.

BALANCE SHEET, 1917.

	£	s.	d.	£	s.	d.
To Capital Funds	2127	17	4			
Show Case Fund	12	15	9			
Life Membership	31	10	0			
Sundry Creditors	2172	3	1			
Reserve Account as at Dec. 31, 1916	416	4	5			
Less Balance from Revenue Account	213	15	5			
	141	16	9			
				71	18	8
				£2660	6	2
				£1136	11	0

	£	s.	d.	£	s.	d.
By Cash—						
Deposit Account	200	0	0			
Current Account	80	0	8			
Petty Cash Account	1	4	8			
Investments as per last Balance Sheet—						
£400 North British Railway 3% Deb.						
£500 Nottingham Corporation 3% ..						
£400 New South Wales 3½%						
£915 India 3%						
£150 Metropolitan Water Board 3% ..						
£421 War Loan 5%						
Stock of Screw Gauges				1981	14	0
Property Account, as per last Balance Sheet ..	88	2	0	21	19	6
Add Apparatus purchased during 1917 ..	75	19	6			
Sundry Debtors				164	1	6
				211	5	10
				£2360	6	2

We have examined the foregoing Account, and compared the same with the Vouchers in the possession of the Society. We have verified the Securities as above mentioned, and find the same correct.

CYRIL F. HULL, Hon. Treasurer.

J. OLDBORN, Lt.-Col.,
J. WILSON, } Auditors.

On the proposition of **Dr. Eyre**, seconded by **Mr. Wilson**, it was resolved that the Statement of Accounts and the Treasurer's Financial Statement should be received, adopted, and entered on the Minutes.

Mr. Webster exhibited some specimens of *Planorbis corneus* which he had found in a small pond on a farm in Hertfordshire. He had not heard of this variety of *P. corneus* having been previously found, but as he had had a specimen brought to him by a dealer some two years ago, found in Essex, he assumed that it was not so scarce as usually supposed.

A vote of thanks to **Mr. Webster** for his exhibition was given.

Mr. E. J. Sheppard then made a communication on "Two Valuable Methods of Staining in Bulk and Counter-staining," which will appear in abstract in the Journal of the Society.

Mr. E. Atkinson then made a communication on "Hypo-entectoid Steel," copiously illustrated by lantern slides. This paper will also appear in the pages of the Journal.

A short discussion ensued, in which **Messrs. Hill and Rawlins** and the **President** took part, and **Mr. Atkinson** briefly replied.

A paper by **Mr. J. M. Brown**, on "*Pyxidicula invisitata*, a Rhizopod new to Britain, and *Hedriocystis spinifera*, a new Helizoon," was then read by **Mr. Scourfield**. This will also appear in the pages of the Journal.

The thanks of the Society were accorded to each of these exhibitors and authors for their valuable contributions.

The President announced that the next Meeting of the Biological Section would be held on May 1, and the next Ordinary Meeting of the Society on April 15, to be devoted to the usual "Pond-life" exhibition.

AN ORDINARY MEETING

OF THE SOCIETY WAS HELD AT NO. 20 HANOVER SQUARE, W., ON WEDNESDAY, MAY 15TH, 1918, MR. J. E. BARNARD, PRESIDENT, IN THE CHAIR.

The Minutes of the Special General Meeting, April 17, and Ordinary Meeting, April 17, were read, confirmed, and signed by the President.

Death of Dr. Hebb.—The President reported the death of Dr. Hebb, who was elected a Fellow of the Society as long ago as 1885. He had always taken a very active part in the work of the Society, acting as Secretary for some ten or twelve years, and he had edited the Journal with marked ability up to the time of his death. He believed it was a statement of fact that his work on the Journal was probably the last thing that Dr. Hebb did. One outstanding feature of his character that appealed to them all was his unflinching geniality under all circumstances. He was sure that it was the wish of the Society that a letter should be sent from them expressing their great regret. He had attended the funeral service held that morning in the Westminster Hospital Chapel, with Dr. Eyre and Mr. Scourfield, to represent the Society, and had laid a wreath on the coffin in the name of the Society. It was intended to send a letter of sympathy to Mrs. Hebb, and he asked those who were in favour of a Vote of Condolence being passed to stand in their places.

The Death of Miss Kate M. Hall, elected in 1910, was also announced.

Donation to the Society.—The President reported that Lady Flower had kindly offered an old Microscope by Hugh Powell, with accessories, and that the Council had accepted the same on behalf of the Society.

Mr. Parsons moved, and Mr. Grundy seconded, "That a very hearty vote of thanks be accorded to Lady Flower for her kindness in presenting the Microscope to the Society."

Carried unanimously.

The Society already possesses a similar instrument, but Lady Flower's donation has several additional accessories. It will therefore be a desirable acquisition to the Society's Cabinet.

Among the accessories are 2-in. and $\frac{1}{4}$ -in. objectives, the latter having cover-glass adjustment and a lieberkühn; three eye-pieces, the medium power being fitted with an arrangement for varying the position of the diaphragm through a range of rather more than $\frac{1}{4}$ -in. The concave mirror forms a "white cloud" reflector. There is a piece of apparatus for holding a glass tube containing weed or living objects

in water while under examination. There are two stages, a small spring safety stage and a large stage which can be substituted for the small one. There are also a stage bull's-eye condenser, stage forceps, dark wells, etc.

For particulars of the stand see the Journ. R. M. S. 1901, p. 728, where Mr. Nelson gives a most interesting historical description of a similar example presented by Messrs. Watson and Sons.

Pond-Life Exhibition.—The President then called upon Mr. Scourfield to make some observations on the Exhibition of Pond-Life which had been arranged by Fellows of the Society and Members of the Quekett Microscopical Club.

Mr. Scourfield said he thought it might be fairly claimed that general "Pond-Life" exhibitions had a decidedly educational and scientific value. This was not so much because particular exhibits were of great rarity or possessed special scientific interest, although this might sometimes be the case, but rather because of the general effect upon both those who had previously given little or no attention to the subject and those who had already specialized in some one branch. To the former there was no doubt that these exhibitions did give, in a very attractive way, an indication of the manifold variety of microscopic fresh-water organisms and of the wonderful structure and exquisite beauty of many of them. To the specialist, on the other hand, they were at least useful as a reminder that the objects of his own study did not live altogether in a world of their own, and that he must therefore not lose sight of the probable inter-relationships of other groups of organisms with his own particular pets. To those who were not exactly either novices or specialists these exhibitions certainly gave encouragement to go still more whole-heartedly into the subject.

The general effect, therefore, should be to extend the desire for further and deeper knowledge of all kinds of fresh-water organisms, and of their conditions of existence—in other words, to lead to an increased interest in the study of fresh-water biology. To go into the many questions arising from a study of fresh-water organisms would, however, lead too far from their purpose that evening, and he intended to refer to three only which seemed to be of some practical importance at the present time.

In the first place, it could scarcely be doubted that the diseases of fresh-water organisms, and more especially, perhaps, the diseases carried by them, was a subject of the utmost importance. There was still much work to be done in this field, and it was open to all pond-life workers to add to the knowledge of the subject by making careful notes of all cases of diseased or parasite-bearing organisms which came under their notice.

Then there was the problem of what might be called the food-chain which existed in ponds, lakes, and other fresh waters, extending from the lowest algæ up to the fishes. From the point of view of scientific fish culture it was very necessary to know something of this dependence of one organism upon another in a gradually ascending series. In this connexion attention might be called to the great importance which had

only in quite recent years been found to attach to the extremely minute free-swimming or free-floating organisms constituting what was now known as the nannoplankton.

Lastly, there was the question of pure water supply. The problems involved in this were very largely biological, and the more detailed the knowledge of pond-life organisms the more complete would be the control which could be exercised under all circumstances over this very vital matter.

To those interested in this subject the little pamphlet on the "Biology of Waterworks," issued by the Natural History Museum, could be recommended.

Mr. Scourfield then proceeded to call attention to the various exhibits, commenting upon some of their more prominent peculiarities.

At the conclusion of Mr. Scourfield's remarks, the **President** said that there was no question about it that the study of Pond-Life was as likely to be as utilitarian as any form of study. What it might lead up to was quite unseen at the time the work was done. Even at the present time, with the extraordinary sanitation in the Army and measures being taken to stamp out disease, 80 p.c. of the illnesses were due to infections conveyed by parasites, living things that are in the strictest sense microscopical. In the case of an enormous proportion of those out of action through disease, the cause might be traced to some parasitic type of living thing. He moved, "That a hearty vote of thanks be accorded to the Fellows of the Society and to the Members of the Quekett Microscopical Club who have exhibited specimens, and to Mr. Scourfield for the remarks he has made on the exhibits."

Carried unanimously.

The **President** announced that the Biological Section would pay a visit on June 15 to the John Innes Horticultural Institution at Merton, by kind invitation of Professor Bateson. At the next Meeting of the Biological Section, on June 5, there would be a communication by Mr. J. Burton on "Some Fresh-water Algæ."

The business proceedings then terminated.

The following Objects were exhibited:—

Mr. C. H. Bestow	<i>Vaginicola crystallina</i> .
Mr. A. J. Bowtell	<i>Monas</i> sp.
Mr. F. W. Chippis	<i>Conochilus volvox</i> ; Polyzoa (<i>Alcyonella</i>) developing from statoblasts.
Mr. E. Cuzner	<i>Melicerta ringens</i> ; <i>Carchesium</i> sp.
Mr. D. Davies	Free-swimming Rotifers.
Mr. E. D. Evens	Larva of <i>Simulium</i> ; ova of fish.
Mr. J. Grundy	<i>Glenodinium</i> sp.; <i>Plumatella repens</i> .
Mr. A. Hardcastle	<i>Stephanoceros eichhornii</i> .
Mr. C. E. Heath	<i>Hydra vulgaris</i> .
Mr. T. H. Hiscott	<i>Closterium lineatum</i> conjugating, showing double zygospore; <i>Lecquerousia spiralis</i> .

Mr. J. J. Jackson	<i>Hydra fusca</i> .
Dr. J. R. Leeson	<i>Spirogyra</i> in conjugation.
Mr. H. H. Mortimer	Water-mite (<i>Pionu carneus</i>).
Mr. J. M. Offord	Gnat larvæ (<i>Culex</i>) emerging from egg-raft.
Mr. R. Paulson	<i>Colacium</i> sp., parasitic on <i>Cyclops</i> .
Mr. F. J. W. Plaskitt	<i>Surirella spiralis</i> .
Mr. J. Richardson	<i>Acanthocystis turfacea</i> ; spawn of pond-snail.
Mr. St. George	<i>Melicerta ringens</i> ; <i>Vorticella</i> sp.
Mr. D. J. Scourfield	<i>Scapholeberis mucronata</i> , an Entomostrocan which makes use of the surface-film of water for support.
Mr. R. S. W. Sears	<i>Conochilus volvox</i> ; <i>Volvox globator</i> ; <i>Stentor polymorphus</i> .
Mr. C. D. Soar	Water-mites (<i>Neumania spinipes</i> , <i>Arrhenurus globator</i> , <i>Acercus lutescens</i>).
Mr. G. Tilling	Water-mites (<i>Diplodontus dispiciens</i> , <i>Arrhenurus caudatus</i>).
Mr. W. R. Traviss	<i>Plumatella repens</i> .
Mr. W. J. Webster	<i>Planorbis corneus</i> , red variety; <i>Vallisneria spiralis</i> , large variety.
Mr. J. Wilson	<i>Actinosphærium eichhornii</i> ; <i>Acanthocystis turfacea</i> .

New Fellows:—

Elected January 16, 1918:—

Mr. Maurice A. Ainslie, R.N., B.A., F.R.A.S.

Mr. Harold Downes, M.B., C.M., L.R.C.P., F.L.S., etc.

Mr. Bertram H. Jones.

Mr. Hubert French Springall.

Elected February 20, 1918:—

Mr. Basil Adams, R.E., F.C.S.

Mr. Sydney Walter Ross.

Mr. Alfred Seymour-Jones.

Mr. George William Young.

Elected March 20, 1918:—

Sir Stanley Bois, Knt.

Mr. George Edwin Burke.

Mr. Hugh Hamilton Mortimer.

Elected May 15, 1918:—

Mr. Henry C. Lancaster.

Mr. Oscar Whittaker, F.E.S.

COUNCIL
OF
THE ROYAL MICROSCOPICAL SOCIETY.

ELECTED 1918.

PRESIDENT.

JOSEPH E. BARNARD.

VICE-PRESIDENTS.

EDWARD HERON-ALLEN, F.L.S., F.Z.S., F.G.S., M.R.I.A., etc.	ARTHUR EARLAND. ROBERT PAULSON, F.L.S.
F. MARTIN DUNCAN, F.R.P.S.	

TREASURER.—CYRIL F. HILL.

SECRETARIES.

J. W. H. EYRE, M.D., M.S., F.R.S. Edin.
DAVID J. SCOURFIELD, F.Z.S.

ORDINARY MEMBERS OF COUNCIL.

ALFRED N. DISNEY, M.A. B.Sc.	CHARLES SINGER, M.A., M.D.,
T. H. HISCOTT.	F.R.C.P.
BENJ. MOORE, M.A., D.Sc., F.R.S.	CHARLES D. SOAR, F.L.S.
J. MILTON OFFORD.	JOSEPH WILSON.
PERCY E. RADLEY.	G. SIMS WOODHEAD, M.A., M.D.,
A. W. SHEPPARD.	LL.D., F.R.S.E., F.R.C.P.
EDWARD J. SHEPPARD.	B. B. WOODWARD, F.L.S., F.G.S.

Editor.—CHARLES SINGER, M.A. M.D.

Librarian.—PERCY E. RADLEY.

Curator of Instruments, etc.—CHARLES SINGER, M.A., M.D.

Curator of Slides.—EDWARD J. SHEPPARD.

Assistant Secretary.—CHARLES J. LOCK.



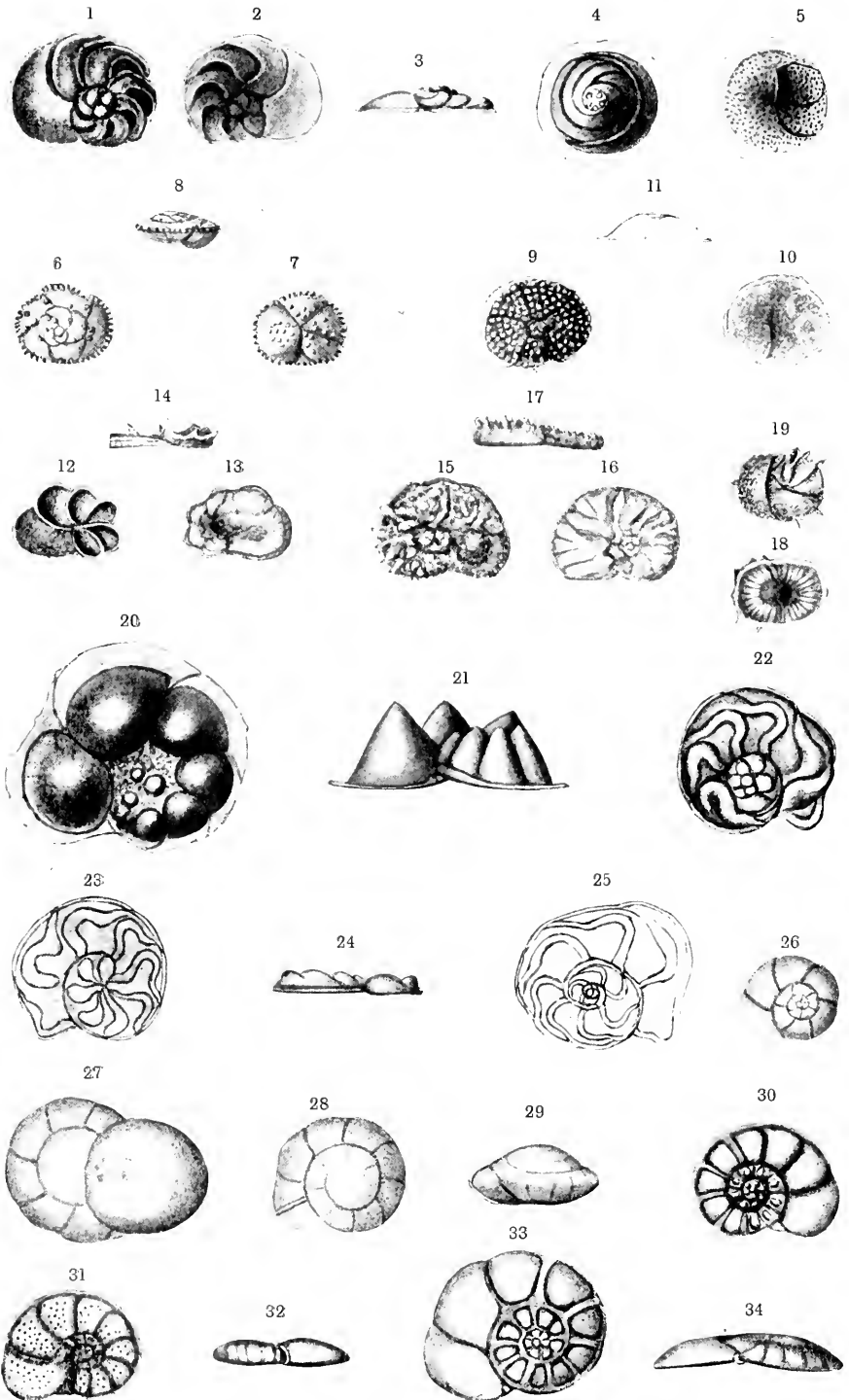

JOURNAL
OF THE
ROYAL MICROSCOPICAL SOCIETY.

SEPTEMBER, 1918.

TRANSACTIONS OF THE SOCIETY.

VII.—*Report on the Recent Foraminifera dredged off the East Coast of Australia. H.M.S. "Dart," Station 19 (14 May, 1895), Lat. 29° 22' S., Long. 153° 51' E., 465 fathoms. Pteropod Ooze—concluded.*

By HENRY SIDEBOTTOM.

[Communicated by E. HERON-ALLEN and A. EARLAND.]

(Read October 17, 1917.)

PLATE VI.

Family ROTALIDÆ.

Sub-family Spirillininæ.

Spirillina Ehrenberg.

Spirillina limbata Brady.

Spirillina limbata Brady. 1879, Quart. Journ. Micr. Sci., vol. xix, N.S., p. 278, pl. viii, fig. 26.

S. limbata Brady, 1884, Chall. Rept., p. 632, pl. lxxxv, figs. 18-21.

The "Challenger" figures show more space between the raised portion of each whorl of the tube than do the tests found in this

EXPLANATION OF PLATE VI.

FIGS.

- 1-3.—*Discorbina bertheloti* (d'Orbigny), var. *complanata* var. nov. Fig. 1, superior view. Fig. 2, inferior view. Fig. 3, edge view. $\times 75$.
4, 5.—*D. circularis* sp. n. Fig. 4, superior view. Fig. 5, inferior view. $\times 50$.
6-8.—*D. tuberculata* Balkwill and Wright, var. *acuta* var. nov. Fig. 6, superior view. Fig. 7, inferior view. Fig. 8, edge view. $\times 110$.
9-11.—*D. pustulata* Heron-Allen and Earland. Fig. 9, superior view. Fig. 10, inferior view. Fig. 11, edge view. $\times 75$.
12-14.—*D. lingulata* Burrows and Hollaud, var. *unquiculata* var. nov. Fig. 12, superior view. Fig. 13, inferior view. Fig. 14, edge view. $\times 75$.

[continued.
S

material. Two out of the three found are of moderate size, the third being smaller.

Spirillina decorata Brady.

Spirillina decorata Brady, 1884, Chall. Rept., p. 633, pl. lxxxv, figs. 22-25.

One large specimen, deeply furrowed; the other two much smaller tests might almost be taken for *S. limbata*, var. *denticulata*, except for the subcarination of the peripheral edge. Judged by the "Challenger" figures and Brady's description none of the three tests are typical, but seem to be intermediate forms between *S. decorata* and *S. limbata*, var. *denticulata*.

Spirillina vivipara Ehrenberg.

Spirillina vivipara Ehrenberg, 1841, Abhandl. k. Akad. Wiss. Berlin, p. 422, pl. iii, fig. 41.
S. vivipara Brady, 1884, Chall. Rept., p. 630, pl. lxxxv, figs. 1-5.

Two occur: one is concave on both surfaces of the test, but more so on the superior surface; the other is slightly concave on the inferior and convex on the superior surface.

Spirillina denticulo-granulata Chapman, var. (Pl. V, figs. 28, 29.)

Spirillina denticulo-granulata Chapman, 1907, Journ. Quekett Micr. Club, Ser. 2, vol. x, p. 133, pl. x, figs. 6, a-c.
S. denticulo-granulata Chapman, 1909, Subantarctic Islands, New Zealand, Article xv, Report Forams., p. 354, pl. xvii, fig. 3.

Five examples occur which are allied to Chapman's species. The chief difference between my specimen and Chapman's is the absence of any limbation. Chapman's figure in the 1909 paper shows very little, if any, limbation of the test. The character of the tubercles, or "small granulations" on the inferior surface varies in different specimens. In the largest test they completely cover the surface, so that the coil is hidden; in the one chosen for illustration the granulation is confined to the centre of the test, the outer

EXPLANATION OF PLATE VI—continued.

FIGS.

- 15-17.—*D. involuta* sp. n. Fig. 15, superior view. Fig. 16, inferior view. Fig. 17, edge view. × 50.
 18, 91.—*D. chasteri*, var. *bispinosa* Heron-Allen and Earland. Fig. 18, superior view. Fig. 19, inferior view. × 100.
 20, 21.—*Truncatulina tenuimargo* Brady. Fig. 20, inferior view. Fig. 21, edge view. × 75.
 22-25.—*Anomalina sinuosa* sp. n. Fig. 22, inferior view. Fig. 23, superior view. Fig. 24, edge view. Fig. 25 mounted in Canada balsam and viewed by transmitted light. × 75.
 26.—*Pulvinulina Karsteni* (Reuss). Fig. 26, superior view. × 75.
 27-29.—*Rotalia soldani* d'Orbigny (?). Fig. 27, superior view with "balloon" chamber. Fig. 28, superior view. Fig. 29, edge view. × 50.
 30-34.—*Operculina ammonoides* d'Orbigny var., *inæquilateralis* var. nov. Figs. 30, 31, 33, lateral views. Figs. 32, 34, edge views. × 50.

coils being "barred." The periphery is subject to slight variation, but none of my tests show it concave as in Chapman's work, 1907, g. 6c.

Spirillina spinigera Chapman.

Spirillina spinigera Chapman, 1900, Journ. Linn. Soc. London, Zool., vol. xxviii, p. 10, pl. i, fig. 7.

Idem. *ibid.*, 1901, vol. xxxviii, p. 188, pl. xix, figs. 9, 10.

S. decorata Brady, var. Sidebottom, 1908, Mem. Proc. Manchester Lit. Phil. Soc., vol. lii, pt. v, p. 8, pl. ii, fig. 6.

A solitary example. It agrees well with the "Delos" specimen which I treated as a variation of *S. decorata* Brady, and which Chapman considers to be referable to his *S. spinigera* (see Chapman, 1909, Foram. Subantarctic Islands, New Zealand, p. 353). It is difficult to discover whether the superior surface is decorated or not owing to granular matter, but I think there is evidence of it. The inferior surface is covered with minute tubercles, and the peripheral edge is very finely serrate.

Sub-family Rotalinæ.

Patellina Williamson.

Patellina corrugata Williamson.

Patellina corrugata Williamson, 1858, Rec. Foram. Gt. Britain, p. 46, pl. iii, figs. 86-89.

P. corrugata Brady, 1884, Chall. Rept., p. 634, pl. lxxxvi, figs. 1-7.

Several occur; all in excellent condition.

Cymbalopora Hagenon.

Cymbalopora pæyi (d'Orbigny).

Rotalia squamosa d'Orbigny, 1826, Ann. Sci. Nat., vol. vii, p. 272, No. 8.

Rosalina pæyi d'Orbigny, 1819, Foram. Cuba, p. 92, pl. iii, figs. 18-20.

Cymbalopora pæyi Brady, 1884, Chall. Rept., p. 636, pl. cii, fig. 13.

C. pæyi Heron-Allen and Earland, 1915, Foram. Kerimba Archipelago, pt. ii, Trans. Zool. Soc. London, vol. xx, pt. xvii, p. 687.

Only small specimens occur. The number of lobes on the inferior surface is four, with the exception of two cases where there are only three. None of the tests are high-domed, like the "Challenger" fig. 13, but appear to be weak forms of *C. pæyi*, var. "Challenger" fig. 14.

Discorbina Parker and Jones.

Discorbina peruviana (d'Orbigny).

Rosalina peruviana d'Orbigny, 1839, Foram. Amér. Mérid., p. 41, pl. i, figs. 12-14.

Discorbina vilardeboana Brady, 1884, Chall. Rept., p. 645, pl. lxxxviii, fig. 2.

D. peruviana Heron-Allen and Earland, 1913, Clare Isl. Foram., Roy. Irish Acad., p. 122, pl. xi, figs. 1-3.

The height of the spire varies. The peripheral edge is sharp. Some of the specimens are very near to the "Challenger" figure of

D. vilardeboana, pl. lxxxviii, fig. 2, which Heron-Allen and Earland consider should be placed under *D. peruviana* d'Orbigny.

Discorbina squamula Reuss.

Discorbina squamula Reuss, 1867, Sitz. k. Ak. Wiss. Wien., vol. lv. (i), p. 101, pl. v, fig. 2.

This is a weak form of *D. rosacea*, but as Mr. Earland considers it identical with *D. squamula* Reuss, it is perhaps worth while recording it under that name. Nine occur.

Discorbina cora (d'Orbigny).

Rosalina cora d'Orbigny, 1839, Foram. Amér. Mérid., p. 45, pl. vi, figs. 19-21.

There are only two examples, and they are not quite typical, although much depressed and sharp edged. The final chamber occupies a much larger portion of the superior face of the test than is usual in this species.

Discorbina araucana (d'Orbigny).

Rosalina araucana d'Orbigny, 1839, Foram. Amér. Mérid., p. 44, pl. vi, figs. 16-18.

Discorbina araucana Brady, 1884, Chall. Rept., p. 645, pl. lxxxvi, figs. 10, 11.

The tests are small and not quite typical.

The limbation along the sutural lines is concave, and broad considering the size of the test, and there is no lobulation of the peripheral edge.

Discorbina rosacea (d'Orbigny).

Rotalia rosacea d'Orbigny, 1826, Ann. Sci. Nat., vol. vii, p. 273, No. 15, Modèle No. 39.

Discorbina rosacea Flint, 1899, Rept. U.S. Nat. Mus. for 1897 (1899), p. 327, pl. lxxii, fig. 3.

D. rosacea Heron-Allen and Earland, 1913, Clare Isl. Foram., Proc. Roy. Irish Acad., p. 124, pl. xi, figs. 7-9.

The examples are not quite typical, having a strong tendency towards the *Asterigerina planorbis* d'Orbigny, of the Vienna Memoir. The asterigene chambers in the umbilical region are rounded off and not star-shaped.

Discorbina isabelleana (d'Orbigny).

Rosalina isabelleana d'Orbigny, 1839, Foram. Amér. Mérid., p. 43, pl. vi, figs. 10-12.

Discorbina isabelleana Brady, 1884, Chall. Rept., p. 646, pl. lxxxviii, fig. 1.

Excellent specimens occur in beautiful condition.

Discorbina concinna Brady.

Discorbina concinna Brady, 1884, Chall. Rept., p. 646, pl. xc, figs. 7, 8.

The examples agree in all respects with Brady's figures in the above reference.

Discorbina bertheloti (d'Orbigny).

Rosalina bertheloti d'Orbigny, 1839, Foram. Canaries, p. 135, pl. i. figs. 28-30.
D. bertheloti Brady, 1884, Chall. Rept., p. 650, pl. lxxxix, figs. 10-12.

The smaller specimens, with one exception, are notable for the strong limbation along the margins of the segments; the larger ones are more normal in this respect and lead up to the largest example present, which appears to me to be the *D. bertheloti*, var. *baconica* Hantken, var. as figured by Brady (1884, Chall. Rept., p. 651, pl. xc, fig. 1), and which he states to be an unimportant variety.

Discorbina bertheloti (d'Orbigny) var. *complanata* nov. var.
(Pl. VI, figs. 1-3.)

Test much depressed, superior surface slightly convex, inferior surface very slightly concave. Seven to eight chambers, narrow and curved, in the outer whorl. Sutures limbate, heavily so on the margins of the earlier chambers. Periphery bordered and acute. The tests are in beautiful condition, and are semi-transparent. I think there is no doubt that this interesting form is closely allied to the *D. bertheloti* (d'Orbigny). I submitted specimens to Mr. Earland, who writes me as follows:—

"The peculiar sigmoid sweep of the chambers is rather striking. If the specimens are wetted you will see that there is excessive and radially increasing limbation of the sutures. . . . The flatness of your specimens is their striking feature." Ten occur.

Discorbina opercularis (d'Orbigny).

Rosalina opercularis d'Orbigny, 1826, Ann. Sci. Nat., vol. vii, p. 271, No. 7.
R. opercularis d'Orbigny, 1839, Foram. Cuba, p. 93, pl. iii, figs. 24, 25;
pl. iv, fig. 1.
Discorbina opercularis Brady, 1884, Chall. Rept., p. 650, pl. lxxxix, figs. 8, 9.

The tests are dull and opaque. They are identical with the "Challenger" specimens.

Discorbina rarescens Brady.

Discorbina rarescens Brady, 1884, Chall. Rept., p. 651, pl. xc, figs. 2, 3.
D. rarescens Egger, 1893, Abhandl. k. bayer. Akad. Wiss., cl. ii, vol. xviii,
p. 388, pl. xv, figs. 45-47.

Six examples of this thin-shelled *Discorbina* were found.

Discorbina circularis, sp. n. (Pl. VI, figs. 4, 5.)

Discorbina rarescens Brady, 1884, Chall. Rept., p. 651, pl. xc, fig. 4(?).

Test circular in outline; superior surface highly convex and glassy in appearance; chambers long, narrow and curved, with

the marginal edge, except in very small specimens, slightly raised. The inferior surface is almost flat, except towards the umbilical region, where it is sunk. On this surface the perforations show conspicuously. The aperture appears to be arched. The test, when full-grown, carries a well-developed keel. The final chamber extends to about three-quarters of the circumference.

I think there is no doubt that this form is the one figured by Brady, 1884, in the "Challenger" Rept., pl. xc, fig. 4, as "*D. rarescens* (?)" It differs totally from *D. rarescens*, having a circular outline, long narrow chambers, and conspicuous perforations on the under-surface. In Brady's figure the long chambers are faintly indicated, also their raised edges. This form occurs more frequently in the material than *D. rarescens*, ten specimens being found.

Discorbina patelliformis Brady.

Discorbina patelliformis Brady, 1884, Chall. Rept., p. 647, pl. lxxxviii, fig. 3; pl. lxxxix, fig. 1.

The specimens are very small and agree best with the "Challenger" illustration, pl. lxxxviii, fig. 3, but two out of the four found are more conical.

Discorbina tuberculata Balkwill and Wright.

Discorbina tuberculata Balkwill and Wright, 1885, Rept. Rec. Foram. Coast of Dublin and Irish Sea, Trans. Roy. Irish Acad., vol. xxviii, p. 350, pl. xiii, figs. 28-30.

D. tuberculata Sidebottom, 1904, etc., Rept. Rec. Foram. Coast of Isl. Delos, Mem. Manchester Lit. and Phil. Soc., pt. v, vol. lii, 1908, p. 15, pl. v, fig. 5.

The six examples that occur are quite typical.

Discorbina tuberculata B. & W., var. *acuta* nov. (Pl. VI, figs. 6-8.)

This is evidently a variant of *D. tuberculata*, in which the tubercles on the superior surface are confined to the acute peripheral and inner edges of the chambers.

The superior surface is less convex than in the type-form, and the sutures, which have a jagged appearance, are not so deeply sunk. The under-surface of the test is more convex than the superior, and the tubercles are more normally placed.

Discorbina pustulata Heron-Allen and Earland. (Pl. VI, figs. 9-11.)

Discorbina pustulata Heron-Allen and Earland, 1913, Clare Island Survey, Proc. Roy. Irish Acad., vol. xxxi, pt. lxiv, Foram., p. 129, pl. xii, figs. 5-7.

D. pustulata Heron-Allen and Earland, 1915, Foram. Kerimba Archipelago, pt. ii, Trans. Zool. Soc. London, vol. xx, pt. xvii, p. 701, pl. lii, figs. 24-26.

Two excellent examples occur, which agree best with the "Kerimba" illustration in the above reference, but the tubercles on the superior surface of the test are much more numerous, practically covering the whole surface, and giving a beautiful appearance to this interesting species. The sutures are slightly sunk and almost hidden by the tubercles, which are arranged in lines on either side.

Discorbina biconcava Parker and Jones.

Discorbina biconcava Parker and Jones, 1865, Phil. Trans., vol. clv, p. 422 pl. xix, fig. 10.

D. biconcava Brady, 1884, Chall. Rept., p. 653, pl. xci, fig. 2.

A single small specimen, more compressed than the type-form

Discorbina lingulata Burrows and Holland.

Discorbina lingulata Burrows and Holland, Foram. Crag., 1895, pt. ii, Pal. Soc., p. 297, pl. vii, figs. 33, a-c.

D. biconcava Brady, 1884, Chall. Rept., p. 653, pl. xci, fig. 3.

Six immature tests occur.

Discorbina lingulata Burrows and Holland, var. *unguiculata* nov. var.
(Pl. VI, figs. 12-14.)

The inferior surface corresponds with that of the type-form, but the chambers on the superior surface are keeled, and sometimes instead of lying flat are more or less tilted up. Six were found. Mr. Earland kindly suggested the varietal name.

Discorbina involuta sp. n. (Pl. VI, figs. 15-17.)

Superior surface convex, or more or less flattened. The septæ between the chambers are produced as highly limbate walls; the surface between the limbate sutures is tuberculate. Inferior surface flat, the internal septæ hardly visible on either surface. The number of chambers in the out-whorl is probably about seven. Subsidiary septæ project from the outer margin into the interior of the chambers, between the upper and lower walls. In the adult stage the test is opaque.

Nearly the whole of the above description is taken from notes kindly sent to me by Mr. Earland, to whom I submitted specimens, and who has spent considerable time on their examination. He also points out that no doubt with the increase in size of the test the number of the subsidiary septæ would become more numerous, and eventually the chambers would become semi-labyrinthic. Personally, I think the subsidiary septæ are the foundation of the numerous tubercles which appear on the superior surface. The test chosen for illustration is one of the flatter specimens.

Discorbina chasteri, var. *bispinosa*. Heron-Allen and Earland.
(Pl. VI, figs. 18, 19.)

Discorbina chasteri, var. *bispinosa* Heron-Allen and Earland, 1913, Clare Island Survey, Proc. Roy. Irish Acad., vol. xxxi, pt. lxiv, Foram., p. 129, pl. xiii, fig. 4.

The under-surface agrees with the type-form.

Two found.

Truncatulina d'Orbigny.

Truncatulina lobatula (Walker and Jacob).

"*Nautilus spiralis lobatus*, etc.," Walker and Boys, 1784, Test. Min., p. 20, pl. iii, fig. 71.

N. lobatulus Walker and Jacob, 1798, Adam's Essays, Kanmacher's Ed., p. 642, pl. xiv, fig. 36.

Truncatulina lobatula Williamson, 1858, Rec. Foram. Gt. Britain, p. 59, pl. v, figs. 121-23.

A large specimen, and a few smaller ones.

Truncatulina wuellerstorfi (Schwager).

Anomalina wuellerstorfi Schwager, 1866, Novara-Exped. Geol. Theil, vol. ii, p. 258, pl. vii, fig. 105.

Truncatulina wuellerstorfi Brady, 1884, Chall. Rept., p. 662, pl. xciii, figs. 8, 9.

Capital examples of this depressed species are present.

Truncatulina akneriana (d'Orbigny).

Rotalina akneriana d'Orbigny, 1846, For. Foss. Vienne, p. 156, pl. viii, figs. 13-15.

Truncatulina akneriana Brady, 1884, Chall. Rept., p. 663, pl. xciv, fig. 8.

Numerous examples occur, varying a good deal in size. The larger tests are more coarsely built than the smaller ones.

Truncatulina ungeriana (d'Orbigny).

Rotalina ungeriana d'Orbigny, 1846, For. Foss. Vienne, p. 157, pl. viii, figs. 16-18.

Truncatulina ungeriana Brady, 1884, Chall. Rept., p. 664, pl. xciv, fig. 9.

The tests agree with the "Challenger" examples.

Truncatulina robertsoniana Brady.

Truncatulina robertsoniana Brady, 1881, Quart. Journ. Micr. Sci., vol. xxi, N.S., p. 65.

T. robertsoniana Brady, 1884, Chall. Rept., p. 664, pl. xcv, fig. 4.

There are six tests. They answer to Brady's description, except that the chambers in the final whorl are not quite so numerous, and only one specimen is of the typical colour.

Truncatulina haidingerii (d'Orbigny).

Rotalina haidingerii d'Orbigny, 1846, For. Foss. Vienne, p. 154, pl. viii, figs. 7-9.

Truncatulina haidingerii Brady, 1884, Chall. Rept., p. 663, pl. xcv, fig. 7

Similar to the "Challenger" tests in every respect.

Truncatulina reticulata (Czjzek).

Rotalina reticulata Czjzek, 1848, Haidinger's Naturw. Abhandl., vol. ii, p. 145, pl. xiii, figs. 7-9.

Truncatulina reticulata Brady, 1884, Chall. Rept., 669, pl. xcvi, figs. 5-8.

The examples are well developed.

Truncatulina pygmaea Hantken.

Truncatulina pygmaea Hantken, 1875, Mittheil. Jahrb. d. k. ung. geol. Anstalt, vol. iv, p. 78, pl. x, fig. 8.

T. pygmaea Brady, 1884, Chall. Rept., p. 666, pl. xcv, figs. 9, 10.

This is one of the best represented forms of the *Truncatulina* in the gathering. The convexity of the superior surface varies. The lobulation of the periphery and the slight roughness of both the surfaces are distinctive.

Truncatulina culter (Parker and Jones).

Planorbulina culter Parker and Jones, 1865, Phil. Trans., vol. clv, p. 421, pl. xix, fig. 1.

Truncatulina culter Brady, 1884, Chall. Rept., p. 668, pl. xcvi, fig. 3.

This, again, is one of the well-represented forms. Most of the tests show a certain amount of colouring of a light brown shade. In one case the keel is well developed.

Truncatulina tenera Brady.

Truncatulina tenera Brady, 1884, Chall. Rept., p. 665, pl. xcv, fig. 11.

Brady mentions the difficulty of distinguishing between *T. tenera* and *Pulcinulina umbonata* Reuss. I have placed the specimens under the above heading on account of the pronounced lobulation of the test, which, in the "Challenger" illustrations of the two forms, is much more marked in *T. tenera* Brady than in *P. umbonata* Reuss.

Truncatulina tenuimargo Brady. (Pl. VI, figs. 20, 21.)

Truncatulina tenuimargo Brady, 1884, Chall. Rept., p. 662, pl. xciii, figs. 2, 3.
T. tenuimargo Egger, 1893, Abhandl. k. bayer. Acad. Wiss., cl. ii, vol. xviii, p. 399, pl. xvi, figs. 7-9.

T. tenuimargo Heron-Allen and Earland, 1908, etc., Rec. and Foss. Foram. Selsey Bill, Sussex, Journ. Roy. Micr. Soc., 1909, p. 680, pl. xx, fig. 2.

A most interesting set.

The small form (fig. 3 in the Chall. Rept.) is present; but

the chief interest centres round the variety, fig. 2, in which, in some cases, the chambers on the inferior surface assume the form of erect cones, the sutures being very deep; in fact, the last two chambers in some of the specimens are almost independent of each other. The keel is well developed. Two of the tests show colour, one being of a light brown tint and the other much darker, especially in the earlier chambers.

Four occur similar to the "Challenger" fig. 3, and fourteen of the variety specially mentioned. These latter vary in size.

Anomalina d'Orbigny.

Anomalina ammonoides (Reuss).

Rosalina ammonoides Reuss, 1845, Varstein. böhm. Kreide, p. 36, pl. viii, fig. 53; pl. xiii, fig. 66.

Anomalina ammonoides Brady, 1884, Chall. Rept., p. 672, pl. xciv, figs. 2, 3.

Excellent examples occur.

Anomalina coronata Parker and Jones.

Anomalina coronata Parker and Jones, 1857, Ann. and Mag. Nat. Hist., Ser. 2, vol. xix, p. 294, pl. x, figs. 15, 16.

A. coronata Brady, 1884, Chall. Rept., p. 675, pl. xcvi, figs. 1, 2.

Two good specimens occur.

Anomalina polymorpha Costa.

Anomalina polymorpha Costa, 1856, etc., Atti dell' Accad. Pontan., vol. vii, p. 252, pl. xxi, figs. 7-9.

A. polymorpha Brady, 1884, Chall. Rept., p. 676, pl. xcvi, figs. 3-6.

This rough and spinous *Anomalina* is represented by two excellent specimens.

Anomalina sinuosa, sp. n. (Pl. VI, figs. 22-25.)

Test compressed. Superior surface flat or slightly concave. Inferior surface slightly convex, with sloping sides and generally a little hollowed in the region of the earlier chambers. Peripheral edge acute. The chambers, of which there are five or six in the outermost whorl, are irregular in shape, sinuous and difficult to distinguish (except when the test is mounted in Canada balsam and viewed as a transparency), owing to the excessive limbation, which is often broader in parts than the adjacent portion of the chamber. The limbation along the septal lines is raised and rounded, varies in width and is extraordinarily sinuous. The test is semi-transparent, a little roughened on the inferior face. The aperture is difficult to distinguish, but appears to be situated near the inner edge of the very narrow septal face of the final chamber. The end of the final chamber does not always project

as in the drawings, but sometimes finishes off regularly. I have found it a difficult foraminifer to draw and describe, but the drawings are quite sufficient for its identification. The tests chosen for illustration were selected as the easiest to draw, the limbation being not quite so excessive as in the others.

Twelve occur.

Pulvinulina Parker and Jones.

Pulvinulina menardii (d'Orbigny).

Rotalia menardii d'Orbigny, 1826, Ann. Sci. Nat., vol. vii, p. 273, No. 26, Modèle No. 10.

Pulvinulina menardii Brady, 1884, Chall. Rept., p. 690, pl. ciii, figs. 1, 2.

This species is well represented.

Pulvinulina tumida Brady.

Pulvinulina menardii, var. *tumida*, Brady, 1877, Geol. Mag., Ser. 2, vol. iv, p. 535.

P. tumida Brady, 1884, Chall. Rept., p. 692, pl. ciii, figs. 4-6.

This thick variety is also present.

Pulvinulina canariensis (d'Orbigny).

Rotalina canariensis d'Orbigny, 1839, Foram. Canaries, p. 130, pl. i, figs. 34-36.

Pulvinulina canariensis Brady, 1884, Chall. Rept., p. 692, pl. ciii, figs. 8-10.

Excellent examples.

Pulvinulina patagonica (d'Orbigny).

Rotalina patagonica d'Orbigny, 1839, Foram. Amér. Mérid., p. 36, pl. ii, figs. 6-8.

Pulvinulina patagonica Brady, 1884, Chall. Rept., p. 693, pl. ciii, fig. 7.

There is a great contrast in size between this and *P. canariensis*, to which Millett considers it is closely related.

Pulvinulina crassa (d'Orbigny).

Rotalina crassa d'Orbigny, 1840, Mém. Soc. Géol. France, vol. iv, p. 32, pl. iii, figs. 7, 8.

Pulvinulina crassa Brady, 1884, Chall. Rept., p. 694, pl. ciii, figs. 11, 12.

The tests are well developed.

Pulvinulina truncatulinoides (d'Orbigny).

Rotalina truncatulinoides d'Orbigny, 1839, Foram. Canaries, p. 132, pl. ii, figs. 25-27.

R. micheliniana d'Orbigny, 1840, Mém. Soc. Géol. France, vol. iv, p. 31, pl. iii, figs. 1-3.

Pulvinulina truncatulinoides Rhumbler, 1900, in Karl Brandt's Nordisches Plankton, Heft 14, p. 17, figs. 16-18.

The examples are quite normal.

Pulvinulina elegans (d'Orbigny).

- Rotalia* (*Turbinulina*) *elegans* d'Orbigny, 1826, Ann. Sci. Nat., vol. xii, p. 276, No. 54.
Pulvinulina elegans Brady, 1884, Chall. Rept., p. 699, pl. cv, figs. 4-6.

Pulvinulina partschiana (d'Orbigny).

- Rotalina partschiana* d'Orbigny, 1846, For. Foss. Vienne, p. 153, pl. vii, figs. 28-30; pl. viii, figs. 1-3.
Pulvinulina partschiana Brady, 1884, Chall. Rept., p. 699, pl. cv, fig. 3, and p. 700, fig. 21.

These allied forms are both present, and the carinate form also. This latter is quite transparent, and the specimens are much smaller than those of the type-form.

Pulvinulina auricula (Fichtel and Moll).

- Nautilus auricula*, var. *a*, Fichtel and Moll, 1798, Test. Micr., p. 108, pl. xx, figs. *a*, *b*, *c*.
Pulvinulina auricula Brady, 1884, Chall. Rept., p. 688, pl. cvi, fig. 5.

Fine typical tests occur. Rare.

Pulvinulina oblonga (Williamson).

- Pulvinulina auricula*, var. *β*, Fichtel and Moll, 1798, Test. Micr., p. 108, pl. xx, figs. *d*, *e*, *f*.
P. auricula Brady, 1884, Chall. Rept., p. 688, pl. cvi, fig. 4.

The tests are small, but they occur more frequently than *P. auricula*.

Pulvinulina exigua Brady.

- Pulvinulina exigua* Brady, 1884, Chall. Rept., p. 696, pl. ciii, figs. 13, 14.

This small form occurs frequently.

Pulvinulina karsteni (Reuss). (Pl. VI, fig. 26.)

- Rotalia karsteni* Reuss, 1855, Zeitschr. d. deutsch. geol. Gesellsch., vol. vii, p. 273, pl. ix, fig. 6.
P. karsteni Brady, 1884, Chall. Rept., p. 698, pl. cv, figs. 8, 9.
P. karsteni Heron-Allen and Earland, 1916, Foram. West of Scotland, Trans. Linn. Soc. London, 2nd ser, Zool., vol. xi, p. 276, pl. xlii, figs. 34-37.

I submitted tests to Mr. Earland for inspection, and he writes to me that "these immature and pauperate forms are frequent in British dredgings."

The specimens are hyaline and agree with the illustrations from the West of Scotland in the above reference. Frequent.

Pulvinulina hauerii (d'Orbigny).

Rotalina hauerii d'Orbigny, 1846, For. Foss. Vien., p. 151, pl. vii, figs. 22-24.
Pulvinulina hauerii Brady, 1884, Chall. Rept., p. 690, pl. cvi, figs. 6, 7.

Except that the tests are not quite so stout, the examples agree with the "Challenger" fig. 7.

Rotalia Lamarck.

Rotalia orbicularis (d'Orbigny).

Gyroidina orbicularis d'Orbigny, 1826, Ann. Sci. Nat., vol. vii, p. 278, No. 1, Modèle No. 13.

Rotalia orbicularis Brady, 1884, Chall. Rept., p. 706, pl. cvii, fig. 5; pl. cxv, fig. 6.

Good examples of this neat form occur.

Most of the specimens are of a clear light brown tint, deepening at the centre of the superior face.

The tests are highly polished, and some of them are almost flat on the upper surface.

Rotalia soldanii (?) d'Orbigny. (Pl. VI, figs. 27-29.)

Rotalia (Gyroidina) soldanii d'Orbigny, 1826, Ann. Sci. Nat., vol. vii, p. 278, No. 5, Modèle No. 36.

Test polished; superior surface, if anything, rather more convex than the inferior; umbilicus flush, not excavated; periphery rounded; aperture a curved slit on the inferior face of the last segment, close to the line of union of the previous convolution.

The specimens may be a pauperate form of *R. soldanii*, but this is open to question, and therefore I have put a query. The chief interest regarding this form is the presence of a "balloon" chamber on three out of the eight examples found, and a fourth (figs. 28, 29) shows traces either of its having had a "balloon" chamber, or of one having been commenced. The orifice and a considerable area of the test are enclosed by this extra chamber.

Family NUMMULINID.E.

Sub-family Polystomellinæ.

Nonionina d'Orbigny.

Nonionina stelligera d'Orbigny.

Nonionina stelligera d'Orbigny, 1839, Foram. Canaries, p. 128, pl. iii, figs. 1, 2.
N. stelligera Brady, 1884, Chall. Rept., p. 728, pl. cix, figs. 3-5.

N. stelligera Heron-Allen and Earland, 1916, Foram. West of Scotland, Trans. Linn. Soc., London, 2nd ser. Zool., vol. xi, p. 280, pl. xliii, figs. 8-10.

Both the forms figured in the "Challenger" Rept. are present. The larger one, with the fewer and more inflated chambers, is frequent; the other very rare.

Nonionina depressula (Walker and Jacob).

Nautilus depressulus Walker and Jacob, 1798, Adam's Essays, Kammacher's edition, p. 641, pl. xiv, fig. 33.

Nonionina depressula Brady, 1884, Chall. Rept., p. 725, pl. cix, figs.

A fair number of specimens found. They vary a good deal in shape. Most of them are slightly elongate, and the edge view of these is not quite symmetrical, the final chambers being a little lobsided. Some of these examples match the *N. scapha* (?) figured by Brady (Chall. Rept., pl. cix, fig. 16), but I have put them under this heading as the greater number are more circular in outline and therefore nearer to *N. depressula*.

Nonionina umbilicatula (Montagu).

Nautilus umbilicatus Montagu, 1803, Tert. Brit., p. 191; Suppl., p. 78, pl. xviii, fig. 1.

Nonionina umbilicatula Brady, 1884, Chall. Rept., p. 726, pl. cix, figs. 8, 9.

Excellent examples occur.

Nonionina scapha (Fichtel and Moll).

Nautilus scapha Fichtel and Moll, 1798, Test. Micr., p. 105, pl. xix, figs. *d-f*.

Nonionina scapha Brady, 1884, Chall. Rept., p. 730, pl. cix, figs. 14, 15, and 16 (?)

The tests are rather small, but occur fairly frequently.

Nonionina turgida (Williamson).

Rotalina turgida Williamson, 1858, Rec. Foram. Gt. Britain, p. 50, pl. iv, figs. 95-97.

Nonionina turgida Brady, 1884, Chall. Rept., p. 731, pl. cix, figs. 17-19.

Several forms found. The one which occurs most frequently is not well developed. It is equilateral and narrower than the type-form. The inequilateral variety is much smaller and rare. Besides these, there are a couple nearer to the type, but one of them is much flattened.

Nonionina boueana d'Orbigny.

Nonionina boueana d'Orbigny, 1846, For. Foss. Vienne, p. 108, pl. v, figs. 11, 12.

N. boueana Brady, 1884, Chall. Rept., p. 729, pl. cix, figs. 12, 13.

A single specimen, not quite circular in outline, with narrow, slightly curved chambers. The test is compressed and small, and cannot be considered typical.

Nonionina orbicularis Brady.

Nonionina orbicularis Brady, 1881, Denkschr. k. Akad. Wiss. Wien., vol. xliii, p. 105, pl. ii, fig. 5.

N. orbicularis Brady, 1884, Chall. Rept., p. 727, pl. cix, figs. 20, 21.

N. orbicularis Madsen, 1895, Medd. Dansk. Geol. Forening, No. 2, p. 217, pl., fig. 7.

N. orbicularis Millett, 1898, etc., Foram. Malay Archipelago, Journ. Roy. Micr. Soc., 1904, p. 600, pl. xi, fig. 1.

A single example. It agrees best with Millett's figure, though the test is rather more compressed. The granulation along the sutural line is well marked.

Polystomella Lamarck.

Polystomella crispa (Linné).

Nautilus crispus Linné, 1767, Syst. Nat., ed. 12, p. 1162, No. 275.

Polystomella crispa Brady, 1884, Chall. Rept., p. 736, pl. cx, figs. 6, 7.

Only two or three very small and weak specimens found.

Polystomella macella (Fichtel and Moll).

Nautilus macellus Fichtel and Moll, 1798, Test. Micr., p. 66, pl. x, figs. e-g.

Polystomella macella Brady, 1884, Chall. Rept., p. 737, pl. cx, figs. 8, 9, 11 and (?) 10.

Two very small, immature specimens.

Polystomella striatopunctata (Fichtel and Moll).

Nautilus striatopunctatus Fichtel and Moll, 1798, Test. Micr., p. 61, pl. ix, figs. a-c.

Polystomella striatopunctata Brady, 1884, Chall. Rept., p. 733, pl. cix, figs. 22, 23.

A solitary, imperfect, and very small example.

Polystomella verriculata Brady.

Polystomella verriculata Brady, 1881, Quart. Journ. Micr. Sci., N.S., vol. xxi, p. 66.

P. verriculata Brady, 1884, Chall. Rept., p. 738, pl. cx, fig. 12.

Two occur.

Polystomella imperatrix (?) Brady.

Polystomella imperatrix Brady, 1881, Quart. Journ. Micr. Sci., vol. xxi, N.S., p. 66.

P. imperatrix Brady, 1884, Chall. Rept., p. 738, pl. cx, figs. 13-15.

Three small tests, which are not typical.

They carry several spines, but the limbate septal lines and retral bars are irregular and very pronounced for the size of the test, partaking much more of the character of *P. verriculata* than of the typical *P. imperatrix*. The specimens might with equal propriety be considered as a spinous form of *P. verriculata*. Until more examples are found I have thought it best to put a query.

Polystomella milletti Heron-Allen and Earland.

Polystomella verriculata Millett, 1898, etc., Foram. Malay Archipelago, Journ. Roy. Micr. Soc., 1904, p. 604, pl. xi, fig. 3.

P. milletti Heron-Allen and Earland, 1915, Foram. Kerimba Archipelago, pt. ii, Trans. Zool. Soc. London, vol. xx, pt. xvii, p. 735, pl. liii, figs. 38-42.

Two occur. They are small and not typical, but I think there is no doubt that they are a variety of this evidently variable species. Each has only seven chambers in the outer whorl, and is slightly inequilateral, one face being slightly convex, and the other more flattened. The tests are also more compressed than in

the type. They are decorated with what appear to be exceedingly fine, short spines, which often seem to coalesce and so give a sugary appearance to the test. I have a fine range of specimens of the type-form from the Seychelles Islands, Mahé Harbour, 14 fms. Some of these attain large dimensions, with only slight lateral compression, and with probably sixteen to eighteen chambers in the final whorl. The lobulation of the rounded peripheral edge is almost lost, and the umbilical region filled up with clear shell-substance, and little decorated. The decoration of the tests consists of reticulations. In some cases this decoration is exceedingly fine and beautiful. Small examples are compressed and smoother, and the outline is lobulated.

Sub-family **Nummulitinæ.**

Amphistegina d'Orbigny.

Amphistegina lessoni d'Orbigny.

Amphistegina lessoni d'Orbigny, 1828, Ann. Sci. Nat., vol. vii, p. 304, No. 3, pl. xvii, figs. 1-4, Modèle No. 98.

A. lessoni Brady, 1884, Chall. Rept., p. 740, pl. cxi, figs. 1-7.

One occurs; similar to the "Challenger" fig. 2.

Operculina d'Orbigny.

Operculina ammonoides d'Orbigny, var. *inoequilateralis*, var. nov.
(Pl. VI, figs. 30-34.)

The type-form is not present, but this interesting variety is well represented. The amount of convexity of the upper surface and the concavity of the under surface varies in the different specimens. In fig. 30 the under surface is almost flat, the septation and aperture being typical. In fig. 33 the edge of the test is sharper, and the septation of the last chambers not so apparent, and the under surface is markedly concave. This latter form, although varying in these particulars, appears to belong to the same variety. The perforations on the under surface are conspicuous in both forms.

CORRIGENDA AND ADDENDA (Journ. R. Micr. Soc., 1918).

- Page 20, line 1 from foot, for "irregular" read "circular."
 " 130 " 15 from top, for "costuta" read "costata."
 " 136 " 21 from top, after "spatulata" add "Sidebottom."
 " 137, after line 19 from foot, add "*F. tenera* Heron-Allen and Earland, 1916, Forum. West of Scotland, Trans. Linn. Soc. London, vol. xi, pt. 13, p. 260."
 " 139, line 5 from top, delete "32 (?)"
 " 141 " 19 " delete comma and put a hyphen.
 " 146 " 15 " for "pygmoea" read "pygmæa."
 " 150 " 14 " for "aequilateralis" read "aequilateralis."
 " 150 " 15 " Ditto, ditto.
 " 150 " 17 " Ditto, ditto.

VIII.—*On the Microstructure of Hypo-eutectoid Steel as contrasted with that of Normal Steel, with a Note on the Microscopical Methods adopted in the Examination of Steel Specimens.*

By E. ATKINSON, A.M.Inst.L.E., F.C.S., F.R.M.S., etc.,
Engineer and Metallurgist.

(Read April 17, 1918.)

PLATES I-III, AND ONE TEXT-FIG.

ALTHOUGH for many years the microscope has proved absolutely indispensable in many fields of research, it is only during comparatively recent years that it has found a place in metallurgy. Previous to the introduction of the microscope, "science" was often looked on either with suspicion or contempt by the practical man engaged in the manufacture of iron and steel. Even the analytical chemist was merely tolerated rather than recognized as being of value or assistance in the production of steel on a commercial scale.

Analyses made by several chemists on the same steel were occasionally found contradictory in results, so, perhaps after all, it is not very surprising that any further introductions of "scientific" nature were liable to be held suspect. However, thanks to the metallurgical microscope, we are enabled to clear up much which was mysterious. It can be seen that, given a satisfactory chemical composition, incorrect after-treatment may render the finished steel either wholly or partly unsuitable for use. Again, as the microstructure may not be uniform, in such cases uniformity in analysis is not to be expected, despite the utmost skill of the analysts to give consistent results. I think this will be fairly well illustrated in the case of R. 288, which forms the subject of this paper.

By the development of photomicrography, the metallurgist has a means of providing permanent records, from which much good may accrue, particularly if he have also a practical knowledge of the methods used in the manufacture of iron and steel, in which case precautions can be taken to eliminate the recurrence of similar difficulties.

The largest percentage of steel in use to-day is of the "hypo-eutectoid" class, or "mild steel" as it is termed in the trade, and consists of steels containing various percentages of carbon not exceeding 0.85 p.c. In such steels examination under the

microscope reveals a certain amount of free or uncombined iron, easily discernible as white silvery veins, as will be seen later. This is termed "ferrite."

"Hyper eutectoid" steel is more highly carburized than the first mentioned, and contains no ferrite, its place being taken by the intensely hard and brittle "cementite." In this paper I propose dealing only with the hypo-eutectoid form, and have selected from my records a recent research made on a rail which did not render the service given by others in similar positions.

The illustration (fig. 1) shows the piece of rail as received; it was about 12 inches long, and from this all the test-pieces were cut, as indicated by the dotted lines. Nos. 1 and 2 were complete sections, and after being carefully polished were first subjected to a laboratory adaptation of the Brinell Test, by which a hardened ball is driven into the steel by a force which remains constant in

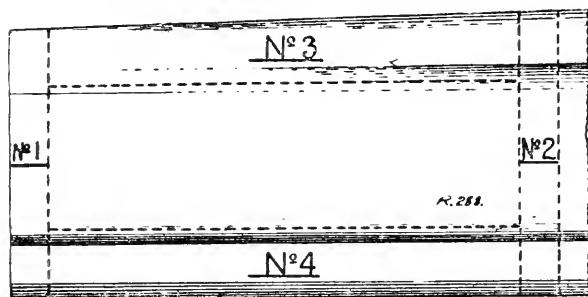

FIG. 1.

each case, so that it naturally follows that the spherical depression will vary in accordance with the resistance opposed to the force expended. By measurement of the indents the degree of hardness, or "hardness number," can be arrived at. Both No. 1 and No. 2 sections emerged fairly well from this test, the hardness numbers being reasonably uniform, as will be seen later. Both were then prepared for "sulphur-printing."

In practically all commercial steels carbon, manganese, silicon, sulphur and phosphorus are present in carefully-regulated proportions, but should sulphur or phosphorus be in excess they are highly detrimental, although little objection can be raised providing both are kept within certain limits. Of course neither exist in steel as simple elements, but effect chemical combinations with the other elements. Unfortunately both sulphur and phosphorus are exceedingly difficult to entirely eliminate.

The presence of sulphur can be detected and recorded by sulphur-printing, for which purpose sheets of silver paper are saturated in a solution of H_2SO_4 , and afterwards placed on an

inclined sheet of plate-glass to enable the excess solution to drain off. The sample is then brought into contact with the paper, when the H_2S evolved produces dark stains of various densities.

The results from No. 1 section gave very definite evidence of the presence of sulphur, and also located the areas in which segregations existed. As will be noted in the illustration (fig. 2), there is a sharply-defined segregation in that part of the section which was originally the centre of the head, and, also, there are fine "sulphur-lines" commencing in the region of the segregate and continuing down into the web, which terminate, curiously enough, in a "curved" formation a little to the left of the centre of the foot, which curve is apparently the most sulphur-free part of this lower area.

On examination of the print from section No. 2 (fig. 3), it will be observed that sulphur is also markedly present—a little better diffused perhaps, although still occupying relatively the same positions as in section No. 1; indeed, each feature is again reproduced, even to the small comparatively sulphur-free "curve," although a reference to the first print will show a rather well-marked area on each side of the foot of considerable density, which at a point 8 in. away—viz. in the section No. 2—is very greatly reduced, though still in evidence, from which it could be assumed that the sulphur was present through the whole length of steel.

The pieces No. 3 and No. 4 were then cut and prepared for tensile-testing, one of the physical tests regularly used. For this the steel is turned perfectly cylindrical for a given distance in the lathe, and suitable "collars" are allowed for in the turning to enable the test-piece to be firmly secured in the machine. The tensile tests were conducted on a 100-ton tensile machine made by Messrs. Buckton and Co., Ltd., Leeds.

Insufficient material remained to enable the test from No. 3 to be made the usual size of 0.798 in. diam. (equal to $\frac{1}{4}$ sq. in. sectional area), so this had perforce to be made 0.565 in. diam. (equal to $\frac{1}{4}$ sq. in. sectional area). Knowing that No. 3 contained a sulphur segregation, experience does not lead us to expect normal tensile results, as, generally speaking, segregated material is apt to be more or less hard and brittle according to the character of the segregation; consequently I expected that a higher tonnage would be required to break the test No. 3 than No. 4, whilst at the same time the reduction in area would not be so great, and also less elongation would be recorded. To facilitate comparisons, the following results are given on the square inch in both cases:—

TENSILE TESTS.

	No. 3.	No. 4.
Breaking stress	43.24 tons	44.51 tons
Reduction in area at point of fracture	24.5 p.c.	40.5 p.c.
Elongation	16.0 "	24.0 "
		T 2

An examination of the test-pieces after fracture proves rather interesting (fig. 4), although the distinctive features are difficult to reproduce photographically. However, the superficial appearance of the cylindrical portions of the two tests is given fair rendition, although the fractures are not so distinctive as in the originals. It will be noted that the fracture of No. 4 is of greater uniformity than the smaller No. 3 above it, and it was of the dark grey "silky" character, which is much more satisfactory in the hypo-eutectoid steels, seeing that it indicates that the steel has received reasonably correct treatment during manufacture.

The smaller fracture shows a darker area, the sulphur segregation thus again announcing its presence. Apart from this, the fracture was of a different order, which gave an inkling of additional irregularities, which were afterwards verified by the microscope.

Drillings were then taken from three positions for analysis, and the results from the head showed the sulphur and manganese to be in excess, which could be expected seeing that particular care was observed to obtain drillings from the segregated area. The chemical composition was:—

4.65 p.c. Fe_3C	0.21 p.c. FeSi_2
1.90 " Mn_3C	0.44 " MnS
0.56 " Fe_3P	92.24 " Fe (dif.)

And from this we can arrive at the approximate microstructure of the steel. The cementite contains the Fe_3C plus the Mn_3C , and the Fe_3P and the FeSi_2 are contained in the ferrite, whilst situated somewhere in the structure is 0.44 p.c. of MnS as "enclosures" of non-metallic nature. Hence we get:—

6.55 p.c. Cementite
0.44 " MnS (enclosed impurities)

In hypo-eutectoid steel the pearlite (so termed from its "pearly" appearance when viewed under oblique lighting) is the strengthening constituent. Under high magnification it is seen to be composed of alternate plates of cementite and ferrite; at lower magnifications, however, it appears as a dark area in the ferrite. The total pearlite is represented by eight times the percentage of cementite. Although this factor has not been definitely decided on so far, I think we can accept it as being quite near enough for our purpose, and so from the above we may expect to find approximately—

52.40 p.c. Pearlite
0.44 " MnS (enclosed impurities)
55.16 " Ferrite
<hr/> 100.00

Theoretically, in the presence of such a high percentage of manganese, all the sulphur present in R. 288 should be in the

Section No. 1.



FIG. 1.

Section No. 2.



FIG. 3.

Tensile test pieces.

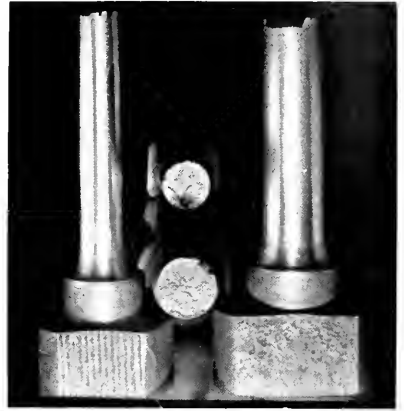

No. 3.

No. 4.

FIG. 4.



FIG. 5.
100x



FIG. 6.
100x

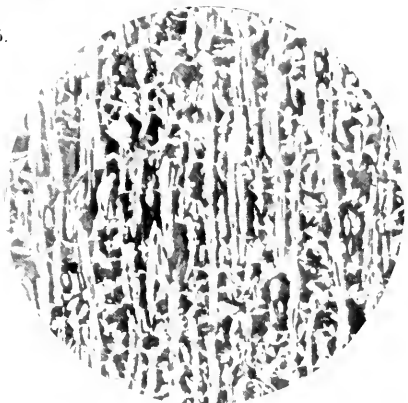

FIG. 7.
100x

form of MnS, which, although not a desirable constituent, is nevertheless the safest form the sulphur can assume, since MnS is about the first to solidify when the molten steel is crystallizing out to form the ingot. The freezing-point of pure MnS is generally accepted as being 1620° C., whilst that of pure iron is 1500° C.

When sulphur combines with the iron to form FeS it is highly detrimental if in any quantity. Now, whereas MnS separates out and appears as "dove-grey" islands in the ferrite, FeS tends to form membranous sheaths surrounding the pearlite crystals in such a manner as to seriously interfere with the vitally necessary adhesion of one pearlite crystal to another, or the pearlite to the ferrite, and consequently it is a source of weakness, and renders the steel unreliable. The melting-point of FeS is about 950° C., so that during the rolling process, which generally commences at a higher temperature than this, it will be seen that whilst the ingot as a whole has "set" (though still plastic) the membranous FeS is still in a liquid state, and so destroys the cohesion which is absolutely essential whilst the ingot is undergoing the required reduction by rolling. In extreme cases the red-hot ingot will break into several pieces. That such effects are produced by sulphur has long been known to the steel-maker, although I believe I am correct in saying that the cause was something in the nature of a mystery until the microscope defined the form of MnS and FeS. Where the latter is present with its low melting-point it is now known that it is rather like attempting to bind two solids together with a liquid. Rather a difficult proposition!

As in this case we had clear indications of the doubtful areas as found by sulphur-printing. Three pieces were cut for examination; the first containing the marked segregation, the second containing what was evidently a branch of it in the web, and the third was from the foot. Visual examination previous to "etching" revealed the presence of the MnS enclosures, which can be seen in the first photomicrograph (fig. 5). It must be understood that this illustration was not representative of the whole. It was selected from a part particularly rich in these enclosures in order that the various formations could be observed. In the centre, where evidently the rolling-stresses have been least exerted, it will be seen that there is quite a tendency for the MnS to partly retain the "globular" form, whilst further away the stresses have apparently tended to break the larger globules up into smaller units, with a tendency to form into lines. A glance at the first sulphur-print (fig. 2) will show that there are fine though well-defined sulphur "lines" in the web, and in order that the elongated shape of the MnS could be seen another photograph was taken in the web.

It will be observed in another photograph from the same specimen (fig. 6) that, with one exception, the MnS exists in small

isolated particles, and as these do not break up the continuity of the ferrite to the same extent they are not seriously detrimental. Visual examination proved that apart from these markedly segregated positions the MnS was in small particles distributed over the whole surfaces of the three specimens.

After etching, the specimens from R. 288 became decidedly interesting. The pearlite crystals (formed by the combination of the Fe_3C and the Mn_3C), and also the silvery ferrite, could be observed. As seen visually the MnS enclosures in the ferrite are still very noticeable owing to the difference in colour, although they do not appear in quite the same sharp contrast when photographed after "etching."

The position of a second photograph (fig. 7) in the web can be seen on the plan. Here the general "banded" structure of the ferrite predominates, and although it can be expected that there should be some tendency in this direction, owing to the severity of the rolling-stresses necessary to reduce the steel down to form this comparatively thin component of the rail, this is too marked to be attributable to rolling-stresses alone, and is due to segregation of phosphorus towards the crystal boundaries whilst the steel is undergoing the first crystallization to form the ingot. The ferrite, rich in phosphorus, apparently resists the entry of carbon, and so would appear to confine the pearlite to areas free from phosphorus. When this "banded" structure, or "ghost lines" as termed by some, is formed, it is extremely persistent, and is difficult to remove even by prolonged annealing. It is a frequent cause of weakness in steel plates and many failures are attributed to it.

The next photograph (fig. 8) is of a character not frequently met with. The magnification was 50 diameters, and so includes the structures in the segregation and also the microstructure above that area, whilst an almost continuous line of ferrite divides the two. The irregularity of the crystals above the ferrite line afford unmistakable evidence of incorrect thermal treatment, although the lower pearlite crystals are of greater uniformity.

The sixth photograph (fig. 9) was taken midway between the depression left by the first physical test and the top of the specimen. The large size of the pearlite crystals will be noted, also the fine needle-like lines of ferrite in the pearlite, from which it becomes apparent that the nearer we approach the top of the rail the thermal treatment has produced worse effects; indeed the condition of the structures here very nearly approaches that of the steel as first cast. It is typical "Widmanstätten" structure, and tends to weakness.

Of course it is well known that the smaller the crystals are the better the resultant material, so long as deformation has not taken place. The old-time smith had some idea of this, and consequently belaboured his glowing iron right royally so that it should prove

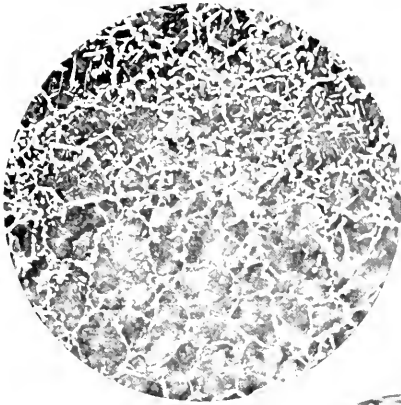

FIG. 8.
50 ×

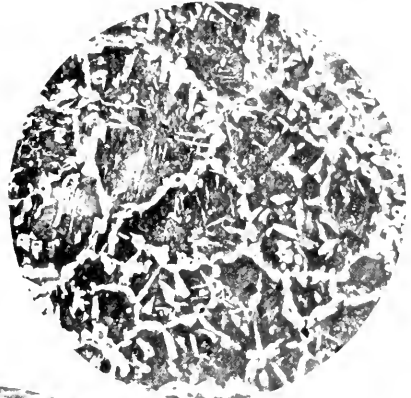

FIG. 9.
100 ×



FIG. 10.
100 ×

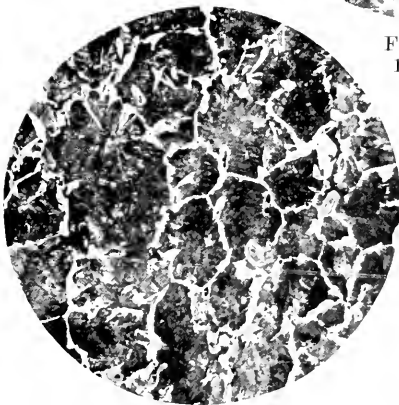

FIG. 11.
100 ×

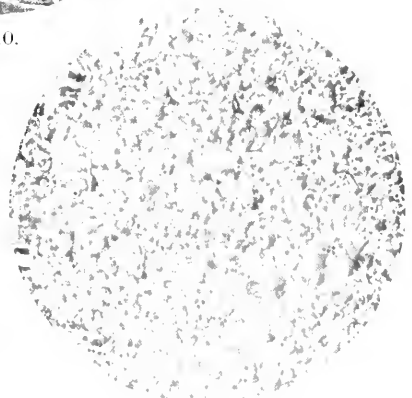

FIG. 12.
100 ×

tough and durable in use. I remember one such worthy man to whom I mentioned the crystalline structure of iron and steel. His concluding comment was, "Well, crystals or no crystals, I gives the stuff a good hammering, because, as I says, good stuff always goes in little room!" If some of that muscular smith's energy could have been used to put the "stuff in little room" in this case, No. 9 would have presented a much more satisfactory picture.

The photograph No. 4 (fig. 10) was taken at the top of the specimen, and illustrates how the large crystals shown in No. 9 have failed to preserve their original formation under the repeated pressures exerted by the wheels of the rolling-stock. Seeing that immediately below this position the general structures were the same as No. 9, we can safely assume that this was the original condition at No. 4 when this rail was first put into use. If anything it is possible the condition was aggravated, seeing that this part must necessarily have been nearer to the surface of the ingot when exposed to the conditions obtained in the heating-furnace. It will be noticed that the structure as a whole has broken down, and the original pearlite polyhedrons have been crushed down one upon the other and deformed.

The seventh photograph (fig. 11) was taken in the sulphur segregation below the test-depression. The pearlite and ferrite are well defined, and careful scrutiny will reveal the enclosures of MnS surrounded by the ferrite in each case, and MnS in turn containing small inclusions of manganese silicates, although not to the same extent as seen previously.

In the eighth photograph (fig. 12), taken below the test depression in the specimen cut from the foot, we find the pearlite assuming another form quite different from that shown in the previous photographs. Presenting as it does rather an emulsified appearance, it leads one to think that the full development has been arrested before completion. By analysis the carbon-content (which is the principal element necessary for the formation of pearlite) is for all practical purposes the same in this part of the steel as in the other parts already seen, and consequently one expects to find the structure here to be much the same in formation. To this imperfect development the name of "sorbite," or "sorbitic pearlite," has been given. It is apt to result by a rapid cooling of hot-worked hypo-eutectoid steel through its critical range, and so leaving insufficient time for the rejection of the full amount of ferrite. While sorbitic pearlite is not quite so ductile as pearlite, which is fully developed, it has a higher tenacity, so that had the foot of this rail been subjected to the wheel-pressures instead of to the head considerably better service could have been looked for.

During the examination of the top specimen still another irregularity was noticed at No. 5 (fig. 13). On the left are a few pearlite crystals in the segregation with several small MnS

enclosures present in the ferrite. On the right are crystals outside that area. Dividing the two is an irregular network-like structure such as we have not found in the previous photomicrographs, to account for which I must revert to the manufacturing conditions.

When the steel has been poured into the comparatively cold ingot-moulds the reduction in temperature promotes solidification, and it is during this period of solidification and contraction that the ingot defects of "blow-holes," "contraction-cavities," and "piping" are produced. The surfaces of the "piping" are oxydized, and so cannot be remedied in the later stages; but "blow-holes" (which are probably produced by the evolution of CO due to chemical action) generally exhibit bright metallic surfaces free from oxide films, so that under favourable circumstances they may be welded up. An enormous amount of experimental work and research has been conducted to eliminate these defects, and although considerable improvement has been effected we are still far from having solved the problem.

Under the conditions obtaining when R. 288 was manufactured little had been accomplished in this direction beyond cutting a sufficient portion from the finished steel to warrant the assumption that the part removed contained the defects. Really it rather introduced the sporting element in which one had to hope for the best! Despite this, however, that rather maligned individual the "practical man" had his own methods of detecting doubtful material, and a considerable measure of success was achieved when such a man supervised the manufacture.

In No. 13 I am of the opinion that this fine "network" is evidence that a small "blow-hole" originally existed in this part of the steel, the walls of which have been pressed up and welded together during the rolling. Such welding is by no means impossible, and probably occurs with greater frequency than we are aware of, but as these are conditions pertaining to the interior anatomy of the steel it is only rarely that the opportunity is accorded to study them.

In reviewing the foregoing data we have evidence of a marked segregation of sulphur; the tensile tests gave its quota towards proving the continuity of the segregation, and the analysis confirmed it. Under such conditions it can generally be taken for granted that phosphorus is segregated also, and this we found to be the case in the web, as shown in the "banded" structure there.

The microscope proves that although a little FeS is present the greater proportion of sulphur exists as MnS, and so is in its most innocuous form; in addition there is that welded up "blow-hole"—all of which points to that portion of the ingot from which R. 288 was rolled.

There is also the marked difference in the crystal structures: sorbitic pearlite in the foot; the "banded" structure in the web;

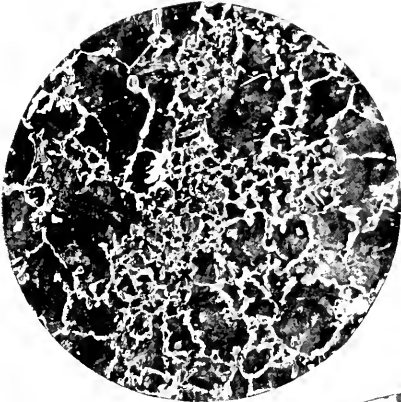

FIG. 13.
100 ×

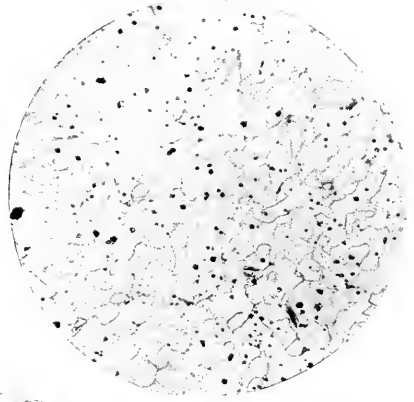

FIG. 14.
100 ×

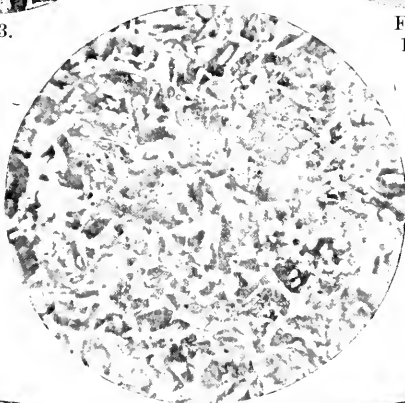

FIG. 15.
100 ×

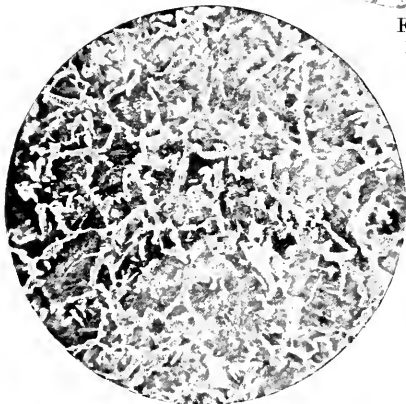

FIG. 16.
100 ×

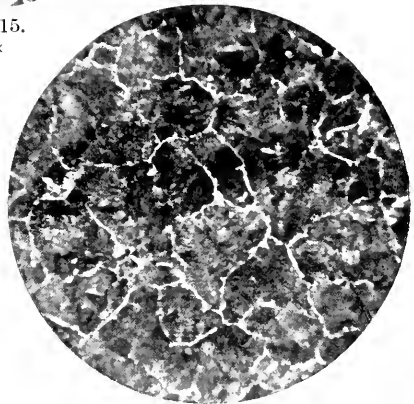

FIG. 17.
100 ×

and also those large crudely-formed pearlite areas of Widmanstatten structures in the head, which proved unable to maintain their formation under wheel action; and so it becomes comparatively simple to arrive at the cause of failure by deduction.

MICROSTRUCTURE OF NORMAL STEELS.

The four concluding photographs serve to illustrate normal crystal structures. The first one (fig. 14) shows an almost carbon-less iron, and consequently only the dark tracery of the crystal boundaries is to be seen, as practically no pearlite areas are present. The dark spots are enclosures of FeO. The two specimens of more highly carburized steels (figs. 15 and 16) are from material which fulfilled all the specified conditions of testing.

The last one (fig. 17) is from a hypo-eutectoid steel of different composition and treatment, which I have recently perfected and made on a commercial scale. As could be expected from the uniformity of microstructure and the absence of enclosed impurities this special steel possesses tenacity and elasticity considerably in advance of the ordinary steels at present used.

Note on the Microscopic Methods adopted in the Examination of Steel Specimens.

PREPARATION.

The sample for examination under the microscope is first lightly rubbed on a very fine-cut file until perfectly level, and exhibiting the lines of abrasion lying in one direction. Polishing then proceeds on commercial emery-papers until the previous file-marks are entirely removed and replaced with the finer ones produced by the emery; which course is followed on each of the four succeeding grades of specially-prepared French emery-papers. Considerable care is required to prevent the transference of the coarser grains of emery to the finer papers, and, if due care is not observed in this respect, it is practically impossible to produce good specimens free from scratches. The polishing is completed by placing the specimen in contact with a cloth or chamois-leather covered disc, primed with alumina or ferric oxide, and, as the disc is revolved at high speed by suitable gearing, the specimen soon assumes a featureless silvery appearance quite free from the minute scratches left by the previous operations.

The specimen is then washed to remove any traces of the polishing medium, again washed in alcohol, and rapidly dried in the hot-air blast. A little plasticine is then placed on the usual

glass slide, the specimen placed thereon, and pressed into a perfectly horizontal position by a specially-made mounting apparatus, and is then ready for examination.

ETCHING.

After the examination of the plain polished surface is completed the crystal structure is developed by etching. Many reagents are used for etching, but perhaps the mention of one or two will suffice. Probably the simplest is to dip the specimen into concentrated HNO_3 ; it then assumes the passive state, but on rinsing-off under a jet of water, the metal is sharply attacked momentarily. It is then immersed in alcohol, and dried in the hot-air blast. A dilute solution of HNO_3 in alcohol, or a saturated solution of picric acid, can be used. These etching solutions darken the pearlite, but leave the ferrite in its original state.

ILLUMINATION.

Illumination is accomplished either by oblique or vertical lighting, and, although several illuminants can be used, the electric arc is undoubtedly superior to any other form of light source. The lens system employed in my laboratory consists of a $4\frac{1}{2}$ -in. Meniscus and two plano-convex lenses of the same dimensions, suitably enclosed; the first parallelizing the light-rays received from the illuminant, and the third projecting a converging beam to the plain glass vertical illuminator which, at an angle of 45° , is situated immediately above the objective; from thence it is reflected down through the objective and so to the specimen on the stage.

For oblique lighting the vertical illuminator is either removed altogether, or turned into a horizontal position parallel to the surface of the specimen.

IX.—*Two Valuable Methods of
Staining in Bulk and Counter-Staining.*

By E. J. SHEPPARD.

Read April 17, 1918.

A METHOD which will materially cut short a lengthy process such as Heidenhain's iron-hæmatoxylin staining, and, at the same time, give as good results, should be of value to either histologist or cytologist; either of the following methods here described does this, and for the first I claim some measure of originality.

My work has been confined chiefly to animal and insect tissues for the study of spermatogenesis, but there is reason to believe that the methods are equally applicable to vegetable tissues.

1. Details of the actual staining must be prefaced by particulars of a fixation method which, in my opinion, excels that of fixing with Flemming's chromo-osmic-acetic mixture.

The formula* for the fixative (a modification of Bouin's) is as follows:—

Picric acid, saturated sol. in water	. 75 c.cm.
Formol 40 p.c.	. 25 „
Acetic acid glacial	. 5 „
Chromic acid	. 1.5 grms.
Urea	. 2.0 „

And should be used warm (38° C) in the case of tissues from warm-blooded animals, and cold, or at an ordinary room temperature, for cold-blooded animals such as the frog, etc., the time being regulated according to the size of the tissue. Roughly the rate of penetration at 38° C. upon an object, such as the testis of a rat, is about one-eighth inch per quarter hour, and when used cold, or at room temperature, slightly slower. Tissues usually float for some time, and complete penetration has not taken place until they sink.

When fixation is complete remove the objects and wash in repeated changes of 70 p.c. alcohol, until no further yellow coloration of the spirit (due to the picric acid) takes place. This usually takes a day or two. When ready transfer to methylated spirit full strength, and allow to remain for forty-eight hours. This completes the hardening process.

Graduate back to distilled water by stages such as 70 p.c.,

* R.M.S. Journal, June, 1917, page 347, under "Improved Technique for showing Details of Dividing Cells."

50 p.c., 30 p.c. alcohol, an hour or so in each grade, and place direct into carmalum for twelve, twenty-four, thirty-six hours, according to the size of the objects. Remove and wash in distilled water until no more colour comes away; graduate back to absolute alcohol, clear with cedar-oil and embed in paraffin. Cut sections, which should not be over 10 μ , and fix, by the water method, to the cover-glass; remove paraffin-wax by cedar-oil, wash away the oil by absolute alcohol, and, subsequently, in one or two changes of methylated spirit. Counter-stain, by immersion for a quarter of an hour, in a solution of Gruebler's light green in methylated spirit.

Light green	0.5 grms.
Methylated spirit	200 c.cm.

Wash out in one or two changes of methylated spirit, then absolute alcohol, cedar-wood oil, xylol, and, finally, mount in euparal, *not balsam* or other media.

One of the distinguishing features of this method is that the cytoplasm of dividing cells, or cells about to enter upon mitosis, is stained a deeper green tone than those not dividing. All nuclei and nuclear material are sharply contrasted from cytoplasm, not by grades of intermixed red and green, but by a complete distinction between the two colours. When differences are to be seen it is only to be observed in varying depths of one or the other stain.

Finally, on comparing a mounted section which has not been counter-stained with light green with another that has, it will be observed that the counter-staining has the effect of considerably intensifying the carmalum stain, and at the same time rendering it sharper and crisper in detail.

2. The second method is one which has been formulated for staining tissues in bulk with an iron preparation of hæmatoxylin. The formula for the preparation of the stain was given in the *Journal, Clinical Research*, May 1910, page 63; a short time after it appeared, by permission, in the *Journal of Micrology*. I have given this stain an extensive trial and am convinced of its value.

Fix and harden as already described. Place the pieces in a freshly-made mixture of the two following solutions:—

1. Hæmatoxylin	1 gm.
95 p.c. alcohol	100 c.cm.
2. Perchloride iron	2 „
Hydrochloric acid	1 „
4 p.c. aqueous solution copper acetate	1 „
Water	95 „

Transfer the material to the stain, and allow to remain for a somewhat longer period, say half as long again, than would be the case when carmalum is employed, for the reason that this stain is not so penetrating. Should the piece of tissue be large—that is,

about the size of the rat testis—thirty-six to forty-eight hours will be required. After staining, remove the piece of tissue to 50 p.c. alcohol, to wash out the excess of colour, grade down, and thoroughly wash out in running tap-water for a few hours, according to the size of tissue. This washing out in water is important, as greater clearness and density of the stain is obtained by this means. Within certain limits, say six to twenty-four hours, according to the size of the piece of tissue, the longer the washing the denser the stain.

After washing out in water, the pieces are up-graded to absolute alcohol, cleared with cedar-wood oil, embedded in paraffin-wax, and sections cut 10 μ . Sections are fixed to the cover-glass and treated *secundem artem*, then, if desired, counter-stained by immersion for about ten minutes in erythrosine, not eosin—

Erythrosine	1	gram.
Alcohol	40	c.cm.
Water	160	„

previously down-grading into alcohol equivalent in strength to that of the erythrosine stain; washed in 30 p.c. spirit and up-graded to absolute alcohol, cleared in cedar-wood oil, xylol, and mounted in balsam or euparal, perhaps preferably in the latter medium, as I am not yet in a position to say whether this stain will keep so well in the former, although I must admit that balsam gives the sharper image with this method of staining.

Centrosomes that are as a rule easily demonstrated by Heidenhain's method are equally so by this latter method of staining in bulk.

In many cases, counter-staining in bulk with light green, after previously staining in bulk with caralum or hæmatoxylin, can be carried out quite easily.

Light green does not overstain, and therefore needs no differentiation. All that is necessary after staining in bulk, as previously described, and washing out, is to up-grade into alcohol of 50 p.c., place the pieces of tissue direct into the alcoholic solution of light green for at least twenty-four hours, wash out in methylated spirit until no more colour comes from the tissues, dehydrate in absolute alcohol, pass through cedar-wood oil, embed in paraffin, cut sections, fix to cover-glass, dry, remove wax by cedar-oil, wash in xylol, and mount in euparal.

Some tissues, however, are of such density that the light green only penetrates a very short distance, and prolonged immersion does not succeed in remedying this defect.

In such cases, proceed to fix sections on the cover-glass, remove the wax, and down-grade to methylated spirit, immerse for about ten minutes in the alcoholic solution of light green, wash out in methylated spirit, dehydrate, clear, and mount in euparal; the

sections will then be found to be satisfactorily stained, although the extreme peripheral portion may be rather deeper in colour.

In conclusion, it is absolutely essential to use freshly-made solutions. Solutions of carmalum and hæmatoxylin do not keep longer than a month in the winter, and about half this time in the summer, and the rate and quality of penetration depreciates with the age of the solution.

Any appearance of precipitation or fungoid growth may be taken as a proof of deterioration. The hæmatoxylin solution keeps somewhat longer than the carmalum, and does not precipitate, even though kept for some length of time.

To obtain the maximum keeping capacity, make up all stains with distilled water that has been previously boiled and allowed to cool.

X.—*Acetone as a Solvent for Mounting Media.*

By JOHN RITCHIE, JUN.

(Read February 20, 1918.)

ACETONE has during the last few years been used as a reagent for the extraction of water from specimens about to be embedded in paraffin wax, owing to the property it possesses in being able to absorb water from formalin and alcohol, etc.

Hitherto I have found no record of its use as a solvent for Canada Balsam (or other gums, such as Copal, Dammar and Sandarac), but as I have been successful in obtaining good mounts in such a medium, a few notes as to the methods employed may be of interest.

Various Formulæ of Medium:—Place in a well-stoppered bottle (*a*) some Canada balsam in the resinous condition (select the lighter-coloured lumps), over this pour some acetone (commercial). At first the acetone acting on the balsam causes a precipitate of a white flaky character, but in a few hours the medium clears and is ready for use. This formula gives a slightly acid reaction to litmus, to avoid which (*b*) re-distilled acetone, free from acid, may be used; but I find that if the mounting process is carried out in an atmosphere impregnated with moisture, much care has to be taken to prevent the finished mount taking up and retaining moisture under the cover-glass. Under ordinary atmospheric conditions, however, it gives almost the same results as the (*a*) formula. (*c*) Another method is to add 2 or 3 drops of Bouin's Fluid (picric acid 50 c.cm., 40% formalin 18 c.cm., glacial acetic acid 2 c.cm.) to each ounce of acetone before pouring on the resin. This last medium is the most suitable for specimens which are not stained. (*d*) Other gums such as those previously mentioned may be employed and give almost similar results; but of course each gives a different refractive index. A recent slide mounted in the acetone-balsam shows a rather lower refractive index than does a slide mounted in xylol or benzole-balsam.

Two methods may be employed. A. In dealing with large specimens, take the object, either stained or unstained, from any of the grades of alcohol from 70% upwards and place in a bath of acetone, from this transfer the specimen to a glass slip, drop on it any of the above media, and adjust a cover-glass. Specimens which are rather too large to be mounted on slips can be put into small

museum jars or specimen tubes after having had a second bath of acetone; this latter is poured off and one or other of the above variations of the medium poured in. The specimen clears in a short time, and any air-bubbles left can be removed by the application of gentle heat, or, if very obstinate, by the use of an air pump. The acetone used for the baths need not be discarded, as the moisture can be removed by adding cupric sulphate, heated to white powder, and then filtering. This method may be used with advantage for specimens, such as mosquitoes, sent from abroad, which have been preserved in formalin or alcohol.

B. If one is dealing with small specimens or with wet or dry cover-glass preparations, these, after staining, are taken from any of the grades of alcohol between 75% and absolute, placed on a slip and covered with a cover-glass, filling up any space left with the grade of alcohol from which the specimen is taken; if desired a higher grade of alcohol or even acetone may be transferred between the cover and slip; then a drop of the selected medium, of such a consistency that it will run easily, is placed at one edge of the cover-slip, while, with a piece of bibulous paper the alcohol or acetone is drawn off at the opposite side, thus causing the medium to flow in until it entirely replaces the alcohol or acetone. Usually a milky cloudiness appears in the preparation if the medium is used to replace 75% alcohol or methylated spirits, but this disappears if the slide is gently warmed and the cover-glass quickly raised from its edge and lowered again. The best results are obtained when the specimen has had a bath of absolute alcohol or acetone just previous to the addition of the acetone balsam. Attempts to carry the specimen direct from water or 5% formalin through an acetone bath into the medium have so far met with no success; yet I believe that this may be possible if the absorbed water is extracted from the acetone by placing some desiccating agent, such as fired carbonate of potash (pearl-ash) or copper sulphate, in the bottom of the vessel containing the acetone bath.

As the medium penetrates the specimen, clearing simultaneously takes place, in a manner similar to that which occurs when a specimen is passed from alcohol through some of the essential oils. The mount will harden in a few hours as the acetone gradually evaporates, leaving the specimen embedded in a layer of Canada balsam or other gum. Several slides mounted in a Bouin's Fluid acetone-balsam medium have now been under observation for nine months. They show no tendency to deteriorate, but rather indicate the stability of the medium, there being no signs of precipitated deposit, no discoloration of the medium, nor uneven shrinkage of the specimen due to the drying of the balsam; in fact, any shrinkage which may occur is due rather, I think, to some fault in fixation.

Action on Stains.—The medium seems to have very little effect on borax or lithium carmine, or on acid stains such as Van Gieson's; or on hæmatoxylin, mordanted previously with a $\frac{1}{2}$ p.c. iron-alum solution, and reduced after staining in $\frac{1}{2}$ to 1 p.c. iron-alum solution; but I find that if hæmatoxylin is used as recommended by G. R. La Rue,* the blueing of the stain is affected, if the slide is heated, by again becoming reddish in colour, as if in an acid bath. In some ways, however, this is an advantage, as the heating of the preparation can be stopped at a time when some particular structure becomes prominent, giving a double-stain effect which is unaltered by the acetone-balsam, even after six months. I have also tested the action of the medium on blood-smears stained with Jenner, Giemsa, and Leishman (Soloid brands). The two former did not retain the stain for any length of time, but whether due to a faulty stain or the medium I cannot be sure; however, with Leishman's the staining was quite as brilliant in media (a) and (b) three months after as when first mounted. I also find that blood-smears and some of the sporozoa, such as *Myxobolus esmarkii* Woodcock,† which I have obtained frequently from the sclerotic coat in the eye of haddock (*Gadus aglefinus*), retain Ehrlich's triacid stain (Cabot's formula) when mounted in either of the variations (a) or (b).

Some Advantages of the Method:—

1. It clears specimens from various grades of alcohol direct without the use of essential oils.
2. It does not cause a precipitate or any uneven shrinkage on the tissues of specimens where these have been properly fixed.
3. It has the advantage that specimens may be oriented in any desired position under the cover-glass and kept there until the exchange to the mounting medium is completed.
4. Many variations are possible in the making-up and employment of medium without fundamental change in the result.

The work was carried out at my own house, but I have to express my indebtedness to Dr. James F. Gemmill, of the University, Glasgow, for advice and encouragement he has given me in the preparation of this paper, and also for placing at my disposal some re-distilled acetone free from acid, which otherwise I would

* "A Revision of the Cestode Family Proteocephalidae." Illinois Biological Monographs, i. (1914) pp. 15, 16.

† Considered by Dr. Jas. Johnstone, to whom I sent specimens, to be *Myxobolus esmarkii* Woodcock; and if so, now recorded for a new host, the previous Report being Johnstone's, from *Gadus esmarkii*, in Lancashire Sea Fisheries record for 1906.

have had some difficulty in obtaining for these experiments. He tells me that since then he has been using a fairly thick solution of balsam in this acetone for mounting films, serial sections, and small objects direct from absolute alcohol, exactly as one does ordinarily from xylol, and that he sent some of the medium for trial to various laboratories in Glasgow with, so far, satisfactory results.

XI.—*A New Type of Infusorian: Arachnidiopsis paradoxa.*

By E. PENARD, Sc.D.

(Read June 19, 1918.)

ONE PLATE.

THOUGH our title indicates a type of Infusorian yet unknown, it is quite probable that we owe to Saville Kent the first notice about the very interesting group of fresh-water Protozoa of which we are going to treat.

On page 637 of his "Manual of Infusoria," that author describes in the following terms the genus which he created for this small group:—

"*Arachnidium*, gen. nov. Animalcules free-swimming, ovate or spherical; oral aperture terminal, central, surrounded by a circular wreath of large, flexible, tentaculiform cilia, which constitute the only locomotive or prehensile organs; endoplast and contractile vesicle conspicuously developed. Inhabiting salt and fresh water.

"This new genus holds a position between *Mesodinium* and *Strombidium*, in having the central mouth and even oral circle of cilia characteristic of the former, but wanting, as with the latter, its special supplementary leaping setæ. This single oral wreath of cilia at the same time attains a much greater development, and assumes a character completely distinct from either of the above-named genera; these cilia, indeed, resemble rather small flexible tentacula than the ordinary cilia or setæ of the normal representatives of this group. In their more ordinary condition these organs are recurved gracefully towards the posterior extremity of the body, and when in active use exhibit a perfectly independent motion. The spider-like aspect of the animalcules of this genus, with their rounded bodies and straggling tentacle-like cilia, has suggested the title for their distinction. More correctly they may perhaps be likened to the free-swimming Cœlenterate genus *Arachnachtsis*."

Kent then describes in this genus *Arachnidium* two species: *A. globosum* (Pl. 32, figs. 48 and 49), which he found, in 1874, in a pond at Stoke Newington, represented by a few examples only; and *A. convolutum* (Pl. 32, fig. 41), a single specimen of which was met with at Bognor, on the Sussex coast, in September, 1872.

At the same time Kent refers to this new genus, as a third species,

Frommentel's *Halteria bipartita* ("Etude sur les Microzoaires," Paris, 1874), but he seems to be too generous with the French author's observations. Frommentel, in this latter work, describes no less than nine new species of *Halteria* (*bipartita*, *vorax*, *minima*, *viridis*, *verrucosa*, *vulvax*, *ovata*, *acuta*, *lobata*), but in a few lines only, and with such defective drawings that all these species are a puzzle, and might be reduced to one or two. As, however, all these species possess the wreath of leaping setæ characteristic of the genus *Halteria*, none of them can be possibly united to *Arachnidium*.

After the publication of Kent's important work, nobody, to my knowledge, met with an organism related to this group, though Bütschli has a few words about it.* As for Delage (Zoologie concrète), he simply indicates (in his "Index for Genera," p. 555) the genus *Arachnidium* as synonymous with *Mesodinium*, and nothing more. Thus Kent's observations seem to have been almost ignored, and these "cilia which resemble rather small flexible tentacula" appear not to have met with any serious consideration.

And yet Kent is possibly quite right. At all events, I am entitled to speak of an Infusorian whose locomotive organs are not cilia nor setæ, but flexible tentacula, and, if my observations necessitate at least the creation of a special genus, this genus would be very nearly related to *Arachnidium*.

The representative specimens of this new genus, "*Arachnidiosis*," were all found in the same station, Florissant near Geneva, in the property of my friend, the botanist H. Romieux. There can be seen a small pond, with gold-fish and aquatic plants, especially exotic *Nymphaea* and *Nuphar*, and it is under the water-lilies that, as far back as 1916, I found the first *Arachnidiosis*, a single specimen, unluckily, which, though examined at length, would not have allowed of any idea of publication; but on January 17 of this year (1918), a second specimen was found, and lastly, a third one on the 1st of March. Since that time, and in spite of frequent visits to this same locality, no further specimen has been obtained; but as the three specimens studied were observed at length and showed an absolute concordance in all their details, the facts are now sufficient to allow of a description of this very curious type.

Arachnidiosis paradoxa—such is the name which I apply to it—is a rather small Infusorian, 48 μ in length and about 40 μ in breadth, egg-shaped, roundish or very little compressed (elliptical) in its transverse section, but distinctly and broadly truncated at

* Page 1732 of his work on Protozoa (Bronn's Thierreich): "Zu *Strombidium* gehören wahrscheinlich auch *Arachnidium globosum* (Süsswasser) und *A. convolutum* (Meer) Kent's, welche beide auf Untersuchungen früherer Zeit (1872 und 74) basiren. Der unterscheidende charakter soll die tentakelförmige Füllung der adoralen Cilien sein, welche ich überhaupt bezweifle."

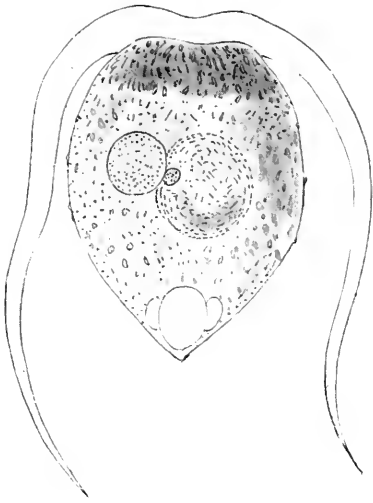

Fig. 1.

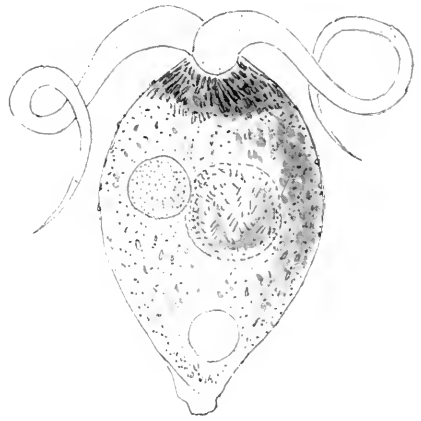

Fig. 2.



Fig. 3.

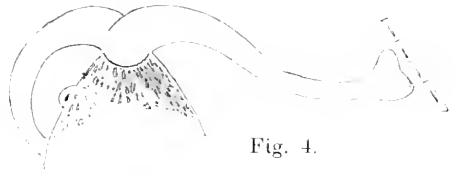

Fig. 4.



Fig. 5.

ARACHNIDIOPSIS PARADOXA Gen. et sp. nov.

its anterior part, and pointed posteriorly (fig. 1). Yet this pointed extremity may be wanting, according to the moment of the observation, to reappear a moment after; or, on the other hand, this posterior part may terminate in a kind of lobe or knob of transparent protoplasm, whose presence will be ephemeral also (fig. 2). In short, this posterior region is somewhat changing, amœboid, and at the same time somewhat glutinous. Very likely this terminal point is able to keep the animalcule in place, affixing it to some support, as I could on several occasions see it remain quiet, whilst the locomotory organs were vibrating actively.

Except this particular region, the body is hardly deformable, and keeps indefinitely its ovoid shape, in spite of the fact that the animal seems to be naked, without any indication of a cuticle; should this latter exist, it would at any rate not be more than a very thin film.

There are no traces of striæ, nor of cilia. However, the surface of the body cannot be called absolutely smooth; it shows rather a rough appearance, and seems to be covered with very fine scattered asperities; and I could satisfy myself that these appearances are in fact due to very fine rod-like particles, which are located under the superficial film and press it out somewhat.

The possession of these particles, in fact, is one of the characteristics of the cytoplasm in our *Arachnidiopsis*; they are disseminated everywhere in the body, very fine as a rule, and mixed with small round granules. At the anterior part of the body these particles are much more densely accumulated, forming there a blackish zone, and showing in their mutual arrangement a vaguely radiating disposition around a clear and central surface which might be taken for the oral aperture, but, as we shall see later, is something different in reality (fig. 3).

Inside the cytoplasm one can also detect the presence—very likely quite normal, as it could be verified in all the specimens observed—of a big spherical body, which at first sight might be regarded as a nucleus, but which in fact is nothing else than an accumulation of these small rod-like particles, united together into a mucilaginous pellet.

In short, all these small rod-like bodies may be considered as very finely divided food-particles, and nothing prevents us surmising that the big spherical bodies themselves are nothing but an accumulation of useless refuse, which will be later eliminated.

The contractile vesicle, rather large and active, is at the posterior extremity. Sometimes, when in the state of maximal expansion, it is seen to project beyond the surface of the body; after the systole, it forms itself again with the help of several lateral vesicles which open in the central one.

The nucleus, about the middle of the body and somewhat laterally located, is spherical, relatively small, uniformly covered

with small punctuations; a typical Infusorian nucleus, but near which I could not ascertain the presence of a micronucleus. In one of the individuals, however, I thought I could distinctly see it, and in fig. 1 this micronucleus has been represented; but this small spherical body, which I could not detect in either of the other specimens, may not be necessarily a micronucleus. All the individuals, in fact, treated with carmine after sufficient observation *in vivo*, coloured rather intensively in their entire mass, and if the nucleus itself was very distinctly delineated and easy to recognize as such, the small roundish body which was seen close by in one of the specimens might have simply been one of several other small red bodies without any particular significance, disseminated in the cytoplasm.

Up to this, *Arachnidiopsis paradoxa* does not present any particular features which might distinguish it from other Infusoria; but we must now speak of the locomotive or vibrating organs, which are here absolutely different from anything we know. In fact, we have here, not cilia nor cirrhi nor undulating membranes or lamellæ, but tubes, or what we might call genuine tentacula. Of these there are two, both of which start from a common basis, from a broad fissure-like opening at the anterior part of the body, rounded at both ends and somewhat constricted in the middle (fig. 3). This opening—if we may apply that term to it, for it has surely no real analogy with a “mouth”—is filled with a clear substance which projects outside like a cushion; and from it diverge in opposite directions two “tentacles,” transparent, very pure and opalescent in appearance, rounded or perhaps slightly elliptical in transverse section, broad at the base and gradually tapering to a pointed extremity. They are very long, and when in a state of repose are seen to be trailing to half the distance behind the posterior extremity of the animalcule, left and right of what might be called either the dorsal or ventral face of the body. Fig. 1 shows this particular disposition of the tentacles, with their common cushion-like basis; in fig. 2, where the animalcule is supposed to be seen from what one might call the side, with an orientation at an angle of 90° to the first, the enveloping pellicle or film—if there is one at all—is seen to be somewhat excavated at the root of the tentacles.

The tentacles, however, are rarely seen as fig. 1 represents them—i.e. in the state of rest. The intervals of rest last only for a very short time, a few seconds at most; then the tentacles lift up, develop a graceful curve, somewhat like that of the horns of a ram (fig. 3, where the animalcule is seen from above, along the longitudinal axis of the body), describing a spiral downwards; and both horns begin vibrating, beating the water with such a rapidity that the shape of the horns disappears from sight to give the impression of a whirling body.

What, now, is the structure of the motile appendages? According to my observations they are tubes, filled with a clear and pure liquid, very likely with water. Such is, at any rate, the appearance on the living animal; and the action of reagents goes to prove their tubular nature. All the three individuals, after observation from life, were submitted to the action of carmine mixed with glycerin, and in all the effect of glycerin, if somewhat different according to the greater or less concentration of the reagent, was such as to show the tubular nature of the tentacles. In the first specimen one of the tentacles suddenly contracted from its extremity to its base, leaving in sight merely a rounded stump; the other kept its length and shape, but flattened ribbon-like, as if having suddenly sent back to the body the internal liquid. In the second case (fig. 5) both tentacles contracted at the same time, to leave only sack-like expansions. In the third specimen both tentacles grew thin and varicose at the end.

We may cite another fact which might throw some light on the intimate structure of the tubular wall. In a great number of Infusoria it is often difficult to distinguish the striation of the body, the appearance delineated by the ciliary lines on the cuticular surface. Now, it becomes easy in nearly all cases to produce this striated appearance by submitting the animalcule to a slight current of dilute glycerin. This, whilst contracting the pellicle by the rapid removal of its water, provokes shrinkings which follow the ciliary lines, and, for a few minutes at any rate, the characteristic striation very clearly appears. The tentacles of *Arachnidiopsis* as already mentioned above, look quite smooth in life, without any visible indication of longitudinal striae, such as might result, for instance, of cilia fused together, nor, if these tentacles are submitted to this glycerin reaction, is there any appearance of pattern or lines.

But at the same time these tubular tentacles may be, in certain special cases, for a time extremely plastic, as the following observations will show: On one of the observed individuals, which did not move from its place in spite of the vigorous beating of its tentacles, one of these tentacles suddenly straightened, came to rest, and its pointed extremity developed into a large lobe (fig. 4); this lobe then began lightly to "taste," or "feel," some green alga which was near, and I was beginning to think of a state of disease or rapid disintegration of the animalcule, when the tentacle, leaving the alga, recovered its pointed form and its normal shape, and began to vibrate again, the animalcule remaining for an indefinite time in good health and activity. The whole process may have lasted two or three seconds.

So much for the vibratory and at the same time locomotory (as to which I could satisfy myself, but unluckily without adequate observations) organs of this curious Infusorian. But now I should

like to consider the mouth, or rather to discuss the question of its existence at all. S. Kent, in his *Arachnidium*, indicates: "oral aperture terminal, central"; but it is quite possible, if at least Kent's *Arachnidium* really belongs to the same group as *Arachnidiopsis*, that the author might have taken for an oral aperture what was simply a rounded space encircled with a wreath of tentacles. In our *Arachnidiopsis* the first impression is that of an aperture, even very distinct and sharp (figs. 2, 3); but on better examination one must arrive at quite another conclusion: this fissure-like, or 8-shaped, appearance as shown on the animal seen from above (fig. 3), or this excavation as in fig. 2, is certainly nothing but the base of the tentacles. A real mouth does not seem to exist; at any rate, I never found any indication of it.

But then, how does the animal take its food? It is surely an Infusorian, perfect and complete, with its nucleus and contractile vesicle, and with food-particles everywhere disseminated in the body.

Unluckily, this question must remain unanswered; all my searches ended in the total acquisition of three specimens, and none of them was seen capturing food. But if my ignorance has remained complete on this point, yet I may be allowed to indicate, as a simple but perhaps not very improbable hypothesis, some suppositions which real facts induce me to entertain. These facts are the following:—

1. The animal is, or seems to be, naked; perhaps with a mere hardening of its ectoplasm into a fine pellicle.

2. The posterior extremity of the body certainly shows a certain degree of viscosity, and at the same time is capable of deformation, emitting at times a small lobe or knob which might recall what we see, for instance, in some *Amœbæ*.

3. In fig. 4 one can see, at the left and just under the basis of one of the tentacles, a very small knob or prominence, and within one small black particle. Now, this prominence was to be seen on the living animal as a small knob of clear protoplasm with a brownish granule.

Might we not be entitled, then, to suppose the capture of food in the form of small particles coming from outside, perhaps thrown against the viscous surface of the body by the movements of the tentacular organs, and then drawn inside the cytoplasm?

This, of course, is pure supposition, but in the absence of any indication of an oral aperture any hypothesis may be put forward, provided it is given as such.

A few words more about the position which must be assigned to *Arachnidiopsis*, as well perhaps as to *Arachnidium*, in the classification of lower organisms.

The class *Infusoria* is generally considered as comprising two

orders; * the *Ciliata* because they possess cilia, the *Tentaculifera* because in their adult state they possess Tentacula. Now we have here, in *Arachnidiopsis* or *Arachnidium*, neither cilia nor tentacles (this term being considered in the sense of Tentacula as applied to *Acincta*). It will, then, be hardly possible to refer our small group to either of these two orders; but our knowledge about these organisms is still too incomplete to allow of the creation of a special order, and it is to be hoped that more representatives of this rare and interesting type will be found in sufficient quantities to allow of a more adequate study.

Since the above was written the organism described has been met with in a new station, and, although not in abundance, in sufficient numbers to allow of definite conclusions about some points previously obscure or doubtful, e.g. :—

(a) There is *no* micronucleus.

(b) The large spheroidal body is not covered or composed of the same rod-like particles as are to be seen at the anterior part of the animal, but is formed by Bacteria, such as are to be found in *Pelomyxa*, collected at the surface of, and partly inside a mucilaginous pellet.

(c) Food has been repeatedly found in the body in the shape of small algæ, etc., which are digested in the ordinary way, and whose remains may be expelled by the opening of the body near the posterior extremity.

* In his "Faune infusorienne des environs de Genève" (Mém. Instit. Nation. Genevois, xix. 1901) Roux created a third order, that of the *Mastigotricha*, for a single species, *Monomastix ciliatus*, which, along with a complete ciliation of the surface of the body, is in possession of a long, anterior flagellum. But having found more recently this *Monomastix* in this neighbourhood, I came to the conclusion that Roux's *Monomastix* is in fact a *Trachelophyllum*, a genuine holotrichous Infusorian, in which this sort of beak, which is characteristic of some species of that genus, is protracted into a very long thread; this thread then curves behind, and floats along one of the sides of the body, undulating weakly at times under the influence of the currents produced by the cilia. It is also, I think, quite in the vicinity of *Trachelophyllum* that we must locate Stokes' *Ilecnema dispar* (Silliman's Amer. Journ., xxviii, 1884), an Infusorian also very nearly related to *Monomastix*.

SUMMARY OF CURRENT RESEARCHES
RELATING TO
ZOOLOGY AND BOTANY
(PRINCIPALLY INVERTEBRATA AND CRYPTOGAMIA),
MICROSCOPY, ETC.*

ZOOLOGY.

VERTEBRATA.

a. Embryology, Evolution, Development, Reproduction,
and Allied Subjects.

Further Experiments on Sex of Frogs developed from Artificially Activated Eggs.—JACQUES LOEB (*Proc. Nat. Acad. Sci.*, 1918, 4, 60-62) has succeeded in rearing twenty leopard frogs produced by the methods of artificial parthenogenesis from unfertilized eggs. Some reached the age of ten to eighteen months, and nine were alive when the paper was published (March 1918). Some have reached the size of the full-grown normal adult male. Both sexes are represented; seven of the nine older whose gonads were examined were males, and two were females. The males possess the diploid number (26) of chromosomes. It is not known whether the female or the male is homozygous for sex in the frog. J. A. T.

Zona Pellucida in Turtle Eggs.—ALICE THING (*Amer. Journ. Anat.*, 1918, 23, 237-57, 12 figs.) finds that the epithelium surrounding the ovarian egg of various turtles is represented by one layer of prismatic cells between the sides of which bridges extend. The intercellular spaces at the surface of these cells are closed by a special cement, the terminal bars. The *zona pellucida* varies from 1 μ to 17 μ according to the stage of development. During its growth it is always formed by two or three different elements; there is a fundamental homogeneous substance filling up the spaces between a system of numerous canals or tubules which enclose filaments or prolongations of the epithelial cells which are connected with the surface of the yolk. The fundamental substance is developed as a cuticular element from the terminal bars or intercellular cement. A secondary network is produced by the superficial

* The Society does not hold itself responsible for the views of the authors of the papers abstracted. The object of this part of the Journal is to present a summary of the papers *as actually published*, and to describe and illustrate Instruments, Apparatus, etc., which are either new or have not been previously described in this country.

cytoplasm of the epithelial cells, and it gives rise at its surface to a cement similar to that produced by the terminal bars. The structure of the *zona pellucida* is favourable for the conveyance of nutritive materials from the maternal capillaries to the growing yolk. J. A. T.

Eggs and Embryos of *Bdellostoma*.—J. D. F. GILCHRIST (*Quart. Journ. Micr. Sci.*, 1918, **63**, 141–59, 2 pls.) describes the naturally deposited eggs of the South African Myxinoid, *Bdellostoma (Heplatretus) hexatrema*, two of which contained well-advanced embryos. There are numerous small projections on the surface of the shell, consisting of the columns of the columnar layer modified at the apex. There are numerous small fissures, probably respiratory apertures. The two polar rings show the inner layer of the shell much enlarged, the outer much reduced. The anchor filaments consist of all the layers of the shell, the heads of the columns of the columnar layer being drawn out so as to appear as striations. The anchors consist of the modified columnar layer and the stratified layer. The segmental duct of the embryo occurs at the distal end of the last tubule of the pronephros, but does not open into it. It is found also at the distal end of the last tubule but one, where, however, it becomes solid and disappears. The tubules of the mesonephros are not strictly segmentally arranged, in that there are six tubules in three segments of the body behind the pronephros, though there is one tubule for each succeeding segment, as far as the mesonephros extends. J. A. T.

Development of Head-segments of Dogfish.—EDWIN S. GOODRICH (*Quart. Journ. Micr. Sci.*, 1918, **63**, 1–30, 2 pls., 1 fig.) has studied the segmentation of the head in *Scyllium canicula*. There are three pro-otic segments, corresponding to the profundus, trigeminal, and facial nerves. Somite 1 is pre-oral; somite 2 lies above the mouth, and is related to the mandibular bar. Somites 3 to 8 lie above each of the six gill-slits, and are related to the hyoid and five branchial bars. The three pro-otic somites are supplied by the oculomotor, trochlear, and abducens. The first meta-otic segment, with the glossopharyngeal root, contains somite 4, which produces no myotome and has no ventral root. Three more meta-otic somites, supplied by the occipital ventral roots, and corresponding to the first three branchial branches of the vagus, complete the cranial region. The eighth somite belongs to the first spinal nerve, of which the dorsal root is absent or vestigial in later stages, and to the fourth branch of the vagus. The author deals also with the vagus and with the development of the chondrocranium. J. A. T.

Earliest Movements of Dogfish Embryo.—P. WINTREBERT (*Bull. Soc. Zool. France*, 1918, **43**, 42–4) describes in the embryo of *Scyllium canicula* the early automatic movements of the myotomes. They are at first independently unilateral, and they are independent of the nervous system. The excised myotomic chain, after entire removal of the nervous system, retains its power of automatic contraction. J. A. T.

Morphogenesis of Duplicities.—E. I. WERBER (*Journ. Exper. Zool.*, 1917, **24**, 409–43, 27 figs.) has experimented with the eggs of the

"minnow," *Fundulus heteroclitus*, and finds that a percentage of duplicities can be produced by adding to the sea-water (50 c.cm.) a varied quantity (30-40 c.cm.) of a Gram-molecular solution (in distilled water) of acetone. In some cases butyric acid was used. The duplicities seem to be due in part to lowering of the osmotic pressure of the medium surrounding the eggs. This induces osmotic blastolysis of the embryonic primordium in the more susceptible eggs. A second factor of blastolysis—namely, chemical alteration—is also inferred. The age of the egg, counting from the time of maturation, probably plays a contributory part, the younger eggs being less susceptible. J. A. T.

Development of Mammalian Notochord.—G. CARL HUBER (*Anat. Record*, 1918, 14, 217-64, 14 figs.) has studied this in the guinea-pig in particular, and finds that the endoderm takes no active part in the histogenesis of the head process, chordal canal, and chordal plate, and that the latter becomes only partially and temporarily incorporated in the endoderm. Therefore there seems no justification for classing the chorda dorsalis as an endodermic derivative. Since the head process—the primordium of the chordal canal and derived structures—has its primordium in turn in the cranial portion of the primitive node, a region of active ectodermic cell proliferation, and since the chordal canal and plate retain their continuity with the primitive node, which serves as a growth zone, there seems justification in regarding head process—chordal canal and derived structures, chordal plate and chorda dorsalis—as a derivative of the ectoderm in the sense that the mesoderm is derived from the ectoderm of the primitive streak region of the embryonic shield. J. A. T.

Hermaphrodite Fowls.—ALICE M. BORING and RAYMOND PEARL (*Journ. Exper. Zool.*, 1918, 25, 1-47, 9 pls., 9 figs.) describe eight cases—females with embryonic or degenerating ovaries. Three were changing to a male condition in respect to gonads, external characters, and sex behaviour. There is no structural counterpart for the abnormal behaviour of one hen treading another hen. Two guinea-chicken hybrids had testes composed of undifferentiated tissue. Development of comb, spurs and wattles does not stand in direct quantitative relation to the sex of the gonad. Body shape and carriage have a general relation to the sex of the gonad. The interstitial cells in the abnormal fowls dealt with had no causal relation to the secondary sex characters. The amount of luteal cells or pigment is in precise correlation with the degree of external somatic femaleness exhibited by the individual. J. A. T.

Ultimobranchial Bodies in Pig.—J. A. BADERTSCHER (*Amer. Journ. Anat.*, 1918, 23, 89-131, 4 pls.) finds that these bodies participate in the formation of thyroid follicles, though the portion of the gland in full-term embryos that is derived from them is small in comparison with that derived from the median thyroid primordium. The time of the transformation of the ultimobranchial bodies into typical thyroid structures varies greatly. So does the degree of their transformation. They usually become entirely embedded in the thyroid gland. J. A. T.

Development of Blood-vessels without Heart.—W. B. CHAPMAN (*Amer. Journ. Anat.*, 1918, 23, 175-203, 17 figs.) finds that in chick embryos from which the heart has been removed before the establishment of the circulation, the embryo and area vasculosa remain alive for seven or eight days. There is some growth, and the development of blood-vessels in the area vasculosa is not entirely inhibited. It seems that certain large vessels, such as the sinus terminalis and the anterior vitelline veins, develop as a result of hereditary factors; self-differentiation of the vascular system is very limited; and the working out of most of the arteries and veins is dependent upon the mechanical factors concerned with the circulation of the blood. J. A. T.

Vestigial Gill-filaments in Sauropsida.—EDWARD A. BOYDEN (*Amer. Journ. Anat.*, 1918, 23, 205-35, 4 pls., 3 figs.) calls attention to the formation and relatively late persistence of a band of tissue across the ventral surface of the neck, which is derived from the ventral union of the hyoid arches. From its resemblance to the development of the gill-cover of certain fishes and amphibians it may be called the opercular fold or plica opercularis. On the lateral margins of this operculum, after it has grown backward to enclose at least a potential peribranchial chamber, filamentous outgrowths may be observed on the under side, which in reptiles have a very transitory existence, but in the chick undergo a relatively extensive and prolonged development. On account of the filamentous character of these out-growths, their origin from the branchial arches (the epithelium of which Ekman has shown to possess a certain specificity for gill-formation in the Anura), and their constant relation to the operculum in both reptiles and birds, these structures are adjudged to be true gill-filaments, evidently vestigial in character, but none the less comparable in kind to the functional organs of water-breathing Anæmia. J. A. T.

Cyclic Variations in Permeability of the Activated Ovum.—MAURICE HERLANT (*C.R. Soc. Biol. Paris*, 1918, 81, 151-5) has studied the period of apparent repose between fertilization or activation and cleavage. It is marked in the fertilized egg by the development and regression of the "male" aster and the formation of a bipolar spindle; in the artificially activated egg by the parallel development of the female aster in the frog, by variations in the volume of the nucleus in the sea-urchin. These are cyclical phenomena, and so are changes in physiological reaction—e.g. susceptibility to various solutions. As R. S. Lillie has suggested, the cyclical changes correspond to changes in the permeability of the cytoplasmic membrane (peripheral zone of protoplasm, not to be confused with the vitelline membrane). Herlant's experiments confirm this view. J. A. T.

Corpus luteum in Ovary of Chicken.—RAYMOND PEARL and ALICE M. BORING (*Amer. Journ. Anat.*, 1918, 23, 1-35, 9 pls., 6 figs.) demonstrate the homology of the corpus luteum in the hen and the cow. The course of its development in the hen is an abbreviation or fore-shortening of that in the cow. It corresponds directly to the late involution stages of the cow corpus luteum. Both contain a yellow

fatty substance, as shown by the Sudan III, absolute alcohol and xylo reactions. In both there develops in the cells a yellow amorphous pigment containing the fatty substance. In the hen a corpus luteum forms in both discharged and atretic follicles. Its origin is definitely from the theca interna.
J. A. T.

Chondriosomes in Testis-cells of Fundulus.—G. DUESBERG (*Amer. Journ. Anat.*, 1918, **23**, 133-53, 2 pls.) has traced the behaviour of very distinct chondriosomes in the testis-cells of this Teleost. It is very probable that, owing to their close contact with the nucleus, they are carried into the egg at the time of fertilization.
J. A. T.

Growth of Mice.—HELEN B. THOMPSON and LAFAYETTE B. MENDEL (*Amer. Journ. Physiol.*, 1918, **45**, pp. 431-60, 10 figs.) find that up to the twenty-sixth day of life in the albino mouse the actual gain per day is approximately the same for the two sexes. After the twenty-sixth day the males continue to grow with comparative rapidity until about the fortieth day, whereupon the slower, gradually diminishing rate of increment ensues. The females gain from the twenty-sixth day at the rate of 0.5 gm. per day until the thirty-fourth day, when their curve flattens perceptibly. The resumption of growth after suppression of growth is followed by a greatly accelerated rate. The acceleration is ordinarily accomplished on a smaller intake of food than is ingested during a period of equal growth at the normal rate from the same initial body-weight.
J. A. T.

Growth of Blood-vessels in Frog Larvæ.—ELIOT R. CLARK (*Amer. Journ. Anat.*, 1918, **23**, 37-88, 16 figs.) finds that an extensive vascular development takes place in early embryonic stages which is independent of the mechanical factors concerned with the circulation of the blood and the interchange of substances through the endothelial wall. The extension of the blood-vascular system takes place by sprouting and by the formation of anastomoses between sprouts, and the early steps are due to hereditary inertia. This stage, however, comes to an end relatively early; and the vascular system, for its further development into the complicated and nicely balanced system of the adult animal, comes to be dependent upon the mechanical factors concerned with the pull and push of outside tissues, with blood-pressure and blood-circulation, and with the interchange of substances through the wall.
J. A. T.

Inheritance of Coat-colour in Cats.—P. W. WHITING (*Journ. Exper. Zool.*, 1918, **25**, 539-69, 2 pls.) has made an experimental study. Maltese dilution segregates distinctly from intense colour, and is probably recessive. Solid white is a simple and complete dominant over colours. White spotting is very irregular in inheritance. There is a partial correlation between dominant white, blue eyes, and deafness. Yellow is determined by a sex-linked factorial difference from other colours. Kittens resembling adult Siamese cats have been produced from common cats. Banding cleanly segregates in three different widths. Much-ticking, little-ticking, and black probably constitute a triple allelo-

morphic series. Intergrades occur between much-ticking and little-ticking. Black spotting is explained by crossing of transverse and longitudinal bars.
J. A. T.

Development of Shoulder-girdle and Fore-limb in *Amblystoma punctatum*.—S. R. DETWILER (*Journ. Exper. Zool.*, 1918, **25**, 499–537, 33 figs.) finds that the separate parts of the shoulder-girdle rudiment are already determined at the stage when the limb rudiment is present as a definite thickening of the somatopleure. The removal of a definite portion brings about a definite defect in the girdle. Transplantation experiments show that the girdle system is not equipotential. The limb mesoderm is already determined in embryos in the stage of open medullary folds. The rudiment can be successfully extirpated and transplanted at this stage.
J. A. T.

Development of Fore-limb of *Amblystoma punctatum*.—ROSS G. HARRISON (*Journ. Exper. Zool.*, 1918, **25**, 413–61, 45 figs.) finds that the fore-limb arises from a group of mesoderm cells formed as a proliferation of the somatopleure. It is a self-differentiating system. No specific stimulus from any particular part of the ectoderm is necessary for its development. The rudiment is not to be regarded as a definitely circumscribed area, like a stone in a mosaic, but as a centre of differentiation in which the intensity gradually diminishes centrifugally. It is an equipotential system, for Harrison's experiments show that a whole will develop from a part, and a single normal whole will develop out of two separate rudiments fused together. "The limb rudiment, therefore, is an entity, which, except for its dependence for nourishment, is independent of its surroundings in the attainment of its specific form."
J. A. T.

Regeneration after Exarticulation in *Diemyctylus viridescens*.—C. V. MORRILL (*Journ. Exper. Zool.*, 1918, **25**, 107–33, 3 pls.) has experimented with this American salamander, and finds that regeneration takes place readily after complete extirpation at hip, knee, or ankle joint. The new skeletal elements are like the old. The new cartilage appears independently (1) around the shaft of the bone proximal to the epiphysis (and this peripheral cartilage is of periosteal origin); (2) in the axis of the bone and in contact with the marrow subsequent to detachment of the epiphysis (and this axial cartilage arises from cells of the old epiphyseal cartilage and from the endosteal lining of the marrow cavity); and (3) in the tissue of the bud distal to the epiphysis (and this embryonal cartilage arises from de-differentiation leading to a substratum of indifferent cells). The removal of single bones was studied.
J. A. T.

Effect of Starvation on Tadpoles.—W. W. SWINGLE (*Journ. Exper. Zool.*, 1918, **24**, 545–65, 14 figs.) finds that total starvation inhibits indefinitely the growth and metamorphosis of larval frogs. It prevents the development of the germ-glands and delays any increase in the

number of germ-cells, interstitial cells and other tissue elements in the gonads. Starvation greatly retards the normal cycle of development of the germ-cells, and prevents the onset of sexual differentiation.

J. A. T.

Thyroid-feeding of Tadpoles.—W. W. SWINGLE (*Journ. Exper. Zool.*, 1918, **24**, 521-43, 14 figs.) finds that by feeding thyroid extract to frog larvæ great bodily changes are brought about within a very few days; entire organs and systems are transformed with startling rapidity from the larval condition to that characteristic of the adult. Yet in the midst of such somatic transformations the gonads and germ-cells remain unaffected. In a state of nature it requires two seasons, and sometimes three, for the larvæ of *Rana catesbiana* to reach the adult condition. It is possible by judicious thyroid feeding to bring about almost complete metamorphosis within a period of three weeks in the immature larvæ of this species of frog. The animals have all the body characteristics of the metamorphosed frog, yet the germ-cells and germ-glands are those of young larvæ.

J. A. T.

Removal of Thyroid from Tadpoles.—BENNET M. ALLEN (*Journ. Exper. Zool.*, 1918, **24**, 499-519, 1 pl., 8 figs.) finds that absence of the thyroid gland in the tadpoles of *Rana pipiens* does not affect the course of early development up to the time when the hind limbs have begun to grow. Further differentiation of the soma—form of body, limbs, gut, brain, etc.—ceases, and metamorphosis does not occur. Thyroid administration to thyroidless tadpoles brought about a resumption of development even four months after it had ceased. The removal of the thyroid does not affect gonads and germ-cells.

J. A. T.

Effect on Ossification in Tadpoles of Extirpating Thyroid.—GEORGE S. TERRY (*Journ. Exper. Zool.*, 1918, **24**, 567-87, 2 pls., 2 figs.) experimented with tadpoles of *Rana pipiens* and found that the vertebrae of thyroidless tadpoles continue to grow long after the normal time; that they retain primitive characters, e.g. in having little in the way of spinous process; and that they show almost no trace of ossification. The removal of the thyroid greatly retarded, if it did not completely stop, both ossification and growth in the bones of the hind leg. Calcification of the cartilage is proceeded with, but there is extreme retardation in the process of ossification.

J. A. T.

Effect of Thyroid Extirpation on Thymus and Pituitary Glands.—JAMES B. ROGERS (*Journ. Exper. Zool.*, 1918, **24**, 589-605, 1 pl., 2 charts) has experimented with tadpoles of *Rana pipiens*, and finds that the pituitary and thymus glands continue to develop when the thyroid gland is extirpated. The pituitary gland may be larger than in the controls. The young sexually mature frogs have smaller thymus glands than thyroidless tadpoles of the same age. The thymus glands of thyroidless tadpoles do not migrate to the position occupied in adult frogs, and do not degenerate like those of normal frogs.

J. A. T.

Influence of Thymus-feeding.—EDUARD UHLENHUTH (*Journ. Exper. Zool.*, 1918, **25**, 135-55) has experimented with larvæ of *Amblystoma*,

and finds that the thymus diet accelerates development up to the stage when worm-fed larvæ go into metamorphosis. At that point development of most organs seems to stop, and disturbances often fatal ensue. There is apparently the suppression of some factor, without which further development is impossible. Severe tetany occurs. The acceleration of early growth and development seems to be the effect of quantitative conditions, and not the result of a specific quality of the thymus, such as a specific growth-stimulating agent. The thymus gland apparently contains all the nutriment necessary to build up an amphibian organism, for specimens of *Amblystoma punctatum*, kept at low temperature, were reared on thymus diet from the fourteenth day to the fourteenth month.

J. A. T.

Effects of Underfeeding Young Albino Rats.—CHESTER A. STEWART (*Journ. Exper. Zool.*, 1918, **25**, 301-353, 1 fig.) removed newborn rats from the mother for nearly one-half of the total time for the usual three weeks of nursing. Great retardation of growth resulted. There is a progressive tendency in the skeleton and (to a slight extent) in the musculature to increase in weight, counterbalanced by a decrease in the integument and viscera. There is great diversity as regards the individual organs, and in regard to this detailed measurements are submitted.

J. A. T.

Grafts in *Amblystoma*.—E. UHLENHUTH (*Journ. Exper. Zool.*, 1917, **24**, 237-301, 5 pls., 3 figs.), working with larvæ of *A. punctatum*, grafted the two halves of the skin of the head, including an eye, on to two other larvæ. The skin grafts developed the network and the yellow spots, not simultaneously with each other, but simultaneously with their hosts. They metamorphosed only if the host did. Skin from *A. punctatum*, grafted on to *A. tigrinum*, metamorphosed there, and in the same time-relation as on a host of the same species. It seems that the development of the yellow spots of *A. punctatum* depends on two factors. One factor is responsible for the kind of yellow spots that will develop, and is contained in the skin itself. The other factor, which may be called the "metamorphosis factor," is necessary to start the development of the yellow spots, i.e. the metamorphosis of the skin; it is not contained in the skin; it is produced by the body or some particular organ; it is non-specific; it may be identified with an agent like thyroid-substance.

J. A. T.

Sexual Activity of Male Rabbit in Relation to Progeny.—FRANK A. HAYS (*Journ. Exper. Zool.*, 1918, **25**, 571-613, 22 charts) finds no inferiority in body-weights of offspring from heavy service groups, nor in body growth, nor in vigour. Heavy service of males gives a perceptible decrease in the proportion of male to female offspring. Female offspring are, to some degree, more likely to succumb than male offspring in all service groups, except the twentieth. The high percentage of deaths of female progeny is largely due to the predominance of females to males in the litters. "By no means thus far used has any inferiority of progeny from heavy sexual service been discovered.

They are fully equal, if not superior to, progeny from very light service of male." In short the fitness of the heavy service male's germ-cells is not lessened as regards inheritance.

J. A. T.

Sexual Activity of Male Rabbit.—ORREN LLOYD-JONES and F. A. HAYS (*Journ. Exper. Zool.*, 1918, **25**, 463-97) have investigated the results of excessive sexual activity on the properties (number of sperms, motility, duration of motion, certainty of pregnancy, etc.) of the seminal discharge. Excessive sexual service—e.g. twenty services in about three hours—causes decrease in amount of ejaculated semen, decrease in number of sperm-cells per cubic millimetre, decrease in the proportion of sperms that show progressive motion, decrease in duration of motion, and decrease in the percentages of pregnancies induced by the copulations. In extreme cases—e.g. of over fifteen services in a short time—there was a notable increase in the percentage of small litters.

J. A. T.

b. Histology.

Shape of Mammalian Red Blood-corpuscule.—LESLIE B. AREY (*Anat. Record.*, 1918, **14**, 135-9) has studied the wing of the living bat, and is convinced that the mammalian erythroplastid is correctly described as a biconcave disc. He eliminated the deceptive simulations of cups afforded by corpuscles viewed obliquely on the flat. Many corpuscles were seen which appeared as veritable cups until rotation presented an edge view. The excavated faces seemed to be especially deep.

J. A. T.

Lobules of Pig's Liver.—FRANKLIN P. JOHNSON (*Amer. Journ. Anat.*, 1918, **23**, 273-83, 2 pls.) has studied the "hepatic lobules," which physiologically and morphologically are the true units of the liver. The smallest may be no larger than 0.5 mm. in diameter; the largest may be 2 mm. or more. The average weight of a lobule is 2.41 milligrams; the average number in nine livers was 702,000.

J. A. T.

Melanophores of Lizards.—E. S. RUTH and R. B. GIBSON (*Philippine Journ. Sci.*, 1917, **12**, 181-8, 2 pls.) have studied the melanophores of Philippine house-lizards (*Cosmibotus platurus*, *Peropus mutilatus*, *Hemidactylus frenatus*, and *H. luzonensis*), and find that they are definitely fixed stellate cells, neither contracting nor expanding, with the pseudopodia remaining *in situ* during the fading and repigmentation. No migration of pigmented or colourless granules was observed in the cell. The pigment is dispersed and disappears both *in vitro* and *in vivo*, leaving colourless granules. This is seen also in lizards bleached in white surroundings. In life the disappearance of the pigment is probably due to the stimulation of the melanophore by a hormone, probably adrenin.

J. A. T.

Branchial Epithelium of Ammocœtes.—IVAN E. WALLIN (*Anat. Record.*, 1918, **14**, 205-15, 2 pls.) finds evidence that the branchial epithelium of the advanced lamprey larva is a compound tissue composed of endoderm and mesenchyme. The same mingling is seen in localized areas in the development of the thymus in higher animals;

the mingling now described occurs throughout the general branchial epithelium. In the lamprey there is a normal mingling of endoderm and mesenchyme in forming the thymus, but the cells of the greater portion of the mixed tissue are transformed into leucocytes, indicating the histogenetic relationship of lymphocyte formation (and probably erythrocyte formation) to thymus formation in this primitive animal. J. A. T.

Minute Structure of Sensory Root of Trigeminal Nerve.—L. A. HOAG (*Anat. Record*, 1918, **14**, 165-82) has studied this in *Mus norvegicus*. The peripheral supporting tissues, endoneurium and epineurium, together with the neurolemma, meet, without intermingling, the central supporting tissues, neuroglia and pia mater, to form an indefinite lamina cribrosa, through which the bundles of nerve-fibres pass. There seem to be distinct chemical and physical differences between the central and peripheral myelin. A number of other mammals show a similar or identical picture. J. A. T.

c. General.

Seasonal Changes in Kidney of Stickleback.—WALTER N. HESS (*Anat. Record*, 1918, **14**, 141-63, 10 figs.) has made a study of the kidney of the five-spined *Eucalia inconstans cayuga*. For most of the year it is an excretory organ. At the breeding season the uriniparous tubules and glomeruli remain excretory, while the epithelial cells of the muciparous tubules, urinary ducts, bladder, and common urinary duct become modified for producing slime. The nuclei seem to pour into the cell-bodies certain products, in the form of secretion granules, which function in breaking down the granular cytoplasm. The secretion granules seem to be produced from certain products of the karyoplasm. The making of the adhesive slime which glues, rather than ties, the material of the nest together is probably unique among fresh-water fishes; it is comparable to the secretion of slime by the genital ducts of amphibians during the breeding season. J. A. T.

Study of Malagasy Perch.—J. LEGENDRE (*Comptes Rendus*, 1918, **166**, 617-9) has made a study of *Paratilapia polleni* Blecker, one of the Cichlidae. It lives in lagoons, lakes and marshes with much vegetation, but neither in rivers nor canals. The colour of the adult is very variable and is adjusted to that of the surroundings. After the parent fishes have sojourned together for a fortnight in a chosen corner, the eggs are laid in a sort of nest. They are guarded thereafter by one parent, probably the male. At least a thousand minute eggs are laid; the incubation lasts about fifteen days; the developing eggs are very black; the larvæ suggest tadpoles. Buccal incubation, which is common in Cichlidae, does not occur, but the nest is courageously guarded. J. A. T.

Anomalous Pelvic Fins in *Cottus bubalis*.—JEAN DELPHY (*Bull. Soc. Zool., France*, 1918, **42**, 118-21, 3 figs.) discusses remarkable cases of atrophy. In the first there was coalescence, so that there seemed only one fin. Perhaps there was some arrest of development at an early stage. In the second case there was a reduction of one fin almost to a vanishing-point—perhaps the outcome of an early accident. J. A. T.

Otolith-method of Estimating Age of Plaice.—H. CHAS. WILLIAMSON (*Journ. Zool. Research*, 1918, **3**, 13–29, 17 figs.) criticizes Reibisch's otolith-method of estimating the age of the plaice, which was based on the postulate that the rings seen in the structure of the otolith are year-rings. It is maintained that this postulate does not rest on any solid basis, and that the assumption that all plaice three years old are mature is at variance with the facts. J. A. T.

Rings in Scales of Plaice and Flounders.—D. WARD CUTLER (*Journ. Marine Biol. Assoc.*, 1918, **11**, 470–96) has made experiments on scale growth, and concludes that the broad summer bands, produced by broad sclerites, and the narrow winter bands, produced by narrow sclerites, are due to changes in the temperature of the water. As the temperature varies from month to month, or even from week to week, the scale curves do not show a continuous rise and fall, but exhibit at certain places secondary elevations or depressions, secondary maxima and minima. The amount of food does not affect the production of summer and winter bands, save that poor nutrition tends to there being few sclerites produced, and high food consumption leads to high sclerite formation. Cutler's view is against that of J. Stuart Thomson, who concluded that the amount of food supply, rather than variation in temperature, brought about the formation of annual rings in scales. J. A. T.

Blue Andalusians.—W. A. LIPPINCOTT (*Amer. Naturalist*, 1918, **52**, 95–115) finds that blue Andalusians are like black Andalusians in that they are self-coloured. They are like the blue-splashed in that homologous pigmented feathers in both sexes have the same condition with reference to the restriction of pigment in the feather structure. The fundamental phenotypic differences between black, blue and blue-splashed Andalusians are briefly described. It is pointed out that the 1 : 2 : 1 ratio is in reality a combination of two 3 : 1 ratios. The condition in the blues is shown to be due to the combined action of two factors *R* and *E*. *R* acts on black pigment, restricting its distribution in such a way that it gives the characteristic blue-grey appearance. *E* extends black pigment to every feather on the fowl's body. It is impossible to decide on the basis of present facts whether *R* and *E* are located on identical loci of homologous chromosomes or are the dominants of two pairs of factors, each linked to the recessive allelomorph of the other. J. A. T.

Baculum or Os penis in some Genera of Mustelidæ.—R. I. POCKOCK (*Ann. Nat. Hist.*, 1918, **1**, series 9, 307–12, 12 figs.) confirms in regard to some Mustelidæ what Oldfield Thomas has shown for Sciuridæ, that the baculum has great systematic value as an index of affinities. He deals with the genera *Charronia*, *Grison*, and *Mellivora*, and attention is drawn to the singular differences between the bacula of *Mustela erminea* and *M. nivalis*. By the shape of the bone the latter falls into the same category as *Mustela (Putorius) putorius* and *furo*. In *M. africana* the bone is shaped substantially as in *M. nivalis*. J. A. T.

Tunicata.

Sensory Reactions of *Ascidia atra*.—SELIG HECHT (*Journ. Exper. Zool.*, 1918, **25**, 261-99, 2 figs.) finds that this Ascidian has six negative reactions to stimuli—three direct (depending on stimulation of the exterior) and three crossed (depending upon a stimulation of the interior, and abolished by severing the intersiphonal ganglion). The Ascidian is sensitive to tactile stimulation, especially in siphon rims and oral tentacles; to vibrations, in the lobes of the siphon rims; to light of high intensity, not in the "ocelli," but within the siphon near the oral tentacles; to temperatures above 32° C. and below 20° C.; to large changes in osmotic pressure; to salts, acids, bases, alkaloids, and anaesthetics (but not to sugars) in solution. On the whole, the animal's reactions are few. J. A. T.

Photic Sensibility of Balanoglossids.—W. J. CROZIER (*Journ. Exper. Zool.*, 1917, **24**, 211-7) has experimented with *Ptychodera bahamensis*, and finds that it is negatively photokinetic. In addition to this orienting stimulus, it is shown that light has another, possibly separate, effect upon these animals—namely, the inhibition of light-production. The tip of the proboscis is the part most sensitive to illumination, but the rest of the animal's surface is likewise open to stimulation by light. The collar nervous system (delaminated part) is unnecessary for the co-ordinated movements of orientation, and also for the inhibitory influence of light on the production of luminescence. J. A. T.

INVERTEBRATA.

Mollusca.

γ. Gastropoda.

Smell and Taste in Marine Snails.—MANTON COPELAND (*Journ. Exper. Zool.*, 1918, **25**, 177-227) has studied the olfactory reactions of *Alectrion obsoleta* and *Busycon canaliculatum*, which move towards the dilute chemical stimuli of distant food or extrude their proboscides. The osphradium is an olfactory organ, but all the skin surfaces tested were found to be more or less susceptible. The movements of the siphon are of much importance. Both snails show positive reactions to relatively strong food solutions, and are therefore gustatory. The principal external receptive areas for taste stimuli appear to be the tentacles, the anterior part of the foot, and the under part of the head. Touch may assist in reactions to food; the eyes do not seem to play any part; taste is effective only in the last stages of food-procurement; smell is all important. J. A. T.

Locomotion of Gastropods.—J. M. D. OLMSTED (*Journ. Exper. Zool.*, 1917, **24**, 223-36, 1 fig.) distinguishes lateral, diagonal, composite and other types of locomotion in Gastropods. Cilia are the means of pedal locomotion in *Marginella*, *Haminea* and *Bulla*. It was found that *Chiton* and *Fissurella* can move backward without reversing the

normal direction of their pedal waves. By the use of a manometer it was shown that pedal waves are areas of suction, and therefore concavities.

J. A. T.

Pedal Locomotion of *Aplysia californica*.—G. H. PARKER (*Journ. Exper. Zool.*, 1917, **24**, 139–45, 1 fig.) finds that pedal locomotion in this sea-hare “is due to monotaxic retrograde waves, which lift the foot locally and temporarily from the substrate, enabling it thus to move forward with freedom, while the rest of the foot for the time being holds the snail in place by many small areas of local suction.”

J. A. T.

Arthropoda.

a. Insecta.

Insects and Disease.—MALCOLM E. MACGREGOR (*Trans. Amer. Micr. Soc.*, 1918, **37**, 7–17. See also *Journ. Tropical Medicine and Hygiene*, 1917, **20**) publishes five provisional tables showing the part that insects play in spreading diseases of unknown origin (like trench fever), of bacterial origin, of spirochaetal origin, of Protozoan origin, and of Helminth origin. A fifth table shows the more important diseases directly attributable to insects and Acarina. Much of our knowledge with regard to insects and disease is still indefinite, but the author's tables, which are in no way dogmatic, afford striking illustration of the multiplicity of inter-relations.

J. A. T.

Wing-markings of Arctiidae.—J. F. VAN BEMMELEN (*Proc. R. Acad. Sci. Amsterdam*, 1918, **20**, 849–60) finds in a study of Arctiidae additional evidence in support of his view that there was for Rhopalocera and Hepialids an original pattern, common to all members of the group, and modified in various but not independent ways in the several families, genera and species. The colour-pattern of Arctiidae may be deduced from an ancestral fundamental form, in which a light ground is divided into seven fields by a corresponding number of transverse rows of dark spots, running uninterruptedly from fore to hind margin, on both sides of the fore as well as of the hind wings. It represents not the primitive Lepidopterous pattern but the secondary Hepialid design. No fundamental control exists between ground colour and markings; they have a common origin, and become altered in the same way by similar influences.

J. A. T.

Wing-venation of Lepidoptera.—R. J. TILLYARD (*Proc. Linn. Soc. N.S.W.*, 1917, **42**, 167–74, 7 figs.) describes the wing of a Triassic fossil insect which represents a generalized type called “Protomecopterous,” and is regarded as near the ancestral stock of the four orders Mecoptera, Trichoptera, Lepidoptera and Diptera.

J. A. T.

Observations on Caterpillars of Cabbage-white Caterpillars.—CL. GAUTIER (*C.R. Soc. Biol.*, 1918, **81**, 196–7) has seen these caterpillars regurgitate the well-known green syrupy alimentary content to a distance of 4 cm. The fluid shows nutritive particles, occasional

chloroleucites, and very minute granular filaments. The blood has sometimes a marked oxydase reaction, but this is very variable.

In another paper (*C.R. Soc. Biol.*, 1918, **81**, 197-9) GAUTIER notes that as many as fifteen to eighty larvæ of the Braconid *Apanteles glomeratus* may emerge from a single caterpillar of *Pieris brassicæ*, and fifty to sixty often appear. They form cocoons below the moribund caterpillar, but this position is not indispensable. The rough-and-ready method of crushing the caterpillars against the leaf is apt to kill their Braconid parasites as well. J. A. T.

Maritime Coleoptera.—JAMES H. KEYS (*Journ. Marine Biol. Assoc.*, 1918, **11**, 497-513) has done an interesting piece of work in recording from South Devon and South Cornwall, with especial reference to the Plymouth district, the beetles whose habitats are covered by the sea for a considerable time during the ebb and flow of the tide. The maritime beetles in the list comprise eight species, the sub-maritime fifty-four, and the coast species eighty-nine. J. A. T.

Spiracles of Hypoderma Maggot.—GEORGE H. CARPENTER and F. J. S. POLLARD (*Proc. R. Irish Acad.*, 1918, **34**, 73-84, 6 pls.) have demonstrated the presence of a paired series of (six) minute lateral spiracles, and of solidified air-tubes connecting them with the branches of the main longitudinal tracheal trunks. The vestigial structures are present in the fourth stage of larvæ of *Hypoderma bovis* and *H. lineatum*, and also in the larvæ of *Ceilemagena tarandi*, the Reindeer Warble-fly. They occur from the second to the seventh abdominal segments. Pantel observed vestigial lateral spiracles in Tachinine larvæ; the authors have not been able to find them in any other Muscoid larvæ. As *Hypoderma* is highly specialized, and yet has remains of the lateral spiracles, it is suggested that it must have diverged very early from the Muscoid stock before the larval lateral spiracles had been lost. J. A. T.

Temperature and Crossing-over in Drosophila.—HAROLD H. PLOUGH (*Journ. Exper. Zool.*, 1917, **24**, 147-209, 9 figs.) finds that the percentage of what is called "crossing-over" among the offspring of this fly is increased in the first brood, but not in the second, by alterations of temperature, which probably affects the structural make-up of the nuclear mechanism. The percentage is not affected by wet and dry food, starvation, and increased fermentation of the food. The high temperature influences appear to act at one stage in the oogenesis—in very early oocytes. J. A. T.

Reactions of Drosophila to Light and Gravity.—R. S. McEWEN (*Journ. Exper. Zool.*, 1918, **25**, 49-106, 3 figs.) finds that females of *Drosophila ampelophila* react to light somewhat more readily than do the males, but the difference decreases with age, and has almost vanished at eight or nine days. The removal of the wings involves a loss of most of the phototropism, but has little or no effect as regards response to gravity. The effect as regards phototropism is roughly proportional to the amount of wing cut off, but is not the result of the operation as such. Operations on the antennæ may produce a weakening of the

response to gravity, though they have little effect on the reaction to light. In a mutant stock called *tan* there is evidence of a sex-linked inheritance of indifference to light, which is apparently not due to any structural defect. The diverse effectiveness of different coloured lights is defined.

J. A. T.

Digestion in Cockroach.—ELDON W. SANFORD (*Journ. Exper. Zool.*, 1918, **25**, 355–411, 21 figs.) finds that the crop is the principal digestive area. Its enzyme splits up fats, and three times as actively as the stomach. The crop is also the chief area for the absorption of fats, and all the cells of its epithelium may share in absorbing. The crop is also an important storing organ; it can store enough for two months. The gizzard has an important sphincter action, and may keep back food from the stomach for several days. The needles on the cushions are moved by special muscles, but their function is doubtful. They may aid in moving food through the gizzard. The caecal epithelium, like that of the stomach, digests and absorbs. In both there are special groups of absorbing cells. The tracheal end cells absorb fatty products from the lumen of the crop, and the peritracheal cells from the blood. The tracheæ themselves never normally contain fat, but in certain tracheæ there is commonly a sticky substance of uncertain origin, often containing leucocytes.

J. A. T.

Pathological Effects of Phthirus pubis.—G. H. F. NUTTALL (*Parasitology*, 1918, **10**, 375–82) notes that the Crab-louse is not known to serve as the vector of any infective disease, and that its pathological effects on man are on the whole of slight degree. It may induce pruritus. It induces pale bluish-grey maculae, but not invariably. These mark the site of the insect's bite; they appear eight to twenty-four hours after the louse commences to feed on the spot affected. They usually disappear in about a week after the removal of the parasite. They may be due to extravasated and altered blood. Apart from the maculae a febrile condition of the skin may be brought about, and the lesions due to scratching may lead to secondary skin infection with pyogenic bacteria.

J. A. T.

Collembola of Abor Expedition.—GEORGE H. CARPENTER (*Records Indian Museum*, 1917, **8**, 561–8, 3 pls.), reports on a collection of Spring-tails from the Abor hills and elsewhere. A description is given of *Cyphoderopsis keupi*, g. et sp. n., a blind pale form found under stones at Rotung, N.E. Assam. It seems to be in many respects a connecting link between typical *Cyphoderini* and the *Paronellini*. A number of new species of *Paronella*, *Lepidocyrtus*, and *Protanura* are dealt with.

J. A. T.

Caudal Gills of Larvæ of Zygopterid Dragonflies.—R. J. TILLYARD (*Proc. Linn. Soc. N.S.W.*, 1917, **42**, 31–112, 6 pls., 32 figs.) has made a detailed study of these structures. There is a median gill formed from the appendix dorsalis, a median out-growth from the eleventh abdominal tergite. There are two lateral gills formed from the two cerci of the eleventh segments, and homologous with crustacean nropods. Each caudal gill is a hollow out-growth of the body-wall, with cuticle

and hypodermis, with tracheæ, two blood-canals, nerves and alveolar tissue, formed from hypoderm cells growing into the hæmocoel. Each gill is attached by a basal piece, with a breaking-joint. Tillyard distinguishes (1) the saccoid type, more or less sausage-shaped, either

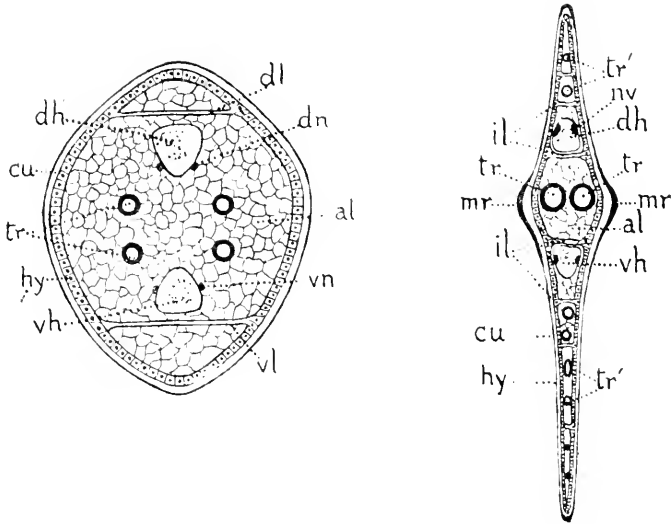

IDEAL (SEMI-DIAGRAMMATIC) T.S. OF MEDIAN CAUDAL GILLS TO SHOW THE INTERNAL STRUCTURE OF THE GILLS.

A. Across the saccoid gill-system of *Diphlebia*.

B. Across the vertical lamellar gill-system of *Austroagrion* (*Agriionid* form of gill).

al, alveolus; *cu*, soft inner layer of cuticle; *dh*, dorsal blood-canal; *dl*, principal dorsal internal lamina; *dn*, dorsal longitudinal nerve of gill; *hy*, hypodermis; *il*, internal lamina; *tr*, main longitudinal trachea of gill; *tr'*, branch trachea of gill; *vh*, ventral blood-canal; *vl*, principal ventral internal lamina; *vn*, ventral longitudinal nerve of gill.

simple or constricted; (2) the triquetro-quadrante type, triangular in transverse section; (3) the lamellar type, with a rachis and vertical or horizontal blades, but admitting of further classification; and (4) the reduced (non-functional type), with a vanishing tracheal system.

J. A. T.

β. Myriopoda.

Peculiar Variation in *Brachydesmus*.—HENRY W. BRÖLEMANN (*Ann. Mag. Nat. Hist.*, 1918, 1, series 9, 281-4, 3 figs.) describes a peculiar condition in an immature specimen of a species of *Brachydesmus*—namely, the presence of almost adult copulatory organs. Such a structure is frequent and even normal with Diplopods of archaic type, such as Colobognatha or Spiroboloidea; but that it should be witnessed in the highly specialized Polydesmoidea is certainly most striking. It seems to be an instance of “neotenia.”

J. A. T.

δ. Arachnida.

Hydracarina of Epping Forest.—CHARLES D. SOAR (*Essex Naturalist* (published Oct. 1917), **18**, 96-105, 23 figs.) gives a list of fifty-two species, in twenty genera, from Epping Forest—about one-fifth of the total number of species for the Britanic area. Eleven forms are figured. J. A. T.

Lebertia sefvei Walter.—W. WILLIAMSON and CHARLES D. SOAR (*Journ. Quekett Micr. Club*, 1918, **13**, 1-4, 1 pl.) record the discovery of this Arctic form in Dartmoor, bringing the number of British species of *Lebertia* up to twelve. They give a description and figures of the external features. J. A. T.

New Pentastomid from a Fish.—P. DE BEAUCHAMP (*Bull. Soc. Zool. France*, 1918, **43**, 14-20, 3 figs.) describes *Porocephalus nematoides* sp. n., from the food-canal of a species of *Mastacembelus* from Lake Tanganyika. The only other species known from fishes is *P. gracilis* (Diesing), and the two are nearly allied. Both are elongated and cylindrical, very like Nematodes. J. A. T.

ε. Crustacea.

New Parasitic Copepod.—CH. J. GRAVIER (*Comptes Rendus*, 1918, **166**, 502-5) describes *Flabellicola neapolitana*, g. et. sp. n., found attached to the restricted area anterior and dorsal to the gills, and between two fans of setæ, on the first segment of the Polychæt *Flabelligera* (*Siphonostoma*) *diplochaitos*. The body of the female shows no appendages, nor segmentation, nor food-canal—little more indeed than ova and granular reserve material. Some spermatozoa were found, but no males were discovered. The remarkable parasite may be provisionally referred to Hansen's family of Herpyllobiidæ. J. A. T.

Annulata.

Peculiarly Adapted Annelid.—F. MESNIL and M. CAULLERY (*Bull. Soc. Zool., France*, 1918, **42**, 127-32, 5 figs.) describe *Exogone hebes* Webster and Benedict, var. *hibernica* Southern, a rare Syllid, requiring a new sub-genus *Parexogone*. It lives in compact sand and has a somewhat Oligochæt appearance. The head is prolonged into a sort of cone with fused palps; the anterior part of the food-canal is very muscular, with proboscis, crop, and gizzard; the cuticle is very thick. In short the worm is remarkably adapted to peculiar conditions of life. J. A. T.

Notes on Syllids.—F. MESNIL and M. CAULLERY (*Bull. Soc. Zool., France*, 1918, **43**, 34-40, 2 figs.) discusses some interesting Syllids from the *Lithothamnion* zone at the Hague. These include *Myrianida fasciculata*, a new *Autolytus*, and various species of *Exogone*, *Sphærosyllis*, and *Grubea*. Attention is directed to the occurrence of a sexual stolon and schizogamy in *Grubea limbata*, and to the presence of a species of *Rhopalura* inside *Sphærosyllis erinaceus* Clp. J. A. T.

Effect of Radium on Fertilization Membrane of Nereis.—ALFRED C. REDFIELD and ELIZABETH M. BRIGHT (*Amer. Journ. Physiol.*, 1918, **45**, 374–87) find that the fertilization membrane of the egg of *Nereis limbata* becomes abnormally thick if the egg is exposed to radiations from radium prior to fertilization. The change leading to the condition is irreversible. The physiological effect is not proportional to the product of intensity and time. The time factor is relatively more important than the intensity factor. J. A. T.

Branchiobdellids from Michigan Crawfishes.—MAX M. ELLIS (*Trans. Amer. Micr. Soc.*, 1918, **37**, 49–51) defines and distinguishes *Xironodrilus formosus* Ellis in ed., *Cambarincola vitrea* Ellis in ed., *C. philadelphica* (Leidy), and *Pterodrilus durbini* Ellis in ed. from numerous crawfish hosts. J. A. T.

Nemathelminthes.

Filter-bed Nematodes.—N. A. COBB (*Nematology, Baltimore*, 1918, 189–212, 9 figs.) finds that towards the end of a period of use the number of Nematodes in the topmost three inches of a filter-bed often amount to hundreds of millions per acre, and sometimes exceeds a thousand millions. About thirty species were found. The commonest are carnivorous. Their soluble excretions may give flavour to water. A description is given of the process of discharging the secretion from the caudal glands. It is pointed out that species of Nematodes regarded as parthenogenetic may turn out, as in the case of *Plectus*, to have minute functional spermatozoa. Some hermaphrodite forms begin by producing spermatozoa which are stored till the ova are produced. The reproductive phenomena are discussed and new terms are proposed. A number of new genera and species are described and figured. J. A. T.

Development of *Ascaris lumbricoides* and *A. mystax* in Mouse.—F. H. STEWART (*Parasitology*, 1918, **10**, 189–96, 1 pl.) has continued his study of the migration of *A. lumbricoides* in the mouse, and has followed the course of the parasites from the ninth to the fifteenth day, during which period many make their way down the intestine. The structure of the young stages is described. Cultures of *A. mystax* in a damp atmosphere showed three-cell stages on the first day, advanced segmentation on the second, curved vermicles on the fourth and fifth, plump vermicles on the seventh, and so on. Ripe eggs were given to mice, and active larvæ were found in the liver between the first and third days after infection. J. A. T.

Life-history of *Ascaris lumbricoides*.—F. H. STEWART (*Parasitology*, 1918, **10**, 197–205) finds that ripe eggs of *A. lumbricoides* or *A. suilla* hatch in the intestine of their definitive hosts, man or the pig, and also in the rat and mouse, and develop in the body of man and of these animals in an identical manner up to the 2 mm. larva in the trachea. Further, that in the mouse the larvæ then pass through the alimentary canal unharmed and are evacuated in the faeces. It may be, however, that the normal development of either species is in one host

only. The eggs of *A. lumbricoides* were found to develop in faeces of man and pig freely exposed to air. No development was observed in contaminated water, but some may develop in tap-water. Development also occurs on the surface of moist clayey earth. The author doubts whether the importance of human Ascariasis is sufficiently recognized.

J. A. T.

Acanthocephala of North American Birds.—H. J. VAN CLEAVE (*Trans. Amer. Micr. Soc.*, 1918, **37**, 19–47, 5 pls.) deals with new species of *Corynosoma*, *Plagiorhynchus*, and *Polymorphus*, and with a number of systematic points. A key is given to all described species of Acanthocephala from North American birds. Among North American birds the occurrence of two different species within the same host-individual has not been recorded. There is no positive case on record of the occurrence of two different genera of Acanthocephala within the same species of North American bird.

J. A. T.

Platyhelminthes.

Trematode Larva from Buccinum undatum.—MARIE V. LEBOUR (*Journ. Marine Biol. Assoc.*, 1918, **11**, 514–8, 7 figs.) describes from the digestive gland of this Gastropod a sporocyst and cercaria which are almost certainly stages of *Zoogonus viviparus* (Olsson). The life-history of this species, common in the intestine of fishes, is so far unknown. From the structure of the cercaria (a Cotylocercous type), which is able to use the posterior end of its body as a sucker-like organ, it is probable that the intermediate host is an actively swimming animal, as in all probability the sucker is used by the cercaria for fixing the hind end of its body whilst the free part waves about in order to catch a host. The stylet on the head and its glands opening beside it show that the cercaria bores into its host. Notes are made on a number of immature and adult Trematodes found in young fishes.

J. A. T.

Life-history of Distoma luteum sp. n.—J. D. F. GILCHRIST (*Parasitology*, 1918, **10**, 311–9) found in *Physa tropica*, in S. Africa, the rediæ and cercariæ of *Distoma luteum* sp. n., which he found as an adult in the alimentary canal of frogs. Several other Trematode stages were found, but the S. African host of the liver-fluke remains uncertain, *Limnæa truncatula* being at the most very rare. A description is given of the eggs, rediæ, cercariæ, cysts, and adults of *D. luteum*.

J. A. T.

Trematodes of Queensland Reptiles and Frogs.—W. NICOLL (*Parasitology*, 1918, **10**, 368–74, 1 pl.) describes *Brachysaccus juvenilis* sp. n., from the intestine of burrowing frogs (*Chiroleptes brevipalmatus*); *Sigmapepa cincta* n. g. et sp. n. from fresh-water turtles (*Emydura latisternum*)—a minute form, hardly over 1 mm. in length, with a characteristic Y-shaped excretory vesicle; *Lecithochirium dillaneii* sp. n., from a sea-snake; and some other forms.

J. A. T.

New Trematode from Australian Poisonous Snakes.—WILLIAM NICOLL (*Parasitology*, 1918, **10**, 290-3) describes *Dolichopera maralpini* sp. n., which, like *D. parvula*, seems to have its normal habitat in the œsophagus, trachea and lungs of snakes. J. A. T.

Structure and Development of Cladorchis.—FRED D. WEIDMAN (*Parasitology*, 1918, **10**, 267-79, 1 pl., 2 figs.) deals with *Cladorchis* (*Stichorchis*) *subtriquetrus* Rudolphi, from the cæcum of the beaver. He describes the external features, the alimentary, reproductive, muscular, and excretory systems. Special attention is directed to the pre-œsophageal sphincter, the œsophageal musculature, the heavy ventral subcuticular musculature, the slight branching of the young testes, the late development of the yolk glands, and so on. It is probable that this Trematode is a commensal as much as a parasite. J. A. T.

Liver-rot.—C. L. WALTON (*Parasitology*, 1918, **10**, 232-66, 5 figs.) has studied the occurrence of this disease in the Aberystwith area. There is a marked coincidence between the distribution of clay and *Linnæa truncatula*, and of *L. truncatula* and Liver-rot. Drought and severe frost work against the snails. Rainfall and its distribution throughout the year is the most important factor governing the increase, spread, and infectivity of the snail. The ova may develop even after the egg-masses have dried down to a hard scale. Roadside ditches are very frequently inhabited by infected snails, and drainage from them may be the cause of cases of rot. Cercariæ of *Distomum hepaticum* were obtained from *L. truncatula* practically throughout the year, but not from snails measuring less than 4.5 mm. Seventy cercariæ were given off naturally, within forty-eight hours, from one specimen measuring 7 mm. in length. A few cercariæ resembling those of *D. hepaticum* were obtained on one occasion from *L. peregra*. J. A. T.

Regeneration in Planaria maculata.—J. M. D. OLMSTED (*Journ. Exper. Zool.*, 1918, **25**, 157-77, 14 figs.) has studied the regeneration of triangular pieces cut from the side. They will regenerate heads at right angles to the original long axis if the following conditions are fulfilled:—(a) the point of the intersection of the two cut edges must lie at or near the old median axis of the worm; (b) the angle between the cut edges must be 90° or less; and (c) the cut edges must be of the same length. Under all other conditions the old polarity is most evidently unchanged. If the piece is small, it may regenerate a head only, but the position of this head shows the tendency to retain the old polarity. Numerous special facts in regard to the regeneration of triangular pieces are stated; the general result is the possibility of retaining polarity even in extreme cases. J. A. T.

Incertæ Sedis.

Life-history of Dicyemids.—AUG. LAMEERE (*Bull. Soc. Zool. France*, 1918, **42**, 122-6) finds that there are five successive generations:—(1) an asexual immigrant generation of "founder-nematogens"; (2) a sedentary asexual generation of "primary nematogens," which are

transformed into "rhombogens"; (3) a hermaphrodite generation of "infusorigens," which arise inside the rhombogens; (4) an asexual emigrant generation; and (5) an asexual generation in some host (still unknown) different from the Cephalopod. There is a period comparable to the Orthonectid's stay in its first host, and there is a period in the kidneys of Cephalopods. The latter has been, as it were, intercalated between the emergence of the Orthonectid from its first host and its return to the same in the form of an infusiform larva arising from a fertilized ovum. A Dicyemid is a hermaphrodite Orthonectid which, instead of reproducing in the sea, penetrates into the kidneys of Cephalopods, becomes asexual, exhibits several generations, and eventually gives rise to the larvæ which find the primary host.

J. A. T.

Rotatoria.

Controlling Sex in Rotifers.—D. D. WHITNEY (*Journ. Exper. Zool.*, 1917, **24**, 101-138, 4 figs., 4 diagrams) finds that when the green-food supply (*Chlamydomonas*) is very abundant the rotifers *Brachionus militaris*, *B. bakeri* and *Euchlanis dilatata* produce a high percentage of male-producing daughters. If the same food is scanty, very few, if any, male-producing daughters are produced. The same is true for the marine *B. mulleri* for either green or colourless food. A race of New Jersey *Hydatina senta* fed on *Chlamydomonas* in the dark without excess of oxygen present produced male-producing daughters nearly as readily as in the light with an excess of oxygen. The excess of oxygen in the culture water acts indirectly on the mother rotifers by influencing the number of micro-organisms which form the food.

J. A. T.

Echinoderma.

Permeability of Sea-urchin Ova.—RALPH S. LILLE (*Amer. Journ. Physiol.*, 1918, **45**, 406-30) finds that fertilized eggs of *Arbacia* and *Echinarachiniis* shrink rapidly and undergo crenation in hypertonic sea-water or van't Hoff's solution (of thirty to forty atmospheres osmotic pressure), while unfertilized eggs shrink slowly in the same solutions and remain round. The relative rates of swelling in dilute sea-water are similar. It follows that fertilization results in a marked increase in the permeability of the plasma-membrane (the semi-permeable surface-layer of protoplasm) to water. Artificial formation of fertilization membranes by butyric acid causes similar though more variable effects in *Arbacia* eggs. The change in permeability begins two and four minutes after fertilization, and is completed in about twenty minutes. The increase of permeability is prevented by anaesthetics and some other reagents.

J. A. T.

Homologies of Anal Plate in Antedon.—F. A. BATHER (*Ann. Mag. Nat. Hist.*, 1918, **1**, series 9, 294-302) discusses the homologies of the plate which appears, migrates, and disappears in the posterior inter-radius of the larval *Antedon*, and is what is called the anal plate. It has been regarded as homologous with the plate generally known as

anal x (the brachianal of Bather, 1890) in the Crinoidea inadunata and flexibilia. This conclusion is upheld in opposition to Austin H. Clarke's suggestion that the anal plate of *Antedon* is homologous with the radianal (Bather, 1890).
J. A. T.

Cell-division in Monaster and Narcotized Ova.—THEOPHILUS S. PAINTER (*Journ. Exper. Zool.*, 1918, **24**, 445-97, 5 pls., 10 figs.) has studied the division of sea-urchin ova treated with narcotics, or shaken so that many Monaster forms (with one division-centre) result. At each division cycle, the egg-protoplasm is affected in three ways: (1) there is a pronounced swelling of the ectoplasmic layer; (2) this is followed by intense changes in surface tension leading to the formation of pseudopod-like processes; (3) there is a flow of the superficial protoplasm towards the area where the streaming is taking place. Ingenious experiments point to the nucleus as the source of a second factor in cell-division which finds expression in a swelling of the ectoplasm, great changes in surface tension, and a flow of the cortical layers of protoplasm towards the cleavage area. The asters seem to act as regulative centres during cell-division; by forming denser areas they restrict the action of the nuclear factor to a prescribed area.
J. A. T.

Physiology of Synaptula hydriformis.—J. M. D. OLMSTED (*Journ. Exper. Zool.*, 1917, **24**, 333-79, 2 figs.) has made a study of this Holothurian at Bermuda. It occurs in red and green varieties. It feeds chiefly on a filamentous alga. There is a rhythmic pulsation of the intestine. Nearly every specimen contained a mass of symbiotic bacteria lying free in the body-cavity. There seems to be a well-developed chemical sense. Probably, as in *Lumbricus* (where, according to Langdon, a specimen of 152 segments, 19 cm. long, has 150,000 sensory structures, about 1,000 to each segment), there are "universal sense organs," receptive to tactile and photic as well as chemical stimuli. This is at the other pole from man, where there are no recognizably universal sense organs, but some twenty (Herrick) special senses. In any case in *Synaptula*, in addition to eyes and otcysts, only one type of sense organ has been found.
J. A. T.

Cœlentera.

Activities of Corymorpha.—G. H. PARKER (*Journ. Exper. Zool.*, 1917, **24**, 303-31) has studied *Corymorpha palma*, a large and hardy Hydrozoan. Its stalk measures as much as 10 cm. or more in length, with a diameter at the thickest part of about 0.5 cm. The mucous glands are insignificant; cilia seem to be absent; the stinging cells are not under the control of the nervous system; the muscles may or may not be so controlled. There are four longitudinal ectodermic muscles—of the stalk, of the proboscis, of the proximal, and of the distal tentacles. There are two circular endodermic muscles—of the stalk and of the proboscis. Both are stimulated directly, but the second is probably also under partial nervous control. Nervous transmission is diffuse except in the stalk, where it is predominantly longitudinal. The stalk, proboscis, and tentacles show great autonomy. The locomotion is very

circumscribed and slow. There is a neuromuscular negatively geotropic response. In quiet water the mouth and distal tentacles are pressed on the mud. In running water the proximal tentacles entangle food and transfer it to the distal tentacles and mouth. The neuromuscular mechanism of *Corymorpha* is not intermediate between that of the receptor-effector system of Actinians and the independent effectors of sponges. It resembles a reduced Actinian system rather than a primitive state from which such a system could be derived. J. A. T.

Suction in Sea-anemone.—G. H. PARKER (*Journ. Exper. Zool.*, 1917, **24**, 219–22, 1 fig.) has experimented with *Cribrina xanthogrammica*, which has great power of suction in its tentacles, and in tubercles which extend in rows from the oral to the pedal disc. The tentacles grip food; the tubercles grip pieces of shell. The breaking force required to separate fragments of shell from the tubercles was measured. The average for ten trials was 47.2 grm., and the average suction-pressure was 11 grm. per square millimetre. This amounts approximately to 15.6 pounds per square inch. As the limit of suction under ordinary circumstances is one atmosphere, or 14.7 pounds per square inch, it appears that at the moment of breaking the sea-anemone was exerting as much suction as, under the circumstances, was physically possible. J. A. T.

Antarctic Actiniaria.—T. A. STEPHENSON (*British Antarctic ("Terra Nova") Expedition*, 1910. *Zoology*, **5**, No. 1, 1–68, 6 pls. Printed by order of Trustees of the British Museum, 1918) establishes five new genera—*Hormosoma*, *Lilliella*, *Artemidactis*, *Aiptasioides*, and *Leptoteichus*—and gives careful descriptions of fifteen species, of which eleven are new. All were collected by the "Terra Nova" Expedition, and seven were obtained in deep water in the Antarctic area. Among the general notes reference is made to nutritive amoeboid cells in the mesogloea, to the presence of zooxanthellae in the male gonads, and to the relative value of diverse structural features. It would seem that the most generally reliable generic characters are to be found in the external features of the body other than its length, in the number of perfect mesenteries, and in the musculature. J. A. T.

Protozoa.

Metabolic Gradients in Amoeba and their Relation to Amoeboid Movement.—LIBBIE H. HYMAN (*Journ. Exper. Zool.*, 1917, **24**, 55–99, 14 figs.) finds in each pseudopodium a gradient in susceptibility to potassium cyanide. It is greatest distally and in the most recent vigorous pseudopodia. The regions of highest susceptibility are thus anterior, as in other organisms. The gradient arises before the pseudopodium appears, and hence the metabolic change which produces increased susceptibility is the primary cause of pseudopodium formation. Evidence is adduced to show that the surface of most amoeboid organisms is in a state of gelation, and it is argued that amoeboid movement must be due to alterations of the colloidal state. Liquefaction or

solution is regarded as the cause of the extension of a pseudopodium ; coagulation or gelation as the cause of the withdrawal of pseudopodia ; and of active contraction. This theory is an extension of one previously advanced by Rhumbler. J. A. T.

Reactions of *Pelomyxa* to Food.—W. A. KEPNER and J. GRAHAM EDWARDS (*Journ. Exper. Zool.* 1917, **24**, 381-407, 14 figs.) find two kinds of reactions, according as the objects engulfed are capable or incapable of retreat. The food includes plants and animals, and varies in size from Nematodes to very minute Infusorians. The paths of possible retreat of motile organisms present a wide range of variability, and the details of the amœba's reactions cannot be predicted. No hypothesis yet advanced to explain the movement of Rhizopods can be applied to the solution of the problem of the movement of *Pelomyxa* in relation to the food-bodies. J. A. T.

***Entamœba histolytica* and *Entamœba ranarum*.**—CLIFFORD DOBELL (*Parasitology*, 1918, **10**, 294-310) has made numerous experiments in the attempt to infect tadpoles with the human *Entamœba histolytica*, but it seems that the cysts, when ingested, pass unchanged through the intestine, without undergoing any development. This indicates the conclusion that the two species, in spite of close resemblance, are somehow distinct, and that the frog, in all probability, is not a "reservoir" of human amœbic dysentery. J. A. T.

Races of *Entamœba histolytica*.—CLIFFORD DOBELL and MARGARET W. JEPPE (*Parasitology*, 1918, **10**, 320-51, 1 pl., 7 figs.) find that *Entamœba histolytica* Schaudinn (vel *E. dysenteriae* Councilman and Laflour) is a collective species, comprising a number (five) of distinct races, strains, or pure lines, distinguishable from one another by the size of the cysts which they produce. These races remain constant in character within a given host ; and the dimensions of the cysts are not determined by the action of the host upon the parasite, since two different races may co-exist side by side in the same host. Since cysts of *E. histolytica* may be found with all diameters from about 5μ to 20μ —a range overlapping or covering the dimensions of the cysts of the harmless intestinal amœbæ (*E. coli* and *E. nana*) and of other cysts and cyst-like bodies in human faeces—it is of considerable practical importance to recognize and distinguish the diverse races of the collective species in question. J. A. T.

New Amœba from Man.—MARGARET W. JEPPE and CLIFFORD DOBELL (*Parasitology*, 1918, **10**, 352-67, 1 pl.) describe *Dientamœba fragilis* g. et sp. n., a very small amœba from the human intestine. The diameter when rounded is about 3.5μ to 12μ , averaging about 9μ ; the cytoplasm is differentiated into ectoplasm and endoplasm ; the pseudopodia are flattened, hyaline, and leaf-like, usually few, with irregularly dentate margins ; the progression is snail-like ; there are no contractile vacuoles. There are typically two nuclei, averaging about 2μ . Each possesses a large central karyosome surrounded by a clear zone containing no peripheral chromatin and limited externally by a very delicate achromatic nuclear membrane. The organism probably

divides into two uninucleate daughter-individuals, which become binucleate. Cysts are unknown. The food consists of small vegetable organisms in the intestinal contents.

J. A. T.

Intracellular Respiration in Paramecium.—E. J. LUND (*Amer. Journ. Physiol.*, 1918, **45**, 351-73) has studied in *Paramecium caudatum* the relation of oxygen concentration and the rate of intracellular oxidation. He finds that the oxidations stop when the cell is killed by too high oxygen-concentration, but below the limit of fifty-five times the minimal concentration the rate of intracellular oxidation is independent of the concentration. The rate is entirely independent of the toxic action of potassium cyanide, but intracellular oxidations stop when the animal undergoes cytolysis in cyanide solutions.

J. A. T.

Experimental Induction of Endomixis in Paramecium aurelia.—R. T. YOUNG (*Journ. Exper. Zool.*, 1917, **24**, 35-53, 3 pls. referred to, not in number) finds that endomixis can be induced experimentally, especially by the use of metabolic end-products (e.g. waste products of Infusorians), and by increasing the rate of metabolism of the animals themselves. It is not a lethal process, but may be associated with a temporary depression. It is more or less cyclical in character, and probably has a rejuvenating function. It is not, however, a necessary accompaniment of temporary depressions, and may not be followed by rejuvenation. Other factors are concerned in determining the division-rate. Its rate to parthenogenesis in Metazoa is not clear.

J. A. T.

Reversibility of Morphogenetic Processes in Bursaria.—E. J. LUND (*Journ. Exper. Zool.*, 1917, **24**, 1-33, 38 figs.) finds that de-differentiation of the gullet of this Ciliate always occurs before division, encystment, and regeneration of lost parts of the cell, and also spontaneously. But the primordium of the gullet remains, and from it a new gullet is formed by differentiation. The processes are reversible. They concern changes in relatively unstable, secondary structures in the cell, and do not visibly affect the more stable nuclear mechanism. The author finds evidence for the existence of a specific type of physical-chemical mechanism for de-differentiation similar in its action to the mechanism of antolysis.

J. A. T.

Trypanosomes in Monkeys.—M. LEGER and E. PARRY (*C.R. Soc. Biol. Paris*, 1918, **81**, 180-3) report the occurrence of some new non-pathogenic Trypanosomes in South American monkeys—a very distinct form (*Trypanosoma leourdi* sp. n.) in *Ateles pentadactylus*; and another (*T. devei* sp. n.) in *Midas midas*, with the general features of non-pathogenic forms from small mammals.

J. A. T.

New Microsporidian in Cabbage White Caterpillars.—A. PAILLOT (*C. R. Soc. Biol.*, 1918, **81**, 187-9, 26 figs.) describes *Perezia legeri* sp. n., from caterpillars of *Pieris brassicæ*, especially in adipose tissue and certain giant cells of the blood. An account is given of the schizogony, the sporogony, the maturation of the spores, and the emergence of a binucleate unit from the spore. The new species is near *P. mesnili*, previously described.

J. A. T.

New Cephaline Gregarine.—D. KEILIN (*Parasitology*, 1918, 10, 406-410, 1 pl., 1 fig.) describes *Leidyana tinei* sp. n., from the mid-gut of the larvæ of the moth *Endrosis fenestrella* found in the nests of the house-martin. An account is given of the small trophozoites, the full-grown sporonts, the cyst formation, and the spores. The main characters of the genus are the solitary sporont, the simple subspherical epimerite, the dehiscence by sporoducts, and the barrel-shaped spores. The difference between the new species and the two already known are detailed. This seems to be the first record of a Gregarine as a parasite in Lepidoptera. J. A. T.

Foraminiferal and Nullipore Structures in some Tertiary Limestones from New Guinea.—R. BULLEN NEWTON (*Geol. Mag.*, 1918, Decade 6, 5, No. 5, 203-12, pls. viii-ix). The rolled Limestone pebbles collected in the upper reaches of the Fly River, New Guinea, prove, on examination by sectioning, to represent two distinct horizons. Apart from the confirmation afforded by the corals, the presence of *Alveolina* and the closely related *Lucazina wichmanni* Schlumberger, in association with characteristic Miliolines, are sufficient to identify some of the Limestones with the Lutetian or Middle Eocene, contemporary with our Bracklesham beds. The striking similarity between sections of the New Guinea pebbles and the well-known "Mixer" rock of Selsey, is referred to by the author and confirmed by his photos. It will be of great interest if subsequent discoveries of more suitable material result in the discovery of *Cyclolocolina* and other forms typical of the Selsey beds.

The identification of the remaining pebbles as Miocene is mainly dependent on the occurrence of the calcareous alga *Lithothamnium ramosissimum* (Reuss), typical of that formation, and especially of its later horizons. In the absence of any specimens of *Lepidocyclina*, the Foraminifera recorded are not very convincing, but the author considers that the pebbles may probably be referred to the Aquitanian or older Miocene. E. Heron-Allen & A. Earland.

BOTANY.

GENERAL,

Including the Anatomy and Physiology of Seed Plants.

Cytology,

Including Cell-contents.

Nature and Significance of the Chondriome.—A. GUILLIERMOND (*Compt. Rend.*, 1918, **166**, 649-651). A short note upon the chondriome, which the author regards as a constituent element of all cells, whether of animal or vegetable origin. The chondriome is represented by mitochondrias, which exist as minute bodies in the homogeneous cytoplasm, distinguishable from the latter by their greater refractive power. They are granular or in the form of short rods or filaments, sometimes elongated and of undulate outline, more rarely branched. They are the most fragile parts of the cell and are especially sensitive to osmotic influences. In a hypotonic medium the granular mitochondrias swell and form large, aqueous vesicles, while the chondriocotes break up into granules and subsequently form similar vesicles, but it is easy to prove that these formations do not represent the normal evolution of the mitochondrias.

Researches as to the nature of both animal and plant mitochondrias show that they are living entities, capable of reproduction by division; during mitosis the chondriome divides into two portions, one of which passes to each pole. The mitochondrias give rise to the greater part of the secretory products of the cell, and are entirely similar in character to the well-known plastids.

In general the chondriome of the plant-cell is represented in the egg by granular mitochondrias; in the embryonic cells a portion of these elements is transformed into chondriocotes, which subsequently develop into plastids; others retain the granular form and assume other functions, or simply serve for the perpetuation of the chondriome.

S. G.

Constancy of Cell-Shape.—L. A. TENOPYR (*Bull. Torr. Bot. Club*, 1918, **45**, 51-76, 1 fig.). The author has studied the relative length and breadth of leaves and their constituent cells in three types of plants—viz. (1) species with broad basal leaves, narrow stem-leaves and transitional leaves, represented by *Campanula rotundifolia* and *Lobelia Erinus*; (2) broad and narrow-leaved species belonging to the same genus, such as *Plantago major* and *P. lanceolata*; (3) varieties of the same species having entire leaves as compared with others having lobed leaves, such as are found in *Cichorium Intybus*.

The cells of the plants examined show considerable variability in size in the same tissue, but the average cell-size for any one tissue of a species or variety is a fairly constant and hereditary character. The cell-size of closely related species may be the same, but may differ con-

siderably in closely related varieties of the same species. Cell-size depends to some extent on the stage of development of the plant when the organ was formed, the cells of organs of late development being smaller than those in organs of early development. Difference in size of any given organ is due to a difference in number of cells, not to cell-size.

The number of cells in each type of leaf is determined by heredity, and the size of the organ is due to factors of periodicity in growth, which determine the rate and duration of cell-division.

The cells of the lower epidermis of leaves have a characteristic length and breadth, but in other regions their shape is modified by other factors—e.g. presence of veins, stomata, etc. Differences in shapes of leaves of the same plant are independent of the shape of the cells. The shape of the leaf is due to factors of periodicity limiting the number and direction of the cell-divisions in each type of leaf. S. G.

Structure and Development.

Vegetative.

The Use of Microscopical Characters in the Systematic Study of the Higher Plants (*Journ. Q.M.C.*, April 1918, ser. 2, 13, 353-60).—In the Presidential Address to the Quekett Microscopical Club for 1918, DR. RENDLE points out the great use that may be made of minute characters in the detection of species, instancing the valuable work done on the microscopical structure of timber, especially in those cases where only fragmentary material is available. Also that the recognition of affinities among fossil plants is almost wholly based upon microscopic characters. Plant hairs, pollen grains, and secretory glands are also referred to. A. W. S.

Reproductive.

Effect of Foreign Pollination on *Cycas Rumphii*.—M. J. LE GOC (*Ann. Roy. Bot. Gard. Peradeniya*, 1917, 6, 187-194). The author describes his preliminary observations carried out in Ceylon. He finds that while female plants of *Cycas Rumphii* are very abundant in Ceylon, no male plant has been observed of late years. The dispersal of this species of *Cycas* in Ceylon takes place by means of offshoots, and no true seeds can be obtained. In the districts where no male plant of any Cycad can be found, the ovules of *C. Rumphii* thrive only for a short time, shrivel, decay, and fall off. But in localities where male cones even of different genera occur, the ovules of *C. Rumphii* attain the size of a fully mature seed; but they contain no embryo, and consequently do not germinate. On investigation it is found that foreign pollen grains belonging to *Encephalartos* or *Macrozamia* have not only pollinated *C. Rumphii*, but have produced male gametophytes. The full growth of the ovules of *C. Rumphii* must be attributed to the stimulus exercised by these foreign male gametophytes. No true fertilization, however, has been observed, or is likely to have taken place. Some minor points, such as the effect of spores of fungi received inside the pollen chamber, have also been discussed. A. B. R.

Graft-hybrids.—F. LA MARCA (*Compt. Rend.*, 1918, 166, 647-649). A note upon a new graft-hybrid; the graft is the *Cannellina* variety of the olive-tree, while the stock belongs to the *Caiazana* variety. The writer found three such grafted trees which produced black fruits similar to those belonging to the stock, and white fruits like those of the graft. Further investigation showed that the kernels of the fruits, both in form and marking, were intermediate between the graft and the hybrid. The peduncles and leaves were also intermediate in character. Analysis of small quantities of oil taken from the hybrid showed that in acidity, and in its behaviour under the influence of light and air, this oil differs from that extracted both from the stock and the graft. The observations extended over four years, and may be regarded as confirming the opinion of those writers who support the theory of asexual hybridization. S. G.

CRYPTOGAMS.

Pteridophyta.

(By A. GEPP, M.A., F.L.S.)

Study of Some New Cases of Apogamy in Ferns.—W. N. STELL (*Bull. Torrey Bot. Club*, 1918, 45, 93-108, 2 pls.). During the past six years the author has discovered apogamy in many ferns, especially in *Pellaea*, *Pteris*, *Aspidium*. In a summary of his results he states that the material was grown under cultural conditions favourable for the development of sex-organs and embryos in non-apogamous species. The apogamous prothallia became heart-shaped before producing the embryo, and bore antheridia, but rarely archegonia. The embryo usually appears as a compact region of cells posterior to the apical notch and on the ventral side of the prothallium; and in several species tracheids are visible in the pale portion of the gametophyte. First appears the apical cell of the leaf, then that of the root, and later that of the stem; but so far no foot has been observed in an apogamous embryo. Either root or leaf or both may develop on the dorsal side of the prothallium, but as a rule arise on the ventral side. As a rule the embryo is produced behind the apical notch, but may be formed on a cylindrical or conical "process," and occasionally on the lobes of the prothallium. Several apogamous embryos may be formed on a single prothallium. Secondary prothallia are readily produced (just as in non-apogamous species), and these form embryos like those of the ordinary prothallia. The "light" area present on some apogamous prothallia is rendered more conspicuous in cultures maintained in weak light; also the conical or cylindrical "process" increases considerably in length when the prothallia are grown under these conditions; and, further, the embryo often arises directly from the apical region of the prothallium in weak light. In the case of *Osmunda regalis*, prothallia cultivated in strong light and prevented from fertilization for a year and a half failed to produce apogamous embryos. A. G.

Comparative List of Fern Pinna-traces, with some Notes on the Leaf-trace in the Ferns.—R. C. DAVIE (*Annals of Botany*, 1918, 32, 233-245, figs.). The author gives a complete tabular list of all the

ferns which he has examined, showing whether they have the marginal or the extra-marginal type of pinna-supply. In the *extra-marginal* type the portion of the pinna-trace which comes from the adaxial side of the leaf-trace is nipped off from the back of a "hook," technically from the abaxial face of the curved leaf-trace; the extreme tip of the adaxial portion of the leaf-trace is continued upward as part of the leaf-trace. In the *marginal* type, the adaxial portion of the leaf-trace (nearest to the pinna) is itself given off to supply the pinna. In both types (usually in connexion with large pinnæ) a portion of the pinna-trace may be derived from the abaxial side of the leaf-trace. In the tabular scheme of ferns appended to the paper, it will be found that 94 species (46 genera) possess the extra-marginal type, and 126 species (51 genera) possess the marginal type. In 7 genera only do both types of pinna-supply occur among the species. In studying the ferns for this criterion it is necessary to examine the lower pinnæ of the older leaves.

A. G.

Bryophyta.

(By A. GEPP.)

Structure of the Cytoplasm in the Cells of *Alicularia scalaris*.

—M. F. RIVETT (*Annals of Botany*, 1918, **32**, 208–214, pl. and figs.). The author describes the structure of the cytoplasm of this hepatic with special reference to the oil-bodies, their meaning and origin. The oil is a catabolic waste-product and is secreted into vacuoles. Further, as to the cytoplasmic structure of the leaf-cells, the author finds that (1) the actively dividing cells of the growing point and young leaf-bases, where the protoplasm fills the whole cell, show a chondriome structure; (2) the maturing cells have a vacuolar protoplasm forming a spongy network; (3) in the fully-grown cells the lining layer is so reduced that it serves merely as a covering to its own products.

A. G.

Le Reboulia Raddi.—CH. et R. DOUIN (*Rev. Génér. de Botanique*, 1918, **30**, 129–145, 5 figs.). The authors have carefully studied and cultivated the hepatic genus *Reboulia*, which has generally been supposed to comprise a single polymorphic and cosmopolitan species, and have come to the conclusion that three distinct species occur in France—*R. hemispherica* (L.) Raddi, *R. occidentalis*, *R. Charrieri*, the two latter being new to science. They discuss in detail the essential characters of the species—the inflorescence, the capitulum (with a critical examination of the terms "lobes" and "rays"), the development of the thallus, the spores. In *R. hemispherica* the andræcia are medial on the thallus; in the other two species the andræcia become divided and laterally displaced. The spores of *R. Charrieri* are smaller than those of the other two species, and are much less conspicuously winged or crested; also the plant is reduced in all its organs, and the lobes of the capitulum are but 2–4 (as against 4–8 in the other two species).

A. G.

Ptilidium pulcherrimum.—J. ROSS (*Essex Naturalist*, 1918, **18**, 187–9). The author records the occurrence of the hepatic *Ptilidium pulcherrimum* in Epping Forest, and describes the conditions under which it is found, and the mosses, etc., with which it is associated.

A. G.

New Lejeunea from Bermuda and the West Indies.—ALEXANDER W. EVANS (*Bull. Torrey Bot. Club*, 1917, **44**, 525-28, 1 pl.). The author describes *Lejeunea minutiloba*, a new hepatic species which is not uncommon in the West Indies. He discusses briefly its morphology and structure. A. G.

Archegonium of Sphagnum squarrosum.—E. MELIN (*Svensk Bot. Tidskr.*, 1916, **10**, 289-311, 6 figs. See also *Bot. Centralbl.*, 1917, **135**, 331-332). The author writes on the archegonia of *Sphagnum squarrosum*, and states that archegonia are not at all uncommon in *Sphagnum*, especially in the dioecious species, though sporogonia are rather rare. In *S. squarrosum* archegonia were very common in the years 1911-1913. The material examined came from Noeby, near Upsala in Sweden. The number of archegonia in a fertile shoot varies according to the species, the coarser species having generally more and the delicate ones less. Growth begins in August and takes place by means of a two-edged apical cell, which cuts off segments on each side, thereby forming the massive foot of the archegonium. So soon as about seven segments have been formed, division takes place in these in the manner characteristic of all moss archegonia, which is here described in detail. As regards development the *Sphagnum* archegonium holds a position between that of mosses and liverworts. The number of canal-cells varies, according to the species, from ten to twenty. Specially interesting is the behaviour of the central cell, which divides into such similar cells that the author designates them both egg-cells, as well as their daughter-cells when they divide. Immediately before fertilization one of the egg-cells degenerates (not always the same one), which points to the equal physiological value of both cells. The further process of fertilization could not be followed. The position of the ventral canal-cell as a reduced egg-cell is established. E. S. G.

Collection, Taxonomy, and Ecology of the Sphagna.—J. A. WHELDOX (*Lancashire and Cheshire Naturalist*, 1917, **10**, 233-6, 253-60; 1918, **10**, 302-6, 319-24). The author gives hints as to the collection and preservation of specimens, discusses the diverse systems of classification of the species and the distinguishing characters adopted by various authors, and the variability of the plants in response to environmental conditions. The rest of the paper is devoted to the ecology of *Sphagnum* under the headings—moisture, climate, altitude, light, soil, competition and dissemination. A. G.

Moss Exchange Club.—W. INGHAM (*23rd Annual Report, York*, 1918, 201-81). A list of the mosses and hepatics gathered by and distributed among the members of the club, with critical notes by the referees upon many of the specimens. In an appendix are given a number of corrections and additions to the "Synopsis of the European Sphagna" recently issued by the Club. A. G.

Rhacomitrium in North America.—T. C. FRYE (*Bryologist*, 1917, **20**, 91-98; 1918, **21**, 1-16). An account of the Rhacomitriums of Western North America, with clear descriptions of the fourteen species,

figures of their habit and structure, and analytical keys. The author reduces the superfluous species to synonymy, and clears away the confusion previously existing.

A. G.

Ptychomitrium subcrispatum Thér. & P. de la V.—R. POTIER DE LA VARDE (*Rev. Génér. de Botanique*, 1918, **30**, 65-69, 1 pl.). A description of *Ptychomitrium subcrispatum*, a new species of moss gathered in Natal by H. A. Wager, with a careful comparison of its structural characters with those of *P. crispatum* (Hook. and Grev.) Schimp., tabulated in parallel columns; and a discussion of its systematic position in the genus.

A. G.

Schistostega osmundacea.—G. T. HARRIS (*Journ. Quekett Microsc. Club*, 1918, **13**, 361-74, 2 pls. and figs.) An account of the luminous moss, *Schistostega osmundacea*, giving its history, distribution, peculiar habitat (in granite crevices facing north), degree of luminosity, reproduction by means of deciduous capsules and by abundant gemmæ (previously unrecorded), structure of the protonema with its light-cells and flask-cells. The flask-cells are the stalk-cells which have borne gemmæ. These and the light-cells are described in some detail, as also are the chloroplasts and their grouping into rosettes for the maximum photosynthetic effect. An explanation is given of the peculiar luminous glow of the protonema by means of the refractive properties of the obconical light-cells.

A. G.

Splachnaceæ.—R. TIMM (*Verh. naturw. Ver. Hamburg*, 1916, **23**, pp. lxxxvi-lxxxviii. See also *Bot. Centralbl.*, 1917, **135**, 332). The author writes on Splachnaceæ. The spores are sticky and are distributed by insects—manure-flies in the case of *Splachnum*, blow-flies in *Tetraplodon*. *S. ampullaceum* was first recorded from Winterhude, near Hamburg, in 1824, and since then has been often found on cow-dung. *Tetraplodon muioïdes* has been found twice in this century near Hamburg, and was seen to be visited by blow-flies.

E. S. G.

Bryophyta of the Vega Expedition.—H. W. ARNELL (*Arkiv. f. Botanik*, 1917, **15**, 1-111. See also *Bot. Centralbl.*, 1917, **135**, 232-34). A report on the mosses and hepatics collected by F. R. Kjellman on the north and east coasts of Asia and on Alaska during the Swedish Expedition of 1878-80. In the same report are included the collections made at Waigatch, Nova Zembla, and the Samoyed Peninsula during the earlier Swedish Expedition in 1875 to the mouth of the Yenesei river. The author divides the area into three geographical regions, and treats of the Bryophyta found in each:—(1) Nova Zembla; (2) the Siberian Ice-sea coast near Behring Strait, and north of the Arctic Circle; (3) the coasts of Behring Sea, Siberia on the one hand and Alaska on the other. Five species and six varieties are new to science; thirteen new records for Siberia are noted, and twelve for Nova Zembla which do not occur in Siberia. Much information is given in the critical notes.

E. S. G.

On *Schistostega osmundacea* Mohr. (*Journ. Q.M.C.*, April 1918, ser. 2, 13, 361-74, pls. 23-4).—This moss appears to be widely distributed in the British Isles, and from his observations, which were made on Dartmoor, G. T. HARRIS is led to infer that the moss prefers a habitat with a northerly aspect, and apparently thrives best in granitic areas. The luminous appearance of the moss is due, as was pointed out by Noll in 1887, to certain protonemal cells, which are so constructed that light rays falling upon them are refracted through the transparent sap and concentrated upon the chloroplasts which are grouped at the base of the cell. The light rays are internally reflected from the basal wall of the cell and again emitted. The fruit appears to be somewhat rare, though when fertile the capsules are often produced in abundance. The distribution of the plant is aided by the deciduous spore-capsule and by an abundance of geminae formed by the protonema, especially when barren conditions of the plant prevail. A. W. S.

Thallophyta.

Algæ.

(By MRS. ETHEL S. GEPP.)

Rhizopodial Development of the Flagellatæ. I. Some Rhizopodial Chrysomonads with Chromatophores.—A. PASCHER (*Archiv. Protistenk.*, 1916, 36, 81-117, 2 pls., 14 figs. See also *Bot. Centralbl.*, 1917, 135, 166). The author regards almost all series of coloured Flagellatæ as falling into his scheme of two groups:—1. Rhizopod organization, characterized by animal nutrition. 2. Cellular organization (Algæ), characterized by holophytic nutrition. A development of entirely rhizopodial organizations out of a series of holophytic Flagellatæ is taking or has taken place. The rhizopodial form is no characteristic of primitive organization. Three new genera and species of rhizopodial Chrysomonads, belonging to the Rhizochrysidinæ—namely, *Rhizaster crinoides*, *Chrysoerinus hydra*, *Chrysotilakion vorax*—are described and figured. E. S. G.

Rhizopodial Development of the Flagellatæ. II. *Dinamœba varians*—a Novelty with Dinoflagella-like Swimmers.—A. PASCHER (*Archiv. Protistenk.*, 1916, 36, 118-36, 1 pl., 4 figs. See also *Bot. Centralbl.*, 1917, 135, 167). A description of the new form and a comparison of its developmental cycle with that of *Cystodinium*. The Dinoflagellatæ are divided into: 1. Rhizodinianæ (including *Dinamœba*) with rhizopodial organization and animal nutrition. 2. Dinophyceæ, with cellular organization and holophytic mode of life, and comprising Dinocapsales, Dinococcales, Dinotrichales. E. S. G.

Rhizopodial Development of the Flagellatæ. III. Rhizopodial Nets as Capturing-apparatus in a Plasmodial Chrysomonad.—A. PASCHER (*Archiv. Protistenk.*, 1916, 38, 15-30, 2 pls., 6 figs. See also *Bot. Centralbl.*, 1917, 135, 167). *Chrysarachnion insidians*, a new genus and species, belongs to the Rhizochrysidinæ, being a permanently rhizopodial Chrysomonad. Whilst *Chrysidiastrum* Lautb. has chain-like filar plasmodia, *Chrysarachnion* has flattish nets. In both of them

the rhizopodia are developed in the equatorial plane of the cell, which itself is flattened-ellipsoidal to flat in form. But this circumstance is certainly secondary, and seems to be an arrangement often realized, for in consequence the cells can be grouped in one plane. The animal food is caught in the net, but is also digested, constituting a high order of apparatus. *Chrysarachnion* is oligotherm, and apparently is confined to cold mountain-tarns.

E. S. G.

Rhizopodial Development of the Flagellatæ. IV. Fusion-plasmodia in Flagellatæ, and their Significance in the Descent of Rhizopods from Flagellatæ.—A. PASCHER (*Archiv. Protistenk.*, 1916, **38**, 31-64, 3 pls., 20 figs. See also *Bot. Centralbl.*, 1917, **135**, 167-8). *Myxochrysis* seldom develops swarmers; it can also produce descendants which have so far lost the characters of Flagellatæ—namely, chromatophores, characteristic cysts, special assimilation-products—as to be no longer recognisable and to stand isolated. Rhizopodial formation is a secondary acquisition, and the Rhizopods are derived forms, adapted to an animal nutrition.

E. S. G.

Microplankton of Plymouth Sound.—MARIE V. LÉBOUR (*Journ. Marine Biolog. Assoc. Plymouth*, 1917, **11**, 133-182, 2 tables and figs.). Here are the results of a year's constant study of the microplankton of Plymouth Sound from the region beyond the breakwater. Both the flora and fauna were studied from samples collected every fortnight. Besides the usual tow-nettings, water samples were taken, centrifuged and examined; and thus several minute organisms, which escape through the meshes of the finest silk nets, were added to the records. A systematic list of the organisms is given, and includes seventy-four diatoms. This is followed by a survey of the plankton in each month, by the weather records, and by two tables showing (1) the average number and relative abundance of each species in each week; (2) the average number of Diatomaceæ and Peridinales in 1 c.cm. for each month.

A. G.

Peridinales of Plymouth Sound.—MARIE V. LÉBOUR (*Journ. Marine Biolog. Assoc. Plymouth*, 1917, **11**, 183-200, 14 figs.). A list including all the Peridinales identified in the plankton captured throughout a year from September 1915 to September 1916. New and rare species of Gymmodiniaceæ are described and figured. In all sixty species are recorded: five of *Gymmodinium*, two of *Spirodinium*, and one of *Cochlodinium* are new; and twenty-eight are new records for the Plymouth area.

A. G.

Nuclear Division in *Euglena viridis*.—B. TSCHENZOFF (*Archiv. Protistenk.*, 1916, **36**, 137-173, 2 plates and figs. See also *Bot. Centralbl.*, 1917, **135**, 148). In *Euglena viridis*, the splitting of the chromosomes takes place in the anaphase or telophase of the previous division. The split chromosomes preserve their individuality throughout the resting nucleus up to the metaphase, when they arrange themselves in pairs and then move off separately. Nuclear division in *Euglena* follows none of the twelve types of the primitive mitoses for protozoa-nuclei given by Alexeieff.

E. S. G.

Nuclear Division in *Chlorogonium elongatum*.—M. HARTMANN (*Sitz.-ber. Ges. naturf. Freunde Berlin*, 1916, 9, 347-51, 20 figs. See also *Bot. Centralbl.*, 1917, 135, 154). The nuclear division of *Chlorogonium elongatum* is as follows:—The organism is slender, spindle-shaped, and has a green chromatophore, with one pyrenoid before and behind the nucleus. At the front end arise two cilia of equal length. The nuclei are typical centronuclei with intranuclear mitosis. The generative nuclear material in the resting nucleus is permanently situated in the external portion; only in the telophase may it be temporarily united with the inner bodies. The locomotor-material is not as a rule to be traced in the resting nucleus, though Dangeard holds that the centriol is here also closely adjacent to the nuclear membrane, as is found in other protozoa and algæ. The course of division reveals the presence of both nuclear components. E. S. G.

Fresh-water Algæ of the Austrian Coast Districts.—B. SCHUSSNIG (*Oesterr. bot. Zeitschr.*, 1915, 65, 248-52, fig. See also *Bot. Centralbl.*, 1917, 135, 246). *Plectonema radiosum* (Sch.) was found thickly covered with *Chamæsiaphon incrustans* Grun. at Gradisca. The forms of *Stigeoclonium* are so numerous as barely to merit names. *S. longipilum* Kütz. shows constantly the following mode of growth: The young germinating plants grow in spring on the filaments of a *Cladophora*, which is already growing luxuriantly. In July that dies down, and the *Stigeoclonium* plantlets cover the stones, which had served as substratum for the *Cladophora*, with a light-green velvety growth. A new species of *Ulothrix* was found. E. S. G.

Marine Diatoms from the Coasts of Iceland.—E. OESTRUP (*The Botany of Iceland, edited by L. K. Rosenvinge and E. Warming, Copenhagen*, 1916, 345-94, 1 pl.) The examination of 438 samples of material yielded a list of 209 species and varieties, arranged systematically in 42 genera. Seven new species and four varieties are described and figured. In an alphabetical table the distribution of each species is displayed in parallel columns—(a) throughout the world; (b) in Greenland and the Arctic Ocean; (c) on the coast of Iceland. Further tables show the frequency of occurrence; also the genera and species that were found to be associated with several of the larger algæ—Rhodophyceæ, Phæophyceæ, and Chlorophyceæ. A. G.

The Quality of "Asakusanori."—Y. OKUDA and S. NAKAYAMA (*Journ. Coll. Agric. Imp. Univ. Tokyo*, 1916, 5, 339-340). The ancient Japanese food "Asakusanori" or "Hoshinori" is prepared from the alga *Porphyra tenera* Kjellm. by drying, and is widely consumed. It resembles black paper. The authors give a chemical analysis of it, and find that the superior samples contain more nitrogen, mostly in an assimilable form. A. G.

Relation between the Chemical Constituents of "Asakusanori" and its Quality.—H. MATSUI (*Journ. Coll. Agric. Imp. Univ. Tokyo*, 1916, 5, 391-393). The author discusses the chemical analysis of "Asakusanori" prepared from *Porphyra luciniata*, and states that the

quality of this food depends upon the conditions of its place of growth and upon the albuminous constituents. Superior samples come from waters that are rich in matters nutritious to algæ—for instance, where fields border the main current of a river. Such samples contain more nitrogen (of various forms), carbohydrate and fat, and less fibre, and command a higher price in the market.
A. G.

Iodine in Marine Algæ.—Y. OKUDA and P. ETO (*Journ. Coll. Agric. Imp. Univ. Tokyo*, 1916, 5, 341-353. See also *Bot. Centralbl.*, 1917, 135, 251-252). An investigation of the form in which iodine occurs in certain species of *Ecklonia*, *Turbinaria*, *Sargassum*. In living algæ most of the iodine is in organic combination (not a protein) which is soluble in water, strong alcohol, dilute alkali and acid solutions. But in "Dashikombu" (a *Laminaria* product) most of the iodine is inorganic. In *Ecklonia bicyclis* the organic iodine is gradually disintegrated by micro-organisms. Dilute solutions of NaCl, CaCl, and HCl have a strong effect on the decomposition of the organic iodine. Old algæ contain more iodine than the young. Algæ of the open sea contain more than those of the inland sea. From dead algæ the iodine readily diffuses in salt or fresh water; hence drifted algæ are not a profitable source of iodine.
A. G.

Marine Algæ of Cuba.—MARSHALL A. HOWE (*Smithsonian Miscell. Collections, Washington*, 1918, 68, No. 11, 13 pp., fig.). An account of the marine algæ collected by J. B. Henderson and P. Bartsch during the cruise of the "Tomas Barrera" on the west coast of Cuba in 1914, comprising sixty-five species, one of which is new (*Phormidium Hendersonii*), and one (*Sarcomenia filamentosa*) had been but once collected (in Florida). The only previous lists of Cuban marine algæ were one by Montagne in Ramon de la Sagra's "Histoire . . . de l'île de Cuba," 1842, with fifty-two species; and one by Farlow in *Amer. Naturalist*, 1871, 5, 201-9, with forty-six species. The present list adds thirty-seven species and a variety to the flora.
A. G.

Fungi.

(By A. LORRAIN SMITH, F.L.S.)

North American Peronosporales.—G. W. WILSON (*Mycologia*, 1918, 10, 168-9). An account of three species of Peronosporales, one of them, *Rysotheca (Plasmopora) Acalyphæ*, being new to science.
A. L. S.

Development of Phytophthora.—J. ERIKSSON (*Rev. Génér. de Bot.*, 1917, 20, 257 et seq.) In a series of papers J. Eriksson has discussed the problem of the overwintering and recurrence of potato disease. He gives an account of all the research undertaken and the theories held. He himself inclines to regard the "sclerotiets" of Wilson as of importance, and with these proposes his theory of mycoplasma. The discussion is still unfinished.
A. L. S.

Parasites on Meliola.—F. L. STEVENS (*Bot. Gazette*, 1918, 65 227-49, 2 pls., 5 figs.) has detected a very large number of these, and

has published descriptions of them. The material all came from Porto Rico. The parasitic fungi include one Ascomycete, a number of Pyrenomycetes (more especially Hypocreaceæ), some Sphærospidæ, and a varied series of Hyphomycetes. Two new genera are described: *Isthmospora*, a genus of Dematiaceæ, with two species; and *Grallomyces*, with a peculiar dark brown mycelium. No spores or conidiophores of the latter were seen, and it is the only fungus recorded in the paper that is not a parasite; it is associated with *Meliola*, but grows on any leaf in suitable conditions.

A. L. S.

South African Perisporiales.—ETHEL M. DOIDGE (*Trans. Roy. Soc. S. Africa*, 1917, 5, 713-750, 10 pl.) gives a full and systematic account of these fungi as contained in the South African Union Mycological Herbarium at Pretoria. There are nine genera, most of them with very few species. *Meliola* is represented by thirty-two species out of forty-five for the group, and seventeen of the species described are new to science. A host index is supplied, and the paper is well illustrated.

A. L. S.

Development of Cryptomyces Pteridis.—KARL KILLIAN (*Zeitschr. Bot.*, 1918, 10, 49-126, 31 figs.) presents his elaborate study of this Bracken fungus. He describes the effects produced on the host-plants and the physiological reasons for the rolling up of the leaves under the influence of the parasite. He then gives an account of the fungus itself from spore to spore. The attempt to induce germination of the ascus spores on artificial media failed, but they were found in the very early stages of attack on young *Pteris* plants; it was observed that penetration of the hosts by the hyphæ occurred only through the stomata. During the summer a conidial form (Sphærospidæ) is freely produced, towards winter the ascus fruit is formed; the formation and development of this stage are fully described; copulation between two cells of neighbouring hyphæ in the ascogonium was observed; aerial hyphæ projected above the surface of the leaf resembling trichogynes, but they were wholly vegetative. The further stages of nuclear fusion and ascus formation are also described. Finally, the author discusses biological and affinity questions.

A. L. S.

Sexuality in Rhizina undulata.—H. M. FITZPATRICK (*Bot. Gaz.*, 1918, 65, 201-26, 2 pls.) publishes results of his cytological study of this Ascomycete. Certain hyphæ near the centre of the ascocarp became transformed at a very early stage into archicarps. As many as eight archicarps may arise. The hyphæ of the archicarp are multinucleate, as are the vegetative hyphæ, but the nuclei of the former increase greatly by division and the cells become opaque. The terminal cell is small, and, at maturity, shows disorganized protoplasmic contents. It has from analogy been termed a trichogyne, but it does not function as such. As the archicarp matures a pore arises between the cells; those at the centre produce ascogenous hyphæ and the contents of the various cells press into them. The nuclei are paired; finally crozier formation takes place and fusion occurs in the young ascus.

A. L. S.

Sphæronema fimbriatum.—S. G. LEHMAN (*Mycologia*, 1918, **10**, 155-63, 1 pl.) gives the development of this fungus as observed in cultures. It produces two kinds of conidia, and their formation is contrasted with the development of similar bodies in *Thielavia*. The peculiar conidia which originate within the hyphæ and emerge from the open end are at first endoconidia, but those produced subsequently are not endoconidia.

A. L. S.

Uredineæ.—G. FILIPPO GRAVATT and G. B. POSEY (*Journ. Agric. Research*, 1918, **12**, 459-62), in discussing the wide-spread distribution of the white pine blister-rust, *Cronartium ribicola*, indicate the part played by the larvæ of the gypsy-moth in spreading the disease. They feed on the *Peridermium* stage, and their bodies become covered with the æcidiospores. It has been shown that a high wind may carry these moths twenty miles; they subsequently feed on the foliage of wild and cultivated species of *Ribes*, and in some cases the only infected leaves of *Ribes* are those showing insect injury.

J. C. ARTHUR (*Mycologia*, 1918, **10**, 111-54) publishes an account of the Uredinales of Costa Rica, mostly from the collection of E. W. D. Holway. A description of the territory is given. The list comprises 188 species; twenty-two of these are new to science. Species and host indexes are provided.

G. FRAGOSO (*Bol. Hist. Nat.*, 1918, **18**, 94-6) publishes a list of twenty-five species collected in Cataluna. Several are new to the Spanish flora, others are new to Cataluna. The habitat and date of collection are recorded.

E. C. STAKMAN and G. R. HOERNER (*Phytopathology*, 1918, **8**, 141-9) have published a paper dealing with the occurrence of *Puccinia graminis tritici-compacti* in the southern United States, in south-east Texas, Louisiana, and Alabama. It was first detected on club-wheat and grasses in the Pacific north-west districts. It has now been found in the south on wheat. As a number of club-wheats and some soft wheats of the *Vulgare* group are congenial hosts, their susceptibility, it is surmised, may be due to softness. The geographical limits of this biologic form are still imperfectly known.

J. S. BOYCE (*Phytopathology*, 1918, **8**, 161-2) describes a new form of hypertrophy on Incense Cedar caused by *Gymnosporangium blasdaleanum*. It is in the form of a spindle-shaped swelling on the branches and trunks. The mycelium within these swellings forms small brown flecks; it is purely vegetative, and is presumably very long-lived.

The full life-cycle of tropical Uredines has been worked out by H. E. THOMAS (*Phytopathology*, 1918, **8**, 163-4). Æcidial spores of *Æcidium tubulosum* on *Solanum torvum* successfully infected *Paspalum paniculatum*, producing the teleutospores of *Puccinia substrata*, while *Æcidium passifloricola* produced *Puccinia Scleriæ* on *Scleria pterota*.

A. L. S.

Smuts of Cereals.—Leaflet No. 31 (*Journ. Board Agric.*, 1918, **24**, 1417-19) issued by the Food Production Office, deals with "Smuts in Oats and Barley." In it are described the different kinds of smut, the dissemination of the spores, and the most effective means for prevent-

ing contamination of the new crops. Infection takes place while the cereals are in the seedling stage, but the disease is not evident until the time of grain formation. Covered smuts of barley and loose smuts of oats may be killed out by steeping the seed-grains in formalin or copper sulphate, concerning which instructions are given. Loose smut of barley is more difficult to deal with, as the fungus is embedded in the embryo, but this type can be countered by the hot-water treatment, which is also explained.

A. L. S.

Hymenomyces.—E. T. HARPER (*Mycologia*, 1918, **10**, 53-7, 3 pls.) has published a descriptive account of American species of the "*Clavaria fistulosa*" group. They are composed of hollow upright clubs mainly unbranched.

W. A. MURRILL (*Mycologia*, 1918, **10**, 62-85) completes his survey of Tropical North America Agaricaceæ, taking account of eight different genera. The plants were collected in the West Indian Islands, Mexico, etc. A number of species are new to science.

GERTRUDE S. BURLINGHAM gives diagnostic descriptions of four new species of *Russula* collected in Massachusetts. One grew in a swamp, the others under trees.

W. A. MURRILL (*Mycologia*, 1918, **10**, 107-110, 1 pl.) publishes a coloured plate and descriptions of a series of woody fungi, *Polyporus*, *Trametes* and *Dædalea*. Most of the species described are common on dead timber.

A. L. S.

Study of Tricholoma.—L. MAIRE (*Rev. Génér. Bot.*, 1917, **29**, 350-1) has issued a synthetic study of this genus. He gives an account of the limits of the genus, its affinity with other genera, and the variations of form included therein. He has placed in *Tricholoma* a number of species hitherto regarded as *Collybiæ*. The notice of the work is published by Léon Dufour.

A. L. S.

Cultures of Wood-rotting Fungi on Artificial Media.—W. H. LONG and R. M. HARSCH (*Journ. Agric. Research*, 1918, **12**, 33-82) had two objects in view in undertaking this work: (1) a method by which various wood-rotting fungi might be identifiable by cultures, and (2) a method by which sporophores might be induced to form, as these are undeveloped very often in diseased timber. The paper published is only a preliminary one. They found that the macroscopic characters of value in determination by cultures were, among others, rapidity of growth, colour of mycelium, texture of the aerial mycelium, colour effects on the medium, and comparative rate of growth between aerial and submerged mycelium; the microscopic characters included septation, branching, clamp connexion, size and colour of hyphæ, with spore polymorphism. The data acquired are set forth in a series of tables. External factors, such as light and culture medium, are discussed.

A. L. S.

Honey-dew Fungi.—F. W. NEGER (*Flora*, 1917, **10**, 67-139, 31 figs.) gives a study of the dark-coloured epiphytic fungi that live on the honey-dew of various leaves—lime, oak, etc. Generally they are

classified under *Fumago vagans* or *Capnodium salicinum*, but Neger has demonstrated by artificial cultures that quite a large number of fungi, such as species of *Dematiium*, *Cladosporium*, *Atichia*, *Gyroceras*, etc., live on the honey-dew. All of the honey-dew forms are distinguished by the gelatinous nature of their cell-walls, which imbibe water readily and thus provide protection against prolonged drought. The fungi are so mixed up on the leaves, and have so many formations in common, that they can only be disentangled and classified by pure cultures. A. L. S.

Mycological Notes.—Three separate parts of the above notes by C. G. LLOYD (Cincinnati, Ohio, 1917-18, 717-64, 74 figs.) have come to hand. On the frontispiece of each there is a photograph of Frank H. Ames, P. A. Saccardo, and Johannes Rich respectively, with a biographical note appended in reference to each of these distinguished mycologists. The author describes and criticizes a large and varied number of the larger fungi which he has received from many parts of the world. The illustrations as usual are copious and instructive.

A. L. S.

New or Rare Fungi.—R. G. FRAGOSO (*Bol. Hist. Nat.*, 1918, 18, 78-85) has published a paper on microfungi from Persia. They were found on Phanerogams in the collection made by D. Fernando, which had been determined by Carlos Pan. Most of them are parasites, and a considerable number are new species.

A. L. S.

Diseases of Plants.—TYOZABURO TANAKA (*Mycologia*, 1918, 10, 86-92) describes a number of new microfungi which have been found to be injuring their host-plants. A *Valsa* on *Paulownia* is analogous to chestnut disease in America, and threatens a loss of valuable timber.

ARTHUR S. RHOALES (*Phytopathology*, 1918, 10, 86-92) continues his account of some unusual hosts of wood-destroying fungi. Thus, he records *Schizophyllum commune* on *Pinus virginiana*. On *Gingko biloba* he found *Polyporus versicolor* and *P. hirsutus*. Several other hosts and parasites are given.

A. L. S.

Description and Treatment of Plant Diseases.—A. D. COTTON and OTHERS (*Board of Agriculture and Fisheries Leaflets*). New editions of a number of leaflets have been issued lately embodying new information on the subjects treated, and especially new methods of control. They are:—No. 39, **The Control of Pests of Fruit-trees in Gardens and small Orchards**; No. 77, **Finger-and-Toe in Turnips**; No. 131, **Apple and Pear Scab**; No. 164, **Potato-leaf Curl**; No. 193, **Dry-rot of Potatoes**; No. 204, **Apple Mildew**; No. 262, **Tomato-leaf Rust**; No. 312, **The "Blossom-wilt and Canker" Disease of Apple-trees**. The diseases treated therein are all due to parasitic fungi, and they have been popularly described and well illustrated; great attention is given to the means employed to combat the pests. To each leaflet is appended the statement that: "*Copies of this leaflet may be obtained, free of charge and post free, on application to the Secretary, Board of Agriculture and Fisheries, 3, St. James's-square, London, S.W.1. Letters of application so addressed need not be stamped.*"

A. L. S.

A Text-book of Mycology and Plant Pathology. By John W. Harshberger. 779 pp., 271 illustrations. London: J. and A. Churchill. 1918. Price 15s. net.

There is no branch of botanical study in which progress has been so marked in recent years as in Mycology. Whether it be in the more exact descriptions of the many forms with their complicated life-histories, in the cytology of the various groups, or in the relations of fungi to other organisms, knowledge has advanced and the records of successful research have increased in every section of the science. There is, therefore, a constantly renewed demand for trustworthy text-books that will collate the facts and present them in readable form, as has been done in the present volume. In writing the text-book Dr. Harshberger has drawn on his long experience as student and Professor of Mycology, and has given us a work full of the most helpful guidance to a complicated and difficult subject.

The book has been divided into four parts:—I. Mycology. II. General Plant Pathology. III. Special Plant Pathology. IV. Laboratory Exercises. There are, in addition, a series of appendices dealing with special aspects of some particular branch of the study. Under "Mycology" the more purely scientific side is dealt with—the nature of fungi and the arrangement of the various groups. With them the author includes an account of *Bacteria* and of Slime-moulds. These latter, the Mycetozoa or Myxomycetes, are frequently classified as animals; but earlier botanists unhesitatingly grouped them with fungi, and it is mainly fungologists who now carry on the study of these organisms. Their presence in a book on fungi is further justified as with them are closely associated *Plasmodiophora* and *Spongospora*, both virulent diseases of plants that find their way into most text-books as fungus diseases; *Spongospora* is, however, omitted from Harshberger's volume. *Bacteria* figure so largely as causing disease in plants that no book on the subject is complete that does not take account of their depredations. In considering the more obvious or "true" fungi, Harshberger gives much useful information on their histology, chemistry, and general physiology; finally, an outline of the classification is provided.

Part I. occupies almost a third of the whole volume; the remaining two-thirds are devoted to Plant Pathology. All the causes that foster disease are considered, whether due to climate, soil, or parasite; attention is also given to abnormalities, and a welcome feature of the book is the glossary of teratological terms. We would note in passing the excessive number of new terms with which almost the whole book bristles; fortunately for the reader, an explanation is generally forthcoming in the text. Special chapters on pathologic plant anatomy describe the changes induced in the various plant tissues by the intrusion of the parasite, resulting frequently in the formation of galls, witches' brooms, etc.

Part III. deals more especially with specific diseases due to fungoid attack. Lists of these are given under the different hosts, arranged in alphabetical order. The diseases are those prevalent in the United States, but many of them are common to this country, and any one

might be introduced. An example of importation is afforded by the recently-discovered onion smut, which has been known as a bad disease in the States for fifty years, but has only now appeared in England. It is somewhat disappointing to find only a few diseases fully described, but no single volume could contain all that one wants to know.

The "Laboratory Exercises" should prove very helpful to student and teacher alike. Good technique and the proper use of instruments are of great value in research work, and gratitude is due to the writer who thus places the results of his experience at the disposal of others. In the appendices there is detailed information on aspects of plant pathology that supplements the main body of the work. They indicate the methods of treating special classes of fungi.

We cordially recommend Harshberger's text-book to mycological students; they will find much to interest and instruct, probably also something with which they will disagree. The author is apt to dogmatize on subjects such as cytology and symbiosis, which are still debated points.

A. L. S.

MICROSCOPY.

A. Instruments, Accessories, etc.*

(3) Illuminating and other Apparatus.

Polarization and Color Effects exhibited by certain Diatoms.— F. J. KEELEY (*Proc. Acad. Nat. Sci. Philadelphia*, 1918, 69, 334-8). The author discusses E. M. Nelson's paper reprinted (p. 340) in the Society's Journal for June, 1917, in which Nelson suggests that "it may be that silex deposited by animals does not exhibit polariscope effects, while that deposited by plants, such as diatoms, will do so." The author considers that the existence of the innumerable surfaces, in diatoms and other minute silicious organisms capable of reflecting light, amply account for the polarizing effects, and that, when suitably illuminated, all diatoms, radiolaria, sponge spicules, powdered glass, or even the surface of a ground-glass plate, will show bright polarization, provided they are mounted dry or in a medium of high refractive index, such as realgar. When in balsam, or other media approximating to their own index, the reflections are nearly or quite eliminated, and most such objects become invisible. Nelson, however, calls attention to the interesting fact that there are certain species of diatoms that show almost equally brilliant polarizing effects when mounted in balsam, and Keeley points out that in all these there is a secondary structure which the medium has failed to penetrate, and has thus left a number of reflecting surfaces sufficient for polarization. Among the diatoms which show by far the brightest colours by transmitted light are certain species of *Actinocyctus*, notably *ralfsii*, in which, so far as the author knew, no secondary structure had hitherto been observed. His theory led him to a special investigation, and a secondary structure was readily found to be present, and particularly visible in the central blank space and wedge-shaped radial segments between the coarser cellular structure of *A. ralfsii*. This secondary structure is exceedingly delicate, and will afford an excellent test for the definition of wide aperture objectives, though, after finding it with oil-immersion and after selecting a well-marked valve, the author was able to see it distinctly with a well-corrected water-immersion of about 1.00 N.A., and even with an exceptionally fine dry objective of slightly less aperture.

The author has also found that interesting polarizing effects can be obtained from the fine granules of a gold film on a glass surface. Such films reflect various colours according to the size of the particles, and transmit the complementary colour. The films may be obtained by means of electrical discharges from the end of a gold wire, or by deposition from solution of gold chloride in collodion. A. N. D.

* This subdivision contains (1) Stands; (2) Eye-pieces and Objectives; (3) Illuminating and other Apparatus; (4) Photomicrography; (5) Microscopical Optics and Manipulation; (6) Miscellaneous.

PROCEEDINGS OF THE SOCIETY.

AN ORDINARY MEETING

OF THE SOCIETY WAS HELD AT 20 HANOVER SQUARE, W., ON WEDNESDAY, JUNE 19TH, 1918, MR. J. E. BARNARD, PRESIDENT, IN THE CHAIR.

The Minutes of the Meeting of May 15 were read, confirmed, and signed by the President.

New Fellows.—The following were elected Ordinary Fellows of the Society :—

Major Robert Cattley, M.B., B.Sc., etc.,

Miss Annie Dixon,

Mr. Harry Godfrey Skepper,

and Lady Mary Elizabeth Bruce were elected an Honorary Fellow.

Mr. Scourfield reported that the Biological Section of the Society had paid a visit on the previous Saturday to the John Innes Horticultural Institution at Merton, and had been shown round the gardens and laboratories by Professor Bateson. Very wonderful results were being obtained there in reference to heredity, etc.

At the suggestion of the **President** the Meeting expressed its warm appreciation of Professor Bateson's kindness.

Donation.—The **President** reported that Mrs. Hebb had kindly offered the Microscope by Baker, with Polariscope and other accessories, which had been in constant use by the late Dr. Hebb. He moved from the Chair the following resolution, which was carried unanimously :—

“That a very hearty vote of thanks be accorded to Mrs. Hebb for her kindness in presenting to the Society the Microscope used by the late Dr. Hebb.”

Mr. J. M. Offord exhibited slides prepared by Mr. Waddington showing: Gnat larvæ emerging from ova; lids of ova opening; early pupating and late pupating stages of gnat larva, showing growth of the breathing-tubes at the head; gnat pupa emerging from larval case; gnat imago emerging from pupal case; *Anopheles* emerging from pupal case; *Corethra* larvæ, with inverted pharyngeal tube; species of Chironomous (?), very fine colours; *Machalonyx*, a rare gnat.

A communication by **Mr. Waddington** was read, in which he said that the *Anopheles bifurcatus*, which is a malaria-carrying mosquito, is

the only species of which the larvæ survive the winter in England, and any mosquitoes found up to about the end of May will most probably be of this species. The larvæ are fairly common in ditches near Bournemouth, and are also to be met with in rain-water tubs which contain much vegetable débris.

By May these winter larvæ have all developed. Early in June the very small larvæ of both *A. maculipennis* and *A. bifurcatus*, hatched from newly-deposited ova, are easily met with in their proper habitats.

The larvæ of the two species may be distinguished by the arrangements of the hairs on the clypeus, and the imagines by the wings of *A. maculipennis* being spotted, while the wings of *A. bifurcatus* are spotless.

As considerable interest has lately been taken in mosquitoes, he would indicate the methods he had found most successful in obtaining them. It is much easier to obtain the larvæ and to carry them through the various stages to maturity than to search for the mosquito itself.

The larvæ of *A. bifurcatus* are to be met with in ditches which contain a fair amount of water; the larvæ of *A. maculipennis* in shallow patches of water in the grass bordering the edges of country roads, and more especially in shallow pools, in shady portions of forest ground, notably in pools of the New Forest, in Hampshire.

The larvæ should be taken with a fair quantity of the water in which they are found, together with a small portion of the débris from the bottom to afford food. They may be seen at the bottom of the bottle containing them feeding voraciously.

The larvæ should be kept in wide-mouthed glass jars, without any covering, quite in the open, where they can get a little of the very early morning sun and are fully exposed to external conditions of wind and rain.

If the larvæ are kept inside the house they rapidly die off. They should be watched daily until they pupate, the pupæ as they form being removed into another jar of the original water, by a glass tube. They require no food. The jar containing them should be tied over with a piece of coarse muslin to prevent the escape of the mosquitoes after they have emerged. By this method of full exposure to external conditions nearly every larva may be developed.

Sufficient importance has not been given to *A. bifurcatus*, which is certainly the earliest to appear, and in some places, such as Bournemouth, is quite as prevalent as the more frequently quoted *A. maculipennis*.

The Society's thanks were accorded to Mr. Waddington.

Professor Benjamin Moore, F.R.S., read a paper on "Studies of Activity of Light in Inorganic and Organic Systems." The author gave a *diseuse* illustrated by experiments. The chief points dealt with were:—1. The natural modes of production of reduced organic compounds, with uptake of energy. 2. The synthesis of formaldehyde from carbon-dioxide and water by the action of light. 3. Condensation of formaldehyde in light to form reducing substances, such as sugars. 4. Reduction of nitrates by sunlight, accompanied by energy absorption. 5. Growths of organisms in nitrate and nitrite-free media in presence

and absence of air, showing that nitrites in air are essential, and that nitrogen fixation in soil is probably due to nitrite fixation from the atmosphere.

The President said that while the communication that Professor Moore had made to them was not on the face of it precisely microscopical, yet in all its bearings it touched the roots of all microscopical problems. He had listened to all he had had to say with very great interest. It had a bearing on so many vital processes. His own interest was in the direction of the action of light on micro-organisms. The hint that was thrown out as to the formation of formaldehyde being at the bottom of the bacteriocidal action of light was very suggestive. It opened up a very simple explanation of what was supposed to be a complex biological problem.

Mr. Blood suggested that the patterns on diatoms might have similar results, forming diffraction gratings, and affecting the quality of the light passing through.

The Meeting accorded a vote of thanks to Professor Moore for his paper and accompanying experiments.

In acknowledging the vote of thanks, Professor Moore referred to the germicidal action of light. Fungi growing in direct sunlight had to cover themselves with pigments in order to protect themselves from the light. Green leaves formed a light shade keeping the dangerous colour-rays off. The green in the leaf was simply keeping the wrong sort of light off the mechanism underneath. The colour-shades letting different wave-lengths of lights through and the colours of flowers might be associated with photo-synthetic phenomena in the petals of flowers connected with the sexual processes going on underneath.

The paper will appear in the pages of the Journal.

Mr. E. Heron-Allen, F.L.S., F.G.S., F.Z.S., and Mr. A. Earland gave a lantern demonstration showing photomicrographs, taken by Mr. Pledge, of "Diatom Ooze from Deep Antarctic Waters," as dredged at the "Challenger" Station 215, off the Great Ice Barrier, 63° 59' S., 174° 13' W., from a depth of 1801 fathoms.

The Society's thanks were accorded to Mr. Heron-Allen and Mr. Earland.

Mr. D. J. Scourfield, F.Z.S., read a communication by Dr. E. Penard, "A new type of Infusorian, *Arachnidiopsis paratona*." The organism described, egg-shaped and about $\frac{1}{300}$ in. in length, has neither cilia nor setæ, but its locomotive organs consist of two flexible tentacula which beat the water with great rapidity. The forms described under the genus *Arachnidium* by Saville Kent were possibly of the same type.

The communication appears on pp. 283-289 of the Journal.

The Society's thanks were accorded to Dr. Penard.

The President announced that the next Meeting would be held on October 16.

BRITISH DYES

LIMITED

Manufacturers
of

ACID	COLOURS
BASIC	COLOURS
CHROME	COLOURS
DIRECT COTTON	COLOURS
OIL	COLOURS
SPIRIT	COLOURS
SULPHUR	COLOURS
UNION	COLOURS
VAT	COLOURS

FOR

ALL PURPOSES

HUDDERSFIELD

JOURNAL
OF THE
ROYAL MICROSCOPICAL SOCIETY.

DECEMBER, 1918.

TRANSACTIONS OF THE SOCIETY.

XII.—*An Improved Method of Apertometry.*

By H. HARTRIDGE, M.A., M.D., F.R.M.S., Fellow of King's
College, Cambridge.

(Read December 18, 1918.)

FOUR TEXT-FIGS.

INACCURACY in apertometry is found to be due to the following causes :—

1. The use of inaccurate focus or incorrect tube length.
2. The use of rays not strictly corresponding to the centre of the field.
3. The incorrect setting of the indices.
4. The incorrect determination of the position of the indices in relationship to the graduated scale ; and inaccuracy in the graduated scale itself.
5. Employment of an incorrect angle between the plane of the apertometer plate and the optical axis.
6. Chromatic aberration.
7. The employment of methods based on the measurement of the Ramsden disc.

SECTION 1.—ERROR IN APERTOMETRY DUE TO THE USE OF
INACCURATE FOCUS OR INCORRECT TUBE LENGTH.

The graduation of the scale of the Abbé apertometer is carried out on the supposition that the segments illuminated by rays proceeding to the periphery of the disc have their apices in

correspondence with the optical centre of the glass disc. The edges of the silvered strips lying under the cover slip should therefore be sharply focused.

The adjustment of tube length is necessary, because it is found by experiment that aperture varies with tube length, particularly with lenses of long focal length.

Further, the focusing of the objective should be carried out by rays corresponding to the peripheral zone of the objective only; since it is these rays which are concerned when the aperture is measured, and since other rays, if spherical aberration be present, will come to a different focus. This limitation to peripheral rays may be performed by the employment of an annular post objective stop. (A Travis expanding stop is admirable for this purpose). (8).^{*} A further advantage would appear to be given by this method in cases where residual spherical aberration exists in the outer zone, since the same focusing adjustment would be employed in making the measurement of N.A. as that used when structure of the utmost fineness that the objective will resolve is under examination. The tube length being correctly adjusted, and the post objective annular stop being in place, the objective is carefully focused. The image will in general be a very poor one compared to that usually obtained, because of the aberrations which are usually found in the peripheral zones of most objectives. In spite of this, however, precision of focus is as a rule considerable, because of the large angle between the rays forming the image.

In the ordinary technique with the Abbé plate when the microscope has been focused the eye-piece is removed, and one or other of two methods employed:—

(A) A special objective (supplied with the Abbé apertometer) is screwed to the lower end of the draw tube so that a magnified image of the back lens of the objective is seen in the eye-piece. (B) The eye is placed over the draw tube and the back lens examined direct. Both methods are faulty. The first in that the aperture attached to the brass tube fitted to the apertometer objective can correspond to one tube length only, and this will be, by accident alone, that for which the focus has been made previously. The second in that again the correction for tube length is ignored, for the iris of the eye is the limiting aperture of the rays, and should therefore correspond with the plane of the image formed by the objective. But owing to the eye being within a convergent optical system formed by the cornea and aqueous, its effective aperture is considerably above the anatomical position of the iris, and therefore the eye should in general be placed 2 to 5 c.cm. below the top of the draw tube in order that the

* The italic figures within brackets refer to the Bibliography at end of the paper.

effective aperture should be in its correct position. In most microscopes this position is impossible. Further, as a rule no care is taken to keep the eye central with the draw tube, in order that its effective aperture shall correspond with the centre of the field. The correct technique is obtained by dropping into the draw tube in place of the eye-piece a suitable aperture in a sunk brass mount, the aperture being small and corresponding to the centre of the field, the depth of the mount being such that the aperture is parfocal with the eye-piece.

SECTION 2.—ERROR IN APERTOMETRY DUE TO THE USE OF RAYS NOT CORRESPONDING TO THE EXACT CENTRE OF THE FIELD.

Rays lying away from the centre give values which differ considerably from those obtained with the employment of central rays, because such rays pass through the apertometer plate as bundles to one side of, and not necessarily parallel with, those which illuminate the centre of the field. Since the definition of most microscope objectives is superior at the centre of the field, observation is preferably made there, and therefore central rays should be used for apertometry. There is, however, another and more important reason. For accurate apertometry the indices and the image of the restricting aperture of the objective should coincide. This is rarely the case in practice, for with low-power objectives the images of the indices are usually in a plane much above the back lens; whereas in the case of high-power lenses the plane is situated more often within the objective. Further, while in most objectives it is the back lens which limits the aperture, in one objective in my possession this is done by the front lens, and therefore it is with the image of this that the indices should coincide. As a rule, therefore, the image of the restricting aperture (usually the back lens) of the objective and the indices do not coincide, and therefore by focusing alone it is impossible to get both in focus at the same time.

Now, consideration showed that by restricting the effective iris of the system it should be possible to increase the depth of focus to such an extent that the images of the indices and the restricting aperture should be both simultaneously sharply imaged. It was further seen that the effective iris corresponded in position with the focused image of the objective. Therefore by replacing the eye-piece by a small aperture, through which the observations of N.A. could be made, it was possible to avoid the difficulty due to the indices and the restricting aperture of the objective not coinciding.

SECTION 3.—ERROR IN APERTOMETRY DUE TO THE INCORRECT SETTING OF THE INDICES.

Probably the most accurate of optical methods of measurement is that in which an index is caused to coincide with the centre of the image to be measured (*3*).

But the accuracy is enormously decreased if the field on one side of the image is invisible to the observer, because the measurements are then affected both by his visual acuity and his judgment. If the rays from the objective be traced through the apertometer it

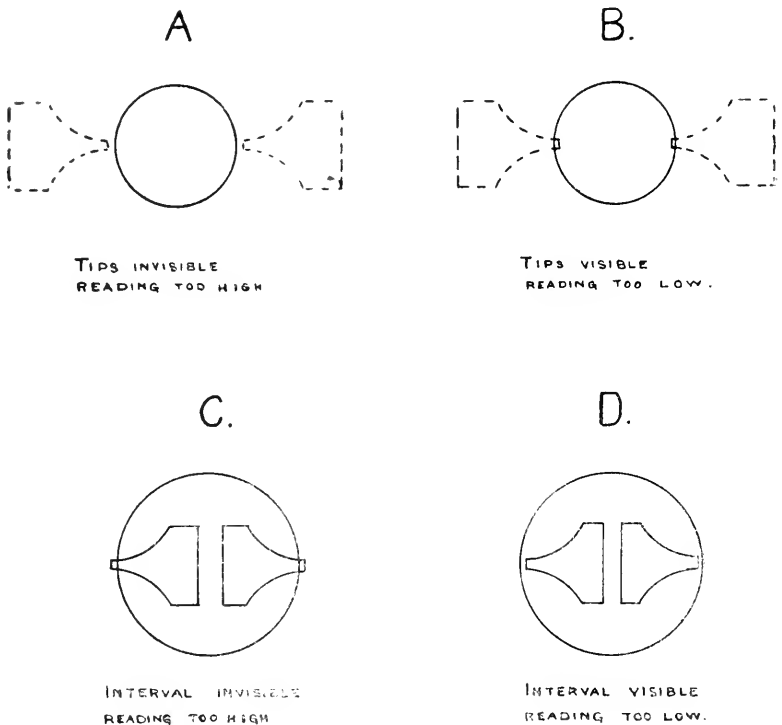

FIG. 1.—Diagrams to show how error is caused by the restriction of the visible field to the aperture of the objective.

At A the indices have been adjusted till the tips are judged to be invisible. The reading is now too high.

At B the indices are still visible, and therefore the reading is too low.

At C similar conditions to A are not met with.

At D the conditions are similar in their effects to those at B.

will be found that they form a cone, the apex of which corresponds with the optical centre of the plate. Structures lying anywhere within this cone will therefore be visible to an observer looking down the draw tube at the back lens of the objective, while structures lying outside this cone will be invisible. This makes the setting of the images of the indices in coincidence with the restricting aperture of the lens a difficult process. Ainslie (*β*) described a similar difficulty in using Cheshire's apertometer. Diagrams A and B (fig. 1) illustrate this difficulty. Placing the indices so that their images are formed within the visible field does not give benefit, as diagrams C and D (fig. 1) show. It is therefore easily seen that according as one takes case (1) in which the tips, or case (2) in which the intervals, are either seen or not seen, so the measurement of the aperture will be too low or too high. A method which allows the whole of the field (i.e. the region outside the cone, corresponding to the limiting aperture of the objective) to be visible removes the difficulty above described by allowing the method of coincidence to be employed. This may be obtained by reversing the direction of the light rays through the optical system. For, this technique, therefore, the light source is placed in the position of the eye-piece, and the rays of light descend through the objective to spread out as a fan towards the periphery of the apertometer plate. The numerical aperture is therefore measured by setting the indices at the edge of the cone of illumination proceeding from the objective, the edge being rendered visible by frosting the curved side of the apertometer plate, or preferably by observing the aerial image by means of a Ramsden eye-piece. It will be seen at once that there are two advantages to be gained by this technique: (1) the whole of the field is visible, and therefore the method of coincidence may be employed; (2) the method can be used without modification for the examination of condenser lens systems. Details of the technique will be given later.

SECTION 4.—ERROR IN APERTOMETRY DUE TO THE INCORRECT DETERMINATION OF THE POSITIONS OF THE INDICES IN RELATIONSHIP TO THE GRADUATED SCALE, AND INACCURACY IN THE GRADUATED SCALE ITSELF.

Both these factors are entirely concerned with the construction of the apparatus and its limitations. As manufactured by Zeiss the instrument is imperfect, for the indices are so constructed that the graduations are not closer than 0.05 N.A., and the subdivision has to be done entirely by eye. This is made difficult by the fact that only one side of the scale is visible (the other part being hidden by the index itself). This point is clearly shown in

diagram A (fig. 2); in diagram B is shown a slight alteration to the indices which entirely avoids this difficulty. An alternative form which would allow greater accuracy is shown at C. The method of using this form of index is as follows:—

The short graduated arm is so constructed that the angle it makes may be altered without changing the position of the zero. By means of a preliminary measurement the approximate N.A. of the objective is obtained. Suppose it to lie between 0·8 and 0·9, the index is placed so that the zero corresponds to 0·8, and the graduated arm is now gently rotated till the 10 graduation corresponds to 0·9. The intermediate graduations now correspond to the decimal subdivisions between 0·8 and 0·9, and may be used for reading to approximately 0·003 N.A. It should be noted that for the scale on the short arm to be uniform its edge must be the segment of a circle. This circle has nearly the same radius as that of the glass plate.

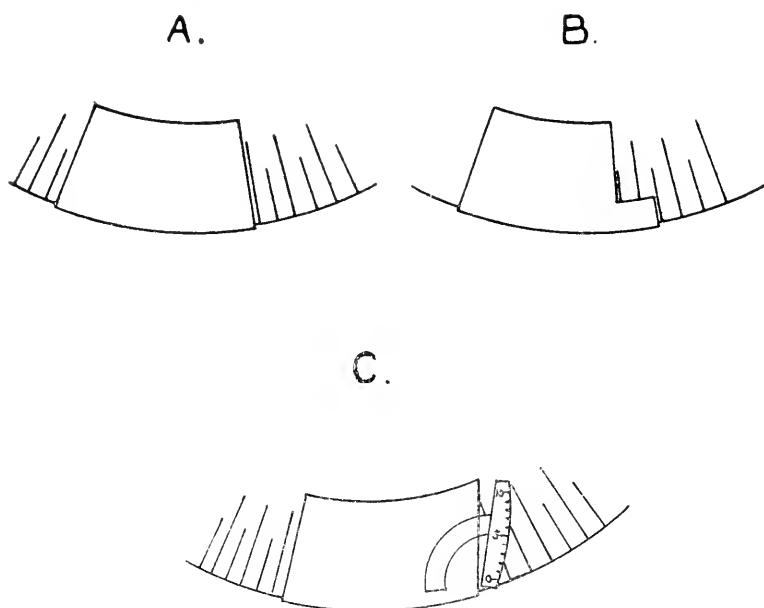

FIG. 2.—Diagrams to show the present shape of the indices A and two improved types, B and C.

At A the subdivisions between the graduations are difficult to estimate by the eye, because only one side of the index is visible.

At B the index has been cut away, thus facilitating the correct estimation of the interval.

At C the index is fitted with a small scale of adjustable inclination, thus rendering the subdivision exact. Direct readings may be obtained to 0·01 N.A. with this device.

A better plan has been suggested to me by Ainslie, namely, to utilize the principle of the diagonal scale. For this purpose a specially graduated glass plate would be required, as shown in fig. 3. The method of using such a scale is well known, and therefore needs no further description. The reason for the use of curved lines is similar to that given above.

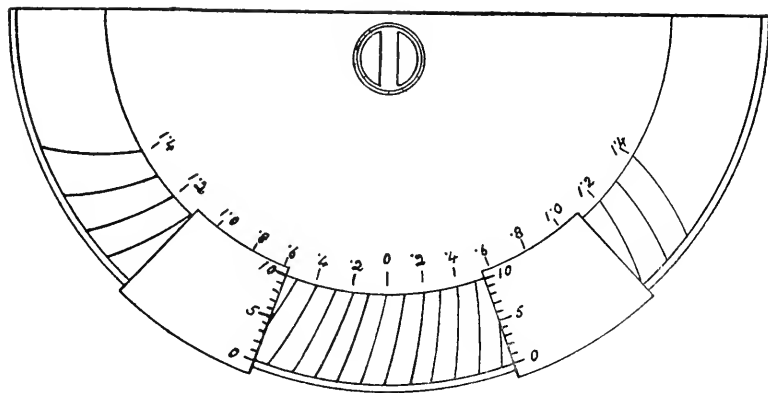

FIG. 3.—Diagram to show the design of an apertometer with a diagonal scale, thus giving direct readings to 0·01 N.A.

SECTION 5.—ERROR IN APERTOMETRY DUE TO PLANE OF APERTOMETER PLATE NOT BEING AT RIGHT ANGLES TO THE OPTICAL AXIS OF THE MICROSCOPE.

Since the light leaves the objective to form a cone of illumination, and since a cone has its greatest width across its diameter, it is clear that the pointers of the indices must be symmetrically placed on a true diameter to the cone, for otherwise the aperture reading will be too low. Since the prism angle at the back of the plate is 45° it might be thought that this point could be neglected. Tests show that this is not the case. Without considering the possible causes of error, the following method of obtaining the correct adjustment may be described as follows:—If with the objective focused in the cover slip of the apertometer, the indices appear to be out of line with the diameter of the cone, then the apertometer plate must be tilted so as to bring them as far as possible correctly into line. The fine centring is now performed by sliding the plate as a whole forward or backward. (This method of adjustment is impossible with the old type of Abbé apertometer, in which the silvering forms a complete ring under the cover glass; and therefore adjustment must be effected by tilting alone.)

The fine centring is performed as follows :—The vertical portion of the indices takes the form of a trident the tips of which are vertically in line, as shown at A in fig. 4. If the indices are now adjusted so that the upper prong is in contact with the edge of the cone of illumination, then if the indices lie in a true diameter the lower prong will also be just in contact, see fig. 4 at B. If contact is not perfect and the index is set apparently at too high a reading, as shown at C, the apertometer plate should be shifted further back and vice versa. Adjustment should be made until the upper and lower prongs appear to meet the edge at the same instant, as shown at B in fig. 4. (At D is shown a better, but somewhat more complicated form of index.)

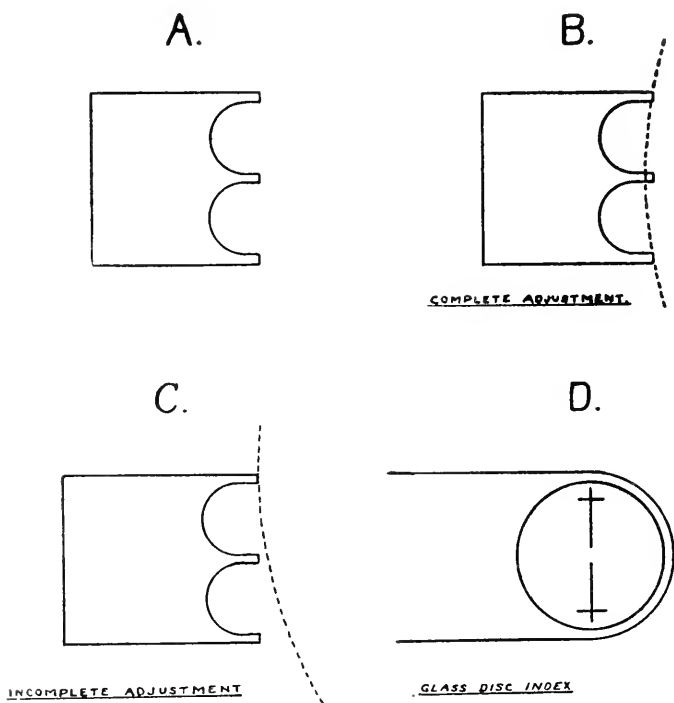

FIG. 4.—Diagrams to show new form of index which facilitates the setting of the plate at right angles to the optical axis.

At A the new form of trident index is shown.

At B the index is shown in relationship to the aperture, the angle between the plate and the optic axis being a right angle.

At C the index is shown in relationship to the aperture, the angle being greater than a right angle.

At D an alternative and better type of index is shown. It is used in a similar manner to the one shown at A.

SECTION 6.—ERROR IN APERTOMETRY DUE TO CHROMATIC ABERRATION.

Abbé has pointed out (1) that objectives corrected for chromatic aberration may show considerable error if the path of the beams is altered. Thus, with high-power objectives, the aperture as measured with blue rays is usually larger than that obtained with red; with the holoscopic 4 mm. the converse is the case. In measuring aperture accurately, therefore, monochromatic light should be used of known, and if possible of standard, wave. This should be either the "chosen colour" (i.e. that for which the most perfect corrections have been made—usually yellow-green rays), or light of short wave length (e.g. blue rays) when the maximum resolving power is required of which the objective is capable.

For providing monochromatic light for this purpose good colour filters are quite sufficient. They may be placed anywhere in the light path; between the source and its aperture is a convenient position.

SECTION 7.—ERROR IN METHODS BASED ON THE MEASUREMENT OF THE RAMSDEN DISC.

The employment of these methods depends on the accuracy of the formula $N.A. \times 2D = M \times R.D.$, where D is the distance of distinct vision (10 in., or 254 mm.), M is the total magnification of the instrument, and $R.D.$ is the diameter of the Ramsden disc. Now Ainslie (3), who has given a description of the method, points out that for accurate determinations the diameter of the Ramsden disc must be measured (because of its small size) by means of instruments of considerable accuracy. When this has been done it still remains to determine the magnification and to fix the value of D , because the accommodation of the eye renders the value of the latter uncertain. For this purpose I find the Eikometer of Wright (4) to have definite advantage, because it fixes the value of D (not at all necessarily at 10 in. however) during the determinations of the magnification. Apart however from the requirement of special instruments I have found the method to suffer from inaccuracy, which is probably due to irradiation.

SECTION 8.—DESCRIPTION OF AN IMPROVED METHOD OF APERTOMETRY.

The principles on which this method rests have been briefly considered above; the description will therefore be limited to structural features.

With the microscope set up in the usual manner (the tube length being correctly adjusted), and with the apertometer on the stage, the annular stop is slipped into position behind the objective, and the latter then carefully focused on one of the edges of the silvered bands under the cover slip. The eye-piece is now replaced by the 2 mm. aperture parfocal with the eye-piece, which is lit from above by a small frosted electric lamp of low candle-power (any other suitable method of illumination may of course be employed).

The aperture being illuminated, the apertometer plate is gently shifted so that the image of the aperture formed by the objective shall fall on the centre of the cover. With a Ramsden eye-piece of medium power (or a hand magnifier) the edge of the shadow on the periphery of the apertometer plate is examined, and one of the indices is moved, so that the upper prong of the trident is set to the exact edge of the shadow. The lower edge is now examined, and if found to be in exact contact the setting of the apertometer plate is correct; if not in contact the setting requires adjustment as described in Section 5. When the correct adjustment has been obtained, the central prong is placed in exact contact with the shadow, and the scale-reading now taken. The left-hand index is then adjusted and its reading similarly obtained. Ten alternate readings are logged and a mean taken; any considerable difference between any of the sets of readings of the same side indicates that the apparatus has been accidentally displaced, and the whole process must be repeated. Assuming that the graduations of the apertometer are accurate, the values obtained by this technique may be depended on to 0.003 N.A. This error even may be reduced by accurate apparatus. A method of this accuracy is found to be essential if other apparatus is to be calibrated in terms of N.A.

SECTION 9.—SIMPLIFIED TECHNIQUE.

Abbé has pointed out that for ordinary purposes very accurate determinations of aperture are not required, because with most objectives quite considerable variation in aperture is not found to cause any observable change in resolving power.

It is therefore possible in such cases to employ a simpler technique than that described above.

For dry lenses of low and medium power the apertometer described by Cheshire (5), or better, Ainslie's modification (6), can be utilized. Special care should be taken to see that the tube length is correct; the use of an annular post objective stop is not necessary however. But there are definite advantages from the use of a descending light path, because the edge of the cone of divergent rays is more easily observed, and the number of rings counted with

greater certainty, when the eye examines the apertometer itself in place of its greatly-diminished image. Owing however to the larger surface the light source has to be brilliant, particularly if outside light has to be competed with. I have found a pocket electric-battery torch admirable for the purpose. For objectives of medium and high power the bull's-eye lens frequently fitted to such lamps may with advantage be retained.

For dry high-power lenses and for oil and water immersion systems the use of a plate similar to the Abbé instrument is necessary. The use of the correct tube length is not of such importance as it is with objectives of longer focal length. If the descending light path be employed both the indices and auxiliary objective may, however, be dispensed with by having the curved edge of the plate frosted and graduated. By this means the boundary of the cone of light may be observed and measured, without the necessity of indices or hand magnifier (Ramsden ocular). Although these simplified methods do not give the same degree of accuracy as that which the more complicated method provides, yet in my hands they appear quite equal to the original Abbé method, and an accuracy to $\cdot 01$ N.A. should be easily obtainable. A further advantage not previously mentioned which the use of a descending light path provides is that since the auxiliary objective is not employed there is no possibility of the error arising which Spitta (?) has drawn attention to.

For very low aperture objectives, Conrady's method would appear to be very reliable, and to be accurate to a least 1 p.c., if proper precautions have been taken with regard to tube length. (The relatively long focal length of such objectives renders the use of the correct tube length of the greatest importance.) In this case also, however, in my opinion, there is definite advantage to be obtained by the employment of the descending light path.

SECTION 10.—APPLICATION OF THE METHOD TO THE SUB-STAGE CONDENSER.

For many purposes it is necessary to obtain the values of apertures, iris-diaphragms, or central stops placed in the lower focal plane of the condenser in terms of N.A. This may be done in several ways; probably the most accurate hitherto described was that employed by the author for measuring working aperture (9). Better results should be obtainable by means of a direct method by employing the apertometer in the same way as that described above for the objective. For this purpose the Abbé apertometer is placed on the stage upside down, and the rays from the condenser caused to enter the plate in a similar manner. It will be at once observed, however, that the method

of focusing and centring employed in the case of an objective cannot be used with the condenser, because the light source cannot be replaced by an eye-piece without considerable inconvenience. An alternative method is therefore best employed, which may be described as follows:—To the sloped reflecting edge of the Abbé apertometer, and immediately above the cover glass, is temporarily mounted the hypotenuse of a small right-angled prism (for this purpose stiff cedar-wood oil, or, better, bifocal cement, will be found satisfactory). The upper surface of the small prism should now be parallel with the plane of the stage, and therefore an image of the silvered strips of the apertometer may be clearly observed by means of any low-power objective with sufficient working distances, since the spherical aberration introduced by the considerable thickness of glass does not cause sufficient degradation of the image to matter for the present purpose. The images of the strips having been sharply focused, the image of the light source is sharply focused in the same plane by adjusting the condenser. The right-angled prism is now removed, and the sloped surface of the apertometer carefully cleaned, in order that the rays incident on it may be reflected to the periphery of the plate without degradation. This must be done without removing the apertometer from the stage or spoiling its adjustment relative to the condenser. A more elaborate method, which avoids any difficulty due to this cause, necessitates the application of a semi-transparent coating of silver to the sloped surface of the apertometer. Above this is permanently cemented the right-angled prism, so that the greater part of the light is internally reflected at right angles, to spread out towards the periphery of the apertometer, while sufficient light passes through the silver and prism to the low-powered objective in order that accurate focusing and centring may be effected. It should be noted that such a procedure does not in any way spoil the apertometer for more general use, so that when much work of this nature is to be done this latter technique should be employed.

BIBLIOGRAPHY.

1. ABBÉ.—*Journ. Roy. Micr. Soc.*, 1880, p. 20.
2. HARTRIDGE.—*Proc. Roy. Soc.*, 1913, B, p. 128.
3. AINSLIE.—*Quekett Journ.*, 1914, p. 287.
4. SPITTA.—*Microscopy*, 1907, p. 432.
5. CHESHIRE.—*Journ. Roy. Micr. Soc.*, 1914, p. 398.
6. AINSLIE.—*Journ. Roy. Micr. Soc.*, 1914, p. 400.
7. SPITTA.—*Microscopy*, 1907, p. 97.
8. TRAVIS.—*Journ. Roy. Micr. Soc.*, 1907, p. 362.
9. HARTRIDGE.—*Journ. Roy. Micr. Soc.*, 1913, p. 363.



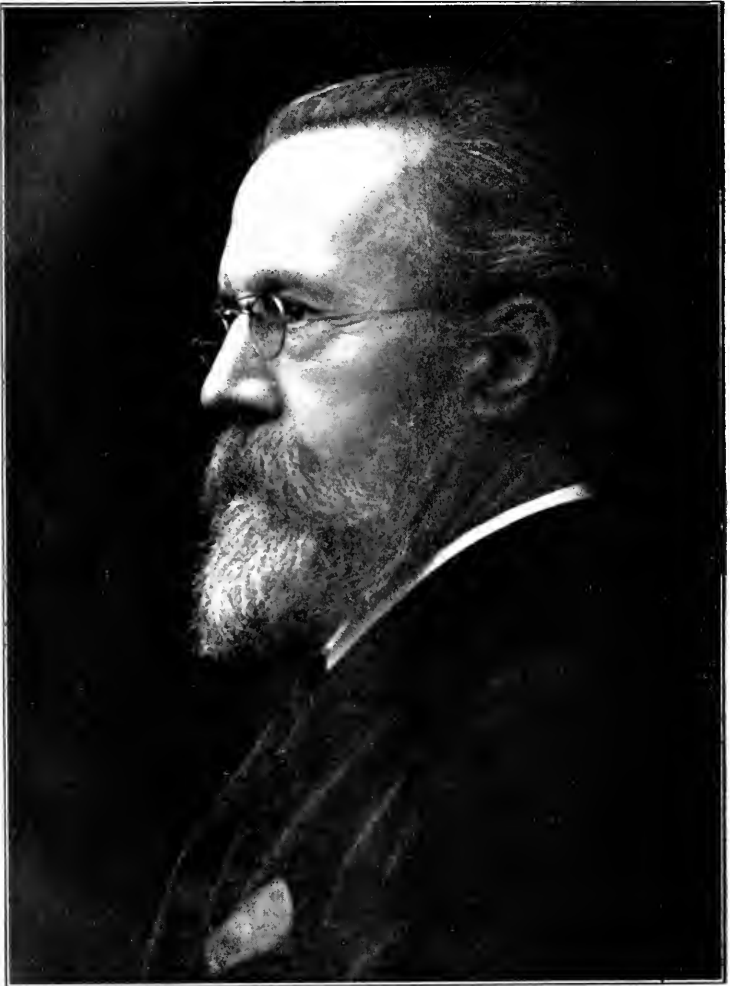

W. G. Munnell

OBITUARY.

PROFESSOR HENRY GEORGE PLIMMER, M.R.C.S., F.R.S., etc.*

[President R.M.S., 1911-12.]

I.—LIFE.

HENRY GEORGE PLIMMER was born in Melksham, Wiltshire, on January 29, 1856. As a young child he suffered from ophthalmia, and practically lost the sight of his right eye thereby. It is ironically curious that ever since he began medicine he used microscopes more than any other instrument.

His father, Dr. George Plimmer, though Melksham is a small town, had a good practice for the country. He was fond of hunting and shooting, indeed of sport of all kinds, and was a well-known figure in the county. George Plimmer had been previously married, and had by his former wife one daughter, who had great musical talent. Henry George's mother and her family were not musical, so that his talent must have come from his father, although the latter often remarked that "music was only fit for women and fools." This is a curious anomaly—the father, with his skill in sport and contempt for music: the son, with no interest in sport and with passion for music.

His father died in 1865. Henry George records that he had no really distinct memory of his father, although he was nine years old at the time of his death, and attributes this to the fact that he was at boarding-school from the age of six, at Devizes. After his father's death it was decided to send him to Shaw House School, which had a local reputation, and was about a mile from Melksham. He seems to have taken every prize at this school except those for conduct and Scripture. He learned very little, but remembered some mathematics, for which he was grateful.

In September, 1867, his mother married John Kerlake, of Bath. He died the following year, and she left Bath early in 1870, and took a tiny house in Ironbridge, Shropshire. Young Plimmer left school in June, 1870, and joined his mother at Ironbridge.

* Professor Plimmer has fortunately left an autobiography in which he set down details of his life for the purpose of any biography or fair statement of his work. It was mostly written in the garden of his friend Goetze, during the summer of 1917. It would seem that he had a presentiment of the fatal illness to which he succumbed in less than a year afterwards.

About a year later he became engaged as a clerk in the Coalbrookdale Co., at a salary beginning at 20*l.* a year. He soon got on, and was a favourite of the general manager, who chose him as his private secretary during the absence of his own secretary in America.

Knowing that he could do better things than clerking Plimmer wrote in 1877 to Dr. J. H. Galton, who had years before been his father's assistant, asking how one began medicine and whether a man could get qualified without money. His whole capital was 400*l.* from his father. Dr. Galton replied that an assistant who had been with him for four years had just qualified and was leaving, and would he like to come and do the same. Feeling that here was his chance, he left his occupation at the Coalbrookdale Co. and went to Dr. Galton on April 2, 1878, at a salary of 50*l.* a year and board. He lived with Dr. Galton at Norwood, and had at first to do the dispensing and book-keeping. He gradually got on to helping in the poor part of the practice, which was large, of Galton and his partner, Sidney Turner. He became in fact "an unqualified assistant."* He entered Guy's Hospital as a perpetual student in the following October, the full fee being paid out of his small capital. His mother came to Norwood in 1880, so he left Galton's house and lived with his mother.

He was Prosector to the Royal College of Surgeons in 1882, became L.S.A. in October of the same year, and M.R.C.S. in January, 1883. The work at Norwood had been very hard and it was impossible for him to do more than just qualify. He did practically the whole of the parish and dispensing work, and frequently went two and three times a day backwards and forwards to Guy's Hospital, as well as being up at night two and three times a week attending midwifery cases. He did not regret these hard years, for he saw and did as much before he was qualified as many men do in ten years after. His interest in pathology arose from his association with Dr. (Sir) Samuel Wilks. He did not however hold any resident appointment. About 1883 he became intimately acquainted with Alfred Aders, of Manchester, and his wife and family, who were living at Norwood. After the death of Alfred Aders he married his widow, Helena, in 1887. His domestic life with this lady, who survives him, was ideally happy. He had previously been made a partner, in 1883, and the firm became Sidney Turner, Galton and Plimmer. In 1889 he moved from Norwood to Sydenham.

In 1892 he retired from general practice so as to devote himself to bacteriology and research, which he began with Professor Crookshank at King's College. In October of this year he described those inclusions in cancer cells subsequently called "Plimmer's

* The unqualified assistant's post was at that time a recognized method of entering the medical profession.

bodies," and became acquainted shortly afterwards with the late Sir Armand Ruffer, who was working at the same subject. At Ruffer's suggestion they went to work together at the laboratories of the Royal College of Surgeons. They worked together there and later at the British Institute of Preventive Medicine; whither they had gone on its establishment in 1893, until illness compelled Ruffer to resign. He became Pathologist to the Cancer Hospital in 1894, where he further studied the various cell inclusions. He was appointed Bacteriologist and Lecturer on Bacteriology at St. Mary's Hospital in 1895, and succeeded Silcock, through whose efforts the appointment was mainly made, as Pathologist and Lecturer on Pathology in 1899. His mother, to whom he was devotedly attached, and by whose side he was afterwards himself buried, died in 1896. In memory of her he founded the Eliza Kerslake prize at St. Mary's Hospital. After his mother's death he moved from Sydenham to St. John's Wood.

In 1902 Sir John, then Doctor, Rose Bradford asked him to take charge of the cancer laboratories at the Lister Institute which had just been started. He resigned his post at St. Mary's Hospital, and later he resigned his post as Director of the Pathological Department at the Cancer Hospital in order to have more time for this work.

From 1898 he had been working at trypanosomes partly alone and partly with Bradford, and in 1906 he undertook the research work on the subject of trypanosomiasis, which was organized and directed by the Tropical Diseases Committee of the Royal Society, and the same time he was made a member of that committee.

He became Pathologist to the Zoological Society in 1907, a post from which he resigned in 1917.

His contributions to science were at last recognized in 1910, when he was elected a Fellow of the Royal Society. It was the only honour he ever desired, and its attainment left him quite free of desires in that direction. In July, 1913, he was elected a member of the Royal Society Club, of which he was a Treasurer for the years 1914-1917. He was offered and accepted the Professorship of Comparative Pathology at the Imperial College of Science and Technology in 1915, was elected a member of the War Office Tetanus Committee in 1916, and later of the Trench Fever Committee. He was actively engaged with the work of his Professorship and with the work of the War Office Committees until a few weeks before his death, being largely concerned in the recent discoveries relating to trench fever. During part of this time he was suffering from that illness of which eventually he died. His death took place on June 22, 1918, at Coombe Bank, Sevenoaks, the residence of his friend, Robert Mond, J.P. Robert Mond, and more especially Mrs. Mond, his mother, were amongst his most intimate friends, and Plimmer would have been the first to eulogize

the kindness and hospitality they offered not only during the days of his last illness, but throughout the period of their close friendship.

Plimmer was a Fellow of numerous scientific and medical societies. The first society of which he became a member was the Royal Microscopical, in 1883, soon after he was qualified. He always took a keen interest in the work of this Society, and on several occasions he gave demonstrations of his microscopical preparations. He also showed his preparations at the meetings of other societies. The specimens were justly admired, for he possessed a wonderful microscopical technique and was always making efforts to improve his methods. He never wearied showing his specimens or other technical details to his friends and colleagues; evenings were often spent alone and with his friends in the study of critical illumination and in discussions of technique.

He was elected to the Council of this Society in 1883, and was President in 1911-1912.

In 1887 he was elected to the Sydenham District Medical Society; became President in 1894, and Honorary Member in 1896.

He was a member of the Medical Research Club from 1894 to 1911; his resignation was due to the fact that he could not attend the meetings during the time that he was President of the Royal Microscopical Society.

He was a member of the Physiological Society from 1894 to 1913, and also of the Pathological Society.

The Linnean Society elected him a Fellow in 1890, and appointed him to the Council in 1917.

His other Societies were:—The Royal Medical and Chirurgical and Royal Society of Medicine (1901); The Royal Institution (1902), of which he was Visitor in 1914-16; Association of Economic Biologists (1917), of which he was a member of the Council from 1917.

He was the only English member of the Deutsche Komité für Krebsforschung, and was also a member of the Deutsche Pathologische Gesellschaft. He knew many of the foreign Bacteriologists and Pathologists intimately, and was welcomed during his many visits to their laboratories on the Continent. His work was as well known to his foreign colleagues as it was to those at home.

II.—SCIENTIFIC, ARTISTIC AND LITERARY WORKS.

During his partnership with Sydney Turner and Galton, Plimmer performed a great deal of surgery, and would undoubtedly have attained the position of a great surgeon if he had specialized in that direction. Amongst his surgical cases must be mentioned: (1) A case of Hysterectomy; (2) a case of Ectopic Gestation. These were remarkable opera-

tions carried out for the first time in this country, and described in the *Lancet* of 1883. Another early publication was on "Quinsy and Rheumatism," published in the *British Medical Journal* of 1886. Even in his busy days of practice he was continually occupied with histological preparations. The specimens demonstrated perfectly the exact structure of each organ. This was the beginning of the histological skill of his later years. An article dealing with the histology of the cell, protoplasm, etc., was written for the first edition of Hazell's "Encyclopædia."

He was particularly interested in the histology of cancer; his first paper dealing with the subject appeared in 1892, entitled, "Note on the Parasitic Protozoa lately found in Cancer," in the *British Medical Journal*. Herein he described the inclusions called Plimmer's bodies. At the same time he devised a technique which differentiated these cells from the known degenerations. This was followed by two papers jointly with Armand Ruffer, "Further Researches on some Parasitic Protozoa found in Cancerous Tumours," in the *Journal of Pathology and Bacteriology* in 1893. Together they published "Sur le mode de reproduction des parasites de Cancer" in *Comptes Rendus de la Société de Biologie* and the *Comptes Rendus des Académies de Science*. In 1894 there was a criticism entitled "The Rhopalocephalus Carcinomatosons," published in the *Journal of Pathology and Bacteriology*.

While working with Armand Ruffer at the British Institute of Preventive Medicine he was concerned chiefly with bacteriology. For several years their main work was on diphtheria, some of the early samples of diphtheria anti-toxin being produced by them. In the autumn of 1894, together with Blaxall, he gave a magnificent demonstration of nearly all the known bacteria at the meeting of the British Medical Association at Bristol. For those days it was really a grand show.

Though continually occupied with the problem of cancer, very few papers were published on the subject, but several reviews were written, namely, "On the Microscopical Diagnosis of Benign and Malignant Growths of the Cervix Uteri" in the *British Gynæcological Journal*, 1895; "Ætiology and Histology of Cancer" in the *Practitioner*, 1899. In 1898 he wrote "A Critical Summary of Ehrlich's Recent Work on Toxins and Anti-toxins" in the *Journal of Pathology and Bacteriology*.

In 1899, whilst at St. Mary's Hospital, he isolated a yeast from a cancer which was ulcerating, then from others. They showed great similarity to some of the cell inclusions, and the fact that they caused tumours in animals lead to the hope that here was the long-looked-for cause of cancer. It was a disappointment, as although they were found in several cancers, they did not produce genuine cancers in animals, and were no doubt accidental infections. Their association with cancer, as shown by his work and that of Sanfelice, Roncali and others, was interesting. These results were published in the *Proceedings of the Royal Society* under the title, "Preliminary Note upon certain Organisms Isolated from Cancer and their Pathogenic Effects upon Animals." There was also an article in *Nature*, "Pathogenic Organisms of Cancer," and a short paper in the *Centralblatt für Bakteriologie* on the same subject.

A paper, "The Parasitic Theory of Cancer," appeared in the *British Medical Journal* of 1903. Plimmer always adhered to the parasitic theory. He was one of the first to try the effect of radium bromide on cancer, after having been on a special visit to Vienna to see the results of the treatment. His experience was published in the *Lancet* of 1904.

From 1899 until his death in 1918 his attention was given to blood-parasites, and he published numerous papers on Trypanosomata. The following is a list of the papers:—(With J. R. Bradford): "Preliminary Note on the Morphology and Distribution of the Organism found in the Tse-tse Fly Disease," *Proc. Roy. Soc.* 1899. "Ueber die Morphologie und Verbreitung der Tse-tse gefundenen Parasiten," *Centralblatt f. Bakt.*, 1899. "The Organism of the Tse-tse Fly Disease," *Nature*, 1899. "Organisms Infesting the Blood of Animals suffering from Tse-tse Fly Disease," *Nature*, 1902. (With J. R. Bradford): "The Trypanosoma Brucei," *Quart. Jour. Micr. Science*, 1902. "Note on the Effect produced on Rats by the Trypanosomes of Gambia Fever and of Sleeping Sickness," *Proc. Roy. Soc.*, 1905. "Further Observations on the Effects produced on Rats by the Trypanosome of Gambia Fever and of Sleeping Sickness," *Proc. Roy. Soc.*, 1907. (With J. D. Thomson): "A Preliminary Summary of the Results of the Experimental Treatment of Trypanosomiasis," *Proc. Roy. Soc.*, 1907. "Experimental Treatment of Trypanosomiasis," *Nature*, 1907. "Comparative Effects of the Trypanosomata of Gambia Fever and of Sleeping Sickness," *Nature*, 1907. "Abstract of Work on the Experimental Treatment of Trypanosomiasis carried out under a Sub-Committee of the Royal Society," *Govt. Blue Book*, 1907. (With J. D. Thomson): "Further Results on the Experimental Treatment of Trypanosomiasis," *Proc. Roy. Soc.*, 1908; reprinted in the Reports of the Sleeping Sickness Commission of the Royal Society, 1908. (With H. C. Bateman): "Further Results on the Experimental Treatment of Trypanosomiasis," *Proc. Roy. Soc.*, 1908; reprinted in the Reports of the Sleeping Sickness Commission of the Royal Society, 1908. "Abstracts of further Results of Experimental Treatment of Trypanosomiasis carried out under a Sub-Committee of the Royal Society," *Govt. Blue Book*, 1908. "Experimental Treatment of Trypanosomiasis," *Nature*, 1908. "Ergebnisse von Versuchen Trypanosomiasis in Ratten zu behandeln," *Centr. f. Bakt.*, 1908. "Weitere Ergebnisse von Versuchen Trypanosomiasis in Ratten zu behandeln," *Centr. f. Bakt.*, 1908. "Weitere Ergebnisse von Versuchen Trypanosomiasis in Ratten zu behandeln," *Centr. f. Bakt.*, 1909. (With W. B. Fry): "Further Results on the Experimental Treatment of Trypanosomiasis," *Proc. Roy. Soc.* 1909. (With W. B. Fry and H. S. Ranken): "Further Results on the Experimental Treatment of Trypanosomiasis," *Proc. Roy. Soc.*, 1910. "Experimental Treatment of Trypanosomiasis," *Nature*, 1910. "Note on Methods," Appendix to paper by W. B. Fry and H. S. Ranken on "Granules," *Proc. Roy. Soc.*, 1913. "Blood Parasites," *Proc. Roy. Inst.*, translated into French in *Revue scientifique*, 1913. "Blood Parasites," *Nature*, 1913. "Note on the Genus *Toxoplasma*, with a Description of Three new Species," *Proc. Roy. Soc.*, 1916. "On the Blood Parasites found in Animals in the Zoological Gardens during the four years 1908–1911," *Proc. Zool. Soc.*, 1912.

This long series of papers on blood-parasites shows that a great deal of the work was devoted to combating sleeping-sickness. Plimmer was the first to use antimony compounds as a means of killing the parasite, after he had tried numerous arsenical preparations and had found them to be uncertain in their action and frequently producing serious after-effects. This was not noticeable in the case of antimony salts, but occasionally the use of antimony, like arsenic, produced parasites immune to the drugs. It was remarkable to see the effects of doses of sodium or lithium-antimony tartrate upon the infected rats. The moribund rat became lively a few minutes after the injection of the drug; after several doses its coat and general condition could not have been more healthy. The appearance of the blood was also most striking; before the injection parasites swarmed; five minutes later only a few parasites were seen; fifteen minutes later no parasites were visible. There was no doubt that the treatment removed the parasites from the blood and the rats were cured. Parasites, however, wander into the cerebro-spinal fluid, and these are not killed by the drug. Some of these enter the blood after the antimony has been excreted, and they can be killed by a second dose. A third dose will kill another invasion from the cerebro-spinal fluid. The antimony-salt is only a real cure in those cases in which the cerebro-spinal fluid is not infected. In these cases it was found that injections of finely-divided metallic antimony into the muscular tissue produced a cure. The best results were ultimately obtained by injecting a suspension of metallic antimony directly into the blood-stream. Horses, goats, rats, and other animals have been cured of the disease. There is a private record of the successful treatment of a few human patients suffering from sleeping-sickness. They were living many years after the injection of antimony, and some had been treated unsuccessfully with arsenic. The curative treatment of sleeping-sickness with antimony was carried out on a large scale in Africa by his late colleagues, Major W. B. Fry, R.A.M.C., and Major H. S. Ranken, V.C., R.A.M.C. Major Fry has also published the results of the successful treatment of yaws with antimony. Plimmer and Fry had previously treated cases of syphilis with this drug with most excellent results. It is a pity that there was no opportunity for further studying the cure of syphilis with antimony. This work of Plimmer and Fry seems to have escaped the notice of other workers.

Plimmer's other papers consist mainly of yearly reports on the deaths in the Zoological Gardens. For four years, 1908-1911, an examination of the blood of the animals was made for parasites, and in 1911 he made a report on the examination of 500 rats caught in the Zoological Gardens. A quarantine house was instituted at his suggestion and the animals in it were under his charge, as well as many other important items in connexion with the health and care of the animals.

Plimmer was an extraordinarily fine musician. In addition to an immense knowledge of music, gained by his own study and by attending musical festivals, he was a wonderful pianist. At the time he left school in 1870 he had no other inclination than towards music, and at that period had taught himself notes and could play fairly well for his age. He used to sit with the organist at the church in Melksham

during his holidays, and at Ironbridge he practised on the organ in Coalbrookdale Church. He became organist there in 1877, just before he came to London. He first heard orchestral music in Bath. Here also his mother took him to his first opera. He attended a performance of "Elijah" in Worcester Cathedral in 1872—his first choir and organ performance. Another stimulus towards music was the piano recitals given by Rubinstein at Birmingham in 1875. Here he has said that he heard for the first time the real thing, and in consequence his own music improved enormously.

The hard medical work at Norwood did not lessen his desire for music. He could generally manage to find a little spare time for playing the piano and to go to concerts. He was a frequent visitor to the opera. In later years he became a Fellow of the Royal Philharmonic Society. His figure was well known in the musical world.

He was quite broad-minded in his music, but he had, if anything, a preference for the works of Wagner. He was present at the first performances at Bayreuth, and was a member of the Patronat Verein. He went to almost every festival until about 1895. One instance showing his broad-mindedness was a visit to Stuttgart to hear the first performance of the new opera "Ariadne," by R. Strauss. Whether he played the works of Beethoven, Brahms, Chopin, Franck, Debussy, Tchaikovsky, Strauss or others, all were rehearsed by Plimmer with equal patience, and in addition their development was carefully studied. For several years he gave recitals of music to his friends in his music room, 3 Hall Road. It was extraordinary for a man so busy in other fields to find the time and to give renderings which were a revelation.

He wrote an analysis of Sinding's pianoforte quintette, and two articles on the Bayreuth Festival of 1891 in the Musical News, and a long article, "A Great Conductor," in the Times of March 18, 1911. He was well acquainted with many of the foremost musicians of his time.

Fine literary gifts were also included in his mentality. During his early life at Ironbridge he read a great deal, in particular the works of Carlyle, Emerson, and Ruskin. At the same time he taught himself German and French, and added enormously to his school-boy knowledge of Latin and Greek. He had correspondence with Ruskin, for whom he translated a passage from the German. By Ruskin he is mentioned in "Fors Clavigera" "as a young student belonging to the working class," and he had a letter from Carlyle. He visited Carlyle in his Chelsea home whilst he lived at Norwood. Later he became acquainted with William Morris and visited Kelmscott House. He knew Hubert Herkomer and many other distinguished literary men. He was most intimate with George Meredith, who visited him annually in the earlier years of their friendship. Throughout his busy life literature always occupied part of his time. He collected a large and valuable library. Many of his best books were secured by chance. He could not and never cared to pay a large price for a book, and was not in the ordinary sense a book collector. His scholarship in literature is only dimly seen in the few articles which he wrote outside his scientific papers. The following are some of these articles:—

“Fourth Dimensions in Space,” Hazell’s Encyclopedia. “Some Aims and Methods in Medicine” (Introductory lecture to medical students at the session 1900–1901), St. Mary’s Hospital Gazette. “Bedullus Immortalis,” Presidential Addresses to the Roy. Micr. Soc., 1911 and 1913. “Omariana,” privately printed for the twenty-first birthday of the Omar Khayyám Club (1913). “The Curves of Life,” Science Progress, 1915. “The Father of Modern Science,” Science Progress, 1916. “Annals of the Royal Society Club,” Science Progress, 1917. “Sir M. A. Ruffer, C.M.G.,” Nature, 1917. “Hyperacoustics,” Science Progress, 1918. “Sir Alfred Keogh and the Army Medical Services,” Nature, 1918.

All other branches of Art were thoroughly appreciated, and he was a connoisseur of the Italian School of painting. Many journeys were planned for the further acquaintance of Architecture and Painting. His first journey abroad was in 1881, to Belgium and to Nuremberg and other parts of Germany. In 1887 he first went to Italy, to Venice, and from 1895 onwards he went almost annually to Italy. Wherever he went his first visit was to the picture gallery, and in these visits he obtained his great knowledge of Fine Art, Sculpture, and Architecture.

He delighted in the intercourse with his fellow-men, and was a brilliant conversationalist; he seldom missed those opportunities of meeting his friends and other men that were offered by the Omar Khayyám Club, the Royal Society Club, and the Savile Club. He was President of the Omar Khayyám Club in 1911, and Treasurer of the Royal Society Club from 1914 to 1916. He was one of those mainly concerned in the formation of the Lucretian Club, of which he was Secretary and Treasurer from its foundation in 1910 to 1917.

A friend of his has written—“When one thinks of the fulness of his life, his keen interest in literature, music, art, and all the things that really matter, it is wonderful that he should have found room for them all as he did. He had a nature, in the words of one of the old Greek poets whom he loved—‘*Τετραγώνος, ἀνευ ψόγου τετογμένος*’ (‘Foursquare, fashioned without fault’).”

KATE MARION HALL, F.L.S., F.Z.S., F.R.M.S.

IN the Proceedings of the Linnean Society of London (Oct. 1918) appears an appreciative notice by Beatrice Harraden of the life and work of Miss Hall, who was elected Fellow of the Royal Microscopical Society in 1910. She was for years the Curator of the Stepney Borough Museum, one of the founders of the School Nature Study Union, and was closely connected with the social and educational work initiated by Toynbee Hall.

Lord Avebury and many other eminent scientists were induced by her to visit Whitechapel for the purpose of lecturing on popular scientific subjects to the inhabitants of that district, whom she had been able to interest in the wonders of Nature.

One of her greatest pleasures was to conduct parties of boys to the parks and woods and talk to them about the birds and flowers, while the renown of her sea-anemone tank and observatory beehive spread far and wide.

Miss Hall was born in August, 1861, and died at Lingfield, whither she had retired, on April 12, 1918.

ALBERT McCALLA, M.A., Ph.D., F.R.M.S.

WE regret to announce the death of Mr. Albert McCalla, aged 72, who died suddenly of heart failure on Thursday, June 6, 1918, at Chicago.

Mr. McCalla was much interested in scientific research, and received a number of degrees. He was possessed of unusually expert ability with the microscope, and was the inventor of an attachment widely used in days gone by. He was a Past-President of the American Microscopical Society.

SUMMARY OF CURRENT RESEARCHES
RELATING TO
ZOOLOGY AND BOTANY
(PRINCIPALLY INVERTEBRATA AND CRYPTOGAMIA),
MICROSCOPY, ETC.*

ZOOLOGY.

V E R T E B R A T A .

a. Embryology, Evolution, Development, Reproduction,
and Allied Subjects.

Germinal Vesicle in Cryptobranchus.—BERTRAM G. SMITH (*Report Michigan Acad. Sci.*, 1916, 17, 73-5, 1 pl.). In the ovum about to leave the ovary of this amphibian, the vicinity of the nucleus shows opaque white globules readily visible to the naked eye. They seem to be not nucleoli, as was at first supposed, but "yolk-islands," i.e. small masses of yolk that become imprisoned between the vitelline membrane and the germinal vesicle when the latter approaches the surface. The subsequent dissolution of the germinal vesicle takes place not at the very surface, but at a short distance from it. During recession a trail of cytoplasm is left between the germinal vesicle and the animal pole. In some ova the germinal vesicle appears to be in a state of disintegration without ever having reached the animal pole, as shown by the absence of this trail of cytoplasm. The dissolution takes place by a gradual disintegration and convergence of its membranes. The germinal vesicle usually collapses before the ovum escapes from the ovary. J. A. T.

Early Development of Opossum.—J. P. HILL (*Quart. Journ. Micr. Sci.*, 1918, 63, 91-139, 4 pls.). Observations were made on the early stages of *Didelphys aurita*, and confirm the view that there is one common mode of early development characteristic of the Didelphia as a group. Cleavage, in the absence of a morula-stage, results in the formation of a unilaminar blastocyst, the wall of which consists of opposite polar areas of formative and non-formative regions. The former is destined to furnish the embryonal ectoderm and the entire

* The Society does not hold itself responsible for the views of the authors of the papers abstracted. The object of this part of the Journal is to present a summary of the papers *as actually published*, and to describe and illustrate Instruments, Apparatus, etc., which are either new or have not been previously described in this country.

endoderm of the blastocyst: the latter gives origin to the trophoblastic or extra-embryonal ectoderm (tropho-ectoderm). The formative cells, the homologue of the inner cell-mass of the Monodelphia, are always freely exposed at the surface of the blastocyst, and are never, even temporarily, enclosed by the tropho-ectoderm, as appears always to be the case in the Monodelphia.

The first cleavage in *Didelphys aurita* tends to be unequal, and is differential, separating the formative from the non-formative. The unsegmented ovum must be potentially polar in its constitution. Perhaps the first cleavage in Monodelphia is similarly differential.

J. A. T.

Lead-poisoning of Germ-cells.—L. J. COLE and L. J. BACHHUBER (*Proc. Soc. Exper. Biol. and Med.*, 1914, 12, 24-9). Two series of experiments with rabbits point to the conclusion that the offspring of males which have been poisoned by the ingestion of lead acetate into the alimentary canal have a lower vitality, and are distinctly smaller in average size, than the normal offspring of unpoisoned males. Other experiments with fowls indicate that poisoning of the male parent with lead results in offspring of a distinctly lower average vitality.

J. A. T.

Seminiferous Tubules of Mammals.—G. M. CURTIS (*Amer. Journ. Anat.*, 1918, 24, 339-94, 24 figs.). Observations were made on isolated tubules of adult mouse, adult rabbit, and three-week dog. Adult tubules present, in their course, no blind ends, blind diverticula, or nodular enlargements. They show in their simpler form an arch, both tubule ends being open and having a functional connexion with the rete. But they form linked series of arches, as many as twelve arches occurring linked in one complex. In rabbit and dog lobules are present, composed of an entire tubule surrounded by a connective tissue sheath. These are divided into sublobules, each with a separate sheath, which contains a part or parts of the single tubule. The waves of the seminiferous tubules were studied in detail. The average wave-length in the mouse is 1.83 cm., in the rabbit, 1.4 cm.

J. A. T.

Spermatogenesis in Mouse.—HARRY B. YOCUM (*Univ. California Publications in Zoology*, 1917, 16, No. 19, 371-80, 1 pl.). In the common house mouse the primary spermatocytes have twenty chromosomes, which correspond in number, shape, and seemingly in size variation to those in the ovum. In the first division all of the chromosomes divide. In the secondary spermatocytes some sections show only nineteen chromosomes, while others show nineteen in one plane or focus and one in another. There is one chromosome which does not divide in the second division, but passes in advance toward one pole of the spindle. There is no secondary pairing of the chromosomes such as has been described in horse, pig, guinea-pig, opossum and man. The spermatids are dimorphic, half having nineteen, and half having twenty chromosomes.

J. A. T.

Spermatogenesis of Dog.—JULIAN Y. MALONE (*Trans. Amer. Micr. Soc.*, 1918, 37, 97-110, 2 pls.). The spermatogonia show deeply

staining nucleoli which fuse before activity is marked; the result is possibly the X-chromosome or associated therewith. The spermatogonia show twenty-one oval chromosomes. Following the spermatogonial division the chromosomes weave out into separate leptotene threads, while the X-chromosome remains as a rounded or slightly oval dark-staining mass. The leptotene threads undergo parasynapsis. Eleven chromosomes appear in the primary spermatocyte, ten are bivalent autosomes, and one is the X-chromosome. The X-chromosome passes undivided to one pole while the autosomes divide by longitudinal splitting. Thus there are produced two kinds of secondary spermatocytes, the division being a reducing division. These two kinds of secondary spermatocytes give rise by division to two kinds of spermatids, one with ten univalent autosomes, the other with ten univalent autosomes and the X-chromosome. During spermiogenesis the centrosome gives rise to the end knob, axial filament and the posterior centrosome; the sphere substance of the secondary spermatocyte division to the acrosome; and the spermatosphere to the sheath of the middle piece. Measurements of mature spermatozoa give a distinct bimodal curve, also indicating their dimorphism.

J. A. T.

Idiosome in Spermatogenesis of Guinea-pig.—GEORGE N. PAPANICOLAOU and CHARLES R. STOCKARD (*Amer. Journ. Anat.*, 1918, 24, 37-69, 2 pls.). The idiosome in the spermatogonia is very variable. In the primary spermatocytes it shows an internal idioendosome sending processes into a larger surrounding idioectosome. When the primary spermatocytes prepare to divide the idioendosome breaks into granules (idiogranulomes), which by the breaking up of the idioectosome are scattered in the cytoplasm. They reunite after division, forming a granular idiosome in the secondary spermatocytes. This breaks up as before and a reconstruction occurs in the spermatids, in which each idiogranulome in the idiosome appears to be surrounded by a minute vacuole, the idiogranulotheca. They run together until there is one large granulome, the idiosphaerosome, surrounded by one large vacuolar wall, the idiosphaerotheca. The subsequent differentiation of the spermatozoon is described in detail. During all stages there are a number of granules in the nucleus, karyogranulomes, which eventually seem to be dissolved within the sperm-head in the same way as the chromatin. The rôle of granulation is probably to secure a distribution of the idioplasmatic substance during cell-division.

J. A. T.

Development of Red Blood Corpuscles.—VERA DANCHAKOFF (*Amer. Journ. Anat.*, 1918, 24, 1-32, 1 pl). The differential factors in the development of a polyvalent cell are extrinsic, and in the erythroblastic differentiation of a hæmoblast depend on the conditions present within the vessels. These factors are active not only in the lower vertebrates, in which normally no extravascular erythropoiesis is observed, but the same factors seem to determine the erythropoiesis in mammals (erythropoiesis in embryonic early stages and experimentally produced in the adult), rendering the derivatives of the hæmoblasts, the erythroblasts, specific—univalent and irreversible in development.

If transferred outside the vessels, the erythroblastic tissue, as seen in the allantois of the chick and in the kidney of the mammal, continues its proliferation and its homoplastic differentiation. The extravascular erythropoiesis in mammals, until new evidence is at hand, may be looked upon as the development of specific blood-cells, which can no longer alter their metabolism in response to environmental factors. J. A. T.

So-called Thymus IV. of Cat.—FRED. W. STEWART (*Amer. Journ. Anat.*, 1918, **24**, 191–223, 4 pls.). The ultimobranchial body of the cat develops essentially as a fifth pharyngeal pouch, although as such it does not make ectodermal contact. The internal thymic lobule of the thymus (the so-called Thymus IV.) is not a branchiomic structure. It is contributed to by the whole of the ultimobranchial body, or by all that does not degenerate. The ultimobranchial body of the cat is an essentially regressive structure. J. A. T.

Development of Hypophysis of Rabbit.—WAYNE J. ATWELL (*Amer. Journ. Anat.*, 1918, **24**, 271–337, 39 figs.). The hypophysis evagination is plainly visible in a rabbit embryo having sixteen primitive segments, on the earlier part of the tenth day after insemination. The endoderm does not contribute. The stalk connecting the hypophysis with the oral epithelium becomes solid during the fourteenth day; it loses its connexion with the epithelium at a variable time between the sixteenth and twenty-fourth day. The residual lumen of Ratke's pouch at first extends from end to end of the epithelial portion; later it does not reach to the nasal extremity. From the thickened epithelium just nasal to the early Ratke's pockets two ridge-like elevations are developed; these are the "lateral lobes," the primordia of the pars tuberalis and of a temporary cortical plate at the nasal extremity of the gland. Their development is followed in detail. The neural lobe undergoes a series of complex foldings and compressions which result in the dividing up and partial obliteration of the cavity of the lobe, and in the formation of a medullary layer and a cortical layer. It seems that processes grow from the neural lobe into the intermediate part. The lateral lobes of mammals and reptiles seem to be homologous, but it is precarious to say the same of the lateral lobes of Elasmobranchs. J. A. T.

Development of Hypophysis of Anura.—W. J. ATWELL (*Anat. Record*, 1918, **15**, 73–92, 18 figs.). There are three epithelial lobes and a neural lobe. The lobes of epithelial origin are the anterior lobe proper, the pars intermedia, and the pars tuberalis. From their development and their mature structure these lobes in Anura may be considered homologous with corresponding lobes in all higher vertebrates. The anterior lobe proper develops from the main central portion of the solid epithelial primordium. It comes to be caudal and ventral to the other portions. The pars intermedia develops from the caudal tip of the hypophysial primordium. The pars tuberalis has a paired origin in the lateral lobes, which appear very early and become detached from the brain-floor in the pia mater. J. A. T.

Right and Left Testes of Pigeons.—OSCAR RIDDLE (*Anat. Record*, 1918, 14, 283-334). In healthy adult doves and pigeons the right testis is larger than the left in a very high percentage of cases. The left testis, in a high percentage of cases, is absolutely longer and thinner—more nearly the shape of the single persistent (left) ovary of the female—than is the right testis. It is relatively longer and thinner in probably nearly all cases. In disease—particularly in tuberculosis—the testes undergo extreme atrophy (often 90 to 95 p.c.); the reduction is greater in the right than in the left testis; the ovary probably suffers no reduction whatever. In hybrids the normal size relations of the two testes are much disturbed. It is suggested that a male which has been forced to arise from a female-producing egg may show in the relative size of its gonads an approximation to the relative size of the gonads of a female.
J. A. T.

Influence of Age on Reproductivity of Fowls.—RAYMOND PEARL (*Genetics*, 1917, 2, 417-32). A new constant, the reproductive or fertility index, is proposed for the measurement of the net reproductive ability of mated pairs of the domestic fowl. This index expresses the actual number of chicks produced by the mating, and capable of living three weeks after hatching, as a percentage of the maximum total number of chicks physiologically possible. For a Barred Plymouth Rock strain the reproductive index has a mean value of about 12 p.c. Net fertility is a rather highly variable character, like other purely physiological characters. Reproductive ability, as measured by the index, diminishes with advancing age of the birds mated, having its maximum when each of the birds mated is from ten to fourteen months old. The rate of decline with advancing age is more rapid in the males.
J. A. T.

Age and Fertility in Fowls.—RAYMOND PEARL (*Proc. Nat. Acad. Sci.*, 1917, 3, 354-56). In mammals it seems that fertility rises from the beginning of sexual life to a maximum, and then declines with further increase in age, until total sterility is reached. In the fowls Pearl worked with there was no approach to this law of fertility. Instead we find a steady and progressive decline in fertility after the first breeding season. Up to a combined parental age of four years what occurs is this: There is a significant drop in reproductive ability as we pass from a combined age of two years for the mated birds to three years. In passing from three years to four there is no significant change in reproductive ability. In passing from a combined age of four years to that of five years there is a large drop in the net reproductive ability of the mating.
J. A. T.

Sex-ratio in Domestic Fowl.—RAYMOND PEARL (*Science*, 1917, 46, 220). The determination of sex in poultry is primarily a matter of zygotic constitution, but under certain conditions the normal ratio of about 48.57 p.c. of cockerels may be modified. The chief factor in bringing about the modification in the direction of a larger production of pullets is the fecundity or laying ability of the hens used as

breeders. It is possible to breed strains of hens in which high productivity is a fixed characteristic. And when the poultryman breeds along the right lines for increased egg production, he will at the same time be producing a strain in which profit-making pullets will preponderate over the less profitable cockerels. The constitutionally more fecund hens tend to produce a larger proportion of female offspring.

J. A. T.

Case of False Hermaphroditism.—H. E. JORDAN (*Anat. Record*, 1918, 15, 27-35, 1 fig.). A case of masculine pseudohermaphroditism in man, showing two abdominal testes and a bilateral pair of symmetrical bodies like ovarian remnants, which turned out, however, to be lymph-nodes. The interstitial cells of the testes were very few and small—degenerate, in short. There was well-attested lack of sexual desire, which is believed to stand in causal correlation with the activity of the interstitial cells. The case was one of arrested male development—atrophyed testes, “rudimentary” penis, vestigial scrotum, and cryptorchism. But certain female secondary characters, e.g. well-developed mammary glands, appeared. There were concomitant somatic abnormalities (supernumerary digits and club-foot), besides left-handedness and feeble-mindedness.

J. A. T.

Superfetation in Cow.—MARY T. HARMAN (*Anat. Record*, 1918, 14, 335-6). A case is described which may be interpreted as superfetation. It may, however, have been due to retarded development. Whatever be the interpretation, the case adds another to the list of mammals in which the uterus has been found to contain at the same time embryos of widely different degrees of development.

J. A. T.

Grafts of Spleen on Allantois.—VERA DANCHAKOFF (*Amer. Journ. Anat.*, 1918, 24, 127-89, 8 pls.). Mashed splenic tissue of fowl grafted on to the allantois shows proliferation and differentiation in the transplanted tissue, and induces the same in the allantois. Both sets of cells react to the new conditions. The further existence of the adult splenic tissue within the embryonic allantois results in a manifestation of definite new potentialities in its surviving cells. In the vicinity of the graft definite changes occur in the mesoderm, ectoderm, and endoderm of the allantois. The mesenchyme is also involved in the general process of stimulation, and shows granuloblastic differentiation as observed in the mesenchyme of the body after grafts of splenic tissue. The above is merely an indication of the lines of this important investigation.

J. A. T.

Notes on Fresh-water Fishes of Madras.—B. SUNDARA RAJ (*Records Indian Museum*, 1916, 12, 249-94, 5 pls.). This paper contains many interesting notes on habits and life-histories. In *Arius falcarius* the male carries the eight or so large eggs in his mouth for many days until they hatch. The eggs of *Haplochilus melanostigma* give off numerous short adhesive threads, by which they adhere to one another and to foreign objects. From a certain area there arise very

long threads which twist together into a common cord which protrudes from the genital opening of the female. The female of *Osphrcmenus gourami* aerates the eggs with mouthfuls of air engulfed at the surface. The female of *Etroplus maculatus* ejects a mouthful of dark sediment

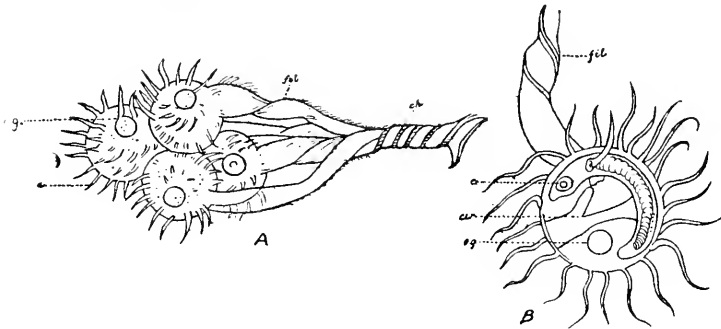

A. Cluster of eggs of *Haplochilus melanostigma*. *a*, adhesive threads; *o.g.*, oil-globule; *fil*, long filaments; *ch*, cord formed by union of twisted filaments; *e*, eye.
 B. Lateral view of embryo inside the egg-membrane.

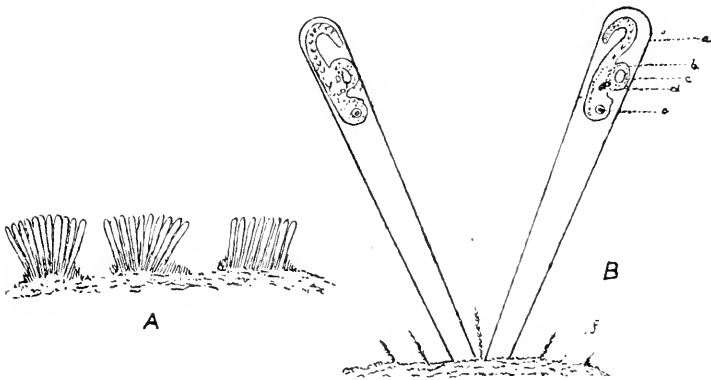

Eggs of *Gobius (Oryurichthys) striatus*.

A. Outline of three clusters of eggs attached to rock.
 B. Two eggs enlarged with advanced embryos, showing egg-membrane (*a*), yolk (*b*), oil-globule (*e*), heart (*d*), and eye (*e*).

into the nest containing the young fry. In *Gobius (Glossogobius) giuris* and in *Gobius (Oryurichthys) striatus* the egg-membrane is in the form of a long tube, which is fixed to the roof of a burrow in the first instance, and to stones and the like in the second.

J. A. T.

Growth of Parts of Rats and of the Whole.—SHINKISHI HATAI (*Amer. Journ. Anat.*, 1918, 24, 71-89, 4 figs.). The increase of weight in epididymis, pancreas, stomach, and submaxillary glands is compared with that of the body as a whole for each millimetre of length from 47 mm. (weighing 4.9 gm.) to 250 mm. (weighing 448.5 gm.). Some results may be noted. Before puberty the weight of the epididymis is approximately one-sixth that of the testes, after puberty about a third. The weight of the stomach is about one-ninth of the alimentary tract, except in the newborn rat, where it is relatively heavier. The females have a heavier pancreas than males of the same weight. J. A. T.

Proportion of Sexes in Whitefish.—RAYMOND PEARL (*Report Michigan Acad. Sci.*, 1916, 17, 76). There is great dearth of definite statistics regarding the normal sex-ratios of even the commonest animals. In unselected catches (five days) of *Coregonus albus* taken in deep water gill-nets in Lake Erie, there were 386 males to 455 female, a ratio of 848 males to 1000 females. J. A. T.

b. Histology.

Lining of Perivascular Spaces.—KAETHE W. DEWEY (*Anat. Record*, 1918, 15, 1-26, 9 figs.). An apparently exceptional behaviour towards vital stains is exhibited by the endothelial cells lining the perivascular spaces, or, if the existence of such cells be denied, by the perivascular connective-tissue within the brain and spinal cord.

Unlike such cells in the perivascular connective-tissue in other organs and tissues, they do not habitually take up the vital stain, but do so only under the influence of stimuli from pathological conditions.

Affinity for the vital stain is absent, in general, in the endothelial cells of the inner lining of arteries, veins, and capillaries, but present in the capillaries and venules of the spleen, the capillaries of bone-marrow, the blood sinuses of hæmal glands, and the Kupffer cells of the liver. It is absent, in general, in the endothelial cells lining the inner wall of the lymph-vessels outside the organs; present in the lymph-channels within organs except the brain and spinal cord. "With reference to the central nervous system, affinity for the vital stain is absent, in general, in the perivascular spaces within the brain and spinal cord; present in these conditionally and in focalized distribution in the presence of pathological stimuli, in general, within the membranes along channels conveying lymph or cerebrospinal fluid." J. A. T.

Heart-muscle of Embryo Chick.—E. D. CONGDON (*Anat. Record*, 1918, 15, 135-50, 10 figs.). The heart of chicks younger than the sixteen- or seventeen-somite stages, when rhythmical contraction begins, has a sarcoplasmic structure whose optical section is a net consisting of two systems of parallel lines intersecting to cut off spaces approaching a square form. They measure in the fixed material about 0.8 micron on a side. The apparent net is probably produced by three systems of intersecting membranes which form hexahedral compartments. At all the intersections of three planes there are small uniform mitochondrial

granules. There is some indication in the arrangement of the planes of a division of the early myocardium into mononuclear cell areas which correspond to lobations on its exterior.

J. A. T.

Giant-cells of Yolk-sac and Bone-marrow.—H. E. JORDAN (*Amer. Journ. Anat.*, 1918, **24**, 225-69, 70 figs.). The giant-cells of the marrow of young bones are of two physiological types, hæmogenic and osteolytic. They agree in being multinucleated and in possessing originally a basophilic cytoplasm, which gradually becomes oxyphilic.

The hæmogenic giant-cells or polykaryocytes originate from hypertrophied hemoblasts by direct division of the nucleus of transitional polymorphokaryocytes. They are essentially multiple hæmoblasts and may differentiate erythrocytes intracellularly under certain conditions, apparently such as call for increased hæmopoietic activity. They are the same in yolk-sac and red bone-marrow.

There is no unequivocal evidence that polymorphokaryocytes and hæmogenic polykaryocytes are phagocytic. They may perhaps represent an incidental phase of intense hæmopoiesis.

The osteolytic giant cells (osteoclasts of Kölliker) originate from the marrow reticulum by a process involving the aggregation of nuclei within larger cytoplasmic masses and secondary fusion with other portions of the reticulum and with osteoblasts. They may during their early stages of differentiation produce blood granulocytes, or possibly hæmoblasts, but there is no direct genetic homology between them and polykaryocytes. They eventually disintegrate and are not re-transformed into marrow reticulum.

J. A. T.

Histology of Lymph.—H. E. JORDAN (*Anat. Record*, 1918, **15**, 37-45). The primary object of this investigation was to determine whether blood-platelets occur in lymph. The material employed consisted of smear preparations of lymph from the thoracic duct of the dog. The evidence seems conclusive that platelets are preformed structural elements of blood—not precipitated products—and that they do not form a normal constituent of the lymph of the thoracic duct. This may mean that only a small quota is contributed to the peripheral portion of the lymphatic tree, and that disintegration occurs during their relatively slow progress towards the thoracic duct.

J. A. T.

Iridocytes in Batrachian Larvæ.—C. R. N. RAO (*Records Indian Museum*, 1917, **13**, 281-92, 1 pl.). The larvæ of *Microhylla ornata* and *M. rubra* float on the surface in shoals. This habit is correlated with the presence of air-chambers between the branchial plates, which function more or less as hydrostatic organs. The attacks of enemies are warded off by the presence of an acid offensive matter in the cephalic gland, and this is probably advertised by the bright coloration. There is a unique occurrence of iridocytes (with guanin crystals) and argenteum or reflecting tissue. The presence of iridocytes and black (melanin) chromatophores on the lungs and peritoneum is very interesting, for both these occur in the air-bladder and peritoneum of some embryo fishes. The iridocytes of the mid-dorsal band and the ventral argenteum of the sub-cutaneous tissue of the abdomen are free from

calcium in any form. The iridocytes contain irregular plates consisting of spherical granules, identical with those obtained by the breaking down of guanin-nitrate crystals, while the argenteum is a dense opaque reflecting sub-cutaneous tissue in which no particular structure could be made out. There are also yellow and red lipochromes in special connective cells transformed into chromatophores. Similarly the cells which accumulate guanin in their cytoplasm become iridocytes. As metamorphosis progresses large amoebocytes appear wherever iridocytes and argenteum occur.

J. A. T.

Phagocytosis in Tadpole's Tail.—E. R. CLARK and E. L. CLARK (*Anat. Record*, 1918, **15**, 151-63, 1 pl.) In the transparent tails of tadpoles (of *Bombinator*, *Rana pipiens*, and *Hyla pickeringii*) there are three types of cell which show the power of phagocytosis in relation to granules of carbon and carmin injected into the sub-cutaneous tissue. These are (1) leucocytes (including wandering cells), (2) stellate connective tissue cells, and (3) the endothelial cells of the lymphatics. The leucocytes actively migrate toward the site of injection, while the mesenchyme cells and lymphatic endothelial cells apparently ingest only those particles which are in close proximity to them.

J. A. T.

Fish-freezing.—J. STANLEY GARDINER and G. H. F. NUTTALL (*Proc. Cambridge Phil. Soc.*, 1918, **19**, 185). The method of freezing fish usually employed preserves the fish for an indefinite period, but the product breaks up in cooking, tending to become rather woolly, and loses flavour and aroma. A fresh process has been developed, freezing the fish in brine consisting of about 18 p.c. of salt at a temperature of 5°-20° F. A large fish freezes thoroughly in three hours, a herring in twenty minutes. There is no woolliness, no loss of flavour or aroma. The difference is due to the fact that, whereas in dry freezing there is a breaking up of the actual muscular fibres due to the formation of ice crystals, in brine-freezing the ice crystals are so small that the muscular fibres are entirely unaffected, and on thawing return to the normal.

J. A. T.

Telescope-eye of Goldfish.—I. AMEMIYA (*Journ. Coll. Agric. Univ., Tokyo*, 1917, **6**, 245-59, 1 pl., 2 figs.) Among varieties of goldfish two kinds of "telescope-eyes" occur, those directed laterally and those directed vertically. These peculiar eyes appear to be in this case the outcome of artificial selection. In deep-sea fishes the telescope-eye is adapted to faint light and is quite different from the goldfish eye. Thus the anterior chamber is spacious in the goldfish, filled up by the lens in the deep-sea type; the retina in the goldfish is degenerate in the posterior region, where it is strongest in the deep-sea type; there is no real accommodation apparatus in the interior of the goldfish eye. Some other differences are explained.

J. A. T.

Caudal Fin of Chaudhuria.—R. H. WHITEHOUSE (*Records Indian Museum*, 1918, **14**, 65-6, 1 fig.). In this eel from Inlé Lake the caudal fin is discontinuous, whereas in all other eels it is continuous with the

dorsal and anal fins, whose fin-rays are supported by interspinous bones alternating with the neural and hæmal spines. There is a space devoid of fin-rays (six or seven vertebræ) separating the caudal fin from the last vertebra with fin-rays attached. Two large hypural bones are present, fused at their bases, and firmly fixed or fused to the last centrum. Thus the caudal fin is *wholly* a ventral structure in this fish, whereas in the majority of Teleosts a few dorsal elements enter into the caudal fin. It is probable that the caudal fin in *Chauliurua* is a more definite propulsive organ than in other Apodes.

J. A. T.

c. General.

Fauna of Coastal Waters.—C. G. JOH. PETERSEN (*Rep. Danish Biol. Stat.*, 1918, 25, 1-62. 11 pls., 16 figs.). A survey is taken of the work done from 1883-1917 in the valuation of the sea-bottom in Danish coastal waters. Much information has been obtained by using, in addition to the dredge, etc., various forms of "bottom-sampler." The sea-floor near the coasts shows flat plains of sand, mud, or clay, or transition stages between these, with or without stones. The vegetation consists of *Zostera* and Algæ. It is not as a rule consumed living, but is spread about in the form of detritus and then eaten. It forms a thin layer on the mud, and is far more important than the microscopic plankton. Eight distinctive animal communities are distinguished, and these are named after characteristic types:—*Macoma*, *Abra*, *Venus*, *Echinocardium cordatum* and *Amphiura filiformis* (contracted to *Echinocardium-filiformis*), *Brissopsis lyrifera* and *Amphiura chiayei* (contracted to *Brissopsis-chiayei*), *Brissopsis lyrifera* and *Ophioglypha sarsii* (contracted to *Brissopsis-sarsii*), *Amphilepis-Pecten*, and *Haploops*. Wherever there are stones, waving plants, or the like, of considerable size, there is an "epifauna," such as the *Mollola*-epifauna or the *Mytilus*-epifauna. The nature of the epifauna communities or of the level-living communities depends on the nature of the bottom, the temperature, the salinity, the depth, the storms, or the inter-relations established. In the Kattegat there are towards 24 millions of tons of plants (about 4 millions of dry matter), about 5 millions of tons of "useless" animals, about 1 million "useful" forms—namely, those which furnish or may furnish food for fishes. It is estimated that there are only some few thousands of tons (5-7000) of each important species of food-fish, such as plaice, cod, and herring. Starfish make up 25,000 tons—more than all the important food-fishes altogether—while predatory Crustaceans and Gastropods amount to no less than 50,000 tons. The food-fishes, being predatory animals, are far from economical to produce. Only a relatively small number can be supported in a given area—and it has to be borne in mind that some animals are much more nutritionally valuable than others. Much of the weight of the animals consumed by fishes may be lime-salts or water. A detailed investigation of a limited area (Limfjord) shows that the quantity of fish-food available is by no means unlimited. Indeed, there may be more fish—e.g. plaice—per acre than the water can stand if they are to grow

rapidly. The *Zostera* areas are noteworthy for the abundance of *Bissoa* and similar small Gastropods, which are of some importance as fish-food, besides being devoured by crabs and starfishes. In addition there are Gammarids, Isopods, Mysids, a few bivalves, and Polychæts. The author has some suggestions to make in regard to the utilization of *Zostera* and the improvement of the feeding-grounds of fishes.

J. A. T.

Food of Post-larval Fishes.—MARIE V. LEBOUR (*Journ. Marine Biol. Assoc.*, 1918, **11**, 433-69, 7 figs.). It now seems a well-established fact that the majority of young fish eat the small animals from the plankton more than the diatoms and other unicellular organisms, except in the cases of some of the very young fishes which have been found to eat diatoms before taking to animal food, and in the few exceptional cases of fish which are true vegetarians. Miss Lebour's investigation deals with about fifty species. There is evidence of a certain amount of selection of food. Fish with the smallest mouths eat the smallest forms, both large and small being eaten by those with large mouths. Entomostraca form the greater part of the food, and the commonest in order of frequency is the Cladoceran *Podon* (probably *intermedius*), and the Copepods *Pseudocalanus elongatus*, *Temora longicornis*, and *Euterpina acutifrons* in the proportion of 6 : 4 : 3 : 2. Cirripede larvæ and small ova are also common; Diatoms and Peridinids are mostly inside the Copepods.

J. A. T.

Disappearance of *Conus arteriosus* in Teleosts.—WILBUR C. SMITH (*Anat. Record*, 1918, **15**, 65-71, 16 figs.). The *conus arteriosus* is characteristic of Elasmobranchs and Dipnoi. It is present only in a few Teleosts. Its gradual disappearance can be illustrated in a series of types. In most cases it has been lost by intussusception or recession into the ventricle, as Hoyer has maintained. In a limited number of cases this is not the case; the *conus* is taken up by the caudal elongation of the *bulbus arteriosus*.

J. A. T.

Note upon the large Mononuclear Leucocytes of the Peripheral Blood and the Macrophages at the Site of Injury amongst the Wounded.—A. NANTA (*C.R. Soc. Biol.*, 1918, **81**, 256-9). In a previous note Nanta showed that tissues around a wound are rapidly infiltrated with leucocytes, chiefly macrophages; whilst in the peripheral blood a leucocytosis of 30 to 60,000 occurs rapidly, the differential count showing 80-85 polynuclears and 5-15 mononuclears per cent. In further investigating the rôle of the mononuclear leucocyte, Nanta observed that the most severe and the most extensive wounds—but not necessarily the most severe hæmorrhages—were attended by the highest mononuclear leucocytosis. Some of the mononuclears of the blood are normal, but the majority are abnormal and show considerable increase in strongly basophile protoplasm, and are often rich in irregular azurophile granules, with fissured nuclei, similar to those associated with diseases of the spleen. Smear preparations from the spleen show the presence of these cells in large numbers in the Malpighian corpuscles.

The author suggests that the hæmatopoëtic centres use up the disengaged mononuclears to satisfy the immediate defensive needs of the organism, and do not at the outset proceed to a reparatory proliferation. J. E.

The Leucocytes in Experimental Spirochetosis ictohæmorrhagica in the Guinea-pig.—J. BABLET (*C.R. Soc. Biol.*, 1918, **81**, 300–3). Leucocytosis ranging from 7,600 to 35,000 per c.cm. against a normal of 3,500 (*sic*) is a constant feature, and reaches a maximum in five days, associated with the disappearance of mononuclear cells and the early appearance of abnormal cells, particularly myelocytes; most marked during the first three days. The following table gives the means of numerous counts:—

AFTER INOCULATION.

—	24 hours	48 hours	72 hours	4 days	5 days	6 days
White cells . .	10,900	8,000	12,400	11,600	18,200	13,100
Myelocytes, p.c. .	60	51	47	36·6	36	32

The myelocytosis takes place at the expense of the polymorphonuclear cells, which, however, regain their normal figure as the myelocytes diminish. At first polymorphs with multilobular nuclei are the rule, and single or bi-lobed cells the exception; after the fourth day this formula is reversed. J. E.

Tunicata.

Philippine Ascidiæ.—WILLARD G. VAN NAME (*Bull. U. S. Nat. Museum*, 1918, **100**, 49–174, 11 pl., 115 figs.). The Ascidian fauna of the Philippines is an integral part of that of the Malay region, not a distinct and separate one. It is very abundant and varied in the southern part, especially in the Sulu Archipelago. To the north, among the islands, it diminishes both in abundance and variety. It is distinctly a tropical fauna. Its relations to that of the temperate portions of the Australian coast are much closer than to those of the less-distant regions on the north, since on account of the warm currents many tropical Malayan forms range southward along the east coast of Australia and even through Bass Strait. Forty-six species are dealt with, including two new genera and eight new species. J. A. T.

Vascular System of Ascidian.—SELIG HECHT (*Amer. Journ. Physiol.*, 1918, **45**, 157–87, 6 figs.) finds that the blood of *Ascidia atra* is colourless and transparent; that it flows through the body under an appreciable pressure; that the blood plasma is isotonic with sea-water; and that the blood has an acid reaction, the acidity being resident in the green corpuscles and not in the plasma. There are at least two kinds of cells in the blood—pigmented and unpigmented. Of the pigmented cells, the green are distributed all over the body, the orange

are localized in the branchial sac, and the blue in the regions of the viscera, etc. Some of the unpigmented cells are amœboid; others are not. In the green cells the pigment is a compound containing vanadium, probably in a stage of oxidation corresponding to V_2O_3 . It is not a respiratory pigment, but is most likely of value as a catalytic agent. The coagulation of the blood depends on the agglutination of its cells. Clotting often occurs within the intact blood system as a result of vigorous external stimulation.

The heart is long and has a node (demonstrable physiologically and anatomically) which divides it unequally. A pericardial body is present. In most specimens a pulsation series shows about twice as many advisceral beats as abvisceral beats. The pulse-rate decreases as the size of the animal increases. It is greater in the advisceral phase, and the velocity of the contraction-wave is greater in the advisceral direction. There is a *circulation* of the blood in the advisceral direction. The reversal of the heart-beat may be due to the alternating dominance as pacemakers of the two ends of the heart. The heart-beat is myogenic, and the contraction wave passes along the muscular elements across the heart.

J. A. T.

INVERTEBRATA.

Mollusca.

a. Cephalopoda.

Posterior Salivary Glands of Cephalopods.—F. BOTAZZI (*Atti R. Accad. Lincei Rend.*, 1918, **27**, 191–6, 227–30). Experiments on the toxic action of the secretion of the posterior salivary glands of *Octopus macropus* point to the effect being due to the presence of substances analogous to tiramine, histamine, and coline in the secretion. The rapid effect of the secretion on the crabs which the cuttlefish bites is well known. The secretion also digests crab-muscle, and contains proteolytic and peptolytic ferments.

J. A. T.

Arthropoda.

a. Insecta.

Reflex Immobilization in Arthropods.—E. RABAUD (*Bull. Soc. Zool. France*, 1918, **42**, 140–5). Some insects become “immobile” when turned back downwards, and may remain stiff for a few seconds or for as long as twenty minutes. This is well seen in several dragonflies (e.g. *Lestes viridis* and *Aeschna cyanea*). The immobility lasted for about thirty seconds in *Cordulogaster annulatus*, for twenty minutes in *Calopteryx splendens*. The phenomenon was also observed in some Lepidoptera (e.g. *Spilosoma menthastris*), some Diptera (e.g. *Dexia rustica*), and very markedly in an Asilid, *Machinus pilipes*. The removal of the tarsal joints from all contact with a surface is the immediate factor which puts a stop to mobilizing stimuli and allows immobilizing influences to get the upper hand. In active flight the tarsal excitation is replaced by that of the wing-beats and by visual stimuli.

J. A. T.

Rôle of Ganglia in Immobilization.—E. RABAUD (*Bull. Soc. Zool. France*, 1918, 42, 158–66). Experiments made on a Millipede (*Leptotulus belgicus*), and various insects (Coleoptera, Odonata, Lepidoptera) show that reflex immobilization does not depend exclusively on this or that ganglion. It depends on the nervous system as a whole, its excitability, and its relations with the outer world. But the suppression of particular ganglia means a restriction of a varying number of excitations, and this works towards reflex immobilization. In different types corresponding ganglia vary in importance. Thus in insects with big eyes the cerebral ganglia count for much, since the visual stimuli are intensely counteractive of immobilization. In insects with small eyes other areas of stimulation become relatively more important. J. A. T.

Study of Ant Larvæ.—W. M. WHEELER (*Proc. Amer. Phil. Soc.*, 1918, 57, 293–343, 12 figs.). Various Ponerine larvæ when fed by the workers are turned on their backs, and fragments of insects are placed on their concave ventral surfaces. On these the larva discharges salivary secretion with a strong proteolytic ferment, and part of this is licked up by the nurses. In some other larvæ which receive liquid food there are tubercles and other delicate outgrowths from which exudation occurs. There may be fleshy lobes of the labium, or a cluster of tubercles about the head, or a tentacle-like process from the mid-ventral line of the mesothorax. This stage is called by Wheeler the “trophidium.”

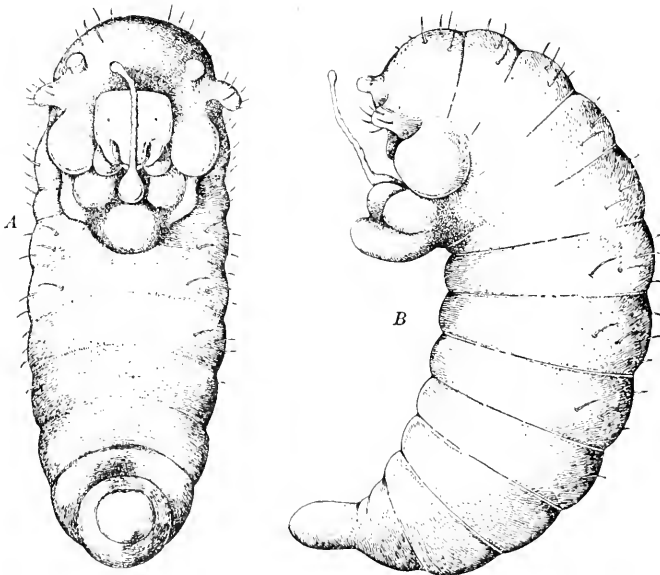

LARVAL STAGES OF *PACHYSIMA ÆTHIOPS*.

(A) Ventral and (B) lateral views of first larval stage (“trophidium”) of *Pachysima æthiops*.

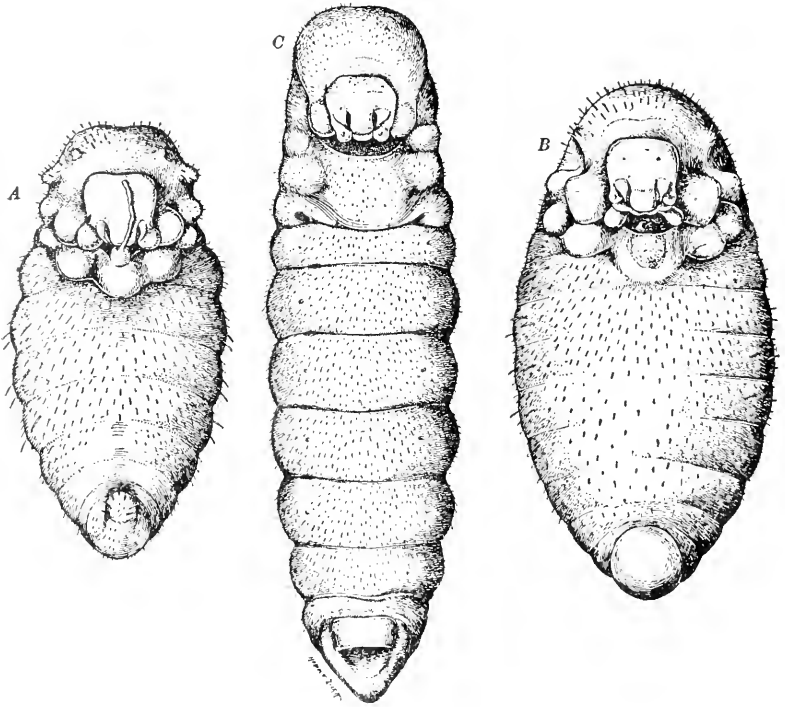
LARVAL STAGES OF *PACHYSIMA* ÆTHIOPS.

(A) Second, (B) third, and (C) fourth (full-grown) larval stages of *Pachysima æthiops*.

The exudation is mainly blood-serum plus nutrient material contributed by the fatty body. It probably escapes under pressure through microscopic pores in the cuticle. There may also be exudation from special skin-glands. This may evaporate from or be licked off special tufts of setæ.

According to Wheeler, who confirms Rabaud's observations on some tropical wasps, there is a relationship of nutritive exchange between the larvæ of some ants and the workers. For this the term "trophallaxis" is proposed, and the theory suggested is that this interrelation lies at the basis of the social life of ants. In a widening vortex it may pass from an exchange between larva and female to an exchange between adults, or between ants and their guests, or between ants and Aphides. The paper is one of extraordinary interest. J. A. T.

Dimorphic Colouring in Lepidoptera.—ARNOLD PICTET (*C. R. Soc. Phys. Hist. Nat. Genève*, 1918, 35, 17-22). The author has calculated that 99.6 p.e. of insects are eliminated in early life, hence the large number of eggs usually laid by the female. Homochromic or protective

coloration does not save more than a small percentage, but if it were not established there would in some cases be no survivors at all. In some Lepidoptera the male shows cryptic coloration, while the female does not; and the female is often much larger. In some such cases the male insect hatches out first, in *Lymantria dispar*, 6 to 12 days before the female; in *Macrothylacea rabi*, 4 to 10 days; in *Malacosoma neustria*, 4 to 10 days; in *Lasiocampa quercus*, 3 to 13 days; in *Saturnia pavonia*, 5 to 13 days. The males hatched out first will have to wait some days before mating, therefore cryptic colouring is more important for the males. The female may be immediately mated, and the egg-laying may be finished the day after hatching, if not on the same day. In twenty-two species where the sexes are alike in colouring and size it was found that the duration of the life-history up to the day of hatching is precisely the same in the two sexes. Mating takes place at once, and survival is not affected by conspicuous colours or the absence of cryptic coloration. In species where both sexes are protectively coloured there is often an interval between the hatching of the two sexes. Sometimes the males emerge first, sometimes the females. Therefore both must have defences, such as cryptic coloration. This does not save the majority, e.g., from other Arthropods which do not depend much on vision; but it saves the requisite number of the surviving minority from the eyes of Mammals, Birds, and other Vertebrates.

J. A. T.

Inheritance of Extra Bristles in *Drosophila*.—EDNA M. REEVES (*Univ. California Publications, Zoology*, 1916, **13**, 495–515, 1 fig.). There is some evidence of Mendelian inheritance (with three factors) concerned in the development of extra bristles in the fruit-fly (*Drosophila melanogaster* Merg. = *D. ampelophila* Leow.) But there is also some evidence in favour of regarding this as a fluctuating variation. Thickened hairs gave evidence of a partial inheritance. There is no sex-linkage involved in the extra bristles. Selection for an increased number of extra bristles made no advance, the tendency being to return to the conditions of four and five bristles. High-grade parents do not produce high-grade offspring; in fact there is no definite relation between parent and offspring as to the number of extra bristles.

J. A. T.

Coloration of Tiger-beetles.—VICTOR E. SHELFORD (*Illinois Biological Monographs*, 1917, **3**, 395–532, 32 pls.). The colour-patterns of Cicindelidæ are definitely related to elytral structures. Longitudinal stripes in which pigment usually occurs lie in the area of the chief tracheal trunks; there are seven cross-bands in which pigment does not develop; the second and third and the fifth and sixth of these are often joined to make one of each pair. Pigment usually occurs about the bases of setæ, which usually lie in the lines of the tracheæ. In ontogeny the elytra show a spotted condition corresponding to the system of cross-bands and longitudinal stripes. The longitudinal stripes are usually more pronounced. The origin of the various markings in the group is traced. The colour-patterns and the structures to which they are related constitute a mechanism, the directions of movement of which are limited, i.e. easier in some directions than others. The colour-pattern plans

break when the related structures do. Hereditary changes and modifications due to stimulation (e.g. high temperature) during ontogeny are in the same direction. Laws governing the mechanism are the same throughout. Orthogenesis is illustrated, but all the ontogenetic changes cannot be said to illustrate recapitulation of phylogeny. During ontogeny some species pass through colour-stages corresponding to geographic races, but the biogenetic law of recapitulation is of doubtful application. The brilliant colours are due to thin surface films of material having properties of metals. Changes in colour during ontogeny are from green and blue toward red or brown, except in *Cicindela lepida*, where it is from yellow (gold) to green. The centre of distribution is about the Indian Ocean. Experimental modifications nearly duplicate certain geographic races in conditions similar to those in the experiment. The more brilliant colours are in warm arid localities. J. A. T.

Leaf-eating Crane-fly.—A. E. CAMERON (*Ann. Entomol. Soc. America*, 1918, **11**, 67–89, 18 figs.). An account is given of the life-history of *Cylindrotoma splendens* Doane from Vancouver Island, which is peculiar in that the larvæ feed openly on Bryophytic and Spermatophytic plants. The female cuts a slit in the epidermis on the under side of the leaf by means of her saw-toothed ovipositor. The sub-translucent glistening white eggs are partially concealed. The period of incubation is two to three weeks. The newly hatched larvæ eat holes in the leaves; their movements suggest those of “looper” caterpillars; they hibernate among dead leaves in their second stage; they resume feeding in spring; they pupate in the middle of May; the pupal period lasts for six to ten days; there are at least three moults before pupation, one before and two after hibernation. J. A. T.

Viability of Mosquito-eggs.—A. BACOT (*Parasitology*, 1918, **10**, 280–3). Eggs of *Stegomyia fasciata* may remain dormant out of water, but in humid atmosphere, for fifteen months, and develop thereafter. Immersed eggs remained dormant for five months, but the limit is probably about a year. J. A. T.

The Pear Thrips.—A. E. CAMERON and R. C. TREHERNE (*Bull. Dept. Agric. Canada*, 1918, **15**, 1–51, 22 figs.). Blighting of fruit-trees in Vancouver Island is often due to *Tæniothrips inconsequens*, the life-history of which is discussed. An account is given of the egg, the larva, the prepupa, the pupa, and the adult. The duration of the adult's life in natural conditions is probably about four to six weeks. The mature larvæ migrate from tree to soil, the adults migrate from soil to tree. A careful account of the ovipositor and of oviposition is given. No male has been seen in America, but a solitary specimen was found by Collinge in England. Parthenogenesis is thus the normal mode of reproduction. Unlike parthenogenetic Phasmids and Aphids, the Pear Thrips produces only one generation in the year. J. A. T.

Rectal Tracheation of Dragon-fly Larva.—ANNA M. CULLEN (*Proc. Acad. Nat. Sci. Philadelphia*, 1918, 75–81, 2 figs.). In the larva of *Argia putrida* there seem to be two areas of respiration in the hind-

gut, a small one in the seventh segment, a larger one in the eighth and ninth segments. The respiration of the former may be carried on through the tracheæ supplied by branches of the right and left visceral tracheæ. The larger area is supplied through the branches of the right and left dorsal rectal tracheæ and the right and left lateral rectal tracheæ. There are also caudal gills, and respiration may take place also all over the surface of the body through the thin wall. J. A. T.

Rectal Tracheæ of Dragon-fly Larva.—JANET P. JAMIESON (*Proc. Acad. Nat. Sci. Philadelphia*, 1918, 81-84, 2 figs.). The rectal epithelium of the larval *Argia talamanca*, which lives by waterfalls, has three main longitudinal folds. There are two main longitudinal tracheæ, the branches of which are traced. All have a black pigment. J. A. T.

Hind-gut and Rectal Tracheæ in Dragon-fly Larva.—MITCHEL CARROLL (*Proc. Acad. Nat. Sci. Philadelphia*, 1918, 86-103, 6 figs.). An intimate description is given of the hind-gut of *Mecistogaster modestus*. Six divisions are recognized, five of them with epithelial folds. The distribution of the tracheæ is dealt with. The tracheole supply of the hind-gut is not rich. All the tracheal twigs end on the basement membrane side of the thick columnar epithelium. The only part of the rectum that has a tracheal supply is the columnar epithelium. It seems improbable that any diffusion takes place between the gases in the rectal tracheoles and those in the water in the rectum. Yet the larvæ can live without their caudal gills. Perhaps the blood in the longitudinal folds of spongy or reticulate tissue captures oxygen from the water in the rectum. J. A. T.

Experiments on Respiration in Larval Dragon-flies.—JOSEPH H. BODINE (*Proc. Acad. Nat. Sci. Philadelphia*, 1918, 103-12, 3 figs.). Zygopterous larvæ (*Ischnura* and *Enallagma*) breathe by means of the rectum from the time of hatching until transformation. Caudal "gills" serve only in a mechanical way, as rudders in the locomotion of the larvæ. Respiration through the skin of the larva is doubtful, but if it takes place it is only in a slight degree, not supplying enough oxygen for the respiratory needs of the larva. Regular rhythmic contractions of the rectum take place throughout the aquatic life of the larvæ. The rhythm of rectal contractions is not interfered with by removal of the caudal "gills." J. A. T.

Spermatogenesis of an Orthopteron.—J. MACHIDA (*Journ. Coll. Agric. Univ. Tokyo*, 1917, 6, 215-44, 3 pls.). The phases of spermatogenesis in *Atractomorpha bedeli* are described in detail. The first spermatocyte mitosis is a transverse reduction-division; the second is a longitudinal equational-division. The longitudinal cleft in the spermatogonia at least appears to be a true longitudinal split. Some deeply stained nucleoli always appear in every resting stage of the spermatogenesis after the chromosomes have diffused, but these bodies do not seem to give rise to the accessory chromosome or any other. The accessory chromosome is distinctly seen in the telophase of the secondary spermatogonia. Throughout the growth period and the

prophase of the first spermatocytes the accessory chromosome occupies its position attached closely to the nuclear membrane. It does not divide in the first spermatocyte mitosis, but passes over to one of the daughter-cells, being therefore absent in one-half of the second spermatocytes. In the second spermatocytes, in which it is present, it divides longitudinally. It becomes concealed for a time among the mass of the chromosomes, appearing again when these diffuse. The idiozome, the mitochondria, the nebenkern are also discussed. J. A. T.

Biology of Chermes.—H. M. STEVEN (*Proc. Roy. Soc. Edinburgh*, 1918, 37, 356). The genera *Chermes* s. str. and *Cnaphalodes* are found to have two separate cycles in Britain :—(a) A cycle of two generations, Fundatrix and Gallicola non-migrans; and (b) a cycle of five generations, Fundatrix, Gallicola migrans, Colonici, Sexupara, and Sexuales. Whether the cycles are those of separate species or of biological races of one species can only be determined by further research. The non-migrating forms are more serious enemies to spruce than are the migrating forms. The collective damage to larch by Colonici of *Chermes* and *Cnaphalodes*, and by Progredientes of the latter, is serious in Britain. The author adheres to Blochmann's theory that the spruce was the original host of the Chermesidæ, and that the winged forms are transported by the wind to trees of other genera, and there adapt themselves to feeding and breeding, the migration back to the spruce being similarly effected. J. A. T.

Notes on Earwigs.—H. H. BRINDLEY (*Proc. Cambridge Phil. Soc.*, 1918, 19, 167-77). Evidence is submitted that the dimorphism of the forelegs in males of *Forficula auricularia* is not the result of or influenced by Gregarine infection, as Giard believed. Notes are made on other parasites besides the Gregarine *Clepsylrina orata*, viz. *Filaria locustæ*, the Tachinid fly, *Rhacodineura antiqua*, in *Forficula tomis*, scarlet mites, and fungoid parasites. As regards food, it seems established that many garden plants are seriously attacked by earwigs, and that the latter can continue healthy on a purely vegetarian diet. But earwigs sometimes kill and devour other insects larger than themselves, besides small insect larvæ. Only thirteen species of birds seem to have been reported as capturing earwigs, and most of them as very sparingly. They may be distasteful, and a large number together emit a well-defined odour. Domestic fowls always eat them readily. J. A. T.

Biology of Phthirus pubis.—G. H. F. NUTTALL (*Parasitology*, 1918, 383-405, 9 figs.). The crab-louse appears to be parasitic chiefly on persons leading an active sexual life. So far it has only been twice recorded on another host than man, namely, the dog. It may spread from the pubic and perianal region to other parts, e.g. abdomen, breast, and axilla. It occurs very rarely about the eyelids. The head is rarely infested, because the hairs are too close together. Infestation mostly occurs by shed hairs bearing larvæ or adults. The adults cling continuously to hairs, moving from one to another. The females seem to be more numerous than the males in the ratio of 3 : 1. A female raised experimentally laid three eggs per day, with a total of twenty-six; the

hatching (on the leg) lasted seven to eight days; there are three moults and larval stages before maturity is reached; the life-cycle is completed in twenty-two to twenty-seven days (on the leg). The feeding is practically continuous, interrupted only by moulting, and the insects die very quickly when removed from the host. Warmth attracts them when they are removed from man. (See also p. 304.) J. A. T.

δ. Arachnida.

Notes on Mussel-mite.—ERNEST CARROLL FAUST (*Trans. Amer. Micr. Soc.*, 1918, **37**, 125-8, 1 pl.). There is a wide range of variability in the species *Unionicola aculeata*, and some of the peculiarities of the material dealt with are recorded. Special attention is directed to the heteromorphic fourth leg of the male. The external male genital organs are very complicated, consisting of an ornate sculpture of chitin, to which prominent muscle-bands are attached. As Koenike has shown, the mite is free-swimming during a considerable part of its life, and seeks the mussel at times of metamorphosis and propagation. Those dealt with in this paper were embedded in thin cysts in the subdermal connective-tissue of the mantle and foot, and had done no harm outside the cyst. J. A. T.

Mange Mites.—E. L. TROUESSART (*Bull. Soc. Zool. France*, 1918, **42**, 151-8, 3 figs.). The pilicolous Sarcoptids of mammals form a series parallel to that of the plumicolous Sarcoptids of birds. In the latter, however, the most marked peculiarities are seen in the adaptations the males show for catching and holding the females; in the former the most marked peculiarities are adaptations for gripping the hair, and may be seen in both sexes. Some of the varying fixing organs are figured and described. The author establishes two new genera, *Euryzonus* (depressed and elongated), and *Atopomelus* (compressed laterally). J. A. T.

Intracellular Digestion in an Acarid.—ED. REICHENOW (*Boll. R. Soc. Espan. Hist. Nat.*, 1918, **18**, 258-73, 4 figs.). In a Gamasid, *Liponyssus saurarum* Oudemans, which is a carrier of the blood parasites of the wall-lizard, there is in the mid-gut a process of intracellular digestion. In the cells of the lining epithelium there are to be seen red blood corpuscles of the host in process of digestion. It appears that there is little or no secretion of digestive juice into the lumen of the gut, though bacterial action may have a liquefying effect. The epithelial cells act as phagocytes, and exhibit intracellular digestion, as in lower Metazoa. Oocytes occur among the epithelial cells of the intestinal wall and take a direct part in the absorption. The author is inclined to think that the limits of the occurrence of intracellular digestion are much wider than has been supposed. J. A. T.

Mites as Disease-carriers.—G. TEODORA ("Redia," 1918, **13**, 105-14.). This paper discusses in particular the species of mite, apparently *Leptus akamushi*, which is the vehicle of a Japanese river-fever. Attention is also directed to *Dermacentor venustus*, which

appears to disseminate the spotted fever of the Rocky Mountains. African recurrent fever, due to *Spirochæta duttoni*, is known to be spread by *Ornithodoros moubata*; European recurrent fever, due to *Spirochæta recurrentis*, is probably spread by *Argas persicus*, or by the bed-bug; American typanosomiasis, due to *Trypanosoma cruzi*, may be carried by *Ornithodoros moubata* and *Rhipicephalus sanguineus*; and a recurrent fever of Persia is said to be carried by *Ornithodoros tholozani* and *O. canestrinii*.
J. A. T.

New Harvest Mite.—A. BERLESE (“*Redia*,” 1918, 13, 93-7, 1 pl.). A diagnosis is given of *Parathrombidium paolii* g. et sp. n., a beautiful form found in Apulia, underground, among the oothecæ of *Dociostaurus maroccanus*. The author shows how the new genus differs from *Eutrombidium*, *Neotrombidium*, *Microtrombidium*, and other related genera.
J. A. T.

6. Crustacea.

Reactions of Sand Crab.—HAROLD T. MEAD (*Univ. California Publ. Zoology*, 1917, 16, 431-8, 6 figs.). Experiments on *Eremita analoga*, common on the wave-washed parts of the sandy beaches of California, show that the animals tend (1) to run down slopes, and (2) to go towards the ocean, when within 200 feet at least of it, although their view of the ocean be intercepted. A 7 p.c. slope away from the ocean neutralizes the oceanward tendency. Normally the eyes count for much in guiding the crabs to their feeding beds (they catch small organisms with their feathery antennæ), and in apprising them of the proximity of birds and other enemies. No “learning” the way out of a simple labyrinth was detected. The range of stimuli to which the animals are susceptible is comparatively narrow.
J. A. T.

Sensory Structures of Crab's Claw.—I. SALKIND (*Annales Sci. Nat. Zool.*, 1918, 2, 121-31, 5 figs.). The forceps or great claw of the common shore-crab (*Carcinus mænas*) is very sensitive, especially near the tips of the propodite and dactylopodite. It bears three kinds of sensory structures: (1) crypts in the cuticle innervated by nerve-fibres, (2) peripheral nerve-ending in simple contact with the cuticle, and (3) complex rosette-shaped structures with a vibratory apparatus in the centre.
J. A. T.

Further Observations on *Xenocœloma brumpti*.—M. CAULLERY and F. MESNIL (*Bull. Soc. Zool. France*, 1918, 42, 169-78, 5 figs.). This remarkable Copepod is embedded between the ectoderm and the somatopleure of *Polycirrus arenivorus*, and has neither appendages nor digestive canal, nor nervous system. It is enveloped in epithelium continuous with the ectoderm of the Annelid, and its axial cavity is continuous with the cœlom of its host. The united stage has not been found. A description is given of a “meandriform” organ, of ovaries, oviducts, testes, and seminal vesicle. The hermaphroditism is noteworthy. The spermatozoa are filiform and very long. The nearest ally is *Saccopsis alleni*, with a distinct fixing apparatus, which Brumpt found at Plymouth as a parasite of *Polycirrus aurantiacus*.
J. A. T.

Crustaceans from Interior of Australia.—CHAS. CHILTON (*Trans. R. Soc. Australia*, 1917, **41**, 475-82, 7 figs.). A small collection included *Hemiporcellio strzelecki* sp. n., *Cubaris claytonensis* sp. n., *Apus australiensis*, *Estheria packardii*, a species of *Boeckella*, and a few other forms. Collectors of small Crustacea are advised to take samples of dried mud from the water-holes and hatch out the Crustacea at leisure. "This would be easier and more likely to lead to the discovery of new forms than trying to collect the animals on the rare occasions when the explorer finds the pools are full after rain." J. A. T.

Fossil Species of Phreatoicus.—CHAS. CHILTON (*Journ. R. Soc. N.S.W.*, 1918, **51**, 365-88, 13 figs.). From shales near Sydney, belonging to Trias-Jura, or perhaps Upper Trias, R. J. Tillyard obtained several specimens of a fossil Isopod, which he provisionally named *Phreatoicus wianamattensis* sp. n. This is confirmed by Chilton, who places the fossil species near *P. australis*. The genus belongs to a primitive group of Isopods. J. A. T.

Australian Isopods.—CHAS. CHILTON (*Trans. R. Soc. Australia*, 1917, **41**, 391-404). A survey is taken of the Australian species of *Serolis*, including *S. bakeri* sp. n., near *S. minuta*. The genus is marked by the much depressed body, circular or oval outline, and widely developed epimera. The first pereon segment has the epimeral portion very largely developed and produced forwards so as to enclose the head-shield on both sides. A description is given of the hitherto unknown adult male of *Deto marina* Chilton. J. A. T.

Respiratory Mechanism of Shore-crab.—ROBERT K. S. LIM (*Proc. R. Soc. Edinburgh*, 1917-18, **38**, 48-56). The direction of the respiratory current in *Carcinus maenas* is postero-anterior, whether the crab is above the sand or buried in it. But reversal may occur, more frequently when the crab is buried, or when a strong ink suspension is used in experiment. The sub-branchial cleft may be divided into four separate spaces which are in direct communication with gaps between certain gill-origins, the whole constituting the sub-branchial inlets, the direction of which determines the direction of the inhaled currents. The relation between the position of the gills and these inlets allows for a convenient and maximal flow. J. A. T.

New Isopod from British Guiana.—WALTER E. COLLINGE (*Journ. Linn. Soc. Zool.*, 1918, **34**, 61-3, 1 pl.). A description is given of *Paracubaris spinosus* g. et sp. n., a terrestrial Isopod, one of the Cubaridae, differing from *Cubaris* in the form of the cephalon, antennæ, maxillipedes, and the first mesosomatic segment, and in the extension of the uropods beyond the telson. It is of special interest in that it represents a type of Cubaridae only known as yet from the Western Hemisphere. J. A. T.

Oral Appendages of Isopoda.—WALTER E. COLLINGE (*Journ. Linn. Soc. Zool.*, 1918, **34**, 65-93, 3 pl.). The first maxillæ and the maxillipedes of Idoteidae are minutely described in twenty-four types, e.g.

with reference to the number of spines on the inner lobe of the former and the number of joints in the palp of the latter. It is proposed to divide the sub-order Valvifera into two groups:—Astacillinea (Astacillidæ, Chætiliidæ, Amesopodidæ), and Idoteina (Idoteidæ, Pseudidotheidæ, Holognathidæ).
J. A. T.

Siboga Crabs.—J. J. TESCH (*Résultats Explor. Siboga*, 1918, *Monographie* 39c, 1–148, 6 pl.). The Siboga Indo-Pacific collection of Catometopous Crabs in the five families: Hymenosomidæ, Retroplumidæ (= Ptenoplacidæ), Ocypodidæ, Grapsidæ, and Gecarcinidæ, comprised sixty-eight species. Of these only four were new, which is explained by the fact that the Siboga was mostly concerned with deep water, whereas the Ocypodidæ, Grapsidæ, and Gecarcinidæ are shore animals, and have, moreover, been largely collected of recent years. The author has discovered numerous new facts, and he has extended his range beyond the Siboga material so as to present a synopsis of all the known Indo-Pacific species.
J. A. T.

British Occurrence of *Nematoscelis megalops*.—O. M. JORGENSEN (*Report Dove Marine Laboratory*, 1918, New Series, 7, 65, 1 fig.). Large numbers of the Schizopod *Nematoscelis megalops* Sars. were found dead in high-water sandy pools at Cullercoats. It is an oceanic form occurring in the North and South Atlantic; it is recorded also from the Indian Ocean, the Mediterranean, off the Labrador and Nova Scotia coasts, and in the Irish Sea. This appears to be the first record of its occurrence on the eastern coast of Great Britain. The largest specimens were 20 mm. long. Amongst them there were specimens of the large form of *Euthemisto compressa* Goës.
J. A. T.

Notes on Development of Shore-crab.—OLGA M. JORGENSEN (*Report Dove Marine Laboratory, Cullercoats*, 1918, New Series, 7, 62–4). The length of the first larval or protozoæa stage of *Carcinus mænus* appears to be between twenty and thirty hours (in one case about forty-four hours). The second stage or first zoæa appears to last from forty-eight to seventy-two hours. Average length measurements for the first three stages are given:—protozoæa, 1.7 mm.; first zoæa, 1.95 mm.; and second zoæa, 2.1 mm.
J. A. T.

Annulata.

Lymph-glands of *Pheretima*.—G. S. THAPAR (*Records Indian Museum*, 1918, 15, 69–76, 1 pl.). In earthworms of this genus there are segmentally arranged whitish glands on each side of the dorsal blood-vessel throughout the intestinal region. The capsule of the gland is peritoneal in origin, and may be regarded as an irregular sac-like forward bulging of the septum which has become very delicate. The main mass of the cells of the glands consists of leucocytes with a phagocytic function as Schneider showed. The cœlomic fluid is yellowish; it contains leucocytes, minute colourless non-granular cells, yellow cells,

and cells with refractile granules or globules. The cœlomic pouches or tunnels described by Beddard and Fedarb in *Pheretima posthuma* were found by Thapar only in one specimen out of many, and appear therefore to be inconstant. J. A. T.

Oligochæta of Inlé Lake.—J. STEPHENSON (*Records Indian Museum*, 1918, 14, 9–18, 5 figs.). Specimens of *Branchiura sowerbyi* have enabled the author to demonstrate the presence of a penis (perhaps a pseudopenis, according to Michaelsen's definition), and to show that in this form, as in *Kawamuraia japonica*, the muscular cœlomic chamber is the apparatus for extrusion. The number of gills was forty to forty-seven in the shorter worms, and over ninety in the longer specimens. One fragment had 140 pairs. They vary considerably in length. The description of a posterior sucker in *Chætogaster beugalensis* seems to be a mistake. The posterior attachment is effected by hooked setæ. J. A. T.

Monograph on Polychæts.—R. HORST (*Monographie Siboga Expedition*, 1917, 24 1b, 45–143, pls. xi–xxix). This portion of the Siboga monograph on Polychæta Errantia deals with the two families Apheroditidae and Chrysopetalidae, and includes a large body of microscopic detail in regard to the setæ and scales. J. A. T.

Nematohelminthes.

Reproduction in Nematodes.—PAUL S. WELCH and L. P. WEHRE (*Trans. Amer. Micr. Soc.*, 1918, 37, 141–76). Two species, *Cephalobus dubius* Maupas and *Diplogaster ærivotra* Cobb, were studied in culture continuously for over three years. In the former no males were found; the average duration of oviposition is sixteen days; the average number of eggs per individual was 139; the larvæ emerge in 2·5–4 days after oviposition and reach maturity in eight to fourteen days; growth usually ceases three to six days after sexual maturity; the average daily increase in body-length is about 0·026 mm.; the length of life varies from twenty to sixty-one days. In *Diplogaster ærivotra* the sexes are separate; one female may unite with several males and one male with several females; fertile ova follow mating for a time, after which infertile ova are laid until a second mating, after which the same sequence usually occurs; it seems that the supply of spermatozoa received by the female becomes exhausted; viviparity occurs from time to time, and the young as produced devour the mother from within; the viviparous young develop from fertilized eggs and develop into normal males and females; females are in the majority, but males are common; the cessation of growth occurred on the eighth to ninth day; the length of life following cessation of growth varies from six to fifteen days; the average length of life was about eighteen days for both sexes. J. A. T.

Toxic Constituent of Nematodes.—TORAI SHIMAMURA and HAJIME FUJII (*Journ. Coll. Agric. Univ. Tokyo*, 1917, 3, 189–258, 4 figs.). From the perivisceral fluid and the dried powder of *Ascaris lumbricoides*

and *A. megaloccephala* has been isolated a highly toxic albumose-peptone ("Askaron"). It produces symptoms like those associated with infection with Ascarids. It is present in *Filaria immitis*, *Sclerostomum vulgare*, *Oxyuris curvula*, and *Trichocephalus depressiusculus*; and also in bot larvæ. Horses are the most susceptible; then, in descending order, guinea-pigs, dogs, and rabbits. Rats and mice are refractory. After poisoning with Askaron a high specific cellular resistance is rapidly established.

J. A. T.

Platyhelminthes.

Cestodes of Hilsa.—T. SOUTHWELL and BAINI PRASHAD (*Records Indian Museum*, 1918, 15, 77-88, 2 pls.). In the lateral muscles of the anadromous fish *Hilsa ilisha* were found larval (cystic) stages of *Rhynchobothrium ilisha* sp. n.; and practically all stages between these and the adult tapeworms were found in the intestine of the shark *Carcharinus gangeticus* which had swallowed the *Hilsa*. This is the first case in which the life-history of an Indian Cestode has been worked out. The cysts, containing the young tapeworm, consisted of a club-like head and a long tail-like structure which was capable of considerable movement, and appeared to help to moor the parasite in the intestine, or to retain it in the lumen until the young tapeworm had time to emerge. Cysts of *Syudesmobothrium filicolle* were also found in the lateral muscles of *Hilsa*. The mesentery and liver yielded an interesting doubtful form, provincially named *Ilisha parthenogenetica*. The generic characters are:—Small parasitic leaf-like worms occurring in cylindrical cysts. Anteriorly there is a rostellum with four unarmed suckers symmetrically arranged round its base. Sexual organs and pores are absent. The development is parthenogenetic. The young are quite like the adult, and find their way out of the parent, and repeat the same life-history.

J. A. T.

Hymenolepis nana Siebold and H. murina Dujardin.—F. H. STEWART (*Records Indian Museum*, 1916, 12, 295-8, 2 pls.). Some authorities regard *H. nana* in man as only a dwarfed variety of *H. murina* in the rat; others regard them as distinct species. If the two are identical it is probable that man is infected as a rule by the contamination of food by rats. The author was unsuccessful in trying to infect two rats with *H. nana* from man, and this negative result suggests that the two species are distinct. A short account is given of microscopic sections of *H. nana*, with especial reference to the reproductive organs.

J. A. T.

North-American Trematodes.—H. W. STUNKARD (*Illinois Biol. Monographs*, 1917, 3, 287-394, 11 pls.). This paper deals with the structure and relationships of Polystomidae (differing from all other known Heterocotylea in being endoparasitic), Aspidogastridae (both ectoparasitic and endoparasitic, of direct development or with an intermediate host, as adults found in both vertebrates and molluscs), and

Paramphistomidae (the only forms retaining a primitive posterior sucker). Four new species of *Polystoma* are described. Among Paramphistomidae the new genus *Alassostoma* is established, characterized by the presence of large oral evaginations which open independently into the oral sucker, an œsophageal bulb of concentric muscle lamellæ, a hermaphrodite duct, germ glands near the middle of the body in the median line, both testes anterior to the ovary, and other genital peculiarities. Important also is the new genus and species *Zygocotyle ceratosa*, with subterminal oral sucker, the posterior sucker divided or provided with a caudal overhanging lip, separate openings to the male and female ducts, and without a cirrus sac. Considerable light is thrown on the inter-relationships of the families of Trematodes.

J. A. T.

New Amphistomid Trematode from a Fish.—S. GOTO and Y. MATSUDAIRA (*Journ Coll. Sci. Univ. Tokyo*, 1918, **39**, Art. 8, 1-19, 1 pl., 2 figs.). A new parasite, *Dissotrema papillatum* g. et sp. n., was found in the rectum of *Siganus fuscescens*, a marine fish distributed from Tokyo to the Philippines. Its appearance suggested the genus *Paramphistomum*, but it seems to require the erection of even a new family. For this the following diagnosis is given:—Digenea with more or less cylindrical body; with oral sucker close to the front end, and acetabulum close to the hind end; with long convoluted pre-pharynx and well-developed pharynx; ovary pre-testicular; common genital aperture ventral and median; no buccal pouches, no ventral pouch.

J. A. T.

American Stephanophialinæ.—ERNEST CARROLL FAUST (*Trans. Amer. Micr. Soc.*, **37**, 1918, 183-98, 2 pl.). In this sub-family of Trematodes (in the family Allocreadiidæ) the integument is usually aspinose, the circumoral papillæ are always six, the yolk glands extend from the region of the pharynx to the posterior end of the body, and the excretory bladder extends to the anterior border of the anterior testis. There are three genera, *Stephanophiala*, *Crepitostomum*, and *Acrolichanus*, and all the species (except *C. metacus* Braun) are parasites of fresh water fishes. The new species, *S. vitelloba*, is described. No life-history has been worked out, but the cercariæ probably have pigmented eye-spots and a heavy tail. It is probable that the cercariæ and preceding parasitic stages occur in water-snails, and the distomula in aquatic insects or crustaceans.

J. A. T.

Reactions of Fresh-water Turbellarian.—BERNOL R. WEIMER (*Trans. Amer. Micr. Soc.*, 1918, **37**, 111-24, 1 pl.). Experiments with *Phagocata gracilis* show that these little animals exhibit a preference for a smooth surface rather than for a rough one. That is to say, the animal is positively thigmotactic to a smooth surface. This is not due to varying amounts of mucous secreted. The animal is positively geotropic (like unfed *Planaria maculata*) and strongly negatively phototropic. The rate of locomotion is the same for rough and smooth surfaces. A histological study of specimens from Morgantown, W. Va., showed no cilia on the dorsal surface, but Woodworth described them there on specimens from New England.

J. A. T.

Triclad from Inlé Lake.—TOKIO KABURAKI (*Records Indian Museum*, 1918, 14, 187-94, 1 pl.). Three new species of *Planaria* are established, and the reproductive system in particular is described in considerable detail. J. A. T.

Echinoderma.

Experiments with Larval Echinoids.—E. W. MACBRIDE (*Proc. Roy. Soc.*, 1918, B., 90, 323-48, 7 pls., 5 figs.). If the larvæ of *Echinus miliaris* be exposed to the action of hypertonic sea-water for a week commencing with the fourth day of development, many of them will develop on the right side as well as on the left a hydrocœle or water-vascular rudiment. In connexion with this second hydrocœle all the structures which normally develop in connexion with the left hydrocœle may make their appearance, viz. spines, tentacles and dental sacs. If the larvæ be starved during the first week of their existence and then placed in favourable conditions as regards food and space, they will continue their development, but many of them will be devoid of both pedicellariæ and hydrocœle, and will have in place of both a group of pointed spines on each side. Such larvæ will, in the majority of cases, be devoid of madreporic pore and axial sinus, but will possess a well-developed madreporic vesicle.

As hypertonic sea-water may unlose the potentiality of an unfertilized ovum and lead to development, it is probable that the formation of a right hydrocœle in larvæ exposed to hypertonic sea-water implies the actualization of a potentiality which is normally in abeyance. The probable *Cephalotiscus*-like ancestor of Echinoderms may perhaps be credited with the possession of two hydrocœles. In the proto-echinoderm one hydrocœle alone persisted. It is suggested that a small area of the coelomic wall gave origin to the hydrocœle bud or buds, and that hormones producing morphogenic modifications were stored in the hydrocœle bud. "When this area under the influence of stimulation produced two hydrocœles instead of one, these hormones were shed abroad on both sides of the larva, although they had only been evolved in connexion with the left side. The body of an embryo is not, like a picture puzzle, a mosaic of pieces each destined to form a particular organ, but consists of sheets of indifferent material 'without form or void' on which a formative 'something' works and evokes the beautiful detail of the adult structure." J. A. T.

Unstalked Crinoids of Siboga Expedition.—AUSTIN H. CLARK (*Résultats Explor. Siboga*, 1918, Monographie 42b, ix + 1-300, 28 pl., 17 figs.). The collection made by the Siboga, at the Aru Islands, Sulu Archipelago, etc., included 149 Comatulids, of which 64 were new. Among the features of special interest may be noted:—A new type (*Atopocrinus*) with five arms and no basals, extremely small species of *Monachocrinus* and *Bythocrinus*; a very large species of *Democrinus*; a new type of *Atelecrinus*, with short cirri and very large basals; extremely small species of *Compsometra*; small species of *Decametra*; *Psathyrometra*; a series of types from the warm, shallow and muddy Java Sea, which are marked by long and slender long-segmented cirri; the most ornate

Comatulid known (*Strotometra ornatissimus*), which exhibits an exaggerated eversion of the distal edges of the brachials, finding a parallel only in the pentacrinite genus *Comastrocrinus*. J. A. T.

Cœlentera.

New Australian Hydroids.—E. A. BRIGGS (*Rec. Australian Mus.*, 1918, 12, 27-47, 2 pls.). A description is given of two new Plumularids, *Aglaophema howensis* sp. n., near *A. sinuosa* Bale; and *Aglaophenopsis vaga* sp. n., which differs considerably from the four previously described members of this genus. These species were all recorded from North American coasts, so the discovery of a fifth on the coast of New South Wales is interesting. The genus is marked by the presence of a phylactogonium, which is a jointed, unbranched appendage springing from the proximal internode of the hydrocladium, and bearing a single row of sarcothecæ, and one or two terminal hydrothecæ. A revision is made of the Hydroids of Lord Howe Island. J. A. T.

New Sea-anemones from New Guinea.—GILBERT C. BOURNE (*Quart. Journ. Micr. Sci.*, 1918, 63, 81-90, 3 pls., 2 figs.). A description is given of four new species of *Phellia*, and a new genus *Decaphellia* is erected for a fifth new form, with the characters of *Phellia*, save that the capitulum has no musculature except for a mesogloæal sphincter at its distal extremity, and that there are only ten complete macromesenteries bearing longitudinal retractor muscles. The order of appearance of the tentacles in Phelliinæ is discussed. It is argued that the Phelliinæ must stand apart from the other sub-families of the heterogeneous Sagartiidæ (a group which has to be broken up), and must be approximated to the Halcampidæ. An interesting suggestion is made in regard to the application of genetic principles to questions of morphology and classification. The presence of a single unit character like acontia is not in itself such a positive mark of inter-relationship that all the forms possessing it must be united into a single family. J. A. T.

Irish Actiniaria.—T. A. STEPHENSON (*Proc. R. Irish Acad.*, 1918, 34, 106-64, 7 pls.). A collection made off Ireland includes *Carlygrenia desiderata* g. et sp. n., an Endocœlactid with six pairs of macromesenteries, *Actinostola atrostoma* sp. n., *Cymbactis gossei* sp. n., *Actinernus aurelia* sp. n., which is like a jellyfish, *Chondrodactis coccinea* sp. n., and two other new species of this genus. The paper includes much histological detail. The amœboid cells of the mesogloæa show considerable variety, and seem to have nervous as well as nutritive functions. J. A. T.

Nature of Madreporarian Skeleton.—G. MATTHAI (*Proc. Cambridge Phil. Soc.*, 1918, 19, 160-3). It seems highly probable that von Heider was right in regarding the Madreporarian skeleton as formed within the calicoblastic protoplasm. The calicoblastic ectoderm is now found to be a multiuneleated sheet of protoplasm devoid of cell-limits, i.e. a syncytium. In Aleyonarian and Madreporarians alike the skeleton seems to be formed within syncytial protoplasm according to physical laws under the presiding activity of the living protoplasm which directs

the complex skeletal architecture. The elements remain separate as spicules in most Aleyonarians, but are united to form a compact skeleton in others, and in all Madreporarians. "From this point of view, a separate calcareous piece of an Aleyonarian might be regarded as a diminutive corallum, and the corallum of a Madreporarian as a massive spicule, and finally, the formation of the Anthozoan skeleton would be essentially similar to the formation of membrane bone in Vertebrates."

J. A. T.

Reactions of Astræid Corals.—G. MATTHAI (*Proc. Cambridge Phil. Soc.*, 1918, **19**, 164–6). Observations were made on species of *Mavandrina*, *Isophyllia*, *Favia* and other genera. Ciliary movement passes the food-particle into the nearest oral aperture. The mouth dilates and the lip is directed towards the particle. The peristomial cavity is narrowed and deepened, which helps to roll the food-particle into the oral opening. There is an expansion of the tentacles of the affected oral disc and of adjacent oral discs. There is an eversion of the stomodæum and consequent exposure of the cœlenteric cavity and mesenterial coils. Then there is a restoration of the original condition.

A tentacle touched with a fine glass needle is withdrawn in a manner resembling pseudopodial movement. The movement spreads to neighbouring polyps. The amoeboid appearance of the movements is in conformity with the author's view that there are no muscular or nervous elements. The so-called muscular fibres at the base of ectoderm and endoderm are specialized connective tissue fibres which are without nuclei and form part of the mesogloea.

J. A. T.

Locomotion and Reactions of Charybdea.—NAOHIDE YATSU (*Journ. Coll. Sci. Univ. Tokyo*, 1917, **40**, Art. 3, 1–12, 5 figs.). In the Cubomedusan *Charybdea rastonii* the locomotor activity is not affected by transference from diffused light to direct sunlight. Whatever be the position of the medusa, the concretion is always at the lowermost end of the rhopalium. Its extraction does not affect swimming. Medusæ deprived of all their rhopalia usually cease to pulsate. In rare cases they may exhibit weak pulsations, or even swim for a short distance. The pulsation centre is located in the region of the rhopalium between the eye part and the stalk. In the upper third of the bell and in the region near the velarium the nerve plexus is probably lacking. Nerve stimuli are not transmitted in those regions. Fatigue comes to the pedalial muscles after fourteen to sixteen contractions as tested by the rhopalium-pedalium reflex. The mouth margin is spread out if the lower region of the subumbrella near the velarium is stroked. The phacellæ of this species are nine to ten in each inter-radial corner of the gastral cavity, and are arranged at irregular intervals. Each is composed of a very elastic stalk and a terminal tuft.

J. A. T.

Porifera.

Larvæ of *Grantia compressa*.—OLGA M. JORGENSEN (*Report Dove Marine Laboratory, Cullercoats*, 1918, New Series, **7**, 60–1, 9 figs.). Actively swimming Amphiblastulæ were collected by centrifuging from

a few sponges attached to a wire fixed in the mouth of a centrifuge tube. Some were still active after nineteen hours. The overgrowth of the larger granular cells was observed, and the fixation. Material not centrifuged showed that the Amphiblastulæ may be active for about twenty-four hours, and that fixation is complete two days after. The freshly-hatched larvæ swim at the surface except when disturbed, when they seek the lower layers for a time, but as proliferation of the granular cells increases the larvæ sink to the bottom, while still retaining their motile character for a short time.

J. A. T.

Sponges from Inlé Lake.—NELSON ANNANDALE (*Records Indian Museum*, 1918, 14, 75-9, 1 pl.). Only three species of sponges were found in this Shan Plateau lake, and these were varieties of cosmopolitan forms—*Spongilla lacustris*, var. *proliferens*, *S. fragilis*, var. *calcuttana*, and *Ephydatia plurivittis*, var. *intha* var. nov. The most noteworthy features of the new variety are the extreme softness of the body, which often collapses in drying into a mere slimy layer, and the regularity of the arrangement of the radiating fibres of the skeleton. The canals of the sponge shelter quite a little fauna of Annelids (e.g. three species of *Chætojaster*) and larval insects (including at least two species of Chironomidæ, a *Sisyra* (Neuropteran), and a caddis-worm without a protecting case.

J. A. T.

Protozoa.

New Amœbæ.—ASA A. SCHAEFFER (*Trans. Amer. Micr. Soc.*, 1918, 37, 79-96, 2 pls., 9 figs.). A description is given of *Amœba bigemma* sp. n., with tapering pseudopodia, with numerous small twin-crystals attached to "excretion spheres" in the endoplasm, with a single nucleus and chromatin granules aggregated in a spherical mass, with numerous small contractile vacuoles, with rapid movements—about 125 microns per minute. A second new form is *Pelomyxa lentissima* sp. n., very small and very sluggish, with a very much compressed body, with few pseudopodia except in the quiescent state, with a spherical nucleus and often two, with numerous contractile vacuoles, with numerous bacterial rods and few refractive bodies (starch grains). A third form, *P. schiedti* sp. n., the smallest species known, with rare pseudopodia, with fluid protoplasm, with movement by eruptive waves of endoplasm partly reflected back along the sides, with nucleus usually double, with numerous small contractile vacuoles, with very numerous starch grains and numerous bacterial rods.

J. A. T.

Respiration in Paramecium.—E. J. LUND (*Amer. Journ. Physiol.*, 1918, 47, 167-77). When *Paramecium* is removed from its native hay infusion in a well-nourished condition, to a condition of starvation in tap-water, the rate of oxidations in the cell decreases simultaneously with the disappearance of the greater amount of the deutoplasmic food reserves of the protoplasm. Feeding boiled yeast to a *Paramecium* which has been brought into a state of acute starvation by placing it in tap-water may increase the speed of the oxidations two or three times the original amount in the acutely starved but otherwise normal active

cell. This increase was not accompanied by cell division in these experiments. In connexion with the above results, it may be recalled that the rate of respiratory metabolism in mammals is markedly increased after ingestion of food, particularly of protein, while during starvation the respiratory metabolism in general decreases. J. A. T.

Blood-red Seas.—RAMÓN SOBRINO BUHIGAS (*Mem. R. Soc. Españ. Hist. Nat.*, 1918, **10**, 407–58, 5 pl., 3 figs.). The remarkable phenomenon of “hæmatothalassia,” or blood-red seas (of which a coloured picture is here given) is frequent off the coasts of Galicia. It has been attributed to superabundance of *Noctiluca*, and to Radiolarians, but investigation has shown it to be wholly due to a Dino-flagellate, *Gonyaulax polyedra*, which has a yellowish colour. It forms an important part of the food of sardines. J. A. T.

New Diatom-eating Flagellate.—ASA A. SCHAEFFER (*Trans. Amer. Micr. Soc.*, 1918, **37**, 177–82, 1 pl.). A remarkable flagellate, *Jenningsia diatomophaga* g. et sp. n., was found in marshes, among algae and diatoms. It is cylindrical, 180 microns in length by 40 in breadth, with a flagellum 150 microns long. The cuticle shows spiral striations bearing numerous movable club-shaped appendages about 1.5 microns in length. There is a large central nucleus, 35 microns in diameter, and a large contractile vacuole near the anterior end. There are several rod-like structures in the pharynx immediately anterior to a large mouth at the anterior end. There are numerous bodies like rings or strongly biconcave discs throughout the endoplasm, and sometimes large clear spheres as well. The animal creeps along, feeds exclusively on diatoms, and multiplies by longitudinal fission. J. A. T.

Relapsing Fever.—H. WERNER and O. WIESE (*Arch. f. Schiffs u. Trop. Hyg., Cassel*, 1917, **21**, 139). The authors examined eleven Pediculi (*Pediculus capitis*) which had been fed on a healthy man for five days and then fed on a relapsing fever patient at the height of the disease. Two of these, eight days later, showed the *Spirochæta recurrentes* multiplying in the body-cavity. The view that the disease may be carried by *P. capitis* was thus confirmed. J. E.

Studies on Infusoria.—EKENDRANATH GOSH (*Records of the Indian Museum*, **15**, part 3, Aug. 1918, 129) records a new species of *Anoplophrya* Stein (*emend* Cépède) to which he gives the name *Anoplophrya lloydii*. This species, from the seminal vesicles of the earthworm *Pheretima posthuma*, comes nearest to *A. striata*. It is a “dished” organism, elongately oval with a subtruncate posterior end curved longitudinally. Macro-nucleus irregularly ribbon-shaped, micro-nucleus small, spherical, placed at the side of the macro-nucleus. The recognized species of *Anoplophrya* now number seventeen, and the author gives a complete synopsis of the genus. He also records two new species of *Conchophthirus* Stein, *C. elongatus* and *C. lamellidens*, and a new type of *C. curtes* Englemann. The recognized species of *Conchophthirus* are

thus raised to eight, of which the author gives a synopsis. All the species under consideration are adequately illustrated, and a list of the literature on the subject is appended.

E. H.-A.

Protozoa of Lahore.—B. L. BHATIA (*Records of the Indian Museum*, 12, part 5, Sept. 1916, 77) contributes notes on ciliate Protozoa of Lahore. 1. On the occurrence of three contractile vacuoles in specimens of *Paramæcium caudatum*. The occurrence of the third contractile vacuole is recorded for the first time in this species (It had been observed by Butschli in *P. putrinum*). 2. The author records a number of the more striking Ciliata that he has come across in ditches and ponds in and about Lahore. The list is not claimed to be complete, but includes a new species *Holophrya indica* and a new species of *Loxophyllum fasciolum* (Ehrbg.) to which he gives the name *Punjabensis*. In addition to these, ten species are recorded, four of which are adequately described. The paper is efficiently illustrated, and full references to the literature are given.

E. H.-A.



BOTANY.

GENERAL,

Including the Anatomy and Physiology of Seed Plants.

On the Cretaceous Flora of Russian Sakhalin.—A. KRYSHTOFOVICH (*Journ. Coll. Sci. Imp. Univ. Tokyo*, 1918, 40, Art. 8, 15 figs.), as the results of his studies in the fossil flora of the Island of Sakhalin, in the summer of 1917, comes to the conclusion that this flora, hitherto regarded as exclusively Miocene, belongs in fact to several geological horizons, not only of the Tertiary period but also of the Cretaceous. It is found that the latter deposits play a more important part in the structure of Russian Sakhalin than was formerly assumed, and Heer (1878) included in the Miocene flora a *Nilssonia*, which is characteristically Mesozoic. A list of fossil plants obtained from all the localities worked is given, followed by a critical examination and description of the species (thirty-four), of which six are new. When the complete study of all the material has been made, the number of species will reach 100. The variation of the forms from different localities has enabled the author to trace three horizons in the flora of Sakhalin from the Middle Cretaceous to the Upper.

A. W. S.

Fungi.

Phycomycetous Fungi from the English Coal Measures.—DAVID ELLIS (*Proc. Roy. Soc. Edin.*, 1918, 38, 130-45, 1 pl. and 8 text-figs.). An account of the results obtained by a systematic search in the Lower Coal Measures for fossilized fungi. In the fossilized vegetable *débris* of this horizon it is not unusual to meet with fragments of fungal threads when these are specially sought for; it was only when remains of the hyphæ and attached structures occurred with specific clearness that they were studied in detail. Altogether some fifteen species of fungi have been assigned with some degree of certainty to the Phycomycetes. The majority of the thirty slides examined were prepared from petrifications from the Upper Foot Mine, Shore, Littleborough. One of the species described in the paper, *Peronosporites gracilis*, was found in the cortex of the stem of *Lepidodendron aculeatum*, and also in the cortex of a secondary root of *Lygniridendron Oldhamium*. The structure is described and its close relationship with *P. antiuanarius* W. Smith indicated. The second fungus, described under the name *Pulzeomyces bacilloides*, was found in the parenchymatous cells of the leaf-bases of a species of *Lepidodendron* (probably *L. fuliginosus*) from the Upper Foot Mine. Vesicles found attached to the hyphæ may be regarded as the remains

of sporangia of the type found in modern Phycomycetes. Bodies of the nature of *Oidium*-cells are also described, and the Saprolegniaceæ are indicated as being the nearest allies among modern fungi. A. W. S.

Myxomycetozoa.

New Mycetozoa.—C. MEYLAN (*Bull. Soc. Vaudoise Sci. Nat.*, 52, 1918, No. 194, 95) describes two new Mycetozoa from cold altitudes. 1. *Lamproderma crucheti*, differing from *L. columbinum* by the colour of the plasmodium and sporangia and spores, and the form of the sporangia and length of the pedicel. 2. *Stemonitis hyperopta*. A new name suggested for the variety *heterospora* of *Comatricha typhoides*. The author discusses the affinity of the organism with G. Lister's *Comatricha dictyospora* (Cel.). Again, the features upon which the author relies would appear to be the possible result of climatic conditions, and it appears to us that judgment should be reserved until these new forms have been cultivated under normal conditions of temperature and environment. E. H.-A.

Mycetozoa from the Jura Mountains.—C. MEYLAN (*Bull. Soc. Vaudoise Sci. Nat.*, 51, No. 191, 1916-17, 259) describes Mycetozoa from high altitudes (900 to 1600 mm.) in the Jura Mountains, of which *Baulhamia lilacina* and *Comatricha elegans* are new to the district. The author does not, however, lose sight of the world-wide distribution of most of the recorded Mycetozoa. The feature of the paper is the revision of the genus and species *Lamproderma violaceum*. He proposes, for reasons which he sets out at length, to raise the variety *sauteri* (Rost.) to specific rank, the variety *caresitiæ* becoming a variety of *L. sauteri*. He discusses the distinction between the latter species and *L. cribrarioides* (Fr.).

It is a question whether the distinction is a sound one, and we should be inclined to think that the author's revision is little more than taxonomic, regard being had to the altitudes and conditions of frigidity, which must have a specific influence on the development of the sporangia. The author gives a complete synopsis of the group. A new variety, *carneo-griseum*, of the species *Enerthenema papillatum* (Pers.) is described; the only difference between the variety and the type is in the rose-grey colour of the sporangia. It would appear to be an autonomous variation resulting from the conditions of altitude and temperature. E. H.-A.

Schizophyta.

Schizomycetes.

Botulism.—DORENDORF (*Deutsche med. Wochenschr.*, 1917, 46, 1531-4, 1554-6). Poisoning, due to toxin produced in raw ham, sausages, meat, fish, by *Bacillus botulinus* is comparatively rare, but during three months Dorendorf studied six cases. Examination after death shows widespread hyperæmia, especially of the meninges, lungs, liver and kidneys. Microscopically the ganglion-cells show disappearance of Nissl's granules,

displacement and cloudiness of the nucleus, and eventually complete destruction of the cell. These changes occur in the medulla and cause nuclear paralysis, and respiratory or cardiac stoppage. J. E.

Bacteria of Gas Gangrene.—R. PFEIFFER and G. BESSAU (*Deutsche med. Wchnschr.*, 1917, **43**, 1217, 1255, 1281). The authors regard "gas gangrene" as due to the combined action of a variety of anaerobic bacilli, and never as the result of a single variety. In 150 cases from the Somme front, Fraenkel's bacillus, *B. ærogenes encapsulatus*, was the most common, but never alone. They emphasize the difficulty of obtaining pure cultures of any of the anaerobes.

They describe in detail four organisms only, two classified as "non-putrefiers" and two as "putrefiers."

Non-putrefying organisms :—

1. Bacillus of Fraenkel (probably *B. ærogenes encapsulatus*, *B. welchii*, *B. perfringens*, of British writers), a plump, non-motile bacillus, does not form spores in agar or broth even after a period of weeks. Very scanty spores may be formed after a time on coagulated serum and in meat-broth.

2. Bacillus of Malignant Œdema (Koch) is longer and narrower than Fraenkel's bacillus, and is very Gram-labile. Varies in motility. Slight sporulation in agar and liver-broth, very abundant spores in a meat-broth culture. On agar-plates the colonies develop very slowly, and after three days appear as very small, fine, slightly cloudy colonies with finely branching filamentous margin. In old meat-broth cultures many free spores may be found, and after a fortnight the meat in the medium begins to dissolve. The cultures have a slightly rancid odour, and there is no putrefaction.

The putrefying organisms are the following :—

1. The so-called "Uhrzeiger," or Clock-hand Bacillus. Very motile. Gram-positive, and spores abundantly on all ordinary media. Abundant gas is produced, and a very foul odour. Meat-broth and brain-broth are both blackened.

2. The "Par œdema Bacillus," morphologically similar to Koch's bacillus of Malignant Œdema, but producing marked putridity in culture. It is non-motile, forms spores in meat-broth, and the meat is slowly dissolved. J. E.

MICROSCOPY.

A. Instruments, Accessories, etc.*

(3) Illuminating and other Apparatus.

Modified Safety-razor Blade-holder for Temperature Control.—T. H. GOODSPEED (*Botanical Gazette*, 1918, 2, 176-7, 1 fig.). The necessity of keeping the knife cool in ribbon section-cutting has led in the University of California Laboratory to a simple modification of the usual type of safety-razor blade-holder. The original holder made by Strickler has been found the most desirable type of a number at present on the market. To such a holder a small brass tube is longitudinally attached. This tube has a bore of 4 mm., and is soldered to the outer leaf of the holder, thus in no way interfering with the separation of the leaves when the safety-razor blade is to be inserted. The tube is extended approximately 6 mm. beyond the holder proper at either end to allow the attaching of small rubber tubes. For class use where very thin sections are not ordinarily required, it has been found that the temperature of the knife in such a holder is sufficiently low if tap-water is allowed to flow through the tube. A very short time is required for the temperature of the water to be communicated to the knife. A cooling-cell, such as Land's or Gardner's, also regulated with tap-water, may be employed in addition, but its use in most cases is superfluous. Where sections from soft or medium paraffin under $5\ \mu$ are required the modified safety-razor blade-holder and the cooling-cell are attached to Gardner's apparatus, with the buckets filled with ice-water. Under such conditions sections $2\ \mu$ thick have been cut very successfully from a paraffin melting at 53°C .
A. N. D.

Scattering of Light by Dust-free Air, with Artificial Reproduction of the Blue Sky.—HON. R. J. STRUTT, F.R.S. (*Royal Society Proceedings*, June 1918, 94, 453-9). It is now recognized that the blue colour of the sky on clear days and at considerable altitudes can be accounted for by the scattering of light by the molecules of air, without postulating suspended particles of foreign matter, such as were thought necessary by earlier writers. The laboratory method described of demonstrating this is in principle a modification of the ultra-microscope of Siedentopf, which again is founded on the observations of Tyndall.

* This subdivision contains (1) Stands; (2) Eye-pieces and Objectives; (3) Illuminating and other Apparatus; (4) Photomicrography; (5) Microscopical Optics and Manipulation; (6) Miscellaneous.

In arranging an experiment for this purpose, the chief essential was to avoid, as far as possible, stray light from the wall of the vessel used as an air-container, and to observe the beam transversely against the blackest possible background.

The source of light was a hand-regulated carbon arc, taking about twelve amperes. A quartz condenser (used on account of its transparency to blue and violet light) was adjusted to give a convergent beam. This passed through a quartz water-cell to take our heat-rays, then into the experimental vessel. The latter was in the form of a cross, constituted of brass tubing $1\frac{1}{2}$ -in. diameter, as shown in the figure (drawn to half-size). The interior was dead black. The light

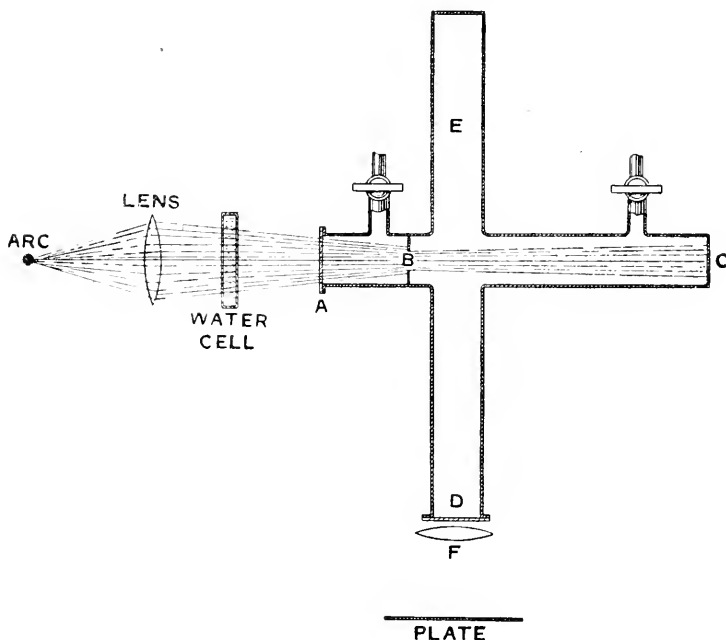

entered by the quartz window A and passed on through the rectangular diaphragm B to the far end, where it was stopped by the closed end of the tube. The beam was observed through the glass window D. The side-piece E constituted a black cave, and the mouth of it afforded the necessary background against which a feeble transverse luminosity of the beam would stand out well. In spite of all precautions enough light was diffused by the walls of the tube to enclose this black background in a luminous ring, which, however, was not bright enough to cause inconvenience. The beam passed diametrically across this luminous ring, which is seen in all the photographs.

For photography the lens F, of 6 c.m. focal length, was arranged

to form an image on a sensitive plate held in an ordinary camera. For visual observation, the plate-holder was removed, and the image viewed with an eye-piece of 3 c.cm. focal length. This moderate magnification was found to be of considerable advantage, though of course it does not increase the intrinsic brightness of the scattered light.

With ordinary untreated air in the apparatus, a very bright track due to scattering by the dust particles was observed. Passing a current of air dried by phosphorus pentoxide, and filtered by cotton-wool, the dust particles became fewer. It took a little time to get rid of them, because the shape of the vessel was unfavourable for a wash through of air. After a few minutes, however, the dust particles became so scarce that they could only be seen occasionally crossing the track, and they soon vanished entirely.

At this stage there was a blue track along the beam, which, though much fainter than the original dusty track, was visible without difficulty when the eyes had been rested in the dark.

When the vessel was exhausted, the blue track disappeared, nothing remaining except the above-mentioned ring of light diffused by the vessel. Readmitting filtered air, the blue track reappeared exactly as before.

These various tests and precautions seem to prove beyond doubt that the observed scattering was not due to dust surviving imperfect filtration, or to any false light, but that it is properly of pure air. Its intensity is of the order of magnitude to be expected. 1. By proper arrangement of the experimental conditions it is possible to observe the scattering of light of pure air, free of dust, in a small-scale laboratory experiment. 2. Similar results can be obtained with other gases. Hydrogen gives much less scattering than air, oxygen about the same, carbon dioxide decidedly more. 3. The scattered light in air and in all the other gases is blue—the blue of the sky—illustrating very directly the theory that attributes the blue of the sky to scattering by the molecules of air. 4. The scattered light is almost completely polarized.

J. E. B.

Some Principles of Illumination.—M. A. AINSLIE (*Proc. Photomicrographic Soc.*, 1918, 7, 1–23, 6 text-figs.) analyses the elements of the subject clearly and concisely. C. S.

The Polarization of Light.—F. C. REYNOLDS (*Proc. Photomicrographic Soc.*, 1918, 7, 24–30, 4 text-figs.) gives an elementary description of the principles involved. C. S.

The Barnard Incandescent Gas Lamp, manufactured by H. F. Angus and Co., may be used either with an ordinary Bunsen flame (4) or with a high-pressure methylated spirit-burner. It embodies a somewhat new but very simple method. It consists of a specially made incandescent mantle in a metal tube (1), which gives an intense uniform source of light of about 5 mm. across. It is sufficiently intense for seeing *Spironema pallidum*, and for differentiating it from other similar organisms. In front of the light is placed a bull's-eye or condensing

lens (6). The position of the latter should be such that the image of the radiant is projected about 7 to 9 in. from the condensing lens, and falls exactly in the centre of the mirror. The tube containing the mantle can be rotated in the cradle (2) until the incandescent material presents a convex surface to the flame. The relative position of incandescent material to flame can be adjusted exactly by means of a

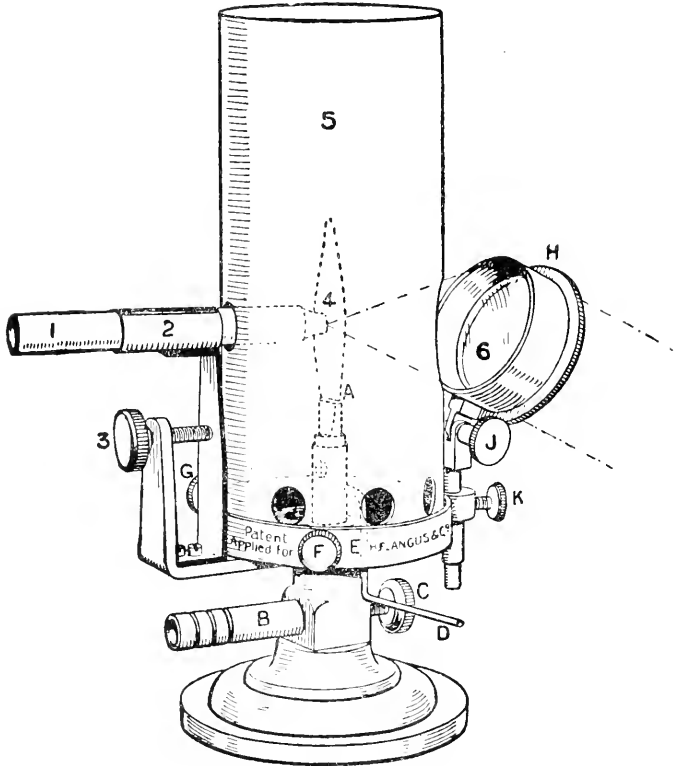

HALF ACTUAL SIZE.

fine-adjustment screw (3). The milled head (C) regulates the supply of gas, and the lever (D) the supply of air. The bull's-eye condenser slides in sleeve (H), and is attached to the gallery of the lamp by clamping screw (K).

(4) Photomicrography.

Wratten "M" Filters (Kodak, Limited, London, 1919, 12 pp.).—A booklet has been issued by the Kodak Company in place of their

larger publication, "Photomicrography," and includes several novelties. In the table of exposure factors for Wratten "M" filters with Wratten "M" plates (p. 11) factors are given for use with the recently introduced pointolite lamp instead of the previous column of Nernst factors. In addition to the nine filters forming the well-known "M" set, three others (K3, 78, 96) are described which may be of use to microscopists. K3 is a luminosity screen for orthochromatic reproduction, and should be used if daylight or equivalent daylight is to be employed. No. 78 is a filter primarily intended for the conversion of the light from a metal-filament lamp into the visual equivalent of average daylight. It may also be used with the pointolite lamp and with the smaller-powered half-watt lamps, and, less efficiently, with incandescent gas or oil. It gives a very close approximation to daylight, and will be found very useful and restful to the eyes in the case of long-continued visual observation. No. 96 (D 1.5) is a neutral tint filter, and transmits about 3 p.c. of the incident light for use when focussing with a strong illuminant, or for lengthening the exposure (about thirty-three times) when inconveniently short, as with low powers. It does not alter the contrast obtained with coloured filters. The Kodak Company hope soon to be able to supply a blue filter, of dominant wave-length 4700,

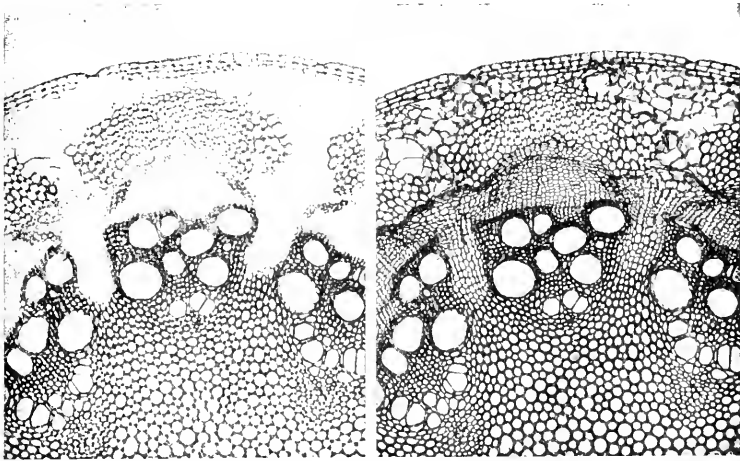

FIG. 1.

FIG. 2.

ILLUSTRATIONS SHOWING THE CONTROL OF DETAIL BY THE USE OF WRATTEN "M" FILTERS.

Fuchsin-stained Section. T.S. Stem of *Clematis flammula* $\times 40$.

Fig. 1. Ordinary plate, no filter. Fig. 2. Wratten "M" plate, B and G filters.

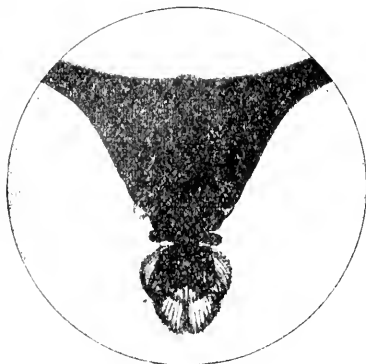

FIG. 3.

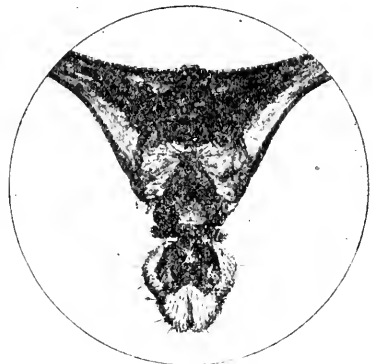

FIG. 4.

Part of head of Telescope fly, *Diopsis apicalis* $\times 22$.

Fig. 3. "M" plate, C filter, to obtain maximum contrast.

Fig. 4. "M" plate, F filter, to obtain maximum detail.

which does not transmit any red, especially for visual use when the highest possible resolution is required. They invite inquiries for it under reference No. 38aM.

A. N. D.

Telescopic Focussing Apparatus for Photomicrography.—A. F. HALLIMOND, M.A. (*Iron and Steel Institute*, 1918). In the ordinary vertical camera, in which the plate is supported at a distance of 10 in. or more above the microscope, the height of the focussing screen is often the source of much inconvenience. It was suggested to the author by Mr. J. H. Whiteley that to meet these difficulties a means might be found of reflecting the beam horizontally, and so adjusting the focus without the use of a ground-glass in the usual position. The telescopic arrangement here described was designed for this purpose, and resembles the ordinary form of reflex focussing camera.

The construction of the apparatus is shown in the adjoining figure, where the broken lines indicate the path of a beam which converges to form a point in the image.

Rays proceeding from the microscope eye-piece A, which would normally converge to a focus on the photographic plate, are reflected horizontally by the movable mirror B; this mirror is attached to a metal plate large enough to cut off all light from the camera when in the position shown, and is prevented from passing beyond the 45° position by an adjustable stop D attached to the spindle. The deflected beam is focussed by the telescope objective E (focal length 4 in.) upon the cross-wires F, and the image so formed is seen, together with the cross-wires, when examined through the eye-lens G (focal length $\frac{3}{4}$ in.). The magnification thus obtained is about the same as that given by the use of a hand-focussing lens upon (or without) the ground-glass.

It will be seen that to each length of camera there corresponds a fixed position of the focus at F, to which the cross-wires must be set by

pushing in the sliding tube and closing the clamp H. It is convenient to graduate the sliding tube, by direct comparison with the ground-glass, in numbers representing the corresponding camera-lengths. When this graduation has once been made, it is sufficient, in taking a photograph, to fix the telescope for the proper camera-length and focus the microscope so that the image is clearly defined on the cross-wires. As soon as the focus is ascertained to be steady and satisfactory, the dark slide having been opened before focussing, the exposure can be made by simply turning back the milled head C, so that the mirror moves into the vertical position.

The lenses described are of the simplest type, and have proved quite satisfactory in working; the field is, however, rather narrow, about one-third of the diameter photographed being visible at once. Mr. Swift, by whose firm the apparatus was made, has suggested that the eye-piece

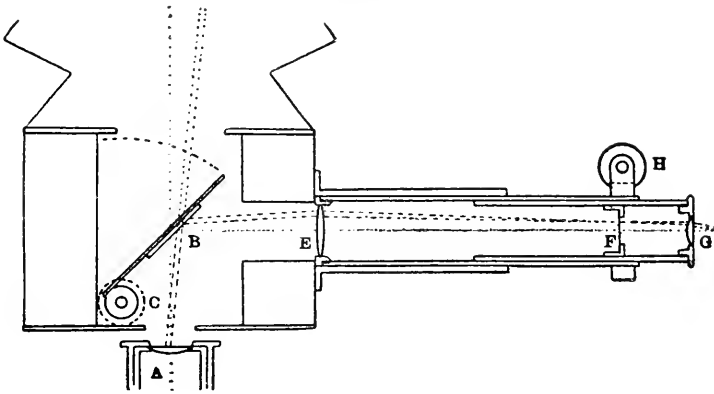

of the telescope might be provided with a field-lens, and no doubt the full field could thus be obtained; at the same time it would certainly be well to make the objective achromatic. No difficulty has been found to arise from the use of the mirror, which is a common plane "galvanometer mirror," though the best result would no doubt be given by a silvered right-angled prism. For ordinary purposes the simple form described has proved sufficient and represents a considerable saving of expense in comparison with the more correct construction. J. E. B.

(5) Microscopical Optics and Manipulation.

Optical Properties and Theory of Colour of Pigments and Paints.
 — H. E. MERWIN (*Proc. Amer. Soc. for Testing Materials, Philadelphia, 1917, XVII., 2, 1, 2*). The hue, purity and brightness of light diffused by a pigment or paint depends upon the refractive index, colour absorption, size, shape and texture of the pigment grains, and upon the refractive index, colour, and continuity of the vehicle; and also upon the distribution of the grains in the vehicle.

A black pigment to be most effective optically should have (1) a refractive index equal to that of the surrounding medium, and (2)

grains $1\ \mu$ (or less) in diameter which should be (3) barely opaque to all colours. All the ordinary black pigments possess the third characteristic approximately, some of them the second, but only one of them, bone black in its various forms, has approximately the best refractive index.

A white pigment should have a high refractive index, should be even grained, with grains about 0.5 to $0.1\ \mu$ in diameter. Finer grains diffuse blue light more than red light under certain conditions, for example, when mixed in oil with black or dark red pigments. Thus blue greys and purples result. Most white pigments contain enough very fine grains to give bluish greys. Control of size of grain is important. It is probable that the refractive index of certain zinc oxides made by the American process can be controlled advantageously.

Colouring efficiency must be considered as much from the standpoint of the hue and tone desired as of the absolute "quantity of colour" obtained. Thus, although extremely fine division may favour the last factor mentioned, when the pigment is used in a mixture with a strongly diffusing pigment, yet under other conditions size and shape of grain and refractive index are of great importance. For example, Harrison red in grains of one shape has about 10 p.c. better diffusing power than in grains of another shape. The shifting of hue, especially of orange and yellow paints toward the green, due to admixed black, is considered in detail. The optical properties which determine whether a pigment is best suited for producing tints or shades are discussed.

Special methods of studying the optical properties of pigments have been used, and a considerable number of constants determined. These properties can be applied in determinative work or to problems in chromaties.

This investigation has been conducted in the Geophysical Laboratory of the Carnegie Institution of Washington.

J. E. B.

(6) Miscellaneous.

Chemical Microscopy.—E. M. CHAMOT (*Trans. American Microscop. Soc.*, 1917, **3**, 139–57, 2 pls.). This was an address delivered before a joint meeting of the Chicago Section of the American Chemical Society and the State Microscopical Society of Illinois, and was an appeal from a chemist for a wider and more intelligent application of the microscope in everyday chemical practice. The author criticizes the modern microscope, and points out that it is not an ideal instrument for a chemical laboratory. He considers that the mirror should be mounted on a swinging bar capable of movements far to one side, or even above the stage; that the objective should be of small angle, long available working distance and marked penetrating power; and that the instrument should be built of materials capable of resisting the corrosive atmosphere of an industrial laboratory. With such an instrument, however, many of the processes of qualitative chemical analysis can be readily and speedily performed. The author discusses in some detail the application of microscopy to such investigations as water analysis, cements, foods and beverages, metallurgical industries, pigments and textiles.

A. N. D.

B. Technique.*

(4) Staining and Injecting.

Staining Spirilla with Formol-violet.—P. SPEHL (*C.R. Soc. Biol.*, 1918, **81**, 305-6). 1. Spread a thin film on cover-slip and dry. 2. Mordant with acetic formol (Ruge) for five minutes. Repeat this process twice. (Formol 2, acetic acid 1, distilled water up to 100.) 3. Replace the acetic formol by 10 p.c. aqueous solution of chromic acid. Allow to act for ten minutes. 4. Wash in absolute alcohol for two minutes; then flame. 5. Stain with warm formol gentian-violet for two minutes. 6. Wash rapidly in water. 7. Treat with Lugol's iodine solution for five minutes. 8. Wash, dry and mount.

By this process cell protoplasm is stained violet, the nuclei black. Bacteria are black, Spirilla violet, or more often black. J. E.

Double Staining of the Tubercle Bacillus: a Modification of Spengler's Method.—P. SPEHL (*C. R. Soc. Biol.*, 1918, **81**, 248-9). In the method the bodies of the bacilli are stained red, Much's granules black, and the remainder of the preparation pale yellow, and is carried out as follows:—Smear a thin film of the sputum on a cover-glass, dry, fix with absolute alcohol one minute, and flame. Stain with a freshly-prepared mixture of Ziehl's fuchsin 3 parts and carbolic gentian-violet 2 parts, for 2-3 minutes warm, or if preferred for 15-30 minutes cold. Replace the stain by Spengler's picric alcohol cold (sat. aq. sol. picric acid 60, alcohol 40), and allow to act for one minute. Replace the picric alcohol by 60 p.c. alcohol, and wash the film three times in this solution. Decolorize for 20 seconds in nitric acid, 15 p.c. solution. Complete decolorizing with 60 p.c. alcohol. Counterstain for one minute with picric alcohol. Wash in water, dry and mount. J. E.

Metallography, etc.

Testing Hardness of Metals by the Boyelle-Morin Apparatus.—C. J. BOWEN COOKE (*Journ. of Inst. of Mechanical Engineers*, 1918, **5**, 331-4, 4 figs.). The essential part of this apparatus consists of a tube *a* carrying a hardened steel ball *c*, and a rod *b* enlarged at the lower end to slide freely in *a*. Interposed between the lower end of *b* and the ball *c* is a cylinder or cube *d* cut from a bar whose hardness has been determined in a 3000-kilogram Brinell machine. The apparatus must be held vertically, with the ball *c* resting on the surface *e* to be tested, and the top of the rod *b* struck sharply with a hammer causing the ball to indent *d* and *e*. The diameters *d* and *e* of the indentations are measured by the scale and a magnifying glass, and the corresponding hardness numbers are read off on a specially graduated slide-rule.

* This subdivision contains (1) Collecting Objects, including Culture Processes; (2) Preparing Objects; (3) Cutting, including Embedding and Microtomes; (4) Staining and Injecting; (5) Mounting, including slides, preservative fluids, etc.; (6) Miscellaneous.

As the result of a number of comparative tests it has been found that the apparatus may be considered as a workshop tool giving results of sufficient accuracy for workshop testing of many of the steels in ordinary use. Whether the concordance would be as satisfactory with harder steels is questionable. The apparatus would be more reliable if some provision were made for insuring that the rod *b* is truly vertical when it is struck.

A. N. D.

Nature of Growths in Colloidal Silica Solutions.—H. ONSLOW (*Proc. Royal Soc.*, 1918, B. 628, 266–9). The late Dr. Charlton Bastian, after having performed a number of experiments, claimed to have synthesized certain symmetrical bodies resembling torulae and other minute organisms from sterilized colloidal solutions, which had been exposed for a long period to the light. Further, he claimed that such “organisms” were capable of reproducing themselves. Dr. Bastian was so anxious for independent investigation that the author undertook to repeat his experiments carefully, in order to ascertain whether the organized bodies in question were in reality living protoplasm. Accordingly, he prepared a series of ninety tubes and repeated Bastian’s experiments, which in some cases required upwards of three years’ culture. The centrifugalized deposits were examined by microscopical observation with a $\frac{1}{4}$ -inch objective and by sub-cultivation. The most elaborate precautions were taken against air-contamination. The results were entirely negative, and the author was forced to the conclusion that the bodies found by Dr. Bastian, which often resembled living organisms in a striking fashion, are due to the slow deposition of silica from the colloidal solutions, either about minute nuclei or about the detritus of dead organisms, in the manner described by Professor Moore and Evans, and also by Sydney G. Paine. The only living organism which occurred in the author’s experiments must have been introduced accidentally owing to the lack of sufficient precautions, for when great care was taken to avoid contamination the tubes were found to be uniformly sterile.

A. N. D.

Industrial Processes.

Investigations on Textile Fibres.—W. HARRISON (*Proc. Roy. Soc.*, 1918, A 663, 460–9, 2 pls.). The object of the author’s investigations was to determine some of the fundamental properties of textile fibres which govern their behaviour in manufacturing processes, and thereby to establish a scientific basis for research into such processes. The investigations included:—1. Effect of stress, moisture, and heat on textile fibres. 2. Cause of the double refraction of textile fibres. 3. Effect of chemical treatment on the double refraction of fibres. 4. Probable causes of the internal stresses existing in natural fibres. Photomicrographs depending on ultramicroscopy, polarized and ordinary light are given illustrating the author’s observations and conclusions.

A. N. D

NOTICES OF NEW BOOKS.

The Foraminifera of the Atlantic Ocean. Part I. Astrorhizidæ.—
By J. Cushman. Smithsonian Institution, United States National
Museum, Bulletin 104, i-vii and 1-111, pls. 1-39. Washington :
Government Printing Office. 1918.

J. A. Cushman, having completed his useful series of monographs on the Foraminifera of the Pacific, is now devoting his attention to those of the Atlantic. The amount of material at his disposal resulting from the records of numerous zoologists working on the European coastline, supplemented by the extensive dredgings and soundings of the U.S. Bureau of Fisheries, is naturally much larger than was available for the comparatively unexplored Pacific.

The Astrorhizidæ are mainly benthic organisms, and many species have consequently a world-wide distribution, because physical conditions in the deep sea are subject to very little variation anywhere. Darkness and a temperature just above freezing point are the chief physical features. Round the poles, and within the influence of the cold currents which originate in the polar seas, the Astrorhizidæ extend into comparatively shallow water. Hence the abundant Astrorhizid fauna which has been dredged in recent years in the deeper areas of the comparatively shallow North Sea, and in the area to the north of the Wyville Thomson Ridge between Scotland and the Faroe Islands. In the warm area to the south and west of the Ridge the same species are found at greater depths.

These conditions are probably duplicated on the eastern coast of the United States, where the Labrador Current and the Gulf Stream meet. Cushman in his introduction refers to the dissimilarity of the benthic fauna to the north and south of Cape Hatteras, but does not appear to have appreciated the enormous influence which the Wyville Thomson Ridge exercises on the fauna of north-western European seas. It would be interesting to compare lists of Foraminifera from similar depths in these four widely-separated areas, and as the material from the European side is already available we hope that Cushman will publish such a comparative table in his forthcoming reports.

Physical conditions on the two sides of the Atlantic being so similar,

it is not surprising to find that nearly all our European forms occur off the American coast. The exceptions are principally species recently described from "Goldseeker" dredgings, and usually of more or less local distribution in our seas. It seems probable that these also will eventually be found on the Western Atlantic shores when intensive search can be made in suitable material. There is no doubt some truth in Cushman's reference to the existence of groups with general as opposed to local distribution, but even the nearest-species have a disconcerting way of turning up when least expected, half a world away from any previous record, and without any intermediate connecting links.

The classification adopted by Cushman is based on the system of Rhumbler, and will not recommend itself to British zoologists, especially in present times, when everything of German origin is viewed with something more than distrust. With all its defects and shortcomings, due largely to the limited amount of deep-sea material on which he had to work, Brady's system is in our opinion more truly scientific, and will hold its own, at any rate, until we know more about the life-history of the deep-sea rhizopods than we are ever likely to know in the immediate future. The fundamental difference between the British and German schools of rhizopodists lies in the fact that the principal British rhizopodists have been marine zoologists, who treated the question of classification from what they knew of its biological side, while the Continentals have been systematists bent on reducing the group to hard and fast specific lines, regardless of the multiplication of genera and species thereby involved in treating organisms of such simple and protean structure as the Foraminifera.

The relative merits or demerits of the two systems can be illustrated by an analysis of Cushman's last sub-family (4), Ammodiscinæ. This includes the genera *Ammolagena* Einers and Fickert = *Webbina clavata* (P. & J.); *Girvanella* Nicholson and Etheridge, a genus created for fossil remains of doubtful nature, and used by Rhumbler for the cosmopolitan *Hyperammina vagans* Brady. These two forms appear to be very distinct from a zoological point of view, and under Brady's classification are relegated to different families. But by Cushman they are associated with the true Ammodisci, and this genus, which may be briefly described as an unseptate, coiled, arenaceous tube, is further subdivided. Six species, differing principally in the nature of the spiral, and which would all have been included without difficulty under *Ammodiscus* Reuss *senen* Brady, now require no less than four genera for their reception—*Ammodiscus* Reuss, *Ammodiscoiles* Cushman, *Gromospira* Rzehak, and *Turitellella* Rhumbler. At this rate it will soon be a case of *tot genera quot species*.

There are many other points we should like to discuss in this valuable monograph, but space will not permit. It is well illustrated by reproductions of original figures, and for that reason it is a pity that the author did not manage to include figures of all the new forms included in the monograph. We trust that he will remedy this omission in a supplementary paper.

E. H.-A. & A. E.

The Fundus oculi of Birds, especially as viewed by the Ophthalmoscope : a Study in Comparative Anatomy and Physiology. By Casey Albert Wood. 182 pp., 61 coloured plates by Arthur Head, F.Z.S., and 145 drawings in the text. Chicago : Lakeside Press. 1917. Price 15s.

In the first year of the present century the Royal Society published in its Transactions (vol. 194) a comprehensive monograph on "The Comparative Anatomy of the Mammalian Eye, chiefly based upon Ophthalmoscopic Examination," by Dr. Lindsay Johnson, illustrated by coloured drawings of the fundus oculi of mammals by Arthur Head. This was a fascinating and suggestive work which aroused the keenest interest amongst ophthalmologists, and prompted the hope that allied fields for research might be explored, to the increase of knowledge. But the collection of the necessary data is a slow and laborious process, and very few are qualified to undertake a research of this nature, so that we warmly welcome Dr. Casey Wood's volume on avian eyes, which, we infer from internal evidence, has occupied considerably more than seven years in the making, and in the preparation of which he has had the valuable help of the same skilful artist who originally prepared the drawings of mammalian eyes.

The author in his wisdom—and we would that more followed his example—summarizes his conclusions at the very outset, and of these we would select two as of prime importance, viz. :—

"The fundus oculi of Birds exhibits a great variety of areas of distinct vision, and these correspond closely to the habits and habitat . . ."

"The appearances . . . furnish entirely different coloured fundus pictures, and it is frequently possible to recognize a species by viewing its fundus oculi," from which the corollary emerges, "in future no report upon a particular avian species can be held complete that ignores the visual apparatus and especially the appearances of the fundus oculi as shown by the ophthalmoscope."

Dr. Casey Wood details the methods he has elaborated for the collection, selection and preparation of material ; the examination of the fundus in the living bird, *post-mortem*, and in preserved and sectioned eyes, reviews the anatomy and physiology of the organs and tissues of the bird's eye, passes to a consideration of the parts and organs visible to the ophthalmoscope, and discusses their relative importance from the point of view of function, and describes their combinations and variations in different species.

The detailed observations of various orders and species of birds which follow show that the ophthalmoscopic appearances are so striking and so consistent as to permit of the classification of fundi into two groups, vascular and avascular, each containing five subdivisions. An atlas of coloured drawings of avian fundi, each provided with a concise description, completes a volume for which we can find nothing but genuine praise.

Indeed we would fain conclude this brief notice by saying that the result of the combined labours of author, artist and publisher leaves nothing to be desired ; but the very excellence of this result impels us to voice our further desire, and to quote a short sentence from the

introduction, which reads: "In addition to these methods of investigation extensive microscopical examinations of the tissues were carried on," etc. As microscopists we would implore Dr. Casey Wood to supply the only important omission in the present volume by providing us with a companion volume detailing his microscopical researches. J. E.

Methods in Practical Petrology. By Milner and Part. Cambridge: W. Heffer and Sons, Ltd. Price 2s. 6d.

An addition to the scanty literature of Petrology is always welcome, and a concise account of practical work is sure to find readers desirous of obtaining hints to help them in the rather difficult task of preparing and examining rock-sections, both macroscopically and microscopically.

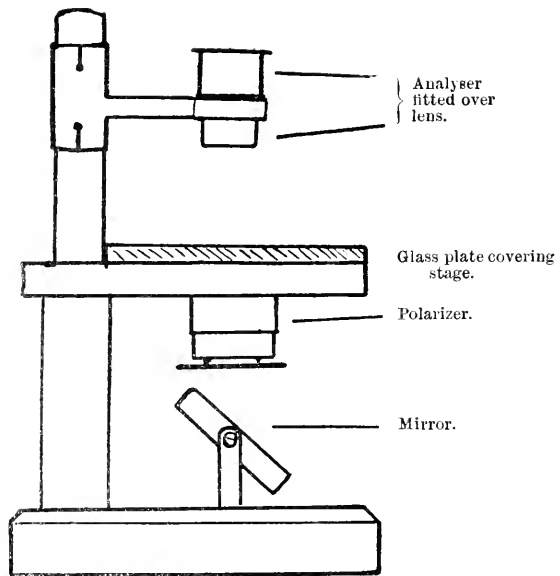

The present manual is divided into four chapters (each with appropriate sub-sections), dealing with:—1. The preparation of rock-slices. 2. Examination of rock-slices. 3. Microchemical methods (staining). 4. Mounting of sands and crushed rock material. There is also an appendix dealing with the preparation of stains, and a satisfactory index. A commendable feature throughout the book is the number of footnotes referring the student to standard authors and to a variety of memoirs. These taken altogether form a quite considerable bibliography.

Several clearly-drawn line-diagrams are included in the text, of which the first (reproduced) is of special interest to microscopists. As will be seen, it is a simple polarizing stand, arranged after the manner of a dissecting microscope, focussing being effected by sliding the arm carrying the lens and analyser up or down the pillar.

The method suggested on page 23 for examining opaque materials by reflected light does not altogether commend itself to the reviewer. Reflecting light by means of a white card on to the specimens would only be feasible when using low-power objectives, and, as the authors imply, the loss of light is considerable. The present writer has obtained good results by tilting the stage to a high angle of inclination, bringing the illuminant behind the microscope (i.e. immediately in front of the observer) and focussing the light on to the slide by means of a bull's-eye condenser. The direction of the incident light being nearly parallel to the line of sight in the microscope, the loss of light is comparatively small.

The book will assuredly strike the reader as the production of petrologists who have themselves grappled with the practical problems of this branch of microscopy, and are therefore well qualified to act as guides to others who may be experiencing the inevitable difficulties in the preparation and examination of rock-sections.

F. I. G. R.

Simplified Method of Tracing Rays through any Optical System.

By Ludwik Silberstein, Ph.D. London: Longmans, Green & Co. Price 5s. net.

The purpose of this small volume is to indicate a method of treating the geometrical optics of any system, particularly that part of a computer's work known as "ray-tracing." It is not of special interest to microscopists, unless an interest is taken in general optical problems. The treatment is mathematical, and assumes a knowledge, elementary it is true, of vector algebra. The book has been produced at the instigation of Messrs. Adam Hilger, Ltd. It is satisfactory to know that an optical firm in this country, of high repute, is interested in such a publication.

J. E. B.

Elements of the Electro-magnetic Theory of Light.

Ludwik Silberstein, Ph.D., Lecturer in Natural Philosophy in the University of Rome. London: Longmans, Green & Co. 1918. Price 3s. 6d. net.

This little volume, the object of which is to present the essentials of the electro-magnetic theory of light, was rewritten at the instance of Messrs. Adam Hilger, Ltd., from the author's Polish treatise on Electricity and Magnetism.

The language adopted is mainly vectorial, so that while the treatment of the subject is of necessity mathematical, it does not entail a knowledge of the higher mathematics for its intelligent appreciation. The author accurately describes it as an easy and complete presentation of the fundamental part of Maxwell's theory of light, and as such may be commended to those microscopists whose interests are mainly directed to the optical side of their subject.

J. E. B.

PROCEEDINGS OF THE SOCIETY.

AN ORDINARY MEETING

OF THE SOCIETY WAS HELD AT 20 HANOVER SQUARE, W., ON
WEDNESDAY, OCTOBER 16, 1918.

The Minutes of the preceding Meeting were read, confirmed, and signed by the President.

The nomination papers were read of the following Candidates for Fellowship :—

Mr. Charlton S. Agate, B.Sc., etc.
Mr. Charles Baxter, C.E., M.I.Mar.E., etc.
Mr. John Leslie Berry.
Captain Thomas Buller Bradshaw, J.P.
Miss Lettice Digby.
Mr. Ernest Chalders Garbutt.
Dr. E. C. Hort.
Mr. William Sandford Hoseason.
Mr. Owen Lloyd Hughes.
Mr. Robert Hicks Kidd, R.E.
Mr. William I. Morrish, M.D., etc.
Mr. Frank Rowley, M.I.M.M.
Mr. Walter Salmon.
Mr. Herbert Sutcliffe.
Mr. Edward E. Triggs.

Sir Nicholas Yermoloff, K.C.B., K.C.V.O., was duly elected a Fellow of the Society.

Donations were reported from—

Dr. Urban Pritchard . . .	A collection of Diatoms.
Mr. J. Rheinberg . . .	A set of Photographic Scales and Micrometer Rulings.

On the motion of the **President**, hearty votes of thanks were passed to the above donors for their valuable contributions to the Society's Collection.

The following report was presented dealing with the Society's exhibit and demonstrations at the recent Scientific Products Exhibition at King's College :—

EXHIBIT OF THE ROYAL MICROSCOPICAL SOCIETY AT THE BRITISH SCIENTIFIC PRODUCTS EXHIBITION, 1918.

Your President has to report that in July last he was informed by the British Science Guild that it was about to organize the British Scientific Products Exhibition, 1918, at King's College, and he was asked whether the Royal Microscopical Society would be prepared to assist in its endeavour to enlist the aid of Science in the industrial development of the Empire. Considering that it would be advisable for the Society to take an active part in such an exhibition, he convened a meeting of a Special Executive Committee, which was held on July 22. At this meeting it was agreed that, subject to the approval of the Members of the Council, the Society should arrange to send a selection of instruments from its collection to illustrate the Evolution of the British Microscope, and that in connexion therewith there should also be demonstrations showing a number of bacteriological, pathological, and other slides that had been stained by means of British-made dyes.

The Members of the Council were unanimous in their support of the proposition, and many offered personal help in furthering the success of the project. A special room was set apart at the Exhibition for the exclusive use of the Society, and an exhibit of twenty-seven British microscopes, illustrating the types in use during the last two centuries, was arranged.

The Exhibition was open for four weeks, August 12 to September 7, and during this period demonstrations were given each Tuesday afternoon and each Thursday evening. A great amount of interest was aroused by the Society's exhibit and demonstrations, an interest which cannot fail to be of benefit to the Society; and the President desires to record his sincere thanks to those who assisted, among whom were Miss Francis, and Messrs. S. C. Akehurst, C. F. Hill, T. H. Hiscott, R. Paulson, D. J. Scourfield, C. D. Soar, and J. Wilson; and also to the following, who very kindly lent modern microscopes for the purpose of the demonstrations: Dr. Eyre, Dr. Gordon, Messrs. Angus, Hill, and Lancaster, King's College, and King's College for Women.

On Tuesday, August 20, your President gave an address in the Exhibition Lecture Theatre on "The Evolution of the English Microscope." Dr. Walmsley presided. There was a good attendance, and a *résumé* of the address will appear in the published Record of the Exhibition which is being prepared by the British Science Guild.

The following is the list of Instruments exhibited to illustrate

THE EVOLUTION OF THE BRITISH MICROSCOPE.

i. JOHN MARSHALL "Double" Microscope, 1744. Invented about 1704. (R.M.S. Cat. No. 6.) Type—Compound Microscope, uncorrected. This instrument was described in the original advertisement as "John Marshall's New Invented Double Microscope for Viewing the Circulation of the Blood." The word "double" here signifies that it was a

compound instrument provided with an objective for forming an image of the object and an ocular for viewing the image so formed.

2. CULPEPER'S Compound Microscope. Date, before 1738. (R.M.S. Cat. No. 9.) Type—Compound, uncorrected. A modification of Wilson's simple Microscope. A body-tube of ivory, with draw-tube, is provided for the purpose of transforming it into a compound instrument which is mounted on a pillar with a ball-and-socket joint.

3. CULPEPER AND SCARLET. Invented about 1738. (R.M.S. Cat. No. 7.) Type—Compound, uncorrected. This tripod form of Microscope stand, mounted on a wooden box, was a favourite model for more than a century. It was copied and made by successive opticians with many variations in form, material, and finish until about the middle of last century. There is no fine-adjustment. The object-glass is a single biconvex lens, and the eye-piece has two lenses.

4. NATHANIEL ADAMS. About 1740. (R.M.S. Cat. No. 152.) Type—Compound, uncorrected. This is of the Culpeper and Scarlet pattern, and is rendered even more unhandy than its original by the addition of a fourth pillar in the space surrounding the stage. This inconvenience was incurred, no doubt, for the sake of the greater rigidity—a distinct advantage in focussing the instrument.

5. DOLLOND. About 1816. (R.M.S. Cat. No. 121.) Type—Compound, uncorrected. This again is of the Culpeper and Scarlet pattern, but shows a great advance in its mechanism, being made all in brass and fitted with a rack-and-pinion focussing arrangement. This specimen is remarkable for its date as showing the persistence and continued improvement of an obsolete type of instrument. Described in the *Journ. R.M.S.*, 1901, p. 227.

6. JOHN CUFF'S Compound Microscope. Invented about 1744. (R.M.S. Cat. No. 127.) Type—Alternatively Simple or Compound, uncorrected. The inventor of this model made a distinct improvement in the mechanical construction of the Microscope, and it forms an important link in the evolution of the instrument. The stand is firmer and more rigid, and altogether more handy, whilst the stage is more accessible; the fine-adjustment applied to the body has greater delicacy.

7. BENJAMIN MARTIN. 1760. (R.M.S. Cat. No. 52.) Type—Alternatively Simple or Compound, uncorrected. For the first time there is a slow and fine movement for focussing, by rack-and-pinion and by screw, both applied to the stage, with the constant action of a spring to check the motion. A small compass-joint at the top of the pillar allows the carrying-ring to be turned out of the way when the instrument is used as a simple Microscope.

8. BENJAMIN MARTIN. 1771. (R.M.S. Cat. No. 5.) Type—Alternatively Simple or Compound, uncorrected. This exceedingly elaborate instrument, of exquisite workmanship, with every conceivable movement, is said to have been made for King George III. Its authentic description is "Benjamin Martin's Large Universal Microscope." The triangular upright stem has a compass-joint at its base, and is fixed to an elaborate foot, over which it is adapted to rotate. The stage has micrometric movements in three directions; it moves the object over a wire scale in the eye-piece. This method of micrometry was invented by Benjamin Martin. The double mirror, as well as the stage, can be raised and

depressed by rack-and-pinion. The compound body can be removed and replaced by a simple Microscope; the stage also can be removed and replaced. Provision is made for holding and illuminating living objects and large opaque specimens. This Microscope is fully described in the Transactions of the R.M.S. of 1862, p. 31.

9. GREGORY AND WRIGHT. (R.M.S. Cat. No. 50.) Type—Alternatively Simple or Compound, uncorrected. The makers of this instrument were successors to Benjamin Martin. They follow his lead by making the stem inclinable by a joint at its base. The body is attached to a movable arm, which, in turn, is carried by the stem. This arm can be swung about the axis of the stem, and moved to and fro in its socket, these movements facilitating the exploration of a large specimen. Focussing is effected by rack-and-pinion, which move the stem and body, whilst the stage is fixed. This Microscope has a rotating multiple lens-carrier nose-piece, invented by Père Cherubini d'Orléans.

10. SHUTTLEWORTH. 1786. (R.M.S. Cat. No. 179.) Type—Alternatively Simple or Compound, uncorrected. The stand of this instrument is a somewhat later imitation of the Benjamin Martin type. The triangular stem has a compass-joint at its base, by means of which the whole Microscope is inclinable. The stage has rack-and-pinion focussing movement. The body is fixed to a movable and rotating arm, and carries Francis Watkins' rotating multiple lens-carrier nose-piece. The mirror and condensing lens slide on the triangular pillar. For description, see Journ. R.M.S., 1908, p. 365.

11. JONES. 1798. (R.M.S. Cat. No. 51.) Type—Alternatively Simple or Compound, uncorrected. This model follows an earlier form of Francis Watkins, inasmuch as the compass-joint making the Microscope inclinable is raised to the top of an upright stem, fixed to a tripod folding foot. To the joint is fixed a square limb, on the top of which a short arm, movable by rack-and-pinion, supports the body of the Microscope. The stage moves on the limb by rack-and-pinion, which serves for the focussing of the object. The mirror and condensing-lens slide on the same square limb. The object-glasses are contained in a rotating multiple lens-carrier nose-piece.

12. CUTHBERT'S Reflecting Microscope. About 1827. (R.M.S. Cat. No. 12.) Type—Compound: Catoptric. The maker of this Microscope attempted to produce achromatism by means of mirrors, carrying into effect a suggestion originally made by Newton. The magnification of objects is here effected by means of very small reflecting specula, and the result for low and medium powers was very fairly satisfactory. The body is fixed by a compass-joint on the top of the telescopic stem supported on a folding tripod. The focussing is effected by moving the stage, and the latter has rectangular motion.

13. HUGH POWELL. 1839. (R.M.S. Cat. No. 128.) Type—Compound: Achromatic. This Microscope embodies new features which have now been very generally adopted. The body, stage, and mirror are carried by the limb, which itself is attached by a compass-joint to an upright telescopic pillar raised on a solid tripod. The coarse-adjustment by rack-and-pinion for the first time moves the body of the Microscope, but the fine-adjustment is applied to the stage by a wedge acted on by a micrometer screw. In this model also Hugh Powell

systematically applied the method of "springing" in the movements to prevent loose action. Described in *Journ. R.M.S.*, 1901, p. 728.

14. HUGH POWELL'S Large Microscope. 1841. (R.M.S. Cat. No. 2.) Type—Compound: Achromatic. This Microscope is one of three which the Council of the Microscopical Society of London,* soon after its formation, ordered of the three best makers of the day—Hugh Powell, James Smith, and Andrew Ross. The too elaborate and substantial stand was considered the best of its day, and embodies all the most refined movements and apparatus the maker was able to devise. The body is moved by rack-and-pinion, and is attached to a hollow triangular bar. The fine-adjustment actuates the stage. Originally this was a monocular Microscope, but the binocular body with Wenham's prism was fitted to it after the invention of the latter in 1863.

15. JAMES SMITH. 1841. (R.M.S. Cat. No. 1.) Type—Compound: Achromatic. This stand was made in execution of an order given by the Council of the Microscopical Society of London in August 1840, and has become a model on which many English stands have since been made. A substantial pillar mounted on a solid tripod supports a grooved limb, which itself carries directly the body, stage, and mirror. Coarse-adjustment is effected by rack-and-pinion moving the body, whilst fine-adjustment for the first time by lever and screw acts on the nose-piece only. The mechanical stage has rectangular motion and can be rotated. Described and figured in *Microscopic Journal*, ii. p. 1.

16. ANDREW ROSS. 1842-3. (R.M.S. Cat. No. 47.) Type—Compound: Achromatic. In execution of an order by the Council of the Microscopical Society of London in 1841, Andrew Ross produced this type of Microscope. The pillar is mounted on a circular base, which rotates so as to increase the steadiness of the base when the Microscope is inclined. The body slides in the grooved limb, and the fine-adjustment acts by a lever on the nose-piece. The mechanical stage has rectangular movements and also rotates. Described and figured in *Journ. R.M.S.*, 1899, p. 214.

17. DR. EDWIN QUEKETT'S Microscope. 1844. (R.M.S. Cat. No. 3.) Type—Compound: Achromatic. This instrument was designed and mainly constructed by Dr. Quekett, the founder of the Royal Microscopical Society, and was bequeathed by him to the Society. Whilst following James Smith's Microscope in general arrangement, this model is characterized by greater rigidity of the foot and pillar. The mechanical stage is made on A. Ross's pattern. Below the stage there is a focussing condenser.

18. POWELL AND LEALAND. 1848. (R.M.S. Cat. No. 129.) Type—Compound: Achromatic. This model is the first example in which the Microscope is hanging in a tripod, and also the first example in which the fine-adjustment moves the nose-piece by means of a lever within a bar. The mechanical stage has Turrell's rectangular movement, and possesses a focussing condenser. This type of Microscope appears to have been first made in 1843. Described in *Journ. R.M.S.*, 1901, p. 727.

19. Microscope by CARY, with VARLEY'S Lever-Stage. About 1850 (?). (R.M.S. Cat. No. 134.) An instrument constructed by

* Now the Royal Microscopical Society.

Varley with a similar stage is described and figured in "Quekett on the Microscope," 1848, p. 94.

20. JACKSON'S Microscope. Date, about 1860 (?). (R.M.S. Cat. No. 133.) Type—Compound: Achromatic. This stand was made by Dr. George Jackson (one of the Founders and a President of the Microscopical Society of London, now the Royal Microscopical Society). The limb is in one piece and is planed straight through from end to end in one cut, so as to form a dove-tailed groove in which the body and substage move by means of rack-and-pinion. A fine-adjustment is fitted to the stage; the mirror is attached to the substage and moves with it. The limb is mounted on two pillars which are screwed to a horse-shoe foot, which is too small and gives an insufficient base.

21. THOMAS ROSS. 1863. (R.M.S. Cat. No. 8.) This is the Microscope presented by Mr. Thomas Ross in exchange for the instrument made for the Royal Microscopical Society in 1841 by Andrew Ross (see Exhibit No. 16), and represents the ideal Microscope of the period.

22. LADD'S Student's Microscope. About 1864. (R.M.S. Cat. No. 145.) Type—Compound: Achromatic. This model is of an original design, differing in most of its features from all others of its period. The body, stage, substage and mirror are fitted on a straight grooved bar planed through from top to bottom, as in the Jackson stand (see Exhibit No. 20). The substage has rack-and-pinion adjustment, but the position of the mirror is fixed. The tripod foot is made of light tubing, and has a fairly good spread of base. The coarse-adjustment and the stage movements are operated by fine chains working on spindles attached to the usual milled heads. The fine-adjustment is worked by a loose lever hanging from the spindle of the coarse-adjustment.

23. POWELL AND LEALAND. No. 1 Stand, 1869. (R.M.S. Cat. No. 122.) Type—Compound: Achromatic. This model is a development of their stand of 1848 (see Exhibit No. 18). It is dated 1875, and with the addition of a fine-adjustment to the substage, rack-and-pinion to the draw-tube, and diagonal rackwork to the coarse-adjustment, the design remains unaltered to the present day. This stand was preceded by one of a smaller size, which was probably introduced after 1851.

24. Ross's Binocular Microscope. 1878. (R.M.S. Cat. No. 40.) Type—Compound: Achromatic. This is a Ross-Jackson model with a Zentmayer swinging substage and a rotating stage with Turrell rectangular movements. The stage can also be placed at an angle with the optic axis. The substage has rack-and-pinion and centring adjustments. The tripod foot is cast in one piece with the uprights for carrying the trunnions.

25. Ross's Large Binocular Microscope. 1888. (R.M.S. Cat. No. 186.) Type—Compound: Achromatic. The body is suspended by trunnions on two pillars fixed on a modified horse-shoe foot. The rotating stage has rectangular mechanical movements and a device for tilting a slide towards the objective when using high powers in order that the working distance may be ascertained. There is a rotating Zentmayer substage with rack-and-pinion focussing and centring adjustments. Schroeder's fine-adjustment is fitted to this instrument.

26. BECK'S Imperial. 1913. A good example of the complete English model on tripod base.

27. SWIFT'S I.M.S. Microscope. 1913. A special design for medical Bacteriology and Hæmatology. This stand was specially constructed for use in the Indian Medical Service. It has a built-in mechanical stage.

The Secretary moved a vote of thanks to the President, who had at great personal inconvenience given two demonstrations each week. It was owing to his energy that the Society had been enabled to provide a striking exhibit in a most important exhibition showing the progress that had been made during the war by firms associated with the production of scientific material. The exhibition had a great influence on a large number of people, and the demonstrations were well attended.

The vote of thanks was carried unanimously, and it was decided that the report, together with a list of the Society's exhibit, should be printed in the Journal.

The following communications were then made:—

In connexion with the exhibition of fresh-water Copepods, Mr. Scourfield said that the Copepods, or "paddle-footed" Crustacea, formed one of the divisions of the Entomostraca, and were divided into three groups, typified by the genera *Diaptomus*, *Cyclops*, and *Canthocamptus*, representing the families Centropagidæ, Cyclopidæ, and Harpacticidæ respectively. Apart from differences in morphology, which were very well marked, the methods of swimming in the three types were quite different. *Diaptomus* normally progressed with a gliding motion brought about by the rapid vibration of the second antennæ and the oral appendages. During this gliding movement the long first pair of antennæ were placed almost at right angles to the body, which was held obliquely, back downwards. The animal could also move through the water by very powerful jerks. *Cyclops* could not glide, but always jerked about, though it was remarkable that while swimming the body was held in different ways by different species, some with the back up, others vertically, and others obliquely with the back downwards. *Canthocamptus* and its allies also jerked about, but with a peculiar zigzag spiral motion.

As a rule *Diaptomus* was found only in the clear water of ponds and lakes, but *D. castor* occurred in little grassy pools. *Cyclops* in one form or another was met with in fresh water everywhere, but many of the species were restricted to particular types of pond, etc. *Canthocamptus* and its allies were found not only in weedy ponds and ditches and the margins of lakes, but certain species could usually be obtained from wet mosses growing in swamps and bogs, on rocks and walls, and on posts, etc., just above the surface of the water. One species he had found only in the cups formed by the leaves of Bromeliaceous plants at the Royal Botanical Gardens at Regent's Park and at Kew, while another was only obtained from the little collections of water in holes on tree-trunks.

As regards the number of species of British fresh-water Copepods, there were about ten species of *Diaptomus* and two of the allied genus *Eurytemora*. *Cyclops* was represented by at least twenty-five, perhaps thirty, species. Of *Canthocamptus*, *Nitocra*, *Morararia*, and other genera belonging to the Harpacticidæ there were some twenty-five species, but there was yet much work to be done on this group.

In the determination of the species of Copepods very minute characters were relied upon as a rule, but strangely enough some closely allied species showed characteristic colour markings and other peculiarities which could be seen by the naked eye or a pocket-lens. Some of these characters had been used long ago by Koch, a copy of whose work had been very kindly brought to the meeting by Mr. Soar.

For the examination of Copepods, the Rousselet live-box was probably the best method, especially when fitted with a thin metal ring to which very thin cover-glasses could be cemented. By this means the highest powers could if necessary be brought to bear on the object. When so used in conjunction with a good condenser details of structure could usually be made out which would only otherwise be obtainable by dissection, a troublesome matter when dealing with creatures no more than $\frac{1}{50}$ -in. perhaps. For preserving in tubes formalin was probably the best all-round medium, and for mounts glycerin-jelly was on the whole most suitable.

Mr. Scourfield then referred briefly to some of the actual specimens exhibited.

The following objects (Fresh-water Copepods) were exhibited:—

- | | |
|-------------------------------|---|
| Mr. S. E. Akehrst | <i>Diaptomus castor</i> ♂. |
| Mr. E. Cuzner | <i>Cyclops fuscus</i> , etc. |
| Mr. D. Davies | <i>C. strenuus</i> . |
| Miss L. R. Francis | <i>C. phaleratus</i> . |
| Mr. J. Grundy | <i>C. fuscus</i> ♀. |
| Dr. J. R. Leeson | <i>Canthocamptus minutus</i> . |
| Mr. J. M. Offord | <i>Cyclops vicinus</i> . |
| Mr. R. Paulson | <i>C. bicolor</i> , the smallest British species
of <i>Cyclops</i> . |
| Mr. F. J. W. Plaskitt | <i>Diaptomus castor</i> ♀. |
| Mr. J. Richardson | <i>Cyclops maerurus</i> . |
| Mr. D. J. Scourfield | <i>Viguiereella ceca</i> (<i>Belisarius viguierei</i>),
from the cneps formed by the leaves
of Bromeliaceous plants at the
Royal Botanic Gardens. <i>Morararia</i>
<i>arboricola</i> , from tree-holes in
Epping Forest. |
| Mr. C. J. H. Sidwell | <i>Cyclops fuscus</i> ♂. |
| Mr. C. D. Soar | <i>Canthocamptus minutus</i> . |
| Mr. W. R. Traviss | <i>Cyclops affinis</i> . |
| Mr. J. Wilson | <i>Cyclops albidus</i> . |

A vote of thanks was accorded to Mr. Scourfield and to those who had brought microscopes and specimens.

Colonel Clibborn exhibited a tank he had constructed. It was constructed of two pieces of plate-glass about nine inches in length, kept apart and made water-tight by means of an undressed rubber tube running along the bottom and sides, strips of wood inside the tube keeping the glass sides the required distance apart. Pieces of angle-brass clamped by means of bolts and nuts kept the sides firm, and the whole was then fitted to a wooden base. It was a simple thing to make and could be taken to pieces in a minute.

Colonel Clibborn was thanked for his exhibit.

The President gave a short description of the booklet published by the Medical Research Committee on the "Diagnosis of Gonococcal Infections and the Methods for the Detection of Spirochaetes." He had previously invited the Fellows of the Society to put their knowledge at the disposal of the medical men of this country in assisting them in the diagnosis of venereal diseases. The booklet referred to was now ready, and he would be pleased to let those who could assist in the direction indicated have copies as far as the supply was available. The Council would be glad to have the names of those Fellows who could help and who had not yet replied, so that a complete list could be printed as soon as possible. He was quite convinced there was room for the Society to do useful work in this direction. The method was very simple with the dark-ground illumination apparatus now available.

The question of illumination was a difficult one even in ordinary work, and he had found a difficulty in that respect in connexion with this particular work. The intensity of the illuminant was a very important factor. The differentiation of *Spirochaeta pallidum* was difficult when other Spirochaetes were present. He had therefore designed a very simple gas-lamp which helped to solve the problem. It was sufficiently intense to see *S. pallidum* easily, and it enabled its characteristics to be observed. He wished them to note that the main point of difference from the other similar objects showing in the field at the same time was the very definite blueness of colour of the organism. The source of light in the lamp was an incandescent mantle, but it was not used as an open fabric which gave bright lines and dark spaces, but the mantle was lightly rolled and put in a tube. The fabric had to be specially woven, cut off into lengths and made into cigarette form. It was pushed into a metal tube, with a quarter of an inch protruding which came in touch with a Bunsen flame. The end could be actually in the flame for days together while the rest of the mantle remained unaltered. The mantle could be easily renewed from time to time by pushing forward the unburnt portion in the tube. It provided an image circular in area, and as large or as small as desired. It fulfilled the want there was for an illuminant of sufficient intensity with not too large an area, and he trusted it might be useful in the work for which it had been designed.

Mr. A. Ashe and Mr. M. A. Ainslie congratulated the President on the production of a very efficient illuminant, the latter pointing out that

it was equally good in illuminating the field of view and in filling the back lens of the objective.

Professor Conrady said that the lamp nipped a lot of microscopical troubles in the bud, for a round source of light was certainly an ideal.

A vote of thanks was accorded to the President for his remarks, who in reply stated that he had made up his mind not to leave the Presidential Chair without saying something about that fetish "the edge of the flame"—as so many seemed to think that all other troubles vanished if only this were used. What was required was a circular source of light of suitable dimension. As far as electricity was concerned, the only light that filled the bill was the Ediswan Pointolite, and there the intensity was somewhat high.

Mr. Rheinberg's donation of Photographic Scales and Micrometer Rulings was exhibited.

The President, by means of a series of lantern-slides, compared the results of photographic and diamond rulings.

The thanks of the Meeting were accorded to the President.

The President announced that the next Meeting of the Biological Section would be on November 6, when the Members would pay a visit to the King's College Bacteriological Laboratories at Chandos Street.

The business proceedings then terminated.

AN ORDINARY MEETING

OF THE SOCIETY WAS HELD AT 20 HANOVER SQUARE, W., ON WEDNESDAY, NOVEMBER 20TH, 1918, MR. J. E. BARNARD, PRESIDENT, IN THE CHAIR.

The Minutes of the Meeting of October 16 were read, confirmed, and signed by the President.

The President drew attention to the important events that had taken place since their last meeting. He was sure he was voicing the feelings of all present in expressing gratitude at the altered state of affairs which enabled them to meet in a time of peace. When peace had been officially declared the Society would be asked to express its opinion in a more formal manner. It was a matter for sincere congratulation that the Royal Microscopical Society had suffered little in loss of Fellows.

The Nomination Paper was read of Mr. Herbert George Blackmore.

New Fellows.—The following were elected Ordinary Fellows of the Society :—

Mr. Charlton S. Agate, B.Sc., etc.
 Mr. Charles Baxter, C.E., M.I.Mar.E., etc.
 Mr. John Leslie Berry.
 Capt. Thomas Buller Bradshaw, J.P.
 Miss Lettice Digby.
 Mr. Ernest Chalders Garbntt.
 Mr. Edward Collete Hort, F.R.C.P. Edin.
 Mr. William Sandford Hoseason.
 Mr. Owen Lloyd Hughes.
 Mr. Robert Hicks Kidd, R.E.
 Mr. William I. Morrish, M.D., etc.
 Mr. Frank Rowley, M.I.M.M.
 Mr. Walter Salmon.
 Mr. Herbert Sutcliffe.
 Mr. Edward E. Triggs.

Mr. A. Earland read the following :—

REPORT OF THE MICROSCOPICAL SLIDES CABINET COMMITTEE.

1. A Sub-Committee, consisting of Messrs. A. Earland, J. Hopkinson, and the Honorary Curator, E. J. Sheppard, was appointed on the 21st February, 1917, to revise the collection of Micro Slides and arrange the

residue, with the object of making the collection available to Fellows. Mr. Hopkinson has unfortunately been unable to take any part in the work, and the following report represents the work and views of the other two members only.

2. The Society's collection was found to consist of about 10,000 slides. With the exception of the "Suffolk" and "Beck" Collections, which have been contained in special cabinets, the whole of the slides are stored in a large cabinet. The origin and history of this cabinet is unknown to us, but it may be described as hopelessly unsuitable for its purpose owing to its construction. Each drawer holds 104 slides arranged in two layers, and it is impossible to get at a slide in the lower layer without removing the drawer from the cabinet, and lifting out a removable tray which holds the top layer of 52 slides.

3. The slides in the large cabinet were arranged on a chronological system, according to the date of their acquisition, and this has resulted in an entire absence of systematic classification. The earliest acquisition bears date March, 1857, and is catalogued as "O.C. 1" (= Old Collection, No. 1). From that date until April, 1897 all slides as acquired were entered under consecutive numbers in the old register, the number being 7,250, although this includes the "Beck" Collection of Bone Sections already alluded to, which bear an O.C. number, though kept in a special cabinet in accordance with the terms of the bequest.

4. In April, 1897, the new register was commenced, and the consecutive numbering of the slides ceased. From this date a system was adopted under which each block of slides acquired was registered under the date of acquisition plus a serial number. The new register begins with a collection of 424 Molluscan Radulae, mounted by the Rev. H. M. Gwatkin, and presented by Mr. Rousselet. These are registered as 97.4.30, Nos. 1-424, the 30th April, 1897, being the date of their acquisition. The register entry also shows the drawer of the cabinet in which each slide is to be found. This was unnecessary under the old system, as the drawers were marked with the numbers they contained.

5. About 1725 slides have been acquired since the new register was started, and these also are devoid of any classification. Indeed, from the very commencement of the cabinet the only arrangement noticeable is that certain collections already classified by the previous owners have been absorbed *en bloc*.

6. We are unable to see that the new register system constituted any advance on the old. In the absence of a subject-index it was impossible to locate any particular slide without laborious search through the registers, or even to say whether the Society possessed one or twenty specimens of a particular subject.

7. Two efforts to remedy this defect have been made. The old register contains several pages showing the cabinet numbers of slides belonging to many prominent groups. This was only a makeshift for the benefit of the Curator.

8. The late Mr. Suffolk, when Curator, made a card-index of the slides, exclusive of the diatoms. The cards are sorted under a very elaborate system in a cabinet. The system is, however, faulty; it was more or less incomplete at the author's death, and was then abandoned, so that at present it has no value. We are of opinion that it could now

with advantage be completed and classified, and that it would prove of great value to Fellows if thereafter it was systematically kept up to date.

9. The "Suffolk" Collection, to which allusion has already been made, consisted of a separate cabinet of about 1000 slides of a very miscellaneous character, largely vegetable preparations mounted by Mr. Suffolk. It has now been merged in the general collection in accordance with the decision of the Council.

In our opinion detached collections lose value by their isolation from the general cabinet, besides entailing more work on the Curator.

10. Two factors became obvious as soon as we started the revision of the cabinet:—(1) The repeated duplication of all favourite micro subjects. (2) The very inferior quality of many of the mounts. The duplication has no doubt been due largely to the absence of a systematic catalogue, but it is probably not unconnected with that policy of never looking at the teeth of the gift-horse, which has certainly been a standard rule of the Society in the past, and which has been responsible for the inclusion of a great number of worthless slides. Donations have been accepted and incorporated in the cabinet, and the grateful thanks of the Society no doubt tendered for slides which were often below the mounting standard of a novice. We are aware that it is not always an easy or a graceful business to refuse a gift tendered by an old esteemed Fellow, but we are strongly of opinion that the situation is not beyond tactful treatment, and that the Curator or a Sub-Committee should in future report on proffered donations before they are definitely accepted.

11. Our first step was to go through the cabinet and remove all slides which might be regarded as entirely worthless, owing to inferior methods of preparation or deterioration from age and neglect. This resulted in the scrapping of over 1100 slides, and of these it is sufficient to state that they have neither scientific nor commercial value. They represent merely their value in waste slips, and in accordance with the Council's decision will be distributed among such Fellows as may feel inclined to clean the slips for further use.

12. A second scrutiny of the cabinet was then made, which resulted in the rejection of about 1750 slides, which may be described as having some commercial value. These consist of:—(1) Duplicate slides. (2) Damaged slides, capable of remounting or repair. (3) Slides unsuitable for the Society's cabinet, either owing to the nature of the subject or the method of mounting.

13. The value of these slides varies considerably, some of the duplicates being first-class specimens and others of great interest or rarity. As decided by the Council, these slides will be open to the inspection of Fellows, who may make any selection at a price which will at first be fixed at one shilling each. As the collection diminishes the price will necessarily be reduced, and we suggest that after a reasonable interval the unsaleable residue should be placed in the hands of Mr. Angus, with directions to dispose of them to the best advantage. The money received for these slides should, we think, be devoted to the purchase of further slides, or become the nucleus of a fund for a new cabinet.

14. The elimination of these wasters and duplicates, and the donation of the Wallich Collection to the British Museum, has reduced the cabinet to about 5125 slides, which we have now re-arranged in the cabinet on a scientific classification, according to the subjects of the mounts. It will in future be possible to go direct to the cabinet and withdraw all the specimens dealing with any particular subject. This re-arrangement has been a most laborious task, owing to the limitations of cabinet space, and the number of transposals required in the sorting processes before the specimens could be assembled in their proper drawers. Now that the process is complete it becomes painfully apparent that the cabinet resembles the Irishman's trousers, inasmuch as it consists largely of gaps. A few subjects are adequately and even liberally represented, others of equal, or from the microscopist's point of view, of greater importance, have only the slightest representation, and sometimes none at all. In a general sense it may be stated that the collections illustrate the technique of the past. This is not a matter of any moment so far as many groups are concerned, but in other groups, especially animal and vegetable physiology, modern histological methods are poorly represented, and we think it desirable that the cabinet should be strengthened by a large addition of modern mounts.

15. There were two sections of the collection which we did not feel disposed to touch as they required specialist treatment. These were:— (1) Microscopic writings and rulings consisting of about 110 preparations. (2) Diatoms consisting of about 1000 mounts. Mr. Barnard was good enough to undertake the examination of the first group, and reports that they are nearly all of interest and should be preserved. It appears that these specimens should not be allowed to circulate without the special permission of the Council, as they are mostly of historic interest and not replaceable.

The Diatom collection is of a very miscellaneous nature, and a large proportion of the slides are of such poor quality that we should have rejected them but for the fact that they have nearly all been examined and reported on by the late Mr. Comber, whose MS. notes are in the possession of the Society. Included in the collection are many slides mounted in special media for resolution purposes, and it is probable that the majority of these have become valueless.

The Diatom collection has for the time being been incorporated *en bloc*, but the Council has accepted the services of a Fellow of the Society who has kindly offered to revise the collection and arrange the selected slides under some scheme which will render them available to Members. A further addition of named and selected species-slides similar to the "Eulenstein" series recently given by Dr. Pritchard should also be obtained in order to supplement the collection, which at present consists largely of spread-slides.

16. Before the cabinet can be advantageously placed at the disposal of the Fellows two things appear to be necessary:—

(1) A new cabinet, or the reconstruction of the existing cabinet on more convenient lines, so as to make all slides accessible without the removal of the drawers from the cabinet.

(2) A printed catalogue of the contents. The card-index, even when

completed, will be of no use except to the Curator and the few Fellows who frequent the Society's rooms.

We take it that the Society will not in the present financial period be prepared to spend money on either of these objects, and, indeed, at the present time the gaps in the collection are too obvious to make a printed catalogue desirable. We think, however, that this would be a very suitable time to fill in the gaps, so that the catalogue when ready for printing may worthily represent the collection of the Royal Microscopical Society. There must be numerous Fellows, and other microscopists working at special groups, who would respond cheerfully to an invitation to give some of their best work a home in the Society's cabinet, and with this end in view we conclude our Report with an Appendix showing how the groups are now represented, and indicating the gaps which it is desired to fill.

A. EARLAND.

E. J. SHEPPARD.

APPENDIX TO THE REPORT.

Animal Kingdom.

The sub-kingdom *Protozoa* is very sparingly represented in the cabinet apart from *Foraminifera*, of which there are over 100 named species and some eighty spread-slides. The Infusoria, the Mastigophora, and the Lobosa are each represented by a single slide, but the Sporozoa and Heliozoa are entirely unrepresented. There are about 20 Radiolaria, but nearly all spread-slides.

Sponges are represented by some 70 preparations, a poor selection except so far as fresh-water sponges are concerned. Many of the specimens require naming or re-naming.

Celenterata are very poorly represented, only about a dozen Hydroids and as many Gorgonids.

Worms.—A very poor series, about 50 slides, but interesting historically as they include mounts by Cobbold, Rosseter, and Bastian.

Rotifera.—Less than a dozen mounts, in good condition.

Crustacea.—Very poorly represented by about 50 slides, 29 or more of which are hard sections. There are only a few mounts of Cladocera and Ostracoda.

Myriapoda.—Two slides only.

Acarina.—There is a fine set of over 100 Oribatidæ, given by Mr. Michael, but very few of other groups.

Pseudoscorpions.—One only.

Ticks.—About a dozen.

Spiders.—About 15, some good.

Pycnogonida.—Two mounts only.

Insects.—A considerable number of slides, but not many high-class preparations.

Thysanura and Collembola.—Over 30 mounts of Podura scales, which Mr. Barnard has undertaken to examine.

Orthoptera, 7. *Neuroptera*, 6. *Mallophaga*, 14.

Aphaniptera, 4. *Thysanoptera*, 1. *Hemiptera*, 10.

Anoplura, 8.

Hymenoptera.—About 50, including less than 12 high-class mounts.

Coleoptera.—About 45 medium mounts, very few really good.

Diptera.—About 60. Some good mounts and dissections, but the latter roughly mounted and in poor condition.

Lepidoptera.—A good series of about 20 eggs; 50 or 60 scales, not examined; and about 20 other slides, some good.

Mollusca.—Over 400 named Radulae and about 40 hard sections, chiefly by Carpenter.

Bryozoa.—A good collection of about 200 named species.

Echinodermata.—Over 60 slides, including several mounts by Carpenter, but in poor condition.

There are no representatives of the *Chætognatha* (*Sagitta*) or *Hemichordata*. One slide for each of the groups *Urochordata* (*Pyrosoma*), *Cephalochordata* (*Amphioxus*), and *Cyclostomata* (*Lamprey*).

Fishes.—About fifty slides, chiefly scales, hardly any anatomical.

Amphibia, *Reptilia*.—About 40, including some good anatomical preparations.

Birds.—About 40 slides, half of which are opaque injections of fowl, of no great interest or value.

Mammalia.—The anatomical section consists of rather more than 100 slides, including some good preparations by Cole and others, a large number of opaque injections by Farrant; good examples of this class of mount, but of little value as micro slides. Modern preparations illustrating recent technique and histology are badly required.

Mammalian Hairs.—About 90 mounts, including a series of bat hairs (dry and balsam) of some interest.

Bones and Teeth.—The Beck Collection consists of over 400 preparations of the highest class, in a special cabinet. These must not be lent to Fellows under the terms of the gift.

A fine series of mounts by Tucker will be available for loan.

Human.—Apart from the Zeiss series of about 90 preparations, there are some 80 or 90 mounts, anatomical and pathological. They are as a whole poor specimens, and modern preparations illustrating recent technique are desirable.

Vegetable Kingdom.

The lower *Algæ*, a specially interesting group to the microscopist, are very badly represented—*Cyanophyceæ* by some 20 slides of poor quality, *Chlorophyceæ* even worse: only 25 slides to represent Green Algæ! Some of these are very poor, but have been retained in the absence of other mounts. Among them is a slide of *Volvox globator*, the only representative of its order, which was mounted in 1849. There should be no difficulty in gathering a suitable collection of Green Algæ. There are only five poor *Desmid* slides and one *Chara*.

The *Red Algæ* are well represented by over 200 slides mounted by Mrs. Clarke, of Whitby, which in spite of their age are in good condition.

Fungi.—Very poorly represented by about 20 very old mounts.

Lichens, 2. *Liverworts*, 8. *Mosses*, 5.

Ferns, 13. *Equisetaceæ*, 4. *Lycopodiæ* 2.

Bacteria.—Hardly represented at all.

Phanerogam tissues.—About 50 slides of varying merit, few really first-class mounts. Modern histological preparations and cytological slides are badly wanted.

Starches.—A fairly representative series.

Raphides.—A few.

Wood Sections.—A useful series of nearly 100 somewhat roughly mounted preparations.

Vegetable Fibres.—A very large and valuable series of over 200 slides. They are apparently in good condition, though probably untouched for nearly 50 years.

Rock Sections, Coal, Flint.—Eight original Eozoon preparations by Carpenter and about 40 other sections of good quality. About 20 flints with *Xanthidia*, good but rough mounts. There is room for large additions to the cabinet in this section. A few interesting coal and shale preparations.

Minerals.—A good number, including a series of over 50 preparations of native gold and associated minerals from California and other parts of the world.

NOTE.—The figures were taken out before the inclusion of the "Suffolk" Collection, but this does not materially affect any group.

The President said it was very difficult to realize the enormous amount of work the report had involved. There was great difficulty in deciding whether a slide was worth retaining or whether it should be thrown out. The collection of slides had now been arranged on a scientific basis, and the cabinet was ready for use. It was the duty of every Fellow of the Society to look through his own collection of slides to see what could be presented to the Society to help to fill vacant spaces in the cabinet.

He would like to propose a very cordial vote of thanks to Mr. Earland and to Mr. Sheppard for the work they had done and the efficient manner in which it had been carried through.

The vote of thanks was carried by acclamation.

In reply to a suggestion by Mr. J. Richardson that slides of historical interest as illustrating mounting methods should be preserved in a special cabinet, Mr. Earland pointed out that there had been no difference in the methods of mounting since the beginning of the collection. The Society did possess representative slides of pre-balsam days in connexion with the collection of instruments, and these included the ancient sliders and the talc and mica mounts. Other slides, by Mr. Cromwell and Dr. Carpenter, with quasi-sentimental value, were retained for the sake of the mounters and for their historical associations.

Mr. R. Paulson, F.L.S., read a paper on "The Microscopic Structure of Lichens." Mr. Paulson expressed his deep regret at the absence of Miss Lorrain Smith on account of illness. She was a recognized authority on the subject of Lichens, and had now completed her great

work, "A Monograph of the British Lichens." The meeting would lose a great deal owing to her absence. They had agreed that he (Mr. Paulson) would say something on the microscopic structure of the thallus, and Miss Lorrain Smith would speak of the reproductive organs, because they were now more necessary in connexion with classification. Her book had brought British Lichenology up to the most modern thought and tendencies. On the tables had been arranged slides of foliose and fruticose lichens, and also a series of slides illustrating spore formation, which Miss Lorrain Smith would have dealt with had she been present.

The President, on the conclusion of the paper, said he had been very interested in Mr. Paulson's remarks, but it was a subject on which he did not feel competent to offer any criticism. He would, however, draw attention to one point. Mr. Paulson had made every effort by microscopical technique to obtain accurate images and a correct interpretation of what he saw. This was somewhat uncommon even in the Society. The illustrations given them on the screen had been particularly beautiful, and showed a great advance over any work published hitherto. It would be a valuable addition to the literature of the subject when the paper was published in the Journal.

Thanks were accorded to Mr. Paulson, coupled with an expression of regret at Miss Lorrain Smith's illness.

The President announced that the next Meeting would be held on December 18, and that the Biological Section would meet on December 2, when Mr. C. D. Soar, F.L.S., would make a communication on "A Species of Uropoda."

ROYAL MICROSCOPICAL SOCIETY

MEETINGS FOR THE SESSION 1918—1919

AT 8 P.M.

Wednesday, Oct. 16, 1918	Wednesday, Feb. 19, 1919
„ Nov. 20, „	„ Mar. 19, „
„ Dec. 18, „	„ Apr. 16, „
„ Jan. 15, 1919	„ May 21, „
(<i>Annual Meeting for Election of Council and Officers.</i>)	„ June 18, „

Council Meetings are held on the third Wednesday, Meetings of the Biological Section on the first Wednesday in each month from October to June.

Fellows intending to exhibit any Instruments or Objects, or to bring forward any Communications at the Ordinary Meetings, are requested to inform the Secretaries a week before the Meeting if possible.

The Library and Rooms of the Society are open for the use of Fellows on Wednesday Evenings, other than Meeting evenings, from six to nine o'clock, except during the vacations.

INDEX

A

Aberystwith Area, Agricultural Zoological Survey of, 187
 Abra, 369
 Acanthocephala of North American Birds, 308
 Acanthoænia, New Species of, 198
 Acari, New Parasitic, 57
 Acarid, Intracellular Digestion in, 379
 Acetone as a Solvent for Mounting Media, 279
 Achrolihanus g. n., 385
Acrepora palmata, 200
Acrostichum prastantissimum, 208
 — *aureum*, 209
 Actiniaria, Antarctic, 312
 — Irish, 387
Actinernus aurelia sp. n., 387
Actinostola atrostoma sp. n., 387
Actinostromaria stellata, 60
 Adams, Nathaniel, 412
Æcidium tubulosum, 327
 — *passifloricola*, 327
Æschma cyanea, 372
 — Larvæ, Circulation in, 193
Agaricus tabularis, 220
 Age, Advancing, Myelin in, 185
Aglaophema hoveensis, sp. n., 387
 — *sinuosa* Bale, 387
 — *vaga* sp. n., 387
Agriades thetis, Scales of Leadon Males of, 191
 Agrionid Larvæ, Circulation in, 193
 Ainslie, M. A., Some Principles of Illumination, 397
Aiptasioides g. n., 312
Alasostoma g. n., 385
 Alcohol-Effect on Progeny of Fowls, 37
 Alcyonarians, Australian, 59
Alectrion obsoleta, 301
Aletrigorgia orientalis (Ridley), 59
 Alexicoff, A., *Blastocystis enterocola*, 63
 Algae, Biology of, 72
 — Calcareous, 215
 — — from Malta, 216
 — Fresh-water, of the Austrian Coast Districts, 324
 — Minute, Staining of, 73

Algae, Marine, of Denmark, 216
 — — Iodine in, 325
 — — Japanese, 78
 — — of Cuba, 325
 — — of the Danish West Indies, 78
 — — of Shaw Island, 77
 — of Bermuda, 76
 — of Michigan, 215
 — of Puget Sound, 77
 — of the Hawaiian Archipelago, 216
 — Thermal, 215
 — Water-supply, 215
 Algal Associations of San Juan Island, 77
 Algology, Oceanic, 76
Alicularia scalaris, Cytoplasm in Cells of, 319
 Alien Enemy Fellows Removed from Roll, 112, 240
 Alismaceæ, Embryogeny of, 65
 Allantois, Grafts of Spleen on, 364
 Allemand-Martin, A., 201
 Allen, Bennet M., Removal of Thyroid from Tadpoles, 296
 Allen, E. J., and E. W. Sexton, Eye-pigment in *Gammarus chevreuxi*, 195
 Alligator, Blood-corpuscles of, 183
Alternaria panax, 87
 — sp. 222
 Alveolina, 315
 Amber, 45, 46
 Amblystoma, 181
 — Grafts in, 297
 — *punctatum*, Development of Fore-limb of, 295, 297
 — — Development of Shoulder-girdle and Fore-limb in, 295
 — *tigrinum*, 297
 Amemiya, I., Telescope-eye of Goldfish, 368
 Amesopodidae, 382
 Amiotic Division in Adipose Cells, 189
 Ammocetes, Branchial Epithelium of, 298
 Ammodiscine, 406
Ammodiscus Reuss *senen* Brady, 406
 — Cushman, 406
 — Reuss, 406
 Amœba, Metabolic Gradients in, and their Relation to Amœboid Movement, 312
 — New, from Man, 313

- Amœbæ Cysts, Rapid Differentiation of, 96
 — New, 389
 Amœbidium, Multiplication in, 63
 Amœboid Activity of Germ-Cells, 39
Amphidromus maculiferus, 45
 — *quadrasi*, 45
 Amphidromus, Philippine Species of, 45
Amphilepis-Pecten, 369
 Amphioxus, Hatschek's Pit in, 186
 — Wheel-organ in, 187
 Amphipods, Body-colour and Blood-colour in, 196
 Anæmia associated with Infection by *Echinostoma*, 199
 Andalusians, Blue, 300
 André, Emile, Helminthological Notes from Switzerland, 199
 Anæmia, Stellar Ontogeny of, 208
 Aneuræ, 212
 Angioblasts and Blood-vessels, 180
 Angus, H. F. & Co., The Barnard Incandescent Gas Lamp, 397
 Annandale, Nelson, Sponges from Inlé Lake, 389
 Annelid, Peculiarly Adapted, 306
 Annual Report, 241
 Anœstrum, 35
Anopheles bifurcatus, 333
 — *maculipennis*, 334
Anoplodactylus lentus, 57
Anoplophrya lloydii sp. n., 390
 Ant Larvæ, 373
 — — and Workers, Nutritive Exchange between, 373
 — — "Trophidium" of, 373
 Antedon, Anal Plate in, 310
 Anthoceros, 212
 Anura, Development of Hypophysis of, 362
Apnesia electrophila sp. n., 45
 Apertometry, an Improved Method of, 337
 — Diagrams to Illustrate, 340, 342, 343, 344
 Aphroditidæ, 383
 Aplodontia, Auditory Ossicles of, 42
Aplysia californica, Pedal Locomotion of, 302
 Apocynacæ, Ovule in, 65
 Apple and Pear Scab, 329
 — Canker due to *Nectria ditissima*, 226
 — Mildew, 329
 Apple-rot Fungi in relation to Temperature, 222
 Apple-trees, Die-back of, 87
 — Root-rot of, 88
Apus australiensis, 381
Arachnidopsis paradoxa, 283
Arbutus Uedo, 88
 Arctiidæ, Wing-markings of, 302
 Arey, Leslie B., Phagocytosis by Osteoclasts, 183
 — Shape of Red Blood-corpusele in Mammals, 183
 Arey, Leslie B., Shape of Mammalian Red Blood-corpusele, 298
Argus persicus, 380
Argia talamanca, 377
Arius falcarius, 364
 Armadillo, Germ-Cells of, 177
 Arnell, H. W., Bryophyta of the Vega Expedition, 321
Artemidactis g. n., 312
 Arthropods from Burmese Amber, 45, 46
 — Reflex Immobilization in, 372
 Arthur, J. C., Uredinales, 327
 "Asakusarori"—a Japanese Food, 324
 — Chemical Constituents of, 324
Ascaris lumbricoides and *A. mystax*, Development of, in Mouse, 307
 — Life-history of, 132
 — *lumbricoides*, 383
 — *megalocephala*, 384
 — *suilla*, 187
Ascidia atra, Sensory Reactions of, 301
 Ascidian, Vascular System of, 371
 Ascidiæ, Circulation in, 372
 — Philippine, 371
 Asclepidacæ, Ovule in, 65
 Ashfordia, 188
 Askaron. Rats and Mice after Inoculation with, 384
Aspergillus flavus, 221
 — *fumigatus*, 221
 — *niger*, Species grouped as, 218
 — *repens*, 221
 Aspidium, 318
Asplenium Scelosii, Ecology of, 211
 Astacillidæ, 382
 Astacillinæ, 382
 Astrohizidæ, 405
 Atelecerinus, 386
Ateles pentadactylus, 314
Atergates floridus (Linn.), 196
Athyrium humile, New Fern, 67
 Atichia, 329
 Atkinson, E., Microstructure of Hypo-eutectoid Steel as contrasted with that of Normal Steel, with a Note on the Microscopical Methods adopted in the Examination of Steel Specimens, 243, 265
 Atopocrinus, 386
 Atopomelus g. n., 379
Atractomorpha bedeli, 377
 Atwell, Wayne J., Development of Hypophysis of Rabbit, 362
 — — of Hypophysis of Anura, 362
 Auditory Capsule in Man, 33
 Austrobilharzia g. n., 199
 Ayers, S. H., 221

B

- Babiet, J., Leucocytes in Experimental Spirochetosis, 371

- Bachhuber, L. J., 360
Bacillus aerogenes capsulatus, 91
 — *aerogenes encapsulatus*, 394
 — *botulinus*, 393
 — *citromaculans*, 227
 — *dysenteriae* Flexner, 92
 — — Agglutination of, 92
 — — Hiss, 92
 — — Shiga, 92
 — *enteriditis sporogenes*, 91
 — of Fränkel, 394
 — of Malignant Oedema (Koch), 394
 — *paratyphosus A.*, 92
 — — *B.*, 92
 — *perfringens*, 394
 — *phenologenes* regarded as Causative Agent of Sclerosis of Arteries, 227
 — *pyocyaneus*, Variety of, 90
 — *subtilis*, 91
 — *tetani*, 91
 — — Medium for Cultivating, 231
 — *tubercle*, Double Staining of: a Modification of Spengler's Method, 403
 — *welchii*, 394
 Bacot, A., Viability of Mosquito-eggs, 376
 Bacteria of Dust, 90
 — of Gas Gangrene, 394
 — Staining Sporogenous, 99
Bacterium gammari, 197
 — *tumifaciens*, 207
 Badcock, H. D., Ant-like Spiders, 195
 Badertscher, J. A., Ultimobranchial Bodies in Pig, 292
Badhamia lilacina, 393
 Balanoglossids, Photic Sensibility of, 301
 Balanoglossus, 187
 Bale, W. M., Measurement of Magnifying Power, 230
 Balsam Problem, 230
 Balsamorhiza, Resin Secretion in, 206
 — *sagittata*, 206
 Bamber, Ruth C., Hermaphrodite Dogfish, 181
 Banks, J. B., 41
 Banta, Arthur M., Sex Intergrades in *Simocephalus*, 197
 Barbieri, Nicola A., Structure of Optic Nerve, 41
 Barnacle Larvæ, Heliotropism of, 197
 Barnard Incandescent Gas Lamp, 397
 Barrell, Joseph, Origin of Air-breathing Vertebrates, 185
 Bartsch, Paul, Philippine Species of *Amphidromus*, 45
 Basidiomycetes from South America, 82
 Bateson, A. W., Cytology and Genetics, 106
 Bather, F. A., Homologies of Anal Plate in Antedon, 310
Bathynella natans, Morphology of, 196
 Batrachian Larvæ, Iridocytes in, 367
 Baumgartner, E. A., Development of Serous Glands of Tongue, 180
 Bauseh and Lomb, Metallurgical Microscope, 93
 Bazin, Method for Discovering Fungi in the Sputum of Bronchitics, 96
 Bdellostoma, Eggs and Embryos of, 291
 — (*Heptatretus hexatremus*), 291
 Beauchamp, P. de, New Pentastomid from a Fish, 306
 Beck's Imperial Microscope, 416
 Beetles, Endoskeleton of, 194
 Beet-root, Disease of, 85
 Bemmelen, J. F. van, Wing-markings of Arctiidae, 302
 Bennet, C. W., 86
 Berland, James, Alteration of Instinct in Spider, 57
 Berlese, A., New Harvest Mite, 380
 Berthelot, A., *Bacillus phenologenes* regarded as Causative Agent of Sclerosis of Arteries, 227
 Bessau, G., 394
Bethylitella cylindrella g. and sp. n., 46
 Bhatia, B. L., Protozoa of Lahore, 391
 Bijk, P. van der, Notes on Coniothecium, 81
 Birds, Australian, Trematodes of, 199
 — Fundus oculi of, 407
 Black-rot Fungus on the Apple, 221
 Black-wart of Potatoes, 226
 Blade-holder for Temperature Control, 395
 Blair, K. G., 79
Blastocystis entericola, Reserve Albumenoids of, 63
Blepharospora cambivora, 227
 Blood-corpusele, Red, in Mammals, 182
 — Shape of Mammalian Red, 298
 Blood-red Seas, 390
 Blood-serum, Bile-pigments in, 101
 Blood-vessels, Development of, without Heart, 293
 "Blossom-wilt and Canker," Disease of Apple-trees, 329
 Blue-green Algæ, Collecting, 215
 Boeckella, 381
 Bodine, Joseph H., Experiments on Respiration in Larval Dragon-flies, 377
 Bombinator, 368
Bombyx mori, 48
 Bone Development, Effect of Stress and Strain in, 179
 Bone-marrow, Actions of Micro-organisms on, 91
 — Giant-cells of, 367
 — in Plasma Medium, 41
 — Transplanted into Spleen, 91
 Bonnerot, S., 102
Boodlen siamensis, 78
 Boquet, A., and L. Nègre, Cultivating the Parasite of Epizootic Lymphangitis, 232
 Börgeson, F., Marine Algæ of the Danish West Indies, 78
 Boring, Alice M., 293

- Boring, Alice M., Interstitial Cells in Reproductive Organs of Chickens, 180
— and Raymond Pearl, Hermaphrodite Fowls, 292
- Boswell, P. G. H., British Resources of Sands and Rocks used in Glass Manufacture, 231
- Botazzi, F., Posterior Salivary Glands of Cephalopods, 372
- Botelho, C., Method for Double-staining Sporulating Bacteria, 233
- Botrytis cinerea*, 81, 222
- Bottomley, Averil Mand, Natal Fungi, 82
- Botulism, 393
- Boudier, E., New or Rare Fungi, 220
- Bouin's Fluid, Modification of, 232
- Bourne, Gilbert C., New Sea-anemones from New Guinea, 387
- Bourquin, Helen, Starch-formation in *Zygnema*, 74
- Boutan, L., Role of Fins in Teleosts with Swim-bladder, 43
- Bower, F. O., Phylogeny of the Pterioidea, 208
- Box salpa*, 62
- Boyce, J. S., *Gymnosporangium blaudaleanum*, 327
- Boyden, Edward A., Vestigial Gill-filaments in Saurapsida, 293
- Boyelle-Morin Apparatus, Testing Hardness of Metals by, 403
- Brachionis bakeri*, 310
— *militaris*, 310
- Brachydesmus, Peculiar Variation in, 305
- Brachysuccus juvenilis* sp. n., 308
- Branchiobdellids from Michigan Crawfishes, 307
- Branchiura sowerbyi*, 383
- Briggs, E. A., New Australian Hydroids, 387
- Bright, Elizabeth M., 307
- Brindley, H. H., Notes on Earwigs, 378
- Brissopsis Amphibura chajpei*, 369
— *lyrifera*, 369
— *sarsi*, 369
- British Scientific Products Exhibition, 411
- Broch, Hjalmar, Australian Alcyonarians, 59
— Coppinia of *Grammaria abietina*, 69
- Brochet, F., Circulation of the Blood in Insects, 193
- Brölemann, Henry W., Peculiar Variation in *Brachydesmus*, 305
- Bronchitis, Verminous, 187
- Bronze, Annealing of, 163
- Brooke, W. J., and F. F. Hunting, Microstructure of Commercially Pure Iron, 235
- Brooks, C. B., and J. S. Cooley, Apple-rot Fungi in relation to Temperature, 222
- Brown, James Meikle, On *Pyxidicula invisitata*, a Rhizopod new to Britain, and *Hedriocystis spinifera*, a new Heliozoan, 170, 243
- Brown, M. M., Embryogeny of *Phaseolus vulgaris*, 64
- Brown, W., Physiology of Parasitism, 81
- Bruner, S. C., 226
- Brush, W. D., Characters of Woods of North American Platanus, 205
- Bryophyta of the Vega Expedition, 321
— Welsh, 70
- Bryopsis corticulans*, 78
— *plumosa*, 78
- Buccinum undatum*, Trematode Larva from, 308
- Buffalo-fly, Binomies of, 192
— Milking-yards, Centres of Infection of, 193
- Buhigas, Ramón Sobrino, Blood-red Seas, 390
- Burlingham, Gertrude S., *Russula*, 328
Burmitempis halteralis g. and sp. n., 46
- Burnet, E., Bacteria of Dust, 90
- Bursaria, Reversibility of Morphogenetic Processes in, 314
- Busyron canaliculatum*, 301
- Butters, F. K., Pellæe in North America, 68
- Buxton, P. A., Protoecerebrum of Micropteryx, 190
- Byl, P. A. van der, *Polyporus lucidus*, 88
lythocrinus, 386

C

- Caccubis rufa*, 198
- Caiazana, 318
- Caldwell, J. S., 221
- Calman, W. T., Morphology of *Bathynella*, 196
- Calopteryx splendens*, 372
- Calvet, Louis, Atrophy of Right Superior Vena Cava of Sheep, 43
- Calypogeia fissa*, 212
- Cambarincola philadelphia*, 307
— *ritrea*, 307
- Cameron, A. E., Leaf-eating Crane-fly, 376
— and R. C. Treherne, Pear Thrips, 376
- Capnodium salicinum*, 329
- Carabidae, 194
- Carausius morosis*, Longevity of Males of, 52
- Carborundum, Optical Properties of, 230
- Carcharinus gangeticus*, 384
- Carcinus maenas*, 380, 381
- Caretta caretta*, 38
- Carl, J., New Spirostreptidae, 195
- Carlgenia desiderata*, g. et sp. n., 387

- Carpenter, C. W., Tuber rots caused by *Fusarium*, 84
- Carpenter, George H., Collembola of Albor Expedition, 304
- and F. J. S. Pollard, Spiracles of *Hypoderma Maggot*, 303
- Carroll, Mitchell, Hind-gut and Rectal Tracheæ in Dragon-fly Larvæ, 377
- Carrot, Disease of, 85
- Cary's Microscope, 414
- Cassiopea, Nerve-conduction in, 201
- Cassiopea zamachama*, 185
- Cat, So-called *Thymus IV.* of, 362
- Superfétation in, 178
- Caterpillars of Cabbage-white Caterpillars, 302
- Cattle-plague, 96
- Cats, Inheritance of Coat-colour in, 294
- Caulery, M., 58, 306
- and F. Mesnil, Observations on *Xenocaloma brumpti*, 380
- Cedars, Nursery Blight of, 225
- Cell-clusters, Aortic, in Vertebrate Embryos, 34
- Cell-shape, Constancey of, 316
- Cendner, A., 85
- Centurus exilicanda*, 195
- Cépède, C., Method of Staining Tubercle Bacillus, 233
- Cephalobus dubius* Maupas, 383
- Cephalopods, Salivary Glands of, 372
- Cephalozia, 211
- Ceratomyxa herouardi*, Life-history of, 62
- — Alteration of Sexual Phase of, 62
- Cercospora beticola*, 226
- — Infection by, 80
- *veticola*, 221
- Cerebratulus lacteus*, 178
- Chætiliidae, 382
- Chætoceros eriophilus*, 214
- Chætogaster bengalensis*, 383
- in Sponges, 389
- Chætomorpha antennina*, 78
- Chumæsisiphon incrustans*, 324
- Chamot, E. M., Chemical Microscopy, 402
- Chapman, A. C., Colouring-matter of Red Torulæ, 227
- Chapman, W. B., Development of Blood-vessels without Heart, 293
- Characæ, Nuclear Division in, 75
- Charpy, G., and S. Bonnerot, Heterogeneity of Steels, 102
- Charronia, 300
- Charybdeu rastonii*, 200, 388
- Reactions of, 388
- Chaudhuria, Caudal Fin of, 368
- Chermes, Biology of, 378
- Cycle of Generations in, 378
- Cheyletus burmiticus* sp. n., 45
- Chick Embryo, Heart-muscle of, 366
- Chicken, Corpus luteum in Ovary of, 293
- Interstitial Cells in Reproductive Organs of, 180
- Chicks, Effects of Pituitary Body and Corpus Luteum on, 181
- Chien, S. S., Spirogyra, 74
- Chilton, Charles, Australian Isopods, 381
- Crustaceans from Interior of Australia, 381
- Fossil Species of Phreatoicus, 381
- New Zealand Sandhoppers, 58
- Chirodiscoides cavie*, 57
- Chlorogonium elongatum*, Nuclear Division in, 324
- Choanephora cucurbitarum*, 225
- Chondriome, Nature and Significance of the, 316
- Chondriomes, Nature and Function of, 204
- Chondrolactis coccinea* sp. n., 387
- Chopard, L., Abdominal Extremity in Orthoptera, 52
- Choristella, 190
- Chromatophores, Black, 367
- Chromodoris zebra*, 188
- Chrysarachnion insidians* g. et sp. n., 322
- Chrysemys, 38
- Chrysoerinus hydra* g. et sp. n., 322
- *vorax* g. et sp. n., 322
- Chrysomad, Plasmodial, Rhizopodial Nets as Capturing-apparatus in a, 322
- Chrysomonads, Rhizopodial, 322
- Chrysopetalida, 383
- Chytridium alarium*, 77
- Cicindela lepida*, 376
- Cicindelidæ, 194
- Citellus franklini*, 180
- *tridecemlineatus*, 180
- Citrus Canker, 222
- — Fungus Isolated from, 222
- "Spot" Disease caused by *Barillus citromaculans*, 227
- Cladorehis, Structure and Development of, 309
- Cladosporium, 329
- Clark, Austin H., Unstalked Crinoids of Siboga Expedition, 386
- Clark, E. R., and E. L. Clark, Phagocytosis in Tadpole's Tail, 368
- Clark, Eliot R., Growth of Blood-vessels in Frog Larvæ, 291
- Clark, Miss, Marine Algæ, 77
- Clark, N. J., Microscope Illumination, 228
- Claviceps Paspali*, Life-history and Poisoning Properties of, 217
- Cleave, H. J. van, Acanthocephala of North American Birds, 308
- Cleland, J. Barton, 82
- Clematis, Stem-rot and Leaf-spot Disease of, 85
- Clepsidrina ovata*, 378
- Clibborn, Lieut.-Col., Exhibit of Tank, 418
- Clovers, Stem-disease in, 86
- Clupea ilisha*, 187
- Cobb, N. A., Filter-bed Nematodes, 307

- Cochlodinium, 323
 Cockayne, E. A., Scales of Leadon Males of *Agricides thetis*, 191
 Cockerell, T. D. A., Auditory Ossicles of Aplodontia, 42
 — Arthropods in Burmese Amber, 45, 46
 Cockroach, Digestion in, 304
 Cole, L. J., and L. J. Bachhuber, Lead-poisoning of Germ-cells, 360
 Coleoptera, Maritime, 303
 Collembola of Abor Expedition, 304
Colletotrichum Brassicæ, 225
 — *Higginscanum* sp. n., 225
 Colley, R. H., *Cronartium ribicola*, 219
 Collinge, Walter E., New Isopod from British Guiana, 381
 — Oral Appendages of Isopoda, 381
 Collins, F. S., and A. B. Hervey, Algæ of Bermuda, 76
Comastrocyrinus, 386
Comatricha dictyospora (Cel.), 393
 — *elegans*, 393
 Comatulids, New, 386
 Comparison Screen for Brass, 234
 Compsometra, 386
 Comstock, G. F., Method for Distinguishing Sulphides from Oxides in Steel, 103
Conchophthirus curtes Englemann, 390
 — *elongatus* sp. n., 390
 — *umellidens* sp. n., 390
 Congdon, E. D., Heart-muscle of Embryo Chick, 366
 Conidial Development, 221
 Coniothecium, 81
 — *chomatosporum*, 81
Coniothyrium tirolense, 81
 Conklin, E. G., Centrifuged Eggs of Crepidula, 188
 Conrady, Prof. A. E., Theory of Dark Ground Illumination, 237
 Conulus, Buccal Armature of, 59
Conus arteriosus, Disappearance of, in Teleosts, 370
 Cooke, C. J. Bowen, Testing Hardness of Metals by the Boyelle-Morin Apparatus, 403
 Coons, G. H., Factors involved in the Growth of Pyrenidia, 80
 Coons, G. W., 219
 Copeland, Manton, Smell and Taste in Marine Snails, 301
 Copepod, New Parasitic, 306
 Copepods, Fresh-water, 416
 Coppinia of *Grammaria abietina*, 60
 Coral Reef, West Indies, Sub-faunas in, 200
 Coralliniceæ, 78
 Corals, Astræid, Reactions of, 388
 — Ectodermic Cilia of, 200
 — Nematocysts of, 200
 — Food of, 200
 — Living, 200
 Corals, Mesenteric Filaments of, 200
 — Mucus Secretion of, 200
 — Tentacular Action of, 200
Cordulogaster annulatus, 372
Coregonus albus, 366
 Corner, George W., Maturation of Ovum in Swine, 178
 Corpus luteum, 35
 Corpuscles, Red Blood, Development of, 361
Corticolous ramalinae, Attachment Organs of, 88
 Corymorpha, Activities of, 311
 Cotton, A. D., Apple Canker due to *Nectria ditissima*, 226
 — and others, Description and Treatment of Plant Diseases, 329
 Cotton Leaf-spot due to an *Alternaria*, 226
Cottus bubalis, Anomalous Pelvic Fins in, 299
 Council, Election of, 111
 Counting Chamber, New, 233
 Cow, Superfetation in, 364
 Crab, Sand, Reactions of, 380
 Crabs, Siboga, 382
 Crab's Claw, Sensory Structures of, 380
 Cranberry, "End-rot" Disease of, 226
 Crane-fly, Leaf-eating, 376
 Crepidostomum, g. n., 385
 Crepidula, Centrifuged Eggs of, 188
 Crataceous Flora of Russian Sakhalin, 392
 Crinoids, Unstalked, of Siboga Expedition, 386
 Crocodilians, Fatty Tissue of, 183
 Cromwell, R. O., 88
Cronartium ribicola, Telentospores of, Developing in Ribes, 219
 Cropper, J. W., New Counting Chamber, 233
 Crozier, Blanche B., Buds of Donatia, 201
 Crozier, W. J., Crustaceans from Interior of Australia, 381
 — Immunity Coloration in Nudibranchs, 188
 — Multiplication by Fission in Holothurians, 59
 — Photic Sensibility of Balanoglossids, 301
Cryphalites rugosissimus g. et sp. n., 46
 Cryptobranchus, Germinal Vesicle in, 359
Cryptomyces Pteridis, Development of, 326
 Cryptorchism, 364
Cubaris chytonensis sp. n., 381
 Cuff, John, 412
Culex pipiens, 49
 Cullen, Anna M., Rectal Tracheation of Dragon-fly Larva, 376
 Culpeper and Scarlet, 412
 Culpeper's Compound Microscope, 412
 Culpeper, C. W., and others, Black-rot Fungus on the Apple, 221
 Cultures, Behaviour of Explanated Striped Muscle in, 40

Currie, J. N., 218
 Curtis, G. M., Seminiferous Tubules of Mammals, 360
 Cushman, J., The Foraminifera of the Atlantic Ocean. Part I. Astrohizidæ, 405
 Cuthbert's Reflecting Microscope, 413
 Cutler, D. Ward, Rings in Scales of Plaice and Flounders, 300
 — and R. Williamson, Rapid Differentiation of Amœbæ Cysts, 96
Cyrcs Runphii, Effect of Foreign Pollination on, 317
Cylindrocladium scoparium, 85
Cylindrotoma splendens Doane, 376
Cymbactis gossei sp. n., 387
Cynocephalus porcurius, 199
Cyphoderopsis kempi g. et sp. n., 304
Cypridina hilgendorfi, Maxillary Gland of, 198
Cyrnea seuratii, 198
 Cytharia, 82
Cytospora leucostoma, 87

D

Dædalea, 328
 Dancharoff, Vera, Differentiation of Cells in the Developing Organism, 39
 — Development of Red Blood Corpuscles, 361
 — Grafts of Spleen on Allantois, 364
 Danææa, 66
 Dangeard, P. A., Nature and Function of Chondriomes, 204
 Dark Ground Illumination, Theory of, 237
 Davidson, P., 103
 Davie, R. C., Comparative List of Fern Pinna-traces, with some Notes on the Leaf-trace in the Ferns, 318
 Dearness, John, New Fungi, 82
 Decametra, 386
 Decapheilia g. n., 387
 Deciduous Trees, Changes by Pressure in Wood of, 64
 Dehorne, Yvonne, Skeleton of Stromatoporphoids, 60
 Delphy, Jean, Anomalous Pelvic Fins in *Cottus bubalis*, 299
 Dematium, 329
 Democrius, 386
Demodex erinacei, 57
 — *muscardini*, 57
 Dendy, Arthur, Chesman Spicule of *Latrunculia*, 60
 Dennstedtia, 209
 Derbidae, Philippine, 51
Dermacentor venustus, 379
Dermestes larvalis sp. n., 45
 Desmid Flora of Dartmoor, 215
Deto marina, 381
 Detwiler, S. R., Development of Shoulder-girdle and Fore-limb in *Amblystoma punctatum*, 295
 Dewey, Kæthe W., Lining of Perivascular Spaces, 366
Devia rustica, 372
 Diatoms, Changing, of Devil's Lake, North Dakota, 215
 — Colour Effects exhibited by, 332
 — from Hanover and the Harz, 215
 — Marine, from the Coasts of Iceland, 324
 — Polarization of, 332
Dibothriocephalus parvus Stephens, 198
Dichotomosphon tuberosus, Life-habits of, 74
 Dictyoxiphium, 208
 Dicyemids, Life-history of, 309
Didelphys aurita, 359
 — *marsupiales*, 178
 — *virginiana*, 178
Didymium nasutum, Conjugation and Eneystation in, 62
 Diels, L., Ecology of *Asplenium Seelosi*, 211
Diemictylus viridescens, Regeneration after Exarticulation in, 295
Dientamœba fragilis g. et sp. n., 313
 Dietrich's Co-ordination Mechanism Theory, 42
 Difflugia, 37
 Diffraction Gratings, Dividing Engine for Ruling, 229
 Dinamœba, Dinoflagella-like Swarmers in, 322
 — *carianus*, 322
Dineutus nigrrior, Germ-cell Cycle of, 194
 Dinophyceæ, 322
Diplocarpon Rosæ (blackspot), causing Diseases of Roses, 224
Diplogaster ærivoræ Cobb, 383
 Discomycetes, Remarkable, 220
 Diseases, Plant, 84
Dissotrema papillatum g. et sp. n., 385
Distoma luteum sp. n., 308
Distomum hepaticum, 309
 Dobell, Clifford, *Entamœba histolytica* and New Genus of Heliozoa, 201
 — and Margaret W. Jepps, Races of *Entamœba histolytica*, 313
Dorostaurus maroccanus, 380
 Dog, Post-œstrous Changes in, 36
 — Spermatogenesis of, 360
 — Structure of Retractor Penis-muscle of, 183
 Dogfish, Development of Head-segments of, 291
 — Embryo, Earliest Movements of, 291
 — Hermaphrodite, 181
 Doidge, Ethel, *Bacillus citromaculans*, 227
 — South African Perisporiales, 326
 Dollond, 412

- Donaldson, Henry N., Mycelin and Advancing Age, 185
- Donatia, Buds of, 201
- Donatia, Lady Flower, Microscope, 244
- Dr. Urban Pritchard, Diatom Slides, 410
- Mr. J. Rheinberg, Photographic Scales and Micrometer Rulings, 410
- Dorogonus, 195
- Dorendorf, Botulism, 393
- Dotilla clepsydra* sp. n., 196
- Douglas Fir, Needle-blight of, 225
- Douin, Ch. et R., *Reboulia Raddi*, 319
- Douin, R., Water-conduction in Marchantiaceæ, 71
- Dragon-flies, 55
- Copulatory Apparatus of, 56
- Development of Wings, 55
- Facets in the Compound Eye of, 55
- Larval, Respiration in, 377
- Metamorphosis of, 56
- Mushroom Bodies of Brain of, 55
- Pronymph of, 56
- Tracheal Gills in Larvæ of, 56
- Vision of, 55
- Zygopterid, Caudal Gills of Larvæ of, 504
- Dragon-fly, Larva, Tracheæ in, 377
- — Rectal Tracheæ of, 377
- — Tracheation of, 376
- Drosophila, 37, 194
- *ampelophila* Leow., 375
- Bristle Inheritance in, 53
- *busckii*, 192
- Inheritance of Extra Bristles in, 375
- *melanogaster* Merg., 375
- Reactions of, to Light and Gravity, 303
- Temperature and Crossing-over in, 303
- Dryopteridæ—a New Tribe of Polypodiaceæ, 67
- Duboscq, O., 63
- Duesberg, G., Chondrisomes in Testis-cells of *Fundulus*, 294
- Duncan, Martin, Photomicrographs of Bacteria, 105
- Duplicities, Morphogenesis of, 291
- Dustin, A. P., Epithelial Reversions in Human Thymus, 41
- Dysentery on the Somme, 92
- Dytiscus, 194
- *marginalis*, 193
- E
- Earland, A., and E. J. Sheppard, Report of Slides Cabinet Committee, 420
- Earwigs, 378
- Echinocardium cordatum*, 369
- *Amphiuva filiformis*, 369
- Echinoceus, 187
- Echinoderma, Phagocytosis of, 200
- Echinoderms, Cephalodiscus-like Ancestor of, 386
- Echinoids, Larval, Experiments with, 386
- Echinorachinus parma*, 179
- Echiastoma ilocanum* in Patients of Manila Hospital, 199
- Ecklonia, Iodine in, 325
- Edgerton, C. W., Tomato-wilt, due to a Fusarium, 224
- Edison, H. A., New Phycomycete, 79
- Damping-off of Seedlings of Sugar-beet, 86
- *Phoma Betæ*, 87
- Edwards, J. Graham, 313
- Eels, Young, Staining, 99
- Eggleston, H. R., Photomicrographs in Colour, 229
- Egg-rafts of *Culex pipiens*, 49
- Eggs, Effect of Vital Stains on, 178
- Elders, C., Intestinal Flora of Sprue, 91
- Eldridge, A. A., 231
- Electrobisium acutum* g. et sp. n., 46
- Electrofævus gracilipes* g. et sp. n., 46
- Ellis, Davis, Phycomycetous Fungi from English Coal Measures, 392
- Ellis, Max M., Branchiobdellids from Michigan Crawfishes, 307
- Ellis, O. W., Comparison Screen for Brass, 234
- Elmore, C. J., Charging Diatoms of Devil's Lake, North Dakota, 215
- Embryo (Amphibian) Removal of Pronephorus of, 181
- Germ-cells in, 39
- Hæmopoiesis in Mongoose, 31
- Embryos, Vertebrate, 34
- Enallagma, 377
- Endoeladia, 77
- Eudomixis, Rhythms in, 202
- Influence of Environment on, 202
- Endophyllum Spores, 218
- *Euphorbia-silaticæ*, 218
- Endrosia fenestrella*, 315
- Enertheuma papillatum* (Perz.), var. *carneo-griseum*, var. nov., 393
- Entameba dysentericæ, 202
- *histolytica*, Races of, 313
- — diameter of, 313
- — and *Entameba ranarum*, 313
- Entomophthora americana*, 79
- Enzymes, Theory that sex-factors are, 53
- Ephydatia flavitilis*, var. *intha*, var. nov., 389
- Epicymatin aphthosæ* sp. n., 220
- Epizootic Lymphangitis, Cultivating the Parasite of, 232
- Equisetum debile*, 66
- Erdmann, Rhoda, Chicken Bone-marrow in Plasma Medium, 41
- Ericaceæ, Endotrophic Mycorrhiza of, 88
- Eriksson, J., Development of Phyto-phthora, 325

- Erythrocytes, Degeneration of, 11
 Erythropoiesis, 361
Escheria packardii, 381
 Etching with Chromic Acid and Hydrogen Peroxide, 234
 Eto, P., 325
Etiopius maculatus, 365
Euchlanis dilatata, 310
Eudemis naxana, 191
Euglena viridis, Nuclear Division in, 323
Euryzonus g. n., 379
Euterpina acutifrons, 370
Euthemisto compressa Göts, 382
 Entrombidium, 380
 Evans, Alexander W., New *Lejeunea* from the West Indies, 320
 Evans, A. W., North American Hepaticæ, 212
 Evolution of British Microscope, 411
 Exhibit at King's College, 411
Exogone hebes, 306
 Expeditions, Swedish, to Australia, 59
- F
- Farquharson, C. O., 83
 Farwell, O. A., American Fern Notes, 68
 — Notes on Hippobæete, 68
 Fanchère, Silkworms in Madagascar, 47
 Faulwetter, R. C., Cotton Leaf-spot due to an *Alternaria*, 226
 Fauna of Coastal Waters, 369
 Faust, E. C., Resin Secretion in *Balsamorhiza*, 206
 — Mussel-mite, 379
 — American Stephanophialinæ, 385
 Favia, 388
 Fay, Henry, Microscopic Examination of Steel, 236
 Fermentation Organisms, Preservation of, 100
 Fern Pinna-traces, 318
 — Prothallia, 68
 Ferns, American, 68
 — Australian, 67
 — of Formosa, 69
 — Study of Some New Cases of Apogamy in, 318
 Fever, Relapsing, 390
 — Spotted, of the Rocky Mountains, 380
 Feytaud, J., Parthenogenesis in *Otioryhncus sulcatus*, 48
 Fig-trees, Disease of, in North Carolina, caused by *Macrophoma Fici*, 224
Filaria immitis, 384
 — *locustæ*, 378
 Filicales, Evolution of Branching in, 209
 Filix, Generic Sense of, 68
 Fimbriaria, 212
 Financial Statement, 242
 Fish-freezing, 368
 Fisher, Homer G., Structure of Retractor Penis-muscle of Dog, 183
 Fishes, Cartilaginous, Optic Nerves of, 41
 — Fresh-water, of Madras, 364
 — Post-larval, Food of, 370
 Fitzpatrick, H. M., Sexuality in *Rhizina undulata*, 326
Flabellivola neapolitana, 306
Flabelligera (Siphonostoma) diplochaitos, 306
 Flagellate, Development of the, 322, 323
 — Descent of Rhizopods from, 323
 — Fusion-plasmodia in, 323
 Flagellate, Diatom-eating, New, 390
 Floridæ, Alternation of Generation in, 75
 Flotowianus, 212
 Flower, Lady, Donation, 241
 Food Production Office, Smuts of Cereals, 327
 Foraminifera of the Atlantic Ocean. Part I. Astrohrizidæ, 405
 Foraminiferal and Nullipore Structures in some Tertiary Limestones from New Guinea, 315
Forcipia fragilis, 61
Forficula auricularia, 378
 — *tomis*, 378
 Formol-violet, Staining Spirilla with, 403
 Formosa, Ferns of, 69
 Foster, A. C., 221
 Foucher, G., Longevity of Males of *Carausius morosis*, 52
 Fouchet, A., Detection of Bile-pigments in Blood-serum, 101
 Fowls, Age and Fertility in, 363
 Fowl (Domestic), Sex-ratio in, 182, 363
 Fowls, Effect on Progeny of, after Treatment with Alcohol, 37
 — Hermaphrodite, 292
 — Influence of Age on Reproductivity of, 363
 — Melanin in Feather-germs of, 187
 Fragoso, G., Uredinæ, 327
 Fragoso, R. G., New or Rare Fungi, 329
 França, Carlos, Classification of Hæmosporida, 203
 Free-Martin, 37
 French, J. W., Balsam Problem, 230
 Frog Larvæ, Growth of Blood-vessels in, 294
 Frogs, Artificially Activated Eggs of, 290
 Fromme, F. D., and H. E. Thomas, Xylaria Root-rot of Apple-trees, 225
 Frye, T. C., Rhacomitrium in North America, 320
 Fucus, 77
 Fujii, Hajime, 383
Fumago vagans, 329
 Fundulus, Chondriosomes in Testis-cells of, 294
 — *heteroclitus*, 292

- Fungi, Forest, Altitudinal Range of, 222
 — from Southern China, 220
 — Growth of, in Concentrated Solutions, 222
 — Honey-dew, 328
 — Irish, 83
 — Method for Discovering in Sputum of Bronchitics, 96
 — Natal, 82
 — New, 82
 — — or Rare, 220, 329
 — Nigerian, 83
 — Parasitic, Immunity from, 84
 — Phycomycetous, from English Coal Measures, 392
 — Relation to Host, 221
 — Schweinitz, Collection of, 82]
 — Tuber-rot, 218
 — Ugandi, 83
 — Variations of, due to Environment, 81
 — Wood-rotting, Cultures of, 328
 Fungicides, Use of Various, 224
 Fungus Fairy Rings, 220
 — Pathogenic, 84
 Fusarium, 224
 — in Potato Tubers, 218
 — *oxysporum*, 218
 — *radicicola*, 218, 222
 — *trichothecioides*, 224
 — Tuber-rots Caused by, 84
Fusicoccum putrefaciens sp. n., 226
- G
- Gadidæ, Optic Nerves of, 41
 Galls, History of the, 223
Gammarus chevreuxi, Eye-pigment in, 195
 Ganglia, Rôle of, in Immobilization, 373
 Garbowski, L., *Sclerospora macrospora* on Corn, 226
 Gardiner, J. Stanley, and G. H. F. Nuttall, Fish-freezing, 368
 Gastropods, Locomotion of, 301
 Gatenby, J. Bronté, Cytoplasmic Bodies in Germ-cells of Lepidoptera, 47
 — — — — Inclusions of Germ-cells, 98
 — — — — in Germ-cells of Snail, 189
 Gautier, Cl., Observations on Caterpillars of Cabbage-white Caterpillars, 302
 Geocarainidæ, 382
 Georgevitch, F., Life-cycle of *Myxidium gadi*, 63
 Georgevitch, Jivoïn, Life-history of *Ceratomyxa heronardi*, 62
 — Leptotheca and Glugea, 63
 Germ-cells, Cytoplasmic Inclusions of, 98
 — Lead-poisoning of, 360
 Gessard, C., Variety of *Barilus pyocyanus*, 90
- Ghose, S. L., Cone of *Selaginella pallidissima*, 210
 Giant-cells, Hemogenic, 367
 — Osteolytic, 367
 Gibbons, William S., Death of, 176
 Gibson, R. B., 298
 Gilbert, A. H., and C. W. Bennet, *Sclerotinia Trifoliorum*, 86
 Gilchrist, J. D. F., Eggs and Embryos of *Bdellostoma*, 291
 — Life-history of *Distoma luteum* sp. n., 308
 Ginseng, Root-rot of, 87
 Glass Manufacture, British Resources of Sands and Rocks used in, 231
 Glover, W. O., Disease of Clematis, 86
Glugea marionis, 63
 Gnat, Fertilization in, 49
Gobius (Glossogobius) giuris, 365
 — (*Oxyurichthys striatus*), 365
 Godfrey, G. H., *Sclerotium Rolfsii*, a Disease of Wheat, 226
 Godspeed, T. H., Modified Safety-razor Blade-holder for Temperature Control, 395
 Goldfish, Telescope-eye of, 368
 Goldschmidt, Richard, Intersexual Forms of Gypsy-Moth, 52
 Gonads, Internal Secretion of, 32
Gouyrosira Scourfieldii, 30
Goniolithon Martellii, 216
 Gonococcal Infections, Diagnosis of, 418
Gonyaulax polyedra, 390
 Goodrich, Edwin S., "Proboscis Pores" in Cranate Vertebrates, 186
 — Development of Head-segments of Dogfish, 291
 Gosh, Ekendranath, Studies on Infusoria, 390
 Goto, S., and Y. Matsudaira, New Amphistomid Trematode from a Fish, 385
Gracilaria corticata, 78
 — *lingua*, 78
 Graft-hybrids, 318
 Grallomyces, 326
Grammaria abietina, Coppinia of, 60
Grantia compressa, Larvæ of, 388
 Grapsidæ, 382
 Gravatt, G. Filippo, and others, Uredinææ, 327
 Gravier, Ch. J., New Parasitic Copepod, 306
 Grayson, J. H., Dividing Engine for Ruling Diffractive Gratings, 229
 Gregarine, New Cephaline, 315
 Gregory and Wright, 413
 Grison, 300
Gronospira Rzchak, 406
 Grove, W. B., *Pleodorina illinoiensis*, 73
 — *Rhizophidium acroforme*, 73
 — *Septoria Cheropodii*, 80
 Growth-period and Duration of Life, 194
Grubea limbata, 306

- Guérin, P., Development of Pollen in *Salvia*, 206
- Guignard, L., Ovule in Apocynaceæ and Asclepiadaceæ, 65
- Guild, J., Spherometer of Precision, 95
- Guilliermond, A., Mitochondrias of Plant-cells, 204
- Nature and Significance of the Chondriome, 316
- Guinea-pig, Spermatogenesis of, 361
- Gymnoconia interstitialis*, 219
- Gymnodinium, 323
- Gymnosporangium blasdaleanum*, 327
- Gyrocera, 329
- Gypsy-Moth, Intersexual Forms of, 52
- H
- Hæmosporidia, Classification of, 203
- "Hæmothallasia," 390
- Hagedoorn, A. G., and A. L., Rats and Evolution, 185
- Hagnenau, J., 92
- Hahn, G. G., and others, Nursery Blight of Cedars, 225
- Halacaridæ, Swiss, 195
- Hall, Kate Marion, Death of, 244, 358
- Hallimond, A. F., Telescopic Focussing Apparatus for Photomicrography, 400
- Hallmann, E. F., Desmacidonid Sponges, 201
- Halnan, E. T., 36
- Halstead, 87
- Hammond, J., Mammary Glands of Rabbit, 35
- Haplochiüs melanostigma*, 365
- Haploops, 369
- Harman, Mary T., Superfetation in Cow, 364
- Harpanthus, 212
- Harper, E. T., and others, Hymenomyces, 328
- Remarkable Discomycetes, 220
- Harris, G. T., Desmid Flora of Dartmoor, 215
- *Schistostegia osmundacea*, 322
- — — *Mohr*, 321
- Harrison, Colonel, M.D., Spirochaetes, 239
- Harrison, Ross G., Development of Forelimb of *Amblystoma punctatum*, 295
- Harrison, W., Investigations on Textile Fibres, 404
- Harshberger, John W., A Text-book of Mycology and Plant Pathology, 330
- Harter, L. L., 88
- Hartley, C., 226
- Hartman, C. G., Superfetation in Cat, 178
- Hartmann, M., Nuclear Division in *Chlorogonium elongatum*, 324
- Hartridge, H., An Improved Method of Apertometry, 337
- Harwood, H. F., 231
- Hatai, Shinkishi, Growth of Parts of Rats and of the Whole, 366
- Hawkes, Onera A. Merritt, Inheritance in Silkworms, 191
- Hawkins, Herbert L., Buccal Armature of *Conulus*, 59
- Hawkins, L. A., *Fusarium* in Potato-tubers, 218
- Growth of Fungi in Concentrated Solutions, 222
- Hayata, B., Ferns of Formosa, 69
- Hays, Frank A., Sexual Activity of Male Rabbit in Relation to Progeny, 297
- Heape, 36
- Heat-treatment of Grey Cast Iron, 235
- Hebb, Dr. R. G., Death of, 173, 244
- Mrs., Donation of Microscope, 333
- Hecht, Selig, Sensory Reactions of *Ascidia atra*, 301
- Vascular System of Ascidian, 371
- Hegner, R. W., and C. P. Russell, Germ-cell Cycle of *Dinenteles nigrior*, 194
- Heitz-Boyer, and Scheikevitch, Osseous Regeneration in the Adult, 41
- Heliozoa, New Genus of, 201
- Helminthological Notes from Switzerland, 199
- Hemiphlebida mirabilis*, 55
- Hemiporcellio strzelecki* sp. n., 381
- Hemogenic Giant-cells, 367
- Hepaticæ, European, 211
- North American, 212
- South African, 212
- Hereditary Characters and Evolution, 37
- Herlant, Maurice, Cyclic Variations in Permeability of the Activated Ovum, 293
- Hermaphroditism, False, 364
- Heron-Allen, E., The Royal Microscopical Society during the Great War—and After: Presidential Address, 1917-18, 153
- and A. Earland, Diatom Ooze from Deep Antarctic Waters, 335
- Herpotrichia nigra*, 86
- *quinqseptata* sp. n., 86
- Herre, A. C., Lichens of Whatcom County, Washington, 89
- Herriott, E. M., Habits of *Lepidurus viridus*, 58
- Hervey, A. B., 76
- Herzog, T., Multicellular Spores in Mosses, 71
- Hess, Walter N., Seasonal Changes in Kidney of Stickleback, 299
- Heterodinium in the Adriatic, 214
- Higgins, B. B., Leaf-spot on Turnip, 225
- Hilario, J. S., and L. D. Wharton, *Echinostoma ilocanum* (Garrison), 199

- Hill, G. F., Binomics of the Buffalo-fly (*Lyperosia exigua* de Meijere), 192
- Hill, J. Ben, Staining of Minute Algæ, 73
- Hill, J. P., Early Development of Opossum, 359
- Hill, Sir John, 68
- Hilsa, 187
- Cestodes of, 384
- *ilisha*, 187, 384
- Hippochæte, Notes on, 68
- Hippospongia equina*, 201
- Hirst, Stanley, New Parasitic Acari, 57
- Hirudinea, Hermaphroditism in, 44
- Histological Material, Short Method of Preparing, 232
- Hoag, L. A., Minute Structure of Sensory Root of Trigeminal Nerve, 299
- Hodgetts, W. J., Discharge of Spores of *Leptosphaeria acuta*, 79
- Hollande, A. C., Modification of Bouin's Fluid, 232
- Holognathidæ, 382
- Holopteryx indica* sp. n., 391
- Holothuria surinamensis*, 59
- Holothurians, Multiplication by Fission in, 59
- Hormosoma g. n., 312
- Hormidium flaccidum*, Structure and Mode of Life of, 72
- Hornvold, A. Gandolfi, Staining Young Eels, 99
- Horse-sponge, Larva of, 201
- Horst, R., Monograph on Polychæts, 383
- Howe, Marshall A., Marine Algæ of Cuba, 325
- Howell, J. A., Effect of Stress and Strain on Bone Development, 179
- Howland, Ruth B., Removal of Pronephros of Amphibian Embryo, 181
- Howlett, F. M., Notes on Lice, 51
- Huber, G. Carl, Development of Mammalian Notochord, 292
- Hubert, E. E., 219
- Hubert, H., Stereoscope for Examining Superposed Projections, 94
- Huic, L. H., Study of Holly Tertrix Moth, 191
- Hunting, F. F., 235
- Hurd, Miss, Nereocystis, 77
- Hurst, C. P., Wiltshire Mosses, 70
- Hurst, J. E., Heat-treatment of Grey Cast Iron, 235
- Hyalestera aspidotus*, Inoculation of, on Pheopteris, 219
- *Polyptodii*, Inoculation Experiment with Spores of, 219
- Hydracarid, Rare, 57
- Hydracarina of Epping Forest, 306
- Hydroids, Australian, New, 387
- Hyctodesia erratica*, 79
- Hygromia, 188
- Hydra pickeringii*, 368
- Hylaster ater*, 194
- *cunicularius*, 194
- *palliatius*, 194
- Hylastes, Structure and Life-history of, 194
- Hyman, Libbie H., Metabolic Gradients in Amoeba and their Relation to Amoeboid Movement, 312
- Hymenolepis nana* Siebold and *H. murina* Dujardin, 384
- Hymenomyces, 328
- Hymenoptera, Paralyzing Habits of, 46
- Hymenozomidæ, 382
- Hyperammina vagans* Brady, 406
- Hyperderma bovis*, 303
- *deformans*, a New Fungus causing Disease of Needles of Western Yellow Pine, 223
- *lineatum*, 303
- Maggot, Spiracles of, 303
- Hypolepis, 209

I

- Idiocetosome, 361
- Idioendosome, 361
- Idiosome in Spermatogenesis of Guinea-pig, 361
- Idoteidæ, 382
- Idoteina, 382
- Ilisha parthenogenetica*, 384
- Illumination, Dark-ground, 418
- Principles of, 397
- Infusoria, Studies on, 390
- Ingham, W., Moss Exchange Club, 320
- Insects and Disease, 302
- Circulation of Blood in, 193
- Ectoparasitic, 52
- Nuclear Division in the Adipose Cells of, 189
- Recognition among, 46
- Iridocytes, 367
- Iron, Microstructure of Commercially Pure, 235
- Ischnura, 377
- Isophyllia, 388
- Isopod, New, from British Guiana, 281
- Isopoda, Oral Appendages of, 381
- Isopods, Australian, 381
- from British Guiana, 58
- Terrestrial, Dipterous Parasite in, 192
- Isthmospora, 326

J

- Jaccard, P., Wool of Deciduous Trees, 64
- Jackson, H. S., Ræstelia, 81

Jackson's Microscope, 415
 Jagger, C., and V. B. Stewart, Verticillium, 224
 Jamieson, Janet P., Rectal Tracheæ of Dragon-fly Larva, 377
 Jeffries, Z., Tungsten-Molybdenum Alloys, 102
 — Effect of Great Hydrostatic Pressure on Metals, 234
 Jennings, H. S., Hereditary Characters and Evolution, 37
Jenningsia diatomophaga, g. et sp. n., 390
 Jepps, Margaret W., and Clifford Döbell, New Amœba from Man, 313
 Johnson, C. E., Development of Liver in Ground Squirrel, 180
 Johnson, Franklin P., Lobules of Pig's Liver, 298
 Johnston, S. J., Trematodes of Australian Birds, 199
 Joicey, J. J., and G. Talbot, Gynandromorph of *Papilio lycophron*, 191
 Jolewalaie, J. R., *Phyllachora Roystoneæ* — a Disease of Royal Palm, 226
 Jones, 1798, 413
 Jones, D. A., Welsh Bryophyta, 70
 Jordan, H. E., Aortic Cell-clusters in Vertebrate Embryos, 34
 — Cardiac and Skeletal Muscle of Scorpion, 57
 — Case of False Hermaphroditism, 364
 — Germ-cells of Loggerhead Turtle, 38
 — Giant-cells of Yolk-sac and Bone-marrow, 367
 — Hæmopoiesis in Mongoose Embryo, 34
 — Histology of Lymph, 367
 — Intercalated Discs in Heart-muscle of Ox, 41
 — Leg-muscle of Sea-Spider, 57
 Jørgensen, O. M., British Occurrence of *Nematoscelis megalops*, 382
 — Development of Shore-crab, 382
 — Larvæ of *Grantia compressa*, 388

K

Kaburaki, Tokio, Triclad from Inlé Lake, 386
 Karrer, Miss, Nereocystis, 77
 Karsten, 82
 Kashyap, S. R., *Equisetum debile*, 66
 — *Targionia hypophylla*, 69
 — Indian Liverworts, 212
 — *Kawamuraia japonica*, 383
 Keeley, F. J., Polarization and Colour Effects exhibited by certain Diatoms, 332
 Keilin, D., New Cephaline Gregarine, 315
 Kemkel, L. O., *Spongospora subterranea*, 90

Kepner, W. A., and J. Graham Edwards, Reactions of *Pelomyxa* to Food, 313
Kerria japonica, Leaf-disease of, 85
 Keys, James H., Maritime Coleoptera, 303
 Kibbe, Miss, *Chytridium alarium*, 77
 Killian, Karl, Development of *Cryptomyces Pteridis*, 326
 King's College Bacteriological Laboratories, 419
 Kinship, Degrees of, 44
 Kittelson, John A., Growth of Kidney of Albino Rat, 186
 Klebs, G., Fern Prothallia, 68
 Klocker, A., Preservation of Fermentation Organisms in Nutrient Media, 100
 Kodak, Limited, Wratten "W" Filters, 398
 Koenike, 379
 Kölliker, Osteoclasts of, 367
 Kopaczewski, W., Poison of *Muræna*, 43
 — Serum of *Muræna*, 43
 — Toxicity of Serum of *Muræna*, 43
 Krysltofvich, A., Cretaceous Flora of Russian Sakhalin, 392
 Kupffer, Cells of the Liver, 366

L

Labrax lupus, Optic Nerves of, 41
Laevina wickhami Schlumberger, 315
 Ladd's Microscope, 415
 La Marca, F., Graft-hybrids, 318
 Lameere, Aug., Life-history of Dicyemids, 309
 Laminaria, 77
 Lamp, Low-voltage Electric, 228
 Lamprey, Thymus-like Structures in Larval, 40
 — Lymphocyte Accumulations of, 40
 — Placodes of, 40
Lamproderma crucheti sp. n., 393
 — *violaceum*, 393
 — *santeri* (Rost), 393
Lasiocampa quercus, 375
 Latrunculia, Chessman Spicule of, 60
 — *bocagei*, 60
 — *apicalis*, 60
 Lead Acetate, Ingestion of, 360
Lebertia seferi Walter, 336
 Lebour, Marie V., Trematode Larva from *Buccinum undatum*, 308
 — Microplankton of Plymouth Sound, 323
 — Peridinales of Plymouth Sound, 323
 — Food of Post-larval Fishes, 370
 Lécaillon, A., Variations in Silkworms, 48
 — Parthenogenesis in Silk-moths, 48
Lerithochirium dillanei sp. n., 308
 Legendre, J., Study of Malagasy Perch, 299

- Léger, L., and O. Duboscq, New Species of *Pseudoklossia*, 63
- Leger, M., and E. Parry, Trypanosomes in Monkeys, 314
- Le Goc, M. J., Effect of Foreign Pollination on *Cycas Rumphii*, 317
- Lehman, S. G., *Sphæronema fimbriatum*, 327
- Leidyana tinei* sp. n., 315
- Lejeunea, New, from Bermuda and the West Indies, 320
- Lek, Van der, *Rhizoctonia violaceæ*, 85
- Leuus Lozodes*, 202
- Lepidoptera, Cytoplasmic Bodies in Germ-cells of, 47
- Dimorphic Colouring in, 374
- Protective Coloration in, 191
- Wing-venation of, 302
- Lepidodendron aculeatum*, 392
- *fuliginosus*, 392
- Lepidurus viridis*, Habits of, 58
- Leptotulus belgicus*, 373
- Leptosphaeria acuta*, Discharge of Spores of, 79
- Leptospora of Noguchi, the Newly-created Genus, 228
- Leptoteichus g. n., 312
- Leptotheca and Glugea, 63
- *elongata*, 63
- Leptus akamushi*, 379
- Leptyphontes nebulosus* Sund, 195
- Lestes viridis*, 372
- Leucocytes, Large Mononuclear, of the Peripheral Blood and the Macrophages at the Site of Injury amongst the Wounded, 370
- Levinseuella howensis* sp. n., 199
- Lewis, Margaret L., 183
- Lewis, Margaret R., 40
- Effect of Vital Stains on Eggs, 178
- Lewis, Warren H., and Margaret R. Lewis, Behaviour of Explanted Striped Muscle in Cultures, 40
- — Time occupied in Mitosis, 183
- Leygue, G., and J. Hagnenau, Dysentery on the Somme, 92
- Lice, Human, Bibliography of, 49
- and Disease, 49
- Biology of, 50
- Methods of Raising Experimentally, 50
- Notes on, 51
- on Typhus patient, 50
- Rate of Locomotion of, 50
- Variation in Proportion of Sexes, 50
- Lichen Vegetation, Foothills, of the Rocky Mountains, 89
- Ecology, 89
- Lichens, 89
- Microscopic Structure of, 426
- Lichtenstein, Jean L., New Mode of Multiplication in Amœbidium, 63
- Light, Electro-magnetic Theory of, 409
- Necessary for Germination, 68
- Light, Polarization of, 397
- Scattering of, by Dust-free Air, 395
- Lillie, R. S., 293
- Permeability of Sea-urchin Ova, 310
- Lillie, Frank R., Study of Free-martin, 37
- Lilliella g. n., 312
- Lim, Robert K. S., Respiratory Mechanism of Shore-crab, 381
- Limnæidæ, Hermaphroditism in, 44
- Limnolacarus Walkeri* (Walter), 195
- Lipochromes, 367
- Lipshütz, A., Internal Secretions of Gonads, 32
- Lithothamnion, 216
- *intermedium*, 216
- Liver, Kupffer Cells of, 366
- Liver-rot, 309
- Liverworts, Geographical Distribution of, 212
- Indian, 212
- of Austria, 211
- of Germany, 211
- of Switzerland, 211
- Lizards, Melanophores of, 298
- Lloyd, C. G., Mycological Notes, 82, 329
- Lloyd-Jones, Orren, and F. A. Hays, Sexual Activity of Male Rabbit, 298
- Loeb, Jacques, Heliotropism of Barnacle Larvæ, 197
- Fertilization and Phagocytosis of Echinoderma, 200
- Further Experiments on Sex of Frogs developed from Artificially Activated Eggs, 290
- Lohmannella violacea* (Kramer), 195
- Lonchitis, 208
- Long, W. H., Uredineæ, 81
- Heart-rot of Oaks, 88
- and R. M. Harsch, Cultures of Wood-rotting Fungi, 328
- Lopez-Neyra, C. Rodriguez, New Nematode from Partridge, 198
- Lophozia Bauerlana*, 72
- *Hatcheri*, 72
- Lophius piscatorius*, 179
- Loxophyllum fasciola* (Ehrbg.), 391
- Lund, E. J., Intracellular Respiration in Paramecium, 314
- Reversibility of Morphogenetic Processes in Bursaria, 314
- Respiration in Paramecium, 389
- Lygirdendron Ollkamium*, 392
- Lymantria dispar*, 52, 375
- Lymph, Histology of, 367
- Blood Platelets in, 367
- Lyperosia exigua* de Meijere, 192
- Lippincott, W. A., Blue Andalusians, 300

M

- Macbride, E. W., Experiments with Larval Echinoids, 386

- McCalla, Albert, Death of, 358
 MacCaughy, V., Algae of the Hawaiian Archipelago, 216
 McClintock, J. A., Pea-nut Disease, 224
 MacDowell, Edwin Carleton, Bristle Inheritance in *Drosophila*, 53
 McEwen, R. S., Reactions of *Drosophila* to Light and Gravity, 303
 MacGregor, Malcolm E., Insects and Disease, 302
 McIndoo, N. E., Recognition among Insects, 46
 McKay, M. B., 80, 86, 221
 — *Cercospora beticola*, 226
 MacLeod, J., Statistics of Moss Structure, 69
 Machida, J., Spermatogenesis of an Orthopteron, 377
Machimus pilipes, 372
 Macoma, 369
 Macrophages at the Site of Injury, 370
Macrophoma Fici, 225
Macrophthalmus grandidieri A. Milne-Edwards, 196
Macrothylacea rubi, 375
 Madreporarian Skeleton, Nature of, 387
Mæandra areolata, 200
 Mæandrina, 388
 Magnifying Power, Measurement of, 230
 Main, Hugh, *Entomophthora americana*, 79
 Maire, L., *Tricholoma*, 328
 Maitland, T. D., and E. M. Wakefield, Uganda Fungi, 83
Malacosoma neustria, 375
 Malacostraca of Natal, 196
 Malarial Blood, Rapid Examination of, 99
 — Parasites, Improvised Staining of, 98
 Mallorca Marine Biological Laboratory, 99
 Malone, Julian Y., Spermatogenesis of Dog, 360
 Mammals, Semiferous Tubules of, 360
 Mammary Glands, 34
 — — of Rabbit, 35
 Manaloug, C., Degeneration of Peripheral Nerves, 98
 Mangiu, L., *Chaetoceros criophilus*, 214
 Marchantiaceæ, Water-conduction in, 71
Marmota monax, 184
 Marrattiaceæ, Stellar System of, 66
 Marshall, 35
 Marshall, F. H. A., and E. T. Halnan, Post-œstrous Changes in Dog, 36
 Marshall, John, 411
 Martin, Benjamin, 412
 Mason, T. G., Carbohydrates of Musci, 71
Massaria japonica, 82
 — *moricola*, 82
 Massey, L. M., Crown-canker Disease of Rose, 85
 — Use of Various Fungicides, 224
 Mast, S. O., Conjugation and Encystation in *Didinium nasutum*, 62
 Mathewson, C. H., and P. Davidson, Annealing of Bronze, 103
Mathiola ralesiaca, 85
 Mathis, C., and L. Mercier, *Entamoeba dysentericæ*, 201
 Matsudaira, Y., 385
 Matsueka, Y., Actions of Micro-organisms on Bone-marrow, 91
 Matsui H., Chemical Constituents of "Asakusanori," 324
 Matthai, G., Nature of Madreporarian Skeleton, 387
 — Reactions of Astræid Corals, 388
 Mayer, A. G., Theory of Nerve Conduction, 185
 — Nerve Conduction in Cassiopea, 201
 Mazza, A., Oceanic Algology, 76
 Mead, Harold T., Reactions of Sand Crab, 380
Mecitogaster modestus, 377
 Mecoptera, 190
 Medical Research Committee, Diagnosis of Gonococcal Infections, 418
 Medusæ deprived of Rhopalia, 388
 — Fatigue in, 388
 — Physiology of, 200
 Melampora sp., 220
 Melamporella spp., 219
Melanospora erythræa, 83
 — *Mangini*, 220
 Melhus, I. E., Peronosporaceæ, 79
 — and others, *Spongospora subterranea*, 223
 Melin, E., Archegonium of *Sphagnum squarrosus*, 320
 Meliola, Parasites on, 325
 Mellivora, 300
 Melobesicæ, 78
 Mendel, Lafayette B., 294
 Mercier, L., 202
 Merrill, E. D., 220
 Meringosphæra, 216
 Merwin, H. E., Optical Properties of Carborundum, 230
 — Optical Properties of Colour of Pigments and Paints, 401
 Mesnil, F., and M. Caullery, Dimorphism in a Polychæt, 58
 — — Notes on Syllids, 306
 — — Peculiarly Adapted Annelid, 306
 Metallurgical Microscope, 92
 Metals, Effect of Great Hydrostatic Pressure on, 234
 Metcalf, H. E., Electrifying the Microtome, 232
 Metœstrum, 35
 Metzgeria, 212
 Meylan, C., New Mycetozoa, 393
 — Mycetozoa from the Jura Mountains, 393
 Mice, "Dislocated," 33
 — Effect of Alcohol on, 42
 — Growth of, 294
Microphyla ornata, 367

- Microphylla rubra*, 367
 Microplankton of Plymouth Sound, 323
 Micropteryx, Protocterebrum of, 190
 Microscope, British, Evolution of, 411
 — Illumination, 228
 Microscopical Characters in the Study of the Higher Plants, 317
 Microscopy, Chemical, 402
 Microsporidian, New, in Cabbage White Caterpillars, 314
 Microtome, Electrifying the, 232
 Microtrombidium, 380
Midas midas, 314
 Miller, S. W., Etching with Chromic Acid and Hydrogen Peroxide, 234
 Milner and Part, Methods in Practical Petrology, 408
Mindal pangtensis g. n., 212
 Misra, C. S., Sugar-cane Leaf-hopper, 49
 Mistletoes, Parasitic Fungus of, 86
Misumena vatia Clerck, 47
 Mite, Harvest, New, 380
 Mites as Disease-carriers, 379
 Mites, Mange, 379
 Mitosis, Time Occupied in, 183
 Mjöberg, E., 59
 Mniium, 69
Modiola-epifauna, 369
 Mollusca, British Terrestrial and Fresh-water, 188
 Monachocinus, 386
Monachosorum subdigitatum, 209
 Monaster and Narcotized Ova, Cell-division in, 311
 Mongoose, Hæmopoiesis in Embryo, 34
Moniezia expansa, 187
 — *trigonophora*, 187
Mouillia carbonaria, 83
Monilochætes infuscans g. et sp. n., 88
 Monkeys, Hydatid Cysts in, 199
 — Trypanosomes in, 314
 Moore, Benjamin, Studies of Activity of Light in Inorganic and Organic Systems, 334
 Moreau, F., and Madame, Anomalies in Mucorini, 217
 — Endophyllum Spores, 218
 — *Epicmatia aphthosæ*, 220
 Morgan, T. H., Inheritance in Fantail Pigeons, 181
 Morgans, T. D., and F. Rogers, Uniformity of a Cast of Acid Open-hearth Steel, 235
 Morrill, C. V., Regeneration after Excitulation in *Diemetylus viridescens*, 295
 Mosquito-eggs, Viability of, 376
 Moss Exchange Club, 320
 — Structure, Statistics of, 69
 Mosses, Australian, 67
 — Dextrose, Levulose, and Sucrose, in, 71
 — Multicellular Spores in, 71
 — of North-West Germany, 213
 Mosses, Wiltshire, 70
Motella tricirrata, 63
 Moth, Holly Tortrix, 191
 Mottram, J. C., Protective Coloration in Lepidoptera, 191
 Mould-spores, Effects of Pasteurization on, 221
 Mouse, Spermatogenesis in, 360
 Much's Granules, 403
Mucor Mucedo, Cultures of, 217
 Mucorini, Anomalies in, 217
 Muenscher, W. L. C., Algal Associations of San Juan Island, 77
 Muir, Frederick, Philippine Derbideæ, 51
 Müller, K., European Hepaticæ, 211
Multiceps multiceps, 187
 Munro, James W., Structure and Life-history of Hylastes, 194
 Muræna, Poison of, 43
 — Serum of, 43
 — Toxicity of Serum of, 43
 Murenidæ, Optic Nerves of, 41
 Murphy, P. A., Cytology of the Sexual Organs of *Phytophthora erythroseptica* Pethyb., 217
 Murrill, W. A., Agaricaceæ, 328
Mus norvegicus albinus, 31
 — — Nature of, 186
 — — *rattus*, Nature of, 186
 Musci, Carbohydrates of, 71
 Mussel-mite, 379
Mustela africana, 300
 — *erminea*, 300
 — *furo*, 300
 — *nivalis*, 300
 — (*Putorius*) *putorius*, 300
 Mustelidæ, Baculum or Os penis in some Genera of, 300
 Muta, Elisa, and Gino Pollacci, Variations of Fungi due to Environment, 81
Mycete (Paresperella) atlantica, 61
 Mycetozoa from the Jura Mountains, 393
 — Irish, 90
 — New, 393
 Mycological Notes, 82, 329
 Mycology and Plant Pathology, a Text-book of, 330
 Mycorrhiza, Endotrophic, of Ericaceæ, 88
Mycospharella Ilorii, 82
 Myelin in Advancing Age, 185
Myelophilus minor, 48
 — *piniperda*, 48
 Myers, J. A., Development of Mammary Glands, 34
Myriacida fasciculata, 306
 Mytilus-epifauna, 369
 Myrmarchæne, 195
Myzidium gadi, Life cycle of, 63
 Myxomycetes, Rare, 90
 Myxophycæ of North America, 215

N

- Nakahara, Waro, Nuclear Division in the Adipose Cells of Insects, 189
- Nakayama, S., 324
- Name, Willard G. Van, Philippine Ascidi-ans, 371
- Nannochorista, 190
- Nannochoristidae, 190
- Nanta, A., Large Mononuclear Leucocytes of the Peripheral Blood and the Macrophages at the Site of Injury amongst the Wounded, 370
- Neger, F. W., Honey-dew Fungi, 328
- Nègre, L., 232
- Nematodes, Filter-bed, 307
- Reproduction in, 383
- Sex in, 44
- Toxic Constituent of, 383
- Nematoscelis megalops*, British Occurrence of, 382
- Neopeckia Coulteri*, 86
- Neotrombidium, 380
- Nephrolepis, 209
- *tuberosa*, 209
- *volubilis*, 209
- Nereocystis, 77
- Nephtyigorgia Kükenthali*, sp. n., 59
- Nercis, Effect of Radium on Fertilization Membrane of, 307
- Nerve Conduction, Theory of, 185
- Structure of Optic, 41
- Neuville, H., 183
- Newborough Sands, Geology and Physical Geography of, 70
- Newton, R. Bullen, Foraminiferal and Nullipore Structures in some Tertiary Limestones from New Guinea, 315
- Nice, J. B., Effect of Alcohol on White Mice, 42
- Nicoll, William, Hydatid Cysts in Monkeys, 199
- Nicoll, W., Trematodes of Queensland Reptiles and Frogs, 308
- New Trematode from Australian Poison Snakes, 309
- Nilssonia, 392
- Noctiluca, 390
- Northop, John N., Growth-period and Duration of Life, 194
- Northop, John H., 197
- Notochord, Development of Mammalian, 292
- Nudibranchs, Immunity Coloration in, 188
- Nuttall, G. H. F., 368
- Bibliography of Human Lice, 49
- Biology of Lice, 50
- — of *Phthirus pubis*, 378
- Lice and Disease, 49
- Pathological Effects of *Phthirus pubis*, 364
- Oaks, Heart-rot of, 88
- Obituary—
- Gibbons, William S., 176
- Hall, Kate Marion, 244, 358
- Hebb, Richard G., 177, 244
- McCalla, Albert, 358
- Plimmer, Henry George, 349
- Sargent, Ethel, 175
- Octopus macropus*, 372
- Ocypodidae, 382
- Odemagena tarandi*, 303
- Oehlkers, F., Nuclear Division in Characeae, 75
- Oenothera, 37
- Oestrous Cycle in Guinea-pig, 35
- Oestrum, 35
- Oestrup, E., Marine Diatoms from the Coasts of Iceland, 324
- Okuda, Y., and P. Eto, Iodine in Marine Algae, 325
- and S. Nakayama, the Quality of "Asakusanori," 324
- Oligochaeta, Hermaphroditism in, 44
- of Inle Lake, 383
- Olmsted, J. M. D., Locomotion of Gastro-pods, 304
- Regeneration in *Planaria maculata*, 309
- Physiology of *Synaptula hydroformis*, 311
- Onciscus asellus*, 192
- Onslow, H., Growths in Colloidal Silica Solutions, 404
- Ophioglypha sarsii*, 369
- Ophiotænia, New Species of, 198
- *racemosa*, 198
- Opisthacanthus elatus*, 195
- Opisthobranchs, Hermaphrodite Marine, 44
- Opossum, Early Development of, 359
- Polyembryonic Blastocyst in, 178
- Optical System, Tracing Rays through, 409
- Orbicella annularis*, 200
- Organism, Differentiation of Cells in the Developing, 39
- Orgyia antiqua*, 47
- Ormskirk, Immunity Trials at, 84
- Ornithodoros canestrinii*, 383
- *woubatu*, 380
- *tholozani*, 380
- Orthoptera, Abdominal Extremity in, 52
- Orthopteron, Spermatogenesis of an, 377
- Osmunda, Apogamy in, 67
- *cinnamomea*, 67
- *Claytoniana*, 67
- Ospromenus gourani*, 365
- Osteoclasts, Phagocytosis by, 183
- Osterwalder, O., Disease of Raspberry, 85
- Otiorynchus cribicollis*, 48
- *ligustici*, 48
- *subcutus*, 48
- *turca*, 48

- Ovum, Cyclic Variations in Permeability of the Activated, 293
- Ox, Intercalated Discs in Heart-muscle, 41
- Oxnerella maritima* g. et sp. n., 201
- Oxyuris curricula*, 384
- P
- Pachysima Ethiops*, 373, 374
- Pæsi, 208
- Paillet, A., New Microsporidian in Cabbage White Caterpillars, 314
- Painter, Theophilus S., Cell-division in Monaster and Narcotized Ova, 311
- Palaeomyces bacilloides*, 392
- Papanicolaou, G. N., 35
- and Charles R. Stockard, Idiosome in Spermatogenesis of Guinea-pig, 361
- Papilio lycophron*, Gynandromorph of, 191
- Paracubaris spinosus* g. et sp. n., 381
- Paramecium auclia*, 202
- — Induction of Endomixis in, 314
- *caudatum*, 391
- Intracellular Respiration in, 314
- *putrinum*, 391
- Respiration in, 389
- Paramphistomidae, 385
- Paramphistomum g. n., 385
- Parasitism, Physiology of, 81
- Parasyndesis, 49
- Parathrombidium paulii* g. et sp. n., 380
- Parker, G. H., Activities of Corymorpha, 311
- Pedal Locomotion of *Aplysia californica*, 392
- Suction in Sea-anemone, 312
- Parmeliopsis, 89
- "Par-œdema" Bacillus, 391
- Parry, E., 314
- Partridge, New Nematode from, 198
- Pascher, A., Rhizopodial Development of the Flagellate. I. Some Rhizopodial Chryomonads with Chromatophores, 322
- — — II. *Dinamaba varians* — a Novelty with Dinoflaggella-like Swimmers, 322
- — — III. Rhizopodial Nets as Capturing-apparatus in a Plasmodial Chryomonad, 322
- — — IV. Fusion-plasmodia in Flagellate, and their Significance in the Descent of Rhizopods from Flagellate, 323
- Paspalum dilatatum*, 217
- Patouillard, N., Fungi from Tonkin, 220
- Patterson, J. J., Polyembryonic Blastocyst in Opossum, 178
- Paulson, R., Microscopy at Ruhlben, 26
- Varenne Collection of Lichens, 89
- Microscopic Structure of Lichens, 426
- Pea-nut Disease, 224
- Pear Thrips, 376
- Pearl, Raymond, Age and Fertility in Fowls, 363
- Effect on Progeny of Fowls after Treatment with Alcohol, 37
- Effects of Pituitary Body and Corpus Luteum on Chicks, 181
- Influence of Age on Reproductivity of Fowls, 363
- Measurements of Degrees of Kinship, 44
- Proportion of Sexes in Whitefish, 366
- Sex-ratio in Domestic Fowl, 182, 363
- and Alice M. Boring, Corpus luteum in Ovary of Chicken, 293
- Pearse, A. S., New Isopods from British Guiana, 58
- Pease, Michael S., 28
- Pediculus capitis*, 50
- *corporis*, 50
- *humanus*, 49
- *vestimenti*, 50
- Pellaea, 318
- *atropurpurea*, 68
- *glabella*, 68
- in North America, 68
- Pelomyxa lentissima* sp. n., 389
- Reactions of, to Food, 313
- *schickii* sp. n., 389
- Pénard, E., a New Type of Infusorian: *Arachnidiopsis paradoxa*, 283
- *Lenus Loxodes*, 202
- Penis, "Rudimentary," 364
- Pentastomid, New, from a Fish, 306
- Perch, Malagasy, Study of, 299
- Perezia legeri* sp. n., 314
- Peridermium cerebrum*, 81
- *filamentosum*, 81
- *pyriforme*, 81
- Peridinales of Plymouth Sound, 323
- Peripheral Nerves, Degeneration of, 98
- Perisporiales, South African, 326
- Perivascular Spaces, Lining of, 366
- Peronosporales, North American, 325
- Peronosporaceæ, 79
- Peronosporites antianarius* W. Smith, 392
- *gracilis*, 392
- Perrier, Edmond, History of Faunas and its Relation to Sex, 14
- Pests of Fruit-trees, Control of, 329
- Petalura gigantea*, 56
- Peter, A., Diatoms from Hanover and the Harz, 215
- Petersen, C. G. Joh., Fauna of Coastal Waters, 369
- Petri, L., Medium for Cultivation of *Blepharospira cambivora*, 227
- Petrographic Microscope, 231
- Petrology, Polarizing Stand for, 408
- Practical, Methods in, 408
- Peyronel, B., *Spondyloctadium atrovirens*, 86

- Pézar, 32
 Pfeiffer, R., and G. Bessau, Bacteria of Gas Gangrene, 394
Phagocata gracilis, 385
 Phagocytosis by Osteoclasts, 183
Phaseolus vulgaris, Embryogeny of, 61
 Phegopteris, Apogamy in, 67
 — *polypodioides*, 67
 Phellia, Four New Species of, 387
 Pheretima, Lymph-glands of, 382
 — Cœlomic Fluid of, 382
Pheretima posthuma, 390
 — — Cœlomic Pouches of, 383
Philostania (Attacus) ricini (Boisd.), 191
 — *cynthia* (Drury), 191
Phlœm necrosis, 85
Phoma Betæ, 86, 87
 — *mali*, 81
 Photomicrographs in Colour, 229
 Photomicrography, Telescopic Focussing Apparatus for, 400
 Phreatoicns, Fossil Species of, 381
 — *wiamanattensis* sp. n., 381
Phthirus pubis, 49
 — — Biology of, 378
 — — Pathological Effects of, 304
 Phycomycete, New, 79
Phyllachora Roystoneæ: a Disease of Royal Palm, 226
Phyllosticta citricola, 82
 — *pirina*, 81
 Physagirina, Experiments with, 45
Phyto melanocephala, 192
 Phytophthora, Development of, 325
 — *erythroseptica* Pethyb., Morphology and Cytology of the Sexual Organs of, 217
 — *infestans*, 79
 Phytoplankton, Caledonian, 213
Phytophthora Faberi, 83
 Pietet, Arnold, Dimorphic Colouring in Lepidoptera, 374
 Piemeisel, P. L., 220
 — F. J., 219
 Pierce, R. G., 226
 Piercy, Alma, Structure and Mode of Life of *Hormidium flaccidum*, 72
Pieris brassicæ, 47, 314
 Pig, Thyroid Follicles of, 292
 — Ultimobranchial Bodies in, 292
 Pig's Liver, Lobules of, 298
 Pigeons (Fantail), Inheritance in, 181
 — Right and Left Testes of, 363
 Pigments and Paints, Optical Properties of Colour of, 401
Pinus ponderosa, Disease of Seedlings of, 81
 Plagiochasma, 212
 Plaice, Otolith-method of Estimating Age of Plaice, 300
 Plaice and Flounders, Rings in Scales of, 300
Planaria maculata, 385
 — — Regeneration in, 309
Planaria, New Species of, 386
 Plankton, Antarctic, 214
 Plant-cells, Mitochondrias of, 204
 — Plastids of, 204
 Plant Diseases, Description and Treatment of, 329
 Plants, Diseases of, 223, 329
 — Injection Experiments on, 207
 — Mechanism of Overgrowth in, 207
 — Rate of Conduction of Injected Fluid, 207
 Platanus, North American, Characters of Words of, 205
Platanus occidentalis, 205
 — *racemosa*, 205
 — *Wrightii*, 205
Platylabus quæris sp. n., 196
Plectonema radiosum, 324
Pleodomus fuscomaculatus, 80
Pleodorina illinoensis, 73
 Plimmer, Henry George, Death of, 349
 Plough, Harold H., Temperature and Crossing-over in *Drosophila*, 303
 Plums, Resistance to Brown-rot, 87
 Plumularids, 387
 Pocock, R. L., Baculum or Os penis in some Genera of Mustelidæ, 300
 Podon, 370
 Pollaci, Gino, 81
 Pollard, F. J. S., 303
 Polychæt, Dimorphism in a, 58
 Polychæts, Monograph on, 383
Polygirus arenivorus, 389
 — *aurantiacus*, 380
 Polykaryocytes, 367
Polypodium punctatum, 209
 Polyporus, 328
 — *hirsutus*, 329
 — *lucidus*, 88
 — *versicolor*, 329
 Polystomidæ, 384
Polyxenus lucimeticus sp. n., 45
 Pond-Life Exhibition, 245
 Pool, V. W., *Phoma Betæ*, 86
 Pool, Venus W., 226
 — Infection by *Cercospora beticola*, 80
 — and M. B. McKay, Climatic Conditions and Conidial Development, 221
 Poratophilus, 195
Porcellio scaber, 192
Porites furcata, 200
 — *incrustans*, 60
Porocephalus nematoides, 306
Porphyra laciniata, 324
 Porter, Lilian, Attachment Organs of *Corticolous Ramalinæ*, 88
 Posey, G. B., 327
 Post-œstrous Changes in Dog, 36
 Potato-leaf Curl, 329
 Potato-tubers, Parasite on, 86
 Potatoes, Dry-rot of, 329
 Potter, Alden A., and G. W. Coons, Ustilaginæ, 219

- Pottia, 213
 "Pourquoi-pas?" Expedition of the, 214
 Powell and Leadland, 414
 Powell, Hugh, 413, 414
 Praeger, R. Lloyd, Irish Fungi, 83
 Prashad, Bainsi, 187, 384
 Pratt, O. A., Storage-rot in Potatoes, 224
 Presidential Address, 153
Prionemis variabilis, 47
 Pritchard, Dr. Urban, Donation of Diatom Slides, 410
 Pro-cœstrum, 35
 Protozoa of Lahore, 391
Protula meilhai, Segmentation of Ovum of, 58
 Psathyrometra, 386
 Pseudidotheidæ, 382
Pseudocalanus elongatus, 370
 Pseudohermaphroditism, 364
 Pseudoklossia, New Species of, 63
 — *pectinis* sp. n., 63
Pseudomonas Citri, the Cause of Citrus Canker, 222
 Pseudo-pregnancy, 36
 Pteridæ, Lines of Phylexis of, 208
 Pteridium, 208
 Pteris, 318
 — (*Histiopteris incisæ*), 208
 — *longifolia*, 68
Pterodrilus durbinii, 307
 Pteroidæ, Phylogeny of the, 208
Ptilidium pulcherrimum, 319
Ptychomitrium subcrispatum, 321
Puccinia graminis, 84
 — — Experiments on Cereals with, 219
 — — Infection of Timothy-grass by, 219
 — — *tritici-compacti*, 327
 — *Sclerizæ*, 327
 — *substriata*, 327
 Puget Sound Algæ, 77
 — — Marine Station, 77
 Punjabensis, 391
Pustularia gigantea, 220
 Pymaly, A. de, *Dichotomusiphon tuberosus*, 74
 Pyenidia, Growth of, 80
 Pyrenopolyporis, 82
Pythium Debaryanum, 86
Pyxidicula invisitata, 170, 243
- Q
- Quanjer, H. H., Phœm Necrosis, 85
 Quekett, Dr. Edwin, 414
- R
- Rabaud, Etienne, "Dislocated" Mice, 33
 — Paralyzing Habits of some Hymenoptera, 46
 Rabaud, Etienne, Reflex Immobilization in Arthropods, 372
 — Rôle of Ganglia in Immobilization, 373
 Rabbit, Development of Hypophysis of, 362
 — Male, Sexual Activity of, in Relation to Progeny, 297
 — — — of, 298
 — Mammary Glands of, 35
Ramalinæ calcicaris, 89
 — *fastigiata*, 89
 — *fraxinea*, 89
 — *pollinaria*, 89
 Ramsbottom, J., 79
 Ramsey, G. B., A Rhizoetonia Potato Disease, 225
Rana pipiens, 296, 368
 Rao, C. R. N., Iridocytes in Batrachian Larvæ, 367
 Rasmussen, A. T., Seasonal Changes in Interstitial Cells of Woodchuck, 184
 Raspberry, Disease of, 85
 Rat, Albino, Growth of Kidney of, 186
 — Development of Mammary Glands in, 179
 Rats and Evolution, 185
 — Growth of Parts of, and of the Whole, 366
 — Young Albino, Effects of Underfeeding, 297
 Rawdon, H. S., Unusual Feature in Microstructure of Wrought-Iron, 103
 Rawlins, F. I. G., Technique of the Vertical Illuminator, 116
 Rawson, H. E., 115
 Rea, Margaret W., and Margarita de Stelfox, Irish Mycetozoa, 90
Reboulia Charrieri, 319
 — *hemispherica*, 319
 — *occidentalis*, 319
 — *Raddi*, 319
 Redfield, Alfred C., and Elizabeth M. Bright, Effect of Radium on Fertilization Membrane of Nereis, 307
 Reese, Albert M., Blood-corpuscles of Alligator, 183
 Reeves, Edna M., Inheritance of Extra Bristles of Drosophila, 375
 Refractometer, Interference, 94
 Regeneration, Osseous, 41
 Reichenow, Ed., Intracellular Digestion in an Acarid, 379
 Rendle, Dr., The Use of Microscopical Characters in the Systematic Study of the Higher Plants, 317
 Report for 1917, 169
 Reptiles, Tapeworms of, 198
 — and Frogs, Trematodes of Queensland, 308
 Retroplumidæ, 382
 Retterer, Ed., and H. Neuville, Fatty Tissue of Crocodilians, 183
 Reynolds, F. C., Polarization of Light, 397

- Rhadinocera antiqua*, 378
 Rhacomitrium in North America, 320
 Rheinberg, J., 419
 — Donation of Photographic Scales, etc., 410
Rhizaster crinoides g. et sp. n., 322
Rhizina undulata, Sexuality in, 326
 Rhizoctonia, 86
 — Potato Disease, 225
 — *Solani*, its effects on Potato Tubers, 225
 — *violacea*, 85
 Rhizodiniæ, 322
Rhizophidium aciforme, 79
 Rhoales, Arthur S., Wood-destroying Fungi, 329
Rhynchothorium itisha sp. n., 384
Rhynchonetes typus Milne-Edwards, 196
Riccia Frostii, 212
 — *pathankotensis*, 212
 Riddle, L. W., Parmeliopsis, 89
 Riddle, Oscar, Right and Left Testes of Pigeons, 363
 Rielta, 212
 Rinderpest Virus, Vitality of, 97
 Ritchie, John, jun., Acetone as a Solvent for Mounting Media, 279
 Ritchie, Walter, Study of *Myelophilus minor*, 48
 Rivett, M. F., Structure of the Cytoplasm in the cells of *Alicularia scalaris*, 319
 Rogers, F., 235
 Rogers, James B., Effect of Thyroid Extirpation on Thymus and Pituitary Glands, 296
 Rose, Crown-canker Disease of, 85
 Rosenbaum, A., Root-rot of Ginseng, 87
 Rosenbaum, J., 223
 — *Rhizoctonia Solani*, its Effect on Potato Tubers, 225
 — Study of Phytophthora, 217
 Rosenvinge, L. K., 324
 Rosenvinge, L. N., Marine Algae of Denmark, 216
 Ross, Andrew, 414
 Ross, J., *Ptilidium pulcherrimum*, 319
 Ross, Thomas, 415
 Ross's Microscopes, 415
 Rothschild, N. C., Convergence among Ectoparasitic Insects, 52
 Rotifers, Controlling Sex in, 310
 Roubaud, E., Rapid Examination of Malarial Blood, 99
 Roule, Louis, Evolution of Salmonidæ, 41
 Rubber Disease, 83
 Rubus, spp., an Orange-rust of, 219
 Rudin, E., Tapeworms of Reptiles, 198
 Ruedemann, R., Median Eye in Trilobites, 189
 Russell, C. P., 194
 Russula, 328
 Rusts and Smuts in New Mexico in 1916, 219
 Rusts on Forest-trees, 219
 Ruth, E. S., and R. B. Gibson, Melanophores of Lizards, 298
- S
- Sabin, Florence R., Angioblasts and Blood-vessels, 180
Saccopsis alleni, 380
 Saggiaria, Development of Root-tip in, 205
 — *sagittæfolia*, 65, 205
 Sahni, B., 209
 — Evolution of Branching in the Filicales, 209
 Salkind, I., Sensory Structures of Crab's Claw, 380
Salmo trutta, 44
 Salmonidæ, Evolution of, 41
 Salvia, Development of Pollen in, 206
 Samsonoff-Aruffo, C., Calcareous Algae from Malta, 216
 Sandhoppers, New Zealand, 58
 Sanford, E. W., Digestion in Cockroach, 304
 Sarcotids, Plumiculous, of Birds and Mammals, 379
 Sargent, Ethel, Death of, 175
Sargassum duplicatum, 78
 — Iodine in, 325
 — *Sandei*, 78
Saturnia pavonia, 375
Sauchia spongiosa g. n., 212
 Sauropsida, Vestigial Gill-filaments in, 293
 Sauver, Dr. Albert, 93
Scalia Hookeri, 212
Scaphanocephalus australis sp. n., 199
 Schaeffer, Asa A., New Amoebæ, 389
 — New Diatom-eating Flagellate, 390
 Schaffnit, E., and G. Voss, Black-wart of Potatoes, 226
 Schein, H., Studies in Cattle-plague, 96
 Schiffner, V., *Lophozia Hatcheri* and *L. Baucuriana*, 72
 Schiller, J., Heterodinium in the Adriatic, 214
 — Meringosphaera, 216
Schistosoma osmundacea Mohr, 321, 322
 Schizæa, Stellar Ontogeny of, 208
Schizophyllum commune, 329
 Schultz, E. S., Silver-scurf on Potatoes, 223
 Schussnig, B., Fresh-water Algae of the Austrian Coast Districts, 321
 Schweinitz Collection of Fungi, 82
 Sciaridæ, 43
Scleroderma (?) quadridentatum sp. n., 45
Sclerospora macrospora on Corn, 226
Sclerosporium vulgare, 384
 Sclerotinia, 85
 — *cinerea*, 87

- Sclerotinia libertiana*, 87
 — *Smilacina*, 87
 — *Trifolium*, 86
Sclerotium Roysii, 224
 — — A Disease of Wheat, 226
 Scorpion, Cardiac and Skeletal Muscle of, 57
 — Spermatozoa, Chondriosomes of, 195
 Scotia, Expedition of the, 214
 Scourfield, D. J., 245
 — Fresh-water Copepods, 416
 Scrotum, Vestigial, 364
Scyllum canicula, 181, 291
 Sea-anemone, Suction in, 312
 Sea-anemones, New, from New Guinea, 387
 Sea-bottom in Danish Coastal Waters, 369
 Sea-spider, Leg-muscle of, 57
 Sea-urchin Ova, Permeability of, 310
 — of, 200
 Seas, Blood-red, 390
 Seed-tubers, Treatment against Dry-rot in, 223
Selaginella chrysoocaulos, 211
 — *chrysorrhizos*, 211
 — *Emanicata*, 210
 — *Kraussiana*, 211
 — *Martensii*, 211
 — *pallidissima*, 210
 — *serpens*, 210
 — *spinosa*, 211
 Senevet, G., Improved Staining of Malarial Parasites, 98
Septoria Chenopodii, 80
Sericaria mori, 47
Serolis bakeri sp. n., 381
 — *minuta*, 381
 Serum, Hæmolytic, 101
 Sex and Fauna, Relation of, 41
 Sex-hormones, 37
 Sexton, E. W., 195
 Sézary, A., Rapid Method for obtaining Hæmolytic Serum, 101
 Shad, Indian, 187
 Shantz, H. L., and R. L. Piémeisel, Fungus Fairy Rings, 220
 Sharples, A., Rubber Disease, 83
 Shear, C. L., "End-rot" Disease of Cranberry, 226
 — and N. E. Stevens, Schweinitz Collection of Fungi, 82
 Sheep, Atrophy of Right Superior Vena Cava, 43
 — Inheritance of Fertility in, 179
 Sheikevitch, 41
 Shelford, Victor E., Coloration of Tiger-beetles, 375
 Sheppard, E. J., 107
 — Two Valuable Methods of Staining in Bulk and Counter-staining, 275
 Shilton, A. W., Vitality of Rinderpest Virus, 97
 Shimamura, Torai, and Hajime Fujii, Toxic Constituent of Nematodes, 383
 Shore-crab, Development of, 382
 — Respiratory Mechanism of, 381
 Shuttleworth, 1786, 413
 Sidebottom, Henry, Report on the Recent Foraminifera dredged off the East Coast of Australia. H.M.S. "Dart," Station 19 (14 May, 1895). Lat. 29° 22' S., Long. 153° 51' E., 465 fathoms. Pteropod Ooze, 2, 121, 249
Siganus fuscescens, 385
Sigmapera cincta g. et sp. n., 308
 Silberstein, Ludwik, Method of Tracing Rays through any Optical System, 409
 — Electro-magnetic Theory of Light, 409
 Silica Solutions, Colloidal, Growths in, 404
 Silk-moths, Parthenogenesis of, 48
 Silkworms, Inheritance in, 191
 — in Madagascar, 47
 — variations in, 48
 Silver-scurf on Potatoes, 223
 Sim, T. R., South African Hepaticæ, 212
Simocephalus retulus, 63
 — — Sex Intergrades in, 197
 Sisyra, 389
 Slides Cabinet: Report of Committee, 420
 Sloane, Thomas G., Endoskeleton of Beetles, 194
Smerinthus populi, 47
 Smith, Bertram G., Germinal Vesicle in Cryptobranchus, 359
 Smith, E. F., Mechanism of Overgrowth in Plants, 207
 Smith, James, 414
 Smith, Wilbur C., Disappearance of *Conus arteriosus* in Teleosts, 370
 Smuts of Cereals, 327
 Snail, Cytoplasmic Inclusions in Germ-cells of, 189
 Snails, Marine, Smell and Taste in, 301
 Snakes, Australian Poison, New Trematode from, 309
 Soar, Charles D., Hydracarina of Epping Forest, 306
 — A Species of Uropoda, 427
Soldanellonyx chappuisi g. et sp. n., 195
 — *parriscutatus* sp. n., 195
 Souéges, R., Embryogeny of the Alismaceæ, 65
 — Development of Root-tip in Sagittaria, 205
 Soulier, A., Segmentation of Ovum of *Protula meilhaei*, 58
 Southwell, T., and Baini Prasad, Study of Hilsa, 187
 — Cestodes of Hilsa, 384
 Spegazzini, 82
 Spegazzinian Melioid Types, 80
 Spehl, P., Double Staining of the Tubercle Bacillus: a Modification of Spengler's Method, 493
 — Staining Spirilla with Formol-violet, 403

- Spengler's Method, Modification of, 103
 Spermatocytes, 360, 361
 Spermatogonial Division, 361
 Spermatozoon, 361
Sphaeronema fibriatum, 327
Sphaeropsis malorum, 222
 — — Effect on Tissues and Cell-contents of Apple, 221
Sphaerosyllis erinaceus (Op.), 306
Sphaerotheca pannosa (Powdery Mildew), 224
 Sphagna, Collection of the, 320
 — Ecology of the, 320
 — Taxonomy of the, 320
Sphagnum squarrosum, Archegonium of, 320
 Spherometer of Precision, 95
 Spider, Alteration of Instinct in, 57
 Spiders, Ant-like, 95
 — Ulster, 195
Spirosoma menthastris, 372
Spirochaeta duttoni, 380
 — *ictero hæmorrhagica*, Photographing the Minute Spirals of, 228
 — *pallidum*, 418
 — *recurrentis*, 50, 380, 390
 Spirochaetes, 239
 — Detection of, 418
 Spirochetosis, Experimental, Leucocytes in, 371
 Spiroditium, 323
 Spirogyra, 71
 — Effect of Barium, Strontium and Cerium on, 74
 Spirosireptidae, New, 195
 Splachnaceæ, 321
Spondylocaulinum atrovirens, 86
 — Causing Silver-scurf on Potatoes, 223
 Sponges, Desmacidonid, 201
 — from Inlé Lake, 389
 — Irish, 61
Spongilla fragilis, var. *calcuttana*, 389
 — *lacustris*, var. *prolifera* var. nov., 389
Spongospora subterranea, 223
 — — Life-history of, 90
 — Types of Dry-rot following, 223
Sporodina grandis, 217
 Sporulating Bacteria, Method for Double-staining, 233
 Sprue, Intestinal Flora of, 91
 Squashes, Diseases of, due to *Choanephora cucurbitarum*, 225
 Squirrel (Ground), Development of Liver in, 180
 Staining in Bulk and Counter-staining, 275
 Stakman, E. C., Immunity from Parasitic Fungi, 84
 — Uredinæ, 219
 — and G. R. Hoerner, *Puccinia graminis tritici-compacti*, 327
 — and F. J. Piemeisel, Experiments with *Puccinia graminis* on Cereals, 219
 Standley, Paul C., Rusts and Smuts of New Mexico, 219
 Stanford, E. C., 224
 Stebbing, T. R. R., Malacostraca of Natal, 196
 Steel, Hypo-eutectoid, 243
 — Methods for distinguishing Sulphides from Oxides in, 103
 — Microscopic Examination of, 236
 — Microstructure of, 265
 — Uniformity of a Cast of Acid Open-hearth, 235
 Steels, Heterogeneity of, 102
 Stefani, Prof. de, 216
Stegomyia fasciata, 376
 Steil, W. N., Study of Some New Cases of Apogamy in Ferns, 318
 Steinach, 32
 Stelfox, Margarita de, 90
Stemonitis hyperopta sp. n., 393
 Stendall, J. A., Ulster Spiders, 195
 Stenurosteptus, 195
 Stenostreptus, 195
 Stephanophiala g. n., 385
 Stephanophialinæ, American, 385
 Stephens, Jame, Irish Sponges, 61
 Stephenson, J., Oligochaeta of Inlé Lake, 383
 Stephenson, T. A., Antarctic Actiniaria, 312
 — Irish Actiniaria, 387
 Stereoscope for Examining Superposed Projections, 92
Stereum subpileatum, 88
 Steven, H. M., Biology of Chermes, 378
 Stevens, N. E., 82
 — Relation of Fungi to Host, 221
 Stevens, F. L., Spegazzinian Meliola Types, 80
 — Parasites on Meliola, 325
 Stewart, Chester A., Effects of Under-feeding Young Albino Rats, 297
 Stewart, F. H., Development of *Ascaris lumbricoides* and *A. mystax* in Mouse, 307
 — *Hymenolepis nana* Siebold and *H. murina* Dujardin, 384
 — Life-history of *Ascaris lumbricoides*, 307
 Stewart, Fred. W., So-called Thymus IV. of Cat, 362
 Stewart, V. B., 221
 — *Kerria japonica*, 85
 Stickleback, Seasonal Changes in Kidney of, 299
 Stigoclenium, 324
 Stockard, Charles R., 361
 — and George N. Papanicolaou, Oestrous Cycle in Guinea-pig, 35
 Stone, R. E., *Gynaecocoon interstitialis*, 219
 Storage-rot in Potatoes, 224
 Strecker, George L., Development of Auditory Capsule in Man, 33

- Stromatoporoids, Skeleton of, 60
 Strong, L. W., Short Method of Preparing
 Histological Material, 232
 Strong, R. M., Melanin in Feather-germs
 of Fowls, 187
Strongylus filaria, 187
Strongylocentrotus purpuratus fertilized
 with Spermatozoa of Starfish, 200
Strotometra ornatissimus, 386
 Struthiopteris, 209
 Strutt, Hon. R. J., Scattering of Light by
 Dust-free Air, with Artificial Repro-
 duction of the Blue Sky, 395
Stuleriotes crassa, 59
 Stunkard, H. W., North-American Trema-
 todes, 384
 Sturgis, W. C., Rare Myxomycetes, 90
Suberiopsis australis g. et sp. n., 59
 Sugar-beet, Fungi cause Damping-off of
 Seedlings of, 86
 Sugar-cane Leaf-Hopper, 49
 Sundara, Raj B., Fresh-water Fishes of
 Madras, 364
 Svedelins, N., Alternation of Generations
 in Floridae, 75
 Sweet-Potato, Scurf of, 87
 Swim-bladder, 43
 Swine, Maturation of Ovum in, 178
 Swingle, W. W., Effect of Starvation on
 Tadpoles, 295
 — Thyroid Feeding of Tadpoles, 296
 Swift's I.M.S. Microscope, 416
 Syllids, Notes on, 306
Synaptula hydriformis, 311
Synidesmnothrium filicelle, 384
Syngamus trachealis, 187
- T
- Tadpoles, Effect on Ossification of Extir-
 pating Thyroid in, 296
 — of Starvation on, 295
 — Thyroid Feeding of, 296
 Tadpole's Tail, Phagocytosis in, 368
 Tadpoles, Removal of Thyroid from, 296
Taeniothrips inconsequens, 376
 Tait, John, Body-colour and Blood-colour
 in Amphipods, 196
 Talbot, G., 191
Talorchestia telluris, 58
 Tanaka, T., Japanese Microfungi, 82
 Tyozaburo, and Arthur S. Rhoades,
 Diseases of Plants, 329
Targionia hypophylla, 69
Talusia necmiciuta, 177, 178
 Taylor, John W., British Terrestrial and
 Fresh-water Mollusca, 188
 Taylor, Monica, Fertilization in Gnat, 49
 Teiling, E., Caledonian Phytoplankton,
 213
 Teleosts, Role of Fins in, 43
Temora longicornis, 370
 Tenopyr, L. A., Constancy of Cell-Shape,
 316
 Teodora, G., Mites as Disease-carriers, 379
 Terry, George S., Effect on Ossification in
 Tadpoles of Extirpating Thyroid, 296
 Tesch, J. J., Siboga Crabs, 382
 Textile Fibres, Investigations on, 404
 Thapar, G. S., Lymph-glands of Pleroc-
 tima, 382
 Theba, 188
 Thing, Alice, *Zona pellucida* in Turtle
 Eggs, 290
 Thom, C. H., and G. H. Ayers, Effects of
 Pasteurisation on Mould-spores, 221
 Thom, C., and J. N. Currie, Species
 Grouped as *Aspergillus niger*, 211
 Thomas, H. E., 225
 — Uredineæ, 327
 Thompson, Elizabeth Lockwood, Experi-
 ments with *Physa gyrina*, 45
 Thompson, Helen B., and Lafayette B.
 Mendel, Growth of Mice, 294
 Thompson, W. R., Dipterous Parasite in
 Territorial Isopods, 192
 Thranstotheca, Development of, 217
 Thymus and Pituitary Glands, Effect of
 Thyroid Extirpation on, 296
 — Epithelial Reversions in, 41
 Thymus-feeding, Influence of, 296
 Thyropygnus, 195
 Tiger-beetles, Coloration of, 375
 Tilden, J. E., Myxophyceæ of North
 America, 215
Tillitia lævis, 219
 — *Tritici*, 219
 Tillyard, R. J., Caudal Gills of Larvæ of
 Zygopterid Dragonflies, 304
 — Monograph on Dragonflies, 55
 — Studies in Mecoptera, 190
 — Wing-venation of Lepidoptera, 302
 Timm, R., Mosses of North-West Ger-
 many, 213
 — Splachnaceæ, 321
Titanideum injobergi sp. n., 59
 Tomato-leaf Rust, 329
 Tomato-wilt due to a Fusarium, 221
 Tongue, Development of Serous Glands of,
 180
 Torulæ, Red, Colouring Matter of, 227
 Trabutca, New Species of, 220
 Trametes, 328
 Transeau, E. N., Alge of Michigan, 215
 Treherne, R. C., 376
 Trematode, New Amphistomid, from a
 Fish, 385
 Trematodes, North-American, 384
 Tribondeau, L., Staining Sporogenous
 Bacteria, 99
 — — Tubercle Bacilli, 100
Trichocephalus depressiusculus, 384
 Tricholoma, 328

Triclad from Inlé Lake, 386
Tricophæa Boudieri, a New Discomycete, 220
 Trigeminal Nerve. Minute Structure of Sensory Root of, 299
 Trilobites, Median Eye in, 189
 Trouessart, E. L., Mange Mites, 379
Trypanosoma cruzi, 380
 — *decei* sp. n., 314
 — *lesourdii* sp. n., 314
 Tschenzoff, B., Nuclear Division in *Euglena viridis*, 323
 Tubercle Bacilli, Staining, 100
 — Bacillus, Method of Staining, 233
 Tulloch, W. J., Medium for Cultivating Bacillus tetani, 231
 Tungsten-Molybdenum Alloys, 102
 Turbellarian, Fresh-water. Reactions of, 385
 Turbinaria, Iodine in, 325
 Turritella Rumbler, 406
 Turnip, Leaf-spot on, 225
 Turnips, Finger-and-Toe in, 329
 Turtle Eggs, *Zona pellucida* in, 290
 — Loggerhead, Germ Cells of, 38
 Twins, Two-sexed, 37
 Trypanosomiasis, American, 380
 Typhus, Prophylaxis of, 50

U

Uca lacteus de Haan, 196
 Uhlenbuth, Eduard, Influence of Thymus-feeding, 296
 — Grafts in *Amblystoma*, 297
 "Uhrzeiger" or "Clock-hand" Bacillus, 394
 Ulva, 77
Underwoodia columnaris, 220
Unionicola aculeata, 379
 Uredineæ, 81, 219, 327
Uredo cantoniensis sp. n., 220
 Ustilagineæ, 219
Ustilina zonata, 83

V

Valleau, W. D., Brown-rot of Plums, 87
 Vancy, C., and A. Allemand-Martin, Larva of Horse-sponge, 201
 Vanneman, Aimee S., Germ-cells of Armadillo, 177
 Varde, R. Potier de la, *Ptychomitrium subcrispatum*, 321
 Vaughan, T. W., Studies in Living Corals, 200
 Venus, 367
 Vertebrates, Air-breathing, Origin of, 185
 — Craniate. "Proboscis Pores" in, 186

Verticillium, 224
 Vestal, A. G., Lichen Ecology, 89
 Vincens, F., 220
 Vess, G., 226

W

Wade, H. Windscr., Pathogenic Fungus, 84
 Wakefield, E. M., 83
 — Nigerian Fungi, 83
 Wallin, Ivan E., Thymus-like Structures in Larval Lamprey, 49
 — Branchial Epithelium of Ammocoetes, 298
Walbrothiella Accentholii, 86
 Walter, C., Swiss Halacaridae, 195
 Walton, Chas. L., Agricultural Zoological Survey of Aberystwith Area, 187
 — Liver-rot, 309
 Warning, E., 324
 Warnstorf, C., Poltia, 213
 Warren, Don C., Mutations in *Drosophila busckii*, 192
 Wart-disease of Potatoes, 81
 Watts, W. W., Australian Ferns and Mosses, 67
Webbia clavata (P. and J.), 106
 Wehrle, L. P., 383
 Weidman, Fred D., Structure and Development of *Cladocelis*, 309
 Weimer, Bernol R., Reactions of Fresh-water Turbellarian, 385
 Weir, J. R., Altitudinal Range of Forest Fungi, 222
 — Diseases of Plants, 223
 — Herpotrichia, 86
 — Needle-blight of Douglas Fir, 225
 — *Pinus ponderosa*, 81
 — and E. E. Hubert, Inoculation with Spores of *Hyalospora Polypodii*, 219
 — — *Metasporella* spp., 219
 — — Rusts on Forest-trees, 219
 Welch, Paul S., and L. P. Wehrle, Reproduction in Nematodes, 383
 Wentworth, E. N., Inheritance of Fertility in Sheep, 179
 Werber, E. L., Morphogenesis of Duplicities, 291
 Wernher, H., and O. Wiese, Relapsing Fever, 390
 Wessenberg-Lund, 213
 West, C., Stellar System of the Marattiaceæ, 66
 West, G. S., A New Species of Gongrosira, 30
 — Biology of Algae, 72
 — New Species of Gongrosira, 105
 Weston, W. H., Development of Thraustotheca, 217
 Wharton, L. D., 199
 Wheeler, W. M., Study of Ant Larvæ, 373

- Wheldon, J. A., Collection, Taxonomy, and Ecology of the Sphagna, 320
 Whitefish, Proportion of Sexes in, 366
 Whitehouse, R. H., Caudal Fin of Chauliuria, 368
 Whiting, P. W., Inheritance of Coat-colour in Cats, 294
 Whitney, D. D., Controlling Sex in Rotifers, 310
 Wiese, O., 390
 Williams, R. S., Interference Refractometer, 94
 Williamson, H. Chas., Otolith-method of Estimating Age of Plaice, 300
 Williamson, R., 96
 Williamson, W., Rare Hydracarid, 57
 — and Charles D. Soar, *Lebertia sefvei* Walter, 306
 Wilson, Edmond B., Chondriosomes of Scorpion Spermatozoa, 195
 Wilson, G. W., North American Peronosporales, 325
Winnertziola burmitica sp. n., 45
 Wintrebert, P., Earliest Movements of Dogfish Embryo, 291
 Wolf, Frederick A., Citrus Canker, 222
 — Disease of Squashes due to *Choaneophora cucubitarum*, 225
 Wolf, F., and R. O. Cromwell, Root-rot of Apple-trees, 88
 Wolf, F. A., and E. E. Stanford, Disease of Fig-trees in North Carolina caused by *Macrophoma Fici*, 224
 Wood, Casey Albert, Fundus oculi of Birds, 407
 Wood, J. Medley, 82
 Woodchuck, Interstitial Cells of the Testis of, 184
 — Seasonal Changes in Interstitial Cells of, 184
 — Spermatogenesis in, 184
 Woodruff, L. L., Rhythms in Endemixis, 202
 Workman, Thomas, 195
 Wratten "M" Filters, 398
 Wright, F. E., Petrographic Microscope, 231
 Wright, W. B., 231
 Wrought-iron, Microstructure of, 103
 Wuist, Elizabeth D., Apogamy in Phegopteris and Osmunda, 67
- X
- X-chromosome, 361
 — — Hermaphroditism of, 380
Xenocaloma brumpti, Observations on, 380
Xironodrilus formosus, 307
 Xylaria, 88
 — Root-rot of Apple-trees, 225
 Xylariae, 82
- Y
- Yates, H. S., Fungi from Southern China, 220
 Yatsu, Naohide, Maxillary Gland of *Cypridina hilgendorfi*, 198
 — Physiology of Medusæ, 200
 — Reactions of Charybdea, 388
 Yendo, K., Japanese Marine Algæ, 78
 Yendo, Y., Injection Experiments on Plants, 207
 Yocum, Harry B., Spermatogenesis in Mouse, 360
 "Yolk-islands," 359
 Yolk-sac and Bone-marrow, Giant-cells of, 367
 Young, R. T., Experimental Induction of Endemixis in *Paramecium aurelia*, 314
- Z
- Zoæa, 382
Zoogonus viciparus (Olsson), 308
 Zostera, 77
 Zschokke, F., *Dibothriocephalus parvus* Stephens, 198
Zygnema cyanospermum, 215
 — Starch Formation in, 74
Zygoecytle ceratosa g. et sp. n., 385

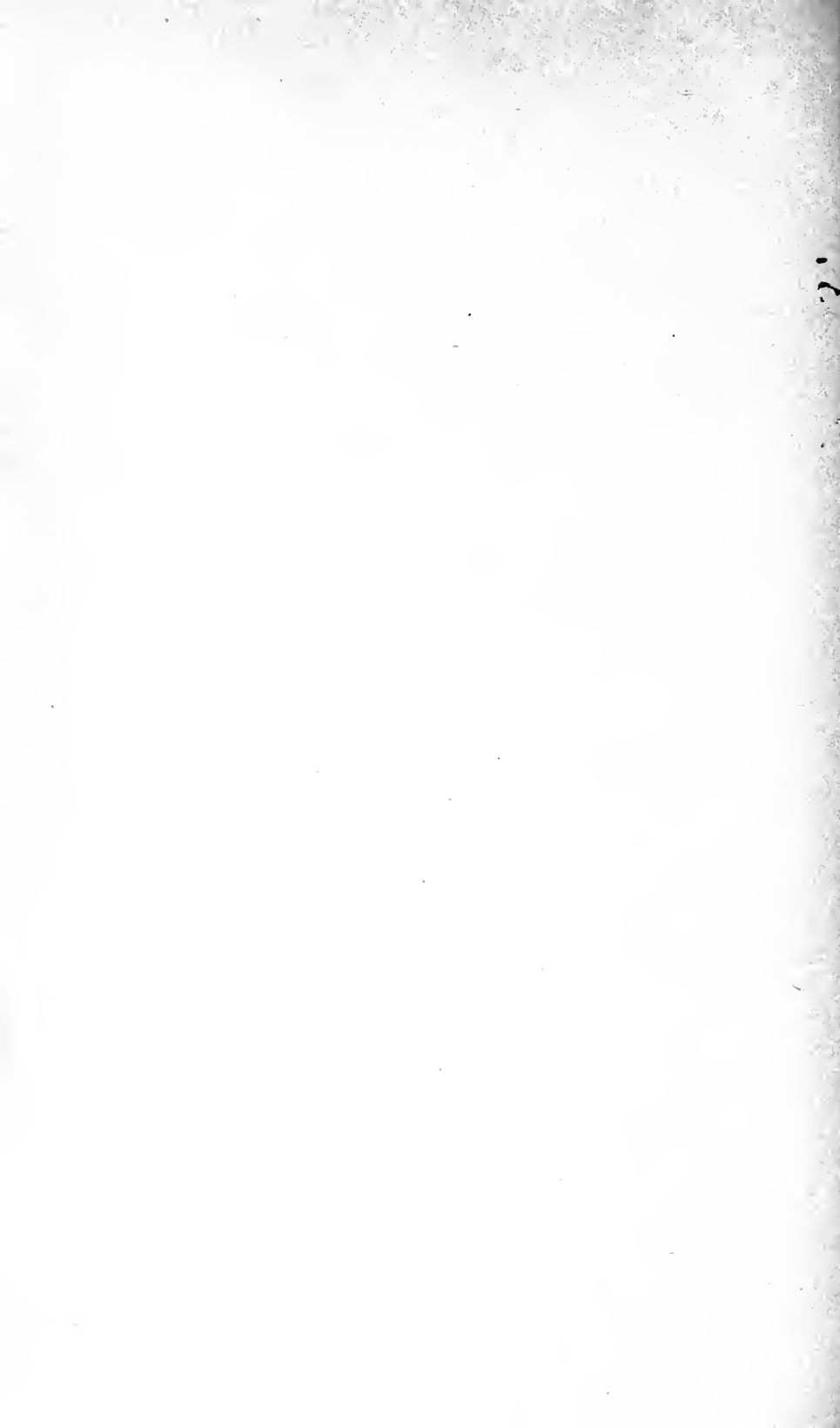

MBL WHOL LIBRARY



WH 18WN R

15531

