



Journal of the Royal Microscopical Society

CONTAINING ITS TRANSACTIONS AND PROCEEDINGS

AND

A SUMMARY OF CURRENT RESEARCHES RELATING TO
ZOOLOGY AND BOTANY

(principally Invertebrata and Cryptogamia)

MICROSCOPY, &c.

EDITED BY

CHARLES SINGER, M.A. M.D. F.R.C.P.

WITH THE ASSISTANCE OF THE PUBLICATION COMMITTEE AND

J. ARTHUR THOMSON, M.A. LL.D.

*Regius Professor of Natural History in the
University of Aberdeen*

A. N. DISNEY, M.A. B.Sc.

FELLOWS OF THE SOCIETY,

A. B. RENDLE, M.A. D.Sc. F.R.S. F.L.S.

Keeper, Department of Botany, British Museum

AND

RALPH ST. JOHN BROOKS,

M.A. M.D. D.P.H. D.T.M. & H. (CAMB.)

Minimis partibus, per totum Naturæ campum, certitudo omnis innititur
quas qui fugit pariter Naturam fugit.—*Linnaeus.*

FOR THE YEAR

1919



TO BE OBTAINED AT THE SOCIETY'S ROOMS

20 HANOVER SQUARE, LONDON, W.1

OF MESSRS. WILLIAMS & NORGATE, 14 HENRIETTA STREET, LONDON, W.C. 2

AND OF MESSRS. DULAU & CO., LTD., 34 MARGARET STREET, LONDON, W.1

COUNCIL.

ELECTED 21ST JANUARY, 1920.

President.

J. W. H. EYRE, M.D., M.S., F.R.S. Edin.

Vice-Presidents.

SIR GEORGE SIMS WOODHEAD, K.B.E., M.A., M.D., LL.D., etc.

FREDERIC J. CHESHIRE.

PERCY E. RADLEY.

ALFRED N. DISNEY, M.A., B.Sc.

Treasurer.

CYRIL F. HILL.

Secretaries.

JOSEPH E. BARNARD.

DAVID J. SCOURFIELD, F.Z.S.

Ordinary Members of Council.

MAURICE A. AINSLIE, R.N.

HERBERT F. ANGUS.

MAURICE BLOOD, M.A., F.C.S.

F. MARTIN DUNCAN, F.R.P.S.

ARTHUR EARLAND.

SIR ROBERT HADFIELD, Bart., D.Sc., F.R.S.

T. H. HISCOTT.

JAMES A. MURRAY, M.D.

JULIUS RHEINBERG.

E. J. SHEPPARD.

CHARLES SINGER, M.A., M.D.

JOSEPH WILSON.

LIBRARIAN.

F. MARTIN DUNCAN, F.R.P.S.

EDITOR AND CURATOR OF INSTRUMENTS.

CHARLES SINGER, M.A., M.D.

CURATOR OF SLIDES.

E. J. SHEPPARD.

CURATOR OF METALLURGICAL SPECIMENS.

F. IAN G. RAWLINS.

Patron

HIS MAJESTY THE KING.

Past-Presidents.

	Elected
*SIR RICHARD OWEN, K.C.B. D.C.L. M.D. LL.D. F.R.S.	1840-1
*JOHN LINDLEY, Ph.D. F.R.S.	1842-3
*THOMAS BELL, F.R.S.	1844-5
*JAMES SCOTT BOWERBANK, LL.D. F.R.S.	1846-7
*GEORGE BUSK, F.R.S.	1848-9
*ARTHUR FARRE, M.D. F.R.S.	1850-1
*GEORGE JACKSON, M.R.C.S.	1852-3
*WILLIAM BENJAMIN CARPENTER, C.B. M.D. LL.D. F.R.S.	1854-5
*GEORGE SHADBOLT	1856-7
*EDWIN LANKESTER, M.D. LL.D. F.R.S.	1858-9
*JOHN THOMAS QUEKETT, F.R.S.	1860
*ROBERT JAMES FARRANTS, F.R.C.S.	1861-2
*CHARLES BROOKE, M.A. F.R.S.	1863-4
*JAMES GLAISHER, F.R.S.	1865-6-7-8
*REV. JOSEPH BANCROFT READE, M.A. F.R.S.	1869-70
*WILLIAM KITCHEN PARKER, F.R.S.	1871-2
*CHARLES BROOKE, M.A. F.R.S.	1873-4
*HENRY CLIFTON SORBY, LL.D. F.R.S.	1875-6-7
*HENRY JAMES SLACK, F.G.S.	1878
*LIONEL S. BEALE, M.B. F.R.C.P. F.R.S.	1879-80
*PETER MARTIN DUNCAN, M.B. F.R.S.	1881-2-3
*REV. WILLIAM HY. DALLINGER, M.A. LL.D. F.R.S.	1884-5-6-7
*CHARLES THOS. HUDSON, M.A. LL.D. (Cantab.), F.R.S.	1888-9-90
*ROBERT BRAITHWAITE, M.D. M.R.C.S.	1891-2
ALBERT D. MICHAEL, F.L.S.	1893-4-5-6
EDWARD MILLES NELSON	1897-8-9
WILLIAM CARRUTHERS, F.R.S. F.L.S. F.G.S.	1900-1
HENRY WOODWARD, LL.D. F.R.S. F.G.S. F.Z.S.	1902-3
DUKINFIELD HY. SCOTT, M.A. Ph.D. LL.D. F.R.S. F.L.S.	1904-5-6
*THE RIGHT HON. LORD AVEBURY, P.C. D.C.L. LL.D. F.R.S., etc.	1907-8
SIR EDWIN RAY LANKESTER, K.C.B. M.A. LL.D. F.R.S. F.L.S. F.Z.S.	1909
J. ARTHUR THOMSON, M.A. F.R.S.E.	1910-11
*HENRY GEORGE PLIMMER, F.R.S., F.L.S., F.Z.S., etc.	1911-12
SIR G. SIMS WOODHEAD, K.B.E. M.A. M.D. LL.D. F.R.S.E., etc.	1913-15
EDWARD HERON-ALLEN, F.R.S. F.L.S. F.G.S., etc.	1916-17
JOSEPH E. BARNARD	1918-19

* Deceased.

CONTENTS.

TRANSACTIONS OF THE SOCIETY.

	PAGE
I.—Presidential Address, 1917-18: The Limitations of Microscopy. By Joseph E. Barnard, P.R.M.S. (One figure)	1
II.—Eye-pieces with Adjustable Compensation. By H. Hartridge, M.A., M.D., F.R.M.S., Fellow of King's College, Cambs. (One diagram).. .. .	15
III.—The Identification of Intracellular Structures. By J. Bronté Gateaby, Senior Demy, Magdalen College, Oxford, Lecturer in Cytology, University College, London. (With fourteen text-figures)	93
IV.—A Method of Adjusting Tube Length. By H. Hartridge, M.A., M.D., F.R.M.S., Fellow of King's College, Cambs. (One diagram)	119
V.—A Standard Microscope. By Lieut.-Col. J. Clibborn, C.I.E., B.A., F.R.M.S.	125
VI.—Tropical Diseases due to Microscopic Organisms in the Balkanic Zone. By Aldo Castellani, M.D., M.R.C.P., Lieut.-Colonel Italian Medical Service (Naval Branch), Member of Permanent Committee, Inter-Allied Sanitary Commission. (One plate)	209
VII.—The Isolation of the Single Bacterial Cell. By Nathan Mutch, M.A., M.D., M.R.C.S. (From the Bacteriological Laboratory, Guy's Hospital.) (One text-figure)	221
VIII.—On the Chemistry of Dendritic Growths in Paper. By James Strachan, F.R.M.S.	225
IX.—On <i>Folliculina boltoni</i> (S. Kent). By E. Penard, Sc.D. (Two plates)	305
X.—Note on Cajal's Formalin-Silver Nitrate Impregnation Method for the Golgi Apparatus. By H. M. Carleton, B.A., Demonstrator in Histology, and Christopher Welch Scholar, University of Oxford. (From the Department of Physiology.) (With three text-figures)	321

OBITUARY.

H. J. Grayson. By W. M. Bale	20
--------------------------------------	----

1215

SUMMARY OF CURRENT RESEARCHES.

ZOOLOGY.

VERTEBRATA.

α. Embryology, Evolution, Heredity, Reproduction,
and Allied Subjects.

	PAGE
DRIPS, DELLA— <i>Ovary of Spermophile</i>	23
RIDDLE, OSCAR— <i>Identical Female Twins in Pigeons from Ora of High Storage</i>	
<i>Metabolism</i>	23
" " & J. ARTHUR HARRIS— <i>Blood-fat and Egg-production in Fowls</i> ..	24
" " & CARL E. ANDERSON— <i>Effects of Quinine on Production of Yolk</i> <i>and Albumen</i>	24
LONG, J. A.— <i>Æstrous Cycle in Rats</i>	24
POYNTER, C. W. M.— <i>Wound Healing in Early Embryo of Chick</i>	25
RIDDLE, OSCAR, & VICTOR K. LA MER— <i>Post-mortem Melanin Formation in Eyes of</i> <i>White Ring Doves</i>	25
DANFORTH, C. H.— <i>Brachydactyly in Fowl</i>	25
BADERTSCHER, J. A.— <i>Ultimobranchial Bodies in Pig</i>	26
ATWELL, WAYNE J., & IDA SITLER— <i>Development of Hypophysis</i>	26
BAUMGARTNER, E. A.— <i>Development of Hypophysis of Reptiles</i>	26
" " — <i>Development of Hypophysis in Dogfish</i>	27
ANGLE, E. J.— <i>Development of Wolfian Body of Pig</i>	27
TERRY, R. J.— <i>Development of Cat's Skull</i>	27
ALSOP, FLORENCE M.— <i>Influence of Abnormal Temperature on Developing Nervous</i> <i>System of Chick</i>	27
HARTMAN, CARL— <i>Development of Opossum</i>	28
REED, H. D.— <i>Fenestral Ear Plate in Caudate Amphibia</i>	28
THURINGER, J. M.— <i>Dicephalic Pig</i>	28
POHLMAN, A. G.— <i>Double Ureters in Pig and Man</i>	28
BUJARD, E.— <i>Split Fore-brain in Sheep Embryo</i>	28
STREETER, G. L.— <i>Formation of Filum terminale</i>	29
KING, HELEN DEAN— <i>Inbreeding and Sex-Ratio in Albino Rats</i>	127
" " <i>Inbreeding and Body Weight in Albino Rats</i>	128
" " <i>Inbreeding and Fertility in Albino Rats</i>	128
HATAI, S.— <i>Feeding Sudan to Young Albino Rats</i>	128
KIRKHAM, W. B.— <i>Suckling and Rate of Embryonic Development in Mice</i>	128
STOCKARD, CHARLES R., & GEORGE N. PAPANICOLAOU— <i>Effect of Alcohol on Guinea-</i> <i>pigs</i>	128
COSTA, A. CELESTINO DA— <i>Amnion-Formation in a Bat</i>	129
" " <i>Amnion Formation in Mammals</i>	129
GUYER, M. F., & E. A. SMITH— <i>Effect of Cytolysins on Embryos</i>	129
KOLLMAN, MAX— <i>Female Reproductive System in some Falcons</i>	130
NEWMAN, H. H.— <i>Hybrids between Fundulus and Mackerel</i>	130
DELAGÉ, YVES— <i>L'Année Biologique</i>	229
SWINGLE, W. W.— <i>Effects of Iodine on Tadpoles</i>	229
" " <i>Influence of Iodine on Thyroid Gland of Tadpoles</i>	229
EWART, J. COSSAR— <i>Sheep Crosses and New Varieties of Wool</i>	230

	PAGE
SUMNER, F. B.— <i>Superfetation in Mice</i>	230
KIRKHAM, W. B.— <i>Fate of Homozygous Yellow Mice</i>	231
STARK, MARY B.— <i>Hereditary Taunour</i>	231
SCHMIDT, W. J.— <i>Neural Plates of Chelonian Carapace</i>	231
GLASER, O. C.— <i>Neural Folds</i>	232
HANSON, F. B.— <i>Coracoid of Pig</i>	232
MORRILL, C. V.— <i>Symmetry Reversal and Mirror-imaging in Monstrous Trout</i>	232
ATTERBURY, RUTH RAND— <i>Pharyngeal Tonsil and Bursa in Calf</i>	232
MOORE, CARL R.— <i>Influence of Gonads in White Rats</i>	233
DANFORTH, C. H.— <i>Possibility of Differential Selection of Germ-cells in Fowl</i>	233
GOODALE, H. D.— <i>Interstitial Cells in Gonads of Fowl</i>	233
ALLEN, EZRA— <i>Diet and Testicular Degeneration in Rat</i>	234
THOMSON, ARTHUR— <i>Maturation of Human Ovary</i>	329
STREETER, GEORGE L.— <i>Formation of Single-ovum Twins</i>	329
DANFORTH, C. H.— <i>Selection among Germ-cells</i>	330
GOODALE, H. D., & GRACE MACMULLEN— <i>Winter Egg-production in Poultry</i>	330
CARAZZI, D.— <i>Development of Guinea-Pig (1 fig.)</i>	330
HANSON, FRANK BLAIR— <i>Development of Pig's Sternum</i>	331
GOODRICH, EDWIN S.— <i>Development of Pericardio-peritoneal Canals in Selachians</i>	331
CULL, S. T. WALLIS— <i>Spina bifida in very early Human Embryo</i>	332
HOSKINS, E. R., & M. M.— <i>Influence of Thyroid on Growth and Development of Amphibia</i>	332
KING, HELEN DEAN— <i>Inbreeding-effects in Albino Rats</i>	332
STEWART, CHESTER A.— <i>Underfeeding Rats</i>	333
MOORE, CARL R.— <i>Gonads as Controllers of Characteristics</i>	333
LIPSCHÜTZ, A.— <i>Sex-characters and Sex-glands</i>	333
MURRAY, JOHN G., JUN.— <i>Relation of Ovary to Causation of Sex</i>	333
CHAMPY, CH., & P. COLLE— <i>Correlation between Pigeon's Crop and Gonads</i>	334

b. Histology.

CLARK, ELEANOR LINTON, & ELIOT R. CLARK— <i>Vital Staining of Tadpole's Tail</i>	29
JORDAN, H. E.— <i>Histogenesis of Blood-platelets in Yolk-sac of Pig</i>	29
MCJUNKIN, F. A.— <i>Origin of Phagocytic Mononuclear Cells</i>	29
SCAMMON, R. E.— <i>Structure of Corpus aliposum buccæ</i>	30
HOLMGREN, NILS— <i>Epiphysis of Dogfish</i>	30
.. .. — <i>Parietal Organs of Frog</i>	30
.. .. — <i>Epiphysis Nerves in Sprat and Herring</i>	31
SUMNER, F. B., & H. H. COLLINS— <i>Autotomy in Pocket Mice</i>	31
ALLEN, BENNETT M.— <i>Experiments on Tadpoles</i>	31
.. .. — <i>Endocrine Glands of Frog and Toad</i>	31
LARSON, MARY ELIZABETH— <i>Endocrine Glands of Toad</i>	31
RIDDLE, OSCAR— <i>Hereditary Ataxia in Pigeons</i>	32
KOCH, MATHILDA L., & OSCAR RIDDLE— <i>Analysis of Ataxic Brains of Pigeons</i>	32
SOUTHWELL, T., & B. PRASHAD— <i>Tumours in Climbing Perch</i>	32
MATSUMOTO, SHINICHI— <i>Epithelial Movement in Tissue Culture</i>	130
.. .. — <i>Cell Movements in Corneal Epithelium</i>	131
BORTNOWSKY, ISAAC— <i>Minute Structure of Monkey's Pharynx</i>	131
REITERER, ED.— <i>Structure and Origin of Dentary Enamel</i>	131
.. .. — <i>Cortex of Roots of Teeth</i>	131
REDFIELD, ALFRED C.— <i>Melanophores of Horned Toad</i>	132
MURISIER, P.— <i>Division of Melanophores of Trout</i>	132

	PAGE
BAYLISS, W. M.— <i>Protoplasm and Cell Contents</i>	234
" " <i>Nature and Permeability of the Cell Membrane</i>	234
LEGRAND, LOUIS— <i>Theory of Specific Plasma</i>	235
LEWIS, WARREN H.— <i>Centriole and Centrosphere in Degenerating Fibroblasts</i> ..	236
DERSCHAU, M. V.— <i>Passage of Solids from Nucleus to Cytoplasm</i>	236
SCHREINER, K. E.— <i>Minute Structure of Hagfish-skin</i>	236
PORTIER, PAUL— <i>New Theory of Symbiosis</i>	236
MUNSON, I. P.— <i>Continuity of Cells and Amitotic Karyokinesis</i>	237
DANCHAKOFF, VERA— <i>Properties of Mesenchyme</i>	237
BECK, CLAUDE S.— <i>Distribution of Clasmatocytes</i>	237
VANCE, H. W.— <i>Structure of Clasmatocytes</i>	237
NICHOLLS, GEORGE E.— <i>Reissner's Fibre</i>	238
FLATHER, MARY DRUSILLA— <i>Blood Supply of Areas of Langerhans</i>	238
JORDAN, H. E.— <i>Intercalated Discs in Striped Muscle</i>	238
MOODIE, ROY L.— <i>Antiquity of Bone Structure</i>	238
ASAI, TAKESHIRO— <i>Minute Structure of Membranous Labyrinth of Tadpoles</i> ..	334
LEWIS, MARGARET REED— <i>Development of Cross-striations in Heart Muscle of Chick Embryo</i>	335
ALEXANDRE, ALBERT & MARY— <i>Ultra-microscopic Particles</i>	335
CARTER, J. THORNTON— <i>Enamel Organ of Hake</i>	335
HUNTSMAN, A. G.— <i>Growth of Fish Scales</i>	336
HUTTON, J. ARTHUR— <i>Scale-reading in Salmon</i>	336
LYNCH, VERNON— <i>Functions of Nucleus</i>	337
LEWIS, WARREN H.— <i>Degeneration of Fibroblasts of Chick Embryos in Cultures</i> ..	337
WITTE, LUCILLE— <i>Development of Heart-muscle of Pig</i>	338
GLEY, E.— <i>Hæmolytic Action of Blood of Young Eels</i>	338
ZILVA, S. S., & F. M. WELLS— <i>Changes in the Teeth of the Guinea-Pig produced by Scorbatic Diet</i>	338

c. General.

MONARD, A.— <i>Deep-water Fauna of Lake Neuchatel</i>	32
MÜLLER, R. T.— <i>Fauna of Eichener Lake</i>	32
LONGLEY, W. H.— <i>Colours of Reef-fishes</i>	33
SHELFORD, V. E.— <i>Reaction of Fishes to H-ions</i>	33
NORDQVIST, O.— <i>Are there Varieties of Eel?</i>	33
CHAPMAN, ROYAL NORTON— <i>Pelvic Structure and Burrowing Habits</i>	33
OSBORNE, W. A.— <i>Aqueous Humour</i>	133
COLLINS, H. H.— <i>Moult and Regeneration of Pelage in Deer-mice</i>	133
WHITING, P. W., & HELEN DEAN KING— <i>New Mendelian Variety of Norway Rat</i>	133
FORBES, S. A., & R. E. RICHARDSON— <i>Changes in Life-conditions in Illinois River</i>	134
SCOTT, A.— <i>Monthly Occurrence of Pelagic Eggs in Port Erin Bay in 1918</i>	134
HERDMAN, W. A., & OTHERS— <i>Intensive Study of Isle of Man Plankton</i>	134
KROGH, A., & ISABELLA LEITCH— <i>Respiration in Fishes</i>	135
MAYER, ALFRED GOLDSBOROUGH— <i>Non-existence of Nervous Shell-shock in Fishes and Marine Invertebrates</i>	239
LARSON, JOHN A.— <i>Functional Correlation of Hypophysis and Thyroid</i>	239
ROCHON-DAVIGNEAUD, A.— <i>Corneal Protection in Crawling Animals</i>	239
MAYER, ALFRED GOLDSBOROUGH— <i>Rate of Nerve-conduction in Sea-water</i>	240
POLIMANTI, O.— <i>Colour-sense in Fishes</i>	240
WHITE, GERTRUDE MAREAN— <i>Colour-discrimination in Sticklebacks and Minnows</i>	240

	PAGE
HAHN, ERNA— <i>Colour-sense in Diurnal Birds</i>	241
HOSKINS, E. R., & M. M. HOSKINS— <i>Reactions of Dogfishes to Injections</i>	241
RASMUSSEN, ANDREW T.— <i>Blood and Blood Gases in Hibernating Woodchuck</i>	241
" " <i>Nerve-cells of Woodchuck during Hibernation</i>	242
DAHLGREN, ULRIC— <i>Luminous Animals</i>	242
MAYER, ALFRED GOLDSBOROUGH— <i>Death from High Temperature</i>	242
JACOBS, M. H.— <i>Acclimatization and Upper Thermal Death Points</i>	243
BIGNEY, ANDREW J.— <i>Influence of Adrenin on Frog's Melanophores and Retina</i> <i>Cells</i>	243
BLANK, ERNST— <i>Bent Tail in Mice</i>	243
SCOTT, GEORGE G.— <i>Osmotic Pressure of the Blood</i>	243
WATERMAN, T. T.— <i>Evolution of the Chin</i>	244
WILLIAMSON, H. CHAS.— <i>Dentigerous Cyst on Cod's Upper Jaw</i>	244
COCKERELL, T. D. A.— <i>Fossil Fish-scales</i>	244
SURBECK, G.— <i>Fauna of Ritom Lake</i>	339
MACLEOD, JULIUS— <i>Quantitative Method in Biology</i>	339
TAKENOUCHI, MATSUZIRO— <i>Resistance of Red Blood Corpuscles to Hypotonic Salt</i> <i>Solutions</i>	339
GOODRICH, EDWIN S.— <i>Heart of Reptiles</i>	340
BENHAM, W. B.— <i>Two Unusual Blood Vessels in Tree-Frog</i>	340
PURSER, G. L.— <i>Brain and Cranial Nerves of Dogfishes</i>	340
NUSBAUM-HILAROWICZ, J.— <i>Organs of Internal Secretion in Fishes</i>	340
SHANN, E. W.— <i>Myology of Shoulder-girdle and Pectoral Fin in Fishes</i>	340
LEBOUR, MARIE V.— <i>Feeding Habits of Young Fishes</i>	341
BOUTAN, A.— <i>Function of Swim-bladder</i>	341

Tunicata.

DAY, EDWARD C.— <i>Nervous System of Ascidian</i>	244
METCALF, MAYNARD M.— <i>Taxonomic Study of Salsidæ (2 figs.)</i>	245
" " & HOYT S. HOPKINS— <i>Taxonomic Study of Pyrosoma (2 figs.)</i>	246

INVERTEBRATA.

Mollusca.

ANTHONY, R.— <i>Muscle-fibres of Molluscs</i>	135
CROZIER, W. J.— <i>Use of Foot in some Molluscs</i>	248

a. Cephalopoda

SHŪJI, RINOSUKE— <i>Luminescence of <i>Watasenia scintillans</i></i>	34
POLIMANTI, O.— <i>Colour-sense in Octopus</i>	248

γ. Gastropoda.

CROZIER, W. J., & L. B. ABEY— <i>Sensory Reactions of <i>Chromodoris zebra</i></i>	34
" " — <i>Coloration of <i>Chromodoris zebra</i></i>	34
GATENBY, J. BRONTÉ— <i>Dimorphic Spermatozoa in <i>Paludina vivipara</i></i>	135
" " — <i>Germinal Nurse-cells of <i>Testacella</i></i>	136
" " — <i>Gametogenesis and Early Development of <i>Limnæa stagnalis</i></i>	136
CROZIER, W. J.— <i>Sensitiveness of Gill-plumes of <i>Chromodoris zebra</i></i>	248
" " — <i>Assortive Mating in Nudibranchs</i>	249
GOULD, HARLEY N.— <i>Sex-changes in <i>Crepidula planu</i></i>	249

	PAGE
GATENBY, J. BRONTÉ— <i>Spermatogenesis of Pulmonate Gastropods</i>	341
COLOSI, GIUSEPPE— <i>Notes on Thecosomatous Pteropods</i>	342
FARNIE, WINIFRED C.— <i>Structure of Amphibola crenata</i> (1 fig.)	342
GOULD, HARLEY N.— <i>Sex Phenomena in Crepidula plana</i>	343
BOYCOTT, A. E.— <i>Parthenogenesis in Paludestrina jenkinsi</i>	343
WATSON, HUGH— <i>Notes on Hygromia limbata</i> (Drap.)	343

Arthropoda.

SWINNERTON, H. H.— <i>Facial Suture of Trilobites</i>	34
---	----

a. Insecta.

STANDFUSS, R.— <i>Male Genital Apparatus in Lepidoptera</i>	35
REVERDIN, L.— <i>Accessory Genital Parts in Lepidoptera</i>	35
MCINDOO, N. E.— <i>Olfactory Sense of Lepidopterous Larvæ</i>	35
DOLLEY, W. L., JUN.— <i>Effect of Light on Vanessa antiopi</i>	35
WHEELER, W. M.— <i>Australian Ants of Genus Onychomyrma</i>	36
GRAHAM-SMITH, G. S.— <i>Hibernation of Flies</i>	36
MORGAN, T. H.— <i>Gynandromorphism in Drosophila</i>	36
BRIDGES, C. B.— <i>Chromosome Dislocation</i>	36
SIMPSON, J. J.— <i>Bionomics of Tsetse Flies</i>	36
CLAUSEN, CURTIS P.— <i>Life-histories of Californian Coccinellids</i>	37
PEACOCK, A. D.— <i>Mouth-parts and Mode of Feeding in Louse</i>	37
NUTTALL, GEORGE H. F.— <i>Biology of Lice</i>	37
MOSHER, EDNA— <i>Pupæ of Notodontoidea</i>	38
MCINDOO, N. E.— <i>Olfactory Organs of Orthoptera</i>	38
CHOPARD, L.— <i>Hermaphrodite Specimen of a Plasmid</i>	38
NAKAHARA, WARO— <i>Structure of Oocytes of Stone-fly</i>	38
BUGNION, E.— <i>New Ceylonese Termite</i>	38
" — <i>Termitoxenia</i>	39
HUIE, L. H.— <i>Germ-band in Holly Tortrix Moth</i>	136
MOSHER, EDNA— <i>Pupæ of Sphingidæ</i>	137
HARDENBERG, C. B.— <i>South African Bagworms</i>	137
BROCHER, FRANK— <i>Pulsatile Tergal Organ in Lepidoptera</i>	137
FOÁ, A.— <i>Intestinal Epithelium of Silkworm</i>	138
MUIR, FREDERICK— <i>Male Genital Tube in Coleoptera</i>	138
FROGGATT, JOHN L.— <i>Spiracles of some Muscid Larvæ</i>	138
HADWEN, S., & A. E. CAMERON— <i>Bot-Flies</i>	138
KUNKEL, B. W.— <i>Effect of a Diet of Ductless Glands on Development of Flesh-flies</i>	139
WOLLMAN, E.— <i>Development of Maggots in Sterilized Tissue</i>	139
RICHET, CHARLES— <i>Note on Nutritive Value of Sterilized Food</i>	139
ALLEE, W. C., & E. R. STEIN, JUN.— <i>Light Reactions of May-fly Nymphs</i>	139
HAVILAND, MAUD D.— <i>Life-history of Red-currant Aphis</i>	140
FULLER, CLAUDE— <i>Wings and Tracheæ of Termites</i>	140
MOHR, OTTO L.— <i>Chromatin Maturation in Spermatogenesis of Locusta ciridissima</i>	141
HILGENDORF, F. W.— <i>Insect Life of New Zealand Mountain Station</i>	141
KANNAN, K. KUNHI— <i>Mutation in Coccidæ</i>	141
GREEN, E. ERNEST— <i>As regards Mutation in Coccidæ</i>	142
BUGNION, E.— <i>Study of Cockroach Head</i> (1 fig.)	142
ROBERTS, ELMER— <i>Vestigial Wing in Drosophila ampelophila</i>	249
BRIDGES, CALVIN B.— <i>Purple Eye in Drosophila</i>	250

	PAGE
GALLARDO, A.— <i>Myrmecophilous Beetle</i>	250
BUDER, J. E.— <i>Spermatogenesis in Deilephila euphorbiæ</i>	250
SZYMANSKI, J. S.— <i>So-called Hynopsis in Cockroach</i>	250
VOINOV, D.— <i>Mitochondrial Changes in Spermatogenesis</i>	251
" — <i>Peculiar Occurrence in Spermatogenesis of Gryllotalpa</i>	251
JORDAN, H. E.— <i>Striped Muscle of Mantis</i>	251
HANDSCHIN, ED.— <i>Collembola of the Snow Level</i>	251
GATENBY, J. BRONTÉ— <i>Segregation of Germ-cells in Trichogramma evanescens</i>	343
" " — <i>Polyembryony in Parasitic Hymenoptera</i>	344
IMMS, A. D.— <i>Insect Parasites of some Coccidæ</i>	345
CARTER, LUCY A.— <i>Somatic Mitosis of Stegomyia fasciata</i>	346
YERBURY, J. W.— <i>Seashore Diptera</i>	346
RODMAN, G. H.— <i>Lecture on Fleas</i>	346
ISAAK, I.— <i>Luminescence in Tiger-moth</i>	347
VAN BEMMELLEN, J. F.— <i>Wing-markings of Spingulix</i>	347
WHITING, P. W.— <i>Genetic Studies on Mediterranean Flour-moth</i>	347
DAVEY, WHEELER P.— <i>X-rays and Beetles</i>	348
STÄGER, ROB.— <i>Behaviour of Tiger-beetle Larva</i>	348
BRIDGES, CALVIN B.— <i>Eye-colour in Drosophila melanogaster</i>	348
TEODORO, G.— <i>Lecanium persicæ and its Symbiotic Yeasts</i>	348
FRIEDERICHS— <i>Counteracting Insects by Fungi</i>	348
MORGENTHAUER, O.— <i>Bee Diseases</i>	349
HART, CHARLES ARTHUR— <i>Nearctic Pentatomoidea</i>	349
BAUMBERGER, J. PERCY— <i>Yeasts and Insects</i>	349
WENRICH, D. H.— <i>Individuality of Chromosomes, with Special Reference to Synaptic Phase</i>	349

β. Myriopoda.

RABAUD, E.— <i>Food of a Millipede</i>	39
CHAMBERLIN, RALPH V.— <i>Lithobiid Genera</i>	39
BRÖLEMAN, HENRY W., & JEAN L. LICHTENSTEIN— <i>Vulvæ of Diplopora</i>	143

γ. Onychophora.

GLEN, EDITH H.— <i>Early Development of Peripatus capensis</i>	350
--	-----

δ. Arachnida.

BILLIARD, G.— <i>Mites in Culture Tubes</i>	39
BODKIN, G. E.— <i>Study of Amblyomma dissimile Koch</i>	39
PATTEN, BRADLEY M.— <i>Reactions of Whip Scorpions</i>	40
RABAUD, E.— <i>Colour Adaptation in Spiders</i>	40
WALTER, C.— <i>Water-mites from Peru and Brazil (1 fig.)</i>	143
FAGE, LOUIS— <i>Cavernicolous Spiders</i>	143
BERLESE, A.— <i>A Hundred New Mites</i>	350
NUKADA, S.— <i>Heart of Limulus</i>	350

ε. Crustacea.

MÜLLER, R. T.— <i>Study of Tunymastix lucinæ Guérin</i>	40
BANTA, ARTHUR M.— <i>Rarity of Sex Intergrades in Cladocera</i>	40

	PAGE
VAULX, R. DE LA— <i>Gynandromorph Daphnids</i>	40
SOUTHWELL, T., & B. PRASHAD— <i>New Parasitic Copepods</i>	41
LEIGH-SHARP, W. HAROLD— <i>New Copepod Parasite of Cod</i>	41
" " — <i>New Species of Lernæopoda</i>	41
BYRNES, ESTHER F.— <i>Life-history of Cyclops</i>	41
BROCH, HJALMAR— <i>Structure of Barnacles</i>	144
COLLINGE, WALTER E.— <i>New Isopod of Natal</i>	144
CAULLERY, M., & F. MESNIL— <i>Development of Testes in Parasitic Copepod</i>	144
KESTEVEN, H. LEIGHTON— <i>Yolk-formation in Copepod Ovum</i> (2 figs.)	145
HERBST, CURT, & H. PLESSNER— <i>Nerves of Antennules Regenerated in Place of Eyes</i>	252
CHILTON, CHARLES— <i>Ceina egregia: an Aberrant Amphipod</i> (2 figs.)	252
" " — <i>Redescription of Orchestia tucurama Fritz Müller</i>	253
ABBOTT, CHARLES H.— <i>Reactions of Land Isopods to Light</i>	253
HARTMANN, OTTO— <i>Influence of Environment on Bosmina longirostris</i>	254
ESTERLY, CALVIN O.— <i>Food of Pelagic Copepods</i>	254
HARVEY, E. NEWTON— <i>Light-production in Cypridina hilgendorfi</i>	254
CHAPMAN, FREDERICK— <i>Upper Cambrian Ostracods</i>	254
RAFF, JANET W.— <i>Abnormality in Australian Crayfish</i>	350
COLOSI, G.— <i>New Species of Meganyctiphanes</i>	351
CHILTON, CHAS.— <i>Boring Crustacea in New Zealand</i> (2 figs.)	351
WEBB, GLADYS E.— <i>Development of Species of Upogebia</i>	352
CHILTON, CHAS.— <i>Genus Phreatogammarus</i>	352

Annulata.

SMITH, F., & I. B. DICKEY— <i>New Species of Rhynchelmis</i>	41
SMITH, FRANK— <i>New North American Species of Haplotaxis</i>	42
KINDRED, JAMES E.— <i>North American Representative of Trichodrilus</i>	42
RIOJA, ENRIQUE— <i>Polychæta of Northern Coasts of Spain</i>	146
FAUVEL, P.— <i>Intervalary Growth in a Maldanian Worm</i>	146
SCHMIDT, PETER— <i>Anabiosis in Earthworms</i>	146
PIGUET, EMILE— <i>Oligochæts of the High Alps</i>	147
LOHNER, L.— <i>Taste in Leeches</i>	255
CHAPMAN, FREDERICK— <i>Fossil Polychæts</i>	352
SOULIER, A.— <i>Early Development of Protula meilhaci</i>	352

Bryozoa.

CANU, F., & RAY S. BASSLER— <i>Fossil Bryozoa of Panama Canal Zone</i>	42
--	----

Nematohelminthes.

WHARTON, L. D.— <i>Nematode Parasite of Chicken</i>	42
RANSOM, B. H., & W. D. FOSTER— <i>Life-history of Ascaris lumbricoides</i>	42
SHEATHER, A. L.— <i>New Nematode in Calves</i>	147
CLEVE, H. J. VAN— <i>Study of Acanthocephala</i> (1 fig.)	353
MAGATH, THOMAS BYRD— <i>Study of a Nematode</i>	353

Platyhelminthes.

CAULLERY, M., & F. MESNIL— <i>Parasitic Rhabdocæl</i> (1 fig.)	43
ACKERT, JAMES E.— <i>Transmission of Fowl Tapeworms</i>	43

	PAGE
SOUTHWELL, T., & B. PRASHAD— <i>Fish Trematodes</i>	43
PRATT, H. S.— <i>Cuticula and Sub-cuticula of Trematodes and Cestodes</i>	44
CAWSTON, F. G.— <i>Cercariæ of Transvaal</i>	44
" " — <i>Bilharziasis in Natal</i>	44
BLANC, H.— <i>Remarkable Case of Echinococcus in Lemur</i>	147
SOUTHWELL, T., & BAINI PRASHAD— <i>Methods of Reproduction in Cestodes</i>	147
PRENANT, MARCEL— <i>Rhabdites of Turbellaria</i>	148
KEPNER, W. A.— <i>Reactions of Proboscis of Planaria albissima</i>	148
HYMAN, L. H.— <i>Action of Potassium Cyanide in Planaria</i>	255
CHILD, C. M.— <i>Effects of Cyanides on Planaria dorotocephala</i>	255
YERI, M., & T. KABURAKI— <i>Japanese Polyclads</i>	255
FURHMANN, O.— <i>Tapeworms of Vertebrates</i>	354
ALLEN, G. D.— <i>Respiratory Metabolism in Planaria</i>	354
CHILD, C. M.— <i>Carbon Dioxide Production in Starving Planaria</i>	354
" " — <i>Susceptibility to Lack of Oxygen during Starvation in Planaria</i>	355
HYMAN, L. H.— <i>Oxygen Consumption in Feeding and Starving Planaria</i>	355
ALLEN, G. D.— <i>Respiratory Metabolism in Planaria</i>	355

Incertæ Sedis.

CORDERO, E. H.— <i>Notes on Gastrotricha (Figs. 1, 2)</i>	44
GILCHRIST, J. D. F.— <i>Transverse Fission in Phoronopsis</i>	148

Rotatoria.

SHULL, A. FRANKLIN— <i>Sex Determination in Hydatina</i>	149
WHITNEY, DAVID D.— <i>Oxygen and Sex-determination in Rotifers</i>	356

Echinoderma.

CROZIER, W. J.— <i>Asexual Multiplication in Coscinasterias tenuispina</i>	45
WOODWARD, AVALYN E.— <i>Egg Secretion in Echinoderms</i>	149
GEMMILL, JAMES F.— <i>Rhythmic Pulsation in Madreporic Vesicle of Young Ophiuroids</i>	150
CROZIER, W. J.— <i>Bottom Material Ingested by Holothurians</i>	150
KOEHLER, O.— <i>Hybridization Experiments with Sea-Urchins</i>	256
MACBRIDE, E. W.— <i>Development of Heart-Urchin</i>	356

Cœlentera.

MOLANDER, ARVID R.— <i>Significance of Calyx in Acoyonaacea</i>	150
" " — <i>Membranous Forms of Colonies in Gorgonaacea</i>	151
STEPHENSON, T. A.— <i>Irish Actiniaria</i>	151
MOLANDER, ARVID R.— <i>Discussion of Leptogorgia irramosa (Grieg)</i>	151
PARKER, G. H.— <i>Study of Renilla</i>	151
WARREN, ERNEST— <i>Pigment of Hydroids (2 figs.)</i>	152
" " — <i>Structure of New South African Hydroid</i>	153
BILLARD, ARMAND— <i>New Species of Sertularella</i>	153
BROCH, HJALMAR— <i>Cœlentera of Gunnerus</i>	153
GILCHRIST, J. D. F.— <i>Species of Crawling Medusa from the Cape</i>	153
GARCIA-BANUS, MARIO— <i>Is there a Metabolic Gradient in Tubularia?</i>	256
DAVIS, DONALD WALTON— <i>Asexual Multiplication and Regeneration in Sagartia luciae</i>	256

	PAGE
LIGHTBOWN, CONSTANCE M.— <i>Dorsal Mesenteric Filaments of Siphonozooids of Pennatulacea</i>	257
THOMSON, J. STUART— <i>Note on Cavernularia litkenii</i>	257
MAYER, ALFRED GOLDSBOROUGH— <i>Nerve-conduction in Jellyfish</i>	257
GARMAN, HARRISON— <i>Swarms of Fresh-water Medusoids</i>	257
CHAPMAN, FREDERICK— <i>Palæozoic Victorian Hydroids</i>	357
BALE, W. M.— <i>Australian Hydroids</i>	357
MAYER, A. G.— <i>Growth of Coral Reefs</i>	358
HICKSON, S. J.— <i>Corals of Pacific Coast of Canada</i>	358
CARY, LEWIS R.— <i>Respiration Rates of Samoan Alcyonarians</i>	358

Porifera.

CROZIER, W. J., & BLANCHE B. CROZIER— <i>Buds in Sponges</i>	45
HERNÁNDEZ, F. F.— <i>New Sponges from Spain</i>	45
TRIGT, A. VAN— <i>Study of Fresh-water Sponges</i> (3 figs.)	154

Protozoa.

HAUGHWOUT, F. G.— <i>Protozoa of Manila</i>	46
HEGNER, R. W.— <i>Variations in Arcella</i> (1 fig.)	46
MACCARDY, H. M.— <i>Nuclear Re-organization in Arcella</i>	46
SCHAEFFER, A. A.— <i>Excretion Crystals in Amœba</i>	47
CUTLER, D. WARD— <i>Entamœba histolytica</i>	47
LUND, E. J.— <i>Respiration in Paramecium</i>	47
COLFS, A. C.— <i>Spirochæte of Infectious Jaundice in English Rats</i>	47
YAKIMOFF, W. L., & OTHERS— <i>Trypanosomiasis of Camels</i>	47
SOUTHWELL, T., & B. PRASHAD— <i>Indian Myxosporidia</i>	47
DUROSCQ, O.— <i>Selysina perforans</i> Dub.	48
DOBELL, CLIFFORD— <i>Coccidia Parasitic in Man</i>	48
CUSHMAN, J. A.— <i>Fossil Foraminifera from Panama</i>	48
PLAYFAIR, G. I.— <i>Fresh-water Rhizopoda of Sydney and Lismore, N.S.W.</i> (figs. 1-3)	48
CORDERO, ERGASTO H.— <i>Ciliate Protozoa from Uruguay</i>	49
CHAPMAN, FREDERICK— <i>Deronian Foraminifera</i>	50
WALTON, L. B.— <i>Axial Rotation of Aquatic Micro-organisms</i> (? figs.)	156
WAILES, G. H.— <i>British Fresh-water Rhizopods</i>	157
DEHORNE, ARMAND— <i>Crystalloids of Entamœba</i>	157
MAST, S. O.— <i>Reversion of Orientation to Light in Spondylomorun quaternarum</i> ..	157
CUTLER, D. WARD— <i>Remarkable Flagellate from Hind-gut of Termite</i>	157
CHATTON, EDOUARD, & CH. PÉRARD— <i>Ciliata from Intestine of the Gondi</i>	157
GOETTE, A.— <i>Life-cycle of Didymia</i>	258
SONDHEIM, MARIA— <i>Feeding in Sun Animalcule</i>	258
MENDEL, J.— <i>Buccal Amœbæ</i>	258
PASCHER, A.— <i>New Amœbæ</i>	258
DÖFLEIN, F.— <i>Pyxidicula operculata</i>	258
CAIKINS, GARY N.— <i>Nuclei of Uroleptus mobilis</i>	259
PECKER, SOPHIE— <i>Influence of Blood-serum on Colpidium colpoda</i>	259
PROWAZEK, S. V.— <i>Races of Colpidium colpoda</i>	259
PASCHER, A.— <i>Amœboid Variations in Flagellates</i>	259
MAST, S. O.— <i>Orientation in Volvox and Pandorina</i>	260

	PAGE
PASCHER, A.— <i>Pseudopodial Network for Food-Catching in a Chryomonad</i>	260
„ — <i>Crossing of Two Species of Chlamydomonas</i>	260
SCHUCHERT, CHARLES, & OTHERS— <i>Beatricea not a Gigantic Foraminifer</i>	260
CUSHMAN, J. A., & OTHERS— <i>Fossil Foraminifera of the Canal Zone, Panama</i> ..	261
ALEXEIEFF, A.— <i>New Coprozoic Flagellate</i> (1 fig.)	359
KOFOID, CHARLES ATWOOD, & OLIVE SWEZY— <i>Peculiar Polymastigote Flagellate</i> (2 figs.)	360
„ „ „ „ — <i>New Species of Trichonympha</i> (2 figs.)	363
„ „ „ „ — <i>New Trichonymphid</i> (2 figs.) ..	364
„ „ „ „ — <i>New Species of Trichomitus</i> ..	365
REICHENOW, ED.— <i>Flagellate of Lizard found also in Tick</i>	365
CARTER, LUCY A.— <i>Amœba Proteus</i>	366
ZALUETA, A. DE— <i>Promitosis and Syndiæresis: two Methods of Nuclear Division</i> <i>co-existing in Amœbæ of the "Limax" Group</i>	366

Miscellanea.

GALLOWAY, J. J.— <i>The Rounding of Grains of Sand by Solution</i> .. .	262
---	-----

BOTANY.

GENERAL,

Including the Anatomy and Physiology of Seed Plants.

Cytology,

Including Cell-Contents.

GUILLIERMOND, A.— <i>Significance of the Chondriome</i>	51
JONES, D. F.— <i>Heterosis and Double Fertilization</i>	51

Structure and Development.

Vegetative.

LANGDON, L. M.— <i>Ray-System of Quercus</i>	52
DUFRENOY, J.— <i>Significance and History of Pine-needles</i>	159
RECORD, S. J.— <i>Significance of Resinous Tracheids</i>	159
BRIQUET, J.— <i>Flower and Fruit of Diaperia</i>	160
BLISS, M. C.— <i>Interrelationships of the Taxineæ</i>	160
COLLINS, MARJORIE J.— <i>Leaf-Anatomy of Scævola crassifolia, with Special Reference</i> <i>to the Epidermal Secretion</i>	263
RECORD, S. J.— <i>Storied or Tier-like Structure of certain Dicotyledonous Woods</i> ..	263
BAKER, R. T.— <i>Technology and Anatomy of some Silky Oak Timbers</i>	264
DIXON, HENRY H.— <i>Mahogany and the Recognition of some of the Different Kinds</i> <i>by their Microscopic Characters</i>	264
HARVEY, R. B.— <i>Importance of Epidermal Coverings</i>	367

BAILEY, J. W.— <i>Depressed Segments of Oak Stems</i>	367
ALVARADO, SALUSTIO— <i>Detailed Structure of Wood-cessels (1 fig.)</i> [Advance note.]	367
URCELAY, INAN CUESTA— <i>Anatomy of the Leaf of Lactuca saligna Linn. (1 fig.)</i>	368
LAWRENCE-BALLS, W.— <i>The Existence of Daily Growth-rings in the Cell-wall of Cotton Hairs (1 fig.)</i>	369

Reproductive.

EVANS, ARTHUR— <i>Embryo-sac and Embryo of Penstemon secundiflorus</i>	265
DOYLE, JOSEPH— <i>Observations on the Morphology of Larix leptolepis</i>	265
JOHNSON, D. S.— <i>Fruit of Opuntia</i>	370
SOUÈGES, R.— <i>Embryogeny of Capsella</i>	370

General.

RAUNKLER, C.— <i>Statistical Investigations on Plant Formations</i>	52
„ — <i>Relative Number of Male and Female Plants in Ramex</i>	161
BERRY, ED. W.— <i>Fossil Higher Plants from the Canal Zone</i>	266
MOSHER, EDNA— <i>Grasses of Illinois</i>	266
CRAIB, WM. G.— <i>Regional Spread of Moisture in the Wood of Trees</i>	266

CRYPTOGAMS.

Pteridophyta.

BENSON, MARGARET J.— <i>Mazocarpon, or the Structure of Sigillariostrobus</i>	53
SPESSARD, EARLE AUGUSTUS— <i>Prothallia of Lycopodium in America</i>	54
OSBORN, T. G. B.— <i>Habitat and Mode of Occurrence in South Australia of two Genera of Lycopods unrecorded for the State</i>	54
DARNELL-SMITH, G. P.— <i>Gametophyte of Psilotum</i>	54
LAWSON, A. ANSTRUTHER— <i>Gametophyte Generation of the Psilotaceæ</i>	54
BERRY, EDWARD W.— <i>Notes on the Fern Genus Clathropteris</i>	55
THOMPSON, JOHN MACLEAN— <i>Further Contribution to the Knowledge of Platyzoma microphyllum R.Br.</i>	55
„ „ — <i>Anatomy and Affinity of Stromatopteris moniliformis Mett.</i>	56
BROWN, ELIZABETH WUIST— <i>Regeneration in Phegopteris polyodioides</i>	56
STIEL, W. N.— <i>New Cases of Apogamy in Ferns</i>	56
CAPELLE, G.— <i>Botanical Observations on Various Plants</i>	57
STIEL, W. N.— <i>Apospory in Pteris sulcata L.</i>	161
HAYATA, BENZO— <i>Protomarattia, a New Genus of Marattiaceæ, and Archangiopteris</i>	161
LEONARD, ELIZABETH J.— <i>Genus Tænitis, with some Notes on the remaining Tænitidinæ</i>	162
ROSENDAHL, H. V.— <i>Collections of Madagascar Ferns</i>	162
„ „ — <i>Species and Forms of Equisetum in Sweden</i>	162
ESELTINE, G. P. VAN— <i>Allies of Selaginella rupestris in S.E. United States</i>	162
SAHNI, B.— <i>Australian Specimen of Ctespydropsis</i>	267
BASSLER, HARVEY— <i>Sporangiophoric Lepidophyte from the Carboniferous</i>	267
DIGBY, L.— <i>Archesporeal and Meiotic Mitoses of Osmunda</i>	268
STIEL, W. N.— <i>Study of Apogamy in Niphrodium hirtipes Hook</i>	268
PHILLIPS, R. W.— <i>Duration of Prothallia of Lustræa Felix-mus</i>	269

	PAGE
HIERONYMUS, G.— <i>Contributions to a Knowledge of the Genus Pteris</i>	269
RICHTER, ALADAR— <i>New Schizæa from Borneo (S. Hallieri)</i>	269
STOKEY, ALMA G.— <i>Apogamy in the Cyathecæ</i>	371
OSBORN, T. G. B.— <i>Observations on the Tuber of Phylloglossum</i>	371
HILL, J. BEN— <i>Anatomy of Lycopodium reflexum</i>	372
STEHL, W. N.— <i>Method of staining Antherozoid of Fern</i>	372
SIDI, T. R.— <i>Ferns of South Africa</i>	372

Bryophyta.

GOEBEL, K.— <i>Organography of Plants</i>	57
EVANS, ALEXANDER W.— <i>Air Chambers of Grimaldiifragrans</i>	58
DOUIN, CH.— <i>Mixtures of Species among the Cephalozellucæ</i>	58
WATSON, W.— <i>Sphagna, their Habitats, Adaptations and Associates</i>	59
SMITH, GILBERT MORGAN— <i>Cell-Structure and Autospore Formation in Tetradron minimum</i>	59
TODA, Y.— <i>Studies on Schistostega osmundacea</i>	59
DIXON, H. N.— <i>Mosses Collected by the Smithsonian African Expedition</i>	60
HAUPT, ARTHUR W.— <i>Morphological Study of Pallavicinia Lyellii</i>	163
EVANS, ALEXANDER W.— <i>Taxonomic Study of Dumortiera</i>	163
.. .. — <i>American Species of Marchantia</i>	163
.. .. — <i>Noteworthy Lejeuneæ from Florida</i>	161
.. .. — <i>Notes on New England Hepaticæ</i>	164
.. .. — <i>Hepaticæ of St. Croix, St. Jan, St. Thomas, and Tortola</i>	164
FRYE, T. C.— <i>Illustrated Key to the Western Sphagnaceæ</i>	164
SKENE, M.— <i>Acidity of Sphagnum and its Relation to Chalk and Mineral Salts</i>	164
ROELL, J.— <i>Sphagna and Mosses of Thüringen</i>	164
WARNSTORF, C.— <i>Vegetative Increase of Pterogynandrum filiforme (Timm) Hedw.</i>	165
GYÖRFFY, I.— <i>Histology of Ephemeroopsis tjbodensis Goebel</i>	165
BROTHERUS, V. F.— <i>Moseniella: a New Moss Genus from Brazil</i>	165
ARNELL, H. W., & C. JENSEN— <i>Bryum vermigerum</i>	165
COKER, DOROTHY— <i>Revision of the North American Species of Eucalypta</i>	166
HERZOG, T.— <i>Two Cleistocarpic Mosses of the Bolivian High Cordilleras</i>	166
MÖLLER, H.— <i>Moss Distribution in Sweden</i>	166
ARNELL, H. W.— <i>Mosses of the "Vega" Expedition</i>	166
DIXON, H. N.— <i>Uganda Mosses</i>	167
RECHINGER, K.— <i>Mosses and Ferns from the Pacific</i>	167
BROTHERUS, V. F.— <i>Contributions to the Moss-flora of the Argentine</i>	167
CAMPBELL, D. H.— <i>Studies on some East Indian Hepaticæ</i>	270
KASHYAP, S. R.— <i>Andræcium in Plagiochasma appendiculatum L. et L. and P. articulatum Kashyap</i>	270
SCHILBERSZKY, K.— <i>New Moss from the Pleistocene of Keesketmet, Hungary</i>	270
WILLIAMS, R. S.— <i>Genus Desmatodon in North America</i>	271
BROTHERUS, V. F., & W. WALTER— <i>Mosses of North Queensland</i>	271
MOSS EXCHANGE CLUB	271
CRIBBS, J. E.— <i>Columella in Marchantia polymorpha</i>	372
VON DANKENSCHWEIL, H. W.— <i>Contribution to the Anatomy of Mosses</i>	373
BUCH, H.— <i>Scapania curta and its Allies</i>	374
MEYLAN, CH.— <i>Desmatodon Wilczekii</i>	374
WHELDON, J. A.— <i>Notes on Braithwaite's "Sphagnaceæ Exsiccatae"</i>	374
DIXON, H. N.— <i>Miscellaneous Bryologica</i>	374

Thallophyta.

Algæ.

	PAGE
HATTORI, H.— <i>Microbiological Researches on some Japanese Water-supplies</i>	60
NAKANO, H.— <i>Researches on the Development and Nutrition of some Chlorophyceæ</i>	61
MOORE, G. T.— <i>A Wood-penetrating Alga, Gomontia hincicola sp. n.</i>	61
YABE, H.— <i>Notes on a Carpenteria-Limestone from B. N. Borneo</i>	61
FRYE, T. C.— <i>Age of Pterygophora californica</i>	61
WALTON, L. B.— <i>Axial Rotation of Aquatic Micro-organisms and its Significance</i> ..	167
PASCHER, A.— <i>Undulating Marginal Cilia in a Green Flagellate</i>	168
GOOR, A. J. C. VAN— <i>Noctiluca miliaris Sur.: A Cytological Investigation</i>	168
STILES, M. H.— <i>Diatom Flora of Martin Beck, Yorks</i>	168
FONTELL, C. W.— <i>Fresh-water Diatoms from Upper Jämtland in Sweden</i>	168
FRITSCH, F. E.— <i>Contributions to our Knowledge of the Fresh-water Algæ of Africa.</i>	
I. <i>Some Fresh-water Algæ from Madagascar</i>	169
RECHINGER, K.— <i>Marine Diatoms from the Pacific</i>	169
MANN, ALBERT— <i>Economic Importance of Diatoms</i>	169
WALTON, L. B.— <i>Eutetramorus globosus: a New Genus and Species of Algæ belonging to the Protococcoidea (Family Cœlastridæ)</i>	169
ELENKIN, A. A.— <i>Interesting Case of the Formation of certain Vacuoles at the Ends of the Cells in the Desmid Closterium plurilocellatum</i>	170
" " — <i>Two Green Algæ from the Genus Stigeoclonium Kütz</i>	170
COLLINS, F. S.— <i>Notes from the Woods Hole Laboratory</i>	170
BROWN, J. G.— <i>Abnormal Conjugation in Spirogyra</i>	171
CUNNINGHAM, BERT— <i>Cross-conjugation in Spirogyra Weberi</i>	171
KYLIN, HARALD— <i>Germination of the Spores of Floridæ</i>	171
SETCHELL, W. A.— <i>Parasitism among the Red Algæ</i>	172
NARITA, SEIICHI— <i>Enumeratio Specierum Nematosis et Helminthocladidæ Japonicæ</i>	173
MAZZA, ANGELO— <i>Oceanic Algylogy</i>	173
LYLE, LILIAN— <i>Developmental Forms of Marine Algæ</i>	173
BÖRGESEN, F.— <i>Marine Algæ of the Danish West Indies</i>	174
LUCAS, A. H. S.— <i>Algæ of Commonwealth Bay</i>	174
SALLER— <i>Seaweed as Raw Material for Industry</i>	174
CHURCH, A. H.— <i>Building of an Autotrophic Flagellate</i>	271
JANET, CHARLES— <i>Phylogenesis of the Orthobiont</i>	271
ELLINGER, T.— <i>Protozoa (Fauna Groenlandica. VIII.)</i>	272
CARTER, NELLIE— <i>Trachelomonas inconstans: a New Flagellate</i>	272
" " — <i>Cytology of Two Species of Characiopsis</i>	272
BAUDIN, L.— <i>Vertical Distribution of Plankton in the Lake of Geneva</i>	272
OSTENFELD, C. H.— <i>Bacillariales</i>	273
" " — <i>Schizophyceæ</i>	273
BRACHER, ROSE— <i>Observations on Euglena deses</i>	274
CARTER, NELLIE— <i>Studies on the Chloroplasts of Desmids. I.</i>	274
" " — <i>Studies on the Chloroplasts of Desmids. II.</i>	274
LOBK, A. J.— <i>List of Desmidiaceæ collected during the Summer of 1913 in the Government of Ufa</i>	275
LECHMERE, A. ECKLEY— <i>Epiphyllie Ulothrix</i>	275
BRISTOL, MURIEL B.— <i>Retention of Vitality by Algæ from old Stored Soils</i>	276
" " — <i>Malay Form of Chlorococcum humicola (Näg.) Rabenh.</i>	276
KUFFERAETH, H.— <i>Contribution to the Algal Flora of South Luxembourg</i>	276
PLAYFAIR, G. I.— <i>New and Rare Fresh-water Algæ</i>	277

	PAGE
FRITSCH, F. E.— <i>Fresh-water Algæ of Africa</i>	277
COLLINS, F. S.— <i>Green Algæ of North America: Second Supplement</i>	277
" "— <i>Working Key to the Genera of North American Algæ</i>	277
GARDNER, N. L.— <i>New Pacific Coast Marine Algæ</i>	278
WOLFE, J. J.— <i>Alternation and Parthenogenesis in Padina</i>	278
CLELAND, RALPH E.— <i>Cytology and Life-history of Nemalion multifidum Ag.</i> ..	278
COTTON, A. D.— <i>Distribution of certain British Algæ</i>	279
" "— <i>Japanese Seaweed, Tosaka Nori</i>	280
LUCAS, A. H. S.— <i>Notes on Australian Marine Algæ</i>	280
KYLIN, H., & C. SKOTTSBERG — <i>Sub-Antarctic and Antarctic Marine Algæ.</i> <i>II.: Rhodophyceæ</i>	280
HOWE, MARSHALL A.— <i>Calcareous Algæ from Murray Island, Australia, and Cocos-Keeling Islands</i>	280
CHURCH, A. H.— <i>Plankton-phase and Plankton-rate</i>	375
SCHRÖDER, B.— <i>Melosira Ræseana Rabenh., a Luminous Diatom</i>	375
SCHUSSNIG, B.— <i>Remarks on certain Adriatic Plankton Bacillariæ</i>	375
QUELLE— <i>Remarks on the Bacillariaceæ of the Numburg Stream</i>	375
LACSNY, J. I.— <i>Bacillariaceæ of the Streams near Nagyrárad</i>	376
PETERSEN, J. B.— <i>Studies of Danish Aerophilous Algæ</i>	376
SCHUSSNIG, B.— <i>On some New and Rare Chlorophyceæ of the Adriatic</i>	376
CARTER, NELLIE— <i>Cytology of the Cladophoraceæ</i>	377
BULLOCK-WEBSTER, G. R.— <i>New Nitella</i>	377
GROVES, J., & G. R. BULLOCK-WEBSTER— <i>Chara fragilis and C. delicatula</i>	377
GROVES, J.— <i>Notes on Lychnothamnus</i>	377
HOWE, M. A.— <i>On some Fossil and Recent Lithothamniceæ of the Panama Canal Zone</i>	378
CHURCH, A. H.— <i>Historical Review of the Floridææ</i>	378
GRUNOW, A.— <i>Additions to our Knowledge of Sargassum</i>	378
CHURCH, A. H.— <i>Phæophycean Zoïd</i>	378
" "— <i>Historical Review of the Phæophyceæ</i>	379

Fungi.

ERIKSSON, JAKOB— <i>Study of Phytophthora infestans</i>	62
KUSANO, S.— <i>Life-History and Cytology of Olpidium</i>	62
RHOADS, ARTHUR S.— <i>Daldinia vernicosa</i>	62
DURAND, E. J.— <i>Peziza proteana var. sparassoides in America</i>	62
GROVE, W. B.— <i>British Species of Melanconium</i>	62
" "— <i>New or Noteworthy Fungi</i>	63
STONE, R. E.— <i>Incubation Period of Cronartium ribicola on the White Pine</i>	63
CRUCHET, PAUL— <i>Contribution to the Study of Uredineæ</i>	63
ARTHUR, J. C., & G. R. BISBY— <i>Rusts of North America</i>	63
DOSDALL, LOUISE— <i>Overwintering of Ascospores of Cronartium ribicola</i>	63
RHOADS, ARTHUR S., & OTHERS— <i>Host Relationship of the North American Rusts, other than Gymnosporangium, which attack Conifers</i>	63
WEIR, J. R., & E. E. HUBERT— <i>Melampsora Cultures</i>	64
JACKSON, H. S.— <i>Puccinia on Carduaceæ</i>	64
ARTHUR, J. C.— <i>Study of the Genus Kuehneola</i>	64
DODGE, B. D.— <i>Study of Gymnosporangium</i>	64
ELLIOTT, J. S. BATLISS— <i>Hyphomyces</i>	64
SMITH, A. LORRAIN— <i>Hyphomyces and the Rotting of Timber</i>	64
RATHBURN, ANNIE E.— <i>Fungus Flora of Pine Seed-beds</i>	65

	PAGE
BRIERLEY, W. B.— <i>Polymorphism of Botrytis cinerea</i>	65
CLELAND, J. BURTON, & EDWIN CHEEL— <i>Notes on Australian Fungi N. IV.</i> ..	65
PEARSON, A. A.— <i>Two-spored Basidia</i>	65
REA, CARLETON— <i>British Mycology</i>	65
FAULL, J. H.— <i>Fomes officinalis, a Timber-destroying Fungus</i>	65
HORNE, A. S.— <i>Fungi on Aleurodes raporum</i>	66
GÜSSOW, H. T.— <i>Empusa Muscæ on Musca domestica</i>	66
BRIERLEY, W. B.— <i>Cell-regeneration in Botrytis cinerea</i>	66
MURRILL, W. A.— <i>Illustrations of Fungi</i>	66
HARPER, EDWARD T.— <i>Notes on Hypholoma</i>	66
ELLIOTT, J. A.— <i>Coriolus prolificans and C. versicolor on Peach Trees</i>	66
WEISS, J. E.— <i>Effect of Weather on the Attacks of Parasitic Fungi</i>	66
LAURITZER, J. L.— <i>Relation of Temperature and Humidity to Infection by certain Fungi</i>	67
MITRA, S. K.— <i>Effect of Salts on the Growth of Wine-yeast</i>	67
BARRUS, MORTIER F.— <i>Varietal Susceptibility of Beans to Strains of Colletotrichum Lindemuthianum</i>	67
WAKEFIELD, E. M.— <i>Biology of Sand-dune Fungi</i>	67
.. .. . & A. A. PEARSON— <i>Fungus from Weybridge</i>	67
.. .. . — <i>Fungi Erotivi: xxiv.</i>	68
FAIRMAN, CH. E.— <i>New or Noteworthy Fungi from New Mexico</i>	68
TANAKA, TYÔZABORÔ— <i>New Japanese Fungi</i>	68
PEGLER, ALICE, & I. B. POLE EVANS— <i>Cape Fungi</i>	68
SMITH, A. LORRAIN, & OTHERS— <i>New or Rare British Fungi</i>	68
ELLIOTT, J. S. BAYLISS— <i>New Species of "Fungi imperfecti"</i>	68
CRUCHET, PAUL— <i>Fungi on Bromus</i>	68
BURKHOLDER, WALTER H.— <i>Production of an Anthraconose-resistant White Marrow-bean</i>	69
SMITH, A. LORRAIN— <i>Relation of Fungi to other Organisms</i>	69
WILTSHIRE, S. P.— <i>Infection and Immunity</i>	69
ASAI, TOICHI— <i>New Tannery Fungus</i>	69
WILLIAMS, MAUD— <i>Absorption of Gold by Fungi</i>	69
FAWCETT, H. S.— <i>Geographical Distribution of Citrus Diseases</i>	69
.. .. . — <i>Relation of Temperature to Growth of Fungi in Cultures</i>	69
BUTLER, E. J.— <i>Fungi and Disease in Plants</i>	70
HODGSON, ROBERT W.— <i>Sterigmatocystis Smut of Figs</i>	70
DEMANDT, ERNST— <i>Cacao Disease</i>	70
ZINSSMEISTER, C. L.— <i>Root-rots of Ginseng</i>	70
BROOKS, F. T., & A. SHARPLES— <i>Pink Disease of Plantation Rubber</i>	70
ROBINSON, W.— <i>"Black Neck," or Wilt Disease of Asters</i>	71
SMOLAK, T.— <i>Silver-leaf Disease</i>	71
ROSENBAUM, J.— <i>Tomato-fruit Rots</i>	71
SHAPOVALOV, M.— <i>Some Potential Parasites of the Potato Tuber</i>	71
WAKEFIELD, E. M.— <i>Diseases of Yams</i>	71
HENDERSON, M. P.— <i>Disease of Cabbage</i>	72
SHARPLES, A.— <i>Rubber Disease</i>	72
WORTLEY, E. J.— <i>Potato Leaf-roll</i>	72
COTTON, A. D.— <i>Diseases of Parsnip</i>	72
ALCOCK, N. L.— <i>Rose-blotch Fungus</i>	72
COONS, G. H.— <i>Treatment of Scab in Potato Tubers</i>	72
WORMALD, H.— <i>Blossom Wilt and Canker of Apple-trees</i>	73
.. .. . — <i>"Wither Tip" of Plum-trees</i>	73

	PAGE
BELGRAVE, W. N. C.— <i>Disease due to Cytospora</i>	73
VAN DER BIJL, P. A.— <i>Diseases of Carnations</i>	73
STEVENS, NEIL E., & R. B. WILCOX— <i>Rhizopus Rot of Strawberries</i>	175
VUILLEMIN, PAUL— <i>Notes on Mortierella</i>	175
ERIKSSON, JAKOB— <i>Origin and Development of the Potato Disease, Phytophthora infestans</i>	175
VUILLEMIN, P.— <i>New Brown Aspergillus, Eurotium verruculosum</i>	175
VINCENS, F.— <i>Character of Taxonomic Value in Xylariaceæ</i>	176
„ — <i>Organogenic Researches on Hypocreales</i>	176
GUILLERMOND, A.— <i>Zygosaccharomyces Nadsonii</i> sp. n.	176
DUFOUR, LÉON— <i>Vegetation of Plicaria leiocarpa</i>	176
CHENANTAIS, J.— <i>Three Discomycetes</i>	176
PALM, BJ.— <i>Scandinavian Taphrina Species</i>	177
BUREN, G. V.— <i>Contribution to the Knowledge of the Mycetium of the Genus Volkartia</i>	177
DARNELL-SMITH, G. P.— <i>An Account of some Observations upon the Life-history of Phoma citricarpa</i> McAlp.	177
ANDERSON, P. J.— <i>Index to American Species of Phyllosticta</i>	177
DAVIS, J. J.— <i>North American Ascochytae</i>	178
COLTON, A. D.— <i>Onion Smut</i>	178
ELLIOTT, JOHN A.— <i>Smut on Iresine</i>	178
FISCHER, ED.— <i>Experiments with Uredineæ</i>	178
BETHEL, ELLSWORTH— <i>Puccinia subnitens and its Aerial Hosts</i>	178
ARTHUR, J. C.— <i>New Species of Uredineæ</i>	179
LEACH, JULIAN G.— <i>Parasitism of Puccinia</i>	179
WILSON, MALCOLM— <i>British Rust Fungi</i>	179
FISCHER, ED.— <i>Mycological Contributions</i>	179
DRESCHLER, CHARLES— <i>Morphology of the Genus Actinomyces</i>	180
LANGE, JAKOB E.— <i>Studies in the Agarics of Denmark</i>	180
DARNELL-SMITH, G.— <i>Occurrence of an Inverted Hymenium in Agaricus campestris</i>	180
CLELAND, J. BURTON, & E. CHEEL— <i>Notes on Australian Fungi. No. IV. Polyporus, Fomes, and Hexagona</i>	181
PETCH, T.— <i>Ceylon Lentini</i>	181
„ — <i>Ceylon Polypori</i>	181
PATOUILLARD, N.— <i>Conidial Forms of Basidiomycetes</i>	181
LLOYD, C. G.— <i>Mycological Notes</i>	181
BATAILLE, F.— <i>French Mycology</i>	181
MOREAU, FERNAND— <i>Technical Microscopic Methods for the Study of Fungi</i>	182
WEIR, JAMES R.— <i>Introduction of Wood-destroying Fungi</i>	182
GRAFF, PAUL W.— <i>Philippine Basidiomycetes</i>	182
TANAKA, TYÔZABURÔ— <i>New Japanese Fungi</i>	182
POLITIS, IOANNES— <i>Greek Mycology</i>	182
KAUFFMAN, C. H.— <i>Michigan Fungi</i>	182
PAUL, D.— <i>Clathrus cancellatus in Scotland</i>	182
JUILLARD, G., & H. PIERRE— <i>French Mycology</i>	183
PETCH, T.— <i>Additions to Ceylon Fungi</i>	183
„ — <i>Revisions of Ceylon Fungi (Parts IV. and V.)</i>	183
MOREAU, FERNAND— <i>Discoloration of Paper Pulp due to Fungi</i>	183
DUFRENOY, J.— <i>Ecological Conditions in the Development of Parasitic Fungi: Study of Geographical Botany</i>	183
LLOYD, C. G.— <i>Xylaria Notes</i>	184
LEONE, MICHAEL— <i>Sporadic Appearance of Non-edible Mushrooms in Cultivated Mushroom Beds</i>	184

SHEAR, C. L., & OTHERS— <i>Endothia parasitica</i> and Related Species	184
TURCONI, MALUSIO, & LUIGI MAFFEI— <i>Parasitic Microfungi</i>	184
DUFRENOY, J.— <i>Parasite of Arbutus Unedo</i>	185
CHIFFLOT, J.— <i>Ergots of Rye on Wheat</i>	185
BILL, P. VAN DER— <i>Cane-Leaf Spot</i>	185
BRIOSI, GIOVANNI, & RUDOLFO FARNETE— <i>Disease of Chestnuts</i>	185
SHEAR, C. L., & OTHERS— <i>Spoilage of Cranberries after Harvest</i>	185
RAMSBOTTOM, J. K.— <i>Investigations on the Narcissus Disease</i>	185
PIPER, C. V., & H. S. COX— <i>Rhizoctonia on Lawns and Pastures</i>	186
BROOKS, F. T.— <i>Silver-leaf in Fruit-trees</i>	186
BESSEY, ERNST A.— <i>Undescribed Species of Ophiosthelia on Ficus</i>	186
STEVENS, FRANK LINCOLN— <i>Two Illinois Rhubarb Diseases</i>	186
DAVIS, J. J.— <i>Notes on Parasitic Fungi in Wisconsin</i>	186
CURTIS, K. M.— <i>Contributions to the Life-history and Cytology of Synchytrium endobioticum</i>	281
BURGER, OWEN F.— <i>Sexuality in Cunninghamiella</i>	281
TISDALE, W. H.— <i>Physoderma Disease of Corn</i>	281
STEVENS, T. L., & NORA DALBY— <i>Some Phyllachoras from Porto Rico</i>	281
CHENANTAIS, J. E.— <i>Study of Pyrenomyces</i>	281
FITZPATRICK, A. M.— <i>Rostronitschkia, a New Genus of Pyrenomyces</i>	282
RANOJEVITCH, N.— <i>New Species of Rust, Puccinia Corteyi Ran</i>	282
ORTON, C. R.— <i>Notes on Some Polemoniaceous Rusts</i>	282
GARRETT, A. O.— <i>Smuts and Rusts of Utah</i>	282
COTTON, A. D., & E. M. WAKEFIELD— <i>Revision of the British Clavariæ</i>	282
MCDUGAL, W. B.— <i>Development of Stropharia epimyces</i>	282
ATKINSON, G. F.— <i>Relationships within the Rhodosporeæ</i>	282
BURT, EDWARD ANGUS— <i>Telephoraceæ of North America</i>	283
KONRAD, P., & RENÉ MAIRE— <i>Notes and Observations on Agarics</i>	283
WALKER, LEVA B.— <i>Development of Piuteus admirabilis and Tubaria furfuracea</i> ..	283
MERRILL, E. D., & H. W. WADE— <i>Validity of the name Discomyces for the Genus of Fungi variously called Actinomyces, Streptothrix, and Nocardia</i>	283
WAKEFIELD, E. M., & A. A. PEARSON— <i>Additional Resupinate Hymenomyces from the Weybridge District</i>	283
PETCH, T.— <i>Further Notes on Colus Gardneri (Berk.) Fischer</i>	284
BOYER, G.— <i>Studies on the Biology and Culture of the Higher Fungi</i>	284
PETHYBRIDGE, G. H.— <i>Notes on some Saprophytic Species of Fungi associated with Diseased Potato Plants and Tubers</i>	284
WAKEFIELD, M.— <i>British Mycology: The Selby Foray</i>	285
DUFRENOY, J.— <i>Ecological Diversity and Generic Coefficients</i>	285
LAGARDE, J.— <i>Cave Fungi</i>	285
WAKEFIELD, E. M.— <i>New British Fungi</i>	286
PEARSON, A. A.— <i>New Mycena</i>	286
SMITH, A. LOBBAIN— <i>New or Rare Microfungi</i>	286
COTTON, A. D.— <i>Entomogenous Fungi New to Britain</i>	286
WAGER, HAROLD— <i>Fluorescent Coloring Matter from Leptonia incana</i>	286
BRIERLY, W. B.— <i>Some Concepts in Mycology: An Attempt at Synthesis</i>	286
BRACKET Fungi of Citrus Trees	287
COTTON, A. D.— <i>Occurrence of Oak-mildew on Beech in Britain</i>	287
REINKING, OTTO A.— <i>Phytophthora Faberi Mauld.: The Cause of Coconut Bud Rot in the Philippines</i>	287
WORMALD, H.— <i>"Brown-rot" Disease of Fruit-trees: with Special Reference to two Biologic Forms of Monilia cinerea</i>	287

	PAGE
BROOKS, F. T.— <i>Account of some Field Observations on the Development of Potato Blight</i>	288
DEY, P. K.— <i>Studies in the Physiology of Parasitism. V. Infection by Colletotrichum Lendemuthianum</i>	288
KRAKOVEK, J.— <i>Disease of Red Clover</i>	288
HASKELL, ROYAL J.— <i>Fusarium Wilt of Potato in the Hudson River Valley, New York</i>	288
REINKING, OTTO— <i>Philippine Plant Diseases</i>	289
KRAKOVER, L. J.— <i>Leaf-spot Disease of Red Clover caused by Macrosporium sarcinæforme</i>	289
PETHYBRIDGE, G. E.— <i>Disease of Flax Seedlings</i>	289
RECENT <i>Work at the Pathological Laboratory, Kew Gardens</i>	290
EDGESTON, C. W.— <i>New Balansia on Cyperus</i>	379
STEVENS, F. L., & NORA DALBEY— <i>Parasite of the Tree-fern (Cyathea)</i>	379
FOEX, ÉTIENNE— <i>Note on a Cordyceps</i>	379
ATKINSON, G. F.— <i>Phylogeny and Relationship in the Ascomycetes</i>	379
DORAN, WM. D.— <i>Minimum, Optimum, and Maximum Temperatures of Spore Germination in some Uredinales</i>	380
WEST, ERDMAN— <i>Undescribed Timber Decay of Hemlock</i>	380
FAULL, J. H.— <i>Pineapple Fungus, or Enfant du Pin or Warabou</i>	380
MURRILL, W. A.— <i>Some described Species of Poria</i>	380
OVEPHOLTS, L. D.— <i>Some Colorado Fungi</i>	380
CHURCH, A. H.— <i>Fungi as Members of the Subærial Transmigration</i>	380
MAYOR, EUG.— <i>Contribution to the Study of the Mycological Flora of the Chateau d'Œx Region</i>	381
ELLIS, DAVID— <i>Fossil Micro-organisms from the Jurassic and Cretaceous Rocks of Great Britain</i>	381
VOGEL, IRWIN H.— <i>Rose Graft Disease</i>	381
SHAPOVALOV, M.— <i>Is the Common Potato Scab Controllable by a mere Rotation of Crops?</i>	382
FITZPATRICK, H. M.— <i>Publications of George Francis Atkinson</i>	382
BRANDES, E. W.— <i>Banana Wilt</i>	382
PETHYBRIDGE, G. H.— <i>Destructive Disease of Seedling Trees of Thuja gigantea</i> ..	382

Lichens.

SMITH, A. LORRAIN— <i>Lichenology in Great Britain</i>	73
" " — <i>Monograph of British Lichens</i>	73
FINK, BRUCE— <i>New Lichen Genus</i>	74
WATSON, W.— <i>Lichens of Sand-dunes</i>	74
" " — <i>Bryophytes and Lichens of Calcareous Soil</i>	74
PAULSON, R.— <i>Notes on the Ecology of Lichens</i>	74
MAYFIELD, A.— <i>Lichens of a Boulder-clay Area</i>	74
MOREAU, FERNAND & MADAME— <i>Researches on Lichens of the Family Peltigeraceæ</i>	290
LYNGE, BERNT— <i>Brazil Parmeliæ</i>	290
RIDDLE, LINCOLN W.— <i>American Lichens</i>	290
MOREAU, F., & MADAME— <i>Biomorphogenesis in Lichens</i>	290
BRAUN, LUCY E.— <i>Vegetation of Conglomerate Rocks of the Cincinnati Region</i> ..	291
GALLØE, O.— <i>Studies of Lichen Structure and Development</i>	291
MAGNUSSON, A. H.— <i>Contribution to the Lichen Flora of the West Coast</i>	383
" " — <i>Concerning the Species of Brown Parmeliæ and Hypogymniæ, their Occurrence and Fertility, especially on the West Coast</i>	383

Mycetozoa.

	PAGE
LISTER, G.— <i>Shrewsbury Mycetozoa</i>	75
„ — <i>Haunts of the Mycetozoa</i>	75
„ — <i>Mycetozoa in Britain</i>	75
ROSS, JOSEPH— <i>Mycetozoa of Chingford District</i>	75
LISTER, GULIELMA— <i>Mycetozoa found during the Selby Foray</i>	291
BEARDSLEE, H. C.— <i>Michigan Collection of Myxomycetes</i>	291
PATOUILLARD, N.— <i>Myxomycete from Madagascar</i>	291
BRIOSI, GIOVANNI— <i>Study of Plasmodiophora Brassicæ</i>	292
MEYLAN, CH.— <i>Notes on Species of Myxomycetes</i>	383

Schizophyta.

Schizomycetes.

HAUGHWONT, FRANK G.— <i>Infections with Coecidium and Isospora in Animals in the Philippine Islands, and their possible Clinical Significance</i> (Figs. 1-5).. ..	292
DONCASTER, L.— <i>Mutation in Bacteria</i>	293
REINKING, OTTO A.— <i>Philippine Economic Plant Diseases</i>	293
CEDERCREUTZ, AXEL— <i>All Dead Bacteria are not Ag-positive</i>	293
BULLOCK, W. E., & W. CRAMER— <i>On a New Factor in the Mechanism of Bacterial Infection</i>	294
MELLO, FROILANO DE, & J. F. ST. ANTONIO FERNANDES— <i>Revision des Champignons Appartenant au Genre Nocardia</i>	294

MICROSCOPY.

A. Instruments, Accessories, etc.

(3) Illuminating and other Apparatus.

STRUTT, R. J.— <i>The Light scattered by Gases: its Polarization and Intensity</i> ..	76
LAMBERT & OTHERS— <i>Opacimeter for Standardizing Bacterial Emulsions</i> (Fig.) ..	295

(5) Microscopical Optics and Manipulation.

NATIONAL PHYSICAL LABORATORY— <i>Report for the Year 1917-1918</i>	77
--	----

B. Technique.

(3) Cutting, including Embedding and Microtomes.

GOODSPEED, T. H.— <i>Modification of Hand Microtome</i> (1 fig.)	78
--	----

(4) Staining and Injecting.

ARNAUD, ROGER— <i>Note on the New Rapid Staining of Blood and Parasites in Films</i>	297
--	-----

(6) Miscellaneous. 7

	PAGE
TSUJI, HIROSHI, & KARAGORO TACHIBANA— <i>Antiseptic Treatment of Wounds</i>	297
HATSCHKE, EMIL— <i>A Study of the Forms assumed by Drops and Vortices of a Gelatinizing Liquid in Various Coagulating Solutions</i>	384
McLENNAN, J. C., & R. J. LANG— <i>An Investigation of Extreme Ultra-violet Spectra, with a Vacuum Grating Spectrograph</i>	384

GEOLOGY.

MANESSE, E.— <i>Rocks of Italian Somaliland</i>	385
STOPEK, M. C.— <i>On the Four Visible Ingredients in Banded Bituminous Coal: Studies in the Composition of Coal, No. 1</i>	385
SMITH, B.— <i>The Chellaston Gypsum Breccia in relation to the Gypsum-Anhydride Deposits of Britain</i>	385
LANG, W. D.— <i>The Kelestomizæ: a Sub-family of Cretaceous Cribimorph Polyzoa</i>	385

METALLOGRAPHY, ETC.

KRYNITZKY, A. I.— <i>Decomposition of Metals</i>	81
SMOUT, J.— <i>Etching Media commonly used in Non-ferrous Metallography</i>	81
HANSON, D.— <i>Rapid Re-crystallization in Deformed Non-ferrous Metals</i>	81
ANDERSON, ROBERT J.— <i>The Metallography of Aluminium</i>	81
HANSON, D., & S. L. ARCHBUTT— <i>The Micrography of Aluminium and its Alloys</i>	81
JOHNSON, F.— <i>A Few of some of the Mechanical Properties of the Alloys of Copper and Zinc</i>	81
ROSENHAIN, W.— <i>The Properties of some Copper Alloys</i>	81
HAUSEN, F. F., & O. A. KNIGHT— <i>Effect of Heat Treatment on Bronze</i>	81
HOWE, & OTHERS— <i>Flakes in Alloy Steel</i>	82
ARCHER, R. S.— <i>Grain Limits in Heat-treated Alloy Steels</i>	82
COMSTOCK, G. F.— <i>New Light on Transverse Fissures</i>	82
HOTT, SAMUEL L.— <i>Static, Dynamic and Notch Toughness</i>	82
GROTT, F.— <i>The Metallography of Heat Treatment of Metals used in Aeroplane Construction II.</i>	82
MILLER, S. W.— <i>Fusion Welding Applied to Drop Forgings</i>	299
HANSON, D., & J. E. HURST— <i>Improved Case-hardening Process</i>	299
BUTTERWORTH, G. F., & A. E. BELLIS— <i>Characteristics of Rifle-barrel Steel</i>	299
SYNOPSIS of Recent Chemical and Metallurgical Literature	299
ANDERSON, ROBERT J.— <i>Metallography of Aluminium Ingot</i>	299
PHILLIPS, ARTHUR, & GEORGE C. GERNER— <i>Notes on the Influence of Certain Variables associated with the Anneal of Cold-worked Alpha Brass</i>	299
HEYN, E., & O. BAUER— <i>Researches on Bearing Metals</i>	299
SMITH, ERNEST A., & HAROLD TURNER— <i>The Properties of Standard or Sterling Silver, with Notes on its Manufacture</i>	299
HATFIELD, W. H., & G. L. THIRKELL— <i>Season Cracking</i>	299
HATFIELD, W. H.— <i>The Mechanical Properties of Steel, with some Consideration on the Question of Brittleness</i>	385
WHITELEY, J. H., & A. F. HALLMOND— <i>The Acid Hearth and Slag</i>	385
PORTEVIN, A. M., & M. GARVIN— <i>The Experimental Investigation of the Influence of the Rate of Cooling on the Hardening of Carbon Steels</i>	385
TAYLOR, G.— <i>Some Points in the Manufacture of Files</i>	385

Council Meetings are held on the third Wednesday, Meetings of the Biological Section on the first Wednesday in each month from October to June.

Fellows intending to exhibit any Instruments or Objects, or to bring forward any Communications at the Ordinary Meetings, are requested to inform the Secretaries a week before the Meeting if possible.

	PAGE
HIEBONYMUS, G.— <i>Contributions to a Knowledge of the Genus Pteris</i>	269
RICHTER, ALÁDAR— <i>New Schizæa from Borneo (S. Hallieri)</i>	269
STOKEY, ALMA G.— <i>Apogamy in the Cyatheaceæ</i>	371
OSBORN, T. G. B.— <i>Observations on the Tuber of Phylloglossum</i>	371
HILL, J. BEN— <i>Anatomy of Lycopodium reflexum</i>	372
STEIL, W. N.— <i>Method of staining Antherozoid of Fern</i>	372
SIM, T. R.— <i>Ferns of South Africa</i>	372

Bryophyta.

GOEBEL, K.— <i>Organography of Plants</i>	57
EVANS, ALEXANDER W.— <i>Air Chambers of Grimaldi fragrans</i>	58
DOUIN, CH.— <i>Mixtures of Species among the Cephalozellaceæ</i>	58
WATSON, W.— <i>Sphagna, their Habitats, Adaptations and Associates</i>	59
SMITH, GILBERT MORGAN— <i>Cell-Structure and Autospore Formation in Tetradon minimum</i>	59
TODA, Y.— <i>Studies on Schistostega osmundæa</i>	59
DIXON, H. N.— <i>Mosses Collected by the Smithsonian African Expedition</i>	60
HAUPT, ARTHUR W.— <i>Morphological Study of Pallavicinia Lyellii</i>	163
EVANS, ALEXANDER W.— <i>Taxonomic Study of Dumortiera</i>	163
.. .. — <i>American Species of Marchantia</i>	163
.. .. — <i>Noteworthy Lejeuneæ from Florida</i>	161
.. .. — <i>Notes on New England Hepaticæ</i>	164
.. .. — <i>Hepaticæ of St. Croix, St. Jan, St. Thomas, and Tortola</i>	164
FRYE, T. C.— <i>Illustrated Key to the Western Sphagnaceæ</i>	164
SKENE, M.— <i>Acidity of Sphagnum and its Relation to Chalk and Mineral Salts</i>	164
ROELL, J.— <i>Sphagna and Mosses of Thüringen</i>	164
WARNSTORF, C.— <i>Vegetative Increase of Pterygandrum filiforme (Timu) Hedw.</i>	165
GYÖRFFY, I.— <i>Histology of Ephemeroopsis tjibodensis Goebel</i>	165
BROTHERUS, V. F.— <i>Moseniella: a New Moss Genus from Brazil</i>	165
ARNELL, H. W., & C. JENSEN— <i>Bryum vermigerum</i>	165
COKER, DOROTHY— <i>Revision of the North American Species of Encalypto</i>	166
HERZOG, T.— <i>Two Cleistocarpic Mosses of the Bolivian High Cordilleras</i>	166
MÖLLER, H.— <i>Moss Distribution in Sweden</i>	166
ARNELL, H. W.— <i>Mosses of the "Vega" Expedition</i>	166
DIXON, H. N.— <i>Uganda Mosses</i>	167
RECHINGER, K.— <i>Mosses and Ferns from the Pacific</i>	167
BROTHERUS, V. F.— <i>Contributions to the Moss-flora of the Argentine</i>	167
CAMPBELL, D. H.— <i>Studies on some East Indian Hepaticæ</i>	270
KASHYAP, S. R.— <i>Andræcium in Plagiochasma appendiculatum L. et L. and P. arti- culatum Kashyap</i>	270
SCHILBERSZKY, K.— <i>New Moss from the Pleistocene of Kecs-kemet, Hungary</i>	270
WILLIAMS, R. S.— <i>Genus Desmatodon in North America</i>	271
BROTHERUS, V. F., & W. WALTER— <i>Mosses of North Queensland</i>	271
MOSS EXCHANGE CLUB	271
CRIBBS, J. E.— <i>Columnella in Marchantia polyneurpla</i>	372
VON DANKENSCHWEIL, H. W.— <i>Contribution to the Anatomy of Mosses</i>	373
BUCH, H.— <i>Scapania curta and its Allies</i>	374
MEYLAN, CH.— <i>Desmatodon Wilczekii</i>	374
WHELDON, J. A.— <i>Notes on Braithwaite's "Sphagnaceæ Exsiccatae"</i>	374
DIXON, H. N.— <i>Miscellaneous Bryologica</i>	374

Thallophyta.

Algæ.

	PAGE
HATTORI, H.— <i>Microbiological Researches on some Japanese Water-supplies</i>	60
NAKANO, H.— <i>Researches on the Derelopment and Nutrition of some Chlorophyceæ</i>	61
MOORE, G. T.— <i>A Wood-penetrating Alga, Gomontia lignicola sp. n.</i>	61
YABE, H.— <i>Notes on a Carpenteria-Limestone from B. N. Borneo</i>	61
FRYE, T. C.— <i>Age of Pterygophoru californica</i>	61
WALTON, L. B.— <i>Axial Rotation of Aquatic Micro-organisms and its Significance</i> ..	167
PASCHER, A.— <i>Undulating Marginal Cilia in a Green Flagellate</i>	168
GOOR, A. J. C. VAN— <i>Noctiluca miliaris Sur.: A Cytological Investigation</i>	168
STILES, M. H.— <i>Diatom Flora of Martin Beck, Yorks</i>	168
FONTELL, C. W.— <i>Fresh-water Diatoms from Upper Jämtland in Sweden</i>	168
FRITSCH, F. E.— <i>Contributions to our Knowledge of the Fresh-water Algæ of Africa.</i>	
<i>I. Some Fresh-water Algæ from Malagascar</i>	169
RECHINGER, K.— <i>Marine Diatoms from the Pacific</i>	169
MANN, ALBERT— <i>Economic Importance of Diatoms</i>	169
WALTON, L. B.— <i>Eutetramorus globosus: a New Genus and Species of Algæ belonging to the Protococcroideu (Family Cælostridæ)</i>	169
ELENKIN, A. A.— <i>Interesting Case of the Formation of certain Vacuoles at the Ends of the Cells in the Desmid Closterium plurilocellatum</i>	170
" " — <i>Two Green Algæ from the Genus Stigeoclonium Kütz</i>	170
COLLINS, F. S.— <i>Notes from the Woods Hole Laboratory</i>	170
BROWN, J. G.— <i>Abnormal Conjugation in Spirogyra</i>	171
CUNNINGHAM, BERT— <i>Cross-conjugation in Spirogyra Weberi</i>	171
KYLIN, HARALD— <i>Germination of the Spores of Floridææ</i>	171
SETCHELL, W. A.— <i>Parasitism among the Red Algæ</i>	172
NARITA, SEIICHI— <i>Enumeratio Specierum Nematosis et Helminthocladia Japonicæ</i>	173
MAZZA, ANGELO— <i>Oceanic Alpylogy</i>	173
LYLE, LILIAN— <i>Developmental Forms of Marine Algæ</i>	173
BÖRGENSEN, F.— <i>Marine Algæ of the Danish West Indies</i>	174
LUCAS, A. H. S.— <i>Algæ of Commonwealth Bay</i>	174
SALLER— <i>Seaweed as Raw Material for Industry</i>	174
CHURCH, A. H.— <i>Building of an Autotrophic Flagellate</i>	271
JANET, CHARLES— <i>Phylogenesis of the Orthobiont</i>	271
ELLINGER, T.— <i>Protozoa (Fauna Groenlandica. VIII.)</i>	272
CARTER, NELLIE— <i>Trachelomonas inconstans: a New Flagellate</i>	272
" " — <i>Cytology of Two Species of Characiopsis</i>	272
BAUDIN, L.— <i>Vertical Distribution of Plankton in the Lake of Geneva</i>	272
OSTENFELD, C. H.— <i>Bacillariales</i>	273
" " — <i>Schizophyceæ</i>	273
BRACHER, ROSE— <i>Observations on Euglena deses</i>	274
CARTER, NELLIE— <i>Studies on the Chloroplasts of Desmids. I.</i>	274
" " — <i>Studies on the Chloroplasts of Desmids. II.</i>	274
LOEIK, A. J.— <i>List of Desmidiaceæ collected during the Summer of 1913 in the Government of Ufa</i>	275
LECHMERE, A. ECKLEY— <i>Epiphyllie Ulothrix</i>	275
BRISTOL, MURIEL B.— <i>Retention of Vitality by Algæ from old Stored Soils</i>	276
" " — <i>Malay Form of Chlorococcum humicola (Näg.) Rabenh.</i>	276
KUFFERATH, H.— <i>Contribution to the Algal Flora of South Luxembourg</i>	276
PLAYFAIR, G. I.— <i>New and Rare Fresh-water Algæ</i>	277

	PAGE
FRITSCH, F. E.— <i>Fresh-water Algæ of Africa</i>	277
COLLINS, F. S.— <i>Green Algæ of North America: Second Supplement</i>	277
" " — <i>Working Key to the Genera of North American Algæ</i>	277
GARDNER, N. L.— <i>New Pacific Coast Marine Algæ</i>	278
WOLFE, J. J.— <i>Alternation and Parthenogenesis in Padina</i>	278
CLELAND, RALPH E.— <i>Cytology and Life-history of Nemalion multifidum Ag.</i> ..	278
COTTON, A. D.— <i>Distribution of certain British Algæ</i>	279
" " — <i>Japanese Seaweed, Tosuka Nori</i>	280
LUCAS, A. H. S.— <i>Notes on Australian Marine Algæ</i>	280
KYLIN, H., & C. SKOTTSBERG — <i>Sub-Antarctic and Antarctic Marine Algæ.</i> II. : <i>Rhodophyceæ</i>	280
HOWE, MARSHALL A.— <i>Calcareous Algæ from Murray Island, Australia, and Cocos-Keeling Islands</i>	280
CHURCH, A. H.— <i>Plankton-phase and Plankton-rate</i>	375
SCHRÖDER, B.— <i>Melosira Røseana Rabenh., a Luminous Diatom</i>	375
SCHUSSNIG, B.— <i>Remarks on certain Adriatic Plankton Bacillariæ</i>	375
QUELLE— <i>Remarks on the Bacillariacæ of the Numburg Stream</i>	375
LACSNY, J. L.— <i>Bacillariacæ of the Streams near Nagyvárad</i>	376
PETERSEN, J. B.— <i>Studies of Danish Aerophilous Algæ</i>	376
SCHUSSNIG, B.— <i>On some New and Rare Chlorophyceæ of the Adriatic</i>	376
CARTER, NELLIE— <i>Cytology of the Cladophoracæ</i>	377
BULLOCK-WEBSTER, G. R.— <i>New Nitella</i>	377
GROVES, J., & G. R. BULLOCK-WEBSTER— <i>Chara fragilis and C. delicatula</i>	377
GROVES, J.— <i>Notes on Lychnothamnus</i>	377
HOWE, M. A.— <i>On some Fossil and Recent Lithothamniæ of the Panama Canal Zone</i>	378
CHURCH, A. H.— <i>Historical Review of the Floridæ</i>	378
GRUNOW, A.— <i>Additions to our Knowledge of Sargassum</i>	378
CHURCH, A. H.— <i>Phæophyceæan Zoid</i>	378
" " — <i>Historical Review of the Phæophyceæ</i>	379

Fungi.

ERIKSSON, JAKOB— <i>Study of Phytophthora infestans</i>	62
KUSANO, S.— <i>Life-History and Cytology of Olpidium</i>	62
RHOADS, ARTHUR S.— <i>Daldinia vernicosa</i>	62
DURAND, E. J.— <i>Peziza proteana var. sparassoides in America</i>	62
GROVE, W. B.— <i>British Species of Melanconium</i>	62
" " — <i>New or Noteworthy Fungi</i>	63
STONE, R. E.— <i>Incubation Period of Cronartium ribicola on the White Pine</i>	63
CRUCHET, PAUL— <i>Contribution to the Study of Uredinæ</i>	63
ARTHUR, J. C., & G. R. BISBY— <i>Rusts of North America</i>	63
DOSDALL, LOUISE— <i>Oeciwintering of Ascospores of Cronartium ribicola</i>	63
RHOADS, ARTHUR S., & OTHERS— <i>Host Relationship of the North American Rusts, other than Gymnosporangium, which attack Conifers</i>	63
WEIR, J. R., & E. E. HUBERT— <i>Melampsora Cultures</i>	64
JACKSON, H. S.— <i>Puccinia on Carduacæ</i>	64
ARTHUR, J. C.— <i>Study of the Genus Kuehneola</i>	64
DODGE, B. D.— <i>Study of Gymnosporangium</i>	64
ELLIOTT, J. S. BAYLISS— <i>Hypomyces</i>	64
SMITH, A. LORRAIN— <i>Hypomyces and the Rotting of Timber</i>	64
RATHEURN, ANNIE E.— <i>Fungus Flora of Pine Seed-beds</i>	65

	PAGE
BRIERLY, W. B.— <i>Polymorphism of Botrytis cinerea</i>	65
CLELAND, J. BURTON, & EDWIN CHEEL— <i>Notes on Australian Fungi N. IV.</i>	65
PEARSON, A. A.— <i>Two-spored Basidia</i>	65
REA, CARLETON— <i>British Mycology</i>	65
FAULL, J. H.— <i>Fomes officinalis, a Timber-destroying Fungus</i>	65
HORNE, A. S.— <i>Fungi on Aleurodes rapararium</i>	66
GÜSSOW, H. T.— <i>Empusa Muscæ on Musca domestica</i>	66
BRIERLEY, W. B.— <i>Cell-regeneration in Botrytis cinerea</i>	66
MURRILL, W. A.— <i>Illustrations of Fungi</i>	66
HARPER, EDWARD T.— <i>Notes on Hypholoma</i>	66
ELLIOTT, J. A.— <i>Coriulus prolificans and C. versicolor on Peach Trees</i>	66
WEISS, J. E.— <i>Effect of Weather on the Attacks of Parasitic Fungi</i>	66
LAURITZER, J. L.— <i>Relation of Temperature and Humidity to Infection by certain Fungi</i>	67
MITRA, S. K.— <i>Effect of Salts on the Growth of Wine-yeast</i>	67
BARRIS, MORTIER F.— <i>Varietal Susceptibility of Beans to Strains of Colletotrichum Lindemuthianum</i>	67
WAKEFIELD, E. M.— <i>Biology of Sand-dune Fungi</i>	67
" " & A. A. PEARSON— <i>Fungus from Weybridge</i>	67
" " — <i>Fungi Exotici: xxiv.</i>	68
FAIRMAN, CH. E.— <i>New or Noteworthy Fungi from New Mexico</i>	68
TANAKA, TYÔZABORÔ— <i>New Japanese Fungi</i>	68
PEGLER, ALICE, & I. B. POLE EVANS— <i>Cape Fungi</i>	68
SMITH, A. LORRAIN, & OTHERS— <i>New or Rare British Fungi</i>	68
ELLIOTT, J. S. BAYLISS— <i>New Species of "Fungi imperfecti"</i>	68
CRUCHET, PAUL— <i>Fungi on Bromus</i>	68
BURKHOLDER, WALTER H.— <i>Production of an Anthracnose-resistant White Marrow-bean</i>	69
SMITH, A. LORRAIN— <i>Relation of Fungi to other Organisms</i>	69
WILTSHIRE, S. P.— <i>Infection and Immunity</i>	69
ASAI, TOICHI— <i>New Tannery Fungus</i>	69
WILLIAMS, MAUD— <i>Absorption of Gold by Fungi</i>	69
FAWCETT, H. S.— <i>Geographical Distribution of Citrus Diseases</i>	69
" " — <i>Relation of Temperature to Growth of Fungi in Cultures</i>	69
BUTLER, E. J.— <i>Fungi and Disease in Plants</i>	70
HODGSON, ROBERT W.— <i>Sterigmatocystis Smut of Figs</i>	70
DEMANDT, ERNST— <i>Cacao Disease</i>	70
ZINSSMEISTER, C. L.— <i>Root-rots of Ginseng</i>	70
BROOKS, F. T., & A. SHARPLES— <i>Pink Disease of Plantation Rubber</i>	70
ROBINSON, W.— <i>"Black Neck," or Wilt Disease of Asters</i>	71
SMOLAK, T.— <i>Silver-leaf Disease</i>	71
ROSENBAUM, J.— <i>Tomato-fruit Rots</i>	71
SHAPOVALOV, M.— <i>Some Potential Parasites of the Potato Tuber</i>	71
WAKEFIELD, E. M.— <i>Diseases of Yams</i>	71
HENDERSON, M. P.— <i>Disease of Cabbage</i>	72
SHARPLES, A.— <i>Rubber Disease</i>	72
WORTLEY, E. J.— <i>Potato Leaf-roll</i>	72
COTTON, A. D.— <i>Diseases of Parsnip</i>	72
ALCOCK, N. L.— <i>Rose-blotch Fungus</i>	72
COONS, G. H.— <i>Treatment of Scab in Potato Tubers</i>	72
WORMALD, H.— <i>Blossom Wilt and Canker of Apple-trees</i>	73
" — <i>"Wither Tip" of Plum-trees</i>	73

	PAGE
BELGRAVE, W. N. C.— <i>Disease due to Cytospora</i>	73
VAN DER BIJL, P. A.— <i>Diseases of Carnations</i>	73
STEVENS, NEIL E., & R. B. WILCOX— <i>Rhizopus Rot of Strawberries</i>	175
VUILLEMIN, PAUL— <i>Notes on Mortierella</i>	175
ERIKSSON, JAKOB— <i>Origin and Development of the Potato Disease, Phytophthora infestans</i>	175
VUILLEMIN, P.— <i>New Brown Aspergillus, Eurotium cerruculosum</i>	175
VINCENS, F.— <i>Character of Taxonomic Value in Xylariaceæ</i>	176
„ — <i>Organogenic Researches on Hypocreales</i>	176
GUILLEMOND, A.— <i>Zygosaccharomyces Nadsonii</i> sp. n.	176
DUFOUR, LÉON— <i>Vegetation of Plicaria leioearpa</i>	176
CHENANTAIS, J.— <i>Three Discomycetes</i>	176
PALM, BJ.— <i>Scandinavian Taphrina Species</i>	177
BUREN, G. V.— <i>Contribution to the Knowledge of the Mycelium of the Genus Volkartia</i>	177
DARNELL-SMITH, G. P.— <i>An Account of some Observations upon the Life-history of Phoma citricarpa</i> McAlp.	177
ANDERSON, P. J.— <i>Index to American Species of Phyllosticta</i>	177
DAVIS, J. J.— <i>North American Ascochyte</i>	178
COLTON, A. D.— <i>Onion Smut</i>	178
ELLIOTT, JOHN A.— <i>Smut on Iresine</i>	178
FISCHER, ED.— <i>Experiments with Uredinæ</i>	178
BETHEL, ELLSWORTH— <i>Puccinia submitens and its Ecial Hosts</i>	178
ARTHUR, J. C.— <i>New Species of Uredinæ</i>	179
LEACH, JULIAN G.— <i>Parasitism of Puccinia</i>	179
WILSON, MALCOLM— <i>British Rust Fungi</i>	179
FISCHER, ED.— <i>Mycological Contributions</i>	179
DRESCHLER, CHARLES— <i>Morphology of the Genus Actinomyces</i>	180
LANGE, JAKOB E.— <i>Studies in the Agarics of Denmark</i>	180
DARNELL-SMITH, G.— <i>Occurrence of an Inverted Hymenium in Agaricus campestris</i>	180
CLELAND, J. BURTON, & E. CHEEL— <i>Notes on Australian Fungi. No. IV. Polyporus, Fomes, and Hexagona</i>	181
PETCH, T.— <i>Ceylon Leutini</i>	181
„ — <i>Ceylon Polypori</i>	181
PATOUILLARD, N.— <i>Conidial Forms of Basidiomycetes</i>	181
LOYD, C. G.— <i>Mycological Notes</i>	181
BATAILLE, F.— <i>French Mycology</i>	181
MOREAU, FERNAND— <i>Technical Microscopic Methods for the Study of Fungi</i>	182
WEIR, JAMES R.— <i>Introduction of Wood-destroying Fungi</i>	182
GRAFF, PAUL W.— <i>Philippine Basidiomycetes</i>	182
TANAKA, TYOZABURŌ— <i>New Japanese Fungi</i>	182
POLITIS, IOANNES— <i>Greek Mycology</i>	182
KAUFFMAN, C. H.— <i>Michigan Fungi</i>	182
PAUL, D.— <i>Clathrus cancellatus in Scotland</i>	182
JULLIARD, G., & H. PIERRE— <i>French Mycology</i>	183
PETCH, T.— <i>Additions to Ceylon Fungi</i>	183
„ — <i>Revisions of Ceylon Fungi (Parts IV. and V.)</i>	183
MOREAU, FERNAND— <i>Discoloration of Paper Pulp due to Fungi</i>	183
DUFRENOY, J.— <i>Ecological Conditions in the Development of Parasitic Fungi: Study of Geographical Botany</i>	183
LOYD, C. G.— <i>Xylaria Notes</i>	184
LEONIE, MICHAEL— <i>Sporadic Appearance of Non-edible Mushrooms in Cultivated Mushroom Beds</i>	184

	PAGE
SHEAR, C. L., & OTHERS— <i>Endothia parasitica</i> and Related Species	184
TURCONI, MALUSIO, & LUIGI MAFFEI— <i>Parasitic Microfungi</i>	184
DUFRENOY, J.— <i>Parasite of Arbutus Unedo</i>	185
CHIFFLOY, J.— <i>Ergots of Rye on Wheat</i>	185
BIJL, P. VAN DER— <i>Cane-Leaf Spot</i>	185
BRIOSI, GIOVANNI, & RUDOLFO FARNETE— <i>Disease of Chestnuts</i>	185
SHEAR, C. L., & OTHERS— <i>Spoilage of Cranberries after Harvest</i>	185
RAMSBOTTOM, J. K.— <i>Investigations on the Narcissus Disease</i>	185
PIPER, C. V., & H. S. COX— <i>Rhizoctonia on Lawns and Pastures</i>	186
BROOKS, F. T.— <i>Silver-leaf in Fruit-trees</i>	186
BESSEY, ERNST A.— <i>Undescribed Species of Ophiolothella on Ficus</i>	186
STEVENS, FRANK LINCOLN— <i>Two Illinois Rhubarb Diseases</i>	186
DAVIS, J. J.— <i>Notes on Parasitic Fungi in Wisconsin</i>	186
CURTIS, K. M.— <i>Contributions to the Life-history and Cytology of Synchytrium</i> <i>endobioticum</i>	281
BURGER, OWEN F.— <i>Sexuality in Cunninghamiella</i>	281
TISDALE, W. H.— <i>Physoderma Disease of Corn</i>	281
STEVENS, T. L., & NORA DALBY— <i>Some Phyllachoras from Porto Rico</i>	281
CHENANTAIS, J. E.— <i>Study of Pyrenomyces</i>	281
FITZPATRICK, A. M.— <i>Rostromitschidia, a New Genus of Pyrenomyces</i>	282
RANOÏEVITCH, N.— <i>New Species of Rust, Puccinia Corteyi Rau</i>	282
ORTON, C. R.— <i>Notes on Some Polemoniaceous Rusts</i>	282
GARRETT, A. O.— <i>Smuts and Rusts of Utah</i>	282
COTTON, A. D., & E. M. WAKEFIELD— <i>Revision of the British Clavariæ</i>	282
MCDUGAL, W. B.— <i>Development of Stropharia epinyces</i>	282
ATKINSON, G. F.— <i>Relationships within the Rhodosporeæ</i>	282
BURT, EDWARD ANGUS— <i>Thelephoraceæ of North America</i>	283
KONRAD, P., & RENÉ MAIRE— <i>Notes and Observations on Agarics</i>	283
WALKER, LEVA B.— <i>Development of Puteus admirabilis and Tubaria furfuracea</i> ..	283
MERRILL, E. D., & H. W. WADE— <i>Validity of the name Discomyces for the Genus</i> <i>of Fungi variously called Actinomyces, Streptothrix, and Nocardia</i>	283
WAKEFIELD, E. M., & A. A. PEARSON— <i>Additional Resupinate Hymenomyces from</i> <i>the Weybridge District</i>	283
PETCH, T.— <i>Further Notes on Colus Gardneri (Berk.) Fischer</i>	284
BOYER, G.— <i>Studies on the Biology and Culture of the Higher Fungi</i>	284
PETHYBRIDGE, G. H.— <i>Notes on some Saprophytic Species of Fungi associated with</i> <i>Diseased Potato Plants and Tubers</i>	284
WAKEFIELD, E. M.— <i>British Mycology: The Selby Foray</i>	285
DUFRENOY, J.— <i>Ecological Diversity and Generic Coefficients</i>	285
LAGARDE, J.— <i>Care Fungi</i>	285
WAKEFIELD, E. M.— <i>New British Fungi</i>	286
PEARSON, A. A.— <i>New Mycena</i>	286
SMITH, A. LORRAIN— <i>New or Rare Microfungi</i>	286
COTTON, A. D.— <i>Entomogenous Fungi New to Britain</i>	286
WAGER, HAROLD— <i>Fluorescent Coloring Matter from Leptonia incana</i>	286
BRIERLY, W. B.— <i>Some Concepts in Mycology: An Attempt at Synthesis</i>	286
BRACKET <i>Fungi of Citrus Trees</i>	287
COTTON, A. D.— <i>Occurrence of Oak-mildew on Beech in Britain</i>	287
REINKING, OTTO A.— <i>Phytophthora Faberi Mühl.: The Cause of Coconut Bud Rot</i> <i>in the Philippines</i>	287
WORMALD, H.— <i>"Brown-rot" Disease of Fruit-trees: with Special Reference to two</i> <i>Biologic Forms of Monilia cinerea</i>	287

	PAGE
BROOKS, F. T.— <i>Account of some Field Observations on the Development of Potato Blight</i>	288
DEY, P. K.— <i>Studies in the Physiology of Parasitism. V. Infection by Colletotrichum Lendemuthianum</i>	288
KRAKOVEK, J.— <i>Disease of Red Clover</i>	288
HASKELL, ROYAL J.— <i>Fusarium Wilt of Potato in the Hudson River Valley, New York</i>	288
REINKING, OTTO— <i>Philippine Plant Diseases</i>	289
KRAKOVEK, L. J.— <i>Leaf-spot Disease of Red Clover caused by Macrosporium sarcinæforme</i>	289
PETHYBRIDGE, G. E.— <i>Disease of Flux Seedlings</i>	289
RECENT <i>Work at the Pathological Laboratory, Kew Gardens</i>	290
EDGERTON, C. W.— <i>New Balansia on Cyperus</i>	379
STEVENS, F. L., & NORA DALBEY— <i>Parasite of the Tree-fern (Cyathea)</i>	379
FOEX, ETIENNE— <i>Note on a Cordyceps</i>	379
ATKINSON, G. F.— <i>Phylogeny and Relationship in the Ascomycetes</i>	379
DORAN, WM. D.— <i>Minimum, Optimum, and Maximum Temperatures of Spore Germination in some Uredinales</i>	380
WEST, ERDMAN— <i>Undescribed Timber Decay of Hemlock</i>	380
FAULL, J. H.— <i>Pineapple Fungus, or Enfant du Pin or Warabou</i>	380
MURRILL, W. A.— <i>Some described Species of Poria</i>	380
OVEPHOLTS, L. D.— <i>Some Colorado Fungi</i>	380
CHURCH, A. H.— <i>Fungi as Members of the Suberial Transmigration</i>	380
MAYOR, EUG.— <i>Contribution to the Study of the Mycological Flora of the Chateau d'Œx Region</i>	381
ELLIS, DAVID— <i>Fossil Micro-organisms from the Jurassic and Cretaceous Rocks of Great Britain</i>	381
VOGEL, IRWIN H.— <i>Rose Graft Disease</i>	381
SHAPOVALOV, M.— <i>Is the Common Potato Scab Controllable by a mere Rotation of Crops?</i>	382
FITZPATRICK, H. M.— <i>Publications of George Francis Atkinson</i>	382
BRANDES, E. W.— <i>Banana Wilt</i>	382
PETHYBRIDGE, G. H.— <i>Destructive Disease of Seedling Trees of Thuja gigantea</i>	382

Lichens.

SMITH, A. LORRAIN— <i>Lichenology in Great Britain</i>	73
" " — <i>Monograph of British Lichens</i>	73
FINK, BRUCE— <i>New Lichen Genus</i>	74
WATSON, W.— <i>Lichens of Sand-dunes</i>	74
" — <i>Bryophytes and Lichens of Calcareous Soil</i>	74
PAULSON, R.— <i>Notes on the Ecology of Lichens</i>	74
MAYFIELD, A.— <i>Lichens of a Boulder-clay Area</i>	74
MOREAU, FERNAND & MADAME— <i>Researches on Lichens of the Family Peltigeraceæ</i>	290
LYNGE, BERNT— <i>Brazil Parmeliæ</i>	290
RIDDLE, LINCOLN W.— <i>American Lichens</i>	290
MOREAU, F., & MADAME— <i>Biomorphogenesis in Lichens</i>	290
BRAUN, LUCY E.— <i>Vegetation of Conglomerate Rocks of the Cincinnati Region</i>	291
GALLØE, O.— <i>Studies of Lichen Structure and Development</i>	291
MAGNUSSON, A. H.— <i>Contribution to the Lichen Flora of the West Coast</i>	383
" " — <i>Concerning the Species of Brown Parmeliæ and Hypogyniæ, their Occurrence and Fertility, especially on the West Coast</i>	383

Mycetozoa.

	PAGE
LISTER, G.— <i>Shrewsbury Mycetozoa</i>	75
,, — <i>Haunts of the Mycetozoa</i>	75
,, — <i>Mycetozoa in Britain</i>	75
ROSS, JOSEPH— <i>Mycetozoa of Chingford District</i>	75
LISTER, GULIELMA— <i>Mycetozoa found during the Selby Foray</i>	291
BEARDSLEE, H. C.— <i>Michigan Collection of Myxomycetes</i>	291
PATOUILLARD, N.— <i>Myxomycete from Madagascar</i>	291
BRIOSI, GIOVANNI— <i>Study of Plasmodiophora Brassicæ</i>	292
MEYLAN, CH.— <i>Notes on Species of Myxomycetes</i>	383

Schizophyta.

Schizomycetes.

HAUGHWONT, FRANK G.— <i>Infections with Corridium and Isospora in Animals in the Philippine Islands, and their possible Clinical Significance</i> (Figs. 1-5).. ..	292
DONCASTER, L.— <i>Mutation in Bacteria</i>	293
REINKING, OTTO A.— <i>Philippine Economic Plant Diseases</i>	293
CEDERCREUTZ, AXEL— <i>All Dead Bacteria are not Ag-positive</i>	293
BULLOCK, W. E., & W. CRAMER— <i>On a New Factor in the Mechanism of Bacterial Infection</i>	294
MELLO, FROILANO DE, & J. F. ST. ANTONIO FERNANDES— <i>Revision des Champignons Appartenant au Genre Nocardia</i>	294

MICROSCOPY.

A. Instruments, Accessories, etc.

(3) **Illuminating and other Apparatus.**

STRUTT, R. J.— <i>The Light scattered by Gases: its Polarization and Intensity</i> ..	76
LAMBERT & OTHERS— <i>Opacimeter for Standardizing Bacterial Emulsions</i> (Fig.) ..	295

(5) **Microscopical Optics and Manipulation.**

NATIONAL PHYSICAL LABORATORY— <i>Report for the Year 1917-1918</i>	77
--	----

B. Technique.

(3) **Cutting, including Embedding and Microtomes.**

GOODSPEED, T. H.— <i>Modification of Hand Microtome</i> (1 fig.)	78
--	----

(4) **Staining and Injecting.**

ARNAUD, ROGER— <i>Note on the New Rapid Staining of Blood and Parasites in Films</i>	297
--	-----

(6) Miscellaneous. 7

	PAGE
TSUJI, HIROSHI, & KARAGORO TACHIBANA— <i>Antiseptic Treatment of Wounds</i>	297
HAATSCHK, EMIL— <i>A Study of the Forms assumed by Drops and Vortices of a Gelatinizing Liquid in Various Coagulating Solutions</i>	384
MCLENNAN, J. C., & R. J. LANG— <i>An Investigation of Extreme Ultra-violet Spectra, with a Vacuum Grating Spectrograph</i>	384

GEOLOGY.

MANESSE, E.— <i>Rocks of Italian Somaliland</i>	385
STOPEK, M. C.— <i>On the Four Visible Impediments in Banded Bituminous Coal: Studies in the Composition of Coal, No. 1</i>	385
SMITH, B.— <i>The Chellaston Gypsum Breccia in relation to the Gypsum-Anhydride Deposits of Britain</i>	385
LANG, W. D.— <i>The Kelestomniæ: a Sub-family of Cretaceous Cribinorph Polyzoa</i>	385

METALLOGRAPHY, ETC.

KRYNITZKY, A. I.— <i>Decomposition of Metals</i>	81
SMOUT, J.— <i>Etching Media commonly used in Non-ferrous Metallography</i>	81
HANSON, D.— <i>Rapid Re-crystallization in Deformed Non-ferrous Metals</i>	81
ANDERSON, ROBERT J.— <i>The Metallography of Aluminium</i>	81
HANSON, D., & S. L. ARCHBUTT— <i>The Micrography of Aluminium and its Alloys</i>	81
JOHNSON, F.— <i>A Few of some of the Mechanical Properties of the Alloys of Copper and Zinc</i>	81
ROSENHAIN, W.— <i>The Properties of some Copper Alloys</i>	81
HAUSEN, F. F., & O. A. KNIGHT— <i>Effect of Heat Treatment on Bronze</i>	81
HOWE, & OTHERS— <i>Flakes in Alloy Steel</i>	82
ARCHER, R. S.— <i>Grain Limits in Heat-treated Alloy Steels</i>	82
COMSTOCK, G. F.— <i>New Light on Transverse Fissures</i>	82
HOTT, SAMUEL L.— <i>Static, Dynamic and Notch Toughness</i>	82
GROTTK, F.— <i>The Metallography of Heat Treatment of Metals used in Aeroplane Construction II.</i>	82
MILLER, S. W.— <i>Fusion Welding Applied to Drop Forgings</i>	299
HANSON, D., & J. E. HURST— <i>Improved Case-hardening Process</i>	299
BUTTERWORTH, G. F., & A. E. BELLIS— <i>Characteristics of Rifle-barrel Steel</i>	299
SYNOPSIS of Recent Chemical and Metallurgical Literature	299
ANDERSON, ROBERT J.— <i>Metallography of Aluminium Ingot</i>	299
PHILLIPS, ARTHUR, & GEORGE C. GERNER— <i>Notes on the Influence of Certain Variables associated with the Anneal of Cold-worked Alpha Brass</i>	299
HEYN, E., & O. BAUER— <i>Researches on Bearing Metals</i>	299
SMITH, ERNEST A., & HAROLD TURNER— <i>The Properties of Standard or Sterling Silver, with Notes on its Manufacture</i>	299
HATFIELD, W. H., & G. L. THIRKELL— <i>Season Cracking</i>	299
HATFIELD, W. H.— <i>The Mechanical Properties of Steel, with some Consideration on the Question of Brittleness</i>	385
WHITELEY, J. H., & A. F. HALLIMOND— <i>The Acid Hearth and Slag</i>	385
PORTEVIN, A. M., & M. GARVIN— <i>The Experimental Investigation of the Influence of the Rate of Cooling on the Hardening of Carbon Steels</i>	385
TAYLOR, G.— <i>Some Points in the Manufacture of Files</i>	385

	PAGE
HUMFREY, J. C. W.— <i>Macro-etching and Macro-printing</i>	385
HANSON, D., & J. E. HURST— <i>Improvements in the Case-hardening Process</i>	386
ANDREW, J. H., & G. W. GREEN— <i>The Manufacture and Working of High-speed Steel</i>	386
ARNOLD, J. O., & F. IBBOTSON— <i>The Molecular Constitutions of High-speed Tool Steels, and their Correlations with Lathe Efficiencies</i>	386

NOTICES OF NEW BOOKS.

CHAMBERLAIN, CHARLES JOSEPH— <i>The Living Cycads</i>	300
GLEICHEN, ALEXANDER— <i>The Theory of Modern Optical Instruments</i>	387
STRUTT, R. J.— <i>Scattering of Light by Solid Substances</i>	388
SOUTHALL, JAMES P. C.— <i>Mirrors, Prisms and Lenses</i>	388
SMITH, ANNIE LORRAIN— <i>A Monograph of the British Lichens</i>	389

PROCEEDINGS OF THE SOCIETY.

Meeting, December 18, 1918	83
.. January 15, 1919	84
.. February 19,	88
.. March 19,	187
.. April 16,	191
.. May 21,	194
.. June 18,	302
.. October 15,	391
.. November 19,	393
REPORT OF THE MICROSCOPE COMMITTEE OF THE BRITISH SCIENCE GUILD.. ..	199

GENERAL INDEX TO VOLUME	397
---------------------------------	-----

Any Omissions or Errors in this List should be notified to the
Secretary.

LIST OF FELLOWS
OF THE
Royal Microscopical Society

(Corrected to July 31st, 1919.)

ORDINARY FELLOWS.

* *Fellows who have compounded for their Annual Subscriptions.*

Elected.

- 1892 Abraham, Rev. Nendick.
Wesleyan Parsonage, Sea Point, Cape Town, South Africa.
- 1894 Abrams, Albert, M.D.
2135, Sacramento-street, San Francisco, Cal., U.S.A.
- 1919 Abushady, Ahmed Zahy, L.M.S.S.A.
21, Cairn-avenue, Ealing, W.5
- 1893 Adair, Thomas Stewart, M.D., C.M., Edin.
Storches-Hall-asylum, Kirkburton, near Huddersfield.
- 1918 Adams, Basil.
Lynwood, Cromwell-road, Beckenham.
- 1893 Adams, Charles, M.D.
33, Bellevue-place, Chicago, Ill., U.S.A.
- 1893 Adams, James.
Comely-park, Dunfermline, N.B.
- 1911 Aders, Walter Mansfield, Ph.D.
Zanzibar, East Africa.
- 1918 Agate, Charlton S., B.Sc., etc.
Engineering Staff, Marconi Works, Chelmsford.
- 1892 Aikin, Charles Edmund, M.R.C.S., L.S.A.
Pentre Felin, Llangollen, Denbighshire, North Wales.
- 1918 Ainslie, Maurice Anderson, R.N.
8, Woodville-road, Blackheath, S.E.3
- 1906 Aitken, Henry James.
Lauresdale, Wellington-road, Edgbaston, Birmingham.

- Elected,
 1914 Akehurst, Sydney Charles.
 69, *Bowes-road, Palmers Green, N.13*
- 1913 Allan, Mark J.
 "Ludgershall," *Roslyn-street, Middle Brighton, Victoria, Australia.*
- 1912 Allen, George Morris.
 "Milburn," *Bury-street, Euroa, Victoria, Australia.*
- 1905 *Allis, Edward Phelps, jun., C.E., LL.D., F.L.S., F.Z.S.
Palais Carnolès, Menton, Alpes Maritimes, France.
- 1906 Andrews, Cuthbert Otto Ralph.
 47, *Red Lion-street, Holborn, W.C.1*
- 1912 Angus, Herbert Francis.
 83, *Wigmore-street, Cavendish-square, W.1*
- 1906 Anthony, Charles, F.R.S.E., M.Inst.C.E., M.Am.Soc.C.E.,
 F.R.A.S., F.R.Met.Soc., F.C.S.
Casilla de Correo 149, Bahía Blanca, Argentine Republic, South America.
- 1911 Armstrong, Frank.
 78, *Deansgate, Manchester.*
- 1912 Ash, Lieut. Edward C.
Dallinghoo Hall, Wickham Market, Suffolk.
- 1909 Ashe, Albert.
 55, *Warrior-square, Southend-on-Sea.*
- 1916 Ashworth, Fred, F.R.Met.Soc., M.S.C.I.
 15, *Woodlea, Waterfoot, near Manchester.*
- 1917 Atkinson, Ernest, A.M.I.L.E., M.I. & S.I.
 5, *Bank-road, Workington.*
- 1915 Attridge, Alfred J.
Ivydene, Rhine-road, Sca Point, Cape Town, S. Africa.
- 1913 Aubin, Percy Adrian.
 10, *Elizabeth-place, St. Helier, Jersey.*
- 1912 Audas, James W., F.L.S.
 "Engowra," 105, *Punt-road, St. Kilda, Melbourne, Victoria.*
- 1909 Bagshaw, Walter.
Moorfield, Birkenshaw, near Bradford.
- 1894 *Bailey, Charles, M.Sc., F.L.S.
Haymesgarth, Cleeve-hill, S.O., Gloucestershire.
- 1908 Baird, Thomas Stewart, F.I.O., F.S.M.C., D.B.O.A.
 54, *St. Enoch-square, and 34-36, Queen-street, Glasgow.*
- 1915 Baker, Arthur.
 "Denhurst," *Earnsdale, Darwen, Lancs.*
- 1885 Baker, Frederick Henry, F.L.S.
 167, *Hoddle-street, Richmond, Victoria, Australia.*
- 1894 Baker, Frederick William Watson.
 313, *High Holborn, W.C.1*
- 1914 Baker, Wilfred E. Watson.
 313, *High Holborn, W.C.1*

- Elected.
- 1882 Bale, William Mountier.
83, *Walpole street, Kew, Victoria, Australia.*
- 1895 Barnard, Joseph Edwin.—PRESIDENT.
Park View, Brondesbury-park, N.W., and Royal Societies Club, St. James's-street, S.W.1
- 1913 Barratt, Thomas Franklin.
Bellmoor, Hampstead Heath, N.W.
- 1913 Barton, Norman V.
10, *Exhibition-road, S. Kensington, S.W.7*
- 1874 Bate, George Paddock, M.D., F.R.C.S.E., M.R.C.S., *Surgeon-Lieut.-Col. Army Medical Reserve.*
2, *King Edward's-road, Hackney, N.E.9*
- 1918 Baxter, Charles, C.E.
Cleveland-house, Bradford-road, Shipley.
- 1890 Baxter, Wynne Edwin, J.P., D.L., F.G.S.
170, *Church-street, Stoke Newington, N.16, and The Granvilles, Stroud, Gloucestershire.*
- 1913 Bayliss, Professor William Maddock, D.Sc., F.R.S.
St. Cuthberts, West Heath-road, Hampstead, N.W.
- 1899 Beale, Peyton Todd Bowman, F.R.C.S.
"Oaklands," *Hythe, Southampton.*
- 1915 Beattie, William.
8, *Lower Grosvenor-place, S.W.1*
- 1885 *Beck, Conrad.
68, *Cornhill, E.C.3*
- 1899 Beck, Horace Courthope.
Lister Works, Weedington-road, Kentish Town, N.W.5
- 1879 *Bell, Francis Jeffrey, M.A., F.Z.S., *Emeritus Professor of Comparative Anatomy and Zoology in King's College, London, Corresponding Member Linnean Society of New South Wales, Honorary Member Manchester Microscopical Society.*
11, *Aberdeen-chambers, 43, Great-Marlborough-street, W.1*
- 1910 Berridge, Miss Emily Mary, D.Sc., F.L.S.
7, *The Knoll, Beckenham, Kent.*
- 1918 Berry, John Leslie.
151A, *New-street, Barton-on-Trent.*
- 1913 Bestow, Charles Horton.
Melford-house, Upper Clapton, N.E.
- 1912 Billinghurst, Humphrey Godwin.
76, *Lebanon-gardens, Wandsworth, S.W.18*
- 1897 Birkbeck, Rev. Joseph.
South Manse, Spilsby, Lincolnshire.
- 1918 Blackmore, Herbert George.
23, *Gloucester-gardens, W.2*
- 1899 Bliss, J.
Boar Bank Hall, Grange-over-Sands, Lancashire.
- 1903 *Blood, Maurice, M.A., F.C.S.
51, *Winchester-avenue, Kilburn, N.W.6*
- 1916 Boccock, C. Hanscope.
c/o Ernest C. Root, Esq., Medina, Ohio, U.S.A.

- Elected. ~~1918~~
- 1918 ~~1918~~ Bois, Sir Stanley.
12, *Fenchurch-street, E.C.*
- 1889 Booth, Miss Mary Ann.
60, *Dartmouth-street, Springfield, Mass., U.S.A.*
- 1862 Borradaile, Charles.
3, *Norfolk-terrace, Brighton.*
- 1913 Boyce, David R.
Greenwood-park, Durban, Natal, South Africa.
- 1914 Boyer, Charles S., A.M.
6140, *Columbia-avenue, Philadelphia, Pa., U.S.A.*
- 1910 Bracewell, Geoffrey Alfred.
17, *Farcliffe-terrace, Bradford, Yorkshire.*
- 1918 *Bradshaw, Thomas Buller, J.P.
Millways, Launceston, Cornwall.
- 1914 Brand, Felix.
37 & 38, *Hatton-garden, E.C.1*
- 1915 Brewster, Frank.
Criminal Intelligence Office, Simla, India, and The "Dingle," Simla.
- 1890 Briant, Lawrence, F.C.S., *Mem. Soc. Public Analysts.*
24, *Holborn-viaduct, E.C.1*
- 1905 Bridge, John William.
Brewer-street, Maidstone.
- 1908 Brooks, Theodore, B.A. (Cantab.), F.R.G.S., *Member of the Academy of Natural Sciences, Philadelphia, U.S.A., Member of the Entomological Society of America.*
Central Caracas, Caracas Sanba, Clara Province, Cuba.
- 1887 Browne, Edward Thomas, F.Z.S.
Anglefield, Berkhamstead, Herts.
- 1911 Browning, Sidney Howard, L.R.C.P., M.R.C.S.
The Station Hospital, Jubbulpore, India.
- 1919 Brunelle, Major George C., Ph.C., M.D.
200, *Chester Pike, Glen Olden, Pa., U.S.A.*
- 1912 Bullamore, Geo. W.
Walden-cottage, Albury, Herts.
- 1919 Bumsted, William F.
792A, *Manning-avenue, Toronto, Canada.*
- 1918 Burke, George E.
Rawlins, Carbon Co., Wyoming, U.S.A.
- 1918 Burke, George Edwin.
Star Ranch, Colorado Springs, Box 1101, Colorado.
- 1913 Burns, Nesbitt, B.A., M.B., B.Ch.
The Lodge, Highbridge, Somerset.
- 1910 Caird, William John.
Schoolhouse, Sandhaven, Fraserburgh.
- 1892 Cale, George W., M.D., *Chief Surgeon, St. Louis and San Francisco Railroad Company.*
San Francisco Hospital, 4960, Laclede-avenue, St. Louis, Mo., U.S.A.

- Elected.
- 1913 Capell, Bruce J.
10, *Castelnau, Barnes, S.W.13*
- 1891 Carlier, Edmond William Wace, M.D., B.Sc., *Professor of Physiology, Mason University College, Birmingham. Morningside, Grauville-road, Dorridge, near Birmingham.*
- 1880 *Carruthers, William, Ph.D. F.R.S., F.L.S., F.G.S.
44, *Central-hill, Norwood, S.E.19*
- 1910 Carter, John Arthur, Assoc.M.I.M.E.
6, *Temple-road, Stowmarket, Suffolk.*
- 1861 *Cattley, Edward Abbs.
Officer Str^t. 5, lodg. 15, St. Petersburg, Russia.
- 1918 Cattley, Major Robert, M.B., C.M., B.Sc., etc.
43, *Main-avenue, Heworth, York.*
- 1903 Chapman, Alfred Chaston, F.I.C., F.C.S.
8, *Duke-street, Aldgate, E.C.3*
- 1892 Chapman, Frederick, A.L.S.
- 1911 Chatwin, Charles Panzetta.
32, *Cassland-road, Thornton-heath, Surrey.*
- 1909 Cheavin, Harold Squier.
22, *Woburn-place. W.C.1*
- 1904 Cheshire, Professor Frederic John, C.B.E., *Director of Technical Optics, Imperial College of Science and Technology, South Kensington, S.W.7*
23, *Carson-road, West Dulwich, S.E.*
- 1885 Clark, Joseph.
Hind Hayes, Street, S.O., Somerset.
- 1917 Clemence, Walter, M.I.Mech.E.
1, *Park-terrace, Nottingham.*
- 1914 Clibborn, Lt.-Col. John, C.I.E., B.A.
87, *Victoria-street. S.W.1*
- 1907 Clowes, William Archibald, F.Z.S.
Duke-street, Stamford-street, S.E.1
- 1905 Cole, Thomas Skelton.
Westbury, 7, Endcliffe-crescent, Sheffield.
- 1908 Connell, John Gibson.
Biology Department, Glasgow Provincial Training College, Cowcaddens-street, Glasgow.
- 1918 Conrady, Professor A. E.
Imperial College of Science and Technology, South Kensington, S.W.7
- 1875 Cowan, Thomas William, F.L.S., F.G.S.
Sutherland-house, Clevedon, Somerset.
- 1881 Creese, Edward James Edgell, F.Z.S.
29, *Cornford-grove, Balham, S.W.12*
- 1884 *Crisp, Lady Catherine.
5, *Lansdowne-road, Notting-hill, W.*
- 1891 Crowther, Henry.
Curator, The Museum, Leeds.
- 1913 Cuzner, Edgar.
36, *Trothy-road, Bermondsey, S.E.1*

Elected.

- 1914 Daniels, Major William Cooke.
 1916 Davies, Alfred T.
Avon-house, Keynsham, near Bristol.
 1908 Davies, Daniel.
 12, *Eliot-hill, Blackheath, S.E.*
 1878 Davis, John.
 41, *Stirling-road, Birmingham.*
 1915 Denne, Mark Thomas.
Edgehill, Warlingham, Surrey.
 1885 De Witt, William G.
 88, *Nassau-street, New York, U.S.A.*
 1904 Dibdin, William Joseph, F.I.C., F.C.S.
 31, *Idmiston-road, West Norwood, S.E.27*
 1918 Digby, Miss Lettice.
Kings Ford, Colchester.
 1913 Dinsley, Alfred.
 1886 Disney, Alfred Norman, M.A., B.Sc.
 14, *Wilton-erescent, Wimbledon, S.W.19*
 1918 *Dixon, Miss Annie.
 43, *Pine-road, Didsbury, Manchester.*
 1896 Dixon, Walter.
 38, *Bath-street, Glasgow.*
 1892 Dixon-Nuttall, Frederick Richard.
Ingleholme, Eccleston-park, near Prescott, Lancashire.
 1907 Dowdy, Sidney Ernest, M.P.S.
 1, *Belton-villas, Hill-road, Dovercourt, Essex.*
 1918 Downes, Harold, M.B., C.M., L.R.C.P., etc.
Ditton Lea, Ilminster, Somerset.
 1919 Drescher, Theodore Bausch.
 149, *Westminster-road, Rochester, N.Y., U.S.A.*
 1910 Dumat, Frank Campbell.
 26, *Standard Bank-chambers, Johannesburg, Transvaal, South Africa.*
 1894 Duncan, Cecil Cooke, F.I.C., F.C.S.
The County Chemical Laboratory, Shire Hall, Worcester.
 1911 Duncan, Francis Martin, F.R.P.S.
 71, *St. Leonard's-road, East Sheen, S.W.14*
 1919 Dunn, Reginald.
c/o Messrs. Brown & Wilby, 9, Friar-lane, Leicester.
- 1910 Earland, Arthur.
Aviemore, 34, Granville-road, Watford, Herts.
 1907 Eastham, John W., B.Sc. (Edin.).
Vernon, British Columbia.
 1912 Edwardes, Seabury.
Burma Excise Department, Moulmein, Lower Burma.
 1899 Elliott, Oliver Thomas, M.P.S., Ph.C.
c/o Messrs. Philip Harris & Co., Edmund-street, Birmingham, and The Rowans, Lloyd's-street, Small Heath.

Elected.

- 1919 Elliott, Thomas Gifford, F.I.C., F.C.S.
*Research Laboratory, Hecla Works, Sheffield, and Hillecote,
Park Edge, Hathersage, near Sheffield.*
- 1907 Ewell, Marshall D., M.D.
155, North Clark-street, Chicago, Ill., U.S.A.
- 1897 Eyre, John William Henry, M.D., M.S.Durh., D.P.H., F.R.S.E.
—SECRETARY, *Professor of Bacteriology at the London
University.*
*Bacteriological Laboratories, Guy's Hospital, S.E.1,
62, Wimpole-street, W.1, and The Warren, Tulse-hill,
S.W.2*
- 1883 *Fawcett, John Edward.
Heron-court, Farnham, Knaresborough.
- 1883 Fellows, Charles Sumner.
*107, Chamber of Commerce, Minneapolis, Minnesota,
U.S.A.*
- 1917 Fendick, Ernest A.
Wicklewood, 22, Finedon-road, Wellingborough.
- 1909 Ferguson, Arthur Duncan.
*British Guiana Bank, Georgetown, Demerary, British
Guiana.*
- 1904 Fischer, Charles Edward Max, M.D., *Associate Professor of
Biology, Histology, and Embryology, College of Physicians
and Surgeons of the University of Illinois, Memb. Amer.
Microscopical Soc., Memb. of the Amer. Assoc. for the
Advancement of Science.*
Suite 1320-2, 25, E. Washington-street, Chicago, Ill., U.S.A.
- 1866 *Fitch, Frederick George.
34, Hamilton-terrace, N.W.8
- 1903 Fitz-Randolph, Raymond Bernard, A.C., *Director, State
Laboratory of Hygiene of the State of New Jersey.*
Trenton, New Jersey, U.S.A.
- 1902 Flatters, Abraham.
Syddal-cottage, Bramhall, Cheshire.
- 1917 Fotheringham, William, J.P.
Hillhead, Lerwick, Shetland.
- 1915 Francis, Miss Lilian Angela.
9, Henrietta-street, Cavendish-square, W.1
- 1912 Gadd, Arthur.
115, Atwood-road, Didsbury, near Manchester.
- 1889 Gadd, William, C.E.
Park View, 30, Richmond-grove West, Manchester.
- 1918 Garbutt, Ernest Chalders.
York-house, St. Ives, Cornwall.

Elected.

- 1902 Gardner, William.
292, *Holloway-road, N.7*
- 1911 Garforth, Sir William Edward, LL.D.
Snydale Hall, Normanton.
- 1919 Garnett, John Benbow.
309, *Oxford-road, Manchester.*
- 1905 Gettys, Henry B., M.D.
3526, *Washington-avenue, St. Louis, Mo., U.S.A.*
- 1910 Gibbs, Miss Lilian S., F.L.S.
22, *South-street, Thurloe-square, S.W.*
- 1902 Gibson, Joseph.
Elmfield, Psalter-lane, Sheffield.
- 1892 Gifford, James William.
Oaklands, Chard, Somerset.
- 1899 Gleadow, Frank.
Bakeham-house, Englefield Green, Surrey.
- 1912 Glover, Samuel.
Olive Mount, St. Ann's, St. Helens, Lancashire.
- 1910 Gooding, Henry Cornish.
Ipswich-street, Stowmarket, Suffolk.
- 1908 Gordon, David.
Care of D. & W. Murray, Ltd., Adelaide, South Australia.
- 1909 Gordon, Fred. William.
61, *Broadway, New York City, U.S.A.*
- 1885 Gordon, Rev. J. M., M.A.
7, *Moreton-gardens, S.W.5*
- 1919 Grant, Ernest Henry.
Britannia-villas, Chesham, Bucks.
- 1904 Griffiths, Waldron.
134, *Market-place, Cirencester.*
- 1910 Grundy, James.
"Ruislip," *Teignmouth-road, Cricklewood, N.W.2*
- 1912 Gurrin, Gerald Francis.
59, *Holborn-viaduct, E.C.1*
- 1902 Güssow, Hans Theodore.
Chief, Division of Botany, Dominion Experimental Farm, Ottawa, Canada, and 43, Fairmount-avenue, Ottawa, Canada
- 1910 Gwynne-Vaughan, Mrs. Helen Charlotte Isabella, D.Sc., F.L.S.,
Head of the Department of Botany, Birkbeck College, E.C.4, 93, Bedford-court-mansions, W.C.1
- 1919 Hadfield, Sir Robert A., Bart., D.Sc., F.R.S.
22, *Carlton-house-terrace, S.W.1*
- 1893 Hägler, Elmer Ellsworth, M.D.
The Hägler Building, 401, East Capitol-avenue, Springfield, Illinois, U.S.A.
- 1914 Halford-Roberts, Stanley.
Edenholme, East Boldon, near Newcastle-on-Tyne.

Elected.

- 1912 Hall, Rev. C. A.
Meirsbrook, Meikleriggs, Paisley.
- 1885 Hallam, Samuel Robinson, L.S.A. (Lond.), L.M.S.S.A.
586, *Old-Kent road, S.E.1*
- 1882 *Hanaman, Charles Edward.
103, *First-street, Troy, N.Y., U.S.A.*
- 1874 †Hanks, Professor Henry.
1124, *Greenwich-street, San Francisco, California, U.S.A.*
- 1914 Harding, H. Bertram.
77, *Hannah-street, Porth, Glam.*
- 1905 Hardy, Alfred Douglas, F.L.S.
*State Forests Department, Melbourne, Yarra-langi,
Studley-avenue, Kew, Melbourne, Victoria, Australia.*
- 1905 Harris, Charles Poulett, M.D. (Lond.), M.R.C.S., L.R.C.P.
192, *Lower Addiscombe-road, Croydon, S.E.*
- 1919 Harper, Captain Raymond Sydney, M.R.C.S., L.R.C.P.,
R.A.M.C.
Cooksditch, Faversham, Kent.
- 1912 Harrison, James.
- 1915 Hartland, Albert J.
22, *Cambridge-road, King Williams Town, Cape Province,
S.A.*
- 1867 *Hartree, William, Associate Inst. C.E., F.Z.S.
Havering, Tunbridge Wells.
- 1911 Hartridge, Hamilton, M.A., M.D.
King's College, Cambridge.
- 1919 Harvey, John Henry, F.C.S.
Ravensworth, Llantarnam, Newport, Mon.
- 1897 Hassall, John, M.D., M.R.C.S., &c.
Ingleside, Mouldsworth, near Chester.
- 1910 Hately, John Craig.
70, *Board of Trade, Chicago, Ill., and Galewood, Lake
Geneva, Wiss., U.S.A.*
- 1919 Hawksley, Charles Worthington.
83, *Wigmore-street, W.1, and 13 Alma-square, St. John's-
wood, N.W.8*
- 1916 Hazeldine, Frederick James.
Barfield, South Godstone, Surrey.
- 1909 Heath, Charles Emanuel.
178, *Loughborough-road, Brixton, S.W.9*
- 1909 Heath, Ernest.
Cligda, Seamen, Cornwall.
- 1899 Heaton, John, F.C.S.
Southcliffe, Roker, Sunderland.
- 1917 Hensman, Leonard Newton, Ph.C., M.P.S.
2, *Killarney-road, Wandsworth, S.W.18*
- 1889 Hepworth-Collins, Walter, F.G.S., F.C.S.
Junior Constitutional Club, Piccadilly, W.

† Corresponding Fellow.

Elected.

- 1891 Heron - Allen, Edward, F.R.S., F.L.S., F.G.S., F.Z.S.,
M.R.I.A., etc.
33, *Hamilton-terrace, N.W.8, and "Large Acres," Selsey-*
bill, Sussex.
- 1910 Hewlett, Richard Tanner, M.D., F.R.C.P., D.P.H.
Professor of Bacteriology, Bacteriological Laboratory,
King's-college, Strand, W.C., and 12 Colinctte-road,
Putney, S.W.15
- 1904 Hill, Cyril Francis, M.Inst.M.M.
Druids-croft, Kimbaird-avenue, Bromley, Kent.
- 1881 *Hill, Joseph Alfred, F.L.S.
St. Bees, Northumberland-road, Leamington.
- 1906 Hiscott, Thomas Henry.
16, *Woodville-road, Ealing, W.5, and 11, Stone-buildings,*
Lincoln's Inn, W.C.
- 1917 Hitchins, Alfred Bishop, Ph.D., D.Sc., A.M.
c/o Anso Co., Research Laboratory, Binghampton, N.Y.,
U.S.A.
- 1918 Hort, Edward C., F.R.C.P.
8, *Harley-street, W.1*
- 1918 Hoscason, William Sandford.
Dockmaster's Office, Princes & Victoria Dock, Bombay,
India.
- 1891 Howard, A. Dashwood, B.A., M.D., M.R.C.S., L.R.C.P.
"The Corner," Hampton-hill, Middlesex.
- 1917 Howard, Henry.
94, *Rosary-road, Thorpe, Norwich.*
- 1894 Howard, Capt. Robert Nesbit, M.R.C.S., S.A.M.C.
No. 2 General Hospital, Maitland, near Cape Town, S.A.
- 1889 Huber, Gotthelf Carl, M.D., *Professor of Histology and*
Embryology, and Director of the Histological Laboratory
in the University of Michigan.
1330, *Hill-street, Ann Arbor, Mich., U.S.A.*
- 1918 Hughes, Owen Lloyd, *Head Master, The Council School,*
Pontfadog, Chirk, Denbighshire, North Wales.
- 1913 Hughes, R. H. Pullen.
Alexander-house, 141, Duke-street, Southport.
- 1911 Hu'sh, Charles Henry.
"The Limes," 63, London-road, Redhill, Surrey.
- 1913 Hurrell, Harry Edward.
25, *Regent-street, Great Yarmouth.*
- 1867 Ingpen, John Edmund.
21, *Wrotham-road, Broadstairs.*
- 1903 Ives, Frederic Eugene, F.R.P.S., *Member of the Franklin Inst.,*
N.Y., Camera Club, and American Microscopical Soc.,
F.A.A.S.
1201, *Race-street, Philadelphia, Pa., U.S.A.*

Elected.

- 1909 James, Robert Denley.
 1901 Johnson, Charles Harold, M.D., C.M., F.R.C.S.E.
Weyanoke, Kerang, Victoria, Australia.
 1912 Johnston, Thomas Harvey, M.A., D.Sc., F.Z.S.
*Biology Department, The University of Queensland, Bris-
 banc, Australia.*
 1918 Jones, Bertram Hyde.
Ilgars, Runwell, Wickford, Essex.
 1910 Jones, William Llewellyn.
Manley Knoll, Helsby, Cheshire.
- 1885 Karop, George C., M.R.C.S.
Inniscorrig, Beltinge-road, Herne Bay.
 1910 Koeley, Frank J., B.S., E.M., Member of the Council, Academy
*of Natural Sciences, Philadelphia; Vice-Director, Mineral-
 ogical Section, Academy of Natural Sciences, Philadelphia.*
Box 25, Merion Station, Penna, U.S.A.
 1919 Keen, Percy Frederick.
64, Fairholt-road, Stamford-hill, N.16
 1918 Kidd, Robert Hicks.
Marlborough-house, Newbury, Berks.
 1912 King, Mrs. Cecil.
33, Evelyn-gardens, South Kensington, S.W.7
 1909 Kirby, Edwin Henry.
*The Sungei Bahrui Rubber Estates, Ltd., Home Division,
 Alor Gaja, Malacca.*
 1898 Kirkman, Hon. Thomas.
Croftlands, Esperanza, Natal, S. Africa.
 1905 Kitchin, Joseph.
Inglencuk, 14, Brackley-road, Beckenham, Kent.
 1913 Koch, Victor M. E.
Lowood-house, Partingdale-lane, Mill-hill, N.W.
- 1917 Lacy, Frank William.
U.S. Naval Hospital, Las Animas, Colorado, U.S.A.
 1915 Lambert, Joseph.
68, Dartmouth-road, Cricklewood, N.W.2
 1918 Lancaster, Henry C.
39, Ladbroke-grove, Holland-park, W.
 1865 Lankester, Sir Edwin Ray, K.C.B., M.A., LL.D., F.R.S., F.L.S.,
F.Z.S., Hon. Fellow of Exeter College, Oxford.
29, Thurloe-place, S.W.7
 1887 Latham, Miss Vida Annette, M.D., D.D.S.
1644, Morse-avenue, Roger's-park, Chicago, Ill., U.S.A.
 1919 Lauwers, Walter H. M., F.P.S.L.
269, Chaussée de Malines, Antwerp, Belgium.

Elected.

- 1912 Lawson, Peter.
"Jesmond," Nella-road, Fulham-palace-road, Hammer-smith, W.
- 1914 Leeson, John Rudd, J.P., M.D., F.L.S., F.R.A.S.
Clifden House, Twickenham.
- 1912 Lloyd, William Francis.
Conservator of Forests, Bangkok, Siam.
- 1916 McEwen, Alfred.
Craig Avel, Tarrytown-on-the-Hudson, New York, U.S.A.
- 1894 Macintyre, John, M.B., C.M., F.R.S.E.
179, Bath-street, Glasgow.
- 1919 Mackay, Rev. A. F. Gordon.
Holyoke, Colorado, U.S.A.
- 1910 McKeever, Frederick Leonard
P.O. Box 210, Penticton, British Columbia.
- 1912 MacKenzie, John Ross, F.C.S.
Woodleigh, Selborne-road, Barbourne, Worcester.
- 1884 McMurrich, J. Playfair, M.A.
Anatomical Laboratory, University of Toronto, Toronto, Canada.
- 1919 Macpherson, Angus Duncan, M.B.
18, Cornwall-mansions, Chelsea, S.W.10
- 1884 Mainland, George Edward.
14, The Norton, Tenby, South Wales.
- 1909 Mapp, Charles Richard, B.Sc.
88, New Walk, Leicester.
- 1896 Marshall, William John.
"The Nook," 15, Elms-road, Dulwich Village, S.E.
- 1904 Mason, Francis Archibald.
29, Frankland-terrace, Leopold-street, Leeds.
- 1892 Maw, William Henry, C.E., F.R.G.S.
18, Addison-road, Kensington, W.
- 1879 *Mercer, A. Clifford, M.D.
324, Montgomery-street, Syracuse, N.Y., U.S.A.
- 1899 Merlin, Augustus Alfred Cornwallis Eliot.
H.M. Consul at Volo, Greece, c/o Foreign Office, London.
[Athens Bag.]
- 1914 Merriman, Arthur D.
41, Hampden-street, Ardwick, Manchester.
- 1884 Mestayer, Richard Liron, M.Inst.C.E.
139, Sydney-street, West Wellington, N.Z.
- 1901 *Metheny, Samuel Alexander Sterrett, B.A., M.D.
617, North Forty-third-street, Philadelphia, Pa., U.S.A.
- 1877 Michael, Albert Davidson, F.L.S., F.Z.S., F.R.H.S.
The Warren, Studland, near Swanage, Dorsetshire.
- 1915 Milbank, Sidney Alexander, M.B.A.A.
14, North-street, Bishop Stortford.

- Elected.
- 1895 Millard, Edgar James, F.C.S.
35-42, *Charlotte-street, E.C.2*
- 1891 Miller, John Albert, M.Sc., Ph.D., F.C.S., *Chemist to the State of New York.*
44 and 45, *Lewis Block, East Swan-street, Buffalo, N.Y., U.S.A.*
- 1912 Mills, Frederick William.
Thornleigh, Edgerton, Huddersfield.
- 1907 Minns, John Edward, M.S.C.I.
32, *North-street, Taunton, Somersetshire, and 5, North Town-terrace, Taunton.*
- 1905 Moffat, Eliezer.
75, *High-street, Chatham.*
- 1911 Mond, Robert Ludwig, M.A., F.R.S.E., F.C.S., F.Ph.S., F.G.S., F.Z.S.
Combe Bank, Sevenoaks, Kent.
- 1916 Moore, Professor Benjamin, M.A., D.Sc., F.R.S.
8, *Pembroke-villas, The Green, Richmond.*
- 1897 Moore, Harry, *Curator, Public Museum, Clifton-park, Rotherham.*
12, *Whiston-grove, Moorgate, Rotherham.*
- 1851 Moreland, Richard, M.Inst.C.E.
4, *Highbury-quadrant, Highbury, N.5*
- 1896 Moreton-Parry, Lewis.
163, *Oakfield-road, Everton, Liverpool.*
- 1918 Morrish, William I., M.D., etc.
"Westleigh," *Thrale-road, Streatham-park, S.W.16*
- 1918 Mortimer, Hugh Hamilton.
15, *Mulgrave-road, Croydon.*
- 1913 Mosey, Hessay, M.I.H.
7, *Pond-street, Hampstead, N.W.3*
- 1915 Mosley, Frederick Ormrod.
University College, Reading, and "Whernside," Basingstoke-road, Reading.
- 1914 Mumford, Major E. Moore, M.Sc.
75, *High-street, Chorlton-on-Medlock, Manchester.*
- 1919 Murray, James Alexander, M.D.
Director, Imperial Cancer Research Fund.
8, *Queen's-square, W.C.1*
- 1900 Murphy, Albert John, F.C.S.
2, *Dorset-square, N.W.1*
- 1914 Nall, Rev. George Herbert.
18, *Dean's-yard, Westminster, S.W.1*
- 1915 Naylor, George, F.B.O.A., F.I.O.
52, *Cavendish-place, Jesmond, Newcastle-on-Tyne.*
- 1890 *Nelson, Edward Milles.
Beckington, near Bath, Somersetshire.

Elected.

- 1911 Noad, Lewis.
7, *King's Bench-walk, Temple, E.C.*
- 1899 Norman, Albert, L.R.C.P. and L.R.C.S. Edin.
35, *Coleherne-road, Earl's Court, S.W.10*
- 1887 Ochsner, A. J., Ph.D., M.D.
2106, *Sedgwick-street, Chicago, Ill., U.S.A.*
- 1883 Offord, John Milton.
3, *Cleveland-gardens, West Ealing, W.*
- 1907 Ogilvy, James Wilson.
18, *Bloomsbury-square, W.C., and 21, Ravensdale-man-
sions, Crouch-end, N.*
- 1878 O'Hara, Lieut.-Colonel Richard.
West Lodge, Galway.
- 1897 Orueta y Duarte, Domingo de
Lagasca 116, Madrid, Spain.
- 1900 Oxbrow, Alfred William.
7, *Old Haymarket, Norwich.*
- 1879 Oxley, Frederick.
*Care of A. E. Linton, Esq., Box 9, Post Office, Nairobi,
British East Africa.*
- 1912 Palmer, Henry, J.P., F.R.G.S.
"Wall Nook," Langley Park, Durham.
- 1910 Palmer, Thomas Chalkley, *President of Delaware County
Natural History Society, Vice-Director, Biological Section,
Academy of Natural Sciences of Philadelphia,
Media, Delaware Co., Penn., U.S.A.*
- 1919 Parish, Rev. Herald.
191, *Stanford-street, Brooks's Bar, Manchester.*
- 1912 Parsons, Frederick A.
15, *Osborne-road, Stroud-green, N.*
- 1890 *Paterson, Mrs. Catherine Childs.
15, *Compayne-gardens, N.W.6*
- 1916 Patterson, Capt. William R., F.R.A.S., F.R.G.S., F.R.A.I.,
F.R.C.I., M.R.A.S., F.R.Met.Soc., M.C.P.
Censor's Office, Rouen, B.E.F., France.
- 1907 Paulson, Robert, F.L.S.
Glenroy, Cecil-park, Pinner, Middlesex.
- 1898 Payne, Arthur E. T.
*Physiological Laboratory, University of Melbourne,
Victoria, and Scotsburn, Toorak, Melbourne, Victoria.*
- 1884 *Peck, The Honourable Lady.
Widworthy Court, Honiton.
- 1898 Pillischer, Jacob.
88, *New Bond-street, W.1*

Elected.

- 1911 Pinchin, Ernest Alfred, B.Sc. (Lond.), F.I.C.
4, *Gleneldon-road, Streatham, S.W.16*
- 1906 Plaskitt, Frederick James Wade.
15, *Uxbridge-road, Rickmansworth, Herts.*
- 1907 Pledge, John Harry.
72, *Nibthwaite Road, Harrow, Middlesex.*
- 1897 Pollard, Jonathan.
10, *Porteus-road, Paddington-green, W.2*
- 1902 Poser, Max.
16, *Vick Park B., Rochester, N.Y., U.S.A., and c/o
Bausch & Lomb, St. Paul-street, Rochester, N.Y.,
U.S.A.*
- 1867 Potter, George.
296, *Archway-road, N.6*
- 1892 Pound, Charles Joseph.
*Director, Stock Experiment Station, Yeerongpilly, Queens-
land, Australia.*
- 1880 Powell, Thomas Hugh.
Emsdale, Greenham-road, Muswell-hill, N.
- 1898 Radley, Percy Edward, F.Z.S.
*Nesta, Broxbourne, Herts, and The Metric Publishing Co.,
329, High Holborn, W.C.1*
- 1896 Ranken, Charles, F.C.S.
11, *Stockton-road, Sunderland.*
- 1917 Rawlius, Francis Ian Gregory.
White Waltham Grove, near Maidenhead, Berkshire.
- 1912 Rees, W. Eric, F.S.M.C.
26, *Castle-street, Swansea.*
- 1910 Reid, Alfred, M.B., D.P.H.B., B.Hy. Durh., M.R.C.S. Eng.,
L.R.C.P., *Government Medical Officer.*
Kuala Lumpur, Selangor, Federated Malay States.
- 1897 Remington, John Stewart, M.R.A.C., F.C.S., F.L.S.
Aynsome-house, Grange-over-Sands, R.S.O., Lancashire.
- 1904 Rennie, John, D.Sc., *Natural History Department, Marischal
College, the University of Aberdeen.*
60, *Desswood-place, Aberdeen, N.B.*
- 1899 Rheinberg, Julius.
23, *The Avenue, Brondesbury-park, N.W.*
- 1893 Richardson, Frederic William, F.I.C., F.C.S., *County Analyst,
Bradford, and Oak Lea, Menston, Yorkshire.*
- 1916 Richardson, John.
28, *Beaumont-avenue, Richmond, Surrey.*
- 1908 Robertson, James A.
Skerryvore, Holmfield-avenue, Cleveleys, near Blackpool.
- 1910 *Robins, Herbert George, F.R.G.S.
1, *Myrtle-villas, Malling-road, Snodland.*
- 1917 *Robinson, Miss Nancy M.
Glassel House, Glassel, Aberdeenshire.

Elected.

- 1916 Robotham, Francis Edward, F.L.S.
48, *Lillieshall-road, Clapham, S.W.4*
- 1899 Rogers, George Henry James.
2, *Bower-terrace, Tonbridge-road, Maidstone.*
- 1911 Ross, John Pilkethly, M.P.S.
Care of Messrs. Stella and Co., Esplanade-road, Bombay, India.
- 1918 Ross, Sydney W.
The College, Storrington, Sussex.
- 1883 *Rosseter, Thomas B.
6, *Salisbury-road, St. Stephen's, Canterbury.*
- 1888 Rousselet, Charles Frédéric.
165, *London-road, St. Leonards-on-Sea.*
- 1918 Rowley, Frank, M.I.M.M.
Rosebery, Tasmania.
- 1897 Rowley, Frederick Richard, Curator, *Royal Albert Memorial Museum, Exeter.*
8, *Pinhoc-road, Heavitree, Exeter.*
- 1917 Ryland, Lieut.-Colonel Alfred W.
Glen Hurst, Watling-street-road, Fulwood, Preston.
- 1918 Salmon, Walter.
17, *The Grove, Eccles, Lancs.*
- 1892 *Salomons, Sir David Lionel, Bart., J.P., M.A., D.L., F.R.G.S.,
F.G.S., F.Z.S.
49, *Grosvenor-street, W. ; and Broomhill, Tunbridge Wells.*
- 1909 Saxton, Thomas R., Assoc.M.Inst.C.E.
43, *East Bank, Stamford-hill, N.16*
- 1898 Scales, F. Shillington, M.A., M.D., B.C. (Cantab.).
Redcourt, Adams-road, Cambridge.
- 1880 Scott, Dukinfield Henry, M.A., D.Sc., Ph.D., LL.D., F.R.S.,
F.L.S.
East Oakley-house, Basingstoke, Hants, and Athenæum-club.
- 1916 Scott, Joseph Henry.
2, *Priory-gardens, Weld-road, Birkdale, Southport.*
- 1909 Scott, Walter.
Ioynene, Ailesbury-park, Dublin.
- 1913 Scott, Wm., F.R.C.V.S.
Friarn House, Bridgwater.
- 1900 Scourfield, David J., F.Z.S., SECRETARY.
63, *Queen's-road, Leytonstone, E.11*
- 1907 Scriven, Charles R.
Kingscote, Furze-hill, Burgh-heath, Surrey.
- 1919 Seager, John Horsford.
98, *Bramshot-avenue, S.E.7, and 1, St. Mary's-road, Faversham, Kent.*

Elected.

- 1917 Sears, R. S. W.
1, *Lisson-grove, Marylebone, N.W.1*
- 1918 Seymour-Jones, Alfred.
"Pendower," *Wrexham*.
- 1902 Sharpe, Charles James.
130, *Fenchurch-street, E.C.3*
- 1885 *Shelley, Major A. D. G., R.E. (Retired).
Bombay, Baroda and Central Indian Railway Board,
11, *Bishopsgate, E.C.2*
- 1910 Sheppard, Alfred William.
1, *Vernon-chambers, W.C.*
- 1909 Sheppard, Edward James.
137, *Kennington-road, Lambeth, S.E.11*
- 1909 Sidwell, Clarence J. H.
46, *Ashbourne-grove, East Dulwich, S.E.*
- 1912 Simpson, Norman Douglas, B.A.
Maesbury, Cavendish-road, Bournemonth.
- 1916 Singer, Charles, M.A., M.D.
Westbury Lodge, Norham-road, Oxford.
- 1918 Skepper, Harry Godfrey.
"Lindum," *Brothertoft-road, Boston, Lincs.*
- 1917 Smith, Joseph, F.S.A.A.
28, *Altom-street, Blackburn, Lancashire.*
- 1908 Smith, Theodore White.
Naperville, Du Page County, Illinois, U.S.A.
- 1906 Smith, Thomas James.
Braeside, Bosworth-road, New Barnet.
- 1897 Soar, Charles David, F.L.S.
37, *Dryburgh-road, Putney, S.W.15*
- 1903 Spitta, Edmund Johnson, L.R.C.P. (Lond.), M.R.C.S., (Eng.),
F.R.A.S.
41, *Ventnor-villas, Hove, Brighton.*
- 1918 Springall, Hubert F.
The Friars, King's Lynn.
- 1903 Spry, Robert, Lieut.-Commander, R.N.
83, *Mount-Gold-road, Plymouth.*
- 1882 Squance, Major Thomas Coke, M.D., M.S., F.R.S.E.
15, *Grange-crescent, Sunderland, Durham.*
- 1909 Stewart, Thomas S., M.D.
1736, *Spruce-street, Philadelphia, Pa., U.S.A.*
- 1900 Stiles, Matthew Henry.
10, *Avenue-road, Doncaster.*
- 1867 Stoker, George Naylor.
Fairfield, Lessar-avenue, Clapham-common, S.W.
- 1914 Strachan, James.
74, *Blenheim-place, Queen's Cross, Aberdeen.*
- 1912 *Stringer, Edward Belcher.
Egerton-lodge, Bromley, Kent.
- 1871 Stuart, John.
3, *North-side, Clapham-common, S.W.4*

Elected.

- 1918 Sutcliffe, Herbert.
The Research Laboratory, Petaling, Federated Malay States.
- 1906 Swift, Mansell James.
81, *Tottenham-court-road, W.1*
- 1889 Sykes, Mark Langdale.
19, *Westbourne-grove, Scarborough.*
- 1911 Syner, Harry.
11, *Fitzroy-terrace, Devonport.*
- 1911 Tabor, Charles James, F.R.A.I.
The White House, Knott's-green, Leyton, Essex.
- 1891 *Talmage, James Edward, D.Sc., Ph.D., F.R.S.E., F.G.S.,
Professor of Geology, University of Utah, Salt Lake City, Utah, U.S.A.
The Desert Museum, Salt Lake City, Utah.
- 1900 Taverner, Henry.
Wrekin House, 319, Seven-Sisters-road, Finsbury-park, N.4
- 1919 Taylor, Albert.
32, *William-street, Ryecroft, Ashton-under-Lyne.*
- 1915 Taylor, Frederick H.
County Bank, Chorley, Hants.
- 1891 Terry, Edwin, F.C.S.
Sunbury House, 374, Brixton-road, S.W.9
- 1916 Thirnal Raja, Rohani, M.R.A.S.C., M.S.S.A., M.A.S.P.,
etc., etc.
Kizhakke Kottavam Palace, Trivandrum, Travancore, S. India.
- 1885 *Thomson, J. Arthur, M.A., LL.D., F.R.S.E., F.Z.S., *Regius Professor of Natural History in the University of Aberdeen.*
Natural History Department, Marischal College, University, Aberdeen, and Castleton House, Old Aberdeen.
- 1881 Thomson, William.
Royal Institution Laboratory, 79A, Princess-street, Manchester.
- 1912 Tierney, Clarence, M.S.
"Netherton," *Coulsdon, Surrey.*
- 1901 Tilling, George.
Grasmere, Rydal-road, Streatham, S.W.16
- 1919 Tomlinson, Thomas Willis Brown.
High-street, Berkhamsted.
- 1919 Topley, William Whiteman Carlton, M.B., F.R.C.P.,
M.R.C.S., etc.
The Institute of Pathology, Charing Cross Hospital Medical School, Chandos-street, W.C.2
- 1918 Triggs, Edward E.
39, *Scarborough-street, West Hartlepool, Durham.*
- 1917 Tripp, Charles Llewellyn H., M.R.C.S., L.R.C.P.
The Chestnuts, Staple-grove, Taunton.

Elected.

- 1915 Tutt, Captain John Francis Donald, M.R.C.V.S., F.Z.S.
1, *St. Cross-road, Winchester.*
- 1882 Tuttle, Albert Henry, M.Sc.
University of Virginia, Charlottesville, Va., U.S.A.
- 1913 Verrall, Frederick H., B.A., LL.B.
The Hollies, Worthing, Sussex.
- 1909 Walter, Rev. Frederick William.
The Grange, Worstead, Norfolk.
- 1867 *Walters, James Hopkins, M.R.C.S.
15, *Friar-street, Reading.*
- 1869 Ward, Frederic Henry, M.R.C.S.
52, *Lancaster-road, West Norwood, S.E.27*
- 1885 Warner, Edmond.
Southend House, Eltham, S.E.
- 1911 Warrington, Capt. A. F. G., F.R.G.S.
Crookham, 11, Khartoum-road, Highfield, Southampton.
- 1883 Waters, Arthur William, F.L.S., F.G.S.
Alderley, McKinley-road, Bournemouth.
- 1919 Watts, George William, L.D.S.Eng.
103, *Haverstock-hill, N.W.3*
- 1912 Webb, Wilfred Mark, F.L.S.
The Hermitage, Hanwell, W.
- 1897 Webster, William Thomas.
252, *Caledonian-road, N.1*
- 1885 *Western, Edward Young.
27, *Pembroke-square, Notting-hill-gate, W.3*
- 1895 White, Charles Powell, M.D., F.R.C.S., L.R.C.P., *Pathological Department, Victoria University, Manchester.*
1, *Albemarle-road, Withington, Manchester.*
- 1886 *Whitehead, Ralph Radcliffe.
Woodstock, Ulster Co., N.Y., U.S.A.
- 1898 Whittaker, Oscar, F.E.S.
"Ormidale," *Ashlands, Ashton-upon-Mersey, Cheshire.*
- 1915 Whitteron, Frederick.
"Dysart," *Maude-street, Geelong, Victoria, Australia.*
- 1913 Wigan, Basil P., F.C.S.
Rhondda-valley Breweries Co., Treherbert, S. Wales.
- 1910 Wigginton, Panks James.
3, *Park-crescent, Brighton.*
- 1910 Wilding, Percy P.
Hurstwood, Chapel-lane, New Longton, near Preston, Lancs.
- 1916 Wilkin, Corporal Arthur P., F.R.H.S., F.Z.S., F.R.B.S.
22, *Buruaby-gardens, Chiswick, W.*

Elected.

- 1908 Wilson, Joseph.
The Hawthorns, 3, West-park-road, Kew-gardens, S.W.
- 1911 Wilton, Edmund Wade, A.I.S.E., F.S.A.
Planet Works, Bramley, Leeds, and Cliff View, Pollard-lane, Newlay, near Leeds.
- 1909 Winton, Francis Langridge, M.A.
The Brewery, Chatteris, Cambs., and 23, Bateman-street, Cambridge.
- 1899 Wood, Walter James, M.I.Mech.E.
Ernecroft, Abbey-road, Grimsby, and 112, Cleethorpe-road, Grimsby.
- 1911 Woodhead, German Sims, M.A., M.D., LL.D., F.R.S.E., F.R.C.P. (Ed.), *Professor of Pathology in the University of Cambridge.*
Dysart House, Luard-road, Cambridge.
- 1880 *Woodward, Bernard B., F.L.S., F.G.S.
4, Longfield-road, Ealing, W., and Brit. Museum (Nat. Hist.), Cromwell-road, S.W.
- 1880 *Woodward, Henry, LL.D., F.R.S., F.G.S., F.Z.S.
Tudor Cottage, Clay Hill, Bushey, Herts.
- 1889 Wright, Charles Henry.
10, Clarence-road, Kew.
- 1882 Wright, Prof. R. Ramsay, M.A., B.Sc.
Red Gables, Headington-hill, Oxford.
- 1918 Yermoloff, Sir N., K.C.B., K.C.V.O., F.L.S.
3, Whitehall-court, S.W.1
- 1890 *Youldale, William Henry.
21, Belle Isle-street, Workington.
- 1918 Young, George William.
20, Grange-road, Barnes, S.W.

HONORARY FELLOWS.

- 1879 Balbiani, E. G.
Paris.
- 1904 Bonnier, G.
Paris.
- 1918 Bruce, Lady Mary Elizabeth, R.R.C.
London
- 1904 Delage, Y.
Paris.
- 1905 Farlow, W. G.
Cambridge, Mass., U.S.A.
- 1895 Golgi, C.
Padua.
- 1905 Jennings, H. S.
Baltimore.
- 1897 Lee, A. B.
Cologne.
- 1912 Penard, Eugene.
Geneva.
- 1904 ^{Dr}Ramón y Cajal, S.
Madrid.
- 1879 Ranvier, L.
Paris.
- 1902 Rayleigh, Rt. Hon. Lord, F.R.S.
London.
- 1896 Retzius, G.
Stockholm.
- 1879 Sars, G. O.
Christiania.
- 1904 Teall, J. J. H.
London.
- 1897 Toni, G. B. de
Modena.
- 1879 Warming, E.
Copenhagen.
- 1905 Wilson, E. B.
New York.
- 1905 Wood, R. W.
Baltimore.

Patron

HIS MAJESTY THE KING.

Past-Presidents.

	Elected
*SIR RICHARD OWEN, K.C.B. D.C.L. M.D. LL.D. F.R.S.	1840-1
*JOHN LINDLEY, Ph.D. F.R.S.	1842-3
*THOMAS BELL, F.R.S.	1844-5
*JAMES SCOTT BOWERBANK, LL.D. F.R.S.	1846-7
*GEORGE BUSK, F.R.S.	1848-9
*ARTHUR FARRE, M.D. F.R.S.	1850-1
*GEORGE JACKSON, M.R.C.S.	1852-3
*WILLIAM BENJAMIN CARPENTER, C.B. M.D. LL.D. F.R.S.	1854-5
*GEORGE SHADBOLT	1856-7
*EDWIN LANKESTER, M.D. LL.D. F.R.S.	1858-9
*JOHN THOMAS QUEKETT, F.R.S.	1860
*ROBERT JAMES FARRANTS, F.R.C.S.	1861-2
*CHARLES BROOKE, M.A. F.R.S.	1863-4
*JAMES GLAISHER, F.R.S.	1865-6-7-8
*REV. JOSEPH BANCROFT READE, M.A. F.R.S.	1869-70
*WILLIAM KITCHEN PARKER, F.R.S.	1871-2
*CHARLES BROOKE, M.A. F.R.S.	1873-4
*HENRY CLIFTON SORBY, LL.D. F.R.S.	1875-6-7
*HENRY JAMES SLACK, F.G.S.	1878
*LIONEL S. BEALE, M.B. F.R.C.P. F.R.S.	1879-80
*PETER MARTIN DUNCAN, M.B. F.R.S.	1881-2-3
*REV. WILLIAM HY. DALLINGER, M.A. LL.D. F.R.S.	1884-5-6-7
*CHARLES THOS. HUDSON, M.A. LL.D. (Cantab.), F.R.S.	1888-9-90
^o ROBERT BRAITHWAITE, M.D. M.R.C.S.	1891-2
ALBERT D. MICHAEL, F.L.S.	1893-4-5-6
EDWARD MILLES NELSON	1897-8-9
WILLIAM CARRUTHERS, F.R.S. F.L.S. F.G.S.	1900-1
HENRY WOODWARD, LL.D. F.R.S. F.G.S. F.Z.S.	1902-3
DUKINFIELD HY. SCOTT, M.A. Ph.D. LL.D. F.R.S. F.L.S.	1904-5-6
*THE RIGHT HON. LORD AVEBURY, P.C. D.C.L. LL.D.	
F.R.S., etc.	1907-8
SIR EDWIN RAY LANKESTER, K.C.B. M.A. LL.D. F.R.S.	
F.L.S. F.Z.S.	1909
J. ARTHUR THOMSON, M.A. F.R.S.E.	1910-11
*HENRY GEORGE PLIMMER, F.R.S., F.L.S., F.Z.S., etc.	1911-12
G. SIMS WOODHEAD, M.A. M.D. LL.D. F.R.S.E., etc.	1913-15
EDWARD HERON-ALLEN, F.R.S. F.L.S. F.G.S., etc.	1916-17

* Deceased.

THE
Royal Microscopical Society.

Established in 1839. Incorporated by Royal Charter in 1866.

20 HANOVER SQUARE, LONDON, W.1

The Society was established in 1839 for the promotion of Microscopical and Biological Science by the communication, discussion, and publication of observations and discoveries relating to (1) Improvements in the construction and mode of application of the Microscope, and (2) Biological or other subjects of Microscopical Research.

It consists of Ordinary, Honorary, and Ex-officio Fellows of either sex.

Ordinary Fellows are elected on a Certificate of Recommendation signed by three Ordinary Fellows, setting forth the names, residence, and qualifications of the Candidate, of whom the first proposer must have personal knowledge. The Certificate is read at two General Meetings, the Candidate being balloted for at the second Meeting.

The Admission Fee is 2*l.* 2*s.*, payable at the time of election; and the Annual Subscription is 2*l.* 2*s.*, payable on election, and subsequently in advance on 1st January in each year, but the Annual Subscriptions may be compounded for at any time for 31*l.* 10*s.* The annual Subscription of Fellows permanently residing abroad is 1*l.* 11*s.* 6*d.*, or a reduction of one-fourth.

The Council, in whom the management of the property and affairs of the Society is vested, is elected annually, and is composed of the President, four Vice-Presidents, Treasurer, two Secretaries, and twelve other Ordinary Fellows.

The Meetings are held on the third Wednesday in each month from October to June, in the Lecture Hall, at 20 Hanover Square, W.1 (commencing at 8 P.M.). Visitors are admitted on the Introduction of Fellows. The business of the Meetings includes the reading of papers, the exhibition of microscopical objects and apparatus (usually on view by 7.30 P.M.), lantern demonstrations, and discussions.

The Journal is published quarterly. All Fellows are entitled to a copy, and it is also sold to Non-Members, at an annual Subscription of 42*s.* post free. It contains the Transactions and Proceedings of the Society, and a Summary of Current Researches relating to Zoology and Botany (principally Invertebrata and Cryptogamia), and Microscopy.

The Library, with the Instruments, Apparatus, and Cabinet of Objects, is open for the use of Fellows daily (except Saturdays), from 10 A.M. to 5 P.M. It is closed for four weeks during August and September.

Forms of proposal for Fellowship, and any further information, may be obtained on application to the Secretary of the Society, 20 Hanover Square, London, W.1

JOURNAL
OF THE
ROYAL MICROSCOPICAL SOCIETY.

MARCH, 1919.

TRANSACTIONS OF THE SOCIETY.

I.—*Presidential Address, 1917-18: The Limitations of
Microscopy.*

By JOSEPH E. BARNARD, P.R.M.S.

(*Read February 19th, 1919.*)

IN accordance with long-established custom, the time has come for me to inflict on you a Presidential Address. I confess that the selection of a suitable subject confronted me with a problem of some difficulty.

I turned for inspiration to the subjects of addresses by some of my predecessors, to find that they in most cases dealt with the particular branch of microscopy in which they were interested, and relied on their, often great, literary ability to put before you an exposition which was a worthy addition to the publications of this Society.

My only course appeared to endeavour to the best of my ability to follow such an example, and to deal with some special branch of microscopy; but with the cessation of war I realized that a change in our outlook must of necessity take place—that I was in a position that none of my predecessors had ever found themselves in, having regard to the social and scientific possibilities of the period ahead of us. It is no longer possible to regard anything as established beyond all chance of reform. The spirit of regeneration is in the air, and it behoves us as a scientific society to review the situation, and to make sure that the branch of science in which we are interested is on a sound foundation, and that we are worthily representing its interests.

I felt, therefore, that some review of the present state of microscopy, its limitations, and, if I dare be prophetic, its possibilities, was called for. Let me at once disclaim any intention, or

for that matter any ability, to tell you something new. It will be of necessity a repetition of an oft-told story, but not I trust entirely devoid of interest even to those of us to whom it is most familiar. There is in this Society perhaps too great a disposition to avoid what is elementary. I can hardly imagine that any of us are so well grounded in the principles of microscopy that no further consideration is necessary.

In fact the exhibits here from time to time convince me that while the objects are often of great interest, the methods of showing them do sometimes leave much to be desired. That will only be remedied by an educational effort, so that all of us may have the opportunity of understanding the scientific principles of the subject we are interested in, and of applying those principles in all we undertake. This, then, is my excuse for dealing with the elements of the subject at this time. It may be only an excuse, and not a well-founded argument, but I can assure you that it has at least the merit of being honest in intention.

I need hardly remind you that I shall be unable, with the time available, to do more than glance here and there at general principles, touching on and indicating points of interest, but not dealing with any part of my subject in a comprehensive or exhaustive manner.

In any consideration of the limitations imposed by the microscope, a clear conception of the magnitudes involved and the relation of microscopic resolution to wave-lengths of light and to molecular dimensions is necessary. This point is of importance, because while the limits of resolution are definite, and unfortunately soon attained, the limits of visibility are by no means so inflexible, and lead us to a consideration of bodies that may approach an organic molecule in order of size.

As you are all aware, the unit of measurement which is usually adopted in microscopic work is the micron, represented by the Greek sign μ . In observations that involve a consideration of dimensions comparable to wave-lengths of light it is more convenient to adopt the micro-millimetre, which is one-thousandth of a micron, and which therefore bears a convenient relationship to dimensions that are of a much smaller order of size. I know of no more graphic method of demonstrating the relative size of these various dimensions than that adopted by Sir George Beilby when dealing with the thickness of thin metal films, and the diagram I am showing you, and the description I give, are taken from his monograph on the "Surface Structure of Solids."

Beginning on the left there is a scale in micro-millimetres. Next to this are three bars which represent on the same scale the wave-lengths of mean red, mean green and mean violet light respectively. The centre of the diagram is occupied by a series of seven sections, all on the same scale, of leaves or films of

thickness varying from 1 micro-millimetre up to 360 micro-millimetres. The three black bars on the extreme right represent on the same scale the resolving power of the three microscope objectives with which we are, perhaps, most familiar, and which are to be found in most batteries of objectives that are used for accurate work. The numbers at the lower ends of the bars are the numerical apertures of these lenses.

“Taking the third of the series, which is marked as having a numerical aperture of 1.4, its length is about 150 micro-millimetres. This means that if two lines were ruled on a glass plate, 150 micro-millimetres apart, they would be seen as two distinct lines by means of this lens. With either of the other two lenses the lines would merge into one: the lens would fail to resolve them.”

“The diagram shows at a glance that an object may be visible to the unaided eye, even though one of its dimensions is far below the range of microscopic resolution. For example, the thickness of a gold-leaf is about 90 micro-millimetres—that is to say, it is 60 millimetres below the resolving power of a lens of 1.4 N.A. Yet we can see the surface of a leaf with the unaided eye, and can examine it microscopically without difficulty; but if we try to see the edge of the leaf we shall fail, for instead of the real edge we shall see an ill-defined edge, the apparent width of which would entirely depend on the aperture of the lens used. With a 1.4 lens the apparent width will be 150 micro-millimetres; with an 0.65 it will be 300 micro-millimetres; and with an 0.3 it will be 700 micro-millimetres. The obvious lesson from this is that in using the microscope in this region of micro-dimensions, we must be careful to keep its limitations, and their possible effect, always in mind.”

In any consideration of the limits of resolving power we have to remember that whenever image-formation by a lens-armed aperture takes place the resulting image of a point is no longer a single point, but a circle of light surrounded by diffraction rings. The result is that in the microscope every optical appliance available must be employed at its best, and optical accuracy of the highest order must be attained to ensure the production of a correct image, one in which these diffraction fringes are least in evidence. If we consider the observation of two objects, or elements in an object, then we shall fail to resolve them if they are so close together that the diffraction image from one overlaps that from the other. The same applies to a grating or series of contiguous points in an object, except that Johnstone Stoney has shown that two points in an object may be somewhat closer together and yet be resolved than the lines of a grating which are of the same distance apart. Also that two such objects would appear to be somewhat farther apart than they actually are. This important

point, which it should be remembered is often brought home to the worker with the microscope, more often perhaps than any other, was first determined theoretically, and afterwards was proved in practice to be well-founded. The method of practical proof was by means of a Grayson ruling. By a fortunate chance two of these lines in the latter projected beyond the rest, so that a pair of objects of known distance apart could be observed. By gradually reducing the numerical aperture of the observing objective, it was shown that the projecting parts of the lines could be seen as two separate objects after the remaining rulings were obliterated, and that they appeared to be farther apart than the distance between the rulings. As you are aware, the theory enunciated by Abbe, and known as the diffraction theory, takes a grating as a typical object. From this we know that the two factors determining the limits of resolving power are the numerical aperture of the objective and the mean wave-length of the light used. Under the most favourable circumstances then the practical limit is reached when objects in a row are about 0.20μ apart, or a pair of objects can be differentiated when they are about five-sixths the distance apart of those that can be separated, if they are in a regularly recurring series.

These limits of resolution for two separate objects may also be taken as the absolute limit of resolution for an isolated object that can be seen and observed as a definite entity. It represents, in fact, the smallest object we can see as a dark body on a bright ground, while being able to ascertain its definite form; but it does not by any means represent the limit of visibility. This point is essentially different, and brings us to a consideration of bodies which can be observed as self-luminous ones on a dark background. The method is well known enough, and when it involves the observation of objects which are well within the resolution limits is referred to as dark-ground illumination. When an object is rendered visible which is small in all dimensions in comparison with a wave-length of light, the object is said to be ultra-microscopic. Lord Rayleigh has shown that the limits of visibility are dependent on the difference of refractive index between the object and the medium in which it lies, and on the intensity of the illumination. Under conditions which result in the object becoming a self-luminous one, it is therefore difficult to assign a definite limit to visibility. In the case of metals like gold and silver in the colloidal state, in which the refractive index differs greatly from that of water, the medium in which they may be immersed, the limit of visibility depends on the amount of light that can be concentrated on such particles and on their separation. On the other hand, in the case of certain organic colloids, such as albumen, the particles are not easily made visible, because of the small difference of refraction existing between them

and the medium. The limits of visibility are therefore mainly dependent on the intensity of illumination. Using sunlight as the illuminant, the smallest observable particle of colloidal gold is probably of the order of 5 micro-millimetres in diameter, and this may be taken to represent the smallest object that has been observed. It is, however, important for us to remember that colloidal gold is highly refractile, and therefore the conditions obtained when it is the observed material are equalled by but few other substances. It has been determined by calculation that the molecules of certain albuminoids have a diameter of 6 micro-millimetres. Were these of the same optical character as colloidal gold they would therefore be visible, but for the reasons I have already indicated they remain invisible, and are likely to be so until some new method, founded on new principles, is established. The observation of gas molecules is at present much beyond the range of the ultra-microscope; but as the result of a large number of microscopic observations Perrin has demonstrated that in an emulsion of gamboge, the granules being uniform in size, the distribution of the granules at various depths is in accordance with the law connecting the density of gases with their pressure. I am showing an ultra-microscope here to-night, with such granules in a new type of cell which simplifies manipulation very considerably.

Such are very briefly the instrumental limitations in microscopy at the present time, in which theory and practice, within the limits of experimental error, are in agreement. In no optical instrument perhaps has a nearer approach to the theoretical possibilities been attained in practice. The wave theory of light has been the basis of all calculations, and has proved sufficient for our purpose. It has been fruitful in results, but there is no finality even in this, and it is as yet impossible to say where the present suggestions in physical science of a corpuscular basis to account for energy transmissions may lead us. In any case it would be an immense gain if the Fellows of this Society would more generally follow the advances in physics, at least in their elements. In this direction progress is rapid, and as it is dealing with the fundamental principles governing all processes, even vital ones, the necessity of a rudimentary acquaintance with such principles will become more and more necessary. The recent publication of such a book as that by Prof. Darcy Thompson on "Growth and Form," intensely interesting in itself, is even more fascinating because of the suggestions thrown out, and the possibilities it opens up. If I may give a simple illustration of what I mean, the usually accepted method of indicating the path of rays through an optical system may suffice. In nearly all textbooks light is assumed to travel in straight lines, and so far as it indicates the main direction of propagation in a homogeneous

medium the method is accurate. But in microscopic optics the importance of diffraction is now universally recognized, and as you know full well this is the very case in which light does not travel in straight lines, new wave centres are continually being set up. I remember hearing Lord Kelvin say that he had no interest in any theory, however ingenious it might be, in which he could not visualize the processes as they were assumed to occur. In our case the conception of light in terms of wave-fronts, plane, concave or convex helps us enormously. The fact that the interposition of any lens results in a change in the form of wave-front appears to me to simplify the matter. I might pursue this theme far beyond the accustomed limits of a Presidential Address, but time will not permit.

Even at the risk of some repetition we may briefly summarize the position. Resolution is dependent on the effective numerical aperture of our observing system, and the mean wave-length of the illuminant. By the use of a solid cone of illumination it follows that we can resolve structural elements of the order of 3μ apart, and that by the use of oblique light this interval can be halved. In the latter case, however, we are unable to do much more than determine the periodicity of the structural elements, the microscope behaving as an interferometer. The resulting image cannot be regarded as a representation of actual structure, in fact we can go so far as to say that the image bears only a quantitative relation to structure. The resolution of diatoms, therefore, by means of narrow oblique beams, the only practical application that this method has, may be an interesting experiment in physical optics, but it is not microscopy. Visibility may be secured under the most favourable conditions of a particle of the order of 5 micromillimetres in diameter, but the resulting images of objects, ranging in size from the limits of resolution to the limits of visibility, are not such that any idea of form or condition can be established. It is merely a proof that the object exists; other physical tests must be applied to approximately determine their size and state.

As I have an ultra-microscope here to-night, perhaps a brief account of it may not be devoid of interest. It is not a novelty to most of those present, but to some it may be unfamiliar. In principle it is founded on the work of Faraday and Tyndall, a point which we may regard with legitimate pride, although it is no exaggeration to say that the great majority of advances in microscopy have originated, at least in principle, in this country. In 1903 Siedentopf and Zsigmondy introduced the ultra-microscope in the form we are conversant with at present, in which the Tyndall cone is examined by means of a high-power microscope objective. The effectiveness of the appliance is dependent on the concentration of a great quantity of light on a small area, so that only a few of the particles in the field of view are illuminated. The illumination

of the particles in depth is also controlled, to ensure that none above or below the focal plane of the observing objective are brought into view.

The microscope is now a tool found in nearly all laboratories devoted to scientific research, and in that sense its applications are almost universal. But the ultra-microscope is a definite link between the physicist and the microscopist; the method is microscopical, but its applications are mainly physical. The use of ultra-violet light and other radiations in microscopy also demands some physical knowledge. Without some acquaintance with spectroscopic methods for instance, I fail to see how any worker could succeed. We see therefore that in those directions in which advances are probable the physical aspect is in evidence, and may become predominant. Microscopy is not alone in this respect; physics threatens or promises, as we choose to regard it, to dominate the whole range of scientific thought and effort.

There is I think nothing to regret in this, rather should we regard it as a natural evolutionary process. When we know that the molecular structure of crystals can now be determined with accuracy by means of X-rays, it may help us to realize that the term "microscopy" may mean something quite different in the future to what we now understand. It is simply a question of keeping our minds open and in a state of flexibility, to enable us to rearrange our ideas to conform to new conditions.

The following is a description of the early experiments by Tyndall, which I feel sure will be of interest, as it indicates so clearly the line of thought that can be attributed to him:—

It has been long known that light effected the decomposition of a certain number of bodies. The transparent iodide of ethyl, for example, becomes brown and opaque on exposure to light, through the discharge of its iodine. The art of photography is founded on the chemical actions of light; so that it is well known that the effects for which the foregoing theoretic considerations would have prepared us are not only probable but actual.

But the method now to be followed, and which consists simply in offering the vapours of volatile substances to the action of light, enables us to give a vast extension to the operations of light, or rather of radiant force, as a chemical agent. It also enables us to imitate in our laboratories actions which have been hitherto performed only in the laboratory of nature. The substances chosen for examination are so constituted that when their molecules are broken up by waves of light the newly-formed bodies are comparatively involatile. To keep them in the gaseous form these products of decomposition require a higher temperature than the vapours from which they are derived; hence, if the space in which these new bodies are liberated be of a lower temperature than that requisite to maintain the vaporous condition, they will be precipi-

tated, as clouds, upon the beam, to the action of which they owe their existence.

The simple apparatus employed in these experiments will be at once understood by reference to illustration. SS' is a glass experimental tube, which may vary from 1 to 5 feet, with a diameter of 2 or 3 inches. From the end the pipe pp' passes to an air-pump. Connected with the other end is the flask F , containing the liquid whose vapour is to be examined. Then follows a U-tube T , filled with fragments of marble wetted with caustic potash. The carbonic acid of the air is here removed. Finally comes a narrow tube tt' , containing a tolerably tightly-fitting plug of cotton-wool. This

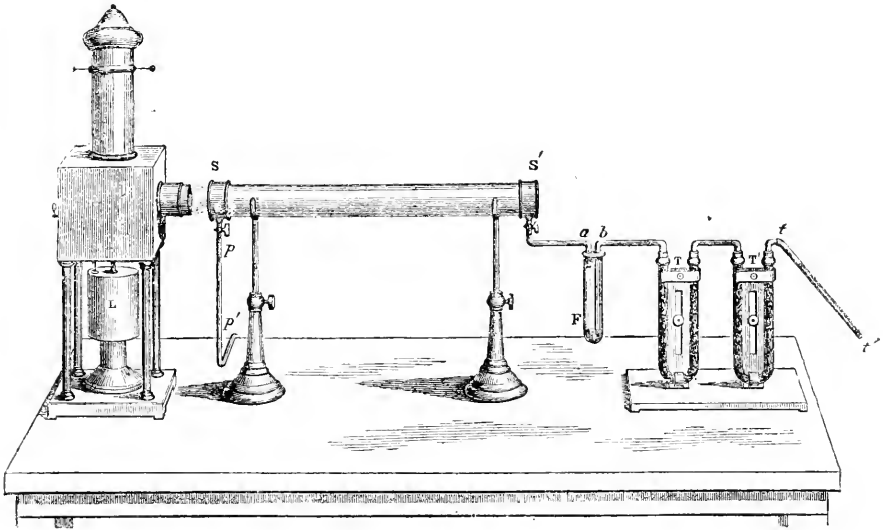

intercepts the floating matter of the air. To save the air-pump gauge from the attack of such vapours as act upon mercury, as also to facilitate observation, a separate barometer-tube is employed.

The experimental tube SS' being exhausted, a cock at the end S' is carefully turned on. The air passes slowly through the cotton-wool, the caustic potash and the sulphuric acid in succession. Thus purified, it enters the flask F , and bubbles through the liquid. Charged with vapour it finally enters the experimental tube, where it is subjected to examination. The lamp L , placed at the end of the experimental tube, furnished the necessary beam.

We will now permit the electric beam to play upon the invisible vapour of nitrite of amyl. The lens of the lamp is so situated as to render the beam convergent, the focus falling near the middle of

the tube. You will notice that the tube appears empty for a moment after the turning on of the beam ; but the chemical action will be so rapid that attention is requisite to mark this interval of darkness. I ignite the lamp, and a luminous white cloud immediately falls upon the beam. The beam has, in fact, shaken asunder the molecules of the nitrite of amyl, and brought down upon itself a shower of particles which flash forth like a solid luminous spear. This experiment, moreover, illustrates the fact that however intense a beam of light may be it remains invisible unless it has something to shine upon. Space, though traversed by the rays from all suns and all stars, is itself unseen. Not even the ether which fills space, and whose motions are the light of the universe, is itself visible.

It is possible to impart to these clouds any required degree of tenuity, for it is in our power to limit at pleasure the amount of vapour in our experimental tube. When the quantity is duly limited, the precipitated particles are at first inconceivably small, defying the highest microscopic power to bring them within range of vision. Probably their diameters are then not greater than the millionth of an inch. They grow gradually, and as they augment in size they throw from them a continually increasing quantity of wave-motion, until finally the cloud which they form becomes so luminous as to fill a room with light. During the growth of the particles the most splendid iridescences are often exhibited. It is not however with the iridescences, however beautiful they may be, that we have now to occupy our thoughts, but with other effects which bear upon the great standing enigmas of meteorology—the colour of the sky and the polarization of its light.

The blue light of the sky is scattered light ; and were there nothing in our atmosphere competent to scatter the solar rays, we should see no blue firmament, but the mere darkness of infinite space. The blue of the sky is produced by perfectly colourless particles. Smallness of size alone is requisite to ensure the selection and reflexion of this colour.

It is possible, as above stated, by duly regulating the quantity of vapour, to make our precipitated particles grow from an infinitesimal and altogether ultra-microscopic size to specks of sensible magnitude ; and by means of these particles, in a certain stage of their growth, we can produce a blue which shall rival, if it does not transcend, that of the deepest and purest Italian sky.

Here, then, we have the fundamental principles governing ultra-microscopic methods and processes, a truly remarkable example of scientific originality and foresight.

We know in practice that under conditions which secure the same magnification, the same methods of illumination, and similar corrections of aberrations in the objective, the best definition and highest resolution is always secured by the lens with the highest numerical aperture. Further, we realize that a reduction in the mean wave-

length of the light used is of value. In terms of N.A. a reduction in wave-length of the illuminant from 550 micro-millimetres to 450 micro-millimetres is equivalent to an increase of the aperture from 1.40 to 1.70 approximately. The most luminous part of the spectrum is the region about 550 micro-millimetres wave-length. In practice the use of screens or other devices which cut out this part of the spectrum seriously reduces luminosity, so that it is necessary when experimenting with colour-screens to have a variable illuminant so that an increased emission of light may be secured to compensate for the inevitable reduction in luminosity. I have reason to believe that this factor, and the varying sensitiveness of the eyes of different observers to different regions of the spectrum, accounts for the variation in results obtained by the use of colour-screens; but in my own case I find such methods invaluable. I am afraid I have taken up too much time with generalities in connexion with ultra-microscopy, but I feel sure that this branch of work has a great future before it. It is usually regarded with a certain amount of awe by the average worker, but I can assure you such an attitude is not justified. It has difficulties certainly, but they are easily mastered. The instrumental needs are not great, and anyone with a taste in that direction could improvise an efficient apparatus without difficulty. In another direction, the use of ultra-violet light and other short radiations, the possibilities are even greater. I have already brought this branch of work before this Society on several occasions, so I will content myself by showing you a few slides of later results. The work has been almost stopped during the war, but I am in hopes of continuing my experiments almost immediately.

To most of us, however, are the limitations I have referred to, the absolute limits that our microscope can attain, the ones we are continually or even occasionally confronted with? I think not. Most of us are confronted with difficulties owing to our failure or inability to take full advantage of the facilities that the microscope offers to us. To obtain the utmost efficiency in ordinary everyday practice the conditions with which we have to comply are relatively simple and few. Firstly, we must have a solid cone of illumination which is sufficiently large to utilize the utmost possible working aperture of our objectives. Secondly, all the optical systems employed, whether objective, eye-piece, or illuminating system, must have their optic axes in exact alignment. This condition of affairs is known in this Society, but not so widely outside it, as critical illumination.

In this connexion it is interesting to note that any want of decentration, if it is only in a lateral direction—by that I mean that the optic axes remain parallel, but are not co-incident—is not so serious as a deflection of one optic axis, so that it is no longer parallel but inclined to the axis of the microscope.

It is obvious, therefore, that the utmost care should be taken to ensure accurate centration, as on this, more than on any other one factor, correct image formation is dependent.

The selection of a suitable light source is also of considerable importance; not only should the illuminant be of such a character that it can be used for any purpose, but it should be so arranged that the intensity can be varied quite apart from any adjustment of the iris-diaphragm of the sub-stage condenser. It is often possible to use a substantially larger cone of illumination if the intensity of the light is suitably moderated. This is particularly evident in dark-ground illumination work, in which it is possible to utilize an objective of considerably greater numerical aperture if the illuminant is not of too great intensity. We all know what is meant when critical illumination is referred to, and there is no necessity for me to go over the ground again. It has been well covered by others more able to deal with it than myself. But I must make some protest against the differentiation between so-called critical illumination and illumination which, for want of a better term, I must refer to as non-critical. What is critical illumination after all? Simply the application of well-known optical principles in a proper manner. Nothing more. Is there any other optical instrument of any complexity in the use of which some special term has to be applied when the conditions are fulfilled for obtaining a correct image? This is really what we do in microscopy. We apply this term of critical illumination to a state of affairs where we are simply doing things properly, and we are content therefore, when not using critical illumination, to put up with a state of affairs that is not in accordance with optical principles, and that we know perfectly well cannot give us an accurate image.

I shall be very glad to know that the term has been dropped at least in this Society, not because I have anything at all to say against the method or the procedure—on the contrary, I think there is everything to be said for it—but we should not adopt a special term to describe a process which is merely the performance of a routine method in a scientific manner.

Before I conclude may I say one word in reference to the Society itself? When you honoured me by electing me as your President, whilst fully appreciating the honour, I felt that the responsibility was considerable. At the time we were at the very worst stage of the war, with all its discomforts and possibilities.

I realized that the period must be one of difficulty, but I think it is a tribute to this Society that we have passed through it so well, and without any results that could be regarded as serious.

The attendance at the Meetings has been quite satisfactory, and the Fellowship has kept up to a remarkable degree. There is one outstanding service that has been rendered to us during

the past year, and that is the re-arrangement and organization of the Cabinet of Slides by Messrs. Earland and Shepherd. It is difficult for those of us who were not at least in partial contact with this work to realize what it involved, and the close application that it entailed. It should be appreciated that this Cabinet is of considerable value, and one to which the Fellows would do well to refer to a much greater extent. Some of the slides are unique, others are of great historic interest, while all, as the result of selection and re-arrangement, are well worth consideration.

It was found, however, that at present there are hardly any workers devoting their attention to the structure of diatoms. Those of us who read the back numbers of our Journal know that many optical improvements in the microscope have taken place as a result of the demand which has been put forward by diatom workers. In endeavouring to re-arrange the slides in the Cabinet of this class it was difficult to find any Fellow with the requisite knowledge who could devote the necessary time to the purpose. I am sure that this is a matter of regret to many of us, and I appeal to those who are not fully occupied with other researches to make an effort to regain for the Society the pre-eminence it once enjoyed in this direction.

Bacteriology is another branch in which I should like to see more work done. It is, I think, erroneously assumed that this involves the use of elaborate laboratory equipment, but a considerable amount can be done with simple apparatus. There is the further point that it generally demands the use of optical appliances and high-power objectives which, to get the best results, must be used at their best. Take, for example, the work that has recently been published in connexion with a group of organisms, if I may refer to them as such, known as "filter-passers," particularly in connexion with trench fever, influenza, and other diseases. On the microscopic side, it is at the very limit of what the finest objectives are capable of doing, using them at their best. But the average bacteriologist rarely takes full advantage of the appliances available. I will not labour the point, but I trust that I have said enough to indicate that there is work to be done, and that the expert microscopist is the one to do it.

Perhaps our greatest need at the moment is for more convenient and better-equipped premises. Our meeting-room is not all that we could wish, and we certainly need better accommodation for the library and instruments. We should have some equipment so that microscopic work of the highest class could be done here, or at least in close connexion with the Society. We should encourage younger men to enter, so that the enthusiasm of youth might act as an antidote to the undue caution of maturity. It might even be advisable to consider the institution of a class of membership which would be open to the young university student or graduate, carry-

ing with it the opportunity of attending meetings and the possession of the Journal for a nominal fee.

From these we should be able to recruit a large body of Fellows while giving encouragement and help to some at the time they need it most. It would be well if we could do as most other scientific societies of standing do: establish one or more memorial lectures to commemorate those worthy of it. Our records show that there would be no difficulty in furnishing names of those whose work deserves to be remembered for generations to come. As it is, the results of their efforts remain, and is a memorial in itself, but it might be made an even brighter example to those following if it were periodically reviewed.

In conclusion, I should like to take this opportunity of thanking the Fellows of the Society for the courtesy and consideration which they have shown me. I am also deeply grateful to the Officers of the Society for their unvarying support. I need hardly say that without an efficient and unselfish staff of Honorary Officers, such as we possess, the Society could hardly exist.

There is at least no controversy on one point. We are able to hold our annual general meeting without the accompanying horrors of war. For that we unite in deep thankfulness.

II.—*Eye-pieces with Adjustable Compensation.*

By H. HARTRIDGE, M.A., M.D., F.R.M.S., Fellow of King's College, Camb.

(Read December 18, 1918.)

ONE DIAGRAM.

THE importance of completely eliminating chromatic difference of magnification has been dealt with in my investigations into the resolving power of the eye (I),* for I found that the presence of this defect had a markedly detrimental effect on definition at the fovea centralis of the eye.

Now, as is well known, microscopic objectives vary greatly in the amount of chromatic difference of magnification which they exhibit. In some combinations the aberration is practically absent, in others (particularly apochromatic objectives of high power) its complete elimination is difficult, if not impossible, while between the two extremes are found a large number which form the semi-apochromatic class.

There is thus found a considerable variation between the amount of correction which different objectives require, and the case is not properly met, therefore, by the provision of two sets of eye-pieces only, namely, compensated and uncompensated; it is necessary, in addition, that the amount of compensation may be varied so that complete correction may be obtained in every case.

The Holoscopic series of eye-pieces, which possess this property of adjustable compensation, are found at the same time to suffer from disadvantages, for not only is change in compensation accompanied by change in position of the lower focal plane, and therefore change in focus of the objective, and change in tube length (accompanied by the introduction of spherical aberration), but also a change in the magnification is found to take place. Now, although the new Holoscopic eye-pieces are better in this respect than the old, still the disadvantages remain, but in a reduced degree. Further, as the Holoscopic eye-piece is of the Huygens type the Ramsden circle is close to the upper surface of the eye lens. This, in high powers particularly, causes inconvenience owing to the closeness of the eye to the top of the eye-piece.

A number of experiments have been made in order to obtain an eye-piece which, while providing adjustable compensation, does

* The italic figures within brackets refer to the Bibliography at end of the paper.

not suffer from the above-mentioned defects. Four typical members of the series have been designed and two actually constructed. Tests of these have shown that the elimination of the difficulties above mentioned has been effected with complete success. The construction of these eye-pieces may be briefly described as follows:—In all powers the top combination is fully achromatized, whether it be a simple doublet or a more complicated system. Similarly in all powers the compensation is provided by a combination of crown and flint glass lenses, which are of equal and opposite power, so that the whole has no focus for rays in the middle of the spectrum. Rays of short wave length are, however, bent towards the axis, while rays of long wave length are bent away from it. This causes images produced by violet and blue rays to be decreased in size, and images produced by red and orange rays to be increased, relative to images formed by yellow and green rays.

Suppose the a-focal combination to correspond with the plane of the virtual image formed by the objective, then it is clear that no change in the relative size of the images produced by different coloured rays has been produced, and the eye-piece is therefore uncompensated. As the a-focal combination is placed further from the image plane, so the relative size of the images is changed. Thus, if it be placed between the image and the eye, then violet images are magnified and red images are diminished (and the eye-piece as a whole becomes more uncompensated); if, on the other hand, the combination be placed below the image (in between the objective and its image), then the effect on the images is reversed and therefore compensation is introduced, the amount of which varies with the distance between the virtual image and the combination.

If in the a-focal combination the negative lens is of flint glass and the positive of crown, then the effects are the reverse of those described above. The series of eye-pieces made according to the above construction will now be briefly described; further particulars are shown in the diagram.

× 4 *Eye-piece*.—This searcher eye-piece is of Huygenian type. It consists of achromatic top lens and bi-convex flint glass field lens; the whole forming an over-corrected compensating system. Between the field lens and the diaphragm is placed the a-focal combination, which consists of negative flint glass lens and positive crown lens of equal power.

When this a-focal doublet is close to the diaphragm the over-correction produced by the flint glass field lens takes effect; when the doublet is slid down close to the field lens, however, its over-correction is neutralized and the eye-piece rendered uncompensating. A "watch glass" is fitted to the top of this eye-piece in order to exclude dust.

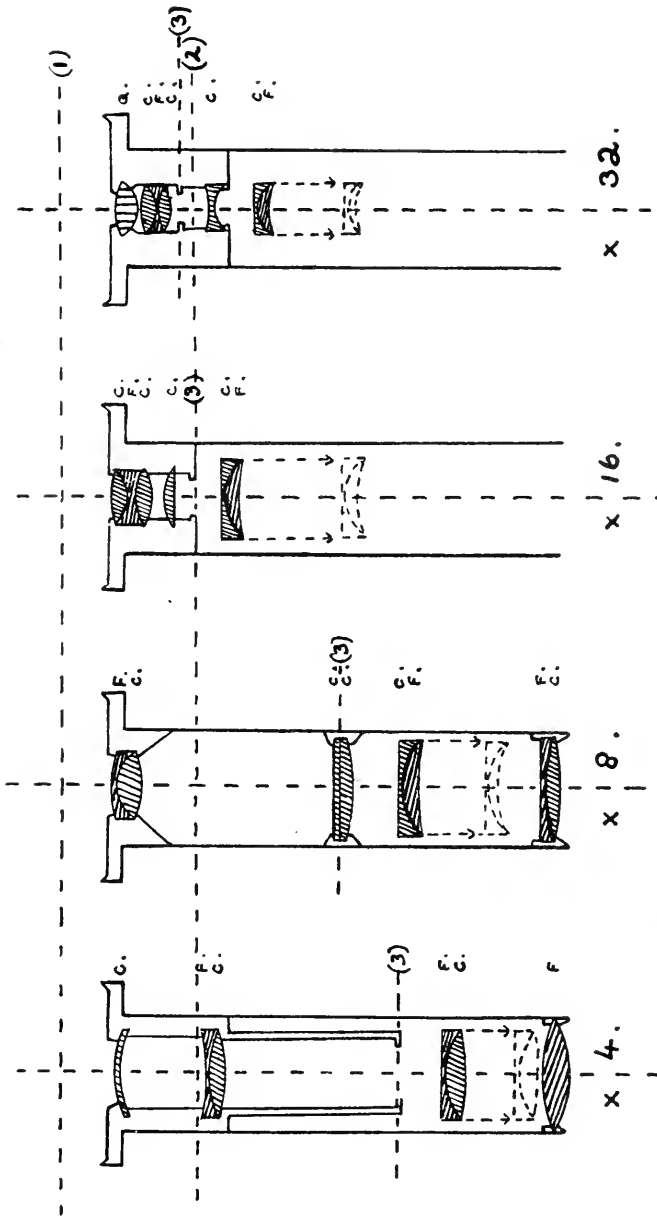

F = FLINT GLASS.
 C = CROWN GLASS.
 G = QUARTZ.

(1.) PLANE OF RAMSDEN DISC.
 (2.) UPPER FOCAL PLANE OF OBJECTIVE
 (3.) LOWER FOCAL PLANE OF EYE PIECES.

× 8 *Eye-piece*.—This medium-power lens is intended to carry a ruled glass micrometer, and is of the Kelner type. It consists of achromatic top lens and plano-convex crown glass field lens, to the plane surface of which is cemented the micrometer. At the lower end of the eye-piece tube is a low-power crown glass lens which renders the eye-piece parfocal with the others of the series, and slightly under-corrected. Between this and the field lens slides the over-corrected a-focal combination. This when close to the field lens neutralizes the under-correction introduced by the bottom lens, thus rendering the eye-piece neutral. On moving the a-focal doublet downward a variable amount of over-correction is introduced.

× 16 *Eye-piece*.—This high-power eye-piece is of the Ramsden type, and consists of an achromatic top combination, formed by an over-compensated triplet and uncorrected field lens. The a-focal combination is mounted so as to be adjustable at varying distances below the diaphragm, thus introducing the required amount of compensation.

× 32 *Eye-piece*.—This eye-piece is intended for objective testing, and like the last is of Ramsden type. The positions occupied by the corrected and uncorrected lenses is reversed, however, so as to place the Ramsden disc as far as possible from the top of the eye-piece.

A short distance below the diaphragm is a crown glass plano-concave lens, the functions of which are—

1. To render this eye-piece parfocal with the others in the series.
2. To magnify the image (in this respect it acts like a telephoto photographic lens).

This lens was found to have two additional beneficial effects: it increased the distance between the Ramsden disc and the top of the eye-piece, and it rendered the eye-piece initially under-compensated.

Below this negative lens is mounted the a-focal combination, which functions as before.

In order to avoid a thick correcting lens with deep curves, it would be an advantage to construct the top lens of some material of low dispersive power, such as quartz, thus reducing the chromatic under-correction which is necessarily introduced.

Of these eye-pieces × 4 and × 16 have been constructed and tested. In both the definition was found to be good and the field flat. Compensation could be easily adjusted, the scope being sufficient for the ordinary range of objectives (including Zeiss apochromatics, except with the × 16 eye-piece, in which the a-focal combination had not been given sufficient power). The variation in compensation was not accompanied by any change in focus, magnification or equivalent tube length. Both eye-pieces were parfocal with others belonging to the author.

In the case of the $\times 16$ eye-piece the Ramsden disc was found to be approximately 4 mm. above the lens (being practically the same distance as that in a $\times 10$ Huygenian eye-piece). This eye-piece, in spite of its high power, was therefore found very comfortable in use.

SUMMARY.

The eye-pieces described possess the property of adjustable chromatic compensation which enables them to be used for all classes of microscopic objective. Unlike the Holoscopic type of eye-piece change in compensation is not accompanied by change in focus, magnification or equivalent tube length. In all powers the change in compensation is effected by the movement of an a-focal combination consisting of a crown and a flint glass lens of equal and opposite power.

The eye-pieces are found to be suitable for ordinary visual work, micrometry and projection.

ADDENDUM.

Since my experiments were completed and the above brief description written, I have found that the use of an a-focal combination has been previously made by Professor Abbé (?). This is described in his words as follows:—

“I therefore added a correcting lens below the eye-piece, a convex flint and concave crown lens cemented together, calculated for neutralizing one another in respect to the middle rays of the spectrum, but with exceeding chromatism of the flint. This lens therefore performs as a plain parallel plate for the middle rays, as a collective lens for the blue, and as a dispersive lens for the red. Inserted at the end of the tube by a suitable adaptor at a short distance from the field lens of the ocular, it introduces, owing to its position, no perceptible aberrations, neither chromatic nor spherical; but it corrects the path of the coloured pencils *outside* the axis by continuously increasing prismatic deflections. This device performs quite satisfactorily with all eye-pieces except very low ones.”

The use of the a-focal combination has therefore been anticipated by Abbé, but not apparently in the precise form that I have adopted—namely, as a *movable* element. In this respect my eye-pieces still appear to be novel.

REFERENCES.

1. HARTRIDGE.—*Journ. Physiol.*, 1918, p. 175.
2. ABBÉ.—*Roy. Micr. Soc.*, 1879, p. 822.

OBITUARY.

H. J. GRAYSON.

MR. H. J. GRAYSON, whose name is familiar to microscopists through his micrometers and test rulings, died on March 21, 1918, at the age of 61 years. Mr. Grayson, who was a native of Yorkshire, visited Australia and New Zealand as a young man, and after a temporary return to England settled in Victoria, where for some years he followed his occupation of horticulturist. He was early attracted to microscopical studies, and made many collections of diatoms from various localities in Australia and New Zealand; he was also skilled in the preparation of botanical sections, and especially of petrological sections, of which he supplied many to the Melbourne University. He first joined that institution as an assistant in the Physiological Department, but was soon transferred to the Geological Department. The highly efficient apparatus used there for preparing rock-sections was designed by Mr. Grayson, whose description of it in the Proceedings of the Royal Society of Victoria was reprinted in the Journal of this Society for 1911 (p. 703), accompanied by a detailed description of his method of working.

Before 1894 Grayson had devoted his attention to the subject of test-rulings on glass, and in that year specimens of the work done by him on a machine designed and constructed by himself were sent to the Royal Microscopical Society and reported upon by Mr. Nelson, who found his rulings to be very accurate, and not showing irregularities in spacing such as are often seen in Robert's plates. (J.R.M.S., 1895, p. 134.) Signs of crystallization or sweating were, however, already perceptible, and in a letter written about that time Grayson explains the experiments made by him with the object of obviating this defect. His best results were gained by using shellac rings thoroughly hardened, and attaching the cover by the application of so much heat as only just sufficed for the purpose. A longer experience, however, satisfied him that the dry mounting plan was never absolutely reliable, and led to his turning his attention to other methods, resulting in his adoption of a process of mounting in realgar. Micrometers and test-plates mounted in this medium, sent to the Society in 1898, and examined by Mr. Nelson, were considered to be the finest yet produced, whether from the point of view of the accuracy of the rulings or the distinctness and brilliancy due to the mounting medium. An accompanying photo-micrograph of

the 10-band plate was pronounced by Mr. Nelson to be the finest photo-micrograph of ruled bands he had ever seen. (J.R.M.S., 1898, p. 690; 1899, p. 122.) Mr. A. A. C. E. Merlin, in his note "On the Measurement of Grayson's New 10-Band Plate," says, "it is doubtful if any production of the kind has hitherto approached so nearly to perfection." (J.R.M.S., 1911, p. 160.)

Other communications regarding these plates in the Journal are: in 1904, p. 393, "On Grayson's 120,000-Band Plate," by E. M. Nelson; in 1910, p. 5, "On the Measurement of Grayson's 10-Band Plate," by A. A. C. E. Merlin; p. 144, "On Measurement of the First Nine Groups of Grayson's Finest 12-Band Plate," by the same writer; p. 701, Note "Grayson's Photo-micrographs of his Rulings," by E. M. Nelson; in 1911, p. 449, "A Report on the Grayson's Ruling presented by Mr. C. Beck to the Royal Microscopical Society," by E. J. Spitta. Other references to the plates and photographs appear in the Journal for 1899, p. 355; 1902, p. 385; 1910, p. 801; 1911, p. 421.

In the volume for 1910, p. 239, is an article by Grayson, reprinted from a local publication, and entitled, "On the Production of Micrometric and Diffraction Rulings." The writer says: "Some years ago I had occasion to use some finely-ruled glass plates, not exceeding 0.01 in. thickness, the lines upon them ranging from 0.02 in. to 0.004 in. apart. These I found were not readily obtainable commercially, so that I had to devise some method of producing them for myself. After a few experiments I soon found I had no difficulty in ruling lines greatly exceeding in fineness and accuracy any of the kind I had hitherto seen, and, as the matter was interesting to me from a microscopical standpoint, I pursued it apart from my immediate requirements." A brief account is given of the apparatus employed, which was largely composed of glass, and which was afterwards much modified, to make it capable of the greatest amount of precision. Lines ruled with it of 120,000 to the inch are the finest so far resolved. The ordinary glass covers were found to be too hard, but Grayson after several trials succeeded in annealing them, making them both softer and tougher. The method of selecting and preparing the diamonds is described, also that of mounting the covers. Grayson says that he tried every, or almost every, known cement and wax-cell, but in every instance the cover-glass sooner or later became coated with minute crystals or beads of moisture. Realgar was then tried, and for a long time without success, but finally the usual method of using it (dissolved in bromine) was abandoned, and after many trials it is claimed that success was obtained by the use of thin films produced by sublimation. A number of test diatoms mounted in this way were exhibited at the Society's meeting in October 1898.

Accounts of Grayson's work having come under the notice of

the officials of the Imperial Board of Trade, he was entrusted by them with certain delicate work in connexion with the official standards of measurement.

Grayson's most important achievement has been the construction of his engine for ruling diffraction gratings, a task to which he devoted much time during several years. This apparatus, for which a special room has been constructed at the University, fitted up with elaborate precautions to secure absolute steadiness and freedom from temperature changes, is very fully described and illustrated in a paper laid before the Royal Society of Victoria in July 1917, wherein are also described in detail the methods of construction, preparation of the diamonds, and other particulars likely to be useful to other experimenters in the same class of work. (Proc. Roy. Soc. Vict., xxx. (N.S.), p. 44-95, pl. vi-xvii.)

It was characteristic of Grayson that whatever work he achieved failed to satisfy him unless his results were at least equal to the best obtained by other workers, and he assiduously studied every process or piece of mechanism in the endeavour to improve upon their procedure. Such microscopical preparations as he produced were always of high quality, his diatom type-slides, for example, being in no way inferior to those of Möller and Thum, while his test-rulings and micrometers, as well as his photographs of them, were, according to the opinions already quoted, in advance of those of his predecessors. It is confidently believed that the same judgment will apply to his last and most important production—the new engine for ruling diffraction gratings.

W. M. BALE.

SUMMARY OF CURRENT RESEARCHES
RELATING TO
ZOOLOGY AND BOTANY
(PRINCIPALLY INVERTEBRATA AND CRYPTOGAMIA),
MICROSCOPY, ETC.*

ZOOLOGY.

V E R T E B R A T A.

a. Embryology, Evolution, Development, Reproduction,
and Allied Subjects.

Ovary of Spermophile.—DELLA DRIPS (*Amer. Journ. Anat.*, 1919, 25, 117-84, 28 figs.). In *Spermophilus citellus tridecemlineatus* ovulation occurs once a year, during the rutting season in early spring. Ovulation is dependent on coitus. The corpora lutea are not present in the ovaries at the rutting time; they develop and pass through their cycle whether fertilization follows or not; while they are present in the ovaries the process of developing and ripening the follicle is at a standstill. The corpora lutea do not seem to influence the mammary gland. The luteal cells are the transformed granulosa cells of the follicle. There is evidence that the corpus luteum has two internal secretions, each with its specific effect on the uterus, one bringing about the changes incident to pregnancy, and the other effecting the normal involution of the organ. The corpora lutea fix the period of œstrus by preventing the development and ripening of follicles until the time for the next rutting season is at hand. J. A. T.

Identical Female Twins in Pigeons from Ova of High Storage Metabolism.—OSCAR RIDDLE (*Journ. Exper. Zool.*, 1918, 26, 227-54). The author has previously maintained that male pigeons arise from eggs (yolks) of lesser storage metabolism (small size and higher metabolism), and female pigeons from eggs (yolks) of greater storage metabolism (large size and lower metabolism). He has now studied two cases of female identical twins which appear to have been produced from ova of high storage metabolism. The proof of this must be indirect, but it is known, for instance, that the eggs which produced the female identical

* The Society does not hold itself responsible for the views of the authors of the papers abstracted. The object of this part of the Journal is to present a summary of the papers as actually published, and to describe and illustrate Instruments, Apparatus, etc., which are either new or have not been previously described in this country.

twins were very large compared with all the others produced by the particular parents (totals of 116 and 134 eggs). The possibility of double-yolked eggs is excluded because in pigeons their production is practically restricted to hybrids from wider crosses, or to birds showing striking reproductive abnormalities, or both, and these would not be expected to appear in the two series in question. It is suggested that the blastoderm-borders will be abnormally raised in extraordinarily large eggs and abnormally lowered in extraordinarily small ones, and that this might be the physical cause of the establishment of two independent foci of development. If male identical twins were to be found developing from a very small egg it would furnish an interesting corroboration of the author's theory. Meanwhile he thinks the data point clearly to the conclusion that each pair of female identical twins arose from a single ovum of high storage metabolism. J. A. T.

Blood-fat and Egg-production in Fowls.—OSCAR RIDDLE and J. ARTHUR HARRIS (*Journ. Biol. Chem.*, 1918, **34**, 161-70). Criticizing the conclusions of Warner and Edmond, the authors point out that there is a progressive change in the nature of the correlation between fat content in the blood of fowls and the total egg records, which is positive for birds in a laying condition, sinks to zero after the cessation of laying, and finally takes a high negative value in birds which have long since ceased to lay. J. A. T.

Effects of Quinine on Production of Yolk and Albumen.—OSCAR RIDDLE and CARL E. ANDERSON (*Amer. Journ. Physiol.*, 1918, **47**, 92-102). When small doses of quinine sulphate are fed to laying ring-doves (*Streptopelia risoria*, *S. alba*, or hybrids of these), the yolk size and total size of the eggs produced are much decreased. Quinine has a known tendency to reduce the destruction of the nitrogenous components of the tissues, as measured by the recovery of nitrogen in the urine. This probably applies to the secretory activity of the pigeon's oviduct, where the product is entirely of protein nature. Furthermore, the presence of quinine in the eggs checks the characteristic transformation of nitrogenous compounds. The reductions and fluctuations in size of the ova are consonant with the view that, in these cases, the size attained is governed by restrictions placed upon the protein metabolism rather than upon the general metabolism. J. A. T.

Œstrous Cycle in Rats.—J. A. LONG (*Proc. Amer. Soc. Zool. in Anat. Record*, 1919, **15**, 352). The length of the cycle averages nearly five days. It is marked by changes in the vaginal and uterine mucosa and by the liberation of ova from the mature follicles. The minute changes are described. The uterus, besides exhibiting changes in its mucosa, becomes at the beginning of the cycle greatly distended by the secretion of clear fluid, in which the spermatozoa become very active. The uterine mucosa is regenerated, at least in part, by mitosis of its cells. Suckling may delay the second ovulation following parturition about 40 days. The first ovulation follows the opening of the vagina by about a day or two. During the first few weeks following puberty

the cycle is longer, 9 to 17 days. The cycles following unfertile copulations are usually 10 to 19 days. Stimulation of the cervix uteri by inserting a glass rod in the first œstrus stage prolongs the next cycle to 11 to 19 days! Perhaps the vaginal plug acts in this mechanical way.

J. A. T.

Wound Healing in Early Embryo of Chick.—C. W. M. POYNTER (*Anat. Record*, 1919, **16**, 1-23, 12 figs.). Wounds of the chick's blastoderm heal with great facility, and the process can be watched for a number of hours in hanging-drop preparations. In wounds of the extra-embryonic blastoderm all the three germinal layers take part in the process, but the ectoderm and endoderm are somewhat more active than the mesoderm. There is de-differentiation, fusion of cells, and re-differentiation. Wounds of the embryo itself heal by de-differentiation of the ectodermal epithelium and the amœboid migration of these cells over the cicatrix. There is no regeneration of the underlying parts, and the endoderm takes very little part. The migration is probably chemico-physical; the covering of the wound is effected without the occurrence of cell proliferation. It would seem that wound repair is a step or phase of the process of regeneration, and that the embryonic dominance is so pronounced that it prevents the wound stimulus from carrying the process beyond this phase.

J. A. T.

Post-mortem Melanin Formation in Eyes of White Ring Doves.—OSCAR RIDDLE and VICTOR K. LA MER (*Amer. Journ. Physiol.*, 1918, **47**, 103-23). In the retina-choroids of white dove embryos of three to twelve days of development, melanin was formed after death. The pigment is not produced in earlier stages, and is not as readily produced, if at all, in the full-term or just-hatched embryos. Killing the tissues in $HgCl_2$ does not prevent the development of the pigment, but the development of free oxygen is necessary in percentages varying between that present in air and 100 p.c. The pigment fails absolutely to form in an atmosphere of CO_2 . It seems probable that the inner ring of iridial pigment disappears when kept after death in the presence of high percentages of CO_2 . The facts of *post-mortem* melanin formation have a bearing on current theories of colour inheritance and development. They coincide with the view advanced by Riddle in 1909 (*Biol. Bulletin*, 1909, **16**, 316), and present difficulties and limitations to the "presence and absence" hypothesis of colour development.

J. A. T.

Brachydactyly in Fowl.—C. H. DANFORTH (*Amer. Journ. Anat.*, 1919, **25**, 97-115, 5 figs.). In certain strains of poultry (and probably in pigeons) there is a close correlation between brachydactyly involving the size and number of bones in the feet, and the presence of feathers on the tarsi. While the size and number of skeletal elements are determined by the length of the embryonic toe, there is no causal relation between toe-length and feathering. The data seem rather to suggest that brachydactyly, feathering of the tarsi, and probably syndactyly, are all dependent on one and the same factor, the nature of which is obscure. It is suggested that a study of the early functioning of the endocrine

glands in normal and abnormal embryos might throw some light on the question. No correlation was seen between either brachydactyly or tarsal feathering and polydactyly and form of comb. J. A. T.

Ultimobranchial Bodies in Pig.—J. A. BÄDERTSCHER (*Amer. Journ. Anat.*, 1919, **25**, 13-23, 4 figs.). The peripheral portion of the ultimobranchial bodies generally develops into typical thyroid structures before its more central portion. The ultimobranchial bodies which can be recognized structurally as such in the thyroid gland of post-natal pigs are mere remnants of these structures that have not fully developed into typical thyroid structures. They consist of nucleated syncytial cords and masses, the central portion of which may be free from colloids. It is probable that there is a genetic relationship between ultimobranchial bodies and large (cystoid) follicles that appear in the thyroid. Only a relatively small portion of the thyroid is derived from the ultimobranchial bodies, but the proportion undoubtedly varies. J. A. T.

Development of Hypophysis.—WAYNE J. ATWELL and IDA SITLER (*Anat. Record*, 1918, **15**, 181-7, 5 figs.). The epithelial portion of the hypophysis consists of three distinct parts: (a) the pars anterior propria, which is the principal epithelial lobe and the bulk of the gland; (b) the pars intermedia, a thin epithelial layer, which becomes intimately associated with the neural lobe; and (c) the pars tuberalis, closely related to the tuber cinereum. The tuberal processes arise from the lateral lobes, which are formed early from the nasal wall of the early hypophysial primordium. J. A. T.

Development of Hypophysis of Reptiles.—E. A. BAUMGARTNER (*Journ. Morphol.*, 1916, **28**, 209-85). The epithelial portion of the hypophysis develops as a single primordium in turtles, lizards and snakes, and probably in alligators. In the development of the evaginations of the hypophysis Ratke's pouch appears first, then two lateral buds, and finally the anterior bud. The lateral buds in turtles give rise to the part termed by Tilney the "pars tuberalis," and to a thin cortical zone around the middle of the anterior lobe; in alligators, to the pars tuberalis and two bands encircling the anterior lobe; in lizards they appear to persist as isolated masses or to disappear; in snakes they completely disappear. The tip of Ratke's pouch gives rise to the pars infundibuliformis (Tilney) or pars intermedia of the adult. The remainder of Ratke's pouch and the earlier anterior bud give rise to the adult anterior lobe, except for the thin cortex or band around it in turtles and alligators. The three parts of the adult hypophysis are distinct histologically as well as ontogenetically. The pars infundibuliformis or pars intermedia has a laminar arrangement of columnar clear-staining cells. The parts derived from the lateral buds are arranged in columns (or sometimes acini) of clear-staining polyhedral cells. The anterior lobe proper is formed of columns or acini, with clear-staining and darkly-staining cells which may be acidophilic or basophilic. In general, the pars intermedia and the parts derived from the lateral buds may be considered the chromophobic and the anterior lobe the chromophilic part. J. A. T.

Development of Hypophysis in Dogfish.—E. A. BAUMGARTNER (*Journ. Morphol.*, 1915, **26**, 301-446, 43 figs.). The several parts of the hypophysis in *Squalus acanthias* are called "anterior lobe," "inferior lobes," and "superior lobe." Ratke's pouch forms the posterior part of the anterior lobe, the rest being due to a later anterior ectodermic invagination. The inferior lobes arise from the sides of Ratke's pouch. The superior lobe develops from the caudal (superior) end of the hypophysial primordium. In the course of development the hypophysis shifts about 145° , so that the upper wall becomes the floor and the ventral (anterior) surface the roof. There is glandular growth from roof to floor. The cells of anterior and inferior lobes are acidophilic, and in general chromophilic. The cell columns of the superior lobe are solid, as Sterzi said. There are spaces with some colloid-like secretion, which also occurs in the lumina of the tubules of the anterior and inferior lobes and in the large main lumen. J. A. T.

Development of Wolffian Body of Pig.—E. J. ANGLE (*Trans. Amer. Micr. Soc.*, 1918, **37**, 215-38, 7 pls.). The two distal portions of each primary tubule and the Malpighian capsule are derived from the Wolffian vesicle. It appears that the first portion of the tubule arises as an outgrowth from the Wolffian duct. The secondary canals and glomeruli arise independently of the primary through a process of differentiation of the Wolffian mesoblast. J. A. T.

Development of Cat's Skull.—R. J. TERRY (*Journ. Morphol.*, 1917, **29**, 281-433, 12 pls.). We cannot do more than select a few conclusions from this careful study of the primordial cranium of the cat. The basal plate of the occipital region is derived from a pair of parachordal cartilages, and from two, probably three, hypochordal commissures or arches. The developmental processes in the occipital region are in principle comparable to those of an atypical vertebra of the atlas kind. The basal plate of the occipital region falls into the category of arch structures, not centra. The condyles belong to the part of the basal plate derived from parachordals, and belong to arch structures. The origin of the cartilaginous pars canalicularis of the otic capsule is independent of other parts of the cranium. The pars cochlearis arises in connexion with the pars canalicularis and the supra-facial commissure. The latter is continuous with the orbito-parietal commissure, and is therefore, in part at least, to be regarded as a parietal structure. The cochlear capsule forms independently of the basal plate, which in the cat is reduced to a narrow bar in the otic region. A pterygoid element appears as a condensation of mesenchyme, in which ossification is occurring at the stage of the 23.1 mm.-embryo. Cartilage is subsequently developed, in which ossification proceeds. There is evidence of two ossific centres, and from these the medial pterygoid lamella and hamular process are formed. Jacobson's cartilage in the cat is the anterior, well-developed, portion of a paraseptal cartilage, connected posteriorly with the lamina transversalis posterior. J. A. T.

Influence of Abnormal Temperature on Developing Nervous System of Chick.—FLORENCE M. ALSOP (*Anat. Record*, 1919, **15**, 307-31, 13 figs.). Excessive heat and a limited amount of heat caused

death in many chick embryos, and various forms of abnormalities in the nervous system of others. Excessive temperatures hastened the development, while low temperatures retarded their rate of growth. The seventy-two-hour chicks did not outgrow any of the abnormalities produced in them at an earlier stage of development. Temperatures between 103° and 108° F. produced 90 p.c. abnormal embryos. Of these abnormalities 46 p.c. were in the head region, 54 p.c. in the neural tube. In eggs incubated at 94° to 101° F., 67 p.c. were abnormal. Of these abnormalities 17 p.c. were in the brain region, 83 p.c. in the neural tube. Incubating eggs at normal temperatures showed nearly 6.5 p.c. of abnormalities, many of which were different from the deformities produced under abnormal temperatures. J. A. T.

Development of Opossum.—CARL HARTMAN (*Proc. Amer. Soc. Zool. in Anat. Record*, 1919, 15, 351-2). In blastocysts of about sixty cells (about twenty-four hours) certain cells in the formative half grow larger and migrate into the cavity, forming the primordium of the endoderm. They multiply and flatten out against the inner surface of the ectoderm. The mesoderm also arises by migration from the undifferentiated superficial layer, forming to begin with a roundish group in the mid-sagittal plane of the embryonic area. J. A. T.

Fenestral Ear Plate in Caudate Amphibia.—H. D. REED (*Proc. Amer. Zool. Soc. in Anat. Record*, 1919, 15, 350). The manner in which the structural elements combine to form the definitive fenestral plate in the ear capsule of tailed Amphibians suggests a division of the order into two legions. The author points out that the perfected apparatus could have been useful only in terrestrial environment, and holds that the living forms which are now aquatic are secondarily so. J. A. T.

Dicephalic Pig.—J. M. THURINGER (*Anat. Record*, 1919, 359-67, 10 figs.). Records of dicephalic monsters mostly refer to calf and man. The author describes *monosomus diprosopus* in a pig foetus. There were two separate cerebral and cerebellar regions, and two fused medullæ oblongata. An account is given of the skull, auditory apparatus, and other parts. J. A. T.

Double Ureters in Pig and Man.—A. G. POHLMAN (*Anat. Record*, 1919, 369-73, 3 figs.). The state of affairs in two pigs with evident ureteral duplication or diverticula is compared with cases in man. The double ureter has a certain embryological importance in that it furnishes a clue to the disappearance of the cloacal segment of the Wolffian duct, and its manner of incorporation into the bladder. J. A. T.

Split Fore-brain in Sheep Embryo.—E. BUJARD (*Rev. Suisse Zool.*, 1918, 26, 245-307, 2 pls., 14 figs.). Of two separate twin-embryos of the sheep, one showed a complete fissure of the prosencephalon (encephaloschisis). This malformation seemed to be due to an amniotic strand which had prevented coalescence of the two sides of the cerebral vesicle. Other malformations were associated, and their morphological interest is very carefully discussed. J. A. T.

Formation of Filum terminale.—G. L. STREETER (*Amer. Journ. Anat.*, 1919, 25, 1-11, 3 figs.). The filum terminale represents that portion of the spinal cord caudal to the second coccygeal segment (31st segment), which has undergone de-differentiation, and has finally become converted into a fibrous strand. This strand, like the sacral nerve roots, elongates by interstitial growth in adaptation to the ascending displacement of the spinal cord. The caudal tip of the dural sac maintains its relation to the vertebræ rather than to the spinal cord, and remains attached to the filum terminale in the sacral region at a more or less fixed point.

J. A. T.

b. Histology.

Vital-staining of Tadpole's Tail.—ELEANOR LINTON CLARK and ELIOT R. CLARK (*Anat. Record*, 1918, 15, 231-56, 4 figs.). Neutral red, Bismarck brown and trypan blue are true vital stains affecting the tadpole's tail. The more highly diffusible dyes, neutral red and Bismarck brown, stain the cells much more rapidly than does the colloidal dye, trypan blue. But the latter can be preserved in permanent preparations. Neutral red and Bismarck brown stain granules in the epidermis; neutral red stains the contents of a richly branching sub-epidermal system; trypan blue does not stain any of the cells of the epidermis; all three dyes stain an occasional granule in the walls of certain blood-vessels; all the three are deposited in the perinuclear areas of the lymphatics, in certain large mononuclear wandering cells and leucocytes, and, to a less degree, on the processes of the stellate connective tissue cells. Cells with the common property of phagocytosis react most readily to the vital-staining.

J. A. T.

Histogenesis of Blood-platelets in Yolk-sac of Pig.—II. E. JORDAN (*Anat. Record*, 1919, 15, 391-406). Blood-platelets are produced in the blood spaces of the yolk-sac and of the liver of the pig embryo by the primitive lymphocytes or hæmoblasts and their giant-cell derivatives, occasionally also by endothelial cells in process of differentiation into hæmoblasts and separation from the vessel wall. The mode of platelet formation is two-fold: (a) by segmentation of pseudopods, and (b) by fragmentation of larger portions of cytoplasm. The giant-cells are essentially hypertrophied hæmoblasts, and in the yolk-sac may function as multiple erythroblasts. Blood-platelet formation appears to be a by-product both of the normal activity and of the disintegration of potentially erythrocytogenic giant-cells. Spindle cells of Ichthyopsid and Sauropsid blood, and platelets of Mammal blood apparently have a similar function in relation to thrombus formation. They may be considered as analogous elements, but no strict homology obtains.

J. A. T.

Origin of Phagocytic Mononuclear Cells.—F. A. McJUNKIN (*Amer. Journ. Anat.*, 1919, 25, 27-53, 3 pls.). These elements are traced by means of injected carbon (lampblack) to the endothelium of the blood-vessels. The demonstration of mitoses in endothelial carbon-containing cells lining capillaries which are not lengthening is proof of

the endothelial origin of phagocytic mononuclear blood-cells. There is negative evidence also, showing that these cells are not of myeloblastic or lymphoblastic origin, and that few phagocytic cells of any variety are present in normal extravascular tissue.

J. A. T.

Structure of Corpus adiposum buccæ.—R. E. SCAMMON (*Anat. Record*, 1919, **15**, 267–87, 9 figs.). This “sucking pad” is a sharply circumscribed mass of fat lobules formed around the radicles of the middle part of the venous plexus which connects the orbital veins with the superficial veins of the face. It appears very early, being mapped out in foetuses 4–5 cm. long. It is a definitely encapsulated area in foetuses 8–10 cm. long; fat-cells appear at this stage, or a little later. They are arranged in lobules which are first found in the periphery of the anterior part of the body. It grows rapidly after the encapsulated area has been established; most of the early growth is due to the expansion of the enclosed mesenchymal and pre-adipose tissue and not to the growth of fat-cells. The later growth is due to an increase in the number of fat-lobules, the formation of new fat-cells, and the growth of individual fat-cells. The finer structure of the fully developed corpus adiposum does not differ from that of ordinary superficial adipose tissue, except that the interlobular septa are somewhat narrower and are arranged radially. The body persists in adult life in the large majority of cases. Its persistence does not seem to be associated with nutrition. There is no evidence for the theory that the body represents the remains of the orbital salivary gland.

J. A. T.

Epiphysis of Dogfish.—NILS HOLMGREN (*Arkiv Zool.*, 1918, **11**, No. 23, 1–28, 2 pls.). In *Squalus acanthias* there are distinct sensory cells projecting into the lumen of the epiphysis. The terminal portion projecting into the lumen varies greatly in appearance and appears to liberate secreted material into the lumen. The sensory cell seems to have in part a secretory activity, the stages of which are described. In the wall of the whole epiphysis there are numerous ganglion cells, but Holmgren found no neuroglia or ependym. The epiphysial nerve strands are described. Very remarkable is the secretion-process of the sensory cells which starts from a formed body that appears in all the sensory cells at certain times. There is then a clear differentiation between an inner and outer portion, the latter with a spiral filament. The terminal portion presents marked resemblance to the rods of eyes, and the author works out the probable homology in detail. It would corroborate the theory which ranks the epiphysis with the eyes.

J. A. T.

Parietal Organs of Frog.—NILS HOLMGREN (*Arkiv Zool.*, 1918, **11**, No. 24, 1–13). An account is given of the terminal vesicle or frontal organ (in the skin) and of the proximal portion, or epiphysis. The latter lies dorsal to the thalamencephalon in the region of the superior commissure between the two habenular ganglia. In both parts or organs three kinds of cells are to be distinguished—sensory, ganglionic and epithelial. These are described and figured in detail. In minute structure there is a close resemblance between the frog's

epiphysis and that of the dogfish. In the course of the pineal tract the frog agrees with Teleosteans and differs from Selachians, for there is neither habenular tract nor epiphysial decussation. J. A. T.

Epiphysis Nerves in Sprat and Herring.—NILS HOLMGREN (*Arkiv Zool.*, 1918, **11**, No. 25, 1-5, 2 figs.). In *Clupea* the habenular nerves are both united with habenulæ, and there is also a posterior commissure connexion. Now this is the sturgeon-stage in the development of the smelt (*Osmerus*), and it persists in some varieties of *Osmerus*; so that *Clupea* may be said to be in this respect phylogenetically older than *Osmerus*. In the development of *Osmerus*, the second stage, the *Amia* stage, shows the left habenular nerve going to the habenula, while the right goes to the posterior commissure. This stage is also represented in some varieties of *Osmerus*. The third stage in the development of *Osmerus*, the Salmonid stage, shows both habenular nerves going to the posterior commissure. The more important variations of *Osmerus* as regards epiphysis nerves may be described as atavistic. J. A. T.

Autotomy in Pocket Mice.—F. B. SUMNER and H. H. COLLINS (*Biol. Bulletin*, 1918, **34**, 1-6, 2 figs.). When a specimen of *Perognathus fallax fallax* is seized by the tail it often gives its body a curious gyrating twist, and the tail breaks across a vertebra (observed in eight cases). There is no regeneration after the autotomy, except that a tuft of hairs grows on the severed stump. Autotomy was also observed in *P. panamintinus bangsi*, a small desert pocket mouse, while in *P. boylei rowleyi* the skin breaks and slips off very readily. In both cases the animal makes what appear like vigorous and well-directed efforts to effect the severance. J. A. T.

Experiments on Tadpoles.—BENNETT M. ALLEN (*Proc. Amer. Soc. Zool. in Anat. Record*, 1919, **15**, 352-3). Tadpoles of *Rana* and *Bufo* from which the first beginning of both thyroid and pituitary glands had been extirpated, developed in precisely the same manner as did those from which the pituitary glands alone were removed. Eight tadpoles were living eight months after the removal of the glands. J. A. T.

Endocrine Glands of Frog and Toad.—BENNETT M. ALLEN (*Proc. Amer. Soc. Zool. in Anat. Record*, 1919, **15**, 353). Tadpoles upon which thyroidectomy had been attempted metamorphosed tardily and were of large size. They showed more or less imperfect thyroid glands. Three operated on for the removal of the hypophysis showed small size at metamorphosis and light colour. They had an imperfect hypophysis. Some other interesting experiments were made. J. A. T.

Endocrine Glands of Toad.—MARY ELIZABETH LARSON (*Proc. Amer. Soc. Zool. in Anat. Record*, 1919, **15**, 353-4). As Rogers showed, extirpation of the thyroid is correlated with increase in the anterior lobe and pars intermedia of the pituitary body. This is confirmed by numerous careful experiments. The minute structure of the pituitary body is notably affected. J. A. T.

Hereditary Ataxia in Pigeons.—OSCAR RIDDLE (*Proc. Soc. Exper. Biol. and Med.*, 1917, 15, 56-8). From an egg produced under the weakening influence of "reproductive overwork" a female pigeon was hatched (in 1914) which showed a marked lack of power over the voluntary movements of the head and body, though this practically disappeared in the adult. The affected female was bred to two different males, and the derangement has been seen through four generations descended from either male. The character appears to be, with some irregularities, a Mendelian recessive. Of 175 young reared to the age at which the disorder might be exhibited, 119 were classed as normal and 46 as affected. J. A. T.

Analysis of Ataxic Brains of Pigeons.—MATHILDA L. KOCH and OSCAR RIDDLE (*Amer. Journ. Physiol.*, 1918, 47, 124-36). The brains of the pigeons referred to above as "ataxic," when compared with those of normal birds of the same parentage, show increased values for moisture, protein and extractive sulphur; decreased values for lipoids, phosphatides and cholesterol. The results of the analyses are interpreted as suggesting a chemical under-differentiation or immaturity of the disordered brains. "The disorder is exhibited in all degrees and has been inherited undiminished to the fifth generation." J. A. T.

Tumours in Climbing Perch.—T. SOUTHWELL and B. PRASHAD (*Records Indian Museum*, 1919, 15, 841-4, 1 pl.). In artificial conditions specimens of *Anabas scandens* may show colloid carcinomas over the surface of the body. They consist of tissue of a thyroid nature, and are rounded structures with a smooth surface. It is impossible to say whether they are directly developed from cells of the thyroid gland or not. A specific organism is suspected, but as yet none has been isolated. J. A. T.

c. General.

Deep-water Fauna of Lake Neuchatel.—A. MONARD (*Revue Suisse Zool.*, 1918, 26, 341-59, 21 figs.). A survey begun in 1916 has already yielded 350 species. Some are quite new, such as a Halacarid genus, *Soldanellonyx* (with two species), three new species of Nematodes, a Bdelloid Rotifer, a Cladoceran, and so on—seventeen new species altogether. Monard reports on *Epistylis violacea* sp. n. (on the head of Chironomid larvæ), *Cothurniopsis canthocampti* sp. n. (borne by *Canthocamptus*), a Rotifer (*Callidina progonulea* sp. n.), a Daphnid (*Peracantha fuhrmanni* sp. n.), and a new variety of *Canthocamptus staphylinus*. The deep-water fauna is turning out unexpectedly rich. J. A. T.

Fauna of Eichener Lake.—R. T. MÜLLER (*Rev. Suisse Zool.*, 1918, 26, 361-408, 3 figs.). An account is given of the environmental conditions in this lake and of its fauna. The list includes about thirty Rhizopods, the interesting Helizoon *Raphidiophrys intermedia* Pén, about nine Ciliata, fifteen Rotifers, three Nematodes, three Chætopods, *Plumatella reptans*, three species of *Macrobiotus*, about a dozen insects, one Phyllopod (the interesting *Tanymastix lacunæ* Guérin), two Ostracods.

Cyclops strenuus, four Amphibians, and a wild duck. The fauna is marked as a whole by the capacity of its components for lying quiescent in the mud or the like during unpropitious conditions, such as drought.
J. A. T.

Colours of Reef-fishes.—W. H. LONGLEY (*Proc. Amer. Soc. Zool. in Anat. Record*, 1919, 15, 350-1). West Indian and Hawaiian reef-fishes are protected by general colour and pattern. A new observation records the fact that some change their coloration as they rise vertically, leaving the bottom and its influence. This is adaptive, like the change of colour associated with horizontal movement. "Nuptial coloration" may be sometimes an index of changed location at that period.
J. A. T.

Reaction of Fishes to H-ions.—V. E. SHELFORD (*Proc. Amer. Soc. Zool. in Anat. Record*, 1919, 15, 347). Experiments show that many marine fishes are exceedingly sensitive to minute differences in the concentration of hydrogen ions. The Pacific herring reacts negatively to 0.8 part per million of sulphurous acid (H_2SO_3) in a manner which indicates an ability to distinguish 0.6 part per million. In this case the difference in H-ion concentration is very slight, probably too slight to be distinguished. Reactions to other chemicals indicate that small amounts of other ions may predominate over small H-ion concentration.
J. A. T.

Are there Varieties of Eel?—O. NORDQVIST (*Arkiv Zool.*, 1917, 11, No. 6, 1-22). The application of biometric methods to a large body of measurements of the common eel (*Anguilla anguilla*) shows that there are considerable differences in the proportions of the body in the two sexes and at different ages. But as regards the existence of narrow-headed and broad-headed varieties the author's results are negative. He points out, however, why he is not prepared as yet to give an answer in the negative.
J. A. T.

Pelvic Structure and Burrowing Habits.—ROYAL NORTON CHAPMAN (*Amer. Journ. Anat.*, 1919, 25, 185-219, 5 pls.). In moles there are horizontal pelves firmly co-ossified to the vertebral column, the ventral margins of the pubes are horizontal and diverge posteriorly, and there is no pubic symphysis. In gophers the same holds, but the symphysis is present in the males and some females. In the marsupial mole the pelvic bones are co-ossified firmly to the vertebral column, the pelvis is horizontal, and the symphysis is greatly reduced. A horizontal pelvis firmly fused to the vertebral column, and the reduction or absence of symphysis, may be correlated with the mechanical force exerted by the hind limbs in propelling the body in continuous burrowing. The horizontal position of the pelvis transmits the locomotive force exerted by the hind limbs along a straight line from the articulation of the limbs to the anterior part of the body. In a similar way the author interprets the reduction of the symphysis, its retention in the pocket gophers, the broad and narrow pelves, the crossing of the rectus abdominis muscles, and so on. From a number of variations in each group

of burrowers the most efficient structure has probably been established by natural selection, but with this interpretation the author would combine the idea that similar forces acting in a similar way have been factors in causing similar modifications of structure in animals belonging to widely different groups, just as tuberosities develop on bones at the points of attachment of muscles of strenuous action. J. A. T.

INVERTEBRATA.

Mollusca.

α. Cephalopoda.

Luminescence of *Watasenia scintillans*.—RINOSUKE SHŌJI (*Amer. Journ. Physiol.*, 1919, **47**, 534-57). In this Japanese luminous squid the luminescence is intracellular in three sets of structures. The luminescence is due to an oxidation. Alcohol, ether and chloroform inhibit the luminescence in a few minutes, though in the first stage of the process they excite the production of light to a certain degree. The power of illumination is quickly recovered on the removal of the narcotics. The most favourable temperature for luminescence is between 16° and 31° C.; direct sunlight has no influence on it; the effect of other environmental factors has been experimentally determined. J. A. T.

γ. Gastropoda.

Sensory Reactions of *Chromodoris zebra*.—W. J. CROZIER and L. B. ABEY (*Proc. Amer. Soc. Zool. in Anat. Record*, 1919, **15**, 345). This Nudibranch reacts locally to tactile and chemical stimuli, to light and shade, and perhaps to heat, through peripheral non-synaptic nerve nets in the gill-plumes and perhaps other parts. It is positively phototropic, probably through the eyes; the branchial collar is also sensitive to light; the rhinophores are directive in relation to currents. Chemotropic responses are important for conjugation. The positive stereotropism of the anterior end of the foot is responsible for righting. J. A. T.

Coloration of *Chromodoris zebra*.—W. J. CROZIER (*Proc. Amer. Soc. Zool. in Anat. Record*, 1919, **15**, 349). The author's experiments go to show that the coloration of this Nudibranch has no "warning" significance, nor "concealing" advantage. It is not homochromic upon natural backgrounds. The animal has an efficient repugnatorial defence, but its coloration is not adaptive. The incidence of various types of injury (from the bites of fishes, etc.) is in no way correlated with the kind, intensity, or distribution of the pigment. J. A. T.

Arthropoda.

Facial Suture of Trilobites.—H. H. SWINNERTON (*Geol. Mag.*, 1919, 103-10, 2 figs.). It is argued that Trilobites form a compact monophyletic group, the members of which at first underwent ecdysis

along a line which may be called the marginal suture. To facilitate the removal of the covering of the eye in moulting, dorsal facial sutures appeared independently in several distinct lines of descent. Taken as a whole the facial suture is composite, being made up of a new dorsal portion intimately associated with the eye, and an anterior portion which is probably a section of the marginal suture. The posterior section of the marginal suture seems to have been completely replaced functionally by the newly instituted line running behind the visual area. The whole of the marginal suture was liable to be resuscitated in forms which, like *Trinuclæus*, became blind secondarily, and thus had no special use for a dorsal suture.

J. A. T.

a. Insecta.

Male Genital Apparatus in Lepidoptera.—R. STANDFUSS (*MT. Schweiz. Entomol. Ges.*, 1914, 12, 201-10). The gripping apparatus and the penis have extraordinarily constant specific characters and may be relied on for purposes of classification. They are thoroughly specific except in a relatively small number of cases where the same male apparatus appears to be present in several distinct species.

J. A. T.

Accessory Genital Parts in Lepidoptera.—L. REVERDIN (*MT. Schweiz. Entomol. Ges.*, 1917, 12, 405-9). Besides androconial scales on the wings and special hairs on certain limbs, there may be in the vicinity of the external genitalia of Lepidoptera special brushes of filaments, prolongations of the last segment, certain glands, etc. They seem to be more frequent in males than in females. In *Thanaos* and some related genera the females have a peculiar accessory apparatus of unknown function. In males of *Danais* and *Euplæa* there is an eversible bundle of fine odoriferous filaments; in *Didonis biblis* and some species of *Eurythela* there are analogous glandular structures. Some Satyridæ have an "organ of Jullien," consisting of a bundle of chitinous rodlets inserted on a lateral diverticulum from the tergite of the eighth abdominal segment, and in *Ageronia* there is an analogous structure. Fritz Müller suggested that it may be sound-producing. In some Nymphalidæ, e.g. some species of *Crenis* and *Eunica*, there are similar chitinous rods, but the function in all cases remains doubtful.

J. A. T.

Olfactory Sense of Lepidopterous Larvæ.—N. E. McINDOO (*Proc. Amer. Soc. Zool. in Anat. Record*, 1919, 15, 344-5). Rapid reaction to odoriferous substances is proved for many caterpillars, and the sense is referred to olfactory pores which were found in thirty species. The average number was sixty-nine. They were invariably found on epicranium, frons, antennæ, mouth-parts, trochanters, and tibiæ, and often on other parts.

J. A. T.

Effect of Light on *Vanessa antiopi*.—W. L. DOLLEY, Jun. (*Proc. Amer. Soc. Zool. in Anat. Record*, 1919, 15, 345-6). Experiments show that at certain flash-frequencies the stimulating effect of intermittent line on this butterfly is greater than that of continuous light of

equal illumination. But the stimulating efficiency depends on the flash-frequency; it may be greater, equal to, or less than that of continuous light.

J. A. T.

Australian Ants of Genus *Onychomyrmex*.—W. M. WHEELER (*Bull. Mus. Comp. Zool. Harvard*, 1916, 60, 45–54, 2 pls.). From among several recent studies of ants by Prof. Wheeler we select his account of three species of this interesting genus. A study of the worker reveals a number of highly-specialized characters. Such are particularly the shape of the mandibles, the vestigial condition of the palpi, the small size of the eyes, and the enlargement of the terminal joint, claws, and pulvilli of the middle and hind tarsi. The powerful, toothed mandibles, long sting, and great hooked claws indicate that their possessors do not feed habitually on small feeble insects like Termites, but on much larger creatures such as the larvæ of Passalids and Scarabæids, and possibly on adult Myriopods and scorpions. An attack on a huge lamellicorn beetle-larva more than 2 inches long was seen. It is not improbable that the colonies move from place to place in search of their prey, like the colonies of the subterranean Dorylinae (*Eciton cæcum* and *Dorylus*), which they very closely resemble in behaviour, colour, sculpturing, and pilosity.

J. A. T.

Hibernation of Flies.—G. S. GRAHAM-SMITH (*Parasitology*, 1918, 11, 81–2). An old house in Lincolnshire showed enormous numbers of “hibernating” flies. “After fumigation a bucketful of flies was removed from a single window-frame, and about six bucketfuls from other infested windows.” This is said to have recurred every winter for twenty-four years. The most abundant fly was *Musca corvina*, but there were four others. There were numerous specimens of the Chalcid *Stenomalus muscarum*. The “hibernating” flies shifted their quarters from time to time and returned again. “They might be present in hundreds on one day and have disappeared on the next.”

J. A. T.

Gynandromorphism in *Drosophila*.—T. H. MORGAN (*Proc. Amer. Soc. Zool. in Anat. Record*, 1919, 15, 357). Gynandromorphs appeared in the ratio of 1 to 2200. There is evidence that nearly all start as females. Practically all the cases appear to be due to the elimination of one sex-chromosome soon after fertilization, but a few cases require the assumption of a bi-nucleated ovum.

J. A. T.

Chromosome Dislocation.—C. B. BRIDGES (*Proc. Amer. Soc. Zool. in Anat. Record*, 1919, 15, 357). In *Drosophila melanogaster* several cases of abnormal inheritance are accounted for by the assumption that in each case a piece of chromosome (the locus of a particular factor) has been taken from its normal position and joined to another chromosome.

J. A. T.

Bionomics of Tsetse Flies.—J. J. SIMPSON (*Bull. Entomol. Research*, 1918, 8, 193–214). There are no defined “fly-belts.” A forest fire only disturbs the tsetse for a short time; the pupæ are not destroyed. The different species of *Glossina* frequent different types of vegetation, which are discussed. Besides mammalian blood, the tsetse flies may

contain that of birds or reptiles. For *G. tachinoides* the large yellowish-brown bat is probably the chief source of the mammalian blood supply. An individual tsetse has been known to fly four miles, but except in this case none returned home from a distance of over two miles. About 59 p.c. returned to the riverside when removed for a mile along the highway. Tsetse flies are destroyed by spiders and dragon-flies, by wasps (*Bembex*), but especially by Asilidæ. J. A. T.

Life-histories of Californian Coccinellids.—CURTIS P. CLAUSEN (*Univ. California Publications, Zoology*, 1916, 1, 251–99). The periods in the life-history of an Aphis-eating Coccinellid in normal summer conditions in California are as follow:—Egg stage, 5 days; first larval stage, 5 days; second, 3 days; third, 3 days; fourth, 6 days; and the pupal stage, 5 days. The number of eggs to be expected under normal field conditions will vary from 200 to 500, or occasionally more, extending over a period of 4 to 8 weeks where the female lives the full adult life under optimum conditions. The period between emergence and mating is 1 to 3 days; from mating to oviposition, 8 to 11 days. Oviposition normally occurs daily. Only one fertilization is necessary during the life of the female, fertile eggs having been produced in one instance 55 days after mating. J. A. T.

Mouth-parts and Mode of Feeding in Louse.—A. D. PEACOCK (*Parasitology*, 1918, 11, 98–117, 1 pl., 6 figs.). A detailed account is given of the mouth, buccal funnel, pumping-pharynx, pumping-pharyngeal tube, pharynx, œsophagus, stabber-sac, Pawlowsky's glands, stabbers and salivary glands. In feeding, the contraction of the buccal and pumping-pharyngeal protractors causes the food canal and stabber-sac to be brought forward. The buccal funnel and the attached pumping-pharynx are brought forward. The dental region becomes everted, so that the hood-like haustellum and the teeth are placed externally; the post-dental region comes to touch the skin of the host. The elements of the pumping-pharyngeal tube also touch the skin; the elements of the sac tube are also brought forward to this point; the contraction of the sac protractors brings the stabbers into play and also influences the sac in a complex way which is tentatively indicated. The structure of the tips of the stabbers produces a lacerated wound. The buccal teeth serve as anchors, but may also help to stretch the skin of the host. The saliva may stimulate hæmorrhage from the wound or prevent coagulation of the blood in the insect. Pawlowsky's glands probably produce a lubricant for the stabbers. The afferent channel for the blood is possibly formed anteriorly by the half-tubes of pumping-pharyngeal tube and the buccal arch, and posteriorly of the pumping-pharyngeal tube alone. J. A. T.

Biology of Lice.—GEORGE H. F. NUTTALL (*Parasitology*, 1919, 201–20, 1 pl., 1 fig.). Experiments with *Pediculus humanus* show that lice, when illuminated by rays of light falling vertically upon them, seek the shade, and a black surface in preference to a light one. In warm weather black clothing is inimical to lice, for it absorbs the maximum of heat rays, and the parasites seek a cooler place. Moreover, the increased

perspiration is inimical, for lice object to excessive moisture in vicinity to man. The most darkly-pigmented specimens of *P. capitis* are derived from dark-skinned black-haired peoples. Head-lice tend to grow paler on yellow or moderately pale races possessing black hair. The palest head-lice are found on white races, whose hair is often light in colour. Pigmentation is dependent upon the nature of the background upon which the insects are raised, and this may have protective value. Pigmentation is not a hereditary character; it may be acquired in a couple of days. The proportion of the sexes varies considerably, depending on conditions which remain to be determined.

J. A. T.

Pupæ of Notodontoidea.—EDNA MOSHER (*Bull. Maine Agric. Exp. Stat.*, 1917, 259, 29–84, 6 figs.). Comparatively little is known of the minuter characters of the pupæ of even common insects. The author has given careful descriptions of the Maine representatives of Geometridæ, Notodontidæ and Platypterygidæ, three families of Lepidoptera in the superfamily Notodontoidea.

J. A. T.

Olfactory Organs of Orthoptera.—N. E. MCINDOO (*Proc. Amer. Soc. Zool. in Anat. Record*, 1919, 15, 343). Olfactory pores always occur on the legs and antennæ (first and second joints); usually on the wings (if present), abdominal segments, cerci, head, mouth-parts; sometimes on the ovipositor. They resemble the lyriform organs of spiders. Some of their borders are radially striated.

J. A. T.

Hermaphrodite Specimen of a Phasmid.—L. CHOPARD (*Bull. Soc. Zool. France*, 1919, 43, 168–75, 4 figs.). A specimen of *Clonopsis (Bacillus) gallica* from Hyères presented in the main external masculine characters, but showed at the same time some feminine features, e.g. a rudimentary oviscapt. It was not possible to study the internal organs. It will be remembered that parthenogenesis is frequent in these Phasמידs.

J. A. T.

Structure of Oocytes of Stone-fly.—WARO NAKAHARA (*Anat. Record*, 1918, 15, 203–15, 9 figs.). In the ovarian ova of *Perla marginata* there are two types of nucleoli. Some have a large single nucleolus, others a number of smaller peripheral nucleoli. The large nucleolus increases with the general growth of the ovum. It may sometimes pass out into the cell body. The small nucleoli, on the other hand, are in all probability due to portions of the yolk nucleus which migrate into the nucleus. There is much to be said for the theory that nucleoli may be formed directly of a material taken up by the nucleus, or may be produced as the result of metabolic processes within the nucleus.

J. A. T.

New Ceylonese Termite.—E. BUGNION (*MT. Schweiz. Entomol. Ges.*, 1914, 12, 193–200, 3 pls.). A finely illustrated description is given of *Eutermes kotuæ* sp. n., including soldier, worker, king, queen, eggs, larva and nymph. The new species is a neighbour of *E. hantanæ*.

J. A. T.

Termitoxenia.—E. BUGNION (*MT. Schweiz. Entomol. Ges.*, 1914, 12, 218–20). The members of this aberrant Dipterous genus are commensals of fungus-eating Termites. They are marked by their rudimentary wings, and by their large, transparent, recurved abdomen. There does not seem to be a cutaneous secretion for the Termites, but a secretion may come from the food-canal. The food seems to be the same as that of Termites, namely fungi. There are three Malpighian tubes, an unusual number. The hermaphroditism alleged by Wasmann and Assmuth was not confirmed by Bugnion. Perhaps a spermatheca has been mistaken for a testis.

J. A. T.

β. Myriopoda.

Food of a Millipede.—E. RABAUD (*Bull. Soc. Zool. France*, 1919, 43, 155–6). Not much is known in regard to the diet of Myriopods. In the case of *Schizophyllum mediterraneum* Rabaud observed that the animal browsed on a mould (*Oidium*) growing on the leaves of an oak-tree, and proved experimentally that a diet of lichens is relished. The captive specimens also ate figs and apples.

J. A. T.

Lithobiid Genera.—RALPH V. CHAMBERLIN (*Bull. Mus. Comp. Zool. Harvard*, 1916, 117–201). From a number of papers by this investigator we select one on the Lithobiid genera *Oabius*, *Kiberbius*, *Paobius*, *Arebius*, *Nothenbius* and *Tigobius*, small forms almost confined to the Pacific coast region of North America. A useful general account is given of the life-history. The eggs of Lithobiids are rich in yolk, relatively large, spherical or sub-spherical. They are laid, as in *Oabius pylorus*, one at a time. As each is passed out it is ordinarily grasped between the claws of the gonopods and often carried about for a short time, so that dirt adheres to its sticky surface and renders it difficult of detection. The females pay no attention to the eggs after they have been deposited, whereas Epimorphous centipedes coil round the egg-mass. The author distinguishes a long series of post-embryonic stages up to the attainment of the full number of legs.

J. A. T.

δ. Arachnida.

Mites in Culture Tubes.—G. BILLIARD (*Bull. Soc. Zool. France*, 1919, 43, 175–8). In culture tubes with various kinds of bacteria, which had formed part of a military laboratory, the media were found to contain eggs, larvæ, and fully-formed specimens of *Aleurobius farinæ* and *Tyroglyphus siro*, along with moulds. The mites must have made their way through the cotton-wool, and they must have brought the spores of the moulds in with them. The tubes were in effective new boxes, and the probability is that flies brought the mites on to the cotton-wool. Indeed, investigation showed the presence of mites (of the two species named and of others) on the legs of the flies.

J. A. T.

Study of *Amblyomma dissimile* Koch.—G. E. BODKIN (*Parasitology*, 1918, 11, 10–18, 1 pl., 1 fig.). This tick was reared on a

toad, *Bufo marinus*. Oviposition beginning on October 22 continued regularly for about sixteen days; the females were dead on November 18. The eggs are light brown, ellipsoidal, smooth and shining. The larvæ are active, but feign death on being violently disturbed. They await their host with the front pair of legs extended above and in front of their bodies. A total life-cycle takes roughly 153 days. The male thrusts his mouth-parts, with the exception of the palps, into the genital aperture of the female, and sets up probing movements enlarging the aperture. The spermatophore from his genital aperture is guided in. The males largely predominate in numbers. There is no doubt that parthenogenesis occurs, probably producing females only. J. A. T.

Reactions of Whip Scorpions.—BRADLEY M. PATTEN (*Proc. Amer. Soc. Zool. in Anat. Record*, 1919, 15, 346-7). By comparing the changes from the normal reaction induced by elimination of the various photoreceptors—median eyes, lateral eyes, and cutaneous sensitive areas—their relative effectiveness was estimated at 1 : 1.6 : 2.2. J. A. T.

Colour Adaptation in Spiders.—E. RABAUD (*Bull. Soc. Zool. France*, 1919, 43, 195-7). A study of *Misumenia vatia* and *Thomisus onustus* shows that these two spiders have only yellow chromatophores, that in darkness or on a white ground all lose their yellow colour but keep their red spots (not in chromatophores), that harmonious colouring with particular flowers is a coincidence and of no value. Experiments show that the loss of the yellow colour, which depends on the illumination, is brought about through the eyes. J. A. T.

6. Crustacea.

Study of Tanyrastix lacunæ Guérin.—R. T. MÜLLER (*Revue Suisse Zool.*, 1918, 26, 361-408, 4 figs.). This interesting crustacean, reported from Lake Eichener, is a Branchipod and a neighbour of *Branchipus*. The author discusses its distribution, the conditions of its life, its life-history, and habits. J. A. T.

Rarity of Sex Intergrades in Cladocera.—ARTHUR M. BANTA (*Proc. Amer. Soc. Zool. in Anat. Record*, 1919, 15, 355-6). Fifteen sex intergrade strains of *Simocephalus vetulus* were reared for three years (sixty-five generations), but among the thousands of individuals examined no case was observed. Six sex intergrade strains of *Daphnia longispina* were reared from some thirty-six generations, but among thousands of individuals examined there was only a sparing occurrence of intergrades. It is evidently a rare phenomenon. J. A. T.

Gynandromorph Daphnids.—R. DE LA VAULX (*Bull. Soc. Zool. France*, 1919, 43, 187-94, 2 figs.). A study has been made of twenty-four gynandromorphs of *Daphnia atkinsoni*. In all cases the gonads were normal ovaries; in three cases the ova were degenerate, and in two of these cases rudiments of vasa deferent were seen. There was great diversity in somatic characters, especially as regards the anten-

nules. All sorts of intermediates between males and females were seen. The gynandromorphism appears to be induced by conditions of defective nutrition.

J. A. T.

New Parasitic Copepods.—T. SOUTHWELL and B. PRASHAD (*Records Indian Museum*, 1918, **15**, 352-5, 1 pl.). A description is given of the female of *Ergasilus bengalensis* sp. n. from the gills of *Wallago attu*. No males were found. Another form, *E. hamiltoni* sp. n., was found on the gills of the climbing perch, and was represented by females only. Excellent figures are given.

J. A. T.

New Copepod Parasite of Cod.—W. HAROLD LEIGH-SHARPE (*Parasitology*, 1918, **11**, 118-26, 8 figs.). A description is given of *Clavella sciatherica* sp. n., a Lernæopodid from the mouth, pharynx and branchial region of a cod. It differs from all the twenty-six valid species of *Clavella* in combining several of the prominent characters of other species. Noteworthy is the extreme length of the backwardly arched cephalothorax taken together with the reduction of the "arms" (second maxillæ) and their expansion into a disc so that the "bulla" or button appears to be almost directly affixed to the body. Both sexes were found.

J. A. T.

New Species of Lernæopoda.—W. HAROLD LEIGH-SHARPE (*Parasitology*, 1918, **11**, 18-28, 11 figs.; and 29-34, 3 figs.). From three dogfishes (*Scyllium canicula*) there were obtained the females and accompanying males of *L. scyllicola* sp. n. The male larva is temporarily attached to the fish; the mature form moves slowly on to the female and remains there. A description is given of the male's appendages, and of its nervous, alimentary, and reproductive systems. From the same host the author obtained *L. globosa* sp. n., and a description of the female is given.

J. A. T.

Life-history of Cyclops.—ESTHER F. BYRNES (*Proc. Amer. Soc. Zool. in Anat. Record*, 1919, **15**, 342-3). There are nine stages and eight moults in *C. signatus* (*C. albidus* Jurine) and *C. americanus* Marsh. There is a typical nauplius; the second stage has a fourth appendage; the second moult produces indications of the fifth and sixth appendages; the third moult yields a typical cyclops stage with six antennal segments, mouth-parts as in adult, and unsegmented swimming appendages; the fourth moult shows seven antennal segments, rami of first and second feet two-jointed; the fifth moult shows nine antennal segments; the sixth, ten and all the feet two-jointed; the seventh, eleven; the eighth, seventeen. Elongation of parts is due to intercalation of segments. The duration of the metamorphosis varies considerably up to ten weeks.

J. A. T.

. Annulata.

New Species of Rhynchelmis.—F. SMITH and L. B. DICKEY (*Trans. Amer. Micr. Soc.*, 1918, **37**, 207-14, 1 pl.). A description is given of *Rhynchelmis elrodi* sp. n. from Western Montana. Some of

its characters ally it closely with the Eurasian species of *Rhynchelmis*, while others link it to *Sutroa* and *Eclipitrilus*. A modification of the definition of the genus is proposed. J. A. T.

New North American Species of Haplotaxis.—FRANK SMITH (*Bull. Nat. Hist. Survey, Illinois*, 1918, **13**, 43-8, 1 pl.). A description is given of *Haplotaxis forbesi* sp. n., from the Illinois River, and of the reproductive system of *H. emissarius*. J. A. T.

North American Representative of Trichodrilus.—JAMES E. KINDRED (*Bull. Nat. Hist. Survey, Illinois*, 1913, **13**, 49-52). A small Lumbriculid, probably *Trichodrilus allobrogum* Claparède, was pumped up from a well in Concord, Illinois. It is the first representative of Lumbriculidæ as yet recorded from North America. Diagnoses of the three European species of *Trichodrilus* are given. J. A. T.

Bryozoa.

Fossil Bryozoa of Panama Canal Zone.—F. CANU and RAY S. BASSLER (*Bull. U. S. Nat. Mus.*, 1918, **103**, 117-22, 1 pl.). Descriptions are given of the few Bryozoa that have been found as yet in the rocks of the Panama Canal zone and related areas. The list includes *Ogivalina mutabilis* sp. n., *Stichoporina tuberosa* sp. n., two species of *Cupularia*, and *Holoporella albirostris* (Smitt). J. A. T.

Nematohelminthes.

Nematode Parasite of Chicken.—L. D. WHARTON (*Philippine Journ. Sci.*, 1918, **13**, 219-21). In the proventriculus of a chicken in the Philippines a number of Nematodes were found, belonging to the species *Tetrameres fissispina*. As in other species of this genus there is marked sex dimorphism, the males being long, slender white worms, and the females sub-globular and red. The female worms lie embedded in the glands: the males are free or with one end in a duct. They are much smaller than the females, and seem to be much less numerous. They probably die after pairing. The same Nematode has been found in the duck (*Anas boschas*) and the coot (*Fulica atra*). J. A. T.

Life-history of Ascaris lumbricoides.—B. H. RANSOM and W. D. FOSTER (*Proc. Amer. Soc. Zool. in Anat. Record*, 1919, **15**, 341-2). The results reached by Stewart have been confirmed and supplemented. The swallowed eggs hatch in the intestine; the larvæ reach the portal vein; they pass by the circulation to the lungs, where they undergo considerable development. By the trachea and the œsophagus they reach the intestine, developing slowly to maturity if the host be suitable, passing out and dying if the host be unsuitable (rat, mouse, guinea-pig, rabbit). Lung-troubles may be caused in children; fatal pneumonia in pigs. In lambs and young goats the *Ascaris* of the pig can develop much further than in rats and mice, and may approach maturity. Eggs injected subcutaneously will hatch, and the larvæ may reach the lungs. J. A. T.

Platyhelminthes.

Parasitic Rhabdocœl.—M. CAULLERY and F. MESNIL (*Bull. Soc. Zool. France*, 1919, **43**, 198-204, 3 figs.). In the intestine of *Haplo-syllis hamata* the authors found a Rhabdocœl Turbellarian, a single specimen, apparently a parasite. There are some analogous cases, but

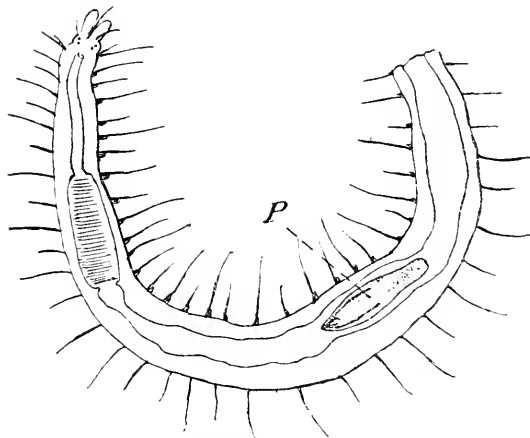

Anterior end of *Haplo-syllis hamata*, showing at P the parasitic Rhabdocœl lying in the alimentary canal.

they are few. In its diffuse, strongly developed yolk-gland, and in the granular sub-ectodermic cells, the parasite here described, visible to the naked eye as a golden-yellow spot, recalls the genus *Fecampia*, but the authors are cautious. J. A. T.

Transmission of Fowl Tapeworms.—JAMES E. ACKERT (*Proc. Amer. Soc. Zool. in Anat. Record*, 1919, **15**, 341). The house-fly, *Musca domestica*, may transmit to chickens a tapeworm which seems to be *Davainea tetragona*, and another species, *D. cesticillus*. The flies were trapped at local poultry-yards where the chickens were known to be infected; they were fed to seventeen isolated chickens whose other food was carefully scrutinized; four chickens have been examined, and two were parasitized by the tapeworm. J. A. T.

Fish Trematodes.—T. SOUTHWELL and B. PRASHAD (*Records Indian Museum*, 1918, **15**, 348-51, 1 pl.). A small collection of encysted larval Trematodes is described, and an account is given of *Clinostomum piscidium* sp. n. from the mesentery of *Trichogaster fasciatus* and *Nandus nandus*. The hermaphrodite nature of the worm, the two suckers, the position of the acetabulum, the situation of the ovary between the two testes (which are non-digitate), the genital pore being situated

posterior to the acetabulum, and the intestine having short lateral projections, place the worm undoubtedly in the genus *Clinostomum* Leidy. But it differs from all previously described species. J. A. T.

Cuticula and Sub-cuticula of Trematodes and Cestodes.—H. S. PRATT (*Proc. Amer. Soc. Zool. in Anat. Record*, 1919, 15, 342). Both cuticula and sub-cuticula belong genetically to the parenchyma, and are mesenchymatous, not ectodermic. Warts on the tail of a *Cercaria* (*C. fusca*) lie outside of the layers of longitudinal muscle and sub-cuticular cells, and are composed exclusively of the peripheral portion of the parenchyma. J. A. T.

Cercariæ of Transvaal.—F. G. CAWSTON (*Parasitology*, 1918, 11, 94-7). Examination of numerous specimens of fresh-water snails (e.g. *Isidora*) showed the presence of various kinds of Cercariæ (*C. arcuata*, *C. frondosa*, *C. glauii*, etc.), and it was found that snails from flowing rivers were less infected than those in stagnant water. Lime in the river-bed seems also inimical. This will account for the relative infrequency of Bilharziasis along the Vaal river, as compared with its occurrence in those portions of the Low Veldt through which the Crocodile river and its tributaries flow. J. A. T.

Bilharziasis in Natal.—F. G. CAWSTON (*Parasitology*, 1918, 11, 83-93). Cercariæ of *Bilharzia*, similar to those which cause Bilharziasis in Egypt, occur in Natal in *Physopsis africana*, but it is rare to find a person whose life has been shortened by the disease. Specimens of the snail exposed to infection from the urine of *Bilharzia* patients show an increase in the number of infected forms. J. A. T.

Incertæ Sedis.

Notes on Gastrotricha.—E. H. CORDERO (*Physis. Rev. Soc. Argent. Cienc. Nat.*, 1918, 4, 241-55, 1 pl.). A description is given of a

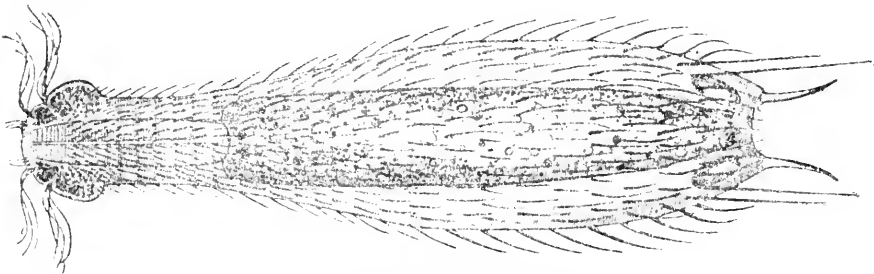

FIG. 1.—*Chætonotus montevidensis* sp. n. $\times 500$.

number of these imperfectly known animals, which Cordero ranks near Rotifers. Those described are from near Montevideo, Uruguay, and

include *Lepiloderma squammatum* (Dujardin), *Chætonotus montevidensis* sp. n., *C. formosus* (A. C. Stokes), *C. larus* (O. F. Müller), and *Proichthyidium coronatum* g. et sp. n. In the new genus the head is sharply

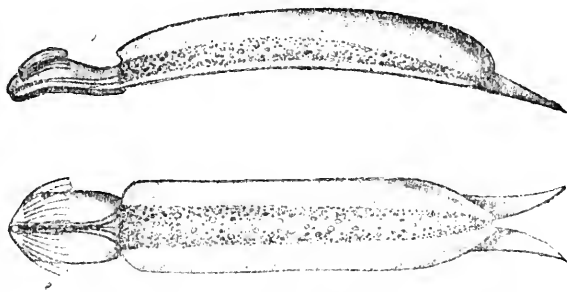

FIG. 2.—*Proichthyidium coronatum* g. et sp. n. $\times 500$.

separated from the body without there being any neck; the cuticle is smooth; there are no appendages except a pair of mobile caudal falciform blades. A general classification is given. J. A. T.

Echinoderma.

Asexual Multiplication in *Coscinasterias tenuispina*.—W. J. CROZIER (*Proc. Amer. Soc. Zool. in Anat. Record*, 1919, 15, 344). Asexual multiplication of this starfish occurs by spontaneous division of the body, and is at a maximum during the summer midway between the sexual periods. The formation of new rays at a division-surface is frequently accompanied by the appearance of new madrepores, and the number of madrepores is positively correlated with the total number of rays, as if there were some functional relation. J. A. T.

Porifera.

Buds in Sponges.—W. J. CROZIER and BLANCHE B. CROZIER (*Proc. Amer. Soc. Zool. in Anat. Record*, 1919, 15, 344). In *Coppatias millbrooki* sp. n. buds are formed like *Donatia* buds ("Tethya"-buds), and it is interesting that the species inhabits mangroove creeks, harbouring three well-differentiated types of *Donatia*, all reproducing by buds—a rare method in marine sponges. J. A. T.

New Sponges from Spain.—F. F. HERNÁNDEZ (*Revista R. Acad. Cienc. Madrid*, 1918, 16, 1-8, 1 pl., 5 figs.). Three littoral sponges are described—*Leucandra sulcata* sp. n., *L. riojai* sp. n., and *Artemisina hispanica* sp. n. Drawings of the spicules and photographs of the entire sponges are given. J. A. T.

Protozoa.

Protozoa of Manila.—F. G. HAUGHWOUT (*Philippine Journ. Sci.*, 1918, **13**, 175–214). A useful introduction to the study of the Protozoa is given, including a discussion of their definition, their classification, and the best ways of collecting, cultivating and mounting them. A census of Philippine forms is planned. J. A. T.

Variations in Arcella.—R. W. HEGNER (*Proc. Nat. Acad. Sci.*, 1918, **4**, 283–8, 2 figs.). Jennings has shown that the descendants of a single specimen of *Diffugia* may be separated into a number of diverse lines that differ from one another in their heritable characteristics. Hegner finds that within a large family of *Arcella dentata* produced by

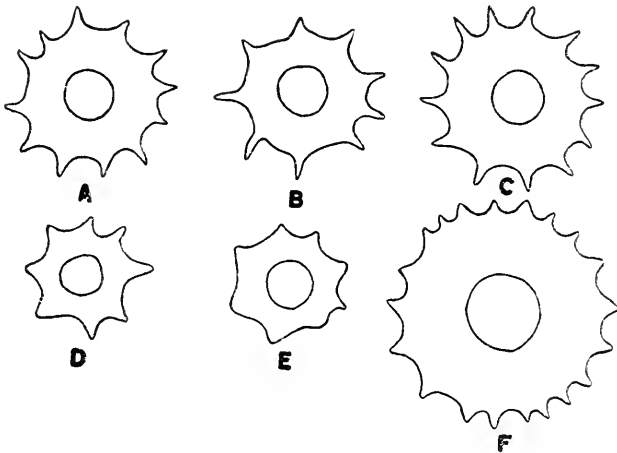

Outlines of specimens of *Arcella dentata* belonging to one family.

- A. The progenitor of the entire family. B. A typical member of the low line E. C. A typical member of the high line A. D. The small progenitor of one of the lines. E. A small specimen from one of the lines. F. The largest specimen of the same line.

vegetative reproduction from a single specimen there are many heritably diverse branches. These diversities are due both to very slight variations and to sudden large mutations. The formation of such hereditarily diverse branches appears to be a true case of evolution observed in the laboratory, and occurring in a similar fashion in natural conditions. In all 6474 specimens were studied. J. A. T.

Nuclear Re-organization in Arcella.—H. M. MACCARDY (*Proc. Amer. Zool. Soc. in Anat. Record*, 1919, **15**, 356–7). A given individual produces a limited number of daughter-cells (0–27), which do likewise, till “depression” sets in. Individuals passing successfully through this may give rise to mutations or may continue the old line. Nuclear reconstruction may occur during depression and during conjugation. J. A. T.

Excretion Crystals in Amœba.—A. A. SCHAEFFER (*Proc. Amer. Soc. Zool. in Anat. Record*, 1919, **15**, 347). Nearly all species contain visible crystals, usually in a vacuole, nearly always optically active, differing specifically, of uncertain chemical composition, probably excretory but not excreted, either remaining permanently or undergoing solution.

J. A. T.

Entamœba histolytica.—D. WARD CUTLER (*Parasitology*, 1919, **11**, 127-46, 1 pl. 1 fig.). The changes that the nucleus undergoes preparatory to division, and the behaviour of the karyosome during division, are fully described. The nuclei originally described as characteristic of two species, *E. histolytica* and *E. tetragena*, are phases of nuclear change in the life-history of the same animal. An account is given of the nuclear division and the cyst-formation. The chromatoid bodies are not comparable with the chromidia of other Rhizopods. Reasons are adduced for the suggestion that during the further development of the cysts quadrinucleate amœbæ emerge, which divide to form four small amœbulæ. Degeneration in *E. histolytica* is described, and the view of Darling, that budding phenomena are degenerative, is confirmed.

J. A. T.

Respiration in Paramecium.—E. J. LUND (*Proc. Amer. Soc. Zool. in Anat. Record*, 1919, **15**, 346). Feeding a starving individual with yeast or yolk of egg increases the rate of CO₂ production two or three times. This acceleration of the oxidations occurs in the absence of cell-division. It is suggested that the acceleration of the oxidations subsequent to fertilization in the Echinoderm egg may be due to the yolk becoming available for assimilation by the living protoplasm of the egg.

J. A. T.

Spirochæte of Infectious Jaundice in English Rats.—A. C. COLES (*Parasitology*, 1918, **11**, 1-9, 1 pl.). Out of 100 common rats (*Mus decumanus*) killed in or near Bournemouth, nine contained in their kidneys *Spirochæta icterohæmorrhagiæ*, which causes infectious jaundice. In one case there was a short, rigid, and thick spirochæte, which may be *S. morsus muris*, the organism of rat-bite fever.

J. A. T.

Trypanosomiasis of Camels.—W. L. YAKIMOFF and OTHERS (*Parasitology*, 1918, **11**, 35-80, 3 pls.). An account is given of the trypanosome of camels in Russian Turkestan. It can infect many mammals and some birds. The course of the disease is acute in mice, rats, and dogs; sub-acute in guinea-pigs, rabbits, and horses; chronic in sheep and large cattle. The parasite approximates to the general type of the Nagana and Surra trypanosomes. Multiplication is by longitudinal fission.

J. A. T.

Indian Myxosporidia.—T. SOUTHWELL and B. PRASHAD (*Records Indian Museum*, 1918, **15**, 344-8, 1 pl.). A description is given of the cysts and spores of *Myxobolus rohütæ* sp. n., *M. seni* sp. n., *M. modularis*, from Indian fishes, and also of a species of *Spærophora* with rounded bicapsulate spores.

J. A. T.

Selysina perforans Dub.—O. DUBOSCQ (*Arch. Zool. Expér.*, 1918, 58, 1-53, 1 pl., 11 figs.). An account is given of this remarkable Sporozoon from the Ascidian *Stolonica socialis*. It occurs in various stages—spores, sporozoites, nodular cysts, small cysts, large persistent cysts—in the blood corpuscles or in the giant cells of the adult Ascidian, or in the statoblasts (dormant buds). A tentative account of the complicated life-cycle is given, but the sexual reproduction remains unknown. It seems that *Selysina* has affinities with Gregarines, Coccidia and Sarcosporidia. Provisionally it may be ranked near the Coccidiomorpha.

J. A. T.

Coccidia Parasitic in Man.—CLIFFORD DOBELL (*Parasitology*, 1919, 11, 147-97, 1 pl., 2 figs.). An inquiry into all the recorded cases of human coccidiosis and a study of the coccidia themselves have yielded a much-needed revision. There are four distinct species which may parasitize man:—(1) *Isospora hominis* Rivolta, 1878 (emend.), discovered by Kjellberg in 1860, and recently investigated by Wenyon; (2) *Eimeria wenyoni* sp. n., a form discovered in 1915 by Wenyon; (3) *Eimeria oxyspora* sp. n., here described for the first time; and (4) an undetermined species of *Eimeria* (?) which was discovered by Gubler in 1858. This last inhabits the liver; the three others probably live in the small intestine. Probably some seventy cases of infection with *Isospora* have been seen; the others appear to be extremely rare. The four are peculiar to man, and there is no evidence that there are others in man. There is no proof that the coccidia of man—with the probable exception of the species occurring in the liver—can produce a clinically recognizable condition of "coccidiosis." No eradicating treatment is known.

J. A. T.

Fossil Foraminifera from Panama.—J. A. CUSHMAN (*Smithsonian Inst. U.S. Nat. Mus. Bull.*, 1918, 103, 89-102, pls. 34-45) describes from Eocene horizons of the canal zone in Panama six Lysidocyclinae, four of which are recorded as new, and for the last of which, *L. duplicata*, he proposes a new sub-genus Multicyclina. He finds a new genus *Heterostiginoïdes* upon a form to which he gives the name *H. panamensis*. He describes an *Orthophragmina* and two *Nummulites*, all of which are recorded as new species, and a new species of *Orbitolites*, *O. americana*. The paper is admirably and profusely illustrated, but we cannot help deploring the erection of new species of these very variable forms upon minor variations which are to be met with in all the typical and accepted forms of these fossils. *O. americana* is illustrated by three excellent plates, but we should have no hesitation in referring the tests to *O. complanata*.

H.-A. & E.

Fresh-water Rhizopoda of Sydney and Lismore, N.S.W.—G. I. PLAYFAIR (*Proc. Linn. Soc. N. S. Wales*, 1917, part 4, 633-75, pls. 34-41 and 7 text-figs.) describes these organisms from ninety gatherings from the named localities, made from Sphagnum, Pond Weeds, Plankton (Sydney Water Supply) and Swamp—which includes all ground-collections. This admirably illustrated paper is evidently the work of a keen and industrious observer, but the author seems to be infected with

the mania for establishing new genera and species upon very minor variations from type. Among the 125 species and varieties which he records and describes, we find the already overburdened nomenclature of the fresh-water Rhizopoda enriched with two new genera, twenty-four new species and forty-eight new varieties. The two new genera, of which we reproduce the author's figures, are (1) *Cystamæba* (incertæ sedis); (2) *C. digitata* g. et sp. n., distinguished by a chitinous thick-walled cyst perforated by small foramina for the extension of blunt,

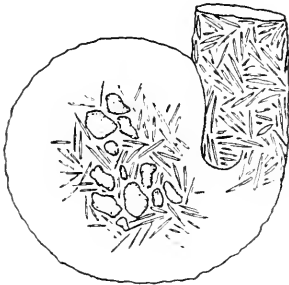

FIG. 1.

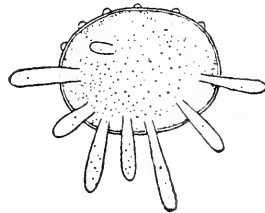

FIG. 2.

digitate pseudopodia; (3) *Cyphoderiopsis*—*C. longicollis* sp. unica, in which "the body-scales are nebuloid, circular, of various sizes, smaller on the neck, continuous but not overlapping, fastened at the edges by little dots of cement." The "selective" constructional powers of these

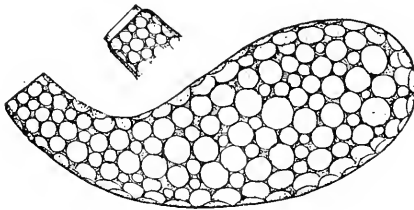

FIG. 3.

organisms are remarkably shown by the figures of *Diffugia bacillarum* Putz and *Lesquerensia spiculosa* sp. n., the latter of which forms a remarkable test of flint sand and apparently auto-secreted spicules.

H.-A. & E.

Ciliate Protozoa from Uruguay.—ERGASTO H. CORDERO (*Anales de la Facultad de Medicina Montevideo*, 1918, **3**, fasc. 8-9), in a thesis for the doctoral degree, describes ciliate Protozoa from the fresh-water of Uruguay. The thesis is a first instalment of a larger work upon free and parasitic Protozoa projected by the author, who, it may be remarked, deplors his lack of works of reference upon the subject, though he subsequently consulted some authorities in the Natural

History Museum at Buenos Aires, of which he gives a list numbering nineteen, four of which deal with South American Protozoa. The illustrations are admirable of their kind, the author admitting the lack of certain details, arising from the fact that they are drawn direct under the microscope from living specimens, and in no sense diagrammatic. His method of technique was to check the movements of the organism by means of "weak solutions of saliva or gum." Fifty species (none of which are new) are described and illustrated: twenty-six in the order Holotrichida, ten in Heterotrichida, and fourteen in Hypotrichida. The author's descriptions show considerable discriminative power, and though there is no marked new contribution to science the work is a useful and praiseworthy addition to the literature of systematic protozoology.

H.-A. & E.

Devonian Foraminifera.—FREDERICK CHAPMAN (*Proc. Linn. Soc. N.S. Wales*, 1918, **43**, part 2, 385-94, pls. 39-42) describes fossil Foraminifera from some micro-sections of the Nemingha horizon of Oolitic limestones from the Tamworth series in New South Wales. Five species are described, three of which are recorded as new—*Psammosphæra neminghensis*, *Valvulina oblonga*, and *Pulvinulina bensoni*. The author gives a résumé of previous records of Devonian Foraminifera from the Eifel (Terquem) and South Devon (Wethered). Chapman is a micro-palæontologist of experience and distinction, and any addition to our knowledge of the Foraminifera put forward by him must command attention, but it seems to us of doubtful utility to erect new species upon the evidence of a few micro-sections. It is in the nature of a reversion to the d'Orbigny system of nomenclature which is to be deprecated.

H.-A. & E.



BOTANY.

GENERAL,

Including the Anatomy and Physiology of Seed Plants.

Cytology,

Including Cell-contents.

Significance of the Chondriome.—A. GUILLIERMOND (*Rev. Génér. Botan.*, 1918, 30, 161-76, 13 pl.) publishes a further paper in support of his theories as to the origin and nature of the chondriome. The author claims that the elements of the chondriome, i.e. the mitochondrias, are constituent elements of every plant or animal cell, and that they are incapable of formation apart from existing mitochondrias. The objection that the chondriome has no real existence, but is the result of methods of fixation, is refuted by proof of its existence in living animal-cells. A description is also given of epidermal cells of the tulip and of the leaves and petals of *Iris germanica*, where structures have been observed both in living and fixed material, precisely similar to the chondriomes of animal-cells. It is also shown that the chondriomes of both animal- and plant-cells behave in exactly the same manner towards fixing and colouring reagents. Moreover, the elaborating functions of animal chondriomes correspond to those of plant-plastids, which the author regards as granular mitochondrias; he points out in support of this theory that starch is not infrequently elaborated before the amyloplasts are fully formed, and that the starch probably arises from granular mitochondrias. Thus, it is claimed that the elaborating function of the so-called plastids is not limited to the formation of starch or chlorophyll, but that they participate in the formation of the greater part of the secretory products of the cell. Cytoplasm appears to be composed of a fundamental material of homogeneous appearance, enclosing in suspension the mitochondrias, which, by a physico-chemical process still unknown, have the power of acting as centres of elaboration of the greater part of the secretory products of the cell. This confirms Altmann's granular theory of the cytoplasm.

The present work is supported by precise experimental data and vital observations, which the author regards as entirely opposed to Dangeard's vacuolar theory of chondriomes. S. G.

Heterosis and Double Fertilization.—D. F. JONES (*Bot. Gaz.*, 1918, 65, 324-33, 3 figs.) publishes a short note upon the results of reciprocal crosses in maize. Collins and Kempton have previously shown that one of the most remarkable effects of heterozygosis is the increase in the amount of endosperm; also that the weights of the seeds themselves were greatly increased. The writer of the present

paper made a number of crosses between types of maize previously selfed from three to six generations, with the result that the crossed seeds showed an increase in weight ranging from 5 to 35 p.c. The greatest increase was obtained where the proportion of selfed to crossed seeds was greatest, suggesting that the heterotic seeds grew at the expense of the selfed seeds. There appears, however, to be no real correlation between the amount of increase in weight and the proportion of two kinds of seeds. The writer finds no confirmation of Nemec's theory that endosperm hybridization is "an adaptation resulting in an alteration of the food-supply to accord with the properties of a hybrid embryo," and doubts whether heterosis "can be entirely removed from the category of results due to indefinite physiological stimulations."

S. G.

Structure and Development.

Vegetative.

Ray-System of *Quercus*.—L. M. LANGDON (*Bot. Gaz.*, 1918, 65, 318-23, 22 figs.) has studied the ray-system of *Q. alba* in order to determine the effects resulting from certain conditions, e.g. age of tree, vigorous or retarded growth, etc. Observations show that neither age nor position of the shoot has much effect upon the ray-formation, but that during decreasing vigour of growth of the mature wood, the "multiseriate rays appear at progressively later stages in the development of the stem." Multiseriate rays are found in seedlings and in the first annual ring in the vicinity of lateral leaf-traces. The peculiar formation of the wood and cambium is due to the influence of outgoing leaf-traces upon the general structure of the xylem cylinder. S. G.

General.

Statistical Investigations on Plant Formations.—C. RAUNKIAER (*Kgl. Danske Videnskab. Selskab. Biol. Meddel.*, 1918, 1, pt. 3) contributes a paper (written in French) of considerable detail, dealing more especially with northern Europe. A general description is given of (1) the frequency and distribution of the species entering into the formations; (2) the relative proportions of the species; and (3) the common biologic characteristics by which the species of a formation adapt themselves to their habitat. The writer then summarizes the chief points to be noted for a complete ecological description of any given area, which are briefly as follows:—The term "formation" is used to describe the vegetation of any area which is perceptibly homogeneous as to chief species. Where the natural conditions have not been interfered with, the vegetation attains a sort of equilibrium, each species being confined to that part of the habitat to which it is best suited. No two species are ever quite similar in their methods of adaptation, so that a difference in floristic composition corresponds to a difference of conditions. A most important feature of plant formations is the frequency with which the different species occur; this is usually estimated as a percentage of the number of specimens collected in a given area. Another important feature is the degree of prosperity of the different

species as shown by the size of the plants and their success in pollination, seed-distribution, etc. All formations are characterized biologically by the number of predominating vital forms—that is, those forms which are most perfectly adapted to their habitat; physiognomically by those forms of predominating mass. By adopting a series of vital forms as the basis of a system of classification, there is found to be a definite progressive perfection of adaptation corresponding with a diminution in physiognomic predominance. In conclusion, the author draws up a scheme for a scientific description of plant formations. This scheme comprises eight classes, each of which consists of plants of a similar habitat, e.g. Hydrophytes, Halophytes, etc. The classes are then subdivided according to such species as deciduous or evergreen leaves, rooted or free-floating habit, etc. It is also pointed out that ecologic descriptions must be based upon an intimate knowledge of the soil from chemical, physical and biologic points of view, as well as upon the characters of the plants under morphological, anatomical and physical aspects.

S. G.

CRYPTOGAMS.

Pteridophyta.

Mazocarpon, or the Structure of Sigillariostrobus.—MARGARET J. BENSON (*Annals of Botany*, 1918, 32, 569–89, 2 pls. and figs.). A description of fossil specimens of *Mazocarpon*, its cone, sporophylls, sporanges, megaspores, and a discussion of the grounds for identifying *Mazocarpon* with *Sigillariostrobus*. *Mazocarpon* is a sporangial apparatus of the Lycopsid type. The cone bore close spirally arranged cone-scales of the *Lepidostrobus* ground plan, but constricted at the plane of attachment to the axis; the cone-scales were exceptionally caducous. There is no free lamella directed downwards, but a convex thicker portion without a ridge may extend to about 0.8 mm. below the plane of the keel of the proximal part of the bract (cone-scale). The distal erect part tapers from 6 mm. in width to a point at not less than 6 mm. above. The sporangia are characterized by the possession of much sterile persistent tissue and the proliferation of the distal wall beyond the limit of the attachment of the sporange to the bract. In the megasporange this lamella is shovel-shaped, and fits into the adaxial concave surface of the upturned part of the bract. The megaspores do not exceed eight and germinate *in situ*, while the spore-wall is plastic. The organic apex of each so-called “spore” is directed centroscopically with reference to the sporange.

There is considerable range of form, determined by the position which the germinating “spore” occupies in the space between the sporange-wall and the subarchesporial pad. The form of those occupying the wider distal end of the sporange in *M. Shorensense* tends to be that of a shallow crucible with the organic apex in the hollow, but many asymmetric forms occur. The spore-wall bears pointed prong-like teeth over its convex base—i.e. the surface directed towards the wall of the sporange. The cone is pedunculate. The sectional area of cone-axis and peduncle is so far found to be hexagonal. The cone may be several

inches long and half an inch wide. Denuded axes are far more common than those with cone-scales still attached, only three of which have so far been recorded. One detached microsporangium is described, and is shown to resemble certain incrustation specimens from the same horizon described by Kidston.

A. G.

Prothallia of Lycopodium in America.—EARLE AUGUSTUS SPESSARD (*Bot. Gazette*, 1918, 65, 362). A correction of a previous statement by the author as to the prothallia of *Lycopodium obscurum*. He now finds that they must be referred to *L. complanatum*, and that the real prothallia of *L. obscurum*, which he has at last discovered, are of the *L. annotinum* type, and are to be described in detail in a later paper.

A. G.

Habitat and Mode of Occurrence in South Australia of two Genera of Lycopods unrecorded for the State.—T. G. B. OSBORN (*Trans. Roy. Soc. S. Australia*, 1918, 42, 12 pp., 1 pl. and figs.). A description of the association of plants in which *Isoetes Drummondii* and *Phylloglossum Drummondii* are found to occur together. It is regarded as a seasonal swamp developed upon alluvial soil within the formation of sclerophyllous woodland. In South Australia both genera are members of a considerable geophilous element within this association. However, the claim of the author to be the first discoverer of *Phylloglossum* in South Australia is anticipated by Dr. A. B. Rendle's record (*Journal of Botany*, 1915, vol. 53, p. 25), the specimens being preserved in the British Museum (Natural History).

A. G.

Gametophyte of Psilotum.—G. P. DARNELL-SMITH (*Trans. Roy. Soc. Edinburgh*, 52, 1918, 79-91, 2 pls.). An account of the ecology, life-history, morphology and anatomy of the gametophyte of *Psilotum*. The spores require a special environment for germination. They produce a cylindrical, radially symmetrical prothallus, which is a brown, subterranean saprophytic tuberous body without chlorophyll, and contains an endophytic fungus. Antheridia and archegonia are borne upon the same prothallus. The antheridia produce spermatozoids having spirally wound bodies and numerous cilia. The archegonia are very simple. They consist of a venter containing the oosphere sunk in the prothallus, a ventral canal cell, and probably two canal cells, which latter are bounded by four tiers of four neck-cells that project at right angles to the surface.

A. G.

Gametophyte Generation of the Psilotaceæ.—A. ANSTRUTHER LAWSON (*Trans. Roy. Soc. Edinburgh*, 52, 1918, 93-113, 5 pls.). An account of the recently discovered gametophyte generation of *Imesipteris* and *Psilotum*. This is a subterranean prothallus, light brown, cylindrical, branching, each branch having apical meristem. The prothallial tissue is uniform, without differentiation into vegetative and reproductive regions. The prothallus is devoid of chlorophyll, is completely saprophytic, and for its nutrition depends upon the co-operation of a mycorrhizal fungus. This fungus is endophytic and not localized in its distribution in the body of the host, and may infect any cells except

those of the meristematic apex. The surface of the prothallus bears numerous long rhizoids. The antheridia and archegonia are always borne on the same prothallus without special localization. The male gametes are coiled multiciliate bodies. The antheridia, developed from superficial cells, stand out as spherical bodies, are very numerous, and arise from all surfaces. The archegonium consists of an immersed venter and of an emerged straight neck, consisting of four rows of cells arranged in several tiers surrounding a neck canal. Like the antheridia the archegonia arise from all surfaces. Both in their vegetative and reproductive characters the gametophytes of *Tmesipteris* and *Psilotum* are remarkably similar. They differ in the following features:—1. In *Tmesipteris* the archegonia are more numerous than the antheridia, while in *Psilotum* the reverse is the case. 2. In *Tmesipteris* the archegonia appear in dense crowded groups, while in *Psilotum* they are more separated or scattered. 3. The antheridia and archegonia of *Tmesipteris* are twice as large as those of *Psilotum*. There is no structural resemblance between the gametophyte generation of the Psilotaceæ and that of either *Lycopodium* or *Equisetum*. The evidence shows conclusively that *Tmesipteris* and *Psilotum* are very closely related to one another, but are very remote indeed in their phylogenetic relationship, from both the Lycopodiales and Equisetales. There are no new facts to upset the view that the Psilotaceæ are more nearly related to the extinct Sphenophyllales than to any other known group of the Pteridophyta.

A. G.

Notes on the Fern Genus Clathropteris.—EDWARD W. BERRY (*Bull. Torrey Bot. Club*, 1918, 45, 279–85, 2 figs.). Observations on some new material from Virginia of the fossil fern *Clathropteris platyphylla*, with a discussion of its bearing on the probable habit of the genus. Fig. 1 represents the specimen itself, and fig. 2 a tentative restoration of the frond of the species.

A. G.

Further Contribution to the knowledge of *Platyzoma microphyllum* R.Br.—JOHN McLEAN THOMPSON (*Trans. Roy. Soc. Edinburgh*, 1918, 52, 157–65, figs.). Additional facts relating to the mature sporangia and spores of *Platyzoma*, with a confirmation of the disposition of the sporangia upon the pinnæ, and of the well-marked differences in sporangial and spore-size and spore-output already recorded for this fern. In the absence of knowledge of sporangial development and spore-germination, it is unknown whether *Platyzoma* be truly heterosporous. Most of the sporangia are small, and the spore-output per sporangium in these is approximately thirty-two. The remaining sporangia are large, and have an approximate output of sixteen per sporangium. The sporangial stalk is typically three-rowed, but four-rowed stalks occur. The annulus is usually irregular, but is interrupted by the stalk. The small and large spores are the dominant types, and the spores of intermediate size are developed when the spore-output in any sporangium is greatly decreased. The three types of spore have similar spore-markings. Their walls are thick, and no sign of germination is found in any spore-type while still contained within the sporangium. The

balance of evidence is in favour of a heterosporous condition for *Platyzoma*. Should a homosporous condition be demonstrated at a later date, the anomalous condition of this remarkable fern will be further accentuated. A. G.

Anatomy and Affinity of *Stromatopteris moniliformis* Mett.—JOHN MCLEAN THOMPSON (*Trans. Roy. Soc. Edinburgh*, 1918, 52, 133-56, 4 pls. and figs.). An account of the anatomy and affinity of *Stromatopteris*, proposed in 1861 by Mettenius as a genus distinct from *Gleichenia*, but united with *Gleichenia* by most authors. The present paper is based on a careful re-examination of herbarium material, and gives details regarding the external form, the dermal appendages, the anatomy of stem and leaf, soral constructions, sporangial form, and spore-output of *Stromatopteris*, thus rendering possible a clearer view of its near affinities. And it is found that structurally *Stromatopteris* can be ranged with *Gleichenia*, but that it has an individuality of form unlike any *Gleichenia*. Possibly its peculiarities are due to the erect position assumed by the branched portions of the axis, and are accentuated by the poverty in roots, or the extremely xerophytic life-conditions. The transitional types of dermal appendages, however, supply a peculiarly distinctive character, and while they may be expressive of special adaptation in a physiological xerophyte, they tend, at the same time, to indicate that *Stromatopteris* is distinct from *Gleichenia*. *Stromatopteris* has no close kinship with *Platyzoma*, and indeed has little in common with it save a xerophytic life; for in *Platyzoma* there is a sporangial advance together with a relatively primitive vegetative condition, while *Stromatopteris* maintains the structural and sporangial character typical of *Gleichenia*. The author holds that *Stromatopteris* deserves recognition as a distinct monotypic genus, closely allied to *Gleichenia*, but clearly distinguished from it by well-marked peculiarities of form and construction. A. G.

Regeneration in *Phegopteris polypodioides*.—ELIZABETH WUIST BROWN (*Bull. Torrey Bot. Club*, 45, 1918, 391-97, figs.). An account of experiments made upon the plant. Regeneration took place near the base of the petiole of a detached leaf of a young sporophyte, placed upon sand moistened with Knop's solution in moist air. A cellular mass, resembling a prothallium, was formed, from which rhizoids, intermediate structures between leaves and prothallia, and true leaves developed. At first true leaves resembling those of normal young sporophytes were formed; then leaves of a much simpler type developed. A. G.

New Cases of Apogamy in Ferns.—W. N. STEIL (*Science*, 1915, 41, 293-4). Cultures of *Aspidium tsus-simense*, *Pellaea adiantoides* and *Lastrea chrysoloba* were kept under observation. The developing embryo of the first species produces no foot; and the primary leaf usually precedes the primary root, the stem appearing later. Numerous scales are developed upon the petiole of the primary leaf, even in the very young embryo, and resemble the characteristic scabs of the mature plant. In *Pellaea adiantoides* the prothallia produce embryos apoga-

mously, the embryos resembling in development those of *P. atropurpurea*. In *Lastrea chrysoloba* the apogamous embryo is developed in a small light region that appears between the apical notch and the cushion of the prothallium.

A. G.

Botanical Observations on various Plants.—G. CAPELLE (*Allgem. Bot. Zeitschr.*, 1915, **21**, 68-74, 121-25; see also *Bot. Centralbl.*, 1917, **135**, 307). An account of some observations on various ferns and vascular cryptogams. *Botrychium ternatum*, and new forms of it, produce in August or September a vegetative leaf after the decay of the inflorescence. Only then do the fronds of the previous year begin to die off. If the winter foliage is injured, the root-stock puts out only weak fronds in the coming year. *Asplenium Ruta-muraria* develops in the shade frond-stalks up to 10 cm. long; the same plant in the sun produces stalks 1-2 cm. long. The effect of cultivation on various species is described; also the appearance of adventitious buds on *Aspidium Filix mas*, when less than twelve months old. *Polystachium*-forms were produced in *Equisetum palustre* and *E. silvaticum*, when most of the shoots were cut off; in *E. limosum* this form is often found because the fruiting shoots are upset by the borings of water-beasts laying their eggs.

E. S. G.

Bryophyta.

Organography of Plants.—K. GOEBEL (New edition, *Jena, Fischer*, 1915, *Heft I.*, 387 pp., figs.; see also *Bot. Centralbl.*, 1917, **135**, 309, 310). An account of the special organography of the Bryophytes. Taking into consideration their diploid generation, one has to do with descending series. Anthocerotaceæ, Andreaeaceæ and Sphagnaceæ are not separated off. The Anthocerotales and Marchantiales have a more primitive structure of the antheridia than the Jungermanniaceæ. The cells of the moss-embryo are diploid; the cells of the *Coleochæte* fruit are haploid. Between the sporophyte of the earliest group of liverworts and that of the mosses there exist similarities in the assimilative tissue, columella and stomata. Between the gametophyte and sporophyte in mosses there exist also similarities. Rhizoids are produced in the most dissimilar groups. The scales of the Marchantiales are homologous with the slime-papillæ of the Jungermanniaceæ. There are transitions between thallose and foliose forms in all these groups of liverworts. It is necessary to guard against the idea of a general derivation of thallose from foliose forms. The adaptation of the vegetative organs for the provision of water in Anthocerotæ and Jungermanniaceæ is manifold. The formation of gemmæ is fully discussed. As regards sporogonia there is a series descending from *Anthoceros* which shows only reduction; the capsule is shortened in favour of the stem, then the assimilative apparatus of the capsule disappears, finally the stem and the elaters. In the portion of the text devoted to mosses new facts are described, notably concerning the prevention of desiccation. The few "water-mosses" have immigrated into the water. The protection of the young sporophyte is much less marked in the mosses than in the liverworts. The swollen portion of the archegonium does not take a large part in

the formation of the perianth and the calyptra, which arise also from the archegonium stalk or from the tissue of the stem itself. Cleistocarpic mosses are retrogressions. Species exist in which the spores grow out into cells even in the capsule (*Cleistostoma*, Dicnemonaceæ). E. S. G.

Air Chambers of *Grimaldia fragrans*.—ALEXANDER W. EVANS (*Bull. Torrey Bot. Club*, 1918, 45, 235-251, 14 figs.). The thalline structure of most Marchantiales may, with reference to the air-chambers, be classed under three distinct types, represented respectively by *Riccia*, *Reboulia* and *Marchantia*. *Grimaldia* is of the *Reboulia* type. 1. The air-chambers of *G. fragrans* are in several layers in the thickened median portion of the thallus. 2. The dorsal chambers communicate with the outside by means of epidermal pores. They are subdivided by a regular system of more or less vertical, united cell-plates, enclosing narrow spaces, so that the boundaries of the chambers are difficult to distinguish. The cell-plates sometimes reach the epidermis and sometimes do not; in the latter case the free margins sometimes bear scattered teeth, less than two cells in length, especially in the vicinity of the pores. Except for these teeth the chambers lack filaments completely. 3. The more deeply situated chambers communicate with one another and with the dorsal chambers by means of passage-ways; they are scarcely or not at all subdivided by cell-plates. 4. The chambers all owe their origin to a splitting of cell-walls in closely united tissue. In the case of the dorsal chambers, the split sometimes begins below the surface and extends outward; sometimes at the surface and extends inward. 5. The dorsal chambers appear first, very close to the apical cell, but the more deeply situated chambers appear soon afterwards. 6. The increase in the size of the chambers is due largely to the growth of the bounding cells, and only slightly to further splittings of cell-walls. The system of united cell-plates in the dorsal chambers and the partitions between the chambers increase in vertical height simultaneously. Direct outgrowths from the surfaces of cell-plates play a very small part in the process of subdivision. A. G.

Mixtures of Species among the Cephaloziellaceæ.—CH. DOUIN (*Revue Bryologique*, 1914, 41, 1-8, 17-26, 1 pl.). A discussion of the intermixing of species of *Cephaloziella* in their natural growth, their similar aspect, and the difficulty thus entailed in discriminating these small species, the nature of the inflorescence of which is hard to ascertain. Species normally without amphigastria produce them on their propaguliferous stems. Such amphigastria must be excluded as specific characters. Treating of the errors of authors, Douin carefully distinguishes *Evansia dentata* (Raddi) Douin from *Prionolobus Turneri* (Hook.); shows that the original specimen of *Jungermannia byssacea* Roth contains a mixture of *J. Starkii* Nees and *J. Hampeana* Nees; that that of *Cephalozia myriantha* Lindberg contains *C. elegans* Heeg and *C. Jackii* Limpr.; and that that of *Cephalozia Limprichti* Warnst. is mixed with *C. rubella* (Nees). He criticizes *C. Starkii* var. *examphigastriata*; *C. divaricata* Spruce, an asylum for misunderstood specimens, from which Douin extracts two new species—*Cephaloziella ludoviciana*

and *C. sinensis*, from Louisiana and China respectively. Another new species is *C. Nicholsoni* Douin and Schiffn., which is carefully differentiated from *C. Massalongi* Spruce and *C. æraria* Pears. The original specimen of *C. Bryhnii* Kaal. (non Schiffn.) contains an admixture of *C. rubella* (Nees) and of another species now provisionally described and named *C. fallax* Douin. Under the heading "Quelques mélanges embarrassants" Douin discusses the following cases and the characters by which the species may be discriminated:—*C. Starkii* and *C. Limprichti*; *C. Hampeana* and *C. rubella*; *C. striatula* Jens. and *C. Starkii*; *C. Jackii* and *C. rubella*; *C. elegans* and *C. Starkii*; *C. bifiloides* Douin (a new species), *C. integerrima* (Lindberg), and *Dichiton calyculatum* Trev.; *C. Starkii* and *C. papillosa* Douin; *C. Starkii*, *C. rubella*, *C. pulchella* and *C. Limprichti*. For the proper determination of the little species of *Cephaloziella* it is indispensable that the specimens should be complete, with fruit, and in good condition. In the plate are figured many details of the structure of *C. myriantha* Lindberg, *C. Nicholsoni* Douin and Schiffn., and *C. Massalongi* Spruce. A. G.

Sphagna, their Habitats, Adaptations and Associates.—W. WATSON (*Annals of Botany*, 1918, 32, 535-51, 5 figs.). A study of the *Sphagna* of Somerset, their distribution, protective devices, reasons for protective devices, further characters important in relation to water-supply. The *Sphagna* obtain their mineral salts from very dilute solutions. They possess a special method of obtaining mineral food by absorbing the base and liberating the acid. In order to do this, special devices (which may seem of a xerophytic nature) are adopted to obtain a sufficient quantity of dilute solution, and to get rid of the superfluous acid and water. These devices vary in different groups of *Sphagnum*. During periods of drought the income of exposed plants is suspended and the xerophytic devices may act as such, keeping the plant in a moist condition till a further supply of dilute solution is available. Structural details are shown in the figures. A. G.

Cell-Structure and Autospore Formation in Tetraedron minimum—GILBERT MORGAN SMITH (*Annals of Botany*, 1918, 32, 459-64, 1 pl.). An account of the cytological structure of this green alga. Young cells of *Tetraedron minimum* contain a single nucleus and pyrenoid. Repeated simultaneous karyokineses may produce as many as eight nuclei within a single cell. Autospores are formed by progressive cleavage, the number of nuclei increasing during the process. Four, eight, sixteen or thirty-two uninucleate protoplasts are the final product of this cleavage, these protoplasts being metamorphosed over into autospores. The pyrenoid disappears after the first cleavage, new pyrenoids being formed *de novo* in the young autospores. A. G.

Studies on Schistostega osmundacea.—Y. TODA (*Journ. Coll. Sci. Imper. Univ. Tokyo*, 1918, 40, art. 5, 30 pp., 2 pls., 2 figs.). An account of the occurrence of *Schistostega* in Japan, its relation to light, heat and humidity, with figures of the structure of the protenema under various conditions. 1. The optimum intensity of light for this so-called

“luminous,” cave-growing moss is 0·02–0·002 (Bunsen’s unit), the protonema thriving well even in so feeble a light as 0·008. The shoot, however, never grows where light is 0·001 or below it. 2. In the dark the protonema can live for seven months at least without producing a leaf or shoot. Where the light exceeds 0·1 the moss cannot live. 3. The movement of the chromatophores is slow. When the protonema is placed in the light the chromatophores are scattered in a day; and when the direction of light is changed they all turn towards it in seven to ten days at a temperature of 15°–25° C. 4. The spherical cells of the protonema seem to enable the moss to effect assimilation in a feeble light. 5. The moss thrives better, and the movement of the chromatophores is quicker, in a blue or violet light. 6. The optimum temperature for the development of the shoot is 16°–25° C. The minimum life temperature for the shoot is –18° C., and for the protonema is –20·5° C. 7. The optimum humidity of the air is 90 to 100 p.c. 8. The protonema is strongly adapted for resisting desiccation. 9. As a cultural medium Elie and Emile Marchal’s solution is the best. 10. The nitrate, sulphate, chloride and carbonate of calcium, each in 0·1 p.c. solution, are not only not injurious to *Schistostega osmundacea*, but stimulate its growth to a certain extent. 11. The spore, at temperature 16°–25° C., germinates in one month, and its first filament has a cylindrical shape, producing many spherical cells soon after.

Mosses Collected by the Smithsonian African Expedition.—H. N. DIXON (*Smithsonian Miscellaneous Collections, Washington, 1918, 69, No. 2, 28 pp., 2 pls.*). An account of the mosses collected in 1909–10 by E. A. Mearns on Mount Kenia, with an introductory discussion of the moss-flora of the mountains of East Tropical Africa. Of the forty-eight species collected, twelve proved to be new to science, and their characters are described and figured. A. G.

Thallophyta.

Algæ.

Microbiological Researches on some Japanese Water-supplies.—H. HATTORI (*Journ. Coll. Sci. Imper. Univ. Tokyo, 1917, 40, art. 4, 76 pp., 6 pls.*). The author has made a full investigation into the principal water systems of Japan, especially that in Yokohama, in order to ascertain how the different species and the development of the bacteria affect the quality of the water; to what extent the flora of the superficial covering of dirt is of importance in the examination of the water; and whether the speed of filtration could be hastened. The results of the work are set forth in detail and illustrated by tables. The species which compose the superficial covering consist of Diatoms, Chlorophyceæ, Conjugatæ and Schizophyceæ, which show annual fluctuations. The rich algal vegetation assists in the work of filtration, but it offers no hindrance to the development of bacteria in the water. Four plates of figures are given of the algæ. A large part of the paper is devoted to the bacteria. E. S. G.

Researches on the Development and Nutrition of some Chlorophyceæ.—H. NAKANO (*Journ. Coll. Sci. Imper. Univ. Tokyo*, 1917, 40, art. 2, 214 pp., 3 pls.). The author succeeded in isolating and cultivating three known species and two new species of Chlorophyceæ, *Chlorosphaera putrida* and *Chlamydomonas koishikanensis*. He describes their development and the physiology of their nutrition, their changes of form and colour, and their systematic position. Full details are given of all his experiments and results.
E. S. G.

A Wood-penetrating Alga, *Gomontia lignicola* sp. n.—G. T. MOORE (*Annals of the Missouri Botanical Garden*, 1918, 5, 211–24, 2 pls.) describes a new wood-penetrating Alga, *Gomontia lignicola*, found on a yellow pine-board in a fresh-water pond near Wood's Hole, Massachusetts, the study of which clears up several points in our knowledge of the life-history of the genus. The plants consist of a typically unbranched cylindrical filament in which a striking appearance is produced by its having most of the chlorophyll concentrated in the terminal cell, the remaining cells being so devoid of colour as to give the appearance of a fungous hypha. Sporangia are formed both in the tissue of the wood and on the surface, and are extremely irregular in outline. The contents break up simultaneously into zoospores which escape through a small hole in the tip of one or more of the branch-like projections from the main body of the sporangium. Previous authors have given the number of cilia for the zoospores of *Gomontia* as two or four, but those of *G. lignicola* have but two cilia. There was no marked difference in size between the zoospores, which were produced in large numbers and function as true zoospores, and it is highly improbable that gametes occur. Prof. Moore finds no foundation for the idea that simply because biciliate and quadriciliate spores have been recorded for the genus those with two cilia are gametes. The spores may germinate directly to produce a vegetative filament, or form resting spores which have hitherto been regarded as akinetes or aplanospores. The resting spores are extremely irregular in ultimate size and shape, brilliantly green and full of starch; a single pyrenoid is visible in the young cells, and there is one nucleus. After reaching maturity the spore may rest for months or even years. Germination may occur at any point, and usually germ-tubes push out at more than one place on the surface. The author concludes that the aplanospores or akinetes described by previous workers in other species of the genus are merely resting spores developed from a zoospore.
A. B. R.

Notes on a *Carpenteria*-Limestone from B. N. Borneo.—H. YABE (*Science Reports, Tôhoku Imper. Univ. Sendai, Japan*, Second Series (Geology), 1918, 5, No. 1, 15–30, 3 pls.). A description of the fossil animals and plants in a Foraminiferal limestone of Tertiary age. *Lithothamnium borneense*, a species new to science, is described; and the structure of it and of *L. ramosissimum* is represented in photographs.
A. G.

Age of *Pterygophora californica*.—T. C. FRYE (*Pub. Puget Sound Biol. Sta.*, 1918, 2, No. 35, 65–71). The author discusses the evidence

as to the duration of life of *P. californica*, as deduced from the structure, and comes to the conclusion that the rings in the stem are annual growth-rings. The greatest number of rings recorded is 24, in a stalk 5 cm. in diam. Stems measuring 7.5 cm. in diam. have been recorded, but their rings were not counted. *Alaria tenuifolia* shows also annual growth-rings. E. S. G.

Fungi.

Study of *Phytophthora infestans*.—JAKOB ERIKSSON (*Rev. Gén. Bot.*, 1918, 30, 16-30; 50-61) has now completed his study of potato-mildew. He has reviewed the results obtained by previous workers, and adds an account of his own researches. As a result of his own observations, he finds that the continuance of the disease is assured by the presence of a mycoplasma, which lives in symbiosis with the normal cytoplasm of the cell, and in the chlorophyll cells of the plant; after undergoing a series of changes, it passes into the intercellular spaces as a fine mycelium. The subsequent development is mycelial. Eriksson has found oogonia and antheridia as well as the "conidial" stage, which is the mildew form of the disease. A. L. S.

Life-History and Cytology of *Olpidium*.—A full account of a new *Olpidium* (*O. Viciæ*) has been given by S. KUSANO (*Journ. Coll. Agric., Tokio*, 1912, 4, 141-99, 3 pls.). He notes that some of the zoospores become planogametes, and form by copulation the motile zygotes. He concludes from this that "the Chytridiales are not a degenerated series, but form the lowest class in the progressive phylogenetic series of the fungi." He also deduces from other evidence that the Olpidiaceæ, or at least *Olpidium*, may have derived from an ancestor below the level of the algæ, perhaps in common with the latter. A. L. S.

***Daldinia vernicosa*.**—ARTHUR S. RHOADS (*Mycologia*, 1918, 10, 277-84, 1 pl., 1 fig.) has described this fungus as one that lives on burnt wood. It is constantly associated with *Nummularia Bulliardii*, but the latter is not confined to burnt surfaces. *D. vernicosa* differs from the more familiar *D. concentrica* in the form of the sporophore; it is somewhat pyriform, narrowing to a stalk at the base. A. L. S.

***Peziza proteana* var. *sparassoides* in America.**—E. J. DURAND (*Mycologia*, 1919, 11, 1-3, 1 pl.) describes this species and the variety, which have been collected recently in America. He is inclined to think that the variety agrees exactly with Masseur's *Gyromitra Phillipsia*, though only a study of authentic specimens can settle the difficulty. A. L. S.

British Species of *Melanconium*.—These have been listed and diagnoses published by W. B. GROVE (*Kew Bull.*, 1918, 161-78, 1 pl.). He divides the genus into three sections:—(1) *Melanconium*, with smoky-brown or blackish spores, exuding in tendril-like masses; (2) *Lamproconium*, with bright-coloured spores; and (3) *Ectoconium*, with olivaceous spores that do not exude as tendrils. The latter grow on reed-like grasses, and have often been mistaken for other genera and species of fungi. A. L. S.

New or Noteworthy Fungi.—The study of Fungi imperfecti is continued by W. B. GROVE (*Journ. Bot.*, 1918, **56**, 340-6). The list includes new species, *Myxosporium Polygoni* and *Marssonia Omphalodis*. Full descriptions are given of all the species listed. A. L. S.

Incubation Period of Cronartium ribicola on the White Pine.—R. E. STONE (*Phytopathology*, 1918, **8**, 438-40, 1 fig.) has published observations on the appearance of aecidia on the white pine, the *Cronartium* stage of which grows on *Ribes cynosbati*. *Ribes* plants growing near the pines were heavily infected in 1914, but were removed in 1915 before the leaves had unfolded. It was only in 1917, that is three years after probable infection, that the pine blister rust appeared, thus indicating a three-year period for incubation, or more exactly, two years and nine months. In some cases the incubation period was found to have been a year longer. A. L. S.

Contribution to the Study of Uredineæ.—PAUL CRUCHET (*Bull. Soc. Vaul. Sci. Nat.*, 1918, **51**, 623-31, 3 figs.) reports the results of experimentation and observation on several Uredineæ. *Aecidium Scillæ* has been known for some time; the *Puccinia* stage has been proved by inoculation, etc., to grow on *Festuca rubra*. *Puccinia Eræ* was found by the author on *Deschampsia cæspitosa* in its Uredo form; he also found the teleutospore stage and publishes the diagnosis. A new species of Uredo was found on *Festuca Halleri* different from all known Uredineæ on *Festuca*. A. L. S.

Rusts of North America.—J. C. ARTHUR and G. R. BISBY (*Proc. Amer. Phil. Soc.*, 1918, **57**, 273-292) have published a translation of two papers by Schweinitz on the rusts of North America. They give an account of his life and activities, and give a description of the many rusts collected by him, with the letterpress attached to the specimens. Finally, they give lists of these rusts under their modern names, and a further list of hosts, with their parasites. A. L. S.

Overwintering of Aeciospores of Cronartium ribicola.—LOUISE DOSDALL (*Phytopathology*, 1918, **8**, 619) collected in 1918 aeciospores of *Cronartium* on a branch of white pine. She takes it for certain that they were spores from the season 1917, and she found that 1 to 2 p.c. had retained their viability and produced germ-tubes. She suggests that the rust may easily overwinter in this way. A. L. S.

Host Relationship of the North American Rusts, other than Gymnosporangium, which attack Conifers.—ARTHUR S. RHOADES, G. G. HEDGCOCK, E. BETHEL, and C. HARTLEY (*Phytopathology*, 1918, **8**, 309-52) have published a detailed paper on the above subject. It arose out of a tabulated account of these rusts and their relationship compiled by G. Hartley as a basis for practical prophylactic work. This proved to be of so much service that it has now been enlarged, and includes work by the other writers. Special stress is laid on the dates of infection, overwintering, etc. More than twelve genera of Uredineæ find hosts among Conifers. Indexes of the alternate host-plants are given, and a copious bibliography. A. L. S.

Melampsora Cultures.—J. R. WEIR and E. E. HUBERT (*Mycologia*, 1918, 10, 195–8) give results of cultures with the rusts of *Populus*. These were known as *Melampsora medusæ* and *M. albertensis*, but as both infect *Pseudotsuga* and *Larix*, it is suggested that they should be recognized as one species, *M. medusæ*. A. L. S.

Puccinia on Carduaceæ.—H. S. JACKSON (*Bot. Gaz.*, 1918, 65, 289–312) gives a descriptive list of Pucciniæ on the three genera of Carduaceæ—*Vernonia*, *Elephantopus*, and *Piptocarpa*. The two latter genera harbour two species of the rust, while on *Vernonia* twenty-five species are here recognized on the various hosts. The rusts are more numerous in the sub-tropical than in the temperate regions. Some of the species are new to science. A. L. S.

Study of the Genus Kuehneola.—J. C. ARTHUR (*Bull. Torrey Bot. Club*, 1917, 44, 501–11) describes the characteristic features of this genus—viz. the formation of the teleutospores in chains. Arthur separates from the genus two forms which grow on *Potentilla* and on *Duchesnea*, in which the teleutospores are stalked like those of *Phragmidium*, but have smooth walls and a single apical pore in each cell. He places these two forms in a new genus, *Frommea*, and adds a new species on *Polylepus* from Ecuador. A. L. S.

Study of Gymnosporangium.—B. D. DODGE (*Mycologia*, 1918, 10, 182–93, 3 pls.) has made a careful cytological study of six species of this genus. He finds that the teleutospores arise from the subterminal cells of the tissue composing the primordium. The developing sorus is covered by the thick epidermis of the host, or, in the case of galls on stems, by several layers of cork; these are burst, and the spores continue to develop, though no evidence has been found to show that they ever arise from a terminal cell.

In another paper (*Bull. Torrey Bot. Club*, 1918, 45, 287–300) Dodge records the results of further studies of *Gymnosporangium*, being a summary of cultures made in 1915 and 1916. He gives an account of inoculation experiments which resulted in the infection of red cedar with *Gymnosporangium clavipes*, *G. macropus*, *G. globosum*, and *G. nidus-avis*. The development of these species and their effect on *Juniperus* is described. A. L. S.

Hyphomycetes.—J. S. BAYLISS ELLIOTT (*Trans. Brit. Mycol. Soc.*, 1918, 6, 37–8, 4 figs.) watched the development of the spores of *Tricothecium roseum*. They grew in a moist chamber, a very sheltered position, and the production of spores was abundant and somewhat abnormal. Racemes of spores instead of clusters were formed at the tips of the conidiophores. A. L. S.

Hyphomycetes and the Rotting of Timber.—A. LORRAIN SMITH (*Trans. Brit. Mycol. Soc.*, 1918, 6, 54–5), on examining some rotted house timbers, found that the woody tissues were permeated with a dark mycelium. In one instance the fungus was identified as *Torula abbreviata*, in the other as *Haplographium finitimum*. The decay of the timber was evidently due to the action of these fungi. A. L. S.

Fungus Flora of Pine Seed-beds.—ANNIE E. RATHBURN (*Phytopathology*, 1918, 8, 468-83) undertook this investigation in order to obtain information as to the fungi that might cause the damping off of seedlings. She gives tables of the fungi in the soil and the depths at which they were found, but concluded that *Fusarium* alone caused the death of the seedlings. She also examined the alimentary canals of worms and grubs, and proved that they were carriers of fungus spores. She isolated and cultured eleven different fungi. A. L. S.

Polymorphism of Botrytis cinerea.—W. B. BRIERLY (*Kew Bull.*, 1918, 131, 1 pl.) describes the microconidia of this *Botrytis*, which developed either from the vegetative mycelium, from the cells of the conidiophores, or directly by the germination of the conidia. On germination these conidia give rise to the normal conidiophores and conidia of *Botrytis*. The writer discusses very fully the conditions that induce the formation of microconidia. A. L. S.

Notes on Australian Fungi N. IV.—J. BURTON CLELAND and EDWIN CHEEL (*Journ. Proc. Roy. Soc. N. S. Wales*, 1918, 51, 475-557) publish notes and observations on the Australian species of *Polyporus*, *Fomes* and *Hexagona*, genera that are somewhat abundant in Australia. The authors have been assisted in their study by C. G. Lloyd, and they publish a classified list of recorded Australian species side by side with Lloyd's determinations. A. L. S.

Two-spored Basidia.—A. A. PEARSON (*Trans. Brit. Mycol. Soc.*, 1918, 6, 39-46) has given a historical account of the occurrence of these basidia, and also the results of his own observations. He finds such basidia in general among the smaller species of Agarics. A. L. S.

British Mycology.—CARLETON REA (*Trans. Brit. Mycol. Soc.*, 1918, 6, 1-14) gives an account of the Autumn Foray of the Mycological Society at Shrewsbury. He describes the itinerary followed, and the rarer finds of the various days. He gives a complete list of the fungi collected, some of which were new to Britain and a few new to science. A. L. S.

Fomes officinalis, a Timber-destroying Fungus.—J. H. FAULL (*Trans. Roy. Canad. Inst.*, 1917, 11, 185-209, 8 pls.) gives a historical and cultural account of this fungus, which causes red heart rot of the stem of conifers. It is a wound parasite. The sporophores were long regarded as of medicinal value; the active principle is a resinous substance, agaricin secreted in the form of amorphous granules in great abundance on the hyphæ of the sporophore. Faull has proved that the fungus is specifically distinct from *Polyporus sulphureus*, with which it has been confused at various times. It has occurred in Europe, Asia and America, but so far seems not to have been reported from the British Isles. A. L. S.

Fungi on Aleurodes vaporarium.—A. S. HORNE (*Ann. App. Biol.*, 1915, **2**, 109–11) has investigated an occurrence of *Cladosporium* and *Cephalosporium* on *Aleurodes* nymphs. He gives an account of similar attacks, but does not find that parasitism has been proved. A. L. S.

Empusa Muscæ on Musca domestica.—H. T. G. SLOW (*Ann. App. Biol.*, 1917, **3**, 150–8, 1 pl.) has published some notes on the possibility of using the *Empusa* fungus as a pest of house-flies; and he adds observations he has made on the germination of the spores.

A. L. S.

Cell-regeneration in Botrytis cinerea.—Some notes on this subject have been published by W. B. BRIERLEY (*Ann. Bot.*, 1918, **32**, 601–4, 3 figs.). He found that on injured cells the protoplasm could form new membranes and resume healthy growth. He describes several different cases in which this happens, and contrasts it with the mycoplasma theory of Eriksson.

A. L. S.

Illustrations of Fungi.—W. A. MURRILL (*Mycologia*, 1918, **10**, 177–81, 1 col. pl.) publishes descriptions to accompany a coloured plate drawn by Miss Eaton. There are nine of the smaller Agarics figured, four of which are exclusively American. The others occur also in Europe.

A. L. S.

Notes on Hypholoma.—EDWARD T. HARPER (*Mycologia*, 1918, **10**, 231–4, 1 pl.) describes some Agarics belonging to the *Hypholoma lacrimabundum* group. He discusses the differences between various closely related species, such as *H. lacrimabundum* and *H. storea* var. *caespitosum*.

A. L. S.

Coriulus prolificans and C. versicolor on Peach Trees.—J. A. ELLIOTT (*Phytopathology*, 1918, **8**, 615–7) finds that these two fungi may cause wood-rots. The attack of the fungi followed severe pruning; the trees grew on heavy soil; others on light soil escaped.

A. L. S.

Effect of Weather on the Attacks of Parasitic Fungi.—J. E. WEISS (*Zeitschr. Pflanzenkr.*, 1918, **28**, 116–42) made careful examinations, in the same area, of the prevalence of a large number of fungus diseases during two successive summers, 1916 and 1917. The former summer was wet and the parasites were abundant. During the following season there was less rain, and an exceptionally dry spell of weather at the beginning of May seemed to have acted as a very effectual check on the growth of the fungi. Weiss describes in considerable detail the comparative growths in about forty different fungi; in some cases the parasite failed to appear. *Plasmidiophora Brassicæ* and smuts are closely affected by moisture in the soil. In almost every case the author recommends the methods best suited to check the disease. He also notes that *Entomosporium maculatum*, which causes spotting of apple and pear trees, appears late in the season (August and September); unlike most other fungi it is able to pierce the mature cuticle of the leaf. *Cronartium ribicola* and *Ceratophorum setosum* are also developed late in the season.

A. L. S.

Relation of Temperature and Humidity to Infection by certain Fungi.—A long series of experiments has been made and recorded by J. L. LAURITZER (*Phytopathology*, 1919, 9, 6-35) bearing on this subject. With regard to temperature, he finds very definite limits for infection, which vary according to the fungus. The range for *Puccinia graminis Tritici* is between 42° and 53° F.; for *Ascochyta Fagopyrum* from 45° F., though there is variation within these limits and 59°, and the highest possible temperature for that fungus is 100°; the buckwheat plants themselves are killed then. The limits of humidity vary roughly from 90 to 100 p.c., but just how the spore obtains the necessary amount of moisture remains an unsolved problem. The absorption may be from the host-plant or in the depressions of the leaf-surface, especially over the stomata, there may be reserves of humidity. Hairs, in checking evaporation, seem to further the germination of the spores.

A. L. S.

Effect of Salts on the Growth of Wine-yeast.—An experimental study of this subject has been made by S. K. MITRA (*Univ. California Publ. Agric. Sci.*, 1917, 3, 63-102) in the line of similar experiments made with animals, bacteria, etc. The salts employed were the chlorides of potassium, magnesium, calcium, and sodium. Each of these salts alone is more or less toxic to the yeast *Saccharomyces ellipsoideus* at certain concentrations, though at low concentrations they stimulate growth. The salts used had a marked effect on the size and appearance of the yeast. The results of the experiments are entirely different from those found with bacteria or with the higher plants and animals.

A. L. S.

Varietal Susceptibility of Beans to Strains of Colletotrichum Lindemuthianum.—MORTIER F. BARRUS (*Phytopathology*, 1918, 8, 589-614, 5 pls.) has carried out a series of inoculation cultures on various host-plants, which tend to show that several species of *Phaseolus* and other allied plants may become infected with the fungus but are not to be reckoned as favourable hosts. He thinks there may be some factors connected with the parasite as well as the host that more or less inhibit growth.

A. L. S.

Biology of Sand-dune Fungi.—E. M. WAKEFIELD (*Trans. Brit. Mycol. Soc.*, 1918, 6, 33-6) notes the peculiar and large fungus-flora observed by Wheldon on the Lancashire dunes, and by herself on the Gower Coast, South Wales. Some of the species were evidently associated with the dune grasses; others, especially *Bolbitius tener* and *Galera rubiginosa*, grew on the sand, and evidently subsisted on a crust of green and blue-green algæ which permeated the sand.

A. L. S.

Fungus from Weybridge.—E. M. WAKEFIELD and A. A. PEARSON (*Trans. Brit. Mycol. Soc.*, 1918, 6, 68-74, 6 figs.) publish a series of resupinate Basidiomycetes which includes six species and two genera new to Britain, with one species, *Tulasnella tremelloides*, new to science. They were found during the winter months at Weybridge, Surrey. *Protodontia* and *Coniophorella* are genera new to Britain; the species *C. olivacea* has been included as *Coniophora olivacea* in British lists, but this is the first time it has been correctly identified.

A. L. S.

Fungi Exotici: xxiv.—In the present paper contributed by E. M. WAKEFIELD (*Kew Bull.*, 1918, 207–10, 7 figs.) nine species new to science are described. One of these, *Fomes pseudo-ferreus*, causes a serious root-disease of *Hevea brasiliensis* in the Malay States, where it was collected, and at one time attributed to *Poria hypolateritia*. Another species, *Fomes elegans*, a small neat species, is also said to cause root-disease of *Hevea* in the same country. Other new fungi described from Australia and Tropical Africa are saprophytic on leaves and wood.

A. L. S.

New or Noteworthy Fungi from New Mexico.—CH. E. FAIRMAN (*Mycologia*, 1918, 10, 239–64) publishes a list of Ascomycetes and Deuteromycetes, all of them microscopic fungi, collected by P. C. Standley in Colfax County, New Mexico. Many of the species are new to science.

A. L. S.

New Japanese Fungi.—TYÔZABURÔ TANAKA (*Mycologia*, 1918, 10, 285–3) continues his account of minute fungi belonging to the “Fungi imperfecti.” Those described grow on living or dead trees of *Morus alba*.

A. L. S.

Cape Fungi.—A considerable number of fungi have been collected by ALICE PEGLER, and listed by I. B. POLE EVANS (*Ann. Bolus Herb.*, 1918, 2, 109–11, 185–93). They were collected in the Kentani district of the Cape Province, and though mostly micro-species there are also a series of larger forms of Basidiomycetes. Several species are new to science.

A. L. S.

New or Rare British Fungi.—A. LORRAIN SMITH and J. RAMSBOTTOM (*Trans. Brit. Mycol. Soc.*, 1918, 6, 47–53) record a series of microfungi mostly new to Britain. Several species are new to science, and one genus, *Discocera*, which resembles *Humaria* in its spores, but is more truly akin to *Nesolechia*. It was parasitic on a crustaceous lichen, on stone.

A second paper, by CARLETON REA (*Trans. Brit. Mycol. Soc.*, 6, 61–4), deals mainly with the larger fungi, two of which are new to science. The paper is illustrated by a coloured plate.

A. L. S.

New Species of “Fungi imperfecti.”—J. S. BAYLISS ELLIOTT (*Trans. Brit. Mycol. Soc.*, 6, 36–61, 1 pl.) has added six species to the British Fungus Flora, four of them being new species. With one exception they grew on decaying wood or on fallen pine-cones, in the author’s garden, at Tamworth-in-Arden, Warwickshire.

A. L. S.

Fungi on Bromus.—PAUL CRUCHET (*Bull. Soc. Vaud. Sci. Nat.*, 1917, 51, 583–5) comments on the list of fodder-plants that has been prepared, and proposes that a list of parasites on each of these plants shon’d also be made. He gives a long list of such as grow on *Bromus erectus*, one of the commonest Swiss grasses. He adds notes on *Epichloe typhina*, *Urocystes Agropyri*, etc.

A. L. S.

Production of an Anthracnose-resistant White Marrow-bean.—WALTER H. BURKHOLDER (*Phytopathology*, 1918, **8**, 353-9) describes his experiments and results, which were successful in obtaining a strain of beans resistant to the attack of *Colletotrichum lindemuthianum*. The fungus attacks the pods of *Phaseolus vulgaris*. A. L. S.

Relation of Fungi to other Organisms.—A. LORRAIN SMITH (*Trans. Brit. Mycol. Soc.*, 1918, **6**, 17-31) discusses this question in her Presidential Address. The relationships may be saprophytic, parasitic or symbiotic. The latter was the last to be recognized, and is to be found in *Mycorrhiza* and in Lichens. Examples of many different types of association are cited. A. L. S.

Infection and Immunity.—In a paper by S. P. WILTSHIRE (*Ann. App. Biol.*, 1914-15, **1**, 335-50, 4 pls.), a study is made of the apple- and pear-scab fungus, *Venturia*. The fungus gains entrance to the host by means of appressoria, which pierce the cuticle of young leaves or fruits. Wiltshire has discussed the questions of infection and immunity. He finds that the fungus simply eats its way through the cuticle till it arrives at the epidermal cell, and flourishes there if the host is susceptible to attack. The cell-sap he considers may be in all cases antagonistic to the fungus, but more so in immune species. A. L. S.

New Tannery Fungus.—TOICHI ASAI (*Journ. Coll. Sci. Imp. Univ. Tokyo*, 1918, **39**, N. 7, 1-42, 2 pls., 7 figs.) has isolated from tanneries in the neighbourhood of Tokyo a deleterious fungus which he has determined as *Mycoderma tannica* sp. n. After describing the fungus, he gives an account of cultures in various solutions, and of its properties; he also gives lists of other fungi that are common in tanneries. *Mycoderma tannica* makes a dark rusty permanent stain on sole-leather. It also destroys the tannin in the factories. A. L. S.

Absorption of Gold by Fungi.—MAUD WILLIAMS (*Ann. Bot.*, 1918, **32**, 531-4) has undertaken a research on the power of certain fungi to develop in colloidal gold solutions and to withdraw the gold contained therein. She was successful with *Penicillium glaucum* and *Oidium lactis*. During growth the metal was removed from the solution and retained in such walls as are not cuticularized. A. L. S.

Geographical Distribution of Citrus Diseases.—Some important fungus diseases are not co-extensive with the areas where the host is cultivated. H. S. FAWCETT (*Johns Hopkins Univ. Circular*, 1917, **3**, 190-3) has instituted an examination of the problem of distribution with regard to *Citrus* diseases, instancing especially those due to *Phomopsis*. Experience so far points to the importance of temperature at certain seasons of growth; the soil or the climatic conditions may equally hinder or favour the development of the fungus at critical stages. A. L. S.

Relation of Temperature to Growth of Fungi in Cultures.—This question has been studied by H. S. FAWCETT (*Johns Hopkins*

Univ. Circular, 1917, 3, 193-4). The preliminary work so far has been in the observation of cultures of *Pythiacystis citrophthora*, which attacks the trunk and the fruit of the lemon tree. Growth was most vigorous between 10 to 20° C., the rate being doubled, from 20° to 28° it increased 25 p.c., at 33° the rate was nearly the same as at 10°.

A. L. S.

Fungi and Disease in Plants.—A text-book of fungi, with special reference to disease of plants in India, has been published by E. J. BUTLER (Thacker, Spink and Co., Calcutta and Simla, 1918, 547 pp., 206 figs.). The first part deals with a general description of fungi and their relation to other organisms. In the second part are described the more prevalent diseases that affect economic plants in India, from cereals to rubber. Remedies for these diseases are suggested. Butler states that in such a large country as India the diseases are unavoidably numerous, and many of them are endemic. Cereals and pulse crops receive necessarily much attention. Root-crops and oil-seeds, dye, drug and spice crops, including tobacco, have each their parasites. Tea and rubber are also important Indian plants, and are subject to severe attacks.

A. L. S.

Sterigmatocystis Smut of Figs.—ROBERT W. HODGSON (*Phytopathology*, 1918, 8, 545-6) has published an account of the trouble caused to fruit merchants by the disfigurement and injury to figs. When opened the figs show streaks of a blackish gummy nature mainly caused by a *Sterigmatocystis*.

A. L. S.

Cacao Disease.—The disease of cacao-beans due to *Phytophthora fuberi* has been studied in Samoa by ERNST DEMANDT (*Zeitschr. Pflanzenkr.*, 1918, 28, 241-391, 2 pls., 13 figs.). After a long account of the disease he gives methods of treatment. He then gives a short description of the disease on the fruits of *Hevea*. Associated with the *Phytophthora* he found *Fusarium samoense* and another species undescribed, which also gave rise to cankers.

A. L. S.

Root-rots of Ginseng.—C. L. ZINSSMEISTER (*Phytopathology*, 1918, 8, 557-71, 8 figs.) has investigated diseased roots of Ginseng (*Panax quinquefolium*). The disease has been known as a root-rust, but the author has traced it to the *Ramularia* fungus. He has examined the tissues, in which he has traced the course of the disease, and he has made cultures and inoculations. He describes three new species of *Ramularia* which he has isolated.

A. L. S.

Pink Disease of Plantation Rubber.—This disease has been abundant in Malayan Estates since 1912, and F. T. BROOKS and A. SHARPLES (*Ann. App. Biol.*, 1915, 2, 58-80, 11 figs.) have investigated its distribution, hosts, etc. It is due to the fungus *Corticium salmonicolor*, which may exist in a sterile condition. It affects both the bark and the wood, inducing tyloses in the vessels of the latter. Instruction is given as to treatment.

A. L. S.

"Black Neck," or Wilt Disease of Asters.—W. ROBINSON (*Ann. App. Biol.*, 1915, 2, 125-37, 2 pls.) found that this fungus was due to a species of *Phytophthora*, possibly a physiological form of *P. omnivora*. The sporangia are peculiar in that the stalk grows through the sporangium after the discharge of the zoospores and forms a second and even a third. No sexual organs were observed. A. L. S.

Silver-leaf Disease.—T. SMOLAK (*Ann. App. Biol.*, 1915, 2, 138-57, 19 figs.) investigated the cytology of leaves attacked by this disease. He describes the changes induced, resembling those found in gall-tissue. He does not consider that the disease is in all cases due to *Stereum purpureum*, nor does he think the silverying is caused by an enzyme; more probably a toxin is secreted in the leaves, which causes the changes which he describes. A. L. S.

Tomato-fruit Rots.—These fruit-rots, according to J. ROSENBAUM (*Phytopathology*, 1918, 8, 572-81, 1 pl.), do not originate in transit as was supposed, but have been traced to field infection, though the trouble may spread in transit. Over-ripeness of the fruit is favourable to the development of the rot fungi. He finds three types of rot: (1) Buckeye Rot (*Phytophthora terrestris*), which can spread to adjacent uninjured fruit; (2) Soil Rot (*Rhizoctonia* sp.), White Rot (*Sclerotium Rolfsii*), and Leak (*Rhizopus* sp.), (the fungi of this type infect through the stem end or through some break in the skin); (3) Nail-head Spot (*Macrosporium Solani*), Black Spot (*Phoma destructiva*), and Anthracnose (*Colletotrichum phomoides*)—these do not affect healthy adjacent fruit. A. L. S.

Some Potential Parasites of the Potato Tuber.—There are a number of saprophytic fungi, mainly Hyphomycetes, that are frequently found on potatoes in storage. M. SHAPOVALOV (*Phytopathology*, 1919, 9, 36-42, 2 pls., 2 figs.) has demonstrated that these fungi may become parasitic and cause considerable damage. The fungi under observation were *Penicillium oxalicum*, *Aspergillus niger*, and *Clonostachys araucariæ* var. *rosea*. The author compares the rot caused by these moulds with the damage done by *Fusarium radicicola*, a serious wound-parasite of the potato. The lesions made by *Aspergillus niger* were almost as deep as those made by the *Fusarium* in the same time; those by the *Penicillium* a little less so, while those by *Clonostachys* lagged some way behind. He found, however, that the *Aspergillus* was less likely to cause infection than the *Penicillium*. A. L. S.

Diseases of Yams.—The yam affected, *Dioscorea preheusilis*, was collected in Nigeria and sent to Kew for examination. E. M. WAKEFIELD (*Kew Bull.*, 1918, 199-201, 1 pl.) found that the cause of the disease was a fungus belonging to the genus *Bagnisiopsis* (Dothideaceæ). It attacks isolated branches of the yam-vine, blackening and destroying them; the internodes are shortened and the leaves dwarfed. A diagnosis of the fungus *B. Dioscoreæ* is given. A. L. S.

Disease of Cabbage.—M. P. HENDERSON (*Phytopathology*, 1918, 8, 379-431, 10 figs.) has made a thorough study of a disease of the leaves, stems, and roots of cabbage due to the fungus *Phoma lingam*. The plants are most susceptible in the seedling stage, but may be attacked at any time. Lesions are produced at the infected areas, and the small black pycnidia appear on the sunken tissues. Various Cruciferae are also liable to infection. Advice is given as to treatment both of the plants and of the infected soil.
A. L. S.

Rubber Disease.—A. SHARPLES (*Ann. App. Biol.*, 1918, 4, 153-78, 6 pls.) publishes an account of disease due to *Ustilina zonata*, which was first known as a disease of tea and other plants, but which also attacks *Hevea brasiliensis*, and in Malaya is responsible for the death of many trees. The roots are chiefly attacked, and fructifications of the fungus are found at the collar. Holes made by boring insects are entered by the fungus, which spreads thence through the tissues. The writer recommends strict sanitation methods, clearing the ground of rotting timber, and the removal of old trees.
A. L. S.

Potato Leaf-roll.—E. J. WORTLEY (*Phytopathology*, 1918, 8, 507-29, 16 figs.) has made a study of the occurrence and history of this disease in Bermuda. After describing the effects produced on the potato plant he states that if the plants are carefully dug up the roots and stolons show darkened patches bearing on the surface the characteristic mycelium of *Rhizoctonia*. A long account is given of experiments in planting different kinds of potatoes.
A. L. S.

Diseases of Parsnip.—After describing a cracking disease of parsnip due to weather changes, A. D. CORTON (*Kew Bull.*, 1918, 8-21, 2 pls., 2 figs.) has added a summary of diseases due to fungi:—*Erysiphe Polygoni*, *Phyllachora Pastinacæ*, *Ramularia Pastinacæ*, *Cercospora Pastinacæ* and *Plasmopora nivea*, all of which occur on the leaves and petioles of *Pastinaca sativa*.
A. L. S.

Rose-blotch Fungus.—N. L. ALCOCK (*Kew Bull.*, 1918, 193-7, 1 pl., 2 figs.) gives an account of this fungus, which produces black blotches on the leaves in summer and autumn. The ascigerous stage has never been found in this country, but some years ago such a stage was discovered in America, and described under a new genus, *Diplocarpon* Wolff (Microthyriaceæ). The writer found conidial pustules on young twigs; she suggests remedial measures, either spraying or removing all leaves and twigs that have been attacked.
A. L. S.

Treatment of Scab in Potato Tubers.—G. H. COONS (*Phytopathology*, 1918, 8, 457-68) records satisfactory results in the treatment of seed potatoes by sprinkling them with formaldehyde or by immersion in solutions of mercuric chloride. Without such treatment the crops raised from scattered tubers were poor and weak. Coons prefers the treatment with corrosive sublimate, 1 in 1000, for one half-hour.
A. L. S.

Blossom Wilt and Canker of Apple-trees.—This disease, due to *Monilia*, has been investigated by H. WORMALD (*Ann. App. Biol.*, 1917, 3, 159-204, 3 pls.). It has caused great loss to growers in the south-east of England. Infection takes place through the open flowers which are wilted; the fungus then penetrates into the tissue of the flowering spur, which it kills: it may also reach the branch and produce a canker. *Monilia* conidia are produced on these dead spurs during winter and spring, and reinfect the blossoms. The fungus is probably identical with *M. cinerea* Bon. It may be kept in check by cutting out the diseased spurs and cankers. A. L. S.

"Wither Tip" of Plum-trees.—This disease is also due to *Monilia*, and an account of it has been published by H. WORMALD (*Ann. App. Biol.*, 1918, 5, 28-59, 3 pls.). The fungus is morphologically similar to *M. cinerea*, which causes "blossom wilt" of apple-trees, but must be considered as a "biologic form," as the results of infection are not the same. As with the above, Wormald advises the careful destruction of affected twigs, branches, etc. A. L. S.

Disease due to Cytospora.—W. N. C. BELGRAVE (*Ann. App. Biol.*, 1915, 2, 183-94, 10 figs.) has investigated the recurrence of this fungus on plum-trees in Cambridgeshire causing die-back. The first sign of disease is the withering of the leaves, usually progressing from the top of the trees downwards. The pycnidia appear in crater-like swellings of the bark. The spores were isolated and grown in pine cultures, pycnidia being successfully reproduced. The fungus is nearly related to, if not identical with, *Cytospora leucostoma*. No further stage was observed. Belgrave gives an account of the effect produced in the tissues by the fungus. A. L. S.

Disease of Carnations.—This has been investigated and described by P. A. VAN DER BIJL (*Ann. App. Biol.*, 1916, 2, 267-91, 4 pls.). It is known as "wilt" or "crown-rot," and is caused by a *Fusarium*. Culture experiments were carried out successfully, and great attention is paid to means of combating the disease. A. L. S.

Lichens.

Lichenology in Great Britain.—A. LORRAIN SMITH (*Trans. Brit. Mycol. Soc.*, 1918, 6, 32) publishes a statement intimating that the Mycological Society has decided to associate the study of Lichenology with that of Fungology. The Society invites lichenologists to become members, and so advance the study of lichens by collecting during the annual forays and by publishing papers on the subject. A. L. S.

Monograph of British Lichens.—Part I. of the Catalogue of British Lichens has been rewritten by A. LORRAIN SMITH (*British Museum (Natural History)*, 1918, xxiv and 520 pp., 71 pls. and figs.). It

is prefaced by an introduction giving a short account of the structure and biology of lichens. Orders, genera, and species have been rearranged on modern lines. The changes in classification and nomenclature rendered necessary have been explained, and synoptic keys to orders and genera are provided. Large genera have been divided, and the species arranged in definite groups, which should simplify the study of lichen plants.

A. L. S.

New Lichen Genus.—BRUCE FINK (*Mycologia*, 1918, 10, 235-8, 1 pl.) has placed in a new genus, *Collemodes*, the lichen examined by Freda M. Bachman as *Collema pulposum*. Bachman found in the lichen a new type of reproductive cells. The spermatia are budded from hyphae in the interior of the lichen tissue, and the trichogyne grows towards these groups of spermatia and fuses with one. The lichen is otherwise indistinguishable from *Collema pulposum*, but it is not uncommon, and has been collected in several American States. The new species is published as *Collemodes Bachmanianum*.

A. L. S.

Lichens of Sand-dunes.—W. WATSON (*Journ. Ecol.*, 1918, 6, 126-43), in his study of the cryptogamic vegetation of sand-dunes, has made a careful examination of the lichens. On somewhat loose sand-hills the lichens associated with Cyanophyceae, such as *Peltigeræ*, *Collema*, etc., are the chief types. In more stable positions other and varied forms make their appearance, many of them with bright green gonidia. Trees are rare, but they carry a varied lichen-flora, not differing, however, from the tree-lichens further inland.

A. L. S.

Bryophytes and Lichens of Calcareous Soil.—W. WATSON (*Journ. Ecol.*, 1918, 6, 189-98) indicates first the lichens that are distinctly calcifuge, then those that grow indifferently on any soil, or with a preference for calcareous substrata. He then gives lists of those found on calcareous walls, on chalk, on limestone grassland, limestone woods, and calcareous rocks, both shaded and exposed. A number of crustaceous calcicole lichens secrete an acid which forms pits in which the lichen fruits are sheltered.

A. L. S.

Notes on the Ecology of Lichens.—R. PAULSON (*Essex Naturalist*, 1918, 19, 276-86, 3 pls.) has studied this subject in Epping Forest. He notes the greater abundance of lichens where oaks are dominant than where hornbeam is the principal tree. The latter casts a deeper shade, which inhibits the growth of most lichens. The nature of the soil, whether it be wet or dry, also influences the growth of lichens on the trees. Paulson also adds observations on the longevity and rate of growth of lichens.

A. L. S.

Lichens of a Boulder-clay Area.—The boulder-clay area worked by A. MAYFIELD (*Ipswich and District Field Club*, 1916, 5, 34-40) is situated in the centre of the county of Suffolk. He gives a general account of the lichen-flora of the various associations of trees in the district, with special attention to the kind of bark and of the

aspect. Terricolous species were few in number. "Only four plants, *Collema pulposum*, *Cladonia pyxidata*, *C. furcata* var. *corymbosa*, and *Peltigera polydactyla*, attain proper development on hedgebanks and roadsides." A list of all the species found is appended. A. L. S.

Mycetozoa.

Shrewsbury Mycetozoa.—G. LISTER (*Trans. Brit. Mycol. Soc.*, 1918, 6, 15–17) publishes a list, with occasional notes, of Mycetozoa collected at Shrewsbury during the annual fungus foray. The list numbers forty-seven species. A. L. S.

Haunts of the Mycetozoa.—G. LISTER (*Essex Naturalist*, 1918, 18, 301–21) has published her Presidential Address given to the Essex Field Club dealing with the above subject. She discusses these in order, and gives the characteristic Mycetozoa that occur in the different situations. Such are woodlands with fallen timber, stumps and leaves, sawdust heaps, spent tan, many different kinds of logs, trees, hedge-clippings, straw-heaps, manure, etc. The writer also gives an account of the species that specially favour Alpine pastures as well as various tropical habitats. Finally a summary is given of species according to habitat. A. L. S.

Mycetozoa in Britain.—G. LISTER (*Essex Naturalist*, 1917–18, 18, 207–37) has issued, in her Presidential Address to the Essex Field Club, an account of the study of Mycetozoa in this country. The first record was made by John Ray in 1696, who describes a "certain small scarlet fungus," now known as *Lycogala epidendrum*. Further records were made by Dillenius, and later by Sir John Hill. Other authorities are quoted down to our own day. The latest scientific work on the group is carefully noted. G. Lister then tabulates the species found in Epping Forest, numbering 82. She compares this list with those of several other counties in England and Scotland. A. L. S.

Mycetozoa of Chingford District.—JOSEPH ROSS (*Essex Naturalist*, 1917, 18, 192–3) has published comparative lists of Mycetozoa for the above district in August and September, 1915 and 1916. Heavy rains in July, 1915, produced a fine crop of Mycetozoa, and some 35 species were listed. Dryer conditions in 1916 resulted in a less abundant growth, but a first record was made for Essex, *Arcyria Erstedtii*.

A. L. S.

MICROSCOPY.

A. Instruments, Accessories, etc.

(3) Illuminating and other Apparatus.

The Light scattered by Gases : its Polarization and Intensity. R. J. STRUTT (*Proc. Roy. Soc.*, Series "A," 95). The present investigation is a development in various directions of that described in the Proceedings of the Royal Society, "A," 94, 453, 1918. It is there shown that the light scattered by air and other gases in the direction perpendicular to the beam is almost completely polarized. It is of importance to determine whether or not the polarization of the scattered light at right angles to the beam is complete. Sky light is by no means completely polarized, but in that case the incident light is not all in one direction. The question is whether, apart from these complications, the polarization would be complete. This cannot be decided by observations on the sky, but the laboratory methods now described allow of this investigation, not only in the air, but in other gases also.

The simple theory, according to which the polarization should be complete, assumes a spherical form for the molecules. That is to say, it is assumed that, however the molecule may be turned with reference to the direction of vibration in the primary beam, the result will be the same, and vibration induced will be wholly in that direction.

Any departure from complete polarization would indicate that the molecule had certain preferential directions of vibration. The extreme case would be that in which the molecule could only vibrate in one direction fixed within it. The experimental arrangements for examining the polarization are the same as that described in a previous preliminary paper, except that slight modifications were introduced to enable the investigations to be made under the conditions specified.

Since the effect to be looked forward for is small it is desirable to make the primary beam as intense as possible. An electric arc therefore was used with "Kinarko" kinematograph carbons. These carbons give great intrinsic brightness. The horizontal core carbon charged with a special preparation was 18 m.m. in diameter, presented end on to the condensing lens. The copper cord negative carbon, nearly vertical, was 10 m.m. in diameter. The current was about 25 amperes and the lamp was a hand-fed one.

The varying intensities of the polarized beam were recorded by means of a photographic plate, so that reliance was not placed on observational methods, but the result was determined by the differing capacities of the photographic deposit as shown by the resulting plate. The results obtained may be summarized as follows :—

1. The light scattered at right angles by gases and vapours is not completely polarized. The vibration parallel to the exerting beam has

already an appreciable intensity, which in ordinary cases varies from 1.2 p.c. in pentane to 14 p.c. in nitric-oxide of the intensity in a perpendicular direction.

2. Helium is an outstanding case, polarizing far less perfectly than any other gas. The measurements give an intensity in the parallel component nearly half as great as that which is in the perpendicular component.

3. Theory indicates that this is the ratio to be expected if the vibration in the helium atom is limited to a direction fixed within the atom, on the assumption, of course, of random orientation to the exciting light. Such an atom is the antithesis of the spherical atom or molecule which would give perfect polarization.

4. The intensity of scattering by the different gasses tried varies as the square of the refractivity within the limits of experimental error.

5. Saturated vapours, even when very dense, show no increase of scattering power beyond what the density would lead one to expect. If molecular aggregates are formed they are not numerous enough to show by this method.

6. Liquid ether apparently scatters about six times less light than the corresponding mass of ether vapour. J. E. B.

(5) Microscopical Optics and Manipulation.

National Physical Laboratory Report for the year 1917-1918.—That portion of the report dealing with Optical Glass Testing is of interest to microscopists.

The number of specimens of glass experimented with has risen largely during the past year. The Auxiliary Apparatus used in connexion with these tests, which was mentioned in the last report and was shown at the Optical Society's Exhibition held in January, 1917, has continued to give the greatest satisfaction.

The tests are made on a Pulfrich Refractometer, and experience shows that a properly constructed instrument of this type, used under suitable conditions, gives entirely reliable and accurate results. During the past year investigations of a comprehensive character, both experimental and theoretical, have been made on various aspects of Refractometry and on the types of instruments suitable for high accuracy in such measurements. As a result proposals for a new form of instrument have been made, but this unfortunately cannot be obtained during the War.

There have been several requests during the past year for the examination for optical properties of specimens of glass which were not specially prepared for that examination. Presumably this refers to the testing of pieces of glass which have neither of their surfaces polished, and which, therefore, cannot be tested by the Refractometer method. The tests in these cases are carried out by an immersion method. The accuracy obtainable varies with different specimens, but it has proved sufficient in all cases to enable the particular glass employed to be identified. The accuracy is, of course, less than that which is secured when suitably prepared specimens are tested. J. E. B.

{B. Technique.**(3) Cutting, including Embedding and Microtomes.**

Modification of Hand Microtome.—T. H. GOODSPEED (*Botanical Gazette*, 1918, **66**, No. 6, 534-6, 5 figs.). Figs. 1-5 represent a simple modification of the familiar hand microtome, and the author has found it to be a decided improvement over the original instrument from which it was derived. In the ordinary type, when cutting sections of woody stems or more delicate material held in pith, it is always difficult to be certain of obtaining the necessary pressure for holding the material at the proper point. The steel rod which moves in or out upon the turning of the single pressure screw will usually hold the material firmly at its lower end, but not so firmly at its upper end, with the result that the material has a tendency to wobble when the knife begins to cut the section. On the other hand, when this difficulty does not arise it is often almost impossible to screw up the material for the next section because of the pressure of the material against the walls of the tube or well.

To obviate these rather commonly encountered difficulties in the ordinary type of hand microtome the modification of it shown in the figures has been devised. Figs. 4 and 5 give two views of an inner "material holder." It consists of two pieces of curved steel which are long enough to reach to the bottom of the tube or well (just below *cc* in fig. 2). This inner material holder is provided with a spreading spring at *cd* which surrounds a small steel bar *cc*. Each curved piece of steel has a hole at *aa* (fig. 4) through which project the ends of the two pressure screws *bb* (fig. 2). The manipulation of the apparatus is as follows where, for example, cross-sections of a woody stem are to be cut. The pressure screws *bb* are turned out until their ends at *aa* are pulled out of the holes in the material holder. The microtome is inverted and the material holder falls out. The stem or a portion of it is placed between the leaves of the material holder and properly oriented, and if necessary a rubber band is bound around the material holder just above *aa*. The material holder, containing the stem, is now pushed down into the well or tube of the microtome and oriented so that the holes are opposite the ends *aa* of the turned-back pressure screws. These screws are turned in, their ends pass into the holes in the material holder, and pressure is finally exerted on both sides. As the pressure becomes greater, the spring at *cd* prevents the upper ends of the material holder from spreading, and ensures maximum pressure against the material at these upper ends. Finally, the stem is held firmly in the centre of the tube or well of the microtome between the leaves of the material holder. The pressure screws are free to move up or down in their openings because no appreciable pressure is exerted upon the walls of the tube or well.

In a similar manner material held in pith is very conveniently arranged in this apparatus. The possibility of arranging and orienting such material held in pith in the material holder outside the microtome

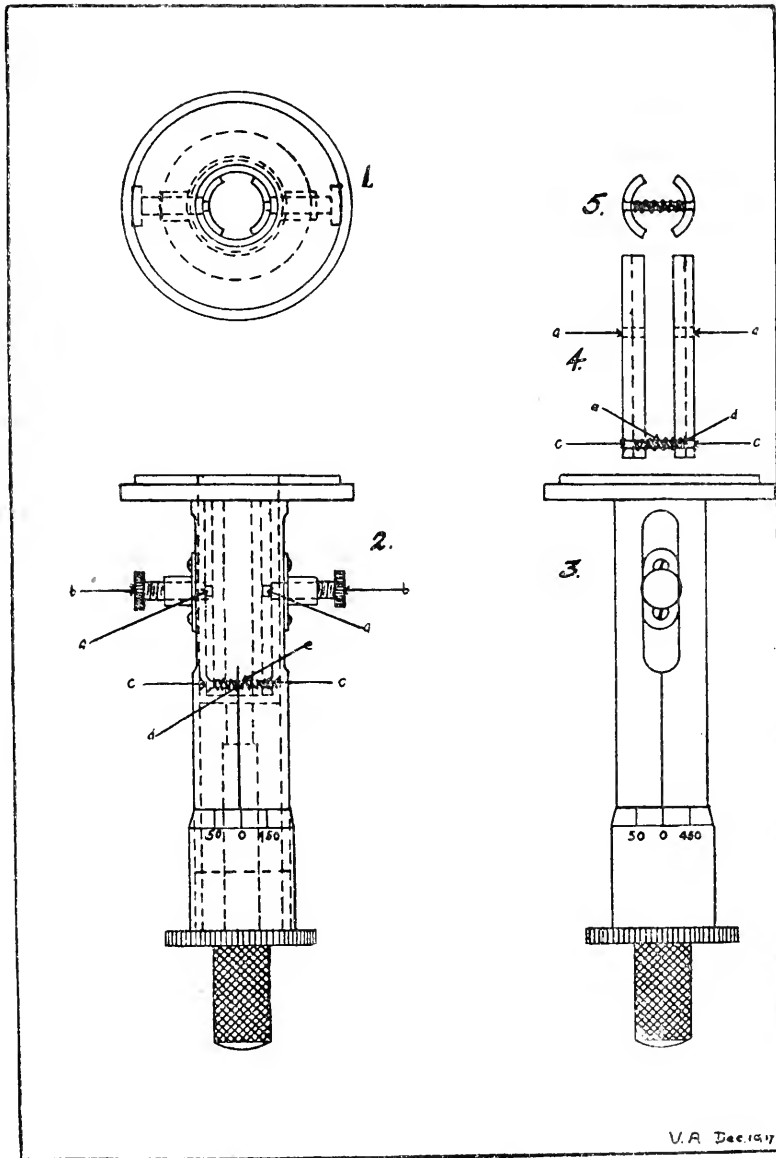

is an obvious advantage. Longitudinal sections of small woody stems are readily cut in this modified hand microtome, whereas their small diameter makes it very difficult to secure them firmly in the original apparatus. As may be seen, it is possible to orient material to obtain all angles in the case of sections to be cut obliquely or in the case of unsymmetrical material.

The original modification from which the drawing was made has been somewhat improved recently. The knurled heads *bb* should be much larger than those illustrated, and for woody stems the leaves of the material holder should be thicker and their inner surfaces more nearly flat.

A. N. D.

METALLOGRAPHY, Etc.

Decomposition of Metals.—COLONEL A. I. KRYNITZKY (*Chemical and Metallurgical Engineering*, 20, No. 6, March 1919). A critical review of various theories which have been advanced from time to time to explain the so-called "Disease of Metal." Allotropy, recrystallization, corrosion, and season cracking may each be responsible for some types of such failures.

Etching Media commonly used in Non-ferrous Metallography.—J. SMOUT (*The Metal Industry*, 1918, 14, No. 1). A few of the different classes of etching. Describes etching media used for copper, brass, bronze, nickel, German silver.

Rapid Recrystallization in Deformed Non-ferrous Metals.—D. HANSON (*The Metal Industry*, 1918, 13, 183) describes recrystallization phenomena of aluminium, magnesium, zinc, lead, copper and certain alloys of the same.

The Metallography of Aluminium.—ROBERT J. ANDERSON (*The Metal Industry*, 14, No. 13, March 1919). Exaggerated growth in aluminium. Silver bands in aluminium. Polishing and etching aluminium.

The Micrography of Aluminium and its Alloys.—D. HANSON and S. L. ARCHBUTT (*The Metal Industry*, 14, No. 14, April 4, 1919). Preparation of sections. The micrographic constituents of aluminium alloys. Pure aluminium. Copper-aluminium alloys. Zinc-aluminium alloys. magnesium-aluminium alloys, manganese-aluminium alloys.

A Few of some of the Mechanical Properties of the Alloys of Copper and Zinc.—F. JOHNSON (*The Metal Industry*, 13, 188-190) describes certain tests made by members of the Metallurgy Department of the Birmingham Technical School, showing relations between Brinell hardness, scleroscope hardness, tensile tests, microscopic examination and analytical examination of parts as cast and after annealing.

The Properties of some Copper Alloys.—W. ROSENHAIN, B.A., and D. HANSON (*The Metal Industry*, 14, No. 14, April 14, 1919). Alloys of copper with aluminium, with manganese and aluminium, not containing zinc. Alloys free from aluminium.

Effect of Heat Treatment on Bronze.—F. F. HAUSEN and O. A. KNIGHT (*The Iron Age*, 1919, 103, No. 6, 347). Characteristics disclosed by Brinell hardness tests and photomicrographs. Quenching and drawing give greater hardness than quenching alone.

Flakes in Alloy Steel.—HOWE, CLAYTON, RAWDON, FOLEY, and LANEY (*The Chemical and Metallurgical Engineering*, 1919, **20**, No. 5, 216). An outline of papers and discussion of this important defect presented at the New York meeting of the American Institute of Mining Engineers.

Grain Limits in Heat-treated Alloy Steels.—R. S. ARCHER (*The Iron Age*, 1919, **103**, No. 6, 366). New etching process which defines the crystals, boundaries, and assists in detecting faulty heat treatment.

New Light on Transverse Fissures.—G. F. COMSTOCK (*The Iron Age*, 1919, **103**, No. 10, 613). Phosphorus streaks as a cause of such rail defects. How they form and what they are. Effects of reheating the blooms.

Static, Dynamic and Notch Toughness.—SAMUEL L. HOTT (*The Iron Age*, 1919, **103**, No. 9, 545). Value of the Charpy test in determining ability of steel to resist rupture under notch conditions. Its use in Europe.

The Metallography of Heat Treatment of Metals used in Aeroplane Construction. II.—F. GROTTTS (*Chemical and Metallurgical Engineering*, 1918, **19**, 191-196). Investigation of parts made from medium-carbon, high-carbon and chrome-nickel steels. Causes of failure in cam wheels, piston pins and crank shafts.

PROCEEDINGS OF THE SOCIETY.

AN ORDINARY MEETING

OF THE SOCIETY WAS HELD AT 20 HANOVER SQUARE, W., on
WEDNESDAY, DECEMBER 18TH, 1918, AT 5.30 P.M., MR. J. E.
BARNARD, PRESIDENT, IN THE CHAIR.

The Minutes of the last Meeting were read, confirmed, and signed by the President.

Mr. Herbert George Blackmore was duly elected a Fellow of the Society.

The following Exhibits were made, and votes of thanks passed to the Exhibitors :—

Mr. Earland :—A slide of Cretaceous Foraminifera from Chalk Marl, taken from a shell crater at Noyelles-sur-Escout, just inside the Hindenburg Line, sent by Mr. Heron-Allen.

Mr. E. J. Sheppard :—Slides showing sections of Testes of Hermaphrodite Goat, sent by Mr. Basil Adams.

Mr. Scourfield :—Eye-piece Micrometer, by J. Rheinberg, with eccentric scale.

Col. Castellani read a paper on "Tropical Diseases met with in the Balkanic War Zone."

The paper was illustrated by microscopical slides showing *Oidium asteroides*, *O. matalense*, *O. rotundatum*, *Monilia balcanica*, *Accladium* Cast. and Pinnoy, 1916, *Fungus*, sp. 48, *Hemiphora rugosa* (Bronch.), *Tokelau*, and *Tinea imbricata*, and also by a number of lantern-slides. The paper will appear in the pages of the Journal.

Dr. Eyre, in moving a very hearty vote of thanks to Col. Castellani for his most interesting paper, which helped to show the valuable place filled by the microscope under war conditions, said that a few years ago the use of the microscope and laboratory methods were looked at askance by the older school, and it had taken a European War to bring home not only to the man in the street but also to the medical practitioner the immense advantages that could be derived from the use of the microscope. The experiments of Col. Castellani had helped to win the War, and in bringing them to the notice of the Society he had opened up a

still wider field. He had touched upon the parasitic fungi. Some of the cultures were quite new, and when there had been time to sort out the immense amount of material that had been collected, he hoped that Col. Castellani would be able to come and give the Society the result of his investigations in microscopical fungi.

Mr. Earland seconded the vote of thanks, which was carried by acclamation.

The following papers by Dr. Hartridge were read :—" An Improved Method of Apertometry "; " A Method of Adjusting Tube-Length "; " Eye-pieces with Adjustable Compensation."

A hearty vote of thanks was accorded to Dr. Hartridge for these papers, which will appear in the pages of the Journal.

It was announced that the next Meeting would be held on January 15th, and that of the Biological Section on January 8th, when Mr. Scourfield would make a communication on "The Sense Organs of *Daphnia* and its Allies."

AN ORDINARY MEETING

OF THE SOCIETY WAS HELD AT 20 HANOVER SQUARE, W., ON WEDNESDAY, JANUARY 15TH, 1919, MR. A. EARLAND, VICE-PRESIDENT, IN THE CHAIR.

The Minutes of the preceding Meeting were read, confirmed, and signed by the Chairman.

The nomination papers were read of the following Candidates for Fellowship :—

Mr. Ahmed Zahy Abnshady, L.M.S.S.A.
Mr. Ernest Henry Grant.

The Annual Report of the Council for 1918 was read as follows :—

FELLOWS.

During the year 33 Ordinary Fellows have been elected, 10 have died, and 15 have resigned or have been removed from the Roll. One Honorary Fellow has been elected. The names of 7 Honorary Fellows

and 12 Ex-officio Fellows have been removed from the Roll. The number of Fellows at the end of the year 1918 was as follows :—

Ordinary	387
Honorary	20
Ex-officio	69
Corresponding	1
	<hr/>
	477

Of the Ordinary Fellows—

305	have paid the annual subscription.
37	have compounded.
13	have had subscriptions remitted.
32	remained unpaid (of these three have since paid).
<hr/>	
387	

The deaths referred to above included those of Dr. Hebb, for many years Secretary of the Society and Editor of its Journal, and Professor H. G. Plimmer, who was President of the Society for the years 1911 and 1912.

FINANCE.

The Financial Statement will be presented at a subsequent Meeting.

JOURNAL.

The death in May last of Dr. Hebb, the Editor of the Journal, was a very serious loss to the Society, and this, coupled with the difficulties connected with the supply of paper and the increased cost of printing, caused your Council great anxiety. Dr. Singer very kindly offered his services as Honorary Editor, and they were gladly accepted, together with offers of assistance from other Members of the Council. It is hoped in the near future, when more normal conditions return, that the Journal may be developed and exercise a wider influence in all branches of microscopical science.

The Council wishes to take this opportunity to thank most cordially the Contributors and Abstractors for their valuable work during the past year.

LIBRARY.

The Library has been utilized by a considerable number of Fellows, and the number of books borrowed from Lewis's Library has been larger than usual. During the year an innovation has been made by arranging for the rooms of the Society to remain open on Wednesday evenings (other than meeting evenings) from six to nine o'clock, in order to afford greater facilities for the use of the Library.

INSTRUMENTS AND APPARATUS.

The Instruments and Apparatus are in excellent condition.

During the year the Society has received the following donations:—

- Lady Flower :—An old Microscope, by Hugh Powell, with accessories.
 Mrs. Hebb :—Microscope, by Baker, with Polariscope and other accessories, which had been in constant use by the late Dr. Hebb.
 Mr. J. Rheinberg :—A Set of Photographic Scales and Micrometer Rulings.

In connexion with the British Science Guilds' Exhibition of Scientific Products at King's College, the Society exhibited a number of instruments to illustrate the Evolution of the British Microscope, and a special report on this subject appears in the Journal.

CABINET.

During the year the Slides Cabinet has been thoroughly overhauled and reclassified, and a full report has been presented, which has appeared in the Journal. The Council has expressed its appreciation of the enthusiastic exertions of the Sub-Committee, consisting of Mr. A. Earland and Mr. E. J. Sheppard, which has undertaken this work so successfully, and trusts that the Fellows of the Society will now co-operate in providing slides for those sections which are at present inadequately represented. The Cabinet will be available for the use of Fellows in the course of a few months, on the completion of the Card Index.

During the year the Council has received from Dr. Urban Pritchard a valuable addition to the Cabinet, in the shape of 100 special Diatom Slides.

The Wallich Collection, consisting of 995 Diatom and other Slides, together with a series of descriptive note-books and drawings illustrating the Collection, has been presented by the Society to the Trustees of the British Museum.

MEETINGS.

Notwithstanding the abnormal conditions under which the work of the Society has been carried on, the meetings have been held as usual, the attendance of Fellows and Visitors has been maintained, and the papers read have been well up to the high standard set by the Society.

The **Biological Section**, which meets on the first Wednesday of each month, has had a most successful programme of events, which has included special visits to the London School of Medicine for Women; the John Innes Horticultural Institute, Merton; King's College Laboratories.

The thanks of the Society are due to Mr. J. Wilson for his continued energy and activity as Honorary Secretary of this Section.

Mr. Mortimer moved, and Mr. E. J. Sheppard seconded, that the Annual Report be received and adopted. Carried.

Mr. Henson moved, and Mr. W. Watson Baker seconded, that a very hearty vote of thanks be tendered to the Honorary Officers and Members of the Council for their services to the Society during the past year. Carried.

The Chairman appointed Mr. D. Davies and Mr. W. Watson Baker to act as Scrutineers, and afterwards announced the result of the ballot for the election of Officers and Council for the ensuing year as follows :—

President.—Joseph E. Barnard.

Vice-Presidents.—Edward Heron-Allen, F.L.S., F.Z.S., F.G.S., M.R.I.A., etc.; Alfred N. Disney, M.A., B.Sc.; F. Martin Duncan, F.R.P.S.; Robert Paulson, F.L.S.

Treasurer.—Cyril F. Hill.

Secretaries.—J. W. H. Eyre, M.D., M.S., F.R.S. Edin.; David J. Scourfield, F.Z.S.

Council.—Herbert F. Angus; Maurice Blood, M.A., F.C.S.; Frederick J. Cheshire, C.B.E.; T. H. Hiscott; Benj. Moore, M.A., D.Sc., F.R.S.; Percy E. Radley; A. W. Sheppard; Edward J. Sheppard; Charles Singer, M.A., M.D.; Joseph Wilson; G. Sims Woodhead, M.A., M.D., LL.D., etc.; B. B. Woodward, F.L.S., F.G.S.

Librarian.—Percy E. Radley.

Curators.—Edward J. Sheppard; Charles Singer, M.A., M.D.

A vote of thanks to the Scrutineers was moved from the Chair and carried.

The Chairman announced that owing to the illness of the President it would be necessary to postpone the Presidential Address until the next Meeting. As the news had only reached them that morning, it was too late to send out notices or arrange for other papers. Mr. Scourfield had however kindly stepped into the gap, and had promised to give them a communication on "The Sense-organs of *Daphnia* and its Allies."

The Chairman exhibited a slide of a Schizopod, *Hoplophragmium canariense* (d'Orbigny), at the request of Mr. J. Hopkinson.

Votes of thanks were duly accorded to Mr. Scourfield and the Chairman.

The Chairman announced that the next Meeting would be held on February 19, and that the Biological Section would meet on February 5, when Mr. A. W. Sheppard would make a communication on "The Pollen Chamber of Cycads and its Function."

The business proceedings then terminated.

AN ORDINARY MEETING

OF THE SOCIETY WAS HELD AT 20 HANOVER SQUARE, W., ON WEDNESDAY, FEBRUARY 19TH, 1919, MR. J. E. BARNARD, PRESIDENT, IN THE CHAIR.

The Minutes of the preceding Meeting were read, confirmed, and signed by the President.

The Nomination Papers were read of the following candidates for Fellowship :—

Capt. Raymond S. Harper, M.R.C.S., L.R.C.P.
 Rev. A. F. Gordon Mackay.
 Mr. Albert Taylor.

New Fellows.—The following were elected Ordinary Fellows of the Society :—

Mr. Ahmed Zaky Abushady, L.M.S.S.A.
 Mr. Ernest Henry Grant.

Donations to the Society were reported from :—

The Department of Scientific and Industrial Research—
 “The Theory of Modern Optical Instruments.”
 The Macmillan Company—
 “Mirrors, Prisms and Lenses.”

The thanks of the Society were accorded to the donors.

An Exhibit of Stains, Reagents, and Mounting Media for Microscopical Purposes, and Indicators used in Bacteriology and Volumetric Analysis, manufactured by the British Drug Houses, Ltd., was shown by their representative, Mr. Thomas Tusting Cocking, F.I.C.

The exhibit was arranged for the purpose of bringing to the notice of Fellows of the Royal Microscopical Society, dyes, stains, and other microscopical requisites, of guaranteed purity and of British manufacture, so that microscopists could rely upon obtaining British preparations of uniform purity to replace the pre-war German products.

Specimens of the following were exhibited, showing that much has already been accomplished in this direction, and it was confidently anticipated that the experiments that were being made would result in

a considerable extension of the number of microscopical requisites now available.

DRY STAINS.

Azur I. (methylene azure).	Erythrosin G (di-iodo-fluorescein).
Azur II.	Fluorescein.
Azur II. eosin.	Fluorescein sodium (soluble in water).
Ammonia carmine.	Giemsa's stain.
Di-chloro-fluorescein.	Hæmatein.
Di-chloro-di-bromo-fluorescein.	Jenner's stain.
Di-chloro-di-iodo-fluorescein.	Lithia carmine.
Di-bromo-di-iodo-fluorescein.	Methylene blue polychrome.
Eosin yellow shade (tetra-bromo-fluorescein).	Methylene violet.
Eosin methylene blue.	Picro-carmine lithia.
Eosin orange (di-bromo-fluorescein).	Picro-carmine soda.
Erythrosin A (tri-iodo-fluorescein).	Tetra-chloro-fluorescein.
Erythrosin B (tetra-iodo-fluorescein).	Tri-bromo-fluorescein.
	Tri-chloro-fluorescein.

A colour-chart of fluorescein and its halogen derivatives was exhibited. It had been prepared from equimolecular solutions of the dyes, and showed that each increase in the molecular weight was accompanied by an increase in the depth, and also a change in the colour of the dye.

STAINING SOLUTIONS AND REAGENTS.

Alum cochineal.	Hæmalum (Mayer).
Carbol fuchsin.	Hæmatoxylin :—
Carbol methylene blue.	Delafield's hæmatoxylin.
Carmine :—	Ehrlich's hæmatoxylin.
Beale's ammonia carmine.	" ammoniated hæmatoxylin
Grauacher's alum carmine.	Kleinberg's hæmatoxylin.
" borax carmine.	Bohmer's hæmatoxylin.
" alcoholic borax carmine.	Jenner's stain.
Mayer's borax carmine.	Leishman's stain.
Orth's lithia carmine.	Löffler's stain.
Carmalum (Mayer).	Malachite green.
Edington's hæmacytometer solution.	Methyl violet (aniline water).
Ehrlich's triacid stain.	Phloroglucin.
" triple stain.	Picro-aniline blue.
Eosin 2 p.c.	Picro-carmine ammonia.
Erythrosin 0·5 p.c.	Picro-carmine lithia.
Gentian violet (aniline water).	Picro-fuchsin.
Gram's iodine.	Schultze's solution.
Gibbe's double stain.	Toison's solution.
Giemsa's stain.	

MOUNTING MEDIA.

Alpha-bromonaphthalene.	Dammar varnish.
Cedar-wood oil.	Dammar and mastic.
Canada balsam in benzene.	Glycerin jelly.
Canada balsam in xylene.	

INDICATORS IN SOLUTION AND SOLID FORM.

Azolitmin.	Phenol red (phenol-sulphone-phthalein).
Bromo-phenol-blue (tetra-bromo-phenol-sulphone-phthalein).	Phenacetolin.
Di-methyl-amido-azo-benzene.	Thymol blue (thymol-sulphone-phthalein).
Iodo-eosin (tetra-iodo-fluorescein).	Thymol phthalein.
Laemoid.	
Methyl red.	

In proposing a vote of thanks to Mr. Cocking for his exhibit, the **President** said he did not claim any special knowledge of the action of dyes when employed in microscopical preparations. The necessary tests must be made by those who were accustomed to that class of work. It did not by any means follow that the purest dyes were the most efficient. It was not so much a question of producing the purest dye as of finding a dye, even if it contained a particular impurity, that was most suitable for microscopical work.

The vote of thanks was carried unanimously.

Mr. H. Taverner exhibited Photomicrographs of Water Mites by the Sangster-Sheppard process.

Mr. Taverner was heartily thanked for his exhibit.

The **President** then delivered his Presidential Address, entitled "The Limitations of Microscopy."

Prof. Cheshire moved: "That the best thanks of this meeting be accorded to Mr. Barnard for his Presidential Address, and that he be asked to allow it to be printed in the Journal of the Society."

Lieut.-Col. Clibborn seconded the proposal, which was supported by **Dr. J. Rudd Leeson**, and carried by acclamation.

The **President** thanked the meeting, and said he would regard it as an honour to have the address printed in the Journal.

The **President** announced that the next meeting of the Society would be held on March 19, and of the Biological Section on March 5, when Mr. F. Martin Duncan would make a communication, "Notes on some Marine Crustacea."

JOURNAL
OF THE
ROYAL MICROSCOPICAL SOCIETY.

JUNE, 1919.

TRANSACTIONS OF THE SOCIETY.

III.—*The Identification of Intracellular Structures.*

By J. BRONTÉ GATENBY, Senior Demy, Magdalen College, Oxford,
Lecturer in Cytology, University College, London.

WITH FOURTEEN TEXT-FIGURES.

INTRODUCTORY.

THE object of these notes is to put before zoologists, and to some extent botanists too, certain results in practical histo-chemistry, from the cytologists' point of view. I shall make no attempt to add anything to physiological chemistry, but rather to classify the organs of the cell under their proper heads. Such modern and valuable works as the "Monographs on Biochemistry," by Plimmer, Leathes, Maclean and others, are written from a different point of view from that generally taken by zoologists, and in the present paper I have tried to unite some of the results of biochemistry with those of cytology.

The physiological or bio-chemist writes of his reagents as they affect any given organic substance; the working cytologist regards his fixing reagents, not altogether as they themselves affect the cell or any of its bodies, but as to the state in which cells appear after the fixed material has been treated in up-graded alcohols and a clearing oil. Most biochemists, on the other hand, working on materials extracted in bulk, often after desiccation or by destructive extraction by liquids, lose sight of the view of the worker who deals with individual cell organs.?

A TENTATIVE CLASSIFICATION OF CELL ELEMENTS.

In the animal cell, be it a spleen, germ, nerve-cell or other such structure, the cytologist may meet the following fairly sharply marked bodies : Nucleus and cytoplasm, and in the latter, fat, yolk, pigment, glycogen, mitochondria and Golgi apparatus. My own researches have led me to classify the mitochondria and Golgi apparatus (fig. 1) as the Protoplasmic (or living) Inclusions, and the fat, yolk, glycogen and pigment as well as such bodies as zymogen granules, as Deutoplasmic (Metaplasmic, dead) Inclusions. This classification is given below, and I should mention that it is entirely practical and pays no attention to the theoretical side of the question. While the somewhat arbitrary classes Protoplasmic (living) and Deutoplasmic (dead) may be artificial, and undoubtedly are constantly being bridged by transitional substances, this system has been temporarily adopted, and it merely remains to be seen how far it will stand criticism of other workers.

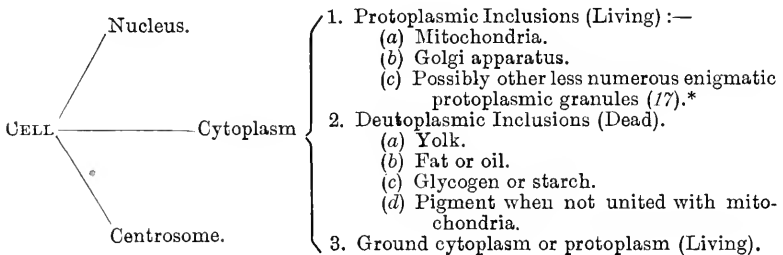

In many animal cells one finds in addition zymogen, oxyphile or basophile, and other (metaplasmic?) elements not mentioned under the Deutoplasmic Inclusions. In all the cases of which I know, these elements are secondary formations derived from various sources in the differentiation of the cell. Thus the granules in different sorts of leucocytes are developed during the differentiation of the cell. The embryonic and indifferent cell does not contain such derivatives, and it is to be understood that the above classification does not particularly deal with all the many enigmatic metaplasmic or deutoplasmic granulations which one meets quite often in the differentiated somatic cells. It is also quite likely (though still disputed) that mitochondria change into zymogen granules and fat; Guilliermond shows that this applies to plant starch, though we do not know so much about glycogen; there would hence be a transition between the cytoplasmic living inclusions and the metaplasmic inclusions. This must be taken into

* The italic figures within brackets refer to the Bibliography at end of the paper.

account in the reading of the above classification. The key to the difficulty lies in differentiation; possibly all embryonic cells would fall under the above classification. One of the greatest difficulties is to ascertain whether the given cell granule is a living plastid-like body, or merely a dead granule, and many of the so-called oxyphile and basophile granules have only been studied in alcohol and acetic acid fixatives, which give deceptive and entirely useless results from this present point of view (Leishman and Jenner).

THE MITOCHONDRIA AND GOLGI APPARATUS IN STAINED SECTIONS.

The mitochondria and Golgi apparatus (figs. 1-3) never clearly appear in stained sections prepared by such methods as fixation in corrosive acetic, Gilson, picro-nitric, Bouin, Carnoy or Flemming-with-acetic acid, and staining in Ehrlich's hæmatoxylin and eosin, toluidin-blue and eosin, paracarmine and borax carmine. Though the mitochondria and Golgi apparatus are properly fixed by formalin, Müller, Flemming-without-acetic acid, Champy, Altmann, etc., they will rarely appear visible in stained sections which have been prepared in Ehrlich's hæmatoxylin or carmine stains, or in fact in any of the current laboratory stains used for general zoological purposes. The mitochondria and Golgi apparatus may appear visible in sections fixed in formalin, Müller, etc., and stained in Altmann's acid fuchsin-picric acid, iron-hæmatoxylin, Benda's alizarin and crystal-violet, etc. The Golgi apparatus rarely becomes visible after any of the above methods, and to study it one must use more specialized methods; to study the Golgi apparatus and the mitochondria by routine zoological laboratory technique is not possible, simply because these methods will not demonstrate the bodies in question.

The Golgi apparatus was first discovered by the Italian worker after whom it is named, and was independently observed by Cajal. Both Golgi and Cajal and their pupils worked principally upon the "apparato reticolare interno," or Golgi apparatus of the nerve ganglion cells of vertebrates. They used exclusively silver nitrate or metallic impregnation methods. The Golgi apparatus of nerve-cells has been studied exhaustively by workers in every country, and new technical improvements have enabled observers to use the Golgi and Cajal silver methods with fairly uniform success. Besides these few silver methods for demonstrating the Golgi apparatus in nerve-cells, Kopsch (8) has perfected an osmic acid method which shows precisely the same structures by a shorter and easier method (see below). Within the last few years Weigl (21), Hirschler (6, 20), Pappenheimer (10), Sjövall (26), and myself (17) and others have applied the silver and osmic methods, or

modifications of them, to every category of glandular and sex-cell in the body of a large number of animals, with the surprising result that it has been established that every animal cell so far studied carefully has been found to possess a more or less typical "apparato interno" of Golgi. Figures of cells showing the typical Golgi apparatus have been given in another paper (17). Certain observers have urged that the Golgi apparatus is only another form

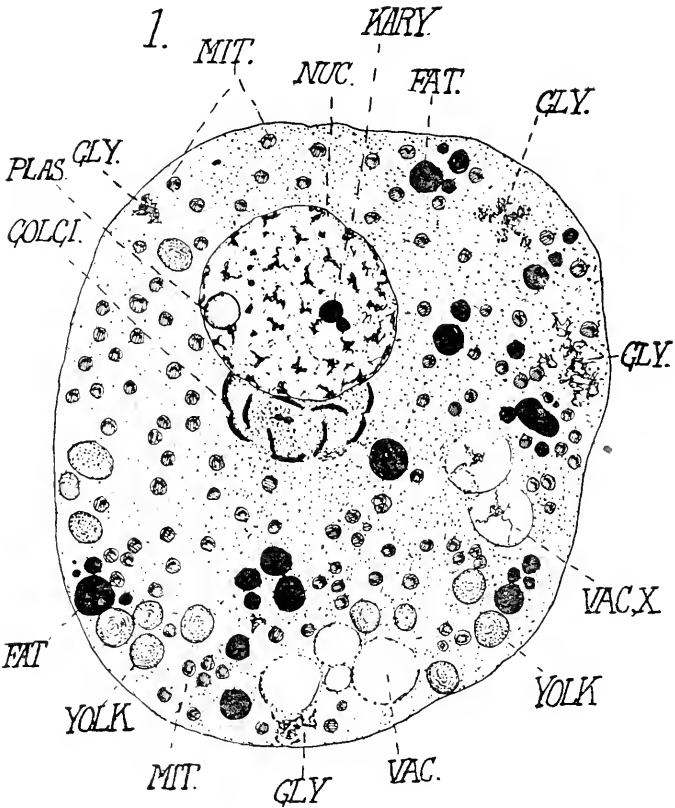

of the mitochondria or chondriokonts; such workers are few, and belong to a small body of cytologists who specialize in one method, and who persist in raising objections without trying other and new methods. The methods of Benda and Haidenhain rarely demonstrate the Golgi apparatus, and unless the techniques of Golgi or Cajal, and Kopsch or Sjövall are used it is impossible in most cases to find the "apparato."

In nearly all cells, and certainly during some period in the life of the cell, the Golgi apparatus lies in the juxta-nuclear position drawn in fig. 1. The apparatus here consists of batonnettes or little rods stuck upon the surface of the archoplasm or attraction sphere. Inside the archoplasm lies the centrosome or centrosomes. In highly differentiated cells, such as the nerve ganglion cell or the egg, and in the only protozoan in which the apparatus has been studied (*Monocystis ascidix*, 20), it is found generally that the batonnettes or grains leave their juxta-nuclear position and pass outwards and become spread out in the cytoplasm (6, 10, 17) (fig. 13). It has now been established by Hirschler, Weigl and myself (6, 17, 21) that the Golgi granules (like the mitochondria) are able to divide independently of the other elements in the cell; both the Golgi elements and the mitochondria are living protoplasmic organs possessing the power of increasing rapidly in number by binary, and in the case of the Golgi elements occasionally (6) by multiple fission. In another section of this paper more

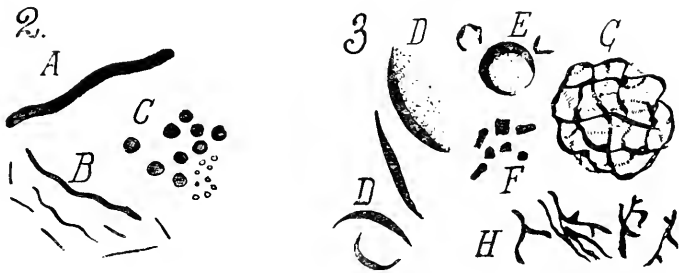

EXPLANATION OF TEXT-FIGS. 1-3. (Not to scale.)

Text-fig 1.—Cell fixed in chrome osmium and stained in Altmann or Benda, except that the glycogen is added to the figure. At NUC is the nucleus; PLAS, plasmosome; KARY, karyosome. At GOLGI is the Golgi apparatus, the separate elements or batonnettes (dictyosome, etc.) black. At FAT is a fat globule gone black with osmium tetroxide. At GLY is the irregular glycogen mass (absolute alcohol and Best's carmine, or iodine). At MIT are the small regular mitochondria (sometimes rod-shaped, fig. 2A). At YOLK are early yolk discs, staining yellowish-green in the osmic acid. At VAC, X, is a vacuole with a small coagulum inside; this may be either a fatty vacuole, or a watery, partially proteid one. At VAC is a vacuole whose contents have entirely gone. This would be a pure liquid one, not containing fat or coagulable proteid.

Text-fig 2.—Different kinds of mitochondrial elements (Mitochondria). A, long chondriokont (*κοντρός*, a pole). B, other kinds of elongate mitochondria or chondriokonts. C, granular mitochondria or chondriosomes.

Text-fig 3.—Various kinds of Golgi elements. D, upper shows a dittosome or batonnette lying upon an archoplasmic mass; lower shows three batonnettes clear of latter. Note shape. E, other forms of multiple batonnettes and archoplasm. F, irregular grains found during cell division after elements separate, preparatory to sorting out between daughter-cells. G, Golgi elements in form of reticulum (juxta-nuclear). H, branched elements free in cytoplasm, after breaking up of reticulum. D, E, G are constant forms.

has been said about the morphology of the Golgi elements and mitochondria. The latter are so well known that it is unnecessary at this juncture to do more than mention that they are granular,

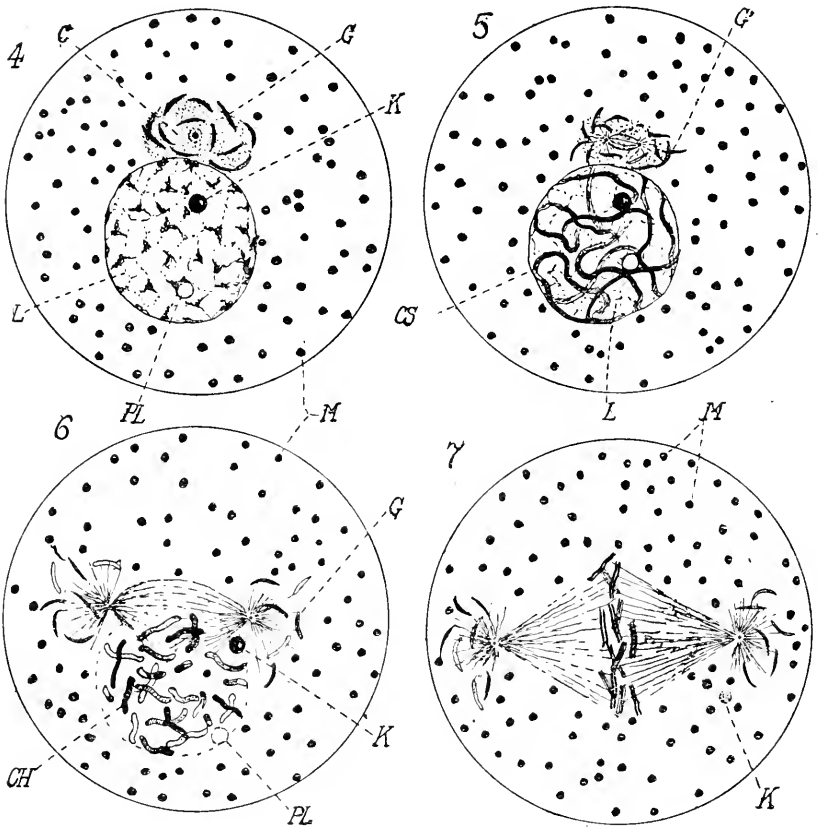

EXPLANATION OF TEXT-FIGS 4-7.

Illustrating Karyokinesis, Dictyokinesis, and Chondrokinesis.
(Diagrammatic.)

Letters.—C = centrosome and archoplasmic sphere. CS = chromatin spireme. CH = chromosomes. G = Golgi rod (nebenkern batonette, dictyosome, chondrioplast). K = karyosome. L = linin of nucleus. M = mitochondrium. PL = plasmosome.

Fig. 4.—“Resting” cell.

Fig. 5.—Prophase; centrosome divided, spindle-forming; archoplasmic sphere disappearing; Golgi rods becoming sorted out into two subequal parts (six and seven); chromatin spireme in nucleus, and mitochondria inert.

Fig. 6.—Nuclear membrane disappearing, karyosome and plasmosome floating free preparatory to degeneration, chromosomes present, and Golgi rods at asters of spindle.

Fig. 7.—Metaphase and splitting of chromosomes, karyosome disappearing.

filamentous or rod-like, generally very numerous elements, strewn through the cytoplasm of cells, and that they have been found in all plant and animal cells carefully studied by experts. There may be rare exceptions where no mitochondria are present, but this is due to the fact that differentiation has for some unknown reason caused the presence of mitochondria to be unnecessary; one such case as this is the duct-cells of the rabbit's liver, and of several other glands in vertebrates.

KARYOKINESIS, DICTYOKINESIS AND CHONDROKINESIS.

Certain Italian workers (12, 22) have referred to the Golgi rod or batonette as a "dictyosome," and Perroncito has suggested that the process of the sorting out of the "dictyosomes" or rods between the daughter-cells during cell-division should be called "dictyokinesis." In my previous papers I have entered into the question of dictyokinesis in Pulmonate Mollusca (17) and Lepidoptera (17). In figs. 4-14 I have drawn diagrammatically the process of dictyokinesis; these figures would apply to all the known examples and varieties of dictyokinesis. In fig. 4 the rods G lie upon the sphere or archoplasm *c*; the centrosome divides and the arrangement of the (thirteen) rods becomes altered; each centrosome attracts to it about half of the whole rods as in fig. 5; the left aster has seven of the rods, the right only six; in fig. 6 this is more easily seen. The rods keep around the amphiastral figure. In figs. 7, 8, 9 and 10 subsequent stages are shown. In figs. 9 and 10 the sphere or archoplasm is reforming, after its dissolution in fig. 5.

In cell-division the mitochondria are also distributed between the two daughter-cells; like the Golgi elements, and unlike the chromosomes, they are only sorted out haphazardly between the new cells. This sorting-out process has been called chondrokinesis, taking the part $\chi\acute{o}\nu\delta\rho\omicron\varsigma$ (a grain) of the words "mitochondrium chondriokont or chondriosome," and the word "kinesis." Examination of figs. 4-10 shows that the mitochondria lie inert in the cytoplasm and are passively distributed between the daughter-cells. In these descriptions of dictyokinesis and chondrokinesis I have made no mention of the fact that some staining change comes over both chondriokonts or mitochondria and Golgi rods or granules during the process of cell-division (17). With reference to karyokinesis, or the division of the nucleus, it is hardly necessary to explain figs. 4-10, as the process has been described in text-books such as that of Wilson on the "Cell." In figs. 6 and 7 the plasmosome and karyosome are seen to degenerate and to become reformed in fig. 10.

The process of dictyokinesis has been described in the following:—Cells of Descemet's membrane of mammalian eye (Deinecka, 23); eight species of Pulmonate Mollusca* (Gatenby, 17); thyroid gland cells of mammals (Cajal, 10); *Paludina* (Perroncito and Gatenby, 17 and 22); Lepidoptera (Gatenby, 17), Argas (Casteel, 24). I have also observed dictyokinesis in many somatic cells of Triton and Rana, but my results have not yet been published, and are much like those of Cajal on the thyroid gland.

In fig. 14 is drawn a type of dictyokinesis in which the Golgi reticulum has broken into more or less irregular granules, which keep around the zone of the amphiaster, but not necessarily around the asters; this type is common in vertebrate gland cells.

In figs. 11–14 rare cases of chondrokinesis or dictyokinesis are given. Fig. 11 is that of the typical spermatocyte of *Paludina vivipara*, where the mitochondria are few and large and have become constricted in the middle so that each cell gets one half of

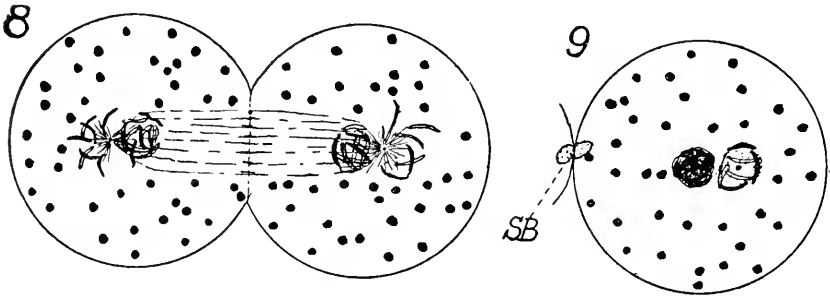

the large mitochondrion (17). Fig. 12 is Wilson's case in the spermatocyte of the scorpion *Centrurus*, where the mitochondria are in the form of a single ring which splits into four, and each spermatid cell gets one portion of the ring (27). Fig. 13 is that of the segmenting ovum (*Limnaea*). The Golgi rods (G) lie inert in the cytoplasm just like the mitochondria, and do not keep around the asters of the segmentation spindle (17, 24). Possibly all eggs (as well as some spermatocytes, etc.) undergo this sort of dictyokinesis and chondrokinesis.

It is to be noticed that the process of dictyokinesis and chondrokinesis is much less exact than that of karyokinesis. In fig. 7 the chromosomes are split longitudinally and not merely sorted out into two portions containing undivided elements, as occurs with the mitochondria and Golgi apparatus. These facts, which have been treated at length in other papers (17), should be borne in mind by those who would consider that the mitochondria are in

* See also Murray, Zool. Jahrb., Bd. xi.

some way bearers of "factors of heredity." It is quite evident that in no cases at present observed do the mitochondria or Golgi elements become distributed between the daughter-cells quite like the chromosomes.

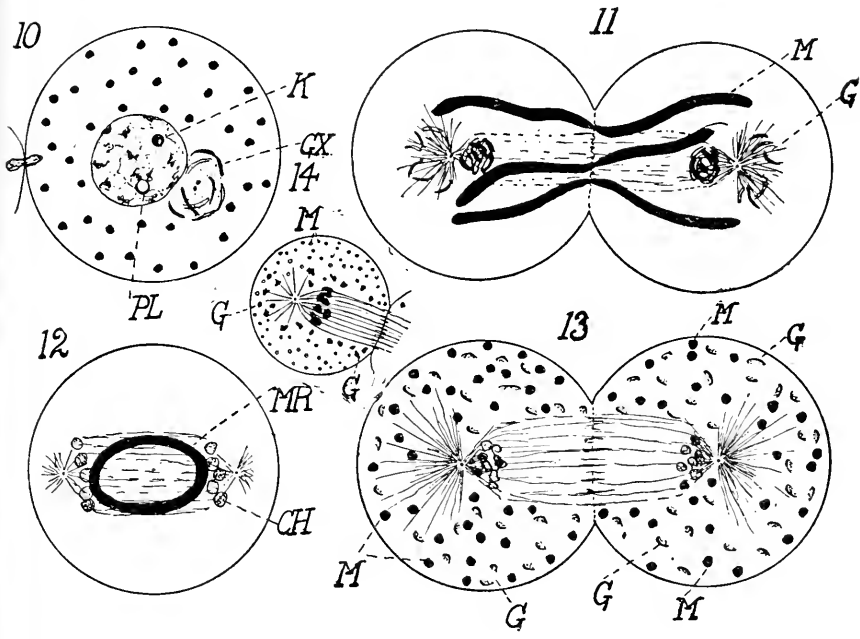

EXPLANATION OF TEXT-FIGS. 8-14.

Illustrating usual and unusual types of Dictyokinesis and Chondrokinesis.

Letters.—Gx = Golgi rod dividing by binary fission. MR = mitochondrial ring. SB = spindle bridge. (Other letters as in text-figs. 4-7.)

Fig. 8.—Late anaphase or telophase. Equatorial plate forming.

Fig. 9.—Late telophase; spindle bridge established from remains of old spindle fibres. Combination of chromosomes to form a nearly solid mass; Golgi rods gathered around the forming archoplasmic sphere.

Fig. 10.—Nucleus reformed; appearance of karyosome and plasmosome; re-constitution of sphere; Golgi rods beginning to divide (Gx).

Fig. 11.—First spermatocyte of *Paludina* (and also exemplifies second spermatocyte of *Centrurus*), showing division of large mitochondria by a constriction in the middle across equatorial plate.

Fig. 12.—First spermatocyte of *Centrurus*, showing mitochondrial ring, which later divides into two sections shaped like those in previous figure.

Fig. 13.—Type of dictyokinesis, found especially in segmenting eggs (possibly all eggs), in which the Golgi elements lie inert in the cytoplasm, and are not attached to any part of amphiaster. In later stages during organogeny this type reverts to that in text-figs. 4-10.

Fig. 14.—Type of dictyokinesis in many vertebrate somatic cells (e.g. thyroid), in which the Golgi apparatus breaks up into irregular granules (G), which keep around the zone of the amphiaster, but do not necessarily adhere to the astral rays. This is possibly a transition form between those in text-figs. 4-10 and 13. In text-fig. 14 the mitochondria are drawn in rings; the cell is the telophase of mitosis.

ON THE NOMENCLATURE OF CELL-DIVISION.

Cell-division therefore involves at least three operations—that of the careful division of the chromosomes; and that of the irregular sorting out of the mitochondria and of the Golgi elements into two subequal portions. The words “karyokinesis and mitosis” refer to the chromatin; it seems advisable to use the words “cell-division,” “cytokinesis” to mean all three processes, karyokinesis, dictyokinesis and chondrokinesis, as below:—

Cell-division or Cytokinesis	}	Karyokinesis and Mitosis (Chromatin)
		Dictyokinesis (Golgi apparatus)
		Chondrokinesis (Mitochondria)

It has now been shown in one form at least (17), that during the development of the embryo every cell which divides not only undergoes karyokinesis but also dictyokinesis and chondrokinesis, and the latter processes are probably as universal as karyokinesis.

It is important to notice that karyokinesis, dictyokinesis and chondrokinesis are all preceded by the division of the centrosome, though the latter is possibly stimulated to divide by the nucleus. To bring the process of division of the centrosome into line with the above nomenclature, it might be called “centrokinesis,” from *κέντρον*, and *κίνησις*, change.

LECITHIN AND YOLK-DISCS AND SPHERES.

The zoologist meets lecithin in the form of yolk-discs, and these structures are familiar to all who have studied amphibian, avian, and other material, where they exist in the form of flattened rounded discs, which may turn quite black in osmium tetroxide fixatives. The chemical elements of yolk have been accurately examined, especially in the hen's egg, and in the yolk of the latter one finds fats, protein, lecithin and cholesterin. The yolk of amphibia and other vertebrates is undoubtedly a compound body, like that of the avian egg; this is a very important point to be remembered. Chemically, lecithin itself may be looked upon as phosphorized fat, and it has many of the properties of fats, but it contains, in addition to phosphoric acid, choline. Lecithin, like fat, is soluble in alcohol and ether, but is insoluble in acetone, which dissolves fat. Mann showed long ago that lecithin crystals go from yellow to brown in osmic acid solution, never black, and this would indicate in the case of oleo-lecithin that in combination the reducing property of the olein is lost. In early or newly forming yolk-discs of such widely different animals as the snail and insect, no amount of soaking in 2 p.c. osmic acid will cause the black colour to appear. Older discs will however gradually turn from yellowish to brown, and still older or mature discs

may go quite black in osmium tetroxide solution. This has been interpreted to mean that apart from any fat content of the lecithin molecule itself, there is a subsequent development of other free fats, among which is constantly found olein. Formalin used as a fixative is found to preserve yolk-discs, but in the case of *Apanteles*, a Bracon fly, I find that such fixation does not prevent the discs from shrinking during passage through up-graded alcohols, while fixation in chrome-osmium mixture (e.g. Flemming's modified formula) prevents shrinkage. This I consider shows that some part of the insect yolk is not fixed by formalin, and is left soluble in alcohol and subsequently washed out. Whether proteid, fat, or cholesterin, this soluble matter is undoubtedly present; I consider that it is a fat. In Amphibia, and possibly in most other animals, the older yolk-discs stain most intensely in iron-hæmatoxylin, and in some forms Benda's stain (crystal-violet following alizarin) strongly colours yolk-discs of all sizes a deep violet; these results are possibly traceable to a staining of some proteid (albuminous matter) contained in the disc in addition to the lecithin, for I find in the ovotestis of the snail that the young yolk-discs which become yellowish in osmic acid refuse to stain either in iron-hæmatoxylin, Altmann or Benda. Under this head the conclusions I have come to by means of microchemical tests are as follows:—

1. The yolk-discs when newly forming do not become black with OsO_4 solution, but stain a yellowish colour somewhat deeper than the general yellow colour of the ground cytoplasm; as they grow larger they become brown with osmic acid, and later may become quite black.

2. The so-called yolk-discs of some animals are, when full-sized, formed of several categories of substances, of which lecithin, proteid and fat are the most important components.

3. The compound structure of the fully formed yolk-discs leads to a variety of results under different techniques whose special properties may be that of preserving either fat, proteid or lecithin separately, or of preserving two or more together, and this result is further confused by the fact that in yolk-discs of different animals the quantities of the three above-mentioned substances may vary.

4. Unless care is taken, the fairly general association of lecithin and free unsaturated fat leads to a confusion of fat with the yolk-discs, for both may go black under treatment with osmic acid. This difficulty is got over by dehydrating the material in acetone instead of alcohols; acetone dissolves away the fat and leaves the lecithin; or it may also be avoided by fixing in formalin and dehydrating and clearing in alcohols and xylol, which dissolve fat and leave yolk (lecithin).

FATS AND OIL.

Oil is a popular name for fats which are liquid at room temperature. The fatty tissue of animals consists nearly, if not always, of a mixture of the three fats—stearin, olein and palmitin. Stearin and palmitin belong to the saturated series, while olein being unsaturated has the property of reducing osmium tetroxide, and so producing the well-known black colour familiar to all who have used osmic fixatives; this property is not shared by untreated fresh palmitin or stearin, but the reduction of osmium tetroxide can be induced in various tissues and cell materials by previous treatment in formalin. The blackening effect of osmium tetroxide can take place in the presence of a chrome compound, such as chromium trioxide (chromic acid), a point the importance of which will appear later.* Various oils have varying olein content, or olein may of course be absent altogether; olive oil, for instance, is largely olein, and is turned by osmic acid a black colour; according to the olein content the oil droplet after treatment in osmic acid may be dark yellowish, brown, to black. As has already been noted, fats are soluble in acetone and xylol, but not after treatment in osmic acid. Vacuoles with a partial coagulum (fig. 1) are possibly caused by the incomplete washing out with alcohol or xylol of a mass partly preserved in the osmic chrome fixative used.

Bolles Lee (²) mentions that apart from the black effect produced in the fresh tissues by osmium tetroxide and olein or oleic acid, palmatin and stearin or their acids may be "browned" by OsO_4 , and subsequently turn black after treatment in alcohol. This is the view of Altmann, Starke and others; but Mann (¹) considers that quite pure palmitin and olein would not blacken with osmium tetroxide, and that any after-blackening effect got with alcohol is due to a reduction and hydration of the OsO_4 into $\text{Os}(\text{OH})_4$ by means of the alcohol, and not of the fats. These opinions are of small importance to the zoologist, because in nature the three fats are nearly always present in any adipose tissue.

With these explanatory remarks on lecithin and fat I may now proceed to give tables which are planned to assist in the identification of those cell-bodies which are met in developmental stages of the organism. The tables are drawn up for the usual methods of the zoologist when preparing sections—that is, fixation in one or more of the commoner solutions:—Flemming, Carnoy, Petrunkevitch, Bouin, formol, Müller, Champy, corrosive acetic, Perenyi, etc., passed through alcohols of different strengths, cleared in xylol, chloroform (not turpentine) oil, embedded either in celloidin or paraffin wax or in both, sectioned, and then stained. More will

* Compare Marchi method for degenerate nerve.

be said about fixatives at a later stage. With regard to the useful manner of distinguishing between fat and yolk (lecithin) by dehydrating the material to be examined in acetone, which dissolves away the fat and leaves lecithin, it should be mentioned that this test is not embodied in my tables because acetone is unsuitable for routine dehydration work, and is scarcely ever used. The tests given by me in paragraphs 3 and 4, sections *b* and *d*, work as well, and can be used on material dehydrated in the more efficient alcohol. I have described the *modus operandi* of the fixatives and stains below.

ANALYTICAL TABLES OF THE MAIN CHEMICAL AND STAINING TESTS FOR CYTOPLASMIC AND DEUTOPLASMIC INCLUSIONS.
(See page 109.)

1. *Golgi Apparatus (Batonette Part, Dictyosome, Nebenkern Rod, Chondrioplast).*

- (a) Black in Kopsch and Sjövall methods.*
- (b) Black in Golgi or Cajal's formol-silver nitrate methods.
- (c) Generally destroyed by acetic acid (circa 5–10 p.c.) even in mixtures containing chrome salts and osmium tetroxide, e.g. Flemming.
- (d) Preserved in formalin (neutral, circa 5–20 p.c.) followed by upgraded alcohols, xylol and wax. (But may not stain in hæmatoxylin of Haidenhain).
- (e) Black in Kopsch-Altman.
- (f) Green when stained in Janus green, 1 in 30,000, *intra vitam*. Sometimes will not stain *intra vitam*.
- (g) Dissolved by alcohol of 80 p.c. (Compare 3, *c*.)
- (h) Rarely (if ever) goes black in Kopsch (OsO_4) to which any part of chromic acid (or $\text{K}_2\text{Cr}_2\text{O}_7$) has been added. Will not blacken in Flemming without acetic. (Compare 3, *c*.)

2. *Mitochondria (Chondriosomes, Chondriokonts, etc.).*

- (a) Yellow to brownish in Kopsch; may go black after Sjövall's method, rarely black after Kopsch.
- (b) Either do not stain, or yellowish in a successful Golgi or Cajal formol-silver nitrate impregnation.
- (c) Act like Golgi apparatus in acetic acid.
- (d) Act like Golgi apparatus in neutral formalin (but always stain in hæmatoxylin of Haidenhain).
- (e) Red to purplish in Kopsch-Altman.

* For these methods see page 109.

- (*f*) Green when stained in Janus green *intra vitam*.
 (*g*) Dissolved by alcohol of 80 p.c. (Compare 3, *c*.)
 (*h*) Do not blacken in Flemming, with or without acetic.
 (Compare 3, *e*.)

Note paragraphs (*a*), (*b*), (*d*) and (*e*) for differences between Golgi apparatus and mitochondria, and paragraphs (*c*) and (*g*) for close similarity. Apart from these tests there are the facts of the shape and position of the Golgi apparatus, and the number and shape of mitochondria, which aid in discrimination between the two. (See below.)

3. Fat (Oil).

- (*a*) Black in Kopsch or Sjövall.
 (*b*) Not preserved by formalin followed by up-graded alcohols, xylol, and paraffin-wax. This means the alcohol and xylol dissolve it away.
 (*c*) Orange-red in an alcoholic (80 p.c.) solution of Sudan III, or scarlet-red.
 (*d*) Left as empty vacuole after ordinary methods, such as HgCl₂ and acetic acid, or Bouin's fluid.
Note.—Oil may, after osmic acid, be left as a vacuole with a dark coagulum; the same, however, may occur in a partly watery and proteid droplet.
 (*e*) Preserved and blackened by a mixture of acetic acid (5–10 p.c.), chromic acid, and osmic acid (e.g. unmodified Flemming's fluid).

4. Yolk, Yolk Discs.

- (*a*) Yellowish, brown, to black in Kopsch or Sjövall, according apparently to amount of free olein content, pure lecithin not going black; only greenish-yellow with OsO₄.
 (*b*) Preserved in formalin followed by up-graded alcohols, xylol, and wax. Generally shrunken after this.
 (*c*) Generally resists acetic acid (5–10 p.c.) in the presence of osmic acid and chrome salts.
 (*d*) Rarely left as a vacuole after ordinary methods (see 3, *d*).

Note for differences paragraphs (*b*) and (*d*). Yolk may stain in Benda's alizarin and crystal-violet, and possibly also in such a stain as Altmann. Yolk often goes a greenish shade with OsO₄, provided the olein content is not too high. Yolk discs containing a good fat content will give all the reactions in section 3, except (*b*) and (*d*). In the fresh state some yolk is grey, but it often contains a pigment (lipochrome). In molluscs yolk is grey in all the cases I have met.

Glycogen (Animal Starch).

(a) Not preserved in water fixatives which contain no OsO_4 , or very small quantities of alcohol.

(b) Preserved in 95 to 100 p.c. alcohol, or Carnoy's fluid.

(c) Reddish brown in iodine-iodide of potassium staining method. (See below.)

(d) Red in Best's carmine stain.

(e) It should be noted that different specimens of tissue have glycogen with differing water-solubility, but watery fixatives must be avoided. See de Waele's method (acetate of copper— OsO_4), Mann (1), p. 296.

Sections (b), (c), and (d) are sufficiently specific.

General Notes.—If the preservation is chrome-osmium, Golgi apparatus, mitochondria, and often yolk may go black with iron-haematoxylin. Benda's alizarin and crystal-violet is not specific for mitochondria, as has been stated; it may stain a violet shade Golgi apparatus, and often insect yolk especially, and the chromatoid, neutral-red, or isolated granule of insect and other spermatids.

It would be a mistake to consider that the above tests act as reliably as chemical tests for inorganic substances; they are only suited to those workers who have had some experience in fixation and staining, and it should be borne in mind that all the elements of the cytoplasm are closely allied and chemically difficult to distinguish. It is also worth while to mention that if one given method fails to demonstrate a desired body, some small modification, such as a longer or shorter time in the fixative or a strengthening or dilution of the latter, may produce the necessary effect.

SMEARS—PROTOZOA AND TESTES.

All the Protozoa (16) so far studied have mitochondria, and in the only case appropriately examined there was a Golgi apparatus present (20). I have little doubt that every protozoan will be found to have a Golgi apparatus. With regard to the above Tables in their bearing on the Protozoa, it has been found that in Schaudium and Bouin smears neither mitochondria nor Golgi apparatus show. In fact, even using F.W.A.* or other mitochondrial fluids followed by iron-haematoxylin, it is a matter of difficulty successfully to demonstrate mitochondria in smears even of metazoan cells. In cases where pieces of parasitized gut, liver with cysts, etc., can be immersed in the fluid (F.W.A., Kopsch, etc.), and the protozoan parasites examined subsequently in sections, the above Tables should be found to agree with the reactions of the cell organs in their

* Flemming's strong formula without acetic acid.

bodies as well as with the host tissue. But smears seem to introduce new conditions. As a general rule, however, grains which appear in ordinary smears will not be found to be either mitochondria or Golgi rods. With regard to the "chromidia," Hirschler (Anat. Anz., XLVII.) remarks: "Die 'Chromidienschollen,' die fast insgesamt mit den Mitochondrien identisch sind, würden vielleicht in einem geringen Teile auch den (Golgi) Apparatelementen entsprechen." This remark, which refers to Protista, will, I believe, apply to many cases of so-called "chromidia," which are often only badly-preserved mitochondria. In many other cases however they do seem to be of true nuclear origin and of chromatinic nature. Nevertheless protozoologists will in the future need to be careful in their use of this term, and in the proper identification of bodies found in many protozoan cells. In the latter one constantly finds isolated granules, or a few granules near or associated with flagellæ or other motile organs. These seem to be distinct from either Golgi apparatus or mitochondria.

Finally, it may be remarked that the above Tables may not apply in every special case. It is naturally quite impossible to draw up a set of tables not liable to exceptions; but I have little doubt that with the invention of newer methods and modification of existing ones, it will eventually become possible to draw up tables which will be liable to very few exceptions. The Analytical Tables given on page 105 are an example of the possibilities of present-day cytology. While such a substance as yolk varies very disconcertingly in its fixing and staining affinities, so much so as to produce confusion, we have such encouraging evidence as the fact that the Golgi apparatus of *Monocystis ascidiæ* shows the same chemical characteristics as that of a mammalian germ cell, and so on. There are many other similar facts, which lead us to believe that the cells of all living animals and plants are fundamentally built on the same general plan, and will be found to contain bodies whose chemical reactions fall under the same heads; wherefore, allowing for special peculiarities, it should be possible eventually to classify cell organs almost as definitely as we have been able to classify chemical substances. It must be mentioned that the fact that all metazoan cells are organized in the same fundamental manner is very remarkable, and is one of the most important results of the latest work on the elements in the cytoplasm.

MORPHOLOGICAL DISTINCTIONS.

Figs. 1-3.

Apart from the histo-chemical tables given, one has certain evidence which can be deduced by the examination of the shape of the body under observation. (See figs. 2 and 3, A, B, C, D, E, F, G and H.)

Golgi Apparatus.—In the form of a reticulum, of rods often branched, but rarely of granules like mitochondria. When reticular the apparatus is easily distinguished from mitochondria, which in only one clear case are known to form a reticulum (Meves, *Apis mellifica*, spermatocyte, 9); in this case a Golgi apparatus is otherwise present. Golgi elements may break into irregular grains during dictyokinesis (cells of Descemet's membrane of eye, 23), or they may form hollowed grains as in some eggs (Ascidia). If in the form of rods, the latter are banana-shaped and curved with tapering ends (Helix, etc.). In most cells, excepting some eggs, the Golgi elements are few in number, much less so than the mitochondria; moreover during cell division they generally keep within the zone of the asters, sticking to the fibres of the aster. Mitochondria may do this, but it is rare.

Mitochondria.—These are nearly always either grains which are very numerous, or unbranched rods (chondriokonts). If rod-shaped, the rods are rarely semilunar, and not drawn out at the ends, but are of uniform thickness. Mitochondria are rarely associated with concentrated regions of the cytoplasm (archoplasm), and rarely form a reticulum like the Golgi apparatus.

Fat and Yolk may exist in the form of more or less numerous spheres, much like mitochondria morphologically, and great care must be taken to avoid confusing them with mitochondria.

MODUS OPERANDI OF THE METHODS OF KOPSCH, KOPSCH-
ALTMANN, SJÖVALL AND CAJAL, ETC.

I. *Kopsch Method.*—Fresh tissue, not exceeding 5 mm. in diam., thrown into 6–10 c.cm. of 2 p.c. OsO₄ in aq. dist. Left from one to two weeks, in the dark, in airtight vessel. Use glass-covered capsule or bottle. Wash in running water overnight (or a few hours will do), up-graded alcohols, xylol, embed in wax, section 3–6 μ , and mount unstained sections in xylol-balsam. Golgi elements, fat, and larger yolk discs black; mitochondria from yellowish to brown.

II. *Sjövall Method.*—Tissue, pieces of which may be fairly large, previously fixed (two days) in a suitable formalin strength (5–20 p.c. ?), then washed from one to two hours in running tap-water, transferred to 2 p.c. OsO₄ in aq. dist. (see that there is enough according to size of piece treated), and left from two to fourteen days, as for Kopsch. Golgi elements, generally mitochondria and always fat, and often yolk, black. (Formalin best neutralized with sodium carbonate.)

III. *Kopsch-Altman.*—Prepare sections by Kopsch, stain as follows in Altmann:—Bring sections to water, stain in acid-fuchsin in aniline water (saturated solution), placing slide on oven or over Bunsen burner till the liquid steams; leave half to two minutes.

Tip off and add a saturated solution of picric acid in water, previously diluted by one-half. Heat and leave as before. Blot, dip into either 90 p.c. or absolute alcohol, and observe differentiation under microscope. Pass to xylol quickly and mount in balsam. Golgi elements black, mitochondria red to purplish, ground cytoplasm yellowish. Rest like Kopsch.

IV. *Champy and Flemming (F. W. A.)*.—Fix small pieces of tissue (circa 3–5 mm. in diameter) from one day to a week in either Champy or Flemming without acetic acid, strong formula. I then find that nine to ten hours in iron-alum, and twelve to twenty hours in hæmatoxylin, gives the most beautiful results. Longer immersion in the watery mordant or stain produces a macerated effect, which however is slight. Champy is excellent for vertebrate tissues, and especially for amphibia. (The acetic acid as added to the fluids of Benda and Meves produces distortion of delicate cell organs.) Mitochondria black; Golgi apparatus, when evident, black.

V. *Mann's Corrosive Osmic*.—Fix tissue from one day to a week in the following solution:—Osmic acid of 1 p.c., 50 parts; corrosive sublimate, saturated solution in normal saline, 50 parts. I then find that iron-hæmatoxylin is the most suitable stain. Ground cytoplasm rarely quite perfect. This method is sometimes successful in demonstrating the Golgi apparatus where other techniques fail. Golgi elements and mitochondria black.

Notes re Kopsch Method.—(a) Never use cork, as it absorbs the osmic vapour and completely disintegrates the solution. (b) The black fluid left, after the lapse of a week or two, may be collected in a bottle; such fluid contains a good deal of osmic acid, and the black matter can be precipitated by adding one or two drops of chromic acid of 1 p.c. The precipitate can be filtered off after a day and the recovered fluid used for laboratory work on fat, etc.

VI. Finally, in attempting to demonstrate the Golgi apparatus in a cell, if other methods have failed, *Cajal's or Golgi's methods* may succeed. I give below the method of Cajal, which I find excellent. (For Golgi, see 10.)

1. Fix small pieces of tissue or organ for from nine to eleven hours:—Uranium nitrate, 1 gm.; formol, 15 c.cm. (commercial will do); distilled water, 100 c.cm.

2. Remove tissue and wash in three changes of distilled water for ten minutes.

3. Transfer to silver-nitrate bath of 1·5 p.c. for about thirty-five hours. Wash as in paragraph 2.

4. Transfer tissues to the following reducing fluid:—Hydroquinone, 2 gm.; formol, 6 c.cm.; distilled water, 100 c.cm. Add anhydrous sodium sulphite, about 0·15–0·25 gm., till the solution has a yellow colour. This solution may go bad after a time. The

tissue is left in the reducing solution till a brown colour appears, generally from one-half to one hour.

5. Pass through upgraded alcohols to xylol and embed in paraffin. Sections on slide are brought into water and toned (if necessary) in the following solution:—

6. *Toning*.—(a) Sodium hyposulphite, 3 grm.; ammonium sulphocyanate, 3 grm.; distilled water, 100 c.cm. (b) Gold chloride, 1 p.c. Use equal parts of (a) and (b). Sections are toned for varying times from about ten minutes to one-half hour, according to the thickness of the sections. Dehydrate, clear and mount.

As far as I can make out from preparations of *Helix* ovotestis made by this method, the image given is generally very faithful, though in other cases it is not limited strictly to the Golgi rod itself, being diffuse, and the individual rods a solid mass.

VII. *Iodine Stain for Glycogen*.—1. Fix tissues in 90–100 p.c. alcohol. Lower strengths must be avoided.

2. Prepare wax or celloidin sections. Stain ten minutes in Ehrlich's hæmatoxylin.

3. Pass sections to 1 p.c. solution of potassium iodide saturated in iodine. Leave three to five minutes.

4. Dehydrate in absolute alcohol saturated in iodine. Blot.

5. Oil of origanum. Differentiate for at least ten minutes, till the general diffuse iodine shade is somewhat extracted.

6. Wash in xylol and mount in xylol balsam. (Oil of origanum balsam has also been used, but this oil eventually destroys the colour.) Such preparations will still show the iodine colour after three years (placenta and liver).

VIII. *Intra-vitam Stains*.—Besides the above methods, fresh cells can be stained alive in neutral red about 1 in 20,000, in tap-water or salt solution, and in Janus green about 1 in 30,000. Both dyes stain the mitochondria clearly, and in male germ cells generally the Golgi (nebenkern) elements as well. These methods are valuable.

IX. *Toxic Stains for Fresh Cells*.—Weak permanganate of potassium (pink solution), one half p.c. OsO_4 , and osmic acid mixed with certain weak dyes, such as methyl-green or dahlia, will kill and stain freshly smeared cells. The mitochondria, and sometimes the Golgi apparatus, may show very clearly.

Sections VIII. and IX. are useful for Protozoa and smears of insect testes. The best results are gained by trying differing strengths till the optimum is obtained.

THE OSMIUM TETROXIDE AND SILVER-NITRATE REACTIONS FOR THE GOLGI APPARATUS.

Kopsch's method turns Golgi batonettes or granules, fat, and often yolk, quite black; but it is easy to distinguish between

the latter and the former by observing the shape and general appearance. As we have seen, the black coloration of the fat and the yolk is traceable to the reduction of the osmium tetroxide by means of one of the oleic fat series; but it is doubtful whether the colour of the Golgi apparatus is due to the same reaction. Ordinary fat blackens in a few hours; the Golgi elements take days to undergo this process. Moreover, Flemming without acetic acid (i.e. chromium trioxide and osmic acid) will turn fat black, while the presence of the chrome salt prevents the Golgi apparatus from going black in the time it would have taken had the chromic acid not been present. For these reasons I am led to consider that the blackening of the Golgi apparatus is at present difficult to explain by the assumption that the elements contain some unsaturated fat. These remarks apply especially to Mollusca. Another fact which must be noticed is that the presence in a tissue of such a reducing substance as formalin may cause the black effect to appear in almost all parts of the cell when osmic acid is subsequently used (Sjövall's method). This fact must be borne in mind by those who would consider that osmic acid is in any way specific for fat.

The silver-nitrate method also presents much the same problem: tissues are fixed in formalin and treated in silver nitrate; some additional reducer is then used, and sections are prepared and toned. The black appearance in the majority of sections is strictly confined to the Golgi apparatus, but in other parts of the section it may have spread to the mitochondria or to the whole cell. This is somewhat like the osmic acid reaction, because by Sjövall's method the tissues are first fixed in formalin and then treated in osmic acid. The black colour can be progressive as with silver nitrate; it may be strictly confined to the Golgi apparatus, or it may have spread to mitochondria and gradually all over the cell. I do not feel able to explain these curious facts, which are so important. It may be pointed out that while Kopsch stains fat black, formol-silver nitrate, while causing Golgi apparatus to become black, does not stain yolk or fat black in successful preparations.

CYTOLOGICAL METHODS OF THE FUTURE.

It is not easy to forecast the future of a branch of Zoology such as Cytology, but one cannot read the papers by Cajal's school, published in the "Trabajos del Laboratorio de Universidad de Madrid," without feeling that the formol metallic methods (gold and silver) have a great future before them. The chrome-osmium tetroxide fixatives are at present giving the most fruitful results, but neither metallic impregnations nor chrome-osmium preparations will take cytologists much farther without great improvements in the manufacture of microscope lenses.

It is evident that the silver-nitrate reduction methods, not only for the Golgi apparatus, but also for neuroglia and dendrites, are extremely capricious, and care must be taken in interpreting the images by these methods. The future training of zoologists will not be complete unless they are taught one of the Golgi apparatus methods of Golgi or Cajal, for the application of these methods to germ cells has lately been giving very interesting results. The Spanish observer Rio-Hortega, in a recent paper on the nuclei of cells of the ovary and involuntary muscle of a mammal, describes an enigmatic body which cannot be demonstrated by other methods. This new nuclear body Rio-Hortega describes as a "nuclein filament"; it consists of a long filament or rod twisted up inside the nucleus, and it is evidently separate from the chromatin of the nucleus. Rio-Hortega does not describe the behaviour of this body during mitosis. Achúcarro, another of Ramon y Cajal's pupils, describes a new silver method for demonstrating neuroglia fibres; this new method gives remarkably reliable results, and has been used in my laboratory with success. I believe that this method, primarily invented and used by a neurohistologist, would give useful results were it applied to "zoological material."

I consider that after the various granules in the cell have been exhaustively examined by silver and chrome-osmium techniques, no further progress will be made in descriptive cytology unless some new methods are introduced which will enable us to face the problems before us from a different point. This especially applies to the cytological basis of the questions of heredity. Should no revolutionary cytological methods appear it would seem that descriptive cytology will in the next few decades pass to the position of present-day "Comparative Anatomy."

FIXATIVES.

For some years I have been working with a variety of fixatives and methods, and give here some part of my new results. Fixation falls under three broad headings:—

1. *Micro-anatomical*, in which correct preservation of cell aggregates, without shrinkage or expanding, is the desideratum. Such is the aim of most embryologists.

2. *Cytological from the chromosome* or nucleus point of view.

3. *Cytological* from the point of view of fixing the cell in a state which most resembles its condition when alive; also so as to identify the cell elements, especially in the cytoplasm.

Only the last section (No. 3) is treated here, as the other two are not a matter of difficulty. In most cases the results attained by workers belonging to sections 1 and 2 can truly be said to give a caricature of the cell *intra vitam*. I give below a general classification of fixatives based mainly on the sections explained above,

those in (a) being fixatives causing the maximum disturbance and destruction in the cell, those in (c) the least.

(a) Carnoy, Petrunkevitch, alcohol, Gilson, picro-nitric, etc.

Fat, mitochondria, Golgi apparatus, and often early yolk discs do not show after these. (Using alcohols and xylol subsequently.)

(b) Bouin, Zenker, corrosive acetic, Flemming-with-acetic acid, etc.

Mitochondria and Golgi apparatus rarely show after these, except possibly in mammals, where these cell inclusions are more resistant than in invertebrata.

(c) Osmic acid, Flemming-without-acetic, Champy, Altmann, formalin, Mann's mercury-osmic liquid, Sjövall's method, etc. Preserve everything (except glycogen?) (Using fluids subsequently as above.)

In section (c) the formol alone will not preserve fat; but see Sjövall's method above.

The fixatives have not been classed according to how they themselves alone affect the contents of the cell, but according to how they preserve the cell preparatory to its treatment in the liquids necessary for embedding and sectioning.

Injurious liquids which should never be used in fixation are acetic acid, chloroform and alcohol. Acetic acid is certainly most destructive to delicate lipins, and its use, except where chromosomes are being studied, is rarely indicated; any worker who uses acetic acid in his fixing mixtures cannot hope to get a correct picture of any part of his cell, possibly excepting the chromosomes (not the resting nucleus). The most valuable fixatives are osmium-tetroxide, chromium-trioxide, bichromate of potassium, and formaldehyde, in the order named. The most valuable mixtures are Müller-formol, Flemming-without-acetic, Altmann, and Champy; the three latter approach as near perfection as present-day technique allows. Altmann's fluid ($K_2Cr_2O_7 + OsO_4$) I find to be a splendid mixture. In no case, except in small invertebrates, do these fixatives (excluding formol) give a true fixation of cell aggregates; this is due to their inferior penetrating powers, and to an unevenness of penetration. Small invertebrates, both marine and fresh-water, and small pieces of tissue, are usually exquisitely preserved in chrome-osmium mixtures, but are not then generally suitable for staining and mounting whole, especially for staining in carmine mixtures.

STAINS

Staining methods, which are now being used with conspicuous success on problems connected with the finer structure of the cell, are as follows:—Iron-hæmatoxylin, Altmann's acid fuchsin and picric acid, Benda's alizarin and crystal-violet (?), Kopsch (OsO_4)

followed by Altmann's stain, or alone, and some of the silver nitrate or gold chloride methods which seem to give true stains. All these methods (excluding the last) are extremely intense and suitable for use after fixation in chrome-osmium mixtures, which necessitate a stain which will "bite in." In every case the above-mentioned stains are best used only after constant practice. Lately certain workers (including myself) have been getting beautiful results by fixing in chrome-osmium, staining intensely in dense hæmatoxylin such as that of Benda or Heidenhain, or Mallory (2), then under-differentiating, and subsequently staining in Altmann's acid fuchsin and picric acid. The latter differentiates the sections to the correct stage. I have also got remarkable results by fixing in chrome-osmium, staining in a black hæmatoxylin, and counter-staining in acid fuchsin-picric acid (Van Gieson).

The widely published statement that Altmann's acid fuchsin picric acid produces granules (precipitate) in cells, and that Altmann's granules are artefacts, is absolutely false. Altmann's method merely stains very efficiently bodies which can be seen in the fresh cell. Fischer's (19) critique is incorrect, and is due to his ignorance of cytology.

ON THE CHEMICAL CONSTITUTION OF MITOCHONDRIA AND GOLGI APPARATUS.

Both Golgi apparatus and mitochondria I believe to consist of a substratum of living protoplasm denser than the surrounding medium in which they lie. In the first place, therefore, I consider that an inquiry into the structure of these cell organs is an inquiry also into the structure of living protoplasm. Besides the basic protoplasmic part of both mitochondria and Golgi apparatus, there are other substances present associated with the basic protoplasm. It is such associated matter which focuses our attention on these cell organs and enables us to fix and stain them specifically. I believe that the well-known changes in fixing and staining affinities undergone by these cell organs are caused by the varying qualities, and even absence and presence, of the associated substances of mitochondrium or Golgi rod. Fauré-Fremiet (25) describes how he extracted a lipin or phosphatide from desiccated *Ascaris* ovaries, and has given some account of its properties. In the first place I am not satisfied that Fauré-Fremiet has extracted the lipin from the mitochondria alone, for in *Ascaris* one gets two sorts of yolk and numerous Golgi rods, all of which might, and probably did, contribute towards Fauré-Fremiet's extract. Before the latter observer can produce evidence of a satisfactory nature he must remove his mitochondria by some method whereby contact with yolk and Golgi rods is avoided. According to Fauré-Fremiet

his extracted body is hardly soluble in warm absolute alcohol or chloroform; it is insoluble in acetone, absolute ether or mixtures of alcohol and ether; with aq. dist. it forms an ultramicroscopic emulsion, and has no action on polarized light. Chromic acid and bichromate of potash transform the lipin into an insoluble product. Osmic acid is reduced by it very slowly, even at a temperature of 60° C. It should not be considered that tests of which the above is a specimen apply to the cell *intra vitam* during the process of fixing, because Carnoy's fluid, which is a mixture of alcohol absolute, acetic acid and chloroform, will be found to sweep everything out of the cytoplasm of the *Ascaris* ovum. This of course need not vitiate the truth of Fauré-Fremiet's experiments *in vitro*; but it must be remembered that such *in vitro* experiments do not shed much light on the problems we have before us, and often do not agree with the evidence of the microscope. It seems certain that the Golgi rods contain small quantities of some fatty substance which, judging from the OsO_4 test (Kopsch), might be olein, but this test is very meagre evidence. By fixing a tissue first in formalin and subsequently treating in OsO_4 (Sjövall) it is often possible to blacken the mitochondria, the formalin having the effect of assisting the reduction of the OsO_4 , though OsO_4 by itself very rarely blackens the mitochondria; the mitochondria in the larger oocytes in the frog ovary go black in Kopsch (OsO_4).

While the Golgi apparatus and the mitochondria closely resemble each other in the fact that both have as their basis a substratum of protoplasm, the associated "fatty" or lipin substances also in each are often very closely similar in chemical nature, though I have never found that they were quite similar. The formol or chrome fixation followed by iron-haematoxylin as a stain seems to bring both mitochondria and Golgi rods into evidence by the fact that the formol or chrome fixes and makes stainable the protoplasmic basis. Possibly it is the albuminous part also which impregnates in Golgi or Cajal's method. On the other hand, Kopsch's method and Sjövall's method (OsO_4) appear to depend on the presence of some associated "fatty" substance in either the Golgi rod or mitochondrium, and the former contains more of this "fatty" substance than the latter.

In his recent monograph dealing with "Lecithin and Allied Substances" Maclean (3) says of the function of lipins, which are found in all parts of the body, "A perusal of the results of the work undertaken to elucidate the biological significance of the lipins justifies the assertion, that so far the special part played by the lipins in the activity of the organism is entirely unknown to us." This is a modern bio-chemist's view; it may be unduly pessimistic, but it illustrates the fact that our knowledge of the connexion between these substances and the vital phenomena of the cell is still a blank. Possibly a more complete liaison between

workers of Maclean's type and the cytologist may produce happier results. Maclean does not mention anything of the literature on the mitochondria.

GENERAL SUMMARY.

There is some considerable difficulty in distinguishing several categories of cell elements. The Golgi apparatus, mitochondria, yolk, and fat are, or contain, substances often identical and generally chemically allied. For this reason great care must be exercised in any attempt to identify a given cell body, and it is clearly recognized that the mixture of two or more of the above-mentioned elements may lead to confusion. The characteristics of the various elements of the cell, which the zoologist meets, and the manner in which they may be distinguished, has been indicated in tabular form. It is hoped that these Tables will prove useful to embryologists and others who might wish to ascertain the nature of any enigmatic cell body under their notice. Finally, it may be pointed out that such Tables can only be made inclusive and perfectly efficient after criticism and trials by other workers, and I would welcome any suggestions of this kind.

BIBLIOGRAPHY.

(For a fuller list see the papers of Pappenheimer, Duesberg, Gatenby, and Hirschler.)

1. MANN, G.—Physiological Histology. Oxford.
2. BOLLES LEE.—The Microtome's Vademecum.
3. LEATHES, MACLEAN, PLIMMER, etc.—Monographs on Bio-chemistry.
4. BEST.—(Glycogen Staining.) *Zeit. wiss. Zool.* xxiii. p. 319.
5. GOLGI, C.—Intorno alla struttura delle cellule nervose. *Bol. del Soc. Med.-Chir. di Pavia* (1878).
— Di un metodo per la facile e pronta dimostrazione dell' apparato reticolare interno delle cellule nervose. *Ibid* (1908).
6. HIRSCHLER, JAN.—Über die Plasmakomponenten des weiblichen Geschlechtszellen. *Arch. Mikr. Anat.*, Bd. 89, Heft 1.
7. JENKINSON, J. W.—Vertebrate Embryology. Oxford, 1913.
8. KOPSCH, F.—Die Darstellung des Binnennetzes in spinalen Ganglienzellen und anderen Körperzellen mittelst Osmiumsäure. *Sitzungsber. d.k. preuss. Akad. d. Wiss. zu Berlin*.
9. MEVES, F.—Die Spermatocytenteilungen bei der Honigbiene. *Arch. f. mikr. Anat.*, Bd. 70.
- + 10. PAPPENHEIMER, A. M.—The Golgi Apparatus: Personal Observations and a Review of the Literature. *Anat. Record*, ii. No. 4 (1916).
11. GRANATA.—I mitochondria nelle cellule seminali maschili di *Pamphagus marmoratus*. *Biologica*, ii. No. 4.
12. TERNI TUL.—Condriosomi, idiozoma, e formazioni periidiozomiche nella spermatogenesi degli Anfibia. *Arch. f. Zellforsch.*, Bd. xii. 14.
13. CHAMPY, CH.—Recherches sur l'absorption intestinale et le rôle des mitochondries dans l'absorption et la sécrétion. *Arch. d'Anat. Micr.*, xiii. (1911-12).

14. COWDRY, E. V.—Relations of Mitochondria and other Cytoplasmic Constituents in Spinal Ganglion Cells of Pigeon. *Internat. Monats. f. Anat. u. Phys.* Bd. xxix.
15. DUESBERG, J.—Plastosomen. "Apparato reticolare interno" und Chromidialapparat. *Ergeb. d. Anat. u. Entwl.*, Bd. xx. (1911). E. Hälfte.
16. FAURÉ-FREMIET.—Étude sur les mitochondries des Protozoaires et des cellules sexuelles. *Arch. d'Anat. Micr.*, xi.
17. GATENBY, J. BRONTÉ.—Various papers in the *Quart. Journ. Micr. Sci.*, 1914-19.
18. CAJAL, RAMON Y.—Various papers, especially in later numbers of the "Trabajos del Laboratorio de Universidad de Madrid."
19. FISCHER, A.—Fixirung, Färbung und Bau des Protoplasmas. Jena.
20. HIRSCHLER.—Über Plasmastrukturen (Golgi'sche Apparat u. A.) in den Tunikaten, Spongien und Protozoenzellen. *Anat. Anz.*, xlvii. 289.
21. WEIGL.—Vergleichende-zytologische Untersuchungen über den Golgi-Kopsch'en Apparat u. A. *Bull. Acad. Sc. Cracovie*, 417 (1912).
22. PERRONCITO.—Contribution à l'étude de la biologie cellulaire. Le phénomène de la dictyokinèse. *Arch. Ital. de Biol.*, liv. (1910).
23. DEINECKA.—Das Netzapparat von Golgi in einigen Epilhel-u. Bindegewebszellen. *Anat. Anz.*, xli. (1912).
24. CASTEEL.—Germ Cells of Argas. *Journ. Morph.* (1915-16).
25. FAURÉ-FREMIET.—Le Cycle germinatif chez l'Ascaris. *Arch d'Anat. Micr.* xv. (1913).
26. SJÖVALL.—Über Spinalganglienzellen und Markscheiden. Zugleich ein Versuch, die Wirkungsweise der Osmiumsäure zu analysieren. *Anat. Hefte*, Bd. 30 (1906).
27. WILSON, E. B.—Distribution of the Chondriosomes to the Spermatozoa of Scorpions. *Nat. Acad. Sci. Philadelphia* (1914). See also (17).
28. RIO-HORTEGA, P. DEL.—Un nuevo método de investigación histológica e histopatológica. *Boletin Soc. Espan. Biol.*, No. 35 (1918).
29. ——— Noticia de un nuevo y fácil método para la coloración de la neuroglia y del tejido conjuntivo. *Trab. Labor. Biol. Madrid*, Tome xv. (1918).
30. ——— Sobre la fina textura del cartilago de los cefalópodos. *Boletin Soc. Españ, Biol.*, No. 36 (1918).
31. Détails nouveaux sur la structure de l'ovaire. *Trab. Labor. Invest. Biol. Madrid*, Tome xi. (1913).

IV.—*A Method of Adjusting Tube Length.*

By H. HARTRIDGE, M.A., M.D., F.R.M.S., Fellow of King's College, Cambs.

(Read December 18, 1918.)

ONE DIAGRAM.

BESIDE the method of adjusting tube length which has been completely described by Ainslie (1),* there is, I have found, another technique which has certain advantages. This may be described as follows:—With the microscope set up in the ordinary way, and with the condenser correctly centred, a slit-shaped aperture cut in suitable material (cardboard, sheet metal, etc.) is mounted beneath the condenser in such a way that the slit may be caused to travel at right angles to its long axis. In this way the beam of light is caused to traverse different parts of the condenser aperture. (See diagram.)

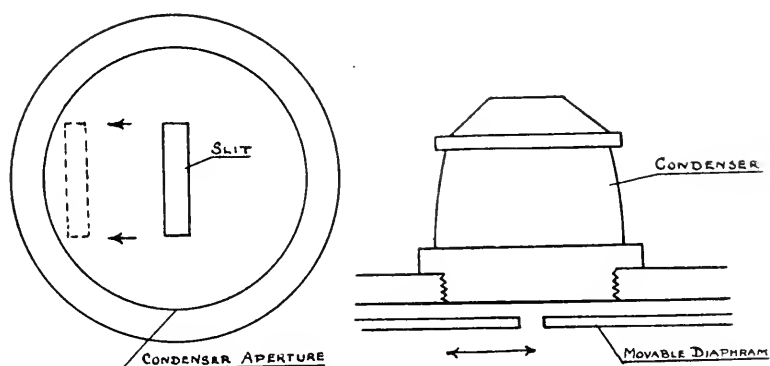

Diagram showing position and direction of motion of slit in relationship to the aperture of the substage condenser.

The eye-piece to be employed is fitted with a pointer, the end of which is near the centre of the field. (For the pointer a stiff hair or bristle will be found suitable.) The eye-piece being placed in the draw tube, the edge of some conspicuous part of the specimen is brought close to the end of the pointer.

* The italic figure within brackets refers to the Bibliography at end of the paper.

[If subsequently it is found necessary to employ a different eye-piece, then it must either be parfocal with the one for which the tube length has been corrected or suitable readjustment of tube length effected. This may be easily carried out if, after changing the eye-pieces, the focus is restored, *not* by touching the fine-adjustment but by moving the draw tube. For this purpose a rack-work draw tube is an advantage, but is not essential. Small tight-fitting rings of brass of the correct width may be used for rendering ordinary or compensated eye-pieces parfocal. This of course cannot be done in the case of holoscopic eye-pieces because the focal plane shifts with the adjustment of compensation.] The microscope is now focused with the pointer corresponding to some suitable part of the slide. In the case of histological or bacteriological specimens no difficulty is encountered, because almost any outstanding feature may be employed. In the case of diatoms a different procedure will be necessary, because the structure to be examined may not be resolved when the slit is placed beneath the condenser because of the small illuminating cone. If coarse structure, such as a mid-rib or a broken edge or even dust particles, lie in the same plane as the structure to be resolved, they may be used for the purpose of tube-length adjustment.

The image of some suitable portion of the object having been caused to correspond with the end of the eye-piece pointer, the image is carefully focused with the slit in the centre of the aperture of the condenser. The slit is now moved from side to side across the back of the condenser, and the image carefully watched. In general the image will be found to move either in the same or in the opposite direction of the slit. If in the same direction, the tube length is too short, and *vice versa*.

If the microscope possesses a mechanical draw tube, the correct adjustment is very quickly made, for it is then found that with a good objective the image is practically stationary. In fact, in my opinion, the better the objective the more definitely and rapidly can the adjustment be made. Now, in a poor objective it may be found that under no conditions will the image remain stationary: for example, as the slit is moved from the centre outwards, the image may be found to move first against the motion of the slit, then back to its old position, and then over to the other side. This shows that (for this setting of the draw tube) there is over-correction of the $\frac{1}{4}$ -zone, correct correction of the $\frac{1}{2}$ -zone, and under-correction of the $\frac{3}{4}$ -zone. A longer setting of the tube will give increased movement and therefore increased over-correction of the $\frac{1}{4}$ -zone, over-correction in the $\frac{1}{2}$ -zone, and correction in the $\frac{3}{4}$ -zone. A shorter tube corrects the $\frac{1}{4}$ -zone at the expense of $\frac{1}{2}$ and $\frac{3}{4}$. It is thus impossible by adjusting tube length to eliminate the spherical aberration. Much good work can be done even with such an

objective if the most is made of this method. For example, to resolve Pleurosigma the zones, roughly, 0.3 N.A. on either side of the central zone are used. If the central zone and these zones be adjusted to be in spherical correction, then to a certain extent the corrections of the other zones do not matter.

This is the adjustment at which coarse and fine details are found to focus approximately together in the same plane. Most objectives show some spherical error in the outer zones. This may be ignored when using the method for correcting tube length, if a $\frac{3}{4}$ -zone of illumination is to be employed, and if the object is not of such a nature that the outer zones are illuminated by diffracted or refracted light. Consideration shows that the principal advantage of this technique over other methods is that by it the different zones of the objective are separately investigated, and therefore more information is obtained than by previous methods in which the objective is treated as a whole.

The adjustment of tube length rapidly becomes automatic in practice: "motion of image with the slit" equals "plus" equals "a longer tube"; "motion against the slit" equals "minus" equals "a shorter tube." This method is found to be of wide application, and is at present being more fully worked out for making complete measurements of the optical performance of objectives.

THE APPLICATION OF THE METHOD TO THE SUBSTAGE CONDENSER.

This method is also found to be very useful for adjusting the distance between the illuminant and the substage condenser in order to eliminate spherical aberration. In my opinion it has advantages for this purpose over previous methods. The technique may be briefly described as follows:—The same slit-shaped aperture is mounted beneath the condenser as previously described for the method of adjusting tube length. The objective to be used is now focused on the slide and the condenser adjusted so that the image of the illuminant is centred and roughly in focus. The card is placed beneath the condenser mounting so that the slit is roughly central with the optical axis. (This is readily done by slipping out the eye-piece and looking down the tube.) The condenser is now carefully focused so that the image of the illuminant is in the same plane as the slide. The card is now shifted so that the slit travels at right angles to its long axis, and the image of the illuminant carefully watched. In general the image will be seen to move either in the same or in the opposite direction to the slit. The movement of the image of the illuminant is of course judged in reference to some prominent feature on the slide, in

order to eliminate any additional movement due to error in correction of the objective. If the image of the illuminant moves in the same direction as the slit, it signifies under-correction, and a more distant light source is therefore required; if the opposite direction, over-correction is present and the light source should be nearer. The rule is therefore the same as that found for an objective: "Movement with" equals "plus" equals "a greater distance is required;" "movement against" equals "minus" equals "nearer light source should be used."

THE THEORY OF THE METHOD.

The basis of this method of adjusting tube length may be of interest, and is therefore briefly described as follows:—

In the case where the tube length has been properly adjusted spherical aberration is eliminated, and therefore rays starting from the point where the optic axis meets the specimen all meet at a point again on the axis. Therefore, as different objective zones are exposed the image remains stationary.

If the tube length is too short, then, as is well known, the outer rays focus closer to the objective than the inner rays—that is to say, rays from the outer zones of the objective have met one another to form a focus, and have then crossed over to the opposite side before the plane of the focus for the more central rays is reached. Those from the left-hand edge of the objective aperture will therefore be found on the right, and *vice versa*. Now, the left-hand edge of the objective aperture is exposed when the slit beneath the condenser is to the right, and therefore when the slit is on the right the image is also on the right, and *vice versa*; in other words, the image moves in the same direction as the slit.

If the tube length is too long, then the central rays form a focus before the outer rays have done so. At the plane of the focus of the central rays, therefore, the outer rays have not yet met—that is, the rays from the right-hand edge of the objective aperture are still on the right, and those from the left on the left. Since, as before, the right-hand edge of the objective aperture is exposed when the slit below the condenser is to the left, the image is on the right when the slit is on the left, and *vice versa*, and the motion of the image is therefore in opposition to that of the slit.

RELATIVE ADVANTAGES OF DIFFERENT METHODS.

- The three alternative methods are:—1. Trial and error method.
2. Ainslie's method. 3. Author's method.

1. The trial and error method suffers from the disadvantages

that the point of correct adjustment is indefinite, and the personal equation very great.

2. The method employing similarity of images above and below focus (Ainslie's method) applies a definite criterion; the personal equation is therefore relatively small. It can be applied in almost all cases met with in practice, and is of special value for work on Diatoms. It requires no apparatus other than a good fine-adjustment. The information given concerns the adjustment of tube length only; little or no inference can be drawn as to the correction of the zones of the lens system of different N.A.

3. Method employing movement of image with alteration of zone (Author's method) employs a very definite test, and therefore has the advantage of a low personal equation. It requires special apparatus; this is however of a simple nature. It can be used for investigating the correction of the different zones of an objective or condenser, and it is this property which gives the method its principle advantage. For this purpose the Abbe test plate forms the best object. Difficulties may be encountered when the method is used on Diatoms. With ordinary slides of an histological or bacteriological nature this does not occur.

This method has been elaborated in order to give data of the convection of different zones of microscopic objectives. Details of the technique will be described in a future paper.

REFERENCE.

1. AINSLIE.—Photomicro. Soc., 1916, p. 23.

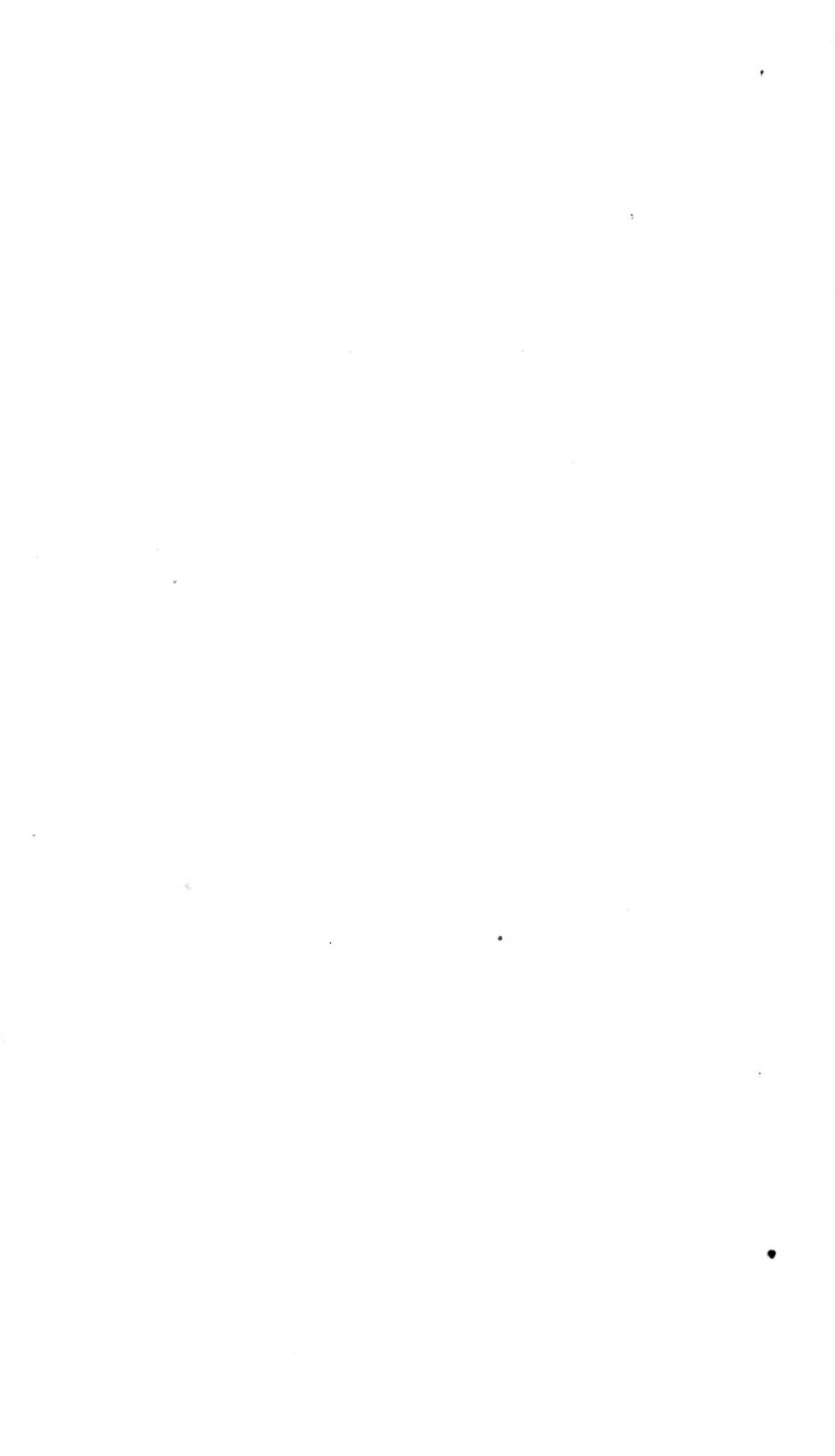

V.—*A Standard Microscope.*

By LIEUT.-COL. J. CLIBBORN, C.I.E., B.A., F.R.M.S.

Read March 19, 1919.

I AM somewhat diffident of my ability to place before the Council and Fellows of this Society a proposition which appears not only appropriate but urgent at the present time—namely, to draw the attention of this Royal Microscopical Society to what may justly be termed both a privilege and a duty. My proposition is that this Society should at once take measures to design and specify the British Standard Microscope.

It seems almost unnecessary to give reasons in support of this proposal; the Government and the trade of this country are pressing strongly for invention, design, and standards to prevent the alien from overwhelming British manufacture, and it would be difficult to find a case in which this regrettable result is more likely to occur than that of the microscope, unless proper measures are taken at once.

It may be suggested this duty is to the manufacturers, and not to this Society; but a little consideration will show that the duty of the trade is to manufacture well and economically and not to research. For the latter the trade rarely has either the methods, the funds, or the leisure, nor is there ready to hand the scientific knowledge, talent, and experience available in the Fellows of this Society, who collectively constitute the proper authority to seal the result of their deliberations as a standard for the Empire.

As a matter of business detail, it need hardly be said that the selection of a particular firm in the trade as the producer of the standard would not conduce to commercial amiability, nor would a co-operative arrangement be practicable or likely to produce the result desired.

It thus appears evident that this national work falls naturally to the Society, and I trust those Fellows, whose knowledge and experience in this matter we all admire and respect, will support the suggestion, and that the Society will take the matter up with vigour, and with a determination to spare no effort to place this country ahead of all rivals in microscope efficiency and production.

I have looked through many catalogues, both home and foreign, in the endeavour to trace some leading idea in the designs offered; there may be such, but, if so, it is camouflaged to all but experts. It however appears evident that a monocular microscope stand

can be designed which will fulfil all the obligations of medical, biological, petrological, metallurgical, and chemical science, and be adapted for photo-micrographical work.

That certain difficulties have to be overcome is undeniable, but none of these appears likely to be insuperable. It would be presumptuous on my part to enter into the details involved in my proposal, but perhaps I may be allowed a few suggestions derived from my experience in manufacture generally, as these may possibly conduce to economy in construction, if nothing else.

That the stand be designed not as a concrete whole, but so as to admit of successive additions of other standard parts as required.

That it should be recognized that the optical parts of the microscope cannot be standardized except as regards their parts fitting to the stand.

That all fittings, other than optical, be standardized.

That each part of the microscope be made of the material best suited to the strains and wear it has to undergo.

That the design should aim at simplicity, a balance of the moving body in all positions, perfect rigidity, uniformity of movement round the arc traversed by the moving body, and artistic finish. It should not require clamping, which is likely to disturb adjustments, and must to some extent distort a delicate instrument.

The manufacture should be carried out by precision tools and precision grinding to limit-gauges, so that all the parts of all instruments will be interchangeable.

Regarding rigidity and materials, it may be noted that brass, the material usually employed heretofore, has a tensile of from 12·5 to 21 tons per square inch, and elongation of from 28–65 p.c., while aluminium-bronze and rubel-bronze have tensiles of 43 tons, with only 12·5 p.c. elongation; these bronzes appear more suitable material for the stand than brass to secure rigidity.

A little book, "Metals and Alloys," published in 1918 by the Metal Industry, 33 Bedford Street, Strand, gives information regarding some 500 metals and alloys, which may be found useful. Attention may also be called to die-casting, which, though more expensive than ordinary brass-founding, produces castings in unlimited number of identical form, of a close texture, and requiring little or no machining. There are several firms in London die-casting, and if in time this method can be applied to hard material, it is certain that its introduction to microscope manufacture would conduce materially both to standardization and economy.

In conclusion, I may remark that you cannot manufacture unless you have standards, but you cannot have standards unless you use precise methods and tools, and that you cannot have a really good instrument at a reasonable price unless you manufacture.

SUMMARY OF CURRENT RESEARCHES

RELATING TO

ZOOLOGY AND BOTANY

(PRINCIPALLY INVERTEBRATA AND CRYPTOGAMIA),

MICROSCOPY ETC.*

ZOOLOGY.

VERTEBRATA.

*a. Embryology, Evolution, Heredity, Reproduction,
and Allied Subjects.*

Inbreeding and Sex-Ratio in Albino Rats.—HELEN DEAN KING (*Journ. Exper. Zool.*, 1918, **27**, 1-35, 1 fig.). The normal sex-ratio in the stock experimented with was 105 males to 100 females. In inbreeding without selection there was in six generations little change. In inbreeding further with females from litters with an excess of males the ratio rose above the norm, except in the tenth generation. In the eleventh generation it was 145 males to 100 females. The first twenty-five generations of this series comprised 1752 litters, with 13,116 individuals, 7116 males and 6000 females, the total ratio being 117 males to 100 females, 12 points above the norm. In this series the breeding females were selected from litters containing an excess of males. In a second series, where the breeding females were taken from litters containing an excess of females, the deviation from the norm was in the reverse direction; for the entire group of 794 litters the sex-ratio was 82 males to 100 females, 23 points below the norm. Through selection the inbred strain was thus separated into distinct lines, and it will be seen that selection had the greater influence on the female line. The experiments seem to indicate that the female has more influence in determining the sex-ratio than has the male. "Yet it is not in the differentiation of the ova, nor in the development of the spermatozoa, that the key to the riddle of sex-determination will be found. A knowledge of the interaction of the germ-cells, and of the conditions that influence it, must be gained before the final solution of this problem can be attained."

J. A. T.

* The Society does not hold itself responsible for the views of the authors of the papers abstracted. The object of this part of the Journal is to present a summary of the papers *as actually published*, and to describe and illustrate Instruments, Apparatus, etc., which are either new or have not been previously described in this country.

Inbreeding and Body Weight in Albino Rats.—HELEN DEAN KING (*Journ. Exper. Zool.*, 1918, **26**, 1-54, 14 charts). The general course of the growth in body weight of inbred rats is similar to that of stock animals. For the first six generations there was malnutrition, and the body weights were under the normal. Many had defective teeth, and the majority of the females were sterile. When nutritive conditions were improved the animals quickly regained their normal body size, and the tendency to sterility and malformation was checked. J. A. T.

Inbreeding and Fertility in Albino Rats.—HELEN DEAN KING (*Journ. Exper. Zool.*, 1918, **26**, 335-78, 2 charts). Two series of albino rats were inbred, brother and sister, for twenty-five generations. The two series combined comprise a total of 3408 litters, which contained 25,452 individuals. The inbreeding did not decrease the productiveness. The constitutional vigour did not seem to be impaired. The span of life in both sexes was increased. The results obtained do not accord with the general view regarding the effects of inbreeding, since they indicate that inbreeding *per se* is not necessarily inimical either to fertility or to vigour. Success or failure in any series of inbreeding experiments would seem to depend on the character of the stock that is inbred, on the manner in which breeding animals are selected, and on the environmental conditions under which the animals are reared.

J. A. T.

Feeding Sudan to Young Albino Rats.—S. HATAI (*Journ. Exper. Zool.*, 1918, **26**, 101-117, 3 charts). Albino rats, 27 to 33 days old, were fed with Sudan III. mixed in olive oil. In all cases the normal rate of growth was retarded to a considerable extent. Liver and pancreas show a steady increase in weight; the thymus, testes and ovaries show a striking diminution. There was a high degree of anaemia. The composition of the organs is more or less altered, there is an increase of water content in the blood, lungs and pancreas, while a reduction occurs in the liver, spleen, kidneys, heart and brain. In the last the reduction is small, but quite uniform, and in every specimen.

J. A. T.

Suckling and Rate of Embryonic Development in Mice.—W. B. KIRKHAM (*Journ. Exper. Zool.*, 1918, **27**, 49-55). In mice simultaneously suckling and pregnant, the removal of all but one of the suckling young at any time during the first six days after the birth of the suckling litter leads in some instances to implantation of the embryos as soon as they reach the uterus, but in other cases the implantation is more or less delayed. If the same removal takes place at any time from seven to fourteen days after the birth of the suckling litter the result is delayed implantation. The full activity of the mammary glands seems to be the chief cause of delayed implantation in the case of mice which are suckling young, but this influence is subject to marked individual variation.

J. A. T.

Effect of Alcohol on Guinea-pigs.—CHARLES R. STOCKARD and GEORGE N. PAPANICOLAOU (*Journ. Exper. Zool.*, 1918, **26**, 119-226, 9 tables, 9 figs.). This communication presents the results obtained

during the sixth and seventh years of an experiment on the modification of mammalian germ cells by the treatment of parental generations with alcohol. In general it may be stated that the offspring produced when treated males were paired with normal females were inferior in several respects as compared with other offspring from the same normal mothers bred to control males of exactly the same original stock. Further, when the male offspring from treated fathers were mated with normal females, the individuals resulting from such matings were as a group decidedly inferior to the young produced by normal females when mated with control males. This group inferiority was present not only in the grandchildren but in the next generation as well. In general terms, an experimental treatment may act upon the germ cells of an animal so as to modify them. They are changed in some way which lowers their ability to react normally in combination with germ cells from another individual. Thus zygotes are produced which tend to develop abnormally, grow slowly, or die during early stages. The subnormal condition may be continued through a number of generations beyond the animals directly treated.

J. A. T.

Amnion-Formation in a Bat.—A. CELESTINO DA COSTA (*C.R. Soc. Biol. Paris*, 1919, **82**, 588-90). In one of the Microchiroptera, *Miniopterus schreibersii*, there is a hollowing out of the embryonic disc to form a closed, relatively large cavity, comparable to the primitive amniotic sac in *Pteropus* and other forms. At this stage the developing egg is a vesicle with a trophoblast wall, containing two other vesicles. One is hollowed out in the ectoderm of the embryonic disc. The other, much the larger, is the endodermic or umbilical vesicle, its wall being the primary endoderm. The ectodermic cavity is quite distinct from the subsequent tropho-ectoblastic cavity. Later on the amniotic folds form the definitive amnion.

J. A. T.

Amnion Formation in Mammals.—A. CELESTINO DA COSTA (*C.R. Soc. Biol. Paris*, 1919, **82**, 604-5). As van Beneden indicated, there is in some cases a primordial amniotic cavity formed within the embryonic disc, preceding the tropho-ectoblastic space, just as that precedes the definitive cavity delimited by the amniotic folds. This is seen in *Miniopterus*, *Rhinolophus*, *Sus*, and some other types. But in some other cases—e.g. hedgehog, mole, rabbit, carnivores—the primordial amniotic cavity is rudimentary or absent, and the amnion is formed from folds. Or, thirdly, the amnion may be formed by excavation of the embryonic disc and histological differentiation of the walls of the primordial cavity, which persists. This is seen in Primates, *Galeopithecus*, *Pteropus*, guinea-pig, and some other forms.

J. A. T.

Effect of Cytolysins on Embryos.—M. F. GUYER and E. A. SMITH (*Journ. Exper. Zool.*, 1918, **26**, 65-82). Lens tissue of rabbits and mice injected into fowls excites the production of specific anti-bodies. If the serum, sensitized by the presence of these, be injected into pregnant rabbits, the anti-bodies may attack the lenses of the unborn young. The reaction is not invariable, however, since a majority of even all of the individuals of a litter may not be acted upon, or a given

individual embryo may be affected in only one eye. This is difficult to explain. The liquefactions that occur indicate a true cytolytic effect. Of the several proteins composing the lens, one is fibrous, and it is upon this that the sensitized serum seems to operate. No effect was observed in the mother, which may be due to the meagre circulation in the adult lens. The fact of chief interest is that visible specific structural modifications can be engendered in the young *in utero* by means of specifically sensitized serum.

J. A. T.

Female Reproductive System in some Falcons.—MAX KOLLMAN (*Bull. Soc. Zool. France*, 1919, **44**, 43-52, 3 figs.). In six cases (four of *Accipiter nisus*, and one of *Astur palumbarius* and *Tinnunculus tinnunculus*) paired ovaries were found; and two persistent Wolffian ducts were found in two cases. A duck observed by Chappellier had two ovaries and two oviducts, and sometimes laid two eggs in a day. In the cases described by Kollman the right oviduct remained vestigial, which is puzzling. In most birds a ventral sagittal partition divides the abdominal cavity into two distinct compartments.

J. A. T.

Hybrids Between Fundulus and Mackerel.—H. H. NEWMAN (*Journ. Exper. Zool.*, 1918, **26**, 391-421, 4 figs.). Crosses have been effected between *Fundulus heteroclitus* ♀ and *Scomber scombrus* ♂. The former has red chromatophores and the latter green ones; the former has solid black chromatophores and the latter delicately branched ones. In proportion as the paternal element (indicated by the mackerel chromatophores) vigorously finds expression, in like proportion is development retarded and various types of monster appear. The most successful embryos are, in so far as the chromatophores are concerned, pure maternal. The great majority of the hybrids are subnormal, especially in their apical structures (eyes, hearts, etc.), and at the same time show obvious paternal inheritance. A somewhat smaller group of hybrid embryos show large apical parts and reduced basal parts; such embryos are usually pure maternal as to chromatophores, or at least in the region of differentiation. Such anomalies are to be interpreted as differential recovery products. The capacity of apical structures for recovery is greater than that in basal structures. Thus there may be heads differentiated without bodies, or with at best rudimentary bodies, and occasionally isolated eyes and hearts. It seems, then, that in heterogenic crosses no harmonious structural differentiation can result unless there be neutralization or elimination of the disharmonious parental (in this case paternal) materials. If the latter function actively in the development, there can result only retarded and subnormal embryos and larvæ, and the vast majority of the hybrids in this case were of this type.

J. A. T.

b. Histology.

Epithelial Movement in Tissue Culture.—SHINICHI MATSUMOTO (*Journ. Exper. Zool.*, 1918, **26**, 545-64, 9 figs.). Corneal epithelium of the adult frog, cultivated in plasma, shows various types of amœboid movement, according to the nature of the substratum. As a rule the

cells have a strong tendency to cling to their own kind, and thus extend in sheets, although under certain conditions active amœboid movement of isolated cells is also to be seen. In the majority of cultures movement into the medium or along the endothelial surface (or both) takes place according to the consistency of the culture medium. When serum is used no migration of the culture into the medium takes place. Experiments exclude chemotactic influences from the living tissue; there may be vigorous cell-movement on glass and celloidin films. Stereotropism plays an important rôle in cell-movement. The behaviour of corneal epithelium *in vitro* serves to throw some light on epithelial growth *in vivo*; for the experiments show clearly that the epithelium is able to extend from the cut end quite rapidly in sheets into the medium (plasma), or on the tissue (plasma and serum), and can cover a large area without mitotic cell-divisions being necessary at all.

J. A. T.

Cell Movements in Corneal Epithelium.—SHINICHI MATSUMOTO (*Journ. Exper. Zool.*, 1918, **27**, 37-47, 4 figs.). Though the cornea of the adult frog is thin and transparent enough for the observation of epithelial movement, it is not an easy matter to note the details of the process. But if the epithelium of the cornea be vitally stained with neutral-red and Nile-blue characteristic granules are seen in the cytoplasm. These exist through the entire period of cell activity, without practically affecting the cells, and facilitate the study of cell movements. Phagocytic phenomena of the corneal epithelium in reference to melanin and carmin were definitely demonstrated.

J. A. T.

Minute Structure of Monkey's Pharynx.—ISAAC BORTNOWSKY (*Ann. Sci. Nat. (Zool.)*, 1919, **2**, 175-98, 10 figs.). This is a study in histology and specificity. A description is given of the epithelium of the rhino-pharynx, the bucco-pharynx, the laryngo-pharynx, the larynx, and the laryngeal sac in *Cercopithecus*, and of the glands in the first four of these regions, and of the associated adenolymphoid tissue. It is shown that the minute structure of the various regions in *Cercopithecus nictitans* differs from that in man, *Theropithecus gelada*, and chimpanzee.

J. A. T.

Structure and Origin of Dentary Enamel.—ED. RETTERER (*C. R. Soc. Biol. Paris*, 1919, **82**, 571-4). There is sometimes an enamel organ, e.g. in armadillo, which does not produce enamel, but the histogenesis shows that enamel never appears without being preceded by ivory. The prisms of enamel arise not from epithelial cells, but from a transformation of the peripheral ends of the rodlets of ivory. The pre-dentary organ of epithelial nature is a *sine qua non* of the formation of a tooth. For although the epithelial cells do not furnish any part of the tooth, they lend to the mesodermic cells which they cover and define a developmental capacity which they would not otherwise have. They form an environment in which the mesoderm cells become odontoblasts, and these odontoblasts produce both ivory and enamel.

J. A. T.

Cortex of Roots of Teeth.—ED. RETTERER (*C. R. Soc. Biol. Paris*, 1919, **82**, 618-21). The root of the tooth has layers of ivory or den-

tine identical in structure and development with those of the crown. The root is likewise surrounded by a layer of bony tissue, which develops like that of the maxilla at the expense of inter-dento-maxillary connective tissue. Thus arises the osseous cortex ("cement" of some authorities), while the rest of the inter-dento-maxillary tissue uniting the cement to the maxilla persists in a fibrous or ligamentar state.

J. A. T.

Melanophores of Horned Toad.—ALFRED C. REDFIELD (*Journ. Exper. Zool.*, 1918, 26, 275-333, 5 pls., 8 figs.). In *Phrynosoma cornutum* light produces an expansion, its absence a contraction of the melanophore pigment. High temperatures produce contraction and low temperatures expansion. The heat effect dominates at extremes of temperature, the light effect at mean temperatures. Light coming from a dark substratum produces an expansion, from a light substratum a contraction of the pigment. Mild mechanical stimuli do not affect the melanophores; mild faradic stimuli cause contraction of the pigment, and so do noxious stimuli, such as violent mechanical or faradic stimuli.

The melanophores, or some closely associated tissues, are receptors of photic and thermal stimuli. There are no specific receptors for noxious stimuli. The eyes are receptors for stimuli which cause adaptive reactions of the melanophores.

The melanophore pigment is contracted by the direct action of nerves as well as by the direct action of adrenin. The spinal cord contains, between the eighth and thirteenth vertebrae, nervous structures through which pass the impulses which cause the contraction of the melanophore pigment. Impulses pass from this part of the cord directly to the adrenal glands. Impulses also pass from this part of the cord posteriorly, and perhaps anteriorly, within the cord to segmentally arranged peripheral nerves which connect directly with the melanophores. The peripheral fibres are a part of the sympathetic division of the autonomic nervous system.

The reactions of the melanophores of the horned toad produce a series of colour changes correlated with the rhythm of day and night, an adaptation of the colour of the skin to that of the environment, and a characteristic pale condition of the skin during nervous excitement. The daily rhythm of colour change is caused by the direct action of photic and thermal stimuli upon the melanophores or some closely associated tissue. The adaptive reactions of the melanophores depend upon stimuli received through the eyes. The contraction of the melanophore pigment during nervous excitement is brought about by the co-operation of nervous impulses delivered to the pigment cells by the sympathetic nervous system and the secretion of adrenin by the adrenal glands. There is a marked resemblance between the innervation of melanophores and the innervation of smooth muscle.

J. A. T.

Division of Melanophores of Trout.—P. MURISIER (*Bull. Soc. Vaudoise*, 1919, 52, 97-8). In *Trutta lacustris* the melanophores are all mononuclear until a few days before hatching. The transition from the mononuclear to the binuclear phase is accomplished by a typical

karyokinesis, but the two daughter-cells remain together in the region corresponding to the equator of the division-spindle. The mitosis appears to occur very rapidly, for it is difficult to catch many cells in the process.

J. A. T.

c. General.

Aqueous Humour.—W. A. OSBORNE (*Journ. Physiol.*, 1919, 52, 347-50.) The aqueous humour presents the singular phenomenon of a body fluid surrounded by living tissue, and yet containing so little protein that it may be regarded as practically protein-free. The chief solids in it are metallic salts. But the common statement that the aqueous humour has a higher osmotic pressure than the blood is challenged. In fact, it is found that the osmotic pressure of ox aqueous humour is equal to that of blood. Other quantitative considerations support the view that the humour is a blood filtrate. The osmotic pressure of the blood proteins in the iridic vessels will cause absorption of aqueous humour if the excess pressure in these vessels is less than 30 mm. Hg.

J. A. T.

Moult and Regeneration of Pelage in Deer-mice.—H. H. COLLINS (*Journ. Exper. Zool.*, 1918, 27, 73-99, 2 pls.). In *Peromyscus* the moulting is, in a measure, comparable in regularity of sequence and directions of growth to the moults of birds. In the post-juvénal moult, growth occurs more or less independently on certain regions of the body, suggesting the mode of moult in the feather tracts of birds. In adults the moults are generally more irregular and inconspicuous. By plucking out juvénal hair, the precocious appearance of the post-juvénal pelage may be induced, and this is sometimes preceded by the out-growth of an aberrant type of hair, with abnormal pigmentation, which persists only for a short time. The normal sequence of the incoming hair is profoundly modified by artificially induced regeneration. Restoration of pelage in adults occurs irrespective of the season, after the plucking out or clipping of the old hair. This restoration is accomplished by the outgrowth of new hairs, except in the case of the vibrissæ, which are replaced by the elongation of the cut hairs. Restoration is much more rapid when the hairs are plucked out than when merely cut. Light appears to be a negligible factor in the development of the differential coloration of the dorsal and ventral surfaces.

J. A. T.

New Mendelian Variety of Norway Rat.—P. W. WHITING and HELEN DEAN KING (*Journ. Exper. Zool.*, 1918, 26, 55-64). A new Mendelian variety, known as ruby-eyed dilute grey, has been found near the Zoological Laboratory of the University of Pennsylvania. The hair is light sepia at the tip and grades to white at the base. The eye-colour is ruby. The new variation is recessive to intense pigmentation. Ruby-eyed dilution is allelomorphous with albinism. The F_1 individuals, called fawns, are intermediate both in hair and in eye-colour. Fawns when bred together produced eighty ruby-eyed dilutes, one hundred and fifty-six fawns, and eighty albinos. Ruby-eyed dilutes crossed with red-eyed yellow rats produce rats of the wild type.

J. A. T.

Changes in Life-conditions in Illinois River.—S. A. FORBES and R. E. RICHARDSON (*Bull. Nat. Hist. Survey, Illinois, 1919, 13, 139-56*). A study of the changes in the plankton and fishes in the Illinois River since the increase of Chicago sewage emptied into the stream and the reclamation of parts of the overflow regions. "A river and its plankton are a flowing soil and its crop, both slipping away continuously, but both renewed constantly from an exhaustless source of supply. The fertility of the flowing water at any time is not dependent on the fertility of that which has preceded it, but on materials of fertility brought into it from the watershed. . . . The plankton productivity of the stream does not depend primarily on the richness and extent of its own flowing waters, but on those of its subsidiary breeding grounds, and if these are not adequate to the maintenance of a plankton sufficient to consume all the readily available food materials of the stream, more or less fertility of the current waters must go to waste." The yield of fishes in the Illinois River has been diminishing for many years in the face of a greatly increased and rapidly growing supply of the raw materials of their food, because of the narrowing of the backwaters, which are for the river important places of digestion and assimilation in which the organic wastes of the city and of the land are worked up into forms fit for food for the higher animals. It is not only space but time that has been seriously reduced. J. A. T.

Monthly Occurrence of Pelagic Eggs in Port Erin Bay in 1918.—A. SCOTT (*Lancashire Sea-Fisheries Laboratory Report, 1919, 27, 15-24*). It was found that pelagic eggs were present in the plankton for nine months out of the twelve. The increase at the beginning of the year was very rapid, rising from 0.83 per haul of the coarse net in January to 106.4 in March—the maximum. A reduction set in during April, which was continued to June. A well-defined increase took place in July, which was largely due to the presence of the eggs of two species of fish (rockling and topknot). After that the pelagic eggs ceased to be conspicuous among the plankton organisms, and finally disappeared in September. J. A. T.

Intensive Study of Isle of Man Plankton.—W. A. HERDMAN, A. SCOTT, and H. M. LEWIS (*Lancashire Sea-Fisheries Laboratory Report, 1919, 27, 25-35*). "One conclusion that is becoming clear from our accumulated observations of the last ten years is the surprisingly small number of different kinds of organisms—both plants and animals—that make up the bulk of the plankton that is of real importance in relation to fish. Our food from the sea seems to depend, in great measure, ultimately upon comparatively few species of Diatoms and Copepoda respectively. A very large proportion of the Diatoms in the spring plankton and of Copepoda in that of late summer belong in each case to a very few different kinds, so that one can select about half-a-dozen species of Copepoda which constitute by far the greater part of the summer zooplankton, and about the same number of Diatoms which similarly make up the bulk of the spring phytoplankton year after year. These few species, belonging to these two very widely

separated groups, thus come to be the most significant organisms in relation to the annual metabolic cycle of our seas and the food supply from our coastal fisheries." The most significant Copepods are—*Oithona similis*, *Pseudocalanus elongatus*, *Acartia clausi*, *Temora longicornis*, *Paracalanus parvus* and *Calanus finmarchicus*. Their distribution is not uniform, and variations in the distribution must have a marked effect on the presence and abundance of at least such migratory plankton-eating fish as herring and mackerel.

J. A. T.

Respiration in Fishes.—A. KROGH and ISABELLA LEITCH (*Journ. Physiol.*, 1919, **52**, 288-300). Fish blood appears to be subtly adapted to the available supply of oxygen, that of carp, eel and pike, which are occasionally exposed to low oxygen pressure, being different (in dissociation curves) from that of cod, plaice and trout, which normally are never exposed to very low oxygen pressures. The adaptation of the fish blood must be brought about by some substance or substances present along with the hæmoglobin within the corpuscles, and the general significance of the hæmoglobin being present in semi-permeable corpuscles, and not simply dissolved in the plasma, is ascribed to the fact that the arrangement makes possible the adaptation of the hæmoglobin to extremely different respiratory conditions without interfering with the general composition of the blood. A hæmoglobin dissolved in blood plasma can, in a cold-blooded animal, only be useful at very low oxygen pressure, and that is probably why in Invertebrates the possession of hæmoglobin is restricted to forms which are habitually exposed to such pressures.

J. A. T.

INVERTEBRATA.

Mollusca.

Muscle-fibres of Molluscs.—R. ANTHONY (*Arch. Zool. Expér. Notes et Revue*, 1919, **58**, 1-10, 3 figs.). In the adductor muscles of bivalves there are two kinds of fibres: (a) smooth and slowly contracting (the nacreous portion); and (b) rapidly contracting and striated, or with lozenge-shaped marking. Those with the lozenge-shaped marking are intermediate between smooth and striped. In *Anomia* the same fibre may show both kinds of marking. The transition from smooth muscle to that with lozenge-shaped marking is adaptive to certain functional requirements which the author expounds.

J. A. T.

γ. Gastropoda.

Dimorphic Spermatozoa in *Paludina vivipara*.—J. BRONTÉ GATENBY (*Quart. Journ. Micr. Sci.*, 1919, **63**, 401-43, 2 pls., 21 figs.). In the case of these dimorphic spermatozoa, the atypic (giant) cells have numerous fine granular mitochondria, while the typic have a very small number of large, stout, rod-shaped mitochondria. In the typic divisions it seemed that in some cases the large rods were merely sorted out into two groups to the daughter-cells, while in other cases the rods were divided in the middle. In the atypic divisions the mitochondria acted

like those of *Helix aspersa* or other Pulmonates. In rare cases the mitochondria of the typic spermatocytes are very large, coarse granules, quite distinct from the smaller granules of the atypic series. The author discusses the "Nebenkern" or "Golgi" apparatus. J. A. T.

Germinal Nurse-cells of Testacella.—J. BRONTÉ GATENBY (*Quart. Journ. Micr. Sci.*, 1919, **63**, 401-43, 2 pls., 21 figs.). In this slug some of the germinal epithelial cells, instead of forming ova, spermatozoa, and follicle-cells, become much enlarged to form yolk-cells or nurse-cells, which have very large hyper-chromatic nuclei and a cytoplasm full of yolk-discs. They nourish the ova and sperm-cells in spring and summer; they degenerate in part towards autumn and winter; there is a re-activation of some of them in the early spring, but degeneration again occurs in many cases. The number of chromosomes in *Testacella* seems to be something over twenty, and the haploid number over ten, probably about twelve. The giant germ-cells seem to contain an irregular and over-numerous series of chromatin loops. J. A. T.

Gametogenesis and Early Development of Limnæa stagnalis.—J. BRONTÉ GATENBY (*Quart. Journ. Micr. Sci.*, 1919, **63**, 445-91, 2 pls., 6 figs.). In the oogenesis of this water-snail the germinal epithelial cells show an excentric "Golgi apparatus" or "Nebenkern," consisting of a number of rods (chondrioplasts or dictyosomes). In the progerminative oocyte mitochondria appear very early in the zone of the Golgi apparatus. The Golgi rods divide by binary fission, and keep increasing in number, each becoming provided with a small portion of the included archoplasm. The apparatus spreads through the whole ovum-cytoplasm. The mitochondria grow, divide, and spread uniformly. The individual Golgi rodlet never grows beyond a certain size. The first yolk-discs make their appearance after the Golgi elements and mitochondria have spread far through the growing oocyte. Towards the end of oogenesis the oocyte gradually becomes filled with fluid vacuoles. In the spermatogenesis no mitochondria were discovered. In spermateleosis (the metamorphosis of spermatid into spermatozoon) there is a mitochondrial residue sloughed off. The tail of the sperm appears as a new formation of mitochondrial matter around the axial filament. The Golgi apparatus is sloughed off during spermateleosis. The nuclear head is very small compared with the long mitochondrial tail. In segmentation the mitochondria are equally divided; so is the Golgi apparatus; both persist in organogeny. J. A. T.

Arthropoda.

a. Insecta.

Germ-band in Holly Tortrix Moth.—L. H. HUIE (*Proc. R. Soc. Edinburgh*, 1918, **38**, 154-65, 2 pls.). The development of *Eulemis nævana* can be followed in the living egg with unusual clearness. Beneath the inner pellicle is a finely and densely granular protoplasm, and inside this is the yolk-plasm. Maturation takes place about the time of oviposition; the first polar body divides again. The first division of the zygote occurs two or three hours after oviposition; in a few hours

there are sixteen nuclei, which spread throughout the yolk; after a few more nuclear divisions the resulting amoeboid cells tend to the periplasm; there a blastoderm is established, the periplasm being broken into a chain of cell-like territories, each with a nucleus in its centre. The cells of the blastoderm and those in the yolk now show a large nucleolus. The completion of the blastoderm is achieved when the cells become sufficiently numerous to form a continuous epithelium. A portion of this is differentiated to form the ventral plate or germ-rudiment, consisting of columnar epithelium. The amnion fold arises at its margins. There is an inward movement of the germ-rudiment into the yolk, which becomes broken up by vitellophags. There is a remarkable turning movement of the germ-rudiment, which becomes crescentic in outline. The germ-rudiment assumes the form of a germ-band, with cells still more columnar and closely apposed, with two procephalic lobes at the head-end, with a narrow median groove which sinks in to form the "inner layer," which soon becomes segmented. J. A. T.

Pupæ of Sphingidæ.—EDNA MOSHER (*Ann. Entomol. Soc. America*, 1918, 11, 403-42, 1 pl.). It is shown that pupal characters indicate natural relationships and confirm those indicated by adult characters. The majority of the sphinx moths spend their pupal life in a cell in the ground, which is formed by the mature larva; the body-surface is generally punctate, with indeterminate transverse striations between the punctures, and the sides of the abdomen in the spiracular region are usually more strongly sculptured than the rest of the body; the cephalic margins of abdominal segments 5-7 are strongly furrowed or carinate in most cases; the furrows (called "spiracular") may be sometimes so deep as to form a sort of pocket-like cavity; no setæ have been observed on the body; the length of the maxillæ in the pupæ often greatly exceeds the length of the wings, in some instances being twice their length, and there are three different ways of providing for this extra length. The spiracular furrows and the maxillæ afford the best characters for classifying the pupæ, and a key to the genera is submitted. J. A. T.

South African Bagworms.—C. B. HARDENBERG (*Annals Natal Museum*, 1919, 4, 143-227, 1 pl., 25 figs.). In continuation of previous studies the author gives a detailed account of twelve species, taking account not only of structure, but of life-history and economic importance. The species belong to the genera *Acanthopsyche*, *Clania*, *Manatha*, *Semimanatha*, and *Monda*; and many minute details are given as to the setæ and mouth-parts of the larvæ. There is much interesting information in regard to the structure of the bags and the habits of the larvæ. J. A. T.

Pulsatile Tergal Organ in Lepidoptera.—FRANK BROCHER (*Arch. Zool. Expér.*, 1919, 58, 149-71, 8 figs.). In *Sphinx convolvuli* there is a mesotergal pulsatile organ like that in water-beetles. It is in a sense the true heart, being much more important than the dorsal blood-vessel in driving the blood. Its importance makes it easier to understand the prolonged survival of insects which have lost their abdomen or have

been badly wounded in the abdomen. There is a sort of thoracic cycle. In the convolvulus moth there is also a small metatergal pulsatile organ, which receives alary veins. But no connexion with aorta or dorsal blood-vessel could be seen. In Dyticidæ it is this metatergal pulsatile organ that is of the greater importance. J. A. T.

Intestinal Epithelium of Silkworm.—A. FOÀ (*Boll. Lab. Zool. Agric. Portici*, 1918, **12**, 217-44). The mid-gut epithelium shows cylindrical and calyciform cells, differing in structure and function. Both are secretory, but the cylindrical cells are likewise absorbent. In diseased (flaccid) silkworms the calyciform cells are reduced or modified. J. A. T.

Male Genital Tube in Coleoptera.—FREDERICK MUIR (*Trans. Entomol. Soc. London*, 1918, **22**, 3-9, 1 pl.). This organ arises as a tube in a median position from the connecting membrane between the ninth and tenth sternites. There is no evidence whatever to indicate that it is composed of amalgamated paired organs (called parameres by some authors); the terminal lobes, cap-piece and tegminal strut are secondary outgrowths from the tegminal fold. There is no indication that any abdominal segment or sternite is incorporated into the tube. The organ is a tubular evagination and no more. J. A. T.

Spiracles of Some Muscid Larvæ.—JOHN L. FROGGATT (*Proc. Linn. Soc. N.S. Wales*, 1918, **43**, 658-67, 1 pl.). An account is given of the minute structure of the spiracles of four species of *Calliphora*, *Lucilia sericata*, and *Ophyra nigra*. This has a practical interest, for it is found that from the posterior spiracles in particular it is possible to identify the different species, even when they are rotten. The spiracles are probably very important in connexion with the destruction of the maggots of these species by poison, for apart from the mouth and anus they are the only openings. In these species there are no pores in the cuticle as there often are in insect larvæ. But the important point zoologically is the specificity of the spiracular apparatus. J. A. T.

Bot-Flies.—S. HADWEN and A. E. CAMERON (*Bull. Entomol. Research*, 1918, **9**, 91-106, 1 pl., 10 figs.). Careful descriptions and admirable figures are given of three species of *Gastrophilus* occurring in Canada—*G. intestinalis*, *G. nasalis*, and *G. hæmorrhoidalis*. They differ in the mode of attachment of the egg to the hair, in the external features of the newly hatched larvæ, and in the appearance and habits of the adults. The eggs of *G. intestinalis* do not readily hatch unaided, but apparently require the application of moisture and friction or shock. A large number of the eggs of *G. nasalis* hatched spontaneously, and so did a few of those of *G. hæmorrhoidalis*. This supports the view that the larvæ of these two species may penetrate directly into the integument of the host. The lesions on the skin of the intermaxillary space and the lips observed at the time the eggs were hatching may be due to direct penetration of the larvæ of *G. nasalis* and *G. hæmorrhoidalis* respectively. The newly emerged larvæ of *G. intestinalis* failed to penetrate the hair-bearing skin of the horse, but positive results were obtained when they

were placed on portions of the buccal mucosa of a horse and calf recently killed. A larger number succeeded in penetrating the papillated portion of the calf's tongue, as compared with the non-papillated. Of the three species, *G. intestinalis* causes the horses less apprehension than the others. The provision of leather flaps on the lips of the horse, cut into strips comb-wise, is advocated as likely to give good results in warding off the attacks of *G. hæmorrhoidalis*.
J. A. T.

Effect of a Diet of Ductless Glands on Development of Flesh-flies.—B. W. KUNKEL (*Journ. Exper. Zool.*, 1919, **26**, 255-64). Feeding larvæ of *Lucilia* and other flesh-flies upon mammalian thyroid and nothing else tends to retard slightly the growth of the larvæ, and consequently to reduce the size of the resulting pupæ. But a diet of thymus tends to increase their size. Thyroid feeding tends to hasten the onset, and to shorten the period of pupation.
J. A. T.

Development of Maggots in Sterilized Tissue.—E. WOLLMAN (*C.R. Soc. Biol. Paris*, 1919, **82**, 593-4). It has been shown that the larvæ of blow-flies (*Culliphora vomitoria*) are able to develop satisfactorily in flesh sterilized at a temperature of 115°, but that the results are not so good when the sterilization is effected at higher temperatures. This has been attributed to the destruction of vitamins. To eliminate disadvantages due to hardening of the tissue, Wollman took fragments of brain and sterilized them in tubes at 130° for forty-five minutes. Eggs of the blow-fly sterilized in sublimate were placed in the tubes, and it was found that the larvæ developed much better than they did in the flesh sterilized at 115°. On the fifth day they were quite normal. It may be that the vitamins are not destroyed, it may be that the larvæ possess "accessory factors of growth," it may be that the larvæ produce vitamins in the substratum, but further experiments are needed. J.A.T.

Note on Nutritive Value of Sterilized Food.—CHARLES RICHEL (*C. R. Soc. Biol. Paris*, 1919, **82**, 601-2). In reference to Wollman's experiment, Richet points out that no general statement can be made in regard to the destruction of vitamins by heat. Dogs fed exclusively on flesh cooked at 100° die in four to five weeks, but dogs fed on a mixture of bread and flesh sterilized for three-quarters of an hour at 135° may thrive.
J. A. T.

Light Reactions of May-fly Nymphs.—W. C. ALLEE and E. R. STEIN, jun. (*Journ. Exper. Zool.*, 1918, **26**, 423-58, 4 charts). The light reactions of the positively phototactic May-fly nymph, *Epeorus*, were reversed by treatment with alcohol, lowered temperature, calcium chloride, and other influences. Nymphs so reversed had a lower rate of metabolism, as measured by resistance to potassium cyanide, than have normal nymphs. The negatively phototactic nymph, *Leptophlebia*, was similarly reversed, with accompanying stimulation or depression of metabolism, as measured by resistance to the cyanide. A negatively phototactic nymph belonging to the Heptageninæ was reversed in its light reactions, with accompanying increase or decrease in carbon dioxide production as measured by Tashiro's biometer. The phototactic reaction

is correlated with the metabolic condition. The experiments indicate, but do not prove, that certain changes in metabolism cause the reversals in reaction to light. All nymphs that reversed their light reactions were either stimulated or depressed, but stimulation or depression does not necessarily involve phototactic reversal.

J. A. T.

Life-history of Red-currant Aphis.—MAUD D. HAVILAND (*Proc. R. Soc. Edinburgh*, 1919, **39**, 78-112, 9 figs.). This Aphis, *Myzus ribis*, is dimorphic in respect of certain features of the antenna and of abdominal and wing dimensions. The nature of the food, whether healthy or blistered by the attack of the fundatrix, seems to be the determining factor of this dimorphism. The form from healthy leaves is probably identical with *M. whitei* Theobald and *M. dispar* Patch. The insect is migratory, and in summer colonizes certain Labiatae and other weeds; but this migration is not obligatory, and the entire life-cycle may be passed on currant. On its summer host this species has been described as *Phorodon galeopsidis* Kaltenbach. There is a decline in fertility in the later part of the summer among the forms remaining on currant. This is caused by a lower birth-rate, and not by the shortening of the life of the parent. This decline, together with the attacks of predaceous and parasitic enemies, accounts for the frequent disappearance of the species from the currant in August and September. Both sexual forms may be produced, and eggs may be laid on either host-plant. Males transferred from Labiate to currant can fertilize females on the latter.

J. A. T.

Wings and Tracheæ of Termites.—CLAUDE FULLER (*Annals Natal Museum*, 1919, **4**, 19-102, 9 pls.). The ribs supporting the termite wing are derived from thickenings of the cellular tissue of the developing organ. One of these thickenings is in the form of an ambient, and develops independently around the margin, whilst the rest form about tracheæ. Subsequently, that portion of the ambient thickening which extends along the outer margin is converted into the rib costa. The tracheæ of the wing-sac develop from two or from three buds, forming very early in nymphal life upon each of the four sections of the spiracular trunk tracheæ within the meso- and metathorax, and not upon the dorsal and ventral longitudinal trunks, as described in other cases. The position and branching of the longitudinal ribs of the wing are almost wholly dependent upon the position and development of the longitudinal tracheæ, except in the case of the costa, which is not preceded by a trachea. The specialization of the wing-ribs by reduction follows the reduction of the tracheæ. A newly-hatched termite shows a framework of comparatively few simple tracheæ, from which a multitude of dichotomizing, arborescent, and other tracheæ gradually develop and grow. The specialization of the respiratory system is by reduction. The valvular spiracles of the abdomen of the adult are derived by gradual transformation from the occluding apparatus of the spiracles with a fixed opening exhibited by the nymphs. The slit-like spiracles of the abdomen of highly-distended queens in *Termites* and *Odontotermes* represent disruptions of the final valvular spiracles.

J. A. T.

Chromatin Maturation in Spermatogenesis of *Locusta viridissima*.—OTTO L. MOHR (*Arch. Biol.*, 1919, 29, 579-752, 5 pls., 9 figs.). There is in the spermatogenesis a multiplication-period, in which the primitive sperm-cells give rise to primary spermatogonia, and these to secondary spermatogonia. Then there is a maturation-period, with two maturation-divisions in the two generations of spermatocytes. There is a monosome (or genuine unpaired chromosome) which is divided longitudinally in all the divisions except the first maturation-division, where it passes undivided into one of the daughter-cells. This is an indication of the fact that the first maturation-division is a reducing division. It is probable that an ovum (with 14 + 1 chromosomes) fertilized by a spermatozoon (with 14 ordinary chromosomes and a monosome) will develop into a female, while one fertilized by a spermatozoon without a monosome will develop into a male. J. A. T.

Insect Life of New Zealand Mountain Station.—F. W. HILGENDORF (*Trans. New Zealand Inst.*, 1918, 50, 135-44). Two important factors in the environment are dead sheep and white flowers, for these are correlated with the two most striking features of the insect life—namely, blowflies by day and moths by night. Apart from birds the only native land vertebrate is the common lizard (*Lygosoma moco*), but fish in the lakes and streams are numerous. The introduction of trout must have made an enormous difference to the insect and probably to the bird population of the district. Hudson has shown that the stomachs of sixty trout taken from various localities contained 4804 Neuroptera, 662 other insects, and twenty-eight other animals. An account is given of the insects of various associations—the tussock grass-land, the lake and swamps, the river-bed, the shrub-land, the forest, and the rocks. The short paper contains many interesting notes. There is the diving dragon-fly, *Somatochlora smithii*, which picks guat-larvæ from the surface of the water, immersing its head ten or twenty times in a minute. When the blowflies do not find a dead sheep they are urgently impelled to any place where there is the faintest scent of animal matter. "I have seen *Calliphora quadrimaculata* so violently impelled to lay her eggs somewhere that she has done so on a bicycle-tyre where it had just been pressed with a perspiring hand." J. A. T.

Mutation in Coccidæ.—K. KUNHI KANNAN (*Trans. Entom. Soc. London*, 1918, 130-48, 4 pls.). In *Coccus viridis* Green collected in Mysore when the pest first appeared there in 1912 there were seven segments in the antennæ. But specimens collected in 1913 and afterwards, though undoubtedly *C. viridis* in other respects, showed in the antennæ a reduction to three segments by the coalescence of the terminal five into one. In Java, besides the typical *C. viridis*, there are two distinct types, with very variable but usually eight antennal segments, highly unstable and with a host of intermediate forms. The author brings forward evidence to show that *Pulvinaria psidii*, also very variable in size, antennæ, and anal plates, is a mutating species from which *C. viridis* and its variants have been derived directly or indirectly.

J. A. T.

As regards Mutation in Coccidæ.—E. ERNEST GREEN (*Trans. Entomol. Soc. London*, 1918, 149-54). That a reduction in the number of antennal joints has been observed in South Indian specimens of *Lecanium* (*Coccus*) *viride* and *Pulvinaria psidii* does not necessarily form an argument in favour of the transmutation of the two species, but suggests, rather, that a similar environment has induced in the two a tendency to variation in the same direction. Green holds that the genera *Pulvinaria* and *Lecanium*, though very closely allied, have quite well-defined boundaries. He sees no more justification for regarding *L. viride* and its allies as having been directly derived from *P. psidii* than for assuming a similar relationship between *L. hesperidum* and *P. floccifera*, or many other pairs that might be mentioned. J. A. T.

Study of Cockroach Head.—E. BUGNION (*MT. Schweiz. Entom. Ges.*, 1916, 12, 383-400, 1 pl., 4 figs.). An account is given of the structure

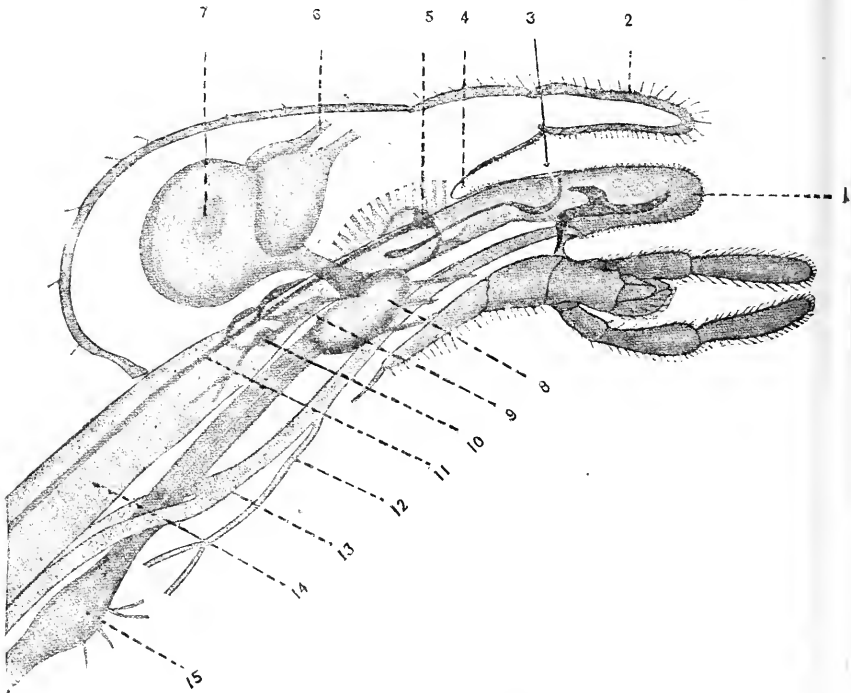

SAGITTAL SECTION OF THE HEAD OF *Blatta americana* $\times 9$.

(The mandibles and first maxillæ have been removed.)

1. Tongue. 2. Labrum. 3. Entrance to pharynx. 4. End of labro-pharyngeal sinus. 5. Frontal ganglion. 6. Antennary nerve. 7. Section of optic nerve. 8. Sub-oesophageal ganglion. 9. Anterior sub-intestinal ganglion. 10. Posterior sub-intestinal ganglion. 11. Recurrent nerve. 12. Duct of salivary glands. 13. Duct of salivary reservoirs. 14. Oesophagus. 15. Prothoracic ganglion.

of the head and its appendages in *Blatta americana* and *B. australasiæ*. There is no large new fact to report, but the description is exceedingly careful and the figures are good. A structure like the quadrilateral tentorium inside the head is minutely described, and the mouth-region (including tongue, hypopharynx, pharynx, as well as appendages), is particularly well described.

J. A. T.

β. Myriopoda.

Vulvæ of Diplopoda.—HENRY W. BRÖLEMANN and JEAN L. LICHTENSTEIN (*Arch. Zool. Expér.*, 1919, 58, 173–218, 31 figs.). A detailed account is given of the integumentary differentiation around the genital apertures of the females (when these do *not* lie on the second pair of appendages, but behind these), which may be spoken of as the vulva. The forms especially dealt with are *Polydesmus coriaceus*, *Schizophyllum sabulosum*, and *Archispirostreptus tumuliporus sudanicus*. What has been called a gland is an apodermatous groove. There appear to be associated sensory setæ. With the groove or gutter minute glands are associated, and the secretion may assist in the receiving of the sperms. But there is nothing appendicular about the vulva.

J. A. T.

δ. Arachnida.

Water-mites from Peru and Brazil.—C. WALTER (*Revue Suisse Zool.*, 1919, 27, 19–59, 45 figs.). This contribution to our knowledge of the Hydracarina of a region that has been very slightly studied includes descriptions of twelve new species of various genera (*Limnesia*,

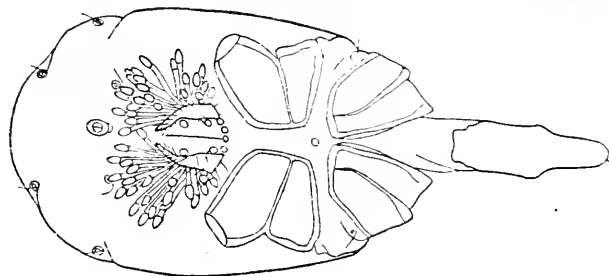

Ventral surface, *Neocalonyx godeti* g. et sp. n., male.

Frontipoda, *Hygrobatas*, *Arrhenurus*, *Eylais*, *Kœnikea* and *Halacarus*). An account is given of *Neocalonyx godeti* g. et sp. n., which is related to *Calonyx*.

J. A. T.

Cavernicolous Spiders.—LOUIS FAGE (*Arch. Zool. Expér.*, 1919, 58, 55–148, 7 pls., 48 figs.). An account is given of the cavernicolous genus *Troglohyphantes*, and of its many species. They are very small spiders, 2–4 mm. in length. Some of the species, but a minority, show special features correlated with their life in caves—the depigmentation of the chitin, the elongation of limbs and sensitive setæ, the reduction of eyes (even to complete anophthalmia). Many species show no special features that can be correlated with cave life. Most move slowly; they

do not "feign death"; the web is slight; the oviposition has not been observed. The genus is separated from related forms mainly by the structure of the copulatory organs, and the evolution of this in the various species, starting from the most primitive Cantabrian and Pyrenean forms, seems to have progressed from west to east. J. A. T.

€. Crustacea.

Structure of Barnacles.—HJALMAR BROCH (*K. Norske Videnskab. Selskabs Skrifter.*, 1918, 1, 1-28, 5 pls., 5 figs.). An account is given of some anatomical and histological features of *Anelasma squalicola* (Lovén) Darwin and *Scalpellum strömii* M. Sars. It is shown that *Anelasma*, in the general structure of its alimentary canal, occupies a somewhat intermediate position between the less specialized *Scalpellum* and the more highly specialized *Conchoderma* and *Lepas*. In their general structure the digestive glands of *Anelasma* are more highly developed than in *Scalpellum*, and approach the high organization of *Conchoderma*; on the other hand, their finer structure suggests resting or even degenerating tissues. The digestive intestine seems to have ceased to be a food-absorbing organ. This is associated with the development of secondary nutritive organs, the offshoots or filaments of the peduncle. These filaments have a dissolving influence on the tissue of the shark on which the barnacle is fixed, and they are abetted in this by secretions from the cement glands, which are numerous and large. They do not, as in other stalked cirripeds, combine into two groups or pass their secretion to the base of the stalk by two main ducts. In *Anelasma* the single gland-cells communicate by short ducts with the lacunæ of the connective tissue. J. A. T.

New Isopod of Natal.—WALTER E. COLLINGE (*Annals Natal Museum*, 1919, 4, 229-33, 1 pl.). A peculiar and interesting form, *Akermania spinosa* g. et sp. n., probably one of the Cubaridæ, is described. It differs from any terrestrial Isopod hitherto described, in the shape of the cephalon, the folded coxopodite beneath the pleural plates of the first mesosomatic segment, the feeble walking legs on segments 2-7, the short expanded uropods with characteristic setæ, and the shape of the telson. It shows a strong development of spines, setæ, and scales. J. A. T.

Development of Testes in Parasitic Copepod.—M. CAULLERY and F. MESNIL (*C.R. Soc. Biol. Paris*, 1919, 82, 596-8). In *Xenocaloma brumpti*, parasitic on *Polycirrus arenivorus* Caull., there is hermaphroditism and apparently autogamy. In Cymothoidæ, Cryptoniscidæ, and similar groups there is a normal and single primordium which produces spermatozoa and ova successively or simultaneously. In *Xenocaloma* no germinal cells are to be seen in the embryo or in the nauplius. In the early parasitic stages, however, the ovary is distinctly differentiated and the primordium of oviducts. Connected with this primordium there is an epithelial complex, not different from ordinary epithelium, which subsequently gives origin to testes, seminal vesicle, and the so-called atrial cavity. Spermatogonia quite similar to oogonia appear *in situ*, in

entire independence of the ovary. It may be, however, that testes and seminal vesicle arise from a transformation of what is the receptaculum in ordinary female Copepods. Does epithelial tissue become in part germinative, or does somatic tissue become testicular? Further inquiry is needed.
 J. A. T.

Yolk-formation in Copepod Ovum.—H. LEIGHTON KESTEVEN (*Proc. Linn. Soc., N.S.W.*, 1918, 43, 136-41, 1 pl.). In *Ubius hilli* Kestv., an endoparasitic Copepod from *Ptychodera australiensis* Hill,

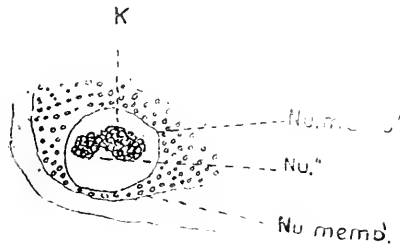

Ubius hilli Kestv.

Stage in formation of new nucleus. *K*, karyosomes; *Nu.*, the new nucleus nearly formed; *Nu. memb.*, the nuclear membrane of the old nucleus; *Nu. memb.*, the nuclear membrane of the new nucleus.

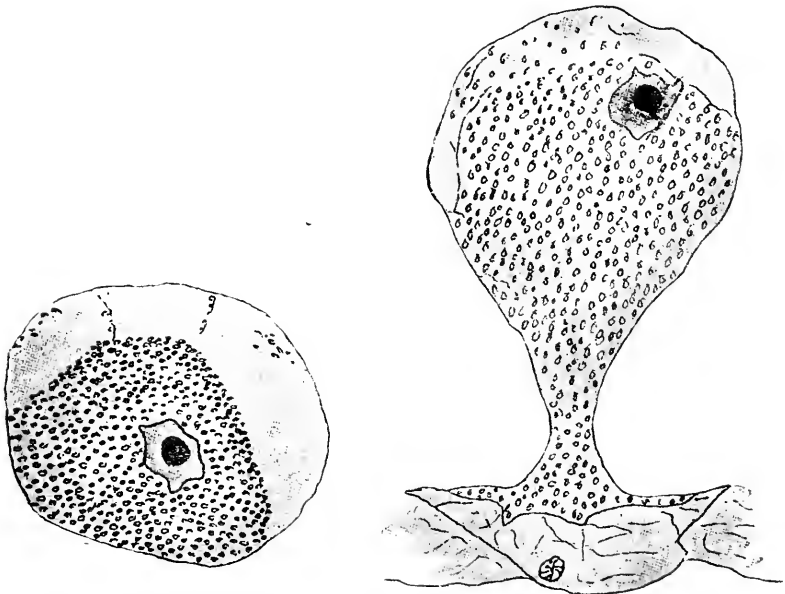

Sections of mature primary oocytes, with nucleus and yolk-granules.

the yolk-granules are formed by the combination of a cytoplasmic constituent with chromatin. The first yolk-granules appear within the nucleus. A new nucleus is formed by a pseudo-contraction of the overlaid old nucleus. This pseudo-contraction leads to the shedding of some of the karyosomes, which function as yolk-nuclei. These yolk-nuclei are stores of chromatin which continue the functional activity of the nucleus of the growing primary oocyte. That is to say, their use is to supply chromatin for that combination which results in yolk-formation. The ultimate oogonium is nourished by endosmosis, the primary oocyte by the epithelium of the oviduct. In both cases the all-important substance received is the cytoplasmic constituent, which enters into yolk-formation. Chromatin constituents, however, must be derived from without in the earliest stages.

J. A. T.

Annulata.

Polychæta of Northern Coasts of Spain.—ENRIQUE RIOJA (*Trabajos Mus. Nac. Cienc. Nat. Madrid, Ser. Zool.*, 1918, **37**, 1-99, 20 figs.). The author's report deals with eighty-one species of littoral Polychæta, including *Hyalinæcia fauveli* sp. n. and *Nereis* (*Neanthes*) *bolivari* sp. n. The latter is placed in a new sub-genus, including those species of *Nereis* in which all the groups of paragnaths are complete, those of the ventral basal portion of the proboscis being united in a complete girdle. In the sub-genus *Neanthes* the groups of paragnaths are also all complete, but those of the dorsal basal portion are distinctly separate from one another and from those of the ventral portion. A new variety of *Glycera convoluta* is based on a minute feature, the hooked end of the aciculum of the ventral blade of the parapodia, which are also more robust than in the type.

J. A. T.

Intercalary Growth in a Maldanian Worm.—P. FAUVEL (*Bull. Soc. Zool. France*, 1919, **44**, 36-40). In a strange Polychæte, *Gravirella multiannulata* g. et sp. n., there is a remarkable proliferation. The succession of segments in the abdominal region is interrupted by the intercalation of a series of segments, the first few very rudimentary, the others gradually increasing until the normal size is exhibited. This was observed in a dozen cases. It recalls the proliferation in a tapeworm and the stolonization of some Syllids. In one case there were two proliferating zones widely separated. It may be a rapid method of making good posterior breakages, or it may be the result of some unknown irritation.

J. A. T.

Anabiosis in Earthworms.—PETER SCHMIDT (*Journ. Exper. Zool.*, 1918, **27**, 57-72). Earthworms subjected to exsiccation or desiccation pass into a state regarded as analogous to the anabiosis of Tardigrada, Rotifers, and Nematodes. They lose their mobility; they shrink to one-half or one-third of their length and volume; they show no manifestations of life. No contractions were seen in the dorsal blood-vessel. The capacity for revivification may be retained for thirty-nine hours in summer, for forty-eight hours, and perhaps more, at low temperature.

The limits may be due to the fact that drying of the skin is apt to destroy the capillaries and cause effusion of blood, and to the presence of micro-organisms in the gut and on the surface. The experiments bring out an important fact, that a large percentage of water can be lost without the complete loss of vitality. Earthworms can revive and regain the normal state of life after a loss of 61·6 p.c. of the weight of the body, or nearly 73 p.c. of the weight of the water contained in the body. This makes it easier to understand, or, perhaps one should say, to believe, that small creatures like Tardigrades, Rotifers, and Nematodes can revive after losing 80–85 p.c. of the water in their bodies.

J. A. T.

Oligochæts of the High Alps.—EMILE PIGUET (*Rev. Suisse. Zool.*, 1919, 27, 1–17). Collections from the mountains of Scandinavia and Switzerland are compared, and the species common to both countries are noted. The Naididæ are represented by *Paranaïs uncinata*, *Chætogaster diaphanus*, and *Stylaria lacustris*; the Tubificidæ by two species of *Tubifex*; the Enchytræidæ by a number of doubtful forms; the Lumbriculidæ by *Lumbriculus variegatus* and *Stygodrilus heringianus*; and the Lumbricidæ by *Lumbricus melibæus*.

J. A. T.

Nematohelminthes.

New Nematode in Calves.—A. L. SHEATHER (*Bull. Agric. Research, Inst. Pusa*, 1919, 86, 1–5, 5 pls.). A parasite is described which causes parasitic gastritis in calves. The caudal bursa is trilobed, with the posterior lobe symmetrically placed; there are very long and slender spicules; the vulva is close to the posterior end of the body. These features distinguish the worm from the genera *Hæmonchus*, *Nematodirus*, *Trichostrongylus*, *Ostertagia* and *Cooperia* known to occur in the stomach proper and duodenum of calves.

J. A. T.

Platyhelminthes.

Remarkable Case of Echinococcus in Lemur.—H. BLANC (*Bull. Soc. Vaudoise Sci. Nat.*, 1919, 52, 451–6, 1 pl., 3 figs.). A specimen of *Lemur catta* showed an almost complete invasion of the thoracic and abdominal cavities by an extraordinary number of hydatid vesicles of *Echinococcus polymorphus*. There was no hint of scolices developing into hydatid cysts, as might ensue if a hydatid vesicle was burst, liberating the heads. It seems more likely that the lemur, which lived in a menagerie with a dog as companion, was the victim of multiple infection from the eggs of the tapeworm stage living in the dog's intestine.

J. A. T.

Methods of Reproduction in Cestodes.—T. SOUTHWELL and BAINI PRASHAD (*Journ. Parasitology*, 1918, 4, 122–9, 12 figs.). The authors discuss the various methods of asexual and parthenogenetic reproduction amongst the Cestodes—(1) internal proliferation from the wall of the cysticercoid, as seen in *Polycercus*, *Cœnurus*, and others; (2) endogenous

budding, as seen in Willey's *Merocercus*; (3) external budding, as exemplified in the species of *Polycercus* and *Staphylocystis*, described by Haswell and Hill; and (4) parthenogenetic reproduction, uniquely illustrated in *Ilishia parthenogenetica* Southwell and Prashad, an adult tapeworm of doubtful affinities. J. A. T.

Rhabdites of Turbellaria.—MARCEL PRENANT (*Arch. Zool. Expér.*, 1919, 58, 219-50, 1 pl., 12 figs.). These bodies are formed of one or more protein substances (with sulphur and phosphorus) combined with calcium. They are almost certainly nucleoproteins, arising from the degeneration of the nuclei, and may be either excretory or reserve products. Their formation is preceded, in many cases at least, by nuclear buds and degeneration. In the epidermis of Polyclads their formation from degenerate nuclei is direct; they have the value of nuclei; their individualization is due to amitosis or to budding. In the epidermis of Triclads and Rhabdocelids the rhabdites arise in superficial corpuscles, probably the basal corpuscles, and their appearance is associated with the degeneration of adjacent nuclei. In *Fecampia erythrocephala*, about the time of encystation and of oviposition, there is an abundant production of rhabdites, followed by their disappearance. There is probably in most cases an actual waxing and waning of rhabdites. In *Prosthlostomum siphunculus* there are rhabdites in the parenchyma, the third case among Polyclads. J. A. T.

Reactions of Proboscis of Planaria albissima.—W. A. KEPNER and ARNOLD RICH (*Journ. Exper. Zool.*, 1918, 26, 83-100, 10 figs.). A proboscis severed from its adjacent ganglion still shows some reaction by disturbed movements within the sheath. In most cases a proboscis, thus separated from the central nervous system, underwent auto-amputation while lying within the sheath. Sometimes this did not happen without a disturbance of the thigmotactic conditions within the sheath. In all cases, however, the disturbance of the thigmotactic conditions of the sheath so excites the proboscis that, without the inhibitory control of the adjacent ganglia of the central nervous system, the proboscis suffers auto-amputation, and acts as an independent reflex "organism." It can carry out the three co-ordinated muscular movements involved in food-ingestion, provided that its entire musculature is intact. It cannot distinguish between food and non-food, for that requires the functioning of the central nervous system. J. A. T.

Incertæ Sedis.

Transverse Fission in Phoronopsis.—J. D. F. GILCHRIST (*Quart. Journ. Micr. Sci.*, 1919, 63, 493-507, 1 pl.). This Phoronid has been observed to reproduce asexually by transverse division of the body. The division occurs in the muscular region, and the detached part is capable of locomotion. It divides a second time below the lophophore, which is thrown off and disintegrates. The remaining part, after moving about freely, develops an anterior projection (epistome?), a lophophoral ridge,

and later an aboral projection. The epidermis of this projection is thrown into a number of involutions, by the unfolding of which it somewhat suddenly increases in length at later stages, and assumes the form of a peduncle, which fixes the animal by a mucous secretion. The whole process, from the first division to the pedunculate fixed form, occupied fourteen days. The peduncle consists externally of a proliferation of the epidermis of the body and internally of modified cells of the coelomic epithelium, fatty particles and muscular elements. J. A. T.

Rotatoria.

Sex Determination in Hydatina.—A. FRANKLIN SHULL (*Journ. Exper. Zool.*, 1918, **26**, 521-44). When water is saturated with an atmosphere containing 60 p.c. of oxygen there is increased male-production. The same is true, Shull and Ladoff have shown, with a 40 p.c. oxygen atmosphere. The lower concentration may, perhaps, be a little more effective in inducing male-production. Cultures in which *Euglena* is used as food show increased male-production; this is partly, but not wholly, due to the oxygen liberated by the *Euglena*. But *Euglena* as food is two or three times as effective as oxygen. Manure-scum used as food is a male-repressing agent. J. A. T.

Echinoderma.

Egg Secretion in Echinoderms.—AVALYN E. WOODWARD (*Journ. Exper. Zool.*, 1918, **26**, 459-501, 2 charts, 3 figs.). In confirmation of the work of Lillie and Glaser, it was found that the eggs of *Asterias* and *Arbacia* secrete into the supernatant sea-water a substance which causes the sperm of the same species to be activated, aggregated, reversibly agglutinated, and paralysed. The secretion is also a parthenogenetic agent.

Further study showed that the presence of the secretion is necessary for the fertilization of the egg, for (1) immature eggs, which cannot be fertilized, produce a secretion with less than one-sixtieth the agglutinating power of that produced by the same eggs when mature; (2) eggs from which the secretion has been washed do not develop when inseminated, but if secretion be added before insemination they develop; (3) eggs of *Arbacia* which are "resistant" to fertilization late in the season also produce little secretion, but fertilize normally if secretion is added.

That the secretion has a dual nature is shown by the following facts:—(a) it reacts with both the sperm and the egg; (b) boiling destroys its value as a parthenogenetic agent, but not as an agglutinin; (c) perivisceral fluid of the same species inhibits autoparthenogenesis, but not agglutination.

The secretion is probably colloidal; it contains carbon and nitrogen, but gives no clear response to protein tests; there is indication of the presence of tyrosine, phenylalanine, or tryptophane. Two substances can be precipitated from the same secretion—a sperm agglutinin and a parthenogenetic agent. The agglutinin resembles an enzyme in the effect upon it of X-radiation. The parthenogenetic agent dissolves a fat

obtained from the eggs, and may contain a lipase. Hence it is provisionally called a lipolysin.

"It seems probable that the factors tending to produce development in the resting egg are of the nature of enzymes. The action of these, Jobling found, may be inhibited by unsaturated fatty acids. The egg remains in the resting stage so long as the action of these enzymes is inhibited by the unsaturated fatty acid. The egg itself, when mature and in a suitable medium, produces a lipolysin which binds this inhibitor. The efficiency of the inhibitor may also be reduced by physical and chemical means. In some groups, the spermatozoon appears to bind the inhibitor, in others to increase the activity of the enzymes." J. A. T.

Rhythmic Pulsation in Madreporic Vesicle of Young Ophiuroids.—JAMES F. GEMMILL (*Quart. Journ. Micr. Sci.*, 1919, **63**, 537-40, 1 fig.). In young Ophiuroids, probably *Ophioglypha albida*, at the stage of a flattened disc with five blunt arms each with five tentacles, there is a rhythmically pulsating madreporic thin-walled cavity entirely comparable to the madreporic vesicle of an *Asterias* larva. The pulsations are extremely regular, occurring once in every eleven or twelve seconds. It looks as if the essential part of the pulsation were the emptying and filling of spongy tissue to one side of the vesicle. The author goes on to discuss the axial organ (which he cannot regard as primarily a genital stolon), and to compare the hæmal systems of Enteropneusts and Echinoderms. J. A. T.

Bottom Material Ingested by Holothurians.—W. J. CROZIER (*Journ. Exper. Zool.*, 1919, **26**, 379-89, 2 charts). It has been found possible to obtain a fairly accurate idea of the rate of feeding in *Stichopus mæbii* Semper, and of the maximal contents of the gut in individuals of different sizes. In certain typical areas 6 to 7 kilos (dry weight) per square metre seem to pass through the intestine of the Holothurians frequenting the spot. It is estimated that in the enclosed "sink" of Harrington Sound the amount of bottom deposit annually eaten by *Stichopus* is perhaps 500 to 1000 tons. The fluid stomach contents are sufficiently acid to dissolve some calcium carbonate. The mutual attraction of particles in the intestine is probably of small significance for the formation of finely-divided particles. J. A. T.

Cœlentera.

Significance of Calyx in Alcyonacea.—ARVID R. MOLANDER (*Arkiv Zoologi*, 1918, **11**, No. 22, 1-12). The term calyx has been used loosely or ambiguously in reference to various types of Alcyonarians. According to the author, it should mean (in Alcyonacea) the well-defined basal region of the free or anthocodial portion of the polyp. Into such a calyx the upper portion of the polyp can be usually retracted, or it may also be that on the retraction of the upper portion into the cœnenchyma the calyx closes over it. The armature of the calyx agrees in the main with that of the stolons, the basal membranes, or the cortex of the colony. The spicules form eight longitudinal bands, and are in the main longitudinally disposed. According to Molander there

is a calyx in all genera of Alcyonidæ and Siphonogorgidæ. There is a calyx in *Clavularia* and in *Gersemia*, and probably in *Telesto* and *Scleranthelia*. But the calyx occurs in every degree of development, down to a hardly visible ring at the base of the anthocodia. It must be noted that Molander's conception of the calyx is different from that usually held.

J. A. T.

Membranous Forms of Colonies in Gorgonacea.—ARVID R. MOLANDER (*Arkiv Zoologi*, 11, No. 21, 1-19, 6 figs.). It sometimes happens that a normally erect Alcyonarian forms a puzzling membranous expansion. Thus, as Broch has shown, *Anthothela grandiflora* may form a spreading membrane and show no trace of axis. Molander maintains that *Anthelia borealis* and *A. fallax* are not Clavularids but Gorgonids. It is probable that they are two varieties of *Anthothela grandiflora*. In the same way—a rather upsetting way—Molander regards *Rhizoxenia alba* as a membranous form of *Gersemia fruticosa*. These are very interesting and important conclusions; we venture to suggest the need for proceeding cautiously with re-interpretations of this sort. J. A. T.

Irish Actiniaria.—T. A. STEPHENSON (*Proc. Roy. Irish Acad.*, 1918, 34, Section B, No. 7, 106-64, 7 pls.). An account is given, with much detail as to minute structure, of certain sea-anemones collected off Ireland by the Irish Fisheries Department. Among the notable forms is *Carlgrenia desiderata* g. et sp. n., which is of much systematic interest; *Cymbactis gossei* sp. n., a rather curious species; *Actinernus aurelia* sp. n., externally like a jellyfish, with enlarged bilobed oral disc and extreme reduction of the base; two new species of *Chondroactis*, with tough cartilaginous body-wall; and the variable *Actinauge richardi* Marion.

J. A. T.

Discussion of *Leptogorgia irramosa* (Grieg).—ARVID R. MOLANDER (*Arkiv Zoologi*, 1918, 12, No. 5, 1-7, 2 figs.). A fresh diagnosis is given of *Leptogorgia irramosa* (Grieg), an Alcyonarian that has borne various names, such as *Gorgonia pinnata* Ratke and *Pterogorgia pinnata* Grieg. There is little in the way of main stem; the branching is irregular; the polyps are irregularly disposed or alternate; there is usually a distinct verruca; the cœnenchyma contains long spindles and double stars; the polyp-body contains long spindles forming eight longitudinal double rows towards the base of the tentacles; the spicules are usually red or grey-white.

J. A. T.

Study of *Renilla*.—G. H. PARKER (*Journ. Exp. Zool.*, 1919, 27, 499-507, 1 fig.). In the interesting Pennatulid, *Renilla amethystina* Verrill, the autozooids exhibit spontaneous withdrawal and expansion with striking independence. The rhythmic contractions of the peduncle are mainly concerned in distending the colony as a whole. As Wilson showed, an enlarged siphonozooid serves as exhalant orifice, the other siphonozooids serving for entrance. The former communicates with the "superior canal" of the rachis and the peduncle; the "inferior canal" extends from the base of the peduncle to the rachis, where it communicates with the autozooids. The two systems of canals communicate with one another at the basal end of the peduncle, and there alone.

The autozooids, though very independent, are unified in a measure in their actions by the single organ for inflation, the rhythmically contracting peduncle, which thus serves the colony as a whole. In relation to the colony the peduncle is a "super-organ." The colony exhibits phosphorescence at night, but not merely by being taken during the day into darkness. The phosphorescence is localized in almost microscopic granulations on the surface of the rachis; it may be excited from any point by mechanical or faradic stimulation; there must be a nerve-net which controls and unifies the colonial luminosity. J. A. T.

Pigment of Hydroids.—ERNEST WARREN (*Annals Natal Museum*, 1919, 4, 103-35, 1 pl., 11 figs.). Many colonies of South African

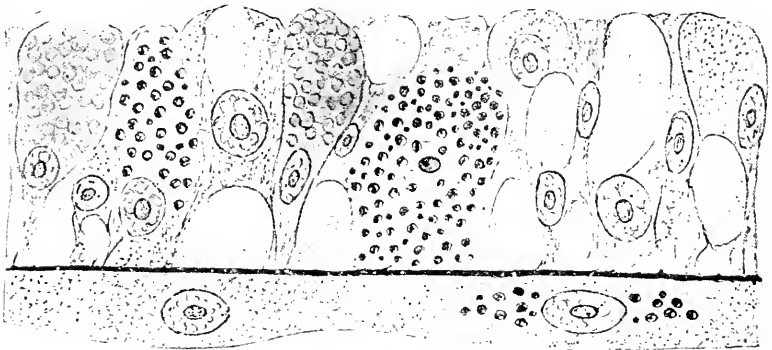

Two endoderm cells of *Lytocarpus filamentosus* and an ectoderm cell undergoing pigment-degeneration. $\times 1300$.

hydroids are black or very dark brown. This is due to cellular degeneration. Senescence is an undoubted factor; intense insolation seems operative deleteriously. The coloured granules appear to be of a

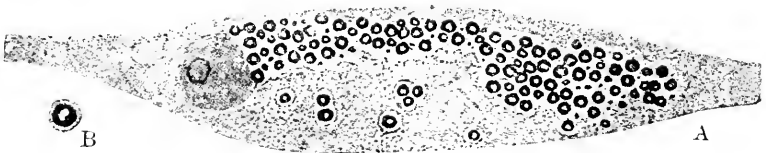

A. Ectoderm cell of *Lytocarpus filamentosus* undergoing pigment-degeneration. B. A single granule $\times 5000$.

protein nature, resulting from disturbed metabolism. The pigment degeneration is discussed in nine species, all, as it happens, calyptoblastic. The granules tend to assume characteristic shapes and aspects. The whole of the protoplasm may be transformed, or the degeneration changes may be confined to a particular portion of a cell. It is pointed out that in the case of the disease chloasma, different types of the

fragmentation of the skin are recognized, and that the conditions inducing these may be paralleled in the conditions of hydroids occurring in exposed rock-pools between the tide-marks of the tropics. "A closer study of the histology of the pigmented tissue resulting from disease in the higher animals would be of the greatest interest to compare with that of the blackened hydroids, and there is no doubt that observations on the pathology of simple organisms is capable of giving an important insight into the fundamental causes and effects of diseases as found in man and other mammals." J. A. T.

Structure of New South African Hydroid.—ERNEST WARREN (*Annals Natal Museum*, 1919, 4, 1-18, 2 pls.). A description is given of *Bimeria rigida* sp. n., peculiar (1) in the simple nature of the hydrocaulus; (2) in the great development of the perisarc over the hydranth, for it extends almost to the edge of the capitula of the elongated tentacles, and over the whole of the hypostome region; (3) in the presence of a small ectoderm-chamber above the mouth, almost of the nature of a stomodæum; and (4) in the termination of the tentacles in small, but perfectly distinct, capitula, with well-developed nematocysts. This form shows the extreme type of protection by perisarc production in the Gymnoblastea, and this apparently has not proved a great success, since the condition is rare or almost unique. Notwithstanding a kind of calyx, there is not necessarily a step towards the true calyx of Calyptoblastea, which is free from the body of the hydranth. J. A. T.

New Species of Sertularella.—ARMAND BILLARD (*Arch. Zool. Expér.*, 1918, 58, *Notes et Revue*, 1, 18-25, 3 figs.). From the *Siboga* collection nine new species of this Hydroid genus are described. J. A. T.

Cœlentera of Gunnerus.—HJALMAR BROCH (*K. Norske Vidensk. Selskabs Skrifter*, 1918, 4, 1-17, 1 pl., 5 figs.). A useful account is given of the Cœlentera described by Bishop Ernst Gunnerus between 1761 and 1768, including *Gorgonia resedæformis* (= *Primnoa resedæformis*), *Gorgonia flabelliformis* (= *Paramuricea placomus*), *Madrepora pertusa* (= *Lophohelia prolifera*), *Madrepora virginea* (= *Stylaster gemmascens*), and so on. His figures and descriptions were far ahead of his time. Broch declares in his Report on the Stylasteridæ of the Danish Ingolf Expedition that the drawings Gunnerus gave of *Stylaster gemmascens* "are the best which have ever been given of the species." J. A. T.

Species of Crawling Medusa from the Cape.—J. D. F. GILCHRIST (*Quart. Journ. Micr. Sci.*, 1919, 63, 509-29, 1 pl.). A description is given of *Cnidonema capensis* g. et sp. n., which is found in fair abundance at certain times and places at the Cape of Good Hope. The young form is usually very active, exhibiting crawling or walking movements by means of its tentacles. The older and mature individuals remain for the most part stationary. The tentacles have a strong adhesive power, and apart from their walking movements show a sudden jerking upwards. The mouth is moved slowly over the substratum, but the tentacles may

hold a small animal until the manubrium is extended beyond the margin of the umbrella and applied to the object. No swimming was observed. The genus is distinguished from *Eleutheria* and from *Cladonema*, and the following outstanding features are noted: The medusa is adapted for crawling or walking; there is no brood pouch above the stomach; the gonads are well developed and lie in ectodermal inter-radial pockets around the stomach; the sexes are separate; the radial canals are usually six; the tentacles are numerous, increasing with age, not corresponding to the number of radial canals, the upper branch with several clusters of nematocysts in addition to a terminal cluster; there are no oral tentacles; there is a thick nematocyst ring under the margin of the bell; the hydroid has one verticil of three capitate tentacles, and a second verticil of six non-capitate tentacles; the hydroid form is very similar to that of *Cladonema* (*Stauridia*), not to that of *Eleutheria* (*Clavatella*). J. A. T.

Porifera.

Study of Fresh-water Sponges.—A. VAN TRIGT (*Leiden*, 1919, 15 pp., 6 pls.). This study is based on grass-green and colourless forms of *Spongilla lacustris* and *Ephydatia fluviatilis*, two kinds readily distinguished by the pungent smell of the former. The sponge owes its

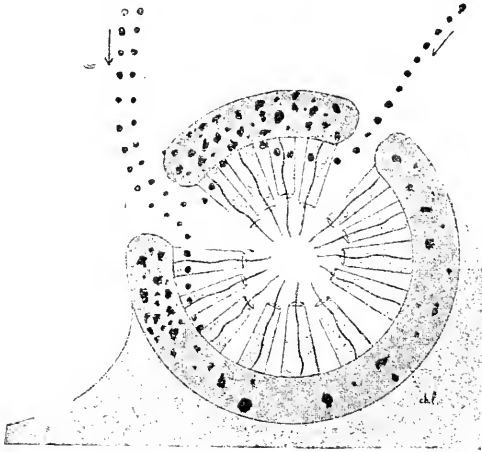

Capture of food particles by cells of choanocyte layer.

green colour to numerous green corpuscles present in the cells, especially in the amoebocytes. They produce oxygen and exhibit photosynthesis in the light; they show a cell-wall, protoplasm, a chloroplast, and perhaps a nucleus; they contain oil-drops, but no carbohydrates; they can live for six months or longer isolated from the sponge, and they can multiply after isolation; they also occur free in the water. It may be safely concluded that they are symbiotic Algae. They multiply by the division of the whole cell, and are nearer to *Pleurococcus* than to *Chlorella*.

There are similar colourless stages ; these never become green ; they seem to be dead. Except in finding some protection the Algæ are not benefited by their association with the sponge, and the protection is

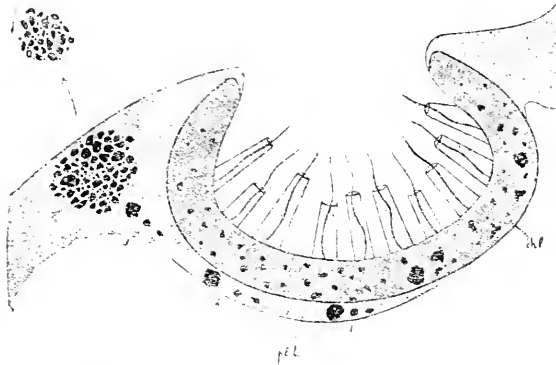

Particles in layer of circulating protoplasm lying against the base of the choanocytes on the side of the incurrent canal.

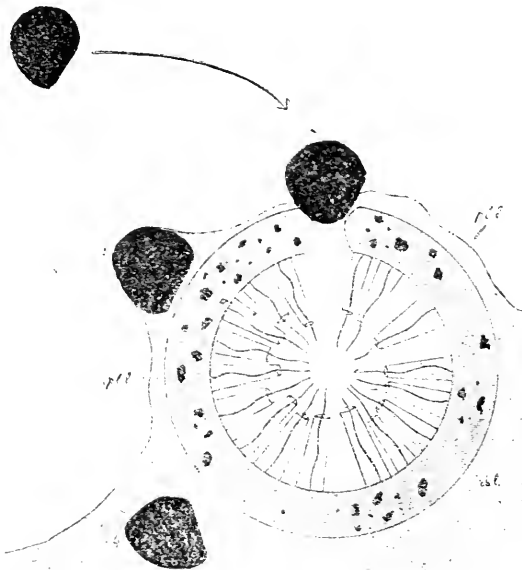

Capture of a coarse food particle by means of the layer of streaming plasma.

limited, for the sponge is always destroying them. To the sponge they afford useful food, being digested in the amœbocytes. The significance of the oxygen produced by the green Algæ does not seem to be great. In the spiral movement of the flagellum of a choanocyte there is a very

rapid succession of waves of small amplitude passing along the flagellum from the base to the top. The smaller food particles are captured by choanocytes and passed on to the amœbocytes; the coarse ones stick in or against the prosopyles, and are taken into the adjacent thin layer of apparently undifferentiated fluent protoplasm. Defecation (and perhaps excretion) takes place by means of vacuoles in amœboid cells along the walls of the excurrent canals, and it may be on the surface as well. The mesogloea is not undifferentiated plasma; it consists entirely of amœboid cells.

J. A. T.

Protozoa.

Axial Rotation of Aquatic Micro-organisms.—L. B. WALTON (*Amer. Naturalist*, 1918, 52, 521-46, 5 figs.). In the progressive swimming movement of most aquatic micro-organisms there is a characteristic axial rotation. Jennings has called attention to the value that such a

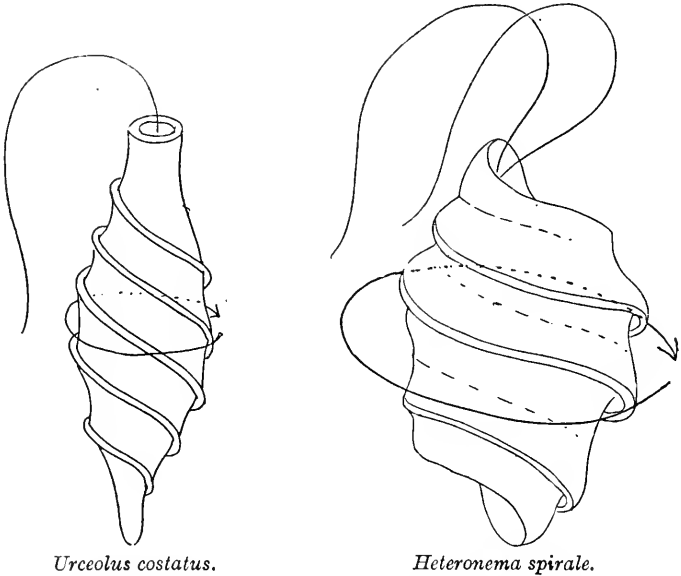

Flagellate forms from the Northern Hemisphere, illustrating the development of the left-hand striae.

compensatory motion may have for the organism in which it exists. Walton points out that an oblique striation forward and to the left is in Flagellates from the Northern Hemisphere associated with an axial rotation from right over to left, so-called "clock-wise." Forms with a reverse striation seem to be absent from the Northern Hemisphere, although such forms occurred in the Southern Hemisphere. As Euglenoids and the like are in general positively phototactic the rotation may

be correlated with the turning of the earth on its axis, with the resultant apparent motion of the sun from east to west. Negatively phototactic micro-organisms of the Northern Hemisphere rotate as a rule in counter-clockwise direction. The author asks how the origin of the characteristic rotation is to be accounted for, and his idea is that the sun has directly induced in the flagellum an east-west rotary-like or whip-like propelling movement. Experimental attempts to reverse or slow up the rotation have not as yet yielded any result, but the author pleads for a consideration of the idea that characters of a physiological nature may be produced by environmental causes. Morphological characters, such as striæ, may arise in a similar manner, or through selection. By correlation with the physiological characters, a cumulative and irreversible effect is produced.

J. A. T.

British Fresh-water Rhizopods.—G. H. WAILES (*Ray Society*, 1919, 4, xii + 130, pls. 58-63, figs. 161-75). When the third volume of this monograph was issued fifty genera had been described; now by the addition of *Pyxidula*, *Capsellina*, *Diplochlamys*, *Microcorycia*, *Bullinula*, *Cucurbitella*, *Acerintzia*, *Parmulina*, and *Plagiophrys*, and the omission of *Ouramæba*, the number is increased to fifty-eight. The volume deals with the families Lobosa, Reticulosa, Vampyrellida, representing the order Amœbina, and with the families Arcellida, Euglyphina, Gromiina, and Amphistomina, representing the order Conchulina. A fine bibliographical section has been contributed by Mr. John Hopkinson.

J. A. T.

Crystalloids of Entamœba.—ARMAND DEHORNE (*Arch. Zool. Expér., Notes et Revue*, 1919, 58, 11-18, 4 figs.). In the amœba (*Entamœba dysentericæ*) which causes liver abscesses in man, crystalloids are formed in the vacuoles of the endoplasm. They last only for a short time, being much reduced or having disappeared when the cyst envelope is completed. In fact the production of the crystalloids may be regarded as a stage in the formation of the cyst envelope. Perhaps the same is true of the trichocysts in Infusorians. In general terms, the crystalloids are chromidial in character, and every chromidial apparatus has to do with shell-making, whether for isolation or protection.

J. A. T.

Reversion of Orientation to Light in Spondylomorom quaternarum.—S. O. MAST (*Journ. Exper. Zool.*, 1918, 26, 503-20). This colonial Flagellate of sixteen cells is negative in its relation to light under certain conditions, and positive in others. Reduction in alkalinity, increase in anaesthetics, increase in temperature, and decrease in illumination, all have the same effect on orientation, making negative specimens to become positive. The reversion is probably due to some specific change in the physiological processes of the organism. What these processes are is not known. They may involve electrical tension and polarization, or permeability or absorption. Reversion depends upon the time-rate of change in the concentration or intensity of the effective factors in the environment, but it has not been demonstrated that it depends on the time-rate of change in the physiological processes which are involved in reversion.

J. A. T.

Remarkable Flagellate from Hind-gut of Termite.—D. WARD CUTLER (*Quart. Journ. Micr. Sci.*, 1919, **63**, 555–88, 9 pls., 3 figs.). A description is given of *Ditrichomonas (Trichomonas) termitis* g. et. sp. n., from the hind-gut of *Archotermopsis wroughtoni*, an Indian termite. At the anterior end there are two free flagella springing from a blepharoplast, and a posteriorly-directed one forming the border of the undulating membrane and arising from a special granule. There is a cytostome. An axostyle runs through the whole length and emerges at the posterior end. An elongate parabasal body with a central thread springs from the blepharoplast. Multiplication by simple division was observed. There is division of the blepharoplast, of the membrane-granule, probably of the parabasal body, and probably of the axostyle.

J. A. T.

Ciliata from Intestine of the Gondi.—EDOUARD CHATTON and CH. PÉRARD (*Bull. Soc. Zool. France*, 1919, **44**, 10–17). In the cæcum and colon of *Ctenodactylus gundi*, a rodent of the Sahara borders and Southern Tunisia, the investigators found immense numbers of two new Ciliata, *Nicolella ctenodactyli* g. et sp. n., and *Colinella gondii* g. et sp. n. The first form shows a very large contractile vacuole at the posterior pole; a sub-median mouth; three zones in the ectoplasm; a vacuolated endoplasm; a micronucleus more or less embedded in the macronucleus. It multiplies by oblique sub-transverse division. Conjugation was studied. In the second form the mouth is posterior, and so is the contractile vacuole, otherwise there is close resemblance between the two genera. They seem to require a new family, Nicollellidæ.

J. A. T.



BOTANY.

GENERAL,

Including the Anatomy and Physiology of Seed Plants.

Structure and Development.

Vegetative.

Significance and History of Pine-needles.—J. DUFRENOY (*Bot. Gaz.*, 1918, 66, 439-54, 29 figs., 1 table) has studied pine-needles in order to throw light upon their morphological significance. The present work includes a brief account of their development, histology, physiology, and pathology, and the writer concludes that morphological variations are the result of physiological variations. The wide differences seen in the phyllodes, juvenile leaves, scale-leaves, fertile leaves, and assimilatory organs are shown to be different features "of a unique ancestral organ," resembling the gametophyte of ferns in possessing the three-fold function of reproduction, assimilation, and protection. The phyllodes of primitive coniferous trees were probably all fertile, but owing to unfavourable ecological conditions some of them became sterile. In support of this hypothesis reference is made to *Pinus maritima*, where parts of the male flowers which have been exposed to a strong sea-wind became sterile, and scales take the place of stamens. Studies of intermediate and abnormal leaf-forms show the process of development to be as follows:—

Primitive organ	{	Fertile (reproduction)	{ ♂ fertile leaf.
			{ ♀ " "
		Green (assimilation)	→ juvenile leaf—short needle.
		Storage of reserves	→ cotyledonary needle.
		Self-protecting	→ scale.

Thus needles are the physiological leaves of pines, differing from ordinary leaves in being perennial and less fragile; they last several seasons and are adapted to the roughest weather and the most adverse ecological conditions. S. G.

Significance of Resinous Tracheids.—S. J. RECORD (*Bot. Gaz.*, 1918, 66, 61-7, 5 figs.) publishes the result of his investigations as to the significance of the resinous tracheids previously described by Penhallow. The "peculiar form" and "particular location" upon which the latter laid such stress are readily understood in view of their origin. The close association of the resin-plates with the medullary rays indicates the origin of the resin, which is an excretion resulting from the metabolic processes of the parenchyma cells; such excretion is most abundant when the cells are about to cease their vital functions and become

heartwood, or when severely wounded. The writer does not agree with Penhallow in regarding the Cordaitales as peculiar among the Gymnosperms in this respect, but claims that similar structures are found in *Pinus*, *Picea*, *Larix*, and *Pseudotsuga*, and other Gymnosperms, also in eleven genera of the Anarcadiaceæ, and in two of the Araliaceæ. He concludes that "resinous tracheids in Gymnosperms find numerous parallels in the Angiosperms, that they represent one form of reservoir for excretions, and that the form of the resin-masses is in response to well-known physical laws." These structures somewhat resemble tyloses, and reduce the permeability of the wood. In a few cases—e.g. in *Pinus albicaulis*—they appear to have a certain value as a diagnostic feature. S. G.

Flower and Fruit of *Diaperia*.—J. BRIQUET (*Compt. Rend. Soc. Phys. et d'Hist. Nat. (Geneva)*, 1918, 35, 76–81) has studied the morphology and biology of the flowers and fruit of *D. prolifera*, with special reference to the bracts surrounding the central flowers. The paleal horns enclosing these flowers appear to throw light upon the probable origin of the so-called pseudocarpic bracts. Before taking on the functions of a pericarp, the bracts of this species serve as a protection for the flower, not by undergoing any great structural alterations, but by simply folding themselves round the flower in the form of a horn. The functions of a perianth are made still more evident by the woolly hairs of the central part of the capitulum being hooked together in such a manner as to form with the bracts a simple structure in which the bees must work somewhat laboriously to find the tiny corollas. Other new facts noted in the present work are the orientation of the plan of symmetry of the ovaries; the presence of numerous myxogenous hairs on the epicarp of the achenes; the absence of fibro-vascular bundles in the corolla of the female flower, and their presence in the corolla-tube, but not in the lobes of the bisexual flowers. *D. multicaulis* differs from *D. prolifera* in having sessile ovaries in the bisexual flowers, and in the absence of the horn-like structure formed by the hairs and bracts; these differences being merely specific, the two species appear to form a natural group. The author considers that there is not sufficient ground for uniting this genus with *Evax*, as proposed by Gray, but suggests the need for a detailed study of the morphology of the Filagineæ. S. G.

Interrelationships of the Taxineæ.—M. C. BLISS (*Bot. Gaz.*, 1918, 66, 54–60, 2 pls.) has studied the root and stem of *Cephalotaxus*, *Torreya* and *Taxus*, with special reference to the classification and relationship of the Taxineæ. Owing to want of material it was not possible to study the process of recapitulation in the embryo and seedling, but retention of ancestral characters was clearly visible in the root and stem, especially in *Taxus*. The abundance of resin-parenchyma in the root and stem of *Cephalotaxus* proves the close connexion of this genus with the Podocarpineæ, while the smaller amount in the stem of *Torreya* points to the intermediate position of this genus. The resin-parenchyma in the root of *Taxus cuspidata* and *T. baccata*, and also in the wounded stem of the latter, is evidently an ancestral feature, while its entire absence in the normal stem of *T. brevifolia* points to the more

modern origin of this species. The writer concludes that the "Taxineæ represent a modern group of conifers, as shown by the gradual reduction and final passing out of resin-parenchyma in the more progressive organs."

S. G.

General.

Relative Number of Male and Female Plants in Rumex.—C. RAUNKJÆR (*Kgl. Danske Vidensk. Selskab. Biol. Medd.*, 1918, 1, 7, 1-17, 7 tables) publishes the results of further investigations as to the relative number of male and female plants in *Rumex*. A previous paper dealt with observations made in connexion with *R. acetosa*, while the present work deals with *R. thyrsiflorus*. In this species the percentage of female plants is considerably higher than that of male plants, and usually varies between 70 and 95 p.c. This difference is partly accounted for by the inclusion in the species of a primary species or race which gives rise to races which are relatively poor in female plants, or vice versa; so that it is not unusual for the offspring to vary considerably from the parent-plant in this respect. When the female plants are more abundant the male plants are relatively late in flowering. Fertilization within this primary species appears to have poorer results than when different stocks are crossed.

S. G.

CRYPTOGAMS.

Pteridophyta.

Apospory in Pteris sulcata L.—W. N. STEIL (*Bot. Gaz.*, 1919, 67, 469-82, 2 pls.). A brief recapitulation of previous work on Apospory, followed by an account of the author's own investigations, which give the following results:—The gametophyte of *Pteris sulcata* arises normally from a spore, and the embryo sporophyte is of apogamous origin. But under certain conditions the gametophyte was produced aposporously. The gametophytes were formed in connexion with the lamina or petiole of the primary leaf, the line of demarcation being sharply drawn between the cells of the gametophyte and the sporophyte. The prothallial portions developed antheridia, secondary prothallia, and in one case a sporophyte-like outgrowth. The antherozoids were actively motile and normal in appearance. Occasionally forms intermediate in character between gametophyte and sporophyte were formed. The origin of the aposporously produced gametophyte may probably be traced to an early stage in the development of the embryo. Since the embryo, on account of its apogamous origin, is intimately connected with the prothallium, it is not impossible that in some way cells of the prothallium may be embodied in the developing embryo. These cells, retaining the power to divide, may produce such outgrowths as described in the paper.

A. G.

Protomarattia, a New Genus of Marattiaceæ, and Archangiopteris.—BUNZO HAYATA (*Bot. Gaz.*, 1919, 67, 84-92, 1 pl., 3 figs.). A description of a new fern-genus, *Protomarattia*, with one species, *P. tonkinensis*, found by the author on Mt. Tamdao in the centre

of Tonkin in 1917. It is very rare and grows among ferns of similar habit. Closely related to *Marattia*, it differs from that genus by having a linear (not oval) synangium containing far more numerous loculi, a frond which is simply pinnate, and a creeping dorsiventral rhizome. From *Archangiopteris* it differs in having a synangium. To the genus *Archangiopteris* the author adds two new Tonkinese species—*A. subintegra* and *A. tamlaensis*—both rare and difficult to detect. This genus was first described in 1899, from a plant discovered in Yunnan, *A. Henryi*; and a second species, *A. Somai*, was found in Formosa in 1915. Thus four species of this primitive Marattiaceous genus are now known.

A. G.

Genus *Tænitis*, with some Notes on the remaining *Tænitidinae*.—ELIZABETH J. LEONARD (*Scientific Proceedings of the Royal Dublin Society*, 1918, 15, 255-72, 1 pl. and figs.). An account of the structure and phylogeny of *Tænitis blechnoides*, *Eschatogramme furcata*, two species of *Drymoglossum*, *Paltonium lanceolatum*, and *Hymenolepis spicata*. The conclusion arrived at is that these genera are all Blechnoid derivatives, with the possible reservation of *Paltonium*. The nearest genera to the true Blechnoids would be *Tænitis* and *Eschatogramme*. The rest have diverged more widely in relation to their epiphytic habit, which more or less obscures their Blechnoid affinity; yet they are all properly to be regarded as offshoots of the Blechnoid series, characterized by the fusion-sorus of intra-marginal position.

A. G.

Collections of Madagascar Ferns.—H. V. ROSENDAHL (*Arkiv för Botanik*, 1917, 14, No. 23, 11 pp.). An account of two collections of ferns made in Madagascar by Dr. W. A. Kaudern in 1911-12, and Drs. K. Afzelius and B. T. Palm (Swedish Madagascar Expedition), 1912-13. The districts visited are described, and are indicated on a chart. A list is given of the 90 species collected, and a distribution table is appended.

A. G.

Species and Forms of *Equisetum* in Sweden.—H. V. ROSENDAHL (*Arkiv för Botanik*, 1917, 15, No. 3, 52 pp., 27 figs.). A systematic account of the forms of *Equisetum* found in Sweden. Six species and one hybrid belong to the section Phaneropora, and four to Cryptopora. The varieties, sub-varieties and forms are all classified, several being new to science. Numerous figures of habit, structure, etc., are supplied.

A. G.

Allies of *Selaginella rupestris* in S.E. United States.—G. P. VAN ESELTINE (*Contrib. U. S. National Herbarium*, 1918, 20, part 5, 160-72, 8 pls. and figs.). An analysis of the group of forms allied to *Selaginella rupestris*, and growing in the south-east of the United States. Underwood and Hieronymus have already paid attention to the group. But the present author, having studied much herbarium material, has found two more new species to describe. He treats of eight species in all, and amplifies their descriptions where necessary, giving photographs and text-figures, and providing a key based upon the megasporangia, stems, leaves and their cilia.

A. G.

Bryophyta.

Morphological Study of *Pallavicinia Lyellii*.—ARTHUR W. HAUPT (*Bot. Gaz.*, 1918, **66**, 524-32, 5 pls.). This species belongs to the sub-genus *Eupallavicinia*, its vegetative body consisting of a single prostrate portion. The apical cell is of the dolabrate type. Branching is both apical and adventitious. The species is dioecious, as usual in the genus. The antheridia are situated in two parallel rows on each side of the midrib, and are protected from behind by an involucrel upgrowth. Their development, with minor variations, follows the type for the anacrogynous Jungermanniales. The archegonia are in dorsal groups, and are surrounded by an involucre and a perianth, the latter remaining inconspicuous until after fertilization. The young archegonial stalk consists of two cells. The egg is small, and the neck long and twisted. The lower half of the fertilized egg becomes a haustorial organ and contributes nothing to the development of the foot, seta, or capsule. The calyptra is four or five cells in thickness, in this respect differing from that of *Symphyogyna*. The differentiation of the spores and elaters occurs relatively late in the development of the sporophyte, and follows the method of *Symphyogyna*. A sterile cap is present at the apex of the capsule, and remains intact in dehiscence, which is accomplished by means of four longitudinal slits. A. G.

Taxonomic Study of *Dumortiera*.—ALEXANDER W. EVANS (*Bull. Torrey Bot. Club*, 1919, **46**, 167-82). A history of the genus *Dumortiera*, a critical study of the species that have at various times been referred to it, and a detailed discussion of the characters adopted by different authors for discriminating the species. Evans shows that the characters drawn from the size and ramification of the thallus are especially untrustworthy, and that those based on the female receptacle and the spores are scarcely more satisfactory. On the other hand, he finds that the structural features of the vegetative thallus afford characters which clearly distinguish the only two species that deserve to be maintained—viz. *D. hirsuta*, with a smooth upper thalline surface; and *D. nepalensis*, with crowded papilliform cells on the upper thalline surface, and always showing vestigial air-chambers. *D. hirsuta* has a very wide geographical distribution, mostly tropical. *D. nepalensis* is absent from Europe and Africa, but otherwise has a similar range, but is more abundant in South-east Asia. A. G.

American Species of *Marchantia*.—ALEXANDER W. EVANS (*Trans. Connecticut Acad. Arts and Sciences*, 1917, **21**, 201-313, figs.). A revised monograph of the species of *Marchantia* recorded from North and South America. Gottsche, Lindenbergh and Ness, in their *Synopsis Hepaticarum* (1847), recognized sixteen such species, and Stephani in his *Species Hepaticarum* (1899) gave a total of eighteen. The present careful revision reduces them to nine, grouped in two sections:—(1) *Astromarchantia*, including *M. polymorpha*, *M. plicata*, *M. Berteroana*; (2) *Chlamidium*, including *M. paleacea*, *M. breviloba* (a new species from Jamaica), *M. domingensis*, *M. papillata*, *M. Bescherellei*, *M. chenopoda*. Each species is described, figured and discussed, and a chapter is

devoted to the morphology of the genus, under the headings—Epidermis and epidermal pores, Compact ventral tissue, Ventral scales, Rhizoids, Receptacles, Sporophyte, Cupules. A. G.

Noteworthy Lejeuneæ from Florida.—ALEXANDER W. EVANS (*American Journ. of Botany*, 1918, 5, 131–50, figs.). Descriptions of the following new species:—*Cololejeunea contractiloba*, *Lejeunea cladogyna*, *Euosmolejeunea parvula*, *Ptychocoleus heterophyllus*, with critical notes on these and other species. A. G.

Notes on New England Hepaticæ. XIII.—ALEXANDER W. EVANS (*Rhodora*, 1916, 18, 74–85, 103–120, 1 pl. and figs.). A discussion of the specific values of *Scapania Oakesii* Aust. and *S. paludicola* Loeske and K. Müll.; of certain little-known structural characteristics of *Porella pinnata* L., with some remarks upon its synonyms; also a critical comparison of *P. platyphylla* (L.) Lindb., *P. platyphyllouidea* (Schwein.) Lind., *P. rivularis* (Nees) Trevis. (*Madrothea Cordæana* (Hüb.) Dumort.), and their allies. A. G.

Hepaticæ of St. Croix, St. Jan, St. Thomas, and Tortola.—ALEXANDER W. EVANS (*Brooklyn Bot. Garden Memoirs*, 1918, 1, 104–9). An enumeration of twenty-one species collected in 1913, together with notes on the only seven species that had previously been recorded. A. G.

Illustrated Key to the Western Sphagnaceæ.—T. C. FRYE (*Bryologist*, 1918, 21, 37–48). An artificial key intended to facilitate the identification of the species of *Sphagnum* found in the western States of North America. It is abundantly supplied with figures to illustrate the points of structure selected for discriminating the species. A. G.

Acidity of Sphagnum and its Relation to Chalk and Mineral Salts.—M. SKENE (*Ann. of Bot.*, 1915, 29, 65–87). An account of previous work and of the author's own investigations on the varying resistance of different species of *Sphagnum* to mineral solutions. As to the localization of the acid compounds, the view is confirmed that colloids in the cell-walls, rather than the living contents, are mainly concerned. Species in poor habitats require the highest acidity to obtain the necessary amount of bases. The different species vary in acidity and in sensitiveness to chalk. Sphagna thrive in acid solutions; and it is the alkalinity of chalk and alkalis that is injurious; mineral solutions are generally harmless. Sphagna utilize the bases held absorbed by the cell-walls. A. G.

Sphagna and Mosses of Thuringen.—J. ROELL (*Hedwigia*, 1915, 56, 1–176, 177–287, 1 table; see also *Bot. Centralblatt*, 1915, 128, 679–80). An exhaustive account of the bryological flora of Thüringen. The introduction describes the historic development of the moss system and the share of the author in it, with a justification of his views of nomenclature, and arguments against varieties based on colour. His views in the polemic with C. Warnstorf are defended. In the special

systematic treatment which follows, the Sphagna occupy a large part; fifty-five species and sub-species are recognized for the European flora, of which fifty are recorded for Thüringen. A synopsis and keys and critical notes are given for the Sphagna, as also for the mosses. Among the latter the genus *Oreoweisia* is discussed, as well as the relations between *Dicranum Schraderi* and *D. spurium*, *Weisia viridula* and *W. rutilans*, etc. The groups respectively of *Didymodon cordatus*, *D. rigidulus*, and *D. spadiceus* are presented in detail, and their relationship is discussed. The memoir is an important one to bryology, and represents the summing up of several decades of careful study. E. S. G.

Vegetative Increase of *Pterigynandrum filiforme* (Timm) Hedw.—C. WARNSTORF (*Hedwigia*, 1914, 55, 378-80; see also *Bot. Centralbl.*, 1915, 128, 680-1). An addition to the author's communications on brood-branchlets and brood-bodies in *Pterigynandrum filiforme*, already published in the "Kryptogamen-flora der Mark Brandenburg." The brood-branchlets, whose significance is still rather in doubt, were only seen once in a Norwegian plant; while, on the other hand, plants with brood-bodies have been observed by him from six localities. The brood-bodies, which are figured, are borne on stalks, and arise at the apex of short branched pedicels which occur in bunches in the leaf-axils. The brood-bodies are elongate oval to short clavate, almost always with one to three transverse walls; when ripe, brown with hyaline basal cell. Dispersal follows easily by fracture. They are on an average 33-60 μ long and 16-20 μ broad. Stages of germination were not observed. The plants were collected in the Sudenten, Mecklenburg, and the Middle European Alps. Plants bearing brood-bodies had however been previously recorded from England and Saxony. E. S. G.

Histology of *Ephemeropsis tjibodensis* Goebel.—I. GYÖRFFY (*Bot. Múz. Füzetek.*, 1916, 2, 1, 20-32, 2 pls.; see also *Bot. Centralbl.*, 1917, 135, 206). An amplified description of this remarkable moss, with special attention to the shape of the capsule, the operculum, the epidermis of the theca, the peristome-teeth (the genus belongs to the Diplolepidæ), the stomata and respiratory apophysis, and the seta. The air-chamber of part of the neck of the capsule is lightly pervaded with the looser cells of the spongy parenchyma, which points to a highly developed transpiration of the sporophyte. E. S. G.

Moseniella: a New Moss Genus from Brazil.—V. F. BROTHERUS (*Arkiv för Botanik*, 1917, 15, No. 7, 3 pp., 1 pl.). Description and figures of the structure of *Moseniella brasiliensis*, a new moss collected by H. Mosén in the province of Minas Geraés in 1873. It is a Splachnaceous genus, nearly allied to *Orthodon*, but differing in the structure of its sporogonium, and much resembling some species of *Physcomitrium* in habit. A. G.

***Bryum vermigerum*.**—H. W. ARNELL and C. JENSEN (*Bot. Notiser*, 1916, 129-32, 1 pl.). A description of a new species, *Bryum (Eubryum) vermigerum*, discovered at Finse in Hardanger, Norway about 1300 m. above sea level, by G. Samuelsson. In size and general habit it resembles

B. Blindii, but it is distinguished by the occurrence of brood-bodies, a quite different form of fruit, very concave leaves with looser areolation, etc. The Latin name refers to the worm-like brood-bodies. E. S. G.

Revision of the North American Species of Encalypta.—DOROTHY COKER (*Bull. Torrey Bot. Club*, 1918, **45**, 433–49, 2 pls.). An account of the genus *Encalypta*, with descriptions of the species, and figures of their essential characters. As a result of careful comparison of original and authentic specimens it has been found possible to reduce to eight the eighteen species that have been recorded for North America; and a key for their ready determination is provided. A. G.

Two Cleistocarpic Mosses of the Bolivian High Cordilleras.—T. HERZOG (*Flora, N. F.*, 1914, **7**, 317–26, 5 figs.; see also *Bot. Centralbl.*, 1915, **128**, 499). The author begins by criticizing cleistocarpy as a character in systematic grouping, and describing the views of various authors on the subject. He shows the unreliability of the character, and quotes as instances the intermediate position of *Mildeella bryoides*, the cleistocarpous forms of *Ditrichum*; and also such forms as *Physcomitrella Hampei*, which are sometimes regarded as bastards, sometimes as arrested forms, but which in both cases merely obliterate the boundaries between cleistocarpous and stegocarpous mosses. Having proved the worthlessness of cleistocarpy as a systematic character for families, the author goes on to prove it equally worthless in dividing genera. He finds among the Cordillera mosses two cases in which plants agree in all the important generic characters, but differ in having cleistocarpous and stegocarpous sporogonia. The one case is the cleistocarpous *Tristichium Lorentzii* C. Müller and *Tristichiopsis mirabilis* of the same author. A complete series of forms was found, connecting these two species, and the author gives his reasons for retaining the two as species but in one genus. He regards the cleistocarpous form as a species either in the making or already fixed. The second case is *Conostomum æquinoctiale* and *C. cleistocarpum*, the latter being the only wholly cleistocarpous Bartramiacean moss hitherto known. The close relationship of these two species is shown; and the author concludes with the words: "In any case we have here two cleistocarpous species whose origin from stegocarpous species can no longer be doubted." E. S. G.

Moss Distribution in Sweden.—H. MÖLLER (*Arkiv för Botanik*, 1917, **15**, No. 2, 108 pp.). This is the fourth section of the author's study of the Swedish moss-flora, and it treats of the Leskeaceæ and Pterogoniaceæ, species by species, at considerable length. A new variety of *Anomodon longifolius* is described. A. G.

Mosses of the "Vega" Expedition.—H. W. ARNELL (*Arkiv för Botanik*, 1917, **15**, No. 5, 111 pp.). An account of the bryophytes of the "Vega" Expedition of 1878–80, collected by F. R. Kjellman on the north and east coasts of Asia, the principal regions being as follows:—Novaja-Zemlja, the Siberian Arctic coast, Behring Strait (Siberian east coast and coast of Alaska). With the results are incorporated those of the earlier Swedish Expedition of 1875. The various collecting-grounds

and their local floras are first described in detail ; and then a systematic account of the species follows, comprising 59 hepatics, 12 sphagna, 173 mosses. There are five new species of *Bryum*, and five new varieties, and much critical work, especially on the Harpidiaceous species of *Amblystegium*. A. G.

Uganda Mosses.—H. N. DIXON (*Smithsonian Miscellaneous Collections*, 1918, 69, No. 8, 10 pp., 1 pl.). An account of the mosses in Uganda by R. Dümmer and others, twenty-seven species in all, including eight which are new to science. The most interesting of these is *Cyathophorum africanum*, an eastern genus hitherto unknown to Africa. All the novelties are figured. A. G.

Mosses and Ferns from the Pacific.—K. RECHINGER (*Denkschr. Akad. Wiss. Wien*, 1914, 89, 441-50 ; see also *Bot. Centralbl.*, 1915, 128, 536). An account of the mosses gathered in Hawaii and Solomon Islands determined by V. F. Brotherus : and of the ferns from the New Guinea Archipelago. Several new species are described. A. G.

Contributions to the Moss-flora of the Argentine.—V. F. BROTHERUS (*Arkiv för Botanik*, 1917, 15, No. 6, 15 pp.). An account of the mosses collected by R. E. Fries in the province of Jujuy, Argentine, and in Gran Chaco, Bolivia, during the Swedish Expedition of 1901-2. The climate was dry, and the total number of species collected was forty-six, among them being twelve new species, one of which, a *Desmatodon*, is of special interest, since no species of that genus had ever been found south of the equator. A. G.

Thallophyta.

Algæ.

Axial Rotation of Aquatic Micro-organisms and its Significance.—L. B. WALTON (*Ohio Journ. of Science*, 1917, 18, 6-7). A short note on the result of studies during two years on this subject. In general, the conclusion of the author is that the positively phototactic free swimming forms of the northern hemisphere rotate clockwise, assuming the observer in front of the advancing organism, and the negatively phototactic forms counter-clockwise, while in the southern hemisphere there are reverse conditions. The apparent exceptions thus far noted have been found closely allied to northern forms, and may have been introduced subsequent to the origin of the southern forms. Evidence is accumulating that this characteristic has been gradually impressed upon the organisms through the rotation of the earth and the apparent path of the sun from east to west. Natural selection, electrical conditions, and other theories do not explain the phenomenon. Experimental attempts to reverse, or to diminish the rapidity of the rotation of the organisms have failed. The author suggests the need of studying the behaviour of micro-organisms near the equator, as well as in the southern hemisphere. E. S. G.

Undulating Marginal Cilia in a Green Flagellate.—A. PASCHER (*Archiv Protistenkunde*, 1916, **37**, 191-7, 8 text-figs.; see also *Bot. Centralbl.*, 1917, **135**, 259-60). The flagellate in question represents a new genus and species, occurring in the North Sea, *Ulochloris oscillans*. It is 8-11 μ long, resembling in form a compressed *Chlamydomonas*; chromatophore large, pyrenoid wanting, margins delicate, with two cilia, of which one is free. One free cilium each on the back and front; but in the case of the pairs on the narrow sides, each cilium is connected with the narrow side by a narrow margin, and is only free at the end. The movement is remarkable: the monad swims as easily backwards as forwards, and it can progress in jerks. Reproduction is by longitudinal division. By the dorsiventral flattening and the peculiar differentiation of the cilia into pairs, the new genus assumed a peculiar development among the Polyblepharidineæ. The origin of the flat discoid chromatophores from the bowl-shaped type of the Chlamydomonads is shown, with figures.

E. S. G.

Noctiluca miliaris Sur.: A Cytological Investigation.—A. J. C. VAN GOOR (*Diss. Amsterdam. Amst. 't Kasteel v. Aemstel*, 1917, 124; see also *Bot. Centralbl.*, 1917, **135**, 194-6). The author gives a detailed account of his investigation of the cytology of *Noctiluca miliaris* Sur., which he considers to be of plant nature. He describes methods of treatment, the minute structure of the organism and processes of reproduction. He believes that if the nuclei of the Dinoflagellates should prove to be polyenergid, this would apply also to the nuclei of *Noctiluca*.

E. S. G.

Diatom-Flora of Martin Beck, Yorks.—M. H. STILES (*The Naturalist*, 1918, 281-3). This paper is part of the result of an investigation by the Doncaster Scientific Society of the natural history of Martin Beck, between Bawtry and Tickhill, and presents a fairly complete record of the Diatom flora of the district. Of the 106 species and varieties, 23 are not included in West's "Alga-Flora of Yorkshire," and 40 have not been previously recorded for that division of the West Riding. The most noteworthy records are *Navicula americana* Ehr., only known in Great Britain from "Ireland" and "Loch Kinnord," according to Van Heurck. The Martin Beck specimens vary from the type form in being shorter, and, slightly, in the margins of the valves: *N. alpina*, which is usually found at much higher levels than the 100-ft. elevation of Martin Beck; *N. ignota*, shown in Schmidt's Atlas, 43/24, without name, and here named provisionally *N. Danensis*; *N. pusilla*.

E. S. G.

Fresh-water Diatoms from Upper Jämtland in Sweden.—C. W. FONTELL (*Arkiv för Botanik*, 1917, **14**, No. 21, 68, 2 pls.). An account of fresh-water diatoms collected near the railway station, Dufed, in Upper Jämtland, during August and September, 1910. About 20 samples were taken from the surrounding lakes and rivers, and were found to be very rich in individuals as well as in species: 375 forms (243 species and 132 varieties), belonging to 37 genera, are recorded. The flora is in the main boreal, and is analyzed in the first part of the

paper. A list of the species is then given in systematic order, with critical and other notes, and descriptions of the new species and varieties.

E. S. G.

Contributions to our Knowledge of the Fresh-water Algæ of Africa. I. Some Fresh-water Algæ from Madagascar.—F. E. FRITSCH (*Ann. Biol. Lac. Bruxelles*, 1914, 7, 40-59; see also *Bot. Centralbl.*, 1915, 128, 600). The results of an examination of material collected by P. A. Methuen in Madagascar. The greater number of species belong to Desmidiaceæ and Diatomaceæ. One record is of special interest, *Batrachospermum huillense* Welw., as it has only hitherto been recorded once. Three new species, four new varieties, and many new forms are described. The additions to the flora of Madagascar number twenty genera and fifty-eight species.

E. S. G.

Marine Diatoms from the Pacific.—K. RECHINGER (*Denkschr. Kgl. Ak. Wiss. Wien Math.-Nat. Kl.*, 1911, 88, 1-72, 3 pl., 5 text-figs.; see also *Bot. Centralbl.*, 1915, 128, 535). A list of marine diatoms from the Solomon Islands, Samoa and Hawaii, collected by Reehinger and determined by H. and M. Peragallo. New species, varieties and forms are described.

E. S. G.

Economic Importance of Diatoms.—ALBERT MANN (*Annual Report Smithsonian Institution for 1916, 1917*, 377-86, 6 pl.). A discussion of the uses of diatoms—fossil diatoms for abrasive powders; food adulterants; absorbents for nitroglycerine in dynamite; packing for steam-pipes, for refrigerators; for pottery-making; as filter-material for serums; as suggesting designs for wall-paper, jewellery, etc. It is believed that diatomaceous oil is one of the sources of petroleum. The presence of diatoms in oceanic currents has been used as evidence of the source of such currents, e.g. a current from Behring Strait across the Polar Sea to the east coast of Greenland. Diatoms are one of the most important primary sources of food for oceanic animals, fish, etc. Beds of fossil diatoms several hundred feet thick occur on the Pacific Coast of America. The use of *Pleurosigma angulatum* and *Amphipleura pellucida* as test-plates for microscope objects is dying out.

A. G.

Eutetramorus globosus: a New Genus and Species of Algæ belonging to the Protococcoidea (Family Cœlastridæ).—L. B. WALTON (*Ohio Journal of Science*, 1918, 18, 125-7). The alga here described was found in October, 1915, among the plankton of Mirror Lake, a small pond in the campus of the State University at Columbus, Ohio, U.S.A. It consisted of sixteen cells, each containing a chloroplast, the cells being arranged in groups of four, and embedded in an almost invisible gelatinous matrix. The organism was non-motile, with no trace of flagella. It occurred among *Cladophora* and other floating algæ at the margin of the lake. The species has never again been found in the various samples of water taken from the lake since 1915. Of the five genera of Cœlastridæ, three have an extremely restricted distribution, the result possibly of their comparatively rare occurrence. The

present genus is based on a single specimen from Columbus; *Phytomorula* on a very few specimens from Berkeley, California; and *Burkillia* is known only from Burmah. *Eutetramorus* represents the lowest form of the family, where a defined colonial organization is attained.

E. S. G.

Interesting Case of the Formation of certain Vacuoles at the Ends of the Cells in the Desmid *Closterium plurilocellatum*.—A. A. ELENKIN (*Bull. Jard. Imp. Bot. Pierre le Grand*, 1914, **14**,² 225–31; see also *Bot. Centrbl.*, 1915, **128**, 598). An account of a phenomenon observed by the author in 1909–10 in *Closterium plurilocellatum*. He noticed at the end of every cell two or three vacuoles instead of the usual one. They lay along the longitudinal axis, one after the other, diminishing in size towards the thin end of the cell. In this way there was formed a system of four to six terminal vacuoles in the *Closterium* cell, a most unusual phenomenon, quite unknown in the genus. The two largest globular vacuoles adjoin the chloroplasts at both ends; they are up to 5 μ in diameter, and contain always only one large grain of gypsum each, of globular form, 1.2–2.5 μ in diameter. The grains are dissimilar in consistence; each one has its distinct centre in the form of a point resembling a pyrenoid. There lie also along the longitudinal axis, at the cell-ends, one or two globular or slightly elongated vacuoles of lesser size, containing one or several small gypsum grains. This phenomenon was invariably found only in the cells of one species of *Closterium*, which closely resembled *C. peracerosum* Gag. var. *elegans* G. S. West; but on account of the normal, constant, and very special occurrence of this character, the author describes it as a new species. The paper is written in Russian and German.

E. S. G.

Two Green Algæ from the Genus *Stigeoclonium* Kütz.—A. A. ELENKIN (*Bull. Jard. Imp. Bot. Pierre le Grand*, 1914, **14**, 235–50, Russian and German; see also *Bot. Centrbl.*, 1915, **128**, 599–600). A detailed description of two species of *Stigeoclonium* which developed in great quantity on calcareous tufa and on the walls of an aquarium in the Institute for Spore Plants—*S. longipilum* Kütz var. *minus* Hansg., and *S. variabile* Naeg. Both species were cultivated together and under various conditions of water, light, and temperature, but neither exhibited any variety of form. The former species, cultivated in hanging drops, produced no zoospores; the latter, on the contrary, produced many. These zoospores must be regarded as macrospores, as each cell produced only one, of almost globular form, 6.6–7.6 μ wide, 8–8.6 μ long, and provided with four cilia. Microzoospores and gametes were not observed. The author regards these two species as entirely independent and of different origin, having nothing to do with *S. tenue* Kütz. He therefore proposes to call the former *S. Hansgirceanum*, and for the latter, *S. variabile*, he draws up a full and amended diagnosis. He rejects the proposal of Hazen to revive the generic name *Myxonema* in the place of *Stigeoclonium*.

E. S. G.

Notes from the Woods Hole Laboratory.—F. S. COLLINS (*Rhodora*, 1918, **20**, 141–5, 1 pl.). The first of these notes contains descriptions

and critical remarks on species new to science or to the region. *Chroococcus limneticus* Lemmermann is common in two ponds, among other algæ. The cells are 8-13 μ diam., and tend to divide much less in one direction than in the other two. The result is a *Merismopedium*-like thallus in surface view, but with an irregular outline, not square as in *Merismopedium*. A new species, *Microchæte naushonensis*, is described, growing on leaves of *Sphagnum* and other water-plants. *Bulbochæte Furberæ*, a new species, is most nearly allied to *B. Brebissonii*, but has smaller dimensions, more celled androsporangia, and more curved dwarf males. *B. elatior* Pringsh. is here recorded for America. *Mikrosyphar Porphyreæ* Kuckuck is fairly common in the fronds of *Porphyra umbilicalis*. *Nostoc punctiforme* was found throughout the summer, so closely associated with *Sphagnum* that it may be called symbiotic, occurring sometimes on the surface of the leaves, but more usually inside the dead or empty cells. A new *Erythrotrichia*, *E. rhizoidea*, is described and critically discussed.

E. S. G.

Abnormal Conjugation in Spirogyra.—J. G. BROWN (*Bot. Gaz.*, 1918, 66, 269-71, 3 figs.). A short account of material of *Spirogyra nitida* collected in the Rillito River, north of Tucson, Arizona, in April, 1917. The cells were conjugating in such a manner as to give the appearance of a knot, one cell having connexions with three others, two with two others, and the fourth with one other. Three of the conjugation-branches formed a triple connexion, and two other cases of triple connexion were found on the same slide. Another filament showed one cell monopolizing the energies of two cells in an adjacent filament, while the neighbouring cell on each side had resorted to parthenogenesis. The author attributes these abnormalities to such external factors as the volume, temperature, and salt-content of the water. In the river in question these factors are extremely variable, and the material here described was collected in a pool which had undergone violent changes due to floods of snow-water from the mountains, followed by evaporation and consequent increase of salt-content.

E. S. G.

Cross-conjugation in Spirogyra Weberi.—BERT CUNNINGHAM (*Bot. Gaz.*, 1918, 66, 272-3, 1 fig.). The author records the occurrence of cross-conjugation in *Spirogyra Weberi*, in addition to that described by him as occurring in *S. inflata* (l. c., 1917, 486-500). He compares the length and width of the two species, and gives figures of both.

E. S. G.

Germination of the Spores of Florideæ.—HARALD KYLIN (*Arkivf. Botanik*, 1917, 14, No. 22, 25 figs.). A detailed account of the germination of spores in each of the three types of Florideæ germlings, as defined by the author—(1) the germ-tube type; (2) the attachment-disc type; (3) the upright type. In the first, the spore on germination forms a tube, which is separated by a cell-wall from the spore, which remains undivided. This type occurs in Nemalionales and in several Cryptonemieæ. In the second type, the spore divides, without increase of size, by a cell-wall vertical to the substratum, and the two cells proceed

to form a disc. This type is found in Gigartinales, Rhodymeniales, Corallinaceæ, most Cryptonemiæ, and certain species of *Chantransia* (Nemalionales). In the third type, the spore often elongates, then divides by a cross-wall, parallel with the substratum, into two cells, one of which represents the pole of the shoot, the other the pole of the root. This type occurs in Ceramiaceæ, Rhodomelaceæ and Delesseriaceæ. The method of culture of the germinating spores is described; and many figures are given of the various developmental stages of each of the twelve species described.

Among the many interesting points described in connexion with the developing sporings is the growth of long unicellular hairs, which occurred in cultures of *Dumontia* to which no additional nitrate had been supplied. In all other respects the conditions of the cultures were the same; and the author concludes therefore that the hairs which occur in so many algæ are formed for the greater absorption of nutritive substances, particularly nitrates and phosphates, from the sea-water.

Finally, the author discusses the question of the influence of light on the germination of spores, after giving the views of other authors on the subject. His own experiments all point to the conclusion that it is the substratum and not the direction of light that influences the orientation of the germinating spore. In his own cultures the substratum was always horizontal, and it is therefore quite possible, though not necessarily certain, that the influence of the substratum on the orientation is merely the influence of gravity. This point needs further investigation.

E. S. G.

Parasitism among the Red Algæ.—W. A. SETCHELL (*Proc. Amer. Phil. Soc.*, 1918, 57, 155-72). The author begins by defining "endophyte" and "epiphyte," and showing how easily both classes may include species which are partially parasitic. He then summarizes fully and clearly the work done on algal parasitic species, and gives a list of forty-two published species, with their respective hosts. The total number of genera known to the author is twenty-nine. These are all reduced or condensed as to the thallus, penetrating and apparently forming protoplasmic connexions with the host plants, and varying from full deep red to pure shining white. Four of these genera are yet unpublished, together with about nine species, of which a short *résumé* is given, all of them being in the author's possession. Of the eleven families among which the parasitic genera are distributed, two—viz. Gigartinaceæ (with five genera and twelve species), and Rhodomelaceæ (with nine genera and seventeen species)—contain one half or more of the known genera and species. It is a remarkable fact that so many of the parasitic red algæ are restricted to near relatives as hosts. Theories have been advanced to account for this. The probability, as it seems to the author, is, however, that the various parasites, or some of them, may have originated in close connexion with their hosts by some mutation decreasing the chlorophyll content or power in one or other of the different forms of spore. Such an inducement to increase the power of penetration and possible protoplasmic connexion between a spore (tetraspore or carpospore) germinating in position might, it would seem

probable, initiate parasitism on the parent plant, and this parasitic tendency increasing penetration and dwarfing might therefore be inheritable. The author gives an instance of such a case in *Agardhiella tenera* Schmitz, where there exist full-sized plants of all three sorts, viz. antheridial, cystocarpic and tetrasporangial; and there exist also dwarf plants parasitic on, but arising from, the tetrasporangial plant. These dwarf plants are very much reduced and simple, and are largely antheridial: but cystocarpic and tetrasporangial dwarf plants may also exist side by side with the antheridial dwarf plant, all parasitic on and probably arising from the same full-sized tetrasporangial plant. Their development from the zonate tetrasporangium is described. The allied species, *Agardhiella Coulteri*, shows no such dwarf parasitic growths. E. S. G.

Enumeratio Specierum Nematium et Helminthocladia Japonicae.

—SEIICHI NARITA (*Bot. Mag. Tokyo*, 1918, **32**, 189-93, 1 pl., 1 text-fig.). Notes are given on three known species of *Nematium*: and one species, *N. japonicum*, new to science, is described from a unique specimen. Another novelty is *Helminthocladia Yendoana*, recorded from several localities in Japan, and represented in Herb. Mus. Bot., Paris, by two specimens collected by Savatier, at Yokosuka, and determined as *Nematium attenuatum*. *H. purpurea* is recorded as new to Japan, differing only from the European forms in having somewhat smaller fronds and more compound ramification. Japanese habitats are given for *H. australis*. The two new species and *H. purpurea* are figured. E. S. G.

Oceanic Algology.—ANGELO MAZZA (*Nuova Notarisia*, 1918, **29**, 57-112). A continuation of his study of the marine algae. In the present part the author discusses the structural and systematic characters of three Coralline genera and some of their species—*Cheilosporum* (four species), *Corallina* (five species and seven forms), *Jania* (six species). E. S. G.

Developmental Forms of Marine Algae.—LILIAN LYLE (*New Phytologist*, 1918, **17**, 231-8, 2 pls. and figs.). An account of some developmental forms of marine algae, notably the dimorphism of *Nitophyllum ramosum* Batt. (*N. laceratum* Grev.). The author finds that the normally erect thallus takes a procumbent position, in which the resemblance to *N. reptans* Crouan is so close that the two species must be regarded as identical. She therefore designates the latter as *N. ramosum* f. *reptans*. The dorsiventral habit is due to certain conditions of growth, and arises only in the initial stages of the plant, but may persist throughout its life-cycle. The author then discusses cases of "Recrudescence," which she has observed in *Rhodymenia palmata*, *Nitophyllum Hilliae*, *N. litteratum*, *Callymenia reniformis*, *C. Larteriae* and *C. flabellata*. The old plant bears proliferations which extend indefinitely, eventually equalling or exceeding in size the parent plant, and themselves producing proliferations. These may represent second and third year growths. Instances of proliferation are figured.

E. S. G.

Marine Algæ of the Danish West Indies.—F. BÜRGESEN (*Dansk Botanisk Arkiv*, 1918, 3, No. 1d, 241-304). The author continues his treatment of the species of the Rhodophyceæ of the formerly Danish West Indies. The genera treated in the present part are *Centroceras*, *Ceramium*, *Laurencia*, *Chondria*, *Acanthophora*, *Polysiphonia*, *Digenea*, *Bryothamnion*, *Herposiphonia*, *Dipterosiphonia*, *Lophosiphonia*, *Bostrychia*, and *Lophocladia*. One new species, *P. sphærocarpa*, is described. The copious critical notes to each species are well illustrated by numerous figures in the text. E. S. G.

Algæ of Commonwealth Bay.—A. H. S. LUCAS (*Australasian Antarctic Expedition*, 1911-14, Scientific Reports, Series C, 1919, 7, part 2, 18 pp. 9 pls.). The fourteen species here recorded were collected by the Mawson Expedition to the Antarctic, and include two new species, *Chætomorpha Mawsoni* and *Iridæa Mawsoni*. Critical notes are appended to each record. Under *Plocamium coccineum* a comparative table is drawn up of the characters of that species and *P. leptophyllum*. The author comes to the conclusion that the two species are identical with each other and with the Antarctic form. The only known species in the list not previously recorded for the Antarctic is *Ballia callitricha* (form *B. Hombroniana* Mont.), sparingly represented by worn fragments. *Phyllogigas grandifolius* was well represented by a large number of individuals of different stages, from very young to the full-grown plant. They are here fully described and well figured. The floras of Victoria Land and Commonwealth Bay are compared. Eight species are common to both; and, on the other hand, each region has six species not represented in the other. The floras are both very limited. E. S. G.

Seaweed as Raw Material for Industry.—SALLER (*Prometheus*, 1916, 27, 726-7; see also *Bot. Centralbl.*, 1917, 135, 180). Banks of algæ are cast up on the shore during great storms, and consist mainly of brown and red algæ. The brown algæ predominate, and are already recognized in industry. But red algæ have also found their uses, for instance, as a binding material for artists' colours, as a source of agar-agar which is employed as an edible, a medicine, a medium for the culture of bacteria, and a "finish" for textile fabrics. As a source of iodine algæ are badly neglected. The species of *Laminaria* contain about 80 p.c. water. Of the residue obtained by desiccation, 20 p.c. consists of salts soluble in water, 40 p.c. soluble organic material, 35 p.c. insoluble organic material, and 5 p.c. insoluble inorganic material. Only the 20 p.c. salts are made use of in iodine manufacture and in the preparation of potassium salts for fertilizers. The 75 p.c. organic material yields 20 p.c. of the "finish"-medium called "norgine," and from the residue yields "taugin," a medical remedy for gout and rheumatism. Recently a definite seaweed industry has been developed in California; and as all the factories are surrounded with barbed wire, the author assumes that they have special trade secrets to guard. E. S. G.

Fungi.

Rhizopus Rot of Strawberries.—NEIL E. STEVENS and R. B. WILCOX (*U. S. Dept. Agric.*, Bull. No. 31, 1917, 1-21) have studied the fungi that cause rotting of these berries in transportation. They find that it is often, if not mainly, due to *Rhizopus nigricans*. The fungus is not able to penetrate uninjured epidermis, but enters readily through wounds in either mature or green berries. *Rhizopus* does not attack strawberries in the field, nor is it able to grow at low temperatures, so that berries gathered in the early morning are more safely transported than those that have been heated by the sun.

In a further Bulletin (No. 686, 1918, 1-14) the authors publish further details on the disease. They contrast *Rhizopus* with *Botrytis*, which latter is a field rot. Berries infected with the latter fungus should not be packed; it is able to grow at low temperatures. A. L. S.

Notes on Mortierella.—PAUL VUILLEMIN (*Bull. Soc. Mycol. France*, 1918, 34, 41-6, 3 figs.) finds that the type species *Mortierella polycephala* includes another species, *M. Le Monnieri* sp. n. The author describes in detail all the allied forms, and diagnoses yet another new species, *M. Mairei*. The latter had a brown coloration, due to the substratum, *Ustulina maxima*. The *Mortierellæ* frequently take the colour of the support; thus there is a species, *M. nigrescens*, in which the spores become brown or chocolate. Another species, with similar morphological characters but remaining always colourless, has been named *M. Bainieri*, but is probably the same fungus. A. L. S.

Origin and Development of the Potato Disease, Phytophthora infestans.—JAKOB ERIKSSON (*Arkiv f. Botanik*, 1916-17, 14, 1-65, 6 pls., 5 figs.) gives an account of the research work done on this disease, and the results attained by the different workers. He then describes his own research on the subject and the conclusions at which he has arrived, which differ very widely from those generally received. After describing the first outbreaks of the disease—in Sweden, between the middle of July and beginning of September—he proceeds to the examination of affected leaves. In these he finds a mycoplasma living in symbiosis with the protoplasm of the host-cell. In time fungus hyphæ develop from the mycoplasma, pass out from the cell, and form either an oogonial or an antheridial primordium. Fructification between the oogonia and antheridia follows, and an oospore is formed which does not function as a resting spore, but gives rise at once to two or three hyphæ, which pass out of the leaf by the stomata and form the familiar conidia, which act as zoosporangia. Eriksson points out that he has not yet ascertained the origin of the mycoplasma, nor does he know if similar developments take place in the seed-tubers during the spring or summer months. A. L. S.

New Brown Aspergillus, Eurotium verruculosum.—The new fungus was found in the laboratory on badly sterilized carrots by P. VUILLEMIN (*Bull. Soc. Mycol. France*, 1918, 34, 76-83, 17 figs.). He

compares it with a brown species, *Eurotium echinulatum*, and gives the characters that indicate the difference between the two species, chiefly in the ascospores, which in Vuillemin's species are marked by lines of verrucæ forming two rings round the centre of the spore. The conidia are also ornamented by brown verrucæ. A. L. S.

Character of Taxonomic Value in Xylariaceæ.—F. VINCENS (*Bull. Soc. Mycol. France*, 1918, **34**, 101-9, 4 figs.) finds in the spores of this family a furrow along one of the surfaces parallel with the long axis. It is such a constant feature that he considers it indicates tissue relationship. He has found it also on the genera *Rosellinia* and *Anthostomum*, and would unite these with the *Xylariæ*. The spores of *Warcelia* bear also the same character, but not those of *Xylobotryon*, which are two-celled; the ascus also differs from that of *Xylaria*. A. L. S.

Organogenic Researches on Hypocreales.—A study of development in Pyrenomycetes has been undertaken by F. VINCENS (*Thèse Sciences Paris*, 1918, 166 pp., 71 text-figs., 3 pls. Lons-C.-Saunier, 1917; see *Bull. Soc. Mycol. France*, 1918, **34**, 95-6). His intention was to provide, if possible, a more scientific classification, but for the present he has only examined Hypocreales. He describes the formation of the stromata and of the perithecia within the stromata in *Melanospora Mangini*, *Hypomyces aurantiacus* (which resembles the previous in the later stages), *Nectria Ribis* (in which the ascogonium degenerates), *Hypocrea gelatinosa*, *Claviceps microcephala*, and *Epichloe typhina*. He concludes that the group is entirely artificial, and the members ought to be relegated to other groups of Pyrenomycetes. A. L. S.

Zygosaccharomyces Nadsonii sp. n.—This new species of yeast with heterogamic conjugation has been cultivated, and is now described by A. GUILLERMOND (*Bull. Soc. Mycol. France*, 1918, **34**, 111-22, 4 pls., 4 figs.). It was isolated from a syrup of bitter oranges, where it produced active fermentation; it was cultivated on beer-wort, where it grew freely. The ascospores arise from the union of a large mother-cell with a smaller daughter-cell derived from the former; they unite by means of a canal, the contents of the small or male cell emigrating into the female cell, which becomes thus an egg-cell. In a short time the egg-cell takes on the character of an ascus cell, and forms one or two or even three ascospores. A. L. S.

Vegetation of *Plicaria leiocarpa*.—LÉON DUFOUR (*Bull. Soc. Mycol. France*, 1918, **34**, 31-3) publishes notes on the development of this fungus. It grows, he says, exclusively on ground that has been devastated by fire at some recent date. Thus, after fires at Fontainebleau, the fungus grew in great abundance early the following year, then gradually died out again. Dufour considers that the spores of the fungus could not survive during the long pauses of growth, but that the mycelium must persist at some considerable depth in the soil. A. L. S.

Three Discomycetes.—J. CHENANTAIS (*Bull. Soc. Mycol. France*, 1918, **34**, 34-40, 1 pl.) publishes an account of *Ascophanus cinereus*,

the development of which he has carefully followed. He found that a daily watering of the substratum was a great aid to growth, and the peculiar characteristics of the fungus became thus more evident. Chenantais finds reason to associate with it as synonymous *A. Holmskjöldii* and *A. crustaceus*; the former has, however, somewhat large spores, and might rank as f. *major*. He gives also diagnoses and descriptions of *Pithyella hamata* sp. n. and *Hyalinia Ulicis* sp. n. A. L. S.

Scandinavian Taphrina Species.—An exhaustive study of this group has been published by BJ. PALM (*Arkiv Botanik. K. Svensk. Vet.*, 1917-18, 15, No. 4, 1-41, 9 figs.). In the introduction there is a histological and general account of the genus. In the systematic portion of the paper he divides the genus into a number of sub-genera (formerly reckoned as genera)—(1) *Taphrinopsis*, species that grow on ferns; (2) *Eutaphrina*, species on Ulnaceæ, Betulaceæ, Fagaceæ and Salicaceæ; (3) *Euezoascus*, species on Rosaceæ; (4) *Saulebeckiella*, species on *Acer*. Palm has added four new species to the sub-genus *Taphrina*, three of them on *Betula*, one on *Alnus*. A synopsis of species is published under each sub-genus. A. L. S.

Contribution to the Knowledge of the Mycelium of the Genus Volkartia.—The genus *Volkartia* was founded by René Maire on *Taphrina rhætica*. A second species, *V. umbelliferarum*, grows on *Heracleum Sphondylium*. A study of the parasite has been made by G. V. BUREN (*Mitt. Naturforsch. Gesell. Bern*, 1917 (1916), 112-24, 1 pl., 9 figs.) with a view to determine the method of over-wintering. He has found that the mycelium is perennial in the root-stock of the hosts, and from thence passes into the young plants. The fungus does not seem to do much harm to the plants attacked. A. L. S.

An Account of some Observations upon the Life-history of Phoma citricarpa McAlp.—This fungus causes the "Black-spot" disease of *Citrus* fruits in Australia, and was first described by McAlpine in his "Fungus Diseases of Citrus Trees in Australia." New observations and records have been published by G. P. DARNELL-SMITH (*Proc. Linn. Soc. N. S. Wales*, 1919, 43, 818-82, 7 pls.). Under the heading "General Symptoms of the Disease" he describes the attack on the leaves of the *Citrus*, generally followed later by spotting of the fruit, and always on the sunny side of the tree: this he traces to the effect of too much sunlight or heat upon the rind, which destroys in some way its inhibiting power. Culture experiments were successfully undertaken and are fully described. Spraying with Bordeaux mixture controls the disease, and need not be undertaken till the fruit is half-grown. A. L. S.

Index to American Species of Phyllosticta.—P. J. ANDERSON (*Mycologia*, 1919, 11, 66-79) supplies a list of species and of hosts that have been published since the issue of Ellis and Everhart's "North American Phyllostictas." He gives references to the literature, and occasionally explanatory notes. There are now 1900 American species of *Phyllosticta*. A. L. S.

North American Ascochytae.—A descriptive list of these, arranged in specific alphabetical order, has been published by J. J. DAVIS (*Trans. Wis. Acad. Sci., Arts and Letters*, 1919, **19**, Part II., 655-70). They grow on leaves and branches, and cause more or less damage. An index of hosts is added. A. L. S.

Onion Smut.—This disease, which is new to the British Islands, is reported by A. D. COLTON (*Journ. Board of Agric.*, 1919, **26**, 168-74, 1 pl.). The smut was published by Farlow as *Urocystis cepulae* in 1897, and has since that date been frequently collected in the United States. In this country it first appeared in June, 1918, in a garden at Northampton, but a record of it from allotments near Edinburgh has been found dating from 1912. The fungus forms black streaks on the leaves, which may extend to the base of the bulb. The sooty mass of spores may be blown away to other plants, or may contaminate the soil. Plants are infected when quite young, below the ground level; the mycelium produced as a result of infection spreads through the growing seedling. Spores do not affect the leaves above ground, nor older plants. The spores retain their vitality for many years; a case is reported where bad outbreaks occurred in a field after twelve years. In America formaldehyde has been used for disinfecting the soil, and has been partially successful. Leeks are even more liable to the disease than onions. A. L. S.

Smut on Iresine.—The smut described was found by JOHN A. ELLIOTT (*Mycologia*, 1919, **11**, 87-8, 4 figs.) affecting the ovaries of *Iresine paniculata* from Indiana. It belongs to the genus *Tolyposporium*, and is the first smut recorded on *Iresine*. A. L. S.

Experiments with Uredineæ.—ED. FISCHER (*Mitt. Naturf. Gesell. Bern*, 1918 (1917), 58-79, 3 figs.) continues his mycological contributions with descriptions of Uredine experiments. He found a new *Gymnosporangium*, *G. fusisporum*, on *Juniperus sabina*, with its æcidia on *Cotoneaster integerrima*, possibly also on *Pirus communis* and *Cydonia oblonga*. He also traced the development of *Uromyces lævis* on the host plant, *Euphorbia Sequieriana*, from the inoculation of buds by teleutospores in the soil. When the buds opened, the first leaves were free from the fungus, but the later leaves were infected. Then a second delay of growth of the mycelium occurred, and the terminal shoots and leaves were free from the fungus.

Some experiments with *Puccinia fusca* on *Anemone montana* are also described. This Uredine possesses a perennial mycelium, and infection experiments are rarely successful, but eventually teleuto-sori were found in two of the leaf segments. A. L. S.

Puccinia subnitens and its Æcial Hosts. II.—An interesting study has been made by ELLSWORTH BETHEL (*Phytopathology*, 1919, **9**, 193-201) of the various hosts of *Puccinia subnitens* Diet., more especially of the æcial hosts. The teleutospores occur chiefly on *Distichlis spicata*, but probably also on other grasses. *Distichlis* is always badly rusted in the Western States. With spores from *Distichlis* Bethel was able to inoculate any of the known hosts from whatever localities they

inhabited. Not many collections from the Atlantic Coast have been examined, but both æcidia and telento-sori have been seen from most of the States, from Maine to Delaware. So far the æcidial stage of the rust has been found on eighty-four host species in fifty-two genera belonging to nineteen different families. A. L. S.

New Species of Uredineæ. XI.—The new species now published by J. C. ARTHUR (*Bull. Torrey Bot. Club*, 1919, 46, 107–25) have been collected from widely different localities in America—from Porto Rico, Florida, Colorado, etc., though most of them are from Mexico. The species belong to *Puccinia*, *Uromyces*, *Uredo* and *Æcidium*. Comparative notes are given with the diagnoses. A. L. S.

Parasitism of Puccinia.—The discovery of a strain of stem rust on *Triticum compactum* which did not normally infect a number of varieties of hard spring wheat led to an examination of the differences between the two strains by JULIAN G. LEACH (*Phytopathology*, 1919, 9, 59–88, 2 pls.). The points chiefly investigated were the comparative infection capabilities of the two strains; the degree of constancy and individuality of the new strain; the desirability of finding other host varieties differing in degree of resistance; and, finally, the investigation of the basic factors underlying the action of the two forms in order to throw light on the varietal resistance and biologic specialization. Many experiments were made, and a list is finally given of the wheats that react differently to the two parasites. The new rust, *Puccinia tritici-compacti*, was proved to be a distinct and constant biologic form. There follows a discussion on the phenomena of immunity and susceptibility. A. L. S.

British Rust Fungi.—A list of rust fungi from Scotland more or less new to Britain has been published by MALCOLM WILSON (*Journ. Bot.*, 1915, 53, 43–9). These are *Puccinia Prostii* on tulips; *P. borealis*, the æcidial stage of which was described by Greville, on *Thalictrum* (*Æ. Thalictri*); *Puccinia septentrionalis*, the telentospores of which were found on *Polygonum viviparum*, on Ben Lui; *P. Anthozanthi*, previously recorded by Plowright from King's Lynn, now found on Ben Lui and Ben Voirlich; and *Melampsora alpina* on *Salix herbacea*, also found on Ben Lui from July to October.

A second paper by WILSON (*Journ. Bot.*, 1919, 57, 161–3) gives further information on rust fungi. The author has found the æcidial stage of *Melampsora alpina* on *Saxifraga oppositifolia*. It grew on Ben Lui in July and August. He has also found in abundance the æcidia of *Puccinia borealis*, not recorded since Greville's day. *Uromyces Onobrychidis*, a new fungus for Britain, grew on *Onobrychis sativa* at Faversham, Kent. Notes are also published of other species. A. L. S.

Mycological Contributions.—In this paper a number of subjects are dealt with by ED. FISCHER (*Mitt. Naturforsch. Gesell. Bern*, 1917 (1916), 125–63, 6 figs.). He describes the results obtained by him in inoculation experiments with the Uredine *Thecopsora sparsa*, the telento-spore and uredospore stages of which are found on *Arctostaphylos* sp.

He succeeded in developing the æcidium stage on *Picea excelsa*. Similar experiments with *Pucciniastrum Circææ* on *Circæa lutetiana* were followed by the growth of æcidia on *Abies pectinata* on the under side of the leaves; pyrenidia grew on both sides. He was able to prove also that *Coleosporium Senecionis* forms æcidia on *Pinus montana* as well as on *P. silvestris*. He made further experiments on the species of *Senecio* affected by the Uredine.

Fischer also gives results of experiments to test the hereditary susceptibility of hosts to the fungus parasites. Susceptibility did not follow on the morphological character of the leaves. More research is necessary.

He notes the presence of an exotic fungus, a species of *Aseroë*, in Europe. It appeared in a garden at Hengelo in Holland. Fischer discusses the specific determination; it seems to be nearest to *A. australiensis*.

A revision of the *Exobasidææ* on *Ericacææ* is also outlined by the writer. He distinguishes two groups: those that cause galls and swellings, and those that form a layer on the under side of the leaves, covering often the whole surface.

A. I. S.

Morphology of the Genus Actinomyces.—The material for the study of this genus was isolated from soil collected in Cambridge, Massachusetts. Other forms were obtained from Porto Rico, Cuba, etc., and the potato-scab organism was taken from a diseased tuber. From these numerous specimens, representing probably more than 100 species, a developmental study has been carried out by CHARLES DRECHSLER (*Bot. Gaz.*, 1919, 67, 65-83, 147-68, 8 pls.). As a result of his observations Drechsler places the fungus among the Hyphomycetes. He was able to follow every stage of growth in his cultures up to the formation of spores. The sporogenous hyphæ of most species are coiled in close spirals; the number and diameter of the coils and the direction of the rotation (whether dextrorse or sinistrorse) are specifically constant. He describes and figures eighteen different forms, indicated by numerals.

A. I. S.

Studies in the Agarics of Denmark.—JAKOB E. LANGE (*Dansk. Bot. Arkiv*, 1913-15, 1, No. 5, 1-40, 2 pls., 1 coloured) gives first a general introduction explaining that the publication now undertaken is meant to serve as the letterpress of a forthcoming "Illustrations of the Agarics of Denmark." The group here studied includes the genus *Mycena*, and he emphasizes the importance of microscopic characters in determination—spores, their arrangement on the gills and the cystidia. He gives a key to the genus based mainly on such characters. He finds two sections: (1) *Eumycena*, with smooth spores containing fifty-three species; and (2) *Mycenella*, with warty spores, only two species. A complete description is given of each species, with habitat, locality, etc. Spores, basidia, and cystidia of each species are figured.

A. I. S.

Occurrence of an Inverted Hymenium in *Agaricus campestris*.—This abnormality was noted in cultivated mushrooms, and has been investigated by G. DARNELL-SMITH (*Proc. Linn. Soc. N.S. Wales*, 1919).

45, 883-7, 3 pls.). In a large number of the mushrooms the abnormal hymenium caused black protuberances on the upper surface and injured the market value of the plants. The author describes these deformities, and gives his reasons for regarding the occurrence as a reversion to ancestral characters.

A. L. S.

Notes on Australian Fungi. No. IV.—Polyporus, Fomes, and Hexagona.—A very full account of these fungi is published by J. BURTON CLELAND and E. CHEEL (*Journ. Roy. Soc. N.S. Wales*, 1917, 51, 473-557). The authors have submitted their specimens to C. G. Lloyd, and they publish his notes on them as well as their own observations. Appended is a list of Cooke's records and determinations, with the names now given.

A. L. S.

Ceylon Lentini.—In a paper on this subject T. PETCH (*Ann. Roy. Bot. Gardens, Peradeniya*, 1916, 6, 1-8) discusses the species of *Lentinus* collected and described as Ceylon plants. A number of these have been described several times under different names. Petch gives the information and the descriptions that serve to unite the various forms.

A. L. S.

Ceylon Polypori.—In preparing this paper T. PETCH (*Ann. Roy. Bot. Gardens, Peradeniya*, 1916, 6, 1-58) has taken, as a basis, Berkley and Broome's list of Polyporoids in the "Fungi of Ceylon." The original specimens are in the Herbarium, Kew, and they are here discussed, and renamed when necessary. The genera *Polyporus*, *Polystictus*, *Fomes*, *Poria*, *Trametes*, *Dædalea*, *Hexagonia*, and *Furolus* are included in this survey. A few species new to science are added by the author.

A. L. S.

Conidial Forms of Basidiomycetes.—N. PATOUILLEARD (*Bull. Soc. Mycol. France*, 1918, 34, 198-201, 2 figs.) describes *Ptychogaster nodulosus* sp. n., which formed small nodules on rotten bark in the Philippines. It was associated with a *Hydnium*. A second fungus, *Echinodictyon Theobromæ*, grew on branches of *Theobroma Cacao* at Singapore. It has the appearance of a flat cushion, the general mass rather coriaceous, and covered with points like a *Stilbum* fructification. The connexion with any higher fungus has not been determined.

A. L. S.

Mycological Notes.—Three issues of these notes have been published recently by C. G. LLOYD (*Cincinnati, Ohio*, 1918, Nos. 54, 55, 56, 766-812). In each Lloyd gives a photograph and a sketch of some distinguished mycologist, then follow figures, notes and descriptions of fungi received from all quarters of the globe; among others there are several species of *Camillea*, *Tremella*, *Geaster*, etc.

A. L. S.

French Mycology.—F. BATAILLE (*Bull. Soc. Mycol. France*, 1918, 34, 195-7) notes a new locality for *Phallus impudicus* var. *imperialis*, in which the peridium and internal envelope of the stalks are a beautiful rose-violet. He collected it towards the end of the summer (1913) at Wimereux, Pas-de-Calais. A description of the fungus is given.

A. L. S.

Technical Microscopic Methods for the Study of Fungi.—FERNAND MOREAU (*Bull. Soc. Mycol. France*, 1918, **34**, 137-91, 35 figs.) presents a manual of instruction with regard to the microscopic examination of fungi. These include the description of the microscope and its various parts, drawing, measurement, preparation of specimens, fixing, staining, etc., with a particular account of the protoplasm and cytology of the group, and instructions suited to the problems to be solved in the examination.

A. L. S.

Introduction of Wood-destroying Fungi.—JAMES R. WEIR (*Mycologia*, 1919, **11**, 58-65) writes on this subject in regard to imported timber in the United States, and cites instances he has noted of such introduction of fungi. He remarks on the comparatively small number of timber fungi in the tropics, but such as there are might spread readily in the southern districts. He also instances the growth of *Polystictus sanguineus* collected in Brazil, but reviving after two years, and growing at Munich when exposed in the forest while snow was still on the ground. The author advises the study of tropical timber diseases in their native haunts, that inspectors may know what to look out for in their examination of imported timbers.

A. L. S.

Philippine Basidiomycetes. III.—PAUL W. GRAFF (*Bull. Torrey Bot. Club*, 1918, **45**, 451-69, 1 pl.) has brought together a series of fungi collected in the various Islands of the Philippine group. He has included in the list a certain number of *Ustilagineæ* and *Uredineæ*. With each species there is published a complete synonymy, and not only the habitat but the geographical distribution.

A. L. S.

New Japanese Fungi.—A number of microfungi new to Japan (*Uncinulæ Peronosporæ*, etc.) have been described by TYÔZABURÔ TANAKA (*Mycologia*, 1919, **11**, 180-6). They are mostly parasitic. One of them, *Macrophoma Corchori Sawada* sp. n., causes a disease of jute. The writer points out that the fungoid diseases of jute are very imperfectly known.

A. L. S.

Greek Mycology.—IOANNES POLITIS (*Atti. Ist. Bot. Univ. Pavia*, 1918, Ser. 2, **15**, 73-9) has undertaken the study and classification of Greek fungi. The material was collected partly by himself and partly by the Directors of the Agricultural Stations of Elide and Patrasso. He has already listed forty-two species belonging to various families and genera of microfungi parasitic on the higher plants.

A. L. S.

Michigan Fungi.—C. H. KAUFFMAN (*Nineteenth Report Mich. Acad. Sci.*, 1917, 145-57) publishes a list of additions to the Michigan Fungus Flora, giving substratum and locality, with the hosts in the case of parasites. To that he appends a list of host plants with the Basidiomycetes that grow on them, these being largely woody fungi belonging to the *Polyporei* and allied groups.

A. L. S.

Clathrus cancellatus in Scotland.—This fungus—an almost entirely southern or tropical plant—has been hitherto found only in South England. It turned up in West Scotland in Argyll, where it was

collected by D. PAUL, who has published an account of it (*Trans. and Proc. Bot. Soc. Edinb.*, 1917-18, **27**, 301-2, 1 pl.). He is unable to explain its occurrence so far north.
A. L. S.

French Mycology.—G. JUILLARD (*Bull. Soc. Mycol. France*, 1918, **34**, 27, 2 col. pls.) gives descriptions of two rare *Boleti*—*B. calopus* and *B. olivaceus*—which were collected in the Forest of Epinal.

H. PIERRE (*Bull. Soc. Mycol., France*, 1918, **34**, 74-5, 1 pl.) describes the superposition of two specimens of *Russula* on the pileus of an older plant. The tissue is continuous between the two fungi, so the association must have started at an early stage of development. They were collected in a wood on damp humus.
A. L. S.

Additions to Ceylon Fungi.—A large series of fungus species, most of them new to science, have been published by T. PETCH (*Ann. Roy. Bot. Gardens, Peradeniya*, 1917, **6**, 195-256). The fungi are mostly either of a large fleshy nature or belong to the microfungi. They were all collected in Ceylon during recent years.
A. L. S.

Revisions of Ceylon Fungi (Parts IV. and V.).—These two papers are parts of a series of notes and observations by T. PETCH (*Ann. Roy. Bot. Gardens, Peradeniya*, 1916, **6**, 1-31; 1917, **6**, 307-55). The author takes up the species of fungi already described and published by previous authors, and gives a history of the species and new descriptions from the living plants. In many cases plants are grouped together that have been diagnosed as distinct species. An index is given with each paper which accounts for all the various names.
A. L. S.

Discoloration of Paper Pulp due to Fungi.—FERNAND MOREAU (*Bull. Soc. Mycol. France*, 1918, **34**, 29-30) reports that a quantity of pulp imported for the manufacture of paper arrived in a very blackened condition, and that the usual process of whitening (by chlorine or hypochlorites) was useless in removing the colour. The blackening was supposed to be due to the presence of a sphaeriaceous fungus on the pulp. If blackening by fungi were to become a danger, the value of imported pulp would be seriously lessened. Moreau experimented with the mycelium and spores of fungi that are dark brown or black. In all cases he was able to decolorize them in a few minutes; but as the presence of a large quantity of fungi might necessitate the employment of hypochlorite in too great quantities, antiseptic measures should be taken before shipment of the material.
A. L. S.

Ecological Conditions in the Development of Parasitic Fungi: Study of Geographical Botany.—This subject has been taken up by J. DUFRENOY (*Bull. Soc. Mycol. France*, 1918, **34**, 8-26), who discusses from personal observations the cause of disease from the view of environment. As factors influencing the presence of fungus diseases he cites the altitude (in which are included radiation, humidity, and temperature) and also the season when the spores mature. He finds that there are species which belong to the plains, others to the mountains, and

some that are indifferent. The author then discusses the degree of noxiousness of the parasites and the immunity of some hosts compared with others. His observations were made at Barèges, in the Pyrenees, and he compares the fungi on the French side with those of the Spanish. As the weakened plant is most liable to attack, it generally happens that several fungi are found on the same host growing in association. The work of insects in transporting spores, and by their bites providing wound openings, is also noted.

A. L. S.

Xylaria Notes.—Two papers have been issued by C. G. LLOYD (Cincinnati, Ohio, Sept. and Dec. 1918, 1-22, figs.) bearing on this genus of fungi. The species dealt with are mainly tropical, many of them collected in Brazil. One, named *Xylaria Herculea*, measures 4 to 10 in. long and $\frac{1}{2}$ to 1 in. thick; it was found by Torrend in Brazil. Other plants described and figured are from Canada and from West Africa.

A. L. S.

Sporadic Appearance of Non-edible Mushrooms in Cultivated Mushroom-beds.—MICHAEL LEONIE (*Mycologia*, 1919, 11, 51-4, 1 pl.) describes a dwarfed white Agaric among the normal mushrooms in cultivation. The plants have short stipes and are frequently fused together. Leonie places them near *Clitocybe dealbata*. He also cites the occurrence of *Aleuria vesiculosa* and var. *saccata* as frequent in mushroom-houses around New York. Both species and variety are typical mushroom-cellar plants.

A. L. S.

Endothia parasitica and Related Species.—An account of these has been published by C. L. SHEAR, NEIL E. STEVENS, and RUBY J. TILLER (*U. S. Dept. Agric. Bull.*, No. 380, 1917, 1-82, 23 pls., 5 figs.). The authors have thoroughly investigated the questions of Taxonomy, Morphology and Physiology of the fungus. Eight species have been recognized by them and cultures made, but *Endothia parasitica*, the disease organism of chestnut-trees, is the most virulent in its action. It has already destroyed most of the chestnut-trees within a radius of 100 miles of New York City. The origin of the fungus has been ascertained by Meyer, who discovered it in Japan and China, whence it was imported into America. Oriental species of chestnut are more or less resistant; all American species are specially liable to the disease.

A. L. S.

Parasitic Microfungi.—MALUSIO TURCONI and LUIGI MAFFEI (*Atti Ist. Univ. Paria*, 1918, Ser. 2, 15, 143-9, 1 pl.) describes a new genus of Ceratostomaceæ. It differs from *Ceratostoma*, its nearest ally, in the hispid character of the perithecium, which is adorned with long stiff pointed hairs. The fungus was found on dead leaves of *Castanea vesca*, in Liguria. They further describe two diseases of *Sophora japonica* due to different fungi. The first, which affects the leaves, has been traced to *Macrosporium Sophoræ* sp. n. The second causes livid spots on the branches, and is due to *Gibberella Briosiana* sp. n. The authors also describe a conidial stage, *Fusarium* sp., which differs in various characters from *F. Sophoræ* Allesch.

A. L. S.

Parasite of Arbutus Unedo.—J. DUFRENOY (*Bull. Soc. Mycol. France*, 1918, **34**, 99–100) detected circular dried spots on the leaves of *Arbutus*, on which grew scattered perithecia with simple ovoid colourless ascospores. Dufrenoy considers that it may be a new species of *Guignardia*, or perhaps a form of *G. Vaccinii*. A. L. S.

Ergots of Rye on Wheat.—J. CHIFFLOT (*Bull. Soc. Mycol. France*, 1918, **34**, 192–4, 1 pl.) calls attention to the presence of ergots on Manitoba wheat. The wheat has been recently introduced into France, and is known to be remarkably free from parasites. Chifflot considers the fungus to be a form of *Claviceps purpurea*, and probably only newly introduced into France. A. L. S.

Cane-Leaf Spot.—A disease of sugar-canes resulting in spots on the leaves has been investigated by P. VAN DER BIJL (*Union of S. Africa Dept. of Agric. Sci. Bull.*, No. 10, 1918, 1–16, 7 figs.). He isolated the fungus that was causing the trouble, and found that it approached very near to *Cercospora Sacchari*. He grew the fungus in culture media, and he also inoculated healthy leaves. Full details are given of the various experiments. A. L. S.

Disease of Chestnuts.—GIOVANNI BRIOSI and RODOLFO FARNETE (*Atti Ist. Bot. Univ. Pavia*, 1918, Ser. 2, **15**, 43–51, 1 fig.) reply to criticisms by Griffon and Maublanc on their researches of the chestnut ink-disease. The criticism had reference chiefly to the identity of the fungi causing the disease. Briosi and Farnete insist on the correctness of their determination that *Melanconis perniciosum* is distinct from *M. modonia*. The whole question is fully discussed.

In a later paper (*Atti Ist. Bot. Univ. Pavia*, 1918, Ser. 2, **15**, 323–30) the authors describe the various stages of attack by the disease; that trees of all ages, even seedlings, may be infected. They repeat that the evil is due to fungi, and not to soil conditions or to root trouble. A. L. S.

Spoilage of Cranberries after Harvest.—This subject has been investigated by C. L. SHEAR, NEIL E. STEVENS, R. B. WILCOX, and B. A. RUDOLPH (*U.S. Dept. Agric. Bull.*, No. 714, 1918, 1–20), as large quantities of berries are produced in the States, and about 15 p.c. of the crop is lost between the field and the consumer. The spoilage may be the result of several causes, but at least half the damage is done by fungi. The chief rots which develop after picking are: early rot, *Guignardia Vaccinii*; end-rot, *Fusicoccum putrefaciens*; bitter-rot, *Glomerella cingulata Vaccinii*; ripe-rot, *Sporonema Oryzocci*; blotch-rot, *Acanthorhynchus Vaccinii*; and soft-rot, *Penicillium* sp. The writers deduce from their observations the necessity for spraying to prevent fungus infection, especially in early stages of growth; careful handling and picking of the fruit; and cool conditions during packing, storage, etc. A. L. S.

Investigations on the Narcissus Disease.—This very serious disease of Narcissus bulbs was ascribed for some time to the attack of a soil fungus, *Fusarium bulbigenum*. An investigation carried out by J. K. RAMSBOTTOM (*Journ. Roy. Hort. Soc.*, 1918, **43**, 51–64, 10 pls.) has

resulted in the discovery that the disease is due to the eel-worm, *Tylenchis devastatrix*. *Fusarium* is constantly present, and two species were isolated and grown in pure cultures during the course of the investigation. A. L. S.

Rhizoctonia on Lawns and Pastures.—C. V. PIPER and H. S. Cox (*Phytopathology*, 1919, 9, 89-92, 2 pls.) have been for some time investigating the damage done to golf courses, etc., by the fungus *Rhizoctonia Solani*. The disease attacks the growing plants, which quickly become brown and die off. It is mostly grasses that are destroyed in these areas, but other plants present, such as *Cerastium vulgatum*, *Achillea millefolium*, etc., are likewise affected. Advice is given as to dealing with the trouble. A. L. S.

Silver-leaf in Fruit-trees.—A paper on this subject has been published (*Journ. Board. of Agric.*, 1919, 26, 162-8, 2 pls.) both in the Journal and as a leaflet of the Agricultural Board. The disease is definitely traced to the action of *Stereum purpureum*, and the work done by F. T. BROOKS on the subject is cited. Other causes may originate "silver-leaf," but so rarely that they are practically negligible in a study of the disease from the grower's point of view. Various recommendations are made as to the treatment of the affected trees and of the soil. Certain varieties of plum-trees have been proved to be resistant, and these should preferably be planted. A. L. S.

Undescribed Species of Ophiodothella on Ficus.—This Dothi-deaceous fungus has been described by ERNST A. BESSEY (*Mycologia*, 1919, 11, 55-7, 1 pl.). It grew on *Ficus aurea*, in the vicinity of Miami, Florida. The stromata of the fungus occupy yellowish-green spots on the leaves. When strongly infected the leaves fall in great numbers. The species is fully described and figured. A. L. S.

Two Illinois Rhubarb Diseases.—Two diseases of market rhubarb have been investigated by FRANK LINCOLN STEVENS (*Univ. Ill. Agric. Exp. Stat. Bull.*, No. 213, 1919, 299-312, 18 figs.). The first, called "rhubarb anthracnose," due to *Colletotrichum crumpens* Sacc., causes soft rot of the petioles and renders them unsaleable. Stevens discusses the systematic position of the fungus; he finds ten nearly related forms on different hosts.

The second disease dealt with is a *Phyllosticta*, which occurs on spots on the leaves as well as on the petioles. Successful cultures were made, and, when thickly sown, growth from spore to spore took place in thirty-six hours. Stevens has decided that the species agrees in the main with *P. straminella*, recorded on *Rumex acetosa*. A. L. S.

Notes on Parasitic Fungi in Wisconsin. IV.-VI.—These notes, published by J. J. DAVIS (*Trans. Wisc. Acad. Sci. Arts and Letters*, 1919, 19, 671-727, Part II.), cover a large field of microfungi, many of them already described, but their descriptions are now enriched by biological notes. A number of new species are also published. An index of the hosts as well as of the parasites is appended. A. L. S.

PROCEEDINGS OF THE SOCIETY.

—o—o—o—

AN ORDINARY MEETING

OF THE SOCIETY WAS HELD AT 20 HANOVER SQUARE, W., ON WEDNESDAY, MARCH 19TH, 1919, MR. J. E. BARNARD, PRESIDENT, IN THE CHAIR.

The Minutes of the preceding Meeting were read, confirmed, and signed by the President.

The nomination papers were read of three Candidates for Fellowship.

New Fellows.—The following were elected Ordinary Fellows of the Society :—

Captain Raymond Sydney Harper, M.R.C.S., L.R.C.P., R.A.M.C.
 Rev. A. F. Gordon Mackay.
 Mr. Angus Duncan Macpherson, M.B.
 Mr. Albert Taylor.

The Financial Statement for the year 1918, which should have been included in the Annual Report of the Council, was now presented by the Treasurer, and is inserted on the next page.

FINANCE.

The Revenue Account shows an excess of Expenditure over Income of £23 12s. 1*d.*

Owing to the fact that it has been impossible to get out Part 4 of the Journal before the end of March, the Council have placed the amount of £150 to a Suspense Account for the printing of this Number of the Journal.

Compared with last year, the Income of the Society shows an increase. The amount received from Subscriptions, Admission Fees and Journal Sales have risen, while the Expenditure has only risen by about £40.

Dr. REVENUE ACCOUNT FOR THE YEAR ENDING 31st DECEMBER, 1918. Cr.

	£	s.	d.
To Journal (Parts 1, 2, 3)—			
Editing	62	4	6
Illustrating	47	9	5
Printing	359	16	6
Postages	18	6	9
Reserve for Part 4	150	0	0
Rent and Insurance	637	17	2
Salaries and Reporting	161	17	9
Library, Books, Papers and Binding	235	18	10
Sundry Expenses—	20	5	3
Stationery, Printing, etc.	86	10	11
Petty Expenses and Postages	31	4	2
	117	15	1
	£1173	14	1
By Subscriptions	634	1	1
By Admission Fees	67	4	0
By Journal—			
Sales	294	13	0
Advertisements	29	9	10
By Sundry Sales	324	2	10
By Interest on Investments	184	12	6
By Balance	106	1	7
	2342	1	1
	£1173	14	1

Dr.

BALANCE SHEET, 1918.

Cr.

	£	s.	d.		£	s.	d.
To Capital Funds	£127	17	4	ASSETS.			
By Show Case Fund	12	15	9	By Cash—Deposit Account	300	0	0
By Life Membership	31	10	0	Current Account	53	14	4
By Life Composition received 1918	31	10	0	Petty Cash Account	1	16	4
By Sundry Creditors	63	0	0	Investments, as per last Balance Sheet—			
By Suspense (for Part 4 of Journal)	328	4	8	£400 North British Railway 3% Deb.
By Reserve Account as at Dec. 31, 1917	150	0	0	£500 Nottingham Corporation 3% Deb.
Less Balance from Reserve Account	71	18	8	£612 Caledonian Railway No. 1 Pref.
	23	12	1	£915 India 3%
	48	6	7	£150 Metropolitan Water Board 3%
	£2730	4	4	£421 War Loan 5%
				Stock of Screw Gauges	1981	14	0
				Property Account, as per last Balance Sheet	18	16	0
				Sundry Debtors	164	1	6
					210	2	2
	£2730	4	4		£2730	4	4

We have examined the foregoing account and compared the same with the Vouchers in the possession of the Society. We have verified the Securities and find the same correct.

C. F. HURT, *Hon. Treasurer,*
19th March, 1919.

J. CLIBBORN, *Et.-Col.}*
J. WILSON } *Auditors.*

The value of the Society's Securities has been left at the same figure as last year. The Society's Holding in New South Wales $3\frac{1}{2}\%$ being due to be paid off during the year, the stock was sold and the amount realized was invested in £612 Caledonian Railway No. 1 Preference Stock. The Investment Account therefore remains at £1981 14s.

During the year one Life Composition Fee has been received, and this amount has been placed to the credit of Life Membership Account.

The balance of the Revenue Account has been charged against Reserve Fund, and this Fund is therefore reduced by £23 12s. 1d., and now stands at £48 6s. 7d.

The high cost of Printing and the difficulties arising out of the war compel the Council to continue to restrict the issue of the Journal to four Numbers.

Mr. Scourfield exhibited a slide, presented by Mr. G. H. Wailes, F.L.S., of *Nebela scutellata* Wailes, from Lakehurst, New Jersey, showing secondary plates covering the gaps between the somewhat irregularly placed ordinary plates. The species was described for the first time by Mr. Wailes in his paper on "Fresh-water Rhizopoda and Heliozoa from the States of New York, New Jersey, and Georgia, U.S.A., with Supplemental Note on Seychelles Species" (see Journ. Linn. Soc., Zoology, xxxii. (1912) p. 139, pl. xii. figs. 11, 12).

A vote of thanks to Mr. Wailes was proposed by the **President**, seconded by **Mr. Heron-Allen**, and carried.

Mr. Pledge (for the Wratten Division of Kodak, Ltd.) exhibited three new colour-filters adapted for Microscopy.

The thanks of the Meeting were accorded to Mr. Pledge.

Dr. Nathan Mutch, M.A., M.R.C.P. (Guy's Hospital), gave a Demonstration of "A Simple Method for the Isolation of Single Bacteria for the Preparation of Pure Cultures."

A description of the apparatus exhibited will appear in the Journal. The thanks of the Meeting were accorded to Dr. Nathan Mutch.

Mr. J. Bronté Gatenby, Senior Demy, Magdalen College, Oxford, read a paper on "The Identification of Intracellular Structures," with an exhibition of slides and lantern illustrations.

At the suggestion of the **President** it was agreed to defer the discussion until the April Meeting.

The paper will be published in the Journal.

Lieut-Col J. Clibborn, C.I.E., B.A., read a paper on "A Standard Microscope."

The President stated that the sole object of bringing the matter forward was a desire to be helpful, and it was fairly obvious that the Society should be in a position to assist in the matter of microscope design and the adaptability of different types for particular work. The paper was entirely a personal matter on the part of Col. Clibborn, and the Society was supporting him on the ground that publicity should be given to his views.

Mr. Conrad Beck stated that the British Science Guild appointed a Committee, which went into the matter and discussed it with the manufacturers, and they then sent out a long list of questions to the Universities and other Institutions. He had pointed out to that Committee that unless some scheme of standardization was produced the microscopist after the war would have to pay three or four times the price for his instrument. But it was equally important that a standard microscope if produced should be adopted. Each one had his own particular attachments, and had a preference for a certain stage or stand. That made it extremely difficult to produce microscopes on what Col. Clibborn had described as manufacturing economically. The Committee's Report contained specifications of standard microscopes, but did not go into the manufacturing details. If microscopes were to be made on satisfactory lines at a reasonable cost, they must be made under totally different conditions. Hand labour would have to be very largely reduced and machinery introduced. His own firm had found that machine tools of greater precision than had been hitherto used were necessary. He thought that anything done by the Society should be by way of suggestion to the Committee that was already in existence. He had hoped to hear some suggestions that would have been of use in criticizing the Report as to the suggested special lines upon which a standard microscope should be designed. The manufacturers worked under great difficulty during the war, and until after November 11 last no microscopes were allowed to be made; the factories were all engaged on optical instruments. Firms, however, were now spending 1000*l.* per month in manufacturing tools for the production of microscopes. The trade was working on the specifications brought forward by the Committee. They would also be interested to learn that the optical industry had started a Research Association, and had been fortunate in securing the services of Sir Herbert Jackson as Director.

Professor Cheshire said that in the future British manufacturers must make goods for the world's markets with interchangeable or standard parts by repetition machinery and unskilled labour. Before the war a certain large lens was roughed out by hand labour at 30*s.* per week, and ten to twelve on the average were turned out each week. When war came they paid a girl 30*s.* per week, and with a machine had an output of more than a thousand per week. In the future a standard microscope made from standard parts by repetition machinery meant a stereotyped instrument.

The President, in submitting a resolution thanking Lieut.-Col. Clibborn for his paper, referred to the work of the British Science Guild.

He had been a member of the Committee that was appointed, and the Society had been in close touch with it, but he had not considered the recommendations as final, and had hoped that in future considerations a somewhat broader view might be taken as to what the requirements were.

The vote of thanks was carried by acclamation.

On the suggestion of **Professor Cheshire**, supported by **Mr. Blood** and **Mr. Hill**, it was agreed that the Specifications for Standard Microscopes as recommended in the Report of the Microscope Committee of the British Science Guild should be published in the Journal of the Society.*

The President announced that the next Meeting of the Society would be held on April 16, and of the Biological Section on April 2, when communications would be made by **Mr. Taverner** and **Sir Nicholas Yermoloff**, K.C.B., K.C.V.O.

AN ORDINARY MEETING

OF THE SOCIETY WAS HELD AT NO. 20 HANOVER SQUARE, W., ON WEDNESDAY, APRIL 16TH, 1919, **MR. J. E. BARNARD**, PRESIDENT, IN THE CHAIR.

The Minutes of the preceding Meeting were read, confirmed, and signed by the President.

The Nomination Papers were read of seven candidates for Fellowship.

New Fellows.—The following were elected Ordinary Fellows of the Society :—

Mr. Walter H. M. Lauwers, F.P.S.L.

Mr. William Whiteman Topley, M.B., F.R.C.P., M.R.C.S., etc.

Mr. George William Watts, L.D.S.(Eng.).

Mr. E. J. Sheppard, in opening a discussion on the paper read by **Mr. J. Bronté Gatenby** at the March meeting, "The Identification of Intracellular Structure," said it was very interesting that the author of the paper, after pressing in a very marked way the methods of Golgi,

* For this Report see p. 199.

went on to say that cytologists would not be carried much farther without great improvement in the manufacture of microscope lenses, and even if things were much improved it was doubtful if they would see much more structure. It seemed strange to hear that the silver-nitrate reductions were extremely capricious and great care must be taken in the interpretation of the images given. Another point was that the present list of fixatives and methods of technique for the representation of cell structure was already overcrowded, and, in his (the speaker's) opinion, required to be weeded out. He was recently exhibiting at a *Conversazione* at King's College some successful specimens of *Forficula auricularia* (common earwig) which clearly showed centrosomes and spindle fibres. Dr. Ross, who was present at that Meeting, was asked to look at the preparations. Dr. Ross gave little time to the examination, but quickly pronounced the results shown to be due to artefacts. Being surprised at this statement further attempts were made in order to show these spindle fibres and centrosomes under as nearly living conditions as possible. By the following August he had been able to gain a certain amount of expertness in getting out the testes of the earwig in about three-quarters of a minute. While they were under survey it was easy to see the spindle fibres and centrosomes. The standard of living condition was judged by the motility of the flagella of the spermatozoa. While they were in active movement the cells were considered to be living; as soon as the motion ceased the cells were looked upon as dead and disregarded for further observation. He considered that to be sufficient evidence that the spindle fibres and centrosomes were cytological facts, and not the result of artefacts. After establishing a fact like that, there were no limits as to what might be seen under dark-ground illumination. It should be quite possible to see structures such as Mr. Gatenby had described.

Dr. Murray said that the mitochondria could be seen by means of dark-ground illumination, and the evidence was very convincing. He was particularly interested in Mr. Gatenby's work, and believed it would lead them to more knowledge on the subject.

Dr. Da Fano also spoke.

Mr. Gatenby, in replying to the discussion, said that they had been able to see that evening that there was such a thing as the Golgi apparatus, and the mitochondria could be seen by dark-ground illumination. The point was whether the mitochondrion was a fact; whether the Golgi apparatus was a fact. It would be very nice to have them of a beautiful shape—but there they were. They were grotesque shapes, and he had had nothing to do with the making of them. The spindle fibres did not come into the question. He had not done much in dark-ground illumination; he had tried the mitochondria with it, but found that the cell had to be particularly big before one could get far with it. But he had watched the mitochondria in the living cell with ordinary illumination. It had been shown that the mitochondria move about, and they had been watched *intra vita* in the living cell. Tracing the Golgi apparatus through had been worked out by himself and another in a mollusc. The Golgi apparatus had been traced to the primordial nerve-ganglion in the mollusc.

The President said he did not pretend to have any particular knowledge of the subject. It seemed to be a question of deciding by staining methods whether the result bore any definite relation to the true structure. The only method to determine whether tissue such as had been described was of a certain definite structure must be to confirm that structure by methods which were in accordance with the laws of microscopical science. By means of dark-ground illumination it was easy to determine the structure of bacteria unless the cells were beyond the limits of resolution. The only other method by which they could see the structure was by using ultra-violet light, and that method had proved to be most valuable. One did not put a preparation into osmic acid for a fortnight, but examined it within a few minutes from the time it was spread. Dark-ground illumination should demonstrate the whole of Mr. Gatenby's points. He would like to thank Mr. Gatenby for having brought the subject forward, and would ask him, on behalf of the Society, to deal with some similar subject on a future occasion.

The thanks of the Meeting were accorded to Mr. Gatenby for his paper. (The paper will be found on page 93.)

Mr. James Strachan read a paper on "The Chemistry of Dendritic Growths in Paper," with an introductory account of dendrites and dendritic growths. It was illustrated by means of specimens and lantern slides.

Mr. Blood asked whether the marks on engravings in bound books were dendritic growths. He had noticed that engravings near the cover bore marks, while those in the centre were free from them.

Mr. Strachan said in reply that any substance that crystallized would form dendritic growths, and most substances would crystallize. In reference to the marks on engravings, very few of them were dendritic growths. The majority were caused by mildew, fungi, and bacteria.

A vote of thanks was accorded to Mr. Strachan for his paper, which will be published in the Journal.

Mr. Scourfield read a paper contributed by Dr. E. Penard on "*Folliculina Boltoni* S. Kent," which will be published in the Journal.

The thanks of the Meeting were accorded to Dr. Penard and Mr. Scourfield.

The President announced that at the next Meeting of the Society, on May 21, the Annual Exhibition of Microscopic Pond Life would be held, and that the next Meeting of the Biological Section would be held on May 7, when a communication would be made by Mr. N. E. Brown, A.L.S., on "Starch and its Formation."

AN ORDINARY MEETING

OF THE SOCIETY WAS HELD AT 20 HANOVER SQUARE, W., ON WEDNESDAY, MAY 21ST, 1919, MR. J. E. BARNARD, PRESIDENT, IN THE CHAIR.

The Minutes of the preceding Meeting were read, confirmed, and signed by the President.

The Nomination Papers were read of seven candidates for Fellowship.

New Fellows.—The following were elected Ordinary Fellows of the Society :—

Major George C. Brunnelle, Ph.C., M.D.
 Mr. Theodore Bausch Drescher.
 Mr. Thomas Gifford Elliott, F.I.C., F.C.S.
 Sir Robert Hadfield, Bart., D.Sc., F.R.S.
 Mr. John Henry Harvey, F.C.S.
 Rev. Herald Parish.
 Mr. Thomas Willis Brown Tomlinson.

Donations were reported from :—

The University of Chicago Press—
 “The Living Cycads” (C. J. Chamberlain).
 Messrs. Chapman and Hall, Ltd.—
 “Fresh-water Biology” (H. B. Ward and G. C. Whipple).

The thanks of the Meeting were accorded to the donors.

The death of **Sir Frank Crisp, Bart.**, a Fellow of the Society, was reported by the President, who said that for many years Sir Frank Crisp had taken a very important part in the work of the Society, and it was largely due to his efforts that it had achieved success. He was sure it would be the wish of the Fellows to express their sympathy with the members of the family, and he would therefore ask them to signify the same by standing for a few moments.

Pond-Life Exhibition.—The President then called upon Mr Scourfield to make some observations on the Annual Exhibition of

Microscopic Pond-Life which had been arranged by Fellows of the Society and Members of the Quekett Microscopical Club.

Mr. Scourfield said that before dealing with the Pond-Life Exhibition he would like to call attention to the book on Fresh-water Biology, by Ward and Whipple, which had been presented to the Society. It was a book that should prove extremely useful to all students of Pond-Life, for although it would not replace the monographs and papers with which the specialist in each group had to work, it was certainly the most comprehensive single work on Fresh-water Biology that had yet appeared in English. Dealing as it did with the American fresh-water fauna and flora, some of the species, and even whole groups of species, were peculiar to that continent, but after all the great majority of the forms were the same as in this country, and the book could be highly recommended to those who wished to have a general review of all types of pond-life organisms in one volume.

In regard to the Pond-Life Exhibition that evening Mr. Scourfield said he thought it was self-evident that one of the good features about such exhibitions was that they encouraged the study of the living organisms. This was all to the good, for there was a big field for work in this direction in spite of what had already been done. We were undoubtedly very ignorant about the natural activities of many, perhaps most, aquatic creatures, both fresh-water and marine, and naturally the only way of acquiring such knowledge was by studying the organisms while they were alive. Without entering into all the ramifications, bionomical, physiological, etc., of the study of living organisms, he would nevertheless like to refer to a few cases in which correlation of structure or other modification to particular modes of life or conditions of existence could only be understood by a study of the living organisms.

Taking first the adaptations for life among weeds and algæ, many modifications were to be found for the purpose of attachment, some of which were not at all evident at first sight. For instance, there was *Simocephalus*, one of the Daphnidae, which was enabled to cling to weeds, and even glass, by means of an excessively minute hook at the tip of one seta only on each of the large antennæ. The hook was so minute and inconspicuous that no one could have guessed its use if the habits of the living animal had not been studied. And yet the possession of these tiny hooks made the most profound difference in the life of the animal, for instead of having to "hop" incessantly, as was the case with the nearly related *Daphnia*, it could suspend itself as long as it liked without effort. Equally remarkable organs of attachment were possessed by *Sida* and *Graptoleberis*, the former having a special organ at the back of the neck, and the latter a flattened ventral margin fringed with densely plumose setæ. In both cases it would have been impossible to have foretold the use of such modifications except by watching the living animals.

In connexion with adaptations for planktonic conditions of existence the case of *Diatomus* and its allies might be mentioned. In these Copepods the second antennæ and the maxillæ were used as accessory organs of locomotion, which by means of very rapid vibrations enabled the animals to glide through the water without the necessity of using

their powerful swimming feet except occasionally. Such a use could hardly have been predicted from structure alone, but became evident when the living animals were closely observed.

Among the cases of adaptation for life resting on the surface of the mud or other bottom sediment might be instanced *Acantholeberis* and *Latona*, both of which exhibited a very peculiar development of the setæ bordering the posterior ventral margins of the valves. Here again it would be difficult to guess the significance of these setæ without a knowledge of the habits of the living animals.

Lastly, with regard to adaptations for life on the underside of the surface-film the cases of *Scapholeberis* and *Notodromas* could be taken, both of which, although belonging to quite different orders of the Entomostraca, showed peculiar and very similar modifications, such as the flattened ventral area, the dark coloration of the ventral parts of the shell, etc., which would be unintelligible unless the habits of the living animals were known.

As would have been noticed the illustrations given had all been taken from the group of the Entomostraca, but every specialist would be able to add from his own experience similar cases of peculiar modifications only to be interpreted by a study of the living animals. And in addition to the known cases, there were undoubtedly a much larger number which had yet to be explained by the same means. New methods of collection and observation would no doubt be very helpful in this connexion. At any rate the customary methods of collection which produced jumbled masses of all sorts of aquatic organisms, usually from all sorts of situations, were somewhat crude, and it appeared evident that for the study of the habits of the living organisms the aim of the collector should be to secure his specimens as nearly as possible in their normal natural surroundings.

Mr. Scourfield then proceeded to refer briefly to the objects exhibited.

The President said he could not usefully add a single word to the remarks made by Mr. Scourfield, who had dealt with the matter so efficiently. He would like to propose, "That a hearty vote of thanks be accorded to the Fellows of the Society and to the Members of the Quekett Microscopical Club who have exhibited specimens, and to Mr. Scourfield for the remarks he has made on the exhibits."

Carried unanimously.

The President announced that the next meeting would be held on June 18, and the next meeting of the Biological Section on June 4, when Mr. E. J. Sheppard would make a communication on "Some Original Work on the Rat Flea."

The business proceedings then terminated.

The following Objects were Exhibited:—

- Mr. T. Cox *Anacharis*, showing cyclosis.
 Mr. D. Davies *Simocephalus vetulus*.
 Mr. A. Downs *Volvox globator*.
 Mr. F. Martin Duncan . *Hydrachna globosa* (from *Dytiscus marginalis*).
 Mr. E. D. Evens *Actinosphærium eichhornii*; also *Proales*, parasitic in *Volvox*, and *Conochilus volvox*.
 Mr. A. J. French *Spirogyra* sp. and *Batrachospermum* sp.
 Mr. A. Hardcastle *Stephanoceros eichhornii*.
 Mr. C. E. Heath *Closterium* sp.
 Mr. W. J. Ireland *Nitella*, showing cyclosis.
 Mr. H. Jewell *Melicerta ringens*.
 Mr. A. Morley Jones *Floscularia ornata*.
 Dr. J. Rudd Leeson *Oscillatoria* sp.
 Mr. E. R. Martin *Volvox aureus*.
 Mr. E. K. Maxwell *Pterodina patina*, *Paludicella*, and *Zoothamnium*.
 Mr. J. C. Myles *Melicerta ringens*.
 Mr. E. R. Newmarch *Epistylis* sp. (on *Utricularia*).
 Mr. J. M. Offord *Volvox globator*, *Hydra viridis*, and *Synchæta* sp.
 Mr. F. Parsons *Diaptomus gracilis* and *Caddis* larva.
 Mr. F. J. W. Plaskitt *Oscillatoria tenuis*.
 Captain A. F. C. Pollard . *Floscularia ornata*.
 Mr. P. E. Radley *Epistylis* sp.
 Mr. J. Richardson *Utricularia*.
 Mr. W. Russell *Epistylis* sp. (on *Cyclops*).
 Mr. D. J. Scourfield *Simocephalus vetulus*.
 Mr. R. S. W. Sears *Vorticella* sp.
 Mr. C. J. H. Sidwell *Simocephalus vetulus*, showing minute hook on antennal seta by which animal clings to weeds, etc.
 Mr. A. E. Smith *Daphnia magna*.
 Mr. T. J. Smith *Corethra plumicornis* larva.
 Mr. C. D. Soar Water-mites — *Brachypoda versicola*, *Arrhenurus globatus*, ♀, *Piona fuscata*, nymph.
 Mr. B. J. Thomas *Vorticella nebulifera*.
 Mr. W. R. Traviss *Spongilla*, showing exhalent cone.
 Mr. G. W. Watts *Euglena viridis*.
 Mr. H. C. Whitfield "Green Drake" larva.
 Mr. J. Wilson *Closterium* (3 spp.), *Microsterias* (2 spp.), *Cosmarium botrytis*, *Euastrum oblongum*.
 Mr. G. W. Young *Conochilus volvox*.

ROYAL MICROSCOPICAL SOCIETY

MEETINGS FOR THE SESSION 1919—1920

AT 8 P.M.

Wednesday, Oct. 15, 1919	Wednesday, Feb. 18, 1920
„ Nov. 19, „	„ Mar. 17, „
„ Dec. 17, „	„ Apr. 21, „
„ Jan. 21, 1920	„ May 19, „
<i>(Annual Meeting for Election of Council and Officers.)</i>	„ June 16, „

Council Meetings are held on the third Wednesday, Meetings of the Biological Section on the first Wednesday in each month from October to June.

Fellows intending to exhibit any Instruments or Objects, or to bring forward any Communications at the Ordinary Meetings, are requested to inform the Secretaries a week before the Meeting if possible.

The Library and Rooms of the Society are open for the use of Fellows on Wednesday Evenings, other than Meeting-evenings, from six to nine o'clock, except during the vacations.

REPORT OF THE MICROSCOPE COMMITTEE OF THE
BRITISH SCIENCE GUILD.

(Revised.)

*First published in the "JOURNAL of the BRITISH SCIENCE GUILD" for
January, 1916.*

THIS Committee was appointed by the Guild for the purpose of "taking steps to improve the existing conditions governing the manufacture of microscopes in this country, and to further the efforts of our manufacturers to secure the German trade which has ceased owing to the war."

The Committee consisted of the following :—

Colonel SIR RONALD ROSS, K.C.B., K.C.M.G., F.R.S.
(Chairman).

Dr. F. W. ANDREWES, F.R.S.

F. WATSON BAKER (Messrs. Watson and Sons).

Dr. ANDREW BALFOUR, C.M.G.

J. E. BARNARD, Esq. (Royal Microscopical Society).

Fleet-Surgeon P. W. BASSETT SMITH, R.N., C.B. (Admiralty).

Dr. H. LYNCH BURGESS (Colonial Office).

CONRAD BECK, Esq. (Messrs R. and J. Beck).

Prof. F. J. CHESHIRE, C.B.E. (Royal Microscopical Society).

C. LEES CURTIES, Esq. (Messrs. Baker).

Lieut.-Colonel J. W. GIFFORD, F.R.A.S.

Colonel HARVEY (War Office).

Prof. R. T. HEWLETT.

Colonel Sir WILLIAM LEISHMAN, F.R.S.

Dr. T. A. MATTHEWS.

EDWARD W. NELSON, Esq., J.P.

SIR ALEXANDER PEDLER, C.I.E., F.R.S. (The late).

Dr. F. MOLLWO PERKIN.

J. PILLISCHER, Esq. (Messrs. Pillischer).

W. SHACKLETON, Esq., F.R.A.S. (India Office).

HERBERT F. SMITH, Esq. (Crown Agents for the Colonies).

MANSELL P. SWIFT, Esq. (Messrs. Swift and Sons).

Major TODD.

Dr. R. M. WALMSLEY.

At the initial meeting of this Committee a Sub-Committee was appointed, composed of the following members :—

Dr. F. W. ANDREWS, F.R.S. (*Chairman*).
 Dr. ANDREW BALFOUR, C.M.G.
 J. E. BARNARD, Esq.
 Fleet-Surgeon P. W. BASSETT SMITH, R.N., C.B.
 Prof. F. J. CHESHIRE, C.B.E.
 Dr. JOHN EYRE.

Hon. Secretaries.

Sir ALEXANDER PEDLER, C.I.E., F.R.S. (The late).
 Dr. F. MOLLWO PERKIN.

The Sub-Committee visited the Works of the principal makers to see what facilities existed for the manufacture of microscopes, and drew up a circular letter, containing questions relating to the types of microscopes most in demand, and the prices which users of such microscopes would be likely to be prepared to pay. This letter was sent to the professors in fifty-four universities and other institutions where microscopes for medical research work are largely used. The replies showed a very large preponderance in favour of certain types.

As a result of these enquiries, together with the practical experience of the members of the Sub-Committee, certain specifications of the types of microscopes which seemed to be most generally useful were drawn up. These were circulated to the principal manufacturers, and a meeting of the Sub-Committee with these gentlemen was held. At this meeting the points raised were fully discussed, and the manufacturers agreed that the requirements were reasonable.

The following are the recommendations of the Committee as to the general types of instruments which should be manufactured.

All screws, threads, tubes and fittings should conform to the Royal Microscopical Society's standards, now verified and deposited with the Director of the National Physical Laboratory.

TYPE I.—A cheap instrument under £10, for the use of students.

1. *Stand*.—The modified Continental type, with jug handle; with spiral rack and pinion coarse adjustment.

2. *Tube*.—Short, with graduated draw tube, allowing for length of nose-piece; the available tube length should be from 140 mm. to 180 mm.

3. *Fine Adjustment*.—Lever type. Lateral milled heads.

4. *Stage*.—Large, square, fair-sized opening, provided with clips of simplest type, having points of contact level with equator of stage.

5. *Mechanical Stage*.—Not required, but provision made for its later addition.

6. *Sub-Stage Condenser*.—Abbe type, accurately centred and fitted with iris diaphragm.

7. *Nose-piece*.—Dust-proof. Position of objectives marked on nose-piece.

8. *Objectives*.—Two, of focal length 16 mm. and 4 mm. (or their equivalents), the latter with good working distance, both engraved with focal length, N.A., tube length and the magnification at the distance for which the objective is corrected, expressed by X

9. *Oculars*.—Two, of focal length 40 and 25 mm. Each ocular should be engraved with the initial magnification, the focal length in mm., and with a magnification number arrived at by dividing 250 by that focal length, and expressed by X

The microscope should be capable of carrying the additions required for more advanced work.

TYPE II.—A good instrument for advanced pathological work, price £15 to £20.

1. *Stand*.—Modified Continental jug-handle type, with spiral rack and pinion coarse adjustment.

2. *Tube*.—Short, with graduated draw tube; the scale to allow for length added to the tube by the changing device (viz. nose-piece). The available tube length should be from 140 mm. to 180 mm.

3. *Fine Adjustment*.—Lever type. Lateral milled heads of small diameter but long milled surface.

4. *Stage*.—Large. Square, with sufficient room to accommodate a large Petri dish. Clips of simple description, having points of contact level with equator of stage.

5. *Mechanical Stage*.—(a) Detachable type; rack and pinion covered through entire length and actuated by milled heads of small diameter, but with long milled surface. Must work smoothly and permit of examination of at least 2 in. of a 3-in. slide. (b) Built-in type.

6. *Sub-Stage Condenser*.—Abbe type. Rack and pinion, centreing, iris diaphragm.

7. *Triple Nose-piece*.—Dust-proof; position of the three objectives to be marked on nose-piece.

8. *Objectives*.—Three of 16 mm., 4 mm., and 3 or 2 mm. oil immersion. Colour of mount of immersion lens to differ from others, and preferably to be black. Each objective should be engraved with the tube length, the N.A., and the magnification at the distance for which the objective is corrected, expressed by X

9. *Oculars*.—Two, of focal length of 40 and 25 mm. Each ocular should be engraved with the initial magnification, the focal length in mm., and with a magnification number arrived at by dividing 250 by that focal length and expressed by X

TYPE III.—An instrument designed especially for research work, price £25 to £35; the character of this to depend on the individual requirements of the different workers.

1. *Stand*.—With spiral rack and pinion coarse adjustment, and to be equally stable in vertical or horizontal positions. The centre of mass should be kept as low as possible consistent with freedom of access to the sub-stage.

2. *Tube*.—Minimum diameter of body tube to be 50 mm. internally, with double draw tube, so that either long or short tube objectives can be used. Second draw tube to be 100 mm. long, and both draw tubes to be graduated in mm.

3. *Fine Adjustment*.—Lever type. Lateral milled heads on both sides of stand, of small diameter, but with long milled surface. Fine adjustment must be graduated.

4. *Stage*.—Circular rotating, with centring screws, and provided with a clamp. The mechanical part should be graduated with verniers and be detachable, and so fitted that when removed a plane surface is left. As an alternative, it should be built in with separate and independently operating milled heads.

5. *Objective Changing*.—Should have sliding objective changers, which should be provided with centring screws.

6. *Sub-Stage*.—Should have centring screws. Rack and pinion to be exceedingly well fitted and made. Sub-stage iris diaphragm should be rotatable, and should have rack-work lateral motion.

7. *Condenser*.—An achromatic immersion condenser which can be used dry.

8. *Dark Ground Illuminator*.—Type in which there are spherical reflecting surfaces. Some device in upper surface which, without interfering with the satisfactory working of the accessory, will indicate the axial centre.

9. *Objectives*.—The following battery of lenses should form the foundation, which would, of course, need addition for the particular research work engaged upon: 16 mm., 8 mm., 3 mm., or 2 mm., focal length. Each objective should be engraved with the tube length, the N.A., and the magnification at the distance for which the objective is corrected, expressed by X Mounting of immersion lenses to be distinctive, preferably black.

10. *Oculars*.—Two to form the basis of equipment, of 40 mm. and 25 mm. focal length. Each ocular should be engraved with the initial magnification, the focal length in mm., and with a magnification number arrived at by dividing 250 by that focal length, and expressed by X

GENERAL REMARKS.

The Committee desire to endorse the following observations:—

The popularity of Continental models depends on—

(a) The remarkably high and uniform quality of the lenses.

- (b) The fact that makers will renovate and repair lenses for an indefinite period, and will make good any deterioration due to spontaneous changes.
- (c) The uniformly good workmanship and cheap prices.

English stands are in many ways just as good value for the money as Continental, but rightly or wrongly there has developed the impression that English lenses are not of a uniform quality. Makers are credited with turning out a few first-class lenses, which are highly praised by experts, but when the student buys a lens he is often disappointed. Before the trade can be captured for British makers they must be able to turn out large numbers of cheap lenses of good quality and of good keeping properties. They can if they choose easily compete in the matter of stands.

The mounting of the lenses is very important. They should not be capable of being easily unscrewed, and the setting should be strong and accurate. The use of aluminium is not desirable in any constructional part of the instrument.

It is only by specializing on a few models that the above prices can be made profitable, and even then only by securing a very large output of high and uniform quality.

All available information would seem to indicate that the day of the small maker of either stands or lenses has passed. The high standard of excellence now insisted upon, together with the low prices to which buyers of microscopes have become accustomed as a direct result of foreign competition, would seem to show that the successful manufacturers of the future must be corporations of sufficient size to make it possible for them to utilize scientific guidance to the full, and to avail themselves to the greatest possible extent of special and labour-saving machinery for their work.

REPORT OF THE MICROSCOPE COMMITTEE.

First published in the "JOURNAL of the BRITISH SCIENCE GUILD" for November, 1916.

Members :—Dr. R. M. Walmsley (Chairman), C. O. Bannister, Esq., J. E. Barnard, Esq., Dr. E. H. Barton, F.R.S., Sir George Beilby, F.R.S., Professor F. J. Cheshire, C.B.E., Professor Cullis, Dr. C. Desch, Dr. J. W. Evans, J. W. Gordon, Esq., K.C., Professor A. Harker, F.R.S., Dr. Hutchinson, Sir Herbert Jackson, K.B.E., Professor Martin Lowry, F.R.S., Robert Mond, Esq., Dr. Rosenhain, F.R.S., Dr. J. E. Stead, F.R.S., Sir J. J. H. Teall, F.R.S., H. H. Thomas, Esq., and the Officers of the Guild.

The Committee has the honour to present the result of its labours in the form of three draft specifications for the following types of microscopes :—

- I. Petrological Microscopes for teaching purposes.
- II. Chemical Microscopes :—
 - (a) Simple form, for use in laboratories.
 - (b) Suggestions *re* chemical microscopes for advanced work.
- III. Metallurgical Microscopes.

These specifications embody the labours of the Committee at ten meetings, and in presenting them the Chairman reports that the procedure adopted by the Committee was to draft, in the first instance, provisional specifications and to circulate them to prominent firms, with an invitation to attend a conference at which they would be considered in detail. The invitations were cordially acknowledged, and the Chairman desires to record the obligations which the Guild is under, not only to the members of the Committee set forth above who have assisted at its deliberations, but also to members of the trade who have attended meetings at which the final drafts of the various specifications were settled. The thanks of the Guild are especially due to Mr. Mansell P. Swift (Messrs. James Swift and Son), and to Mr. F. W. Watson Baker (Messrs. W. Watson and Sons, Ltd.).

Unfortunately, owing to the urgent demands of war business, other manufacturers who in ordinary times would willingly have assisted the Committee, were unable to send representatives to attend its meetings. It is believed, however, that the agreed specifications reported are such as will meet with the general approval of the manufacturers.

SPECIFICATIONS.

I. Draft Specifications of Students' Petrological Microscopes for teaching purposes. The price of the Petrological Microscope, for which the following general specification is suggested, should not exceed £15, with such fittings and accessories as are specified in paragraphs 1 to 9.

1. *Stand* to be substantial and secure, with ample space between table and stage; horizontal axis for tilting; and instrument capable of being used and standing firmly in the vertical, inclined, and horizontal positions.

2. *Rotating Stage* to be not less than $4\frac{1}{2}$ in. diameter, graduated in degrees, with vernier reading to $5'$. Also fitted with central, detachable, perforated, spoon-shaped, spring clip with turned-up internal edges; or a pair of movable lateral slips, with dimpled ends.

3. *Mechanical Tube Length* of 160 mm. with the following adjustments:—

i. *Coarse Adjustment* by diagonal rack and pinion, graduated so that one interval corresponds to a complete turn of the fine adjustment.

Fine Adjustment graduated up to 10 microns on circumference of milled head; the screw should be sufficiently accurate throughout its acting length to enable measurements to be made within the above limits.

ii. *Clamp* for fixing objectives to nose-piece, or alternatively the ordinary double nose-piece.

iii. *The Necessary Centreing Screws* to be fitted on nosepiece only, and a slot provided between the centreing nose-piece and the aperture of the analyser for the insertion of accessories, at 45° to the cross wires.

4. *Sub-Stage Fittings and Accessories, Optical and Mechanical.*

i. *Mirror* to be plane and concave, in the usual gimbal fitting, so attached as to provide an adequate range of distance between mirror and stage in view of the range of focussing of the sub-stage and the presence of the polarizer.

ii. *Condenser* to be in one fitting with polarizer, but removable either as a whole or in part; the whole fitting to be adjustable vertically.

iii. *Polarizer* to be carried in swing-out frame; to be capable of rotation on the microscope axis, with spring catch at zero reading, the rotation to be graduated at degrees 0, 90, 180, and 270, and the plane of vibration in the zero position to be left and right.

iv. *A Slot* for the insertion of accessories in a position at 45° to the cross wires above the polarizer, and sufficiently below the condenser to allow a slight lowering of the condenser to bring an image of a diaphragm or other accessory to coincide with the object.

5. *Objectives* 30 mm. and 6 mm., showing no optical evidence of strain; the 6 mm. objectives to be of not less than 0.8 N.A. Objective barrels to be of such length as to give approximate focus on interchange. The N.A. and equivalent focal length to be plainly indicated on each objective.

6. *Analyser* to slide in and out of lower part of tube and to be accurately crossed with the clicked polarizer.

7. *Ocular* to be fitted with cross wires in the form of spider lines, or ruled glass plate accessible for cleaning, slotted at 45° to cross wires

for insertion of accessories in focus, cross wires to be accurately parallel to the planes of polarization. The ocular to be engraved with the equivalent focal length.

8. *Diaphragms* with holes of different sizes, and others with central stops for dark-ground illumination corresponding with the objectives.

9. *Gypsum Plate*, showing red or violet of the first order.

ACCESSORIES.

The following accessories are to be regarded as additional and not included in the price specified. Some of them will not be required by ordinary students.

10. *Beck Lens*, which can be placed on ocular, to be capable of being focussed. It should be provided with cross wires and a slot, and should be capable of rotation and graduated for every 5° .

11. *Bertrand Lens* in metal carrier for insertion in the slot above the objective.

12. *Extra Analyser*, which can be placed either on the ocular or the Beck lens, capable of rotation and graduated for every 5° .

13. *Quartz Wedges*, ordinary, graduated, combination and double. The form especially recommended is a graduated combination wedge with projecting gypsum plate, the graduation being in hundreds of micro-millimetres of relative retardation.

14. *Mica Steps*, progressing by relative retardation of 100 micro-millimetres.

15. *Stage Micrometer* in metric units, and to include sub-divisions of 100 and of 10 microns with an accuracy of not less than 5 p.c.

16. *Squared Ocular Micrometer* in metric units, with an accuracy of not less than 5 p.c.

17. *Nakamura Plate*. (A modification of the plate in the Bertrand ocular.)

II. (a) Draft Specification of a simple form of microscope for general use in Chemical Laboratories when something rather better than a hand magnifying glass is required. The price complete for the microscope specified, with one objective and ocular in case, is to be about £3, without the accessories.

(1) *Stand*.—Fixed upright form, on either tripod or horseshoe base. The limbs should be shaped so as to form a convenient handle.

(2) *Stage*.—A plain square stage with removable spring object clips. The stage should be blacked brass so that it can be temporarily covered, when corrosive fluids are being used, with a separate plain plate of glass supplied with the instrument. Standard-sized under-stage fitting, to take iris diaphragm if required.

(3) *Mirrors*.—Concave adjustable in two directions on arm, fixed as to distance from stage.

(4) *Focussing Arrangement*.—A good coarse adjustment only, with range sufficient to focus a 50 mm. objective.

(5) *Objective*.—One low power only, but any usual power between 50 mm. and 15 mm. as desired.

(6) *Ocular*.—One lower power only—e.g. 30 to 40 mm. focal length.

(7) *Finish*.—All black (permanently acid-resisting), including mounts of objectives, and milled heads of coarse adjustment.

Accessories.—Additional objectives, double nose-piece, iris diaphragm, eye-piece scale.

II. (b) The range of advanced work in Chemistry is so wide that no single microscope can satisfactorily cover the whole ground. The requirements for different kinds of work are also so wide apart that if an instrument were designed to satisfy all these requirements it would probably not be very good for any of them. One or other of the microscopes for advanced work for which specifications have been drafted will be suitable for different special classes of advanced chemical work. For general purposes the specification of the "Instrument for advanced Pathological work" (TYPE II. *supra*) may be adopted as a basis, with the following modifications:—

(1) The microscope should be provided with *polarizers* and *analysers* capable of being rotated simultaneously.

(2) The *stage* should be fixed and not less than $4\frac{1}{2}$ inches in diameter, fitted with central, detachable, perforated, spoon-shaped, spring clip with turned-up edges, or a pair of movable lateral clips with dimpled ends. [If a rotating stage is desired the arrangement in the Petrological type (*supra*) may be adopted.]

(3) The *sub-stage* should allow the use of a high power as well as of a fairly low power condenser—e.g. one of the well-known achromatic condensers of N.A. 0.9, either with or without the top lens; moreover, when this top lens has been removed it should still be possible to use the polarizer even when the instrument is in the upright position.

(4) *Mirrors* in the usual gimbal fitting, so attached as to provide an adequate range of distance between mirror and stage in view of the range of focussing of the sub-stage and the presence of the polarizing prism.

III. Draft Specification for a Metallurgical Microscope of simple type, intended for students and for general use in works and laboratories. Price not to exceed £15.

(1) *Stand*.—Form of foot immaterial, but stand must be strong and rigid. The limb, if inclinable, should be provided with an efficient clamp. Rigidity is of great importance when large or heavy specimens have to be examined, or when the stage is to be used at a long distance from the objective.

(2) *Stage*.—Coarse focussing by rack and pinion essential; ample bearing surface important. Fine adjustment must be on the stage. Stage to be plain with central opening for transmitted light, and a stop to close the opening when not required. The stage should be provided with a removable ridge against which the specimen or the object-carrier may rest when the instrument is in the inclined position. Strong spring detachable clips required. The movement of the stage should be sufficient to allow of a free working distance between the objective and the surface of the stage of not less than 4 inches, in order to allow of the use of a 3-inch objective with a specimen of fair thickness.

Facilities should be provided for the addition as an extra of a mechanical stage with concentric rotation and centring screws.

(3) *Body tube* should be short enough to allow of an effective tube length of 160 mm. ($6\frac{1}{2}$ in.), including the space occupied by the illuminator. A draw tube allowing the total tube length to attain 9 in. should be provided. No focussing movement for the tube is required.

(4) *Illuminator*.—The “vertical illuminator” should be incorporated in, or permanently attached to, the lower end of the body tube. The illuminator may either be made to rotate or be so arranged that light may be admitted from either side or from the front. The reflector should be mounted on a substantial fitting provided with a large milled head, and the reflector should be removable from the instrument, for purposes of interchanging different kinds of reflectors, without disturbing the objective. Totally-reflecting prism, clear glass disc and silvered glass half-disc reflectors should be provided. The illuminator and the lower end of the tube should be so arranged that the reflector can be brought down, or is normally placed, immediately above the back lens of the objective. The reflector should be adjustable in the direction at right angles to the optic axis, and should be set by an adjusting screw. The illuminator should be provided with an iris diaphragm, the position of which can be varied.

(5) *An Additional Illuminator* is required for use with very low powers; this should be supplied in the form of an arm attachable to the body tube or limb, and carrying a holder for either (or both) an opaque silvered reflector or (and) a thin plate of parallel glass—both these reflectors to be used between the objective and the specimen. Adjustment must be provided to allow this outside reflector to be brought down near the surface of a specimen at the extreme bottom position of the stage.

(6) <i>Objectives</i> .—Very low power	...	75 to 100 mm.
(Low Power	...	50 mm.)
Medium	...	16 mm.
(do.	...	8 mm.)
High	...	4 or 6 mm.
(Oil Immersion	...	2 mm. or 3 mm.)

(The objectives in brackets to be regarded as extras—not required by students.)

The objectives to be mounted in very short mounts (upper end as nearly as possible flush with the back surface of the top lens), to be corrected for use without cover glasses, and selected of a type avoiding internal reflections.

(7) *Two Eye-Pieces*, to be selected with magnifications of X 6 or 8 and X 10 or 12. If of the compensating type, to be selected with magnifications X 8 and 12 or 18.

JOURNAL
OF THE
ROYAL MICROSCOPICAL SOCIETY.

SEPTEMBER, 1919.

TRANSACTIONS OF THE SOCIETY.

VI.—*Tropical Diseases due to Microscopic Organisms in
the Balkanic Zone.*

By ALDO CASTELLANI, M.D., M.R.C.P., Lieut.-Colonel Italian
Medical Service (Naval Branch), Member of Permanent
Committee, Inter-Allied Sanitary Commission.

(Read December 18, 1918.)

ONE PLATE.

I.—MALARIA.

OF the diseases to which the Allied troops have been exposed in the Balkans, malaria is by far the most common and the most important. The number of cases of malaria throughout the Adriatic and Balkanic Zones during the years 1915–1917 has been appalling, and the cases of pernicious type quite common. Malaria has been the disease which has caused by far most invaliding among the Allied troops.

Unfortunately during recent years there arose in certain quarters in Europe, and even in tropical countries, a tendency to consider malaria as a not very dangerous disease. The recent experience in the Balkans, therefore, has come as a rude awakening, and has shown what a terrible scourge this disease can be.

The experience in Serbia, Macedonia, and the Adriatic Zone, in addition to showing the frequency and gravity of this malady, has also shown us what a protean disease it is. This of course is nothing new to the old tropical practitioner, but to the young medical man just out from home it is decidedly bewildering. It is especially on these protean features of the malarial infection, on what might be called mimicry, that I should like to say a few words. Malaria may simulate a stupendous number of different diseases.

The Hæmorrhagic Types of Malaria.—Near Skopolje, in Serbia, in September 1915, an outbreak of so-called scurvy was reported as occurring in a Serbian regiment, and I was asked to investigate the condition. The patients were extremely pale, felt very weak and languid, complained of pains in the loins and limbs; in most cases the whole body was covered with petechiæ, and tense indurated swellings due to large extravasations of blood were present in several cases. In many of the patients bleeding was taking place from the gums, which were swollen and spongy, and from the nose; in two cases there were hæmorrhages from the stomach and the intestine; in one there was hæmorrhage from the lungs and bronchi; in another from the kidneys and bladder. The exact diagnosis was most difficult, but the microscope cleared it; the blood was teeming with malarial parasites. In none of the cases was fever noticed, but the presence of a large indurated spleen in two of the patients, and the fact that I had seen similar cases in the Tropics, made me suspect malaria; the blood examinations made soon after revealed presence of malarial parasites. All of the patients were put on quinine, and the symptoms improved in a remarkably rapid manner, and disappeared completely within three to six weeks. In some cases I gave calcium lactate in association with quinine, but I soon found out it was unnecessary. The diet was not changed in any way. This hæmorrhagic type of malaria must be distinguished from the ordinary types of purpura, from scorbutus, also from a peculiar hæmorrhagic affection, without jaundice, of spirochætic origin.

Malaria may simulate *Pernicious Anæmia*. Of this type I have seen several cases, both in the Balkans and in tropical countries. The appearance of the patient is quite different from an ordinary malarial cachexia, and there may be no history and no sign pointing to a malarial infection. The patient is generally a young man or woman with the typical pallor and the lemon-yellow tint of pernicious anæmia; in some cases the liver is slightly enlarged, or, more rarely, the spleen; there is no fever, or just 99 or 100° F. at night, which is quite common also in true pernicious anæmia. The blood may be negative for malaria on repeated examinations, and may show most of the common features of pernicious anæmia, such as poikilocytosis, nucleated red cells, high colour index, relative increase of the small mononuclears instead of the large mononuclears, as one would expect in malaria. We had one such case for several months in 1918 at one of the Uskub hospitals. The patient, a Serbian soldier aged twenty-one, was fairly well nourished, but very pale, with a lemon-yellowish tint; he was always very languid and apathetic and stayed in bed the whole time; no fever, no enlargement of spleen or liver. Blood, 2,100,000 red corpuscles, marked poikilocytosis, some nucleated

erythrocytes present; leucocytes, 5000 with a large increase in the lymphocytes (55 p.c.) instead of the large mononuclears, as one would expect in a malarial condition. He was considered to be a case of pernicious anæmia, and accordingly was treated with arsenic for several months, when suddenly one day he had a rigor, the temperature going up to 105° F.; the spleen became just palpable, and a few malarial parasites were found in the blood. A quinine treatment by intramuscular injections was immediately started, and within two months the patient was so improved that he returned to his regiment.

In old individuals the profound anæmia may give rise to the suspicion of internal cancer. A man aged sixty was admitted to Sorowich Hospital, near Monastir, in 1917, in a condition of profound anæmia; he was greatly emaciated, with no fever, no enlargement of the spleen or liver; the dyspeptic symptoms dated from several months; complete loss of appetite, pain after food, and vomiting, which he said was of a very dark colour. The doctor who attended him very naturally suspected cancer, especially as the usual treatment for dyspepsia, dieting, etc., had completely failed. Here, too, the microscope revealed the true nature of the condition. A quinine treatment caused all the symptoms to disappear within a few weeks.

Malaria may simulate *Diseases of the Nervous System. The Polyneuritic Type.*—This type has been denied by many observers, but I have come across a number of cases both in the Tropics and in the Balkans. I would call attention to the type of polyneuritis which simulates wet beri-beri very closely. The patient is œdematous; there is the characteristic gait, knee jerks absent. No fever nor enlargement of the spleen or liver. In two such cases the blood showed Laveran's crescents. They both recovered on quinine given in large doses by the mouth and by intramuscular injection.

The Comatose Type of Malaria, for instance, was quite common in Skopolje and the surrounding districts in Serbia during August and September 1915. In this type the patient is brought into hospital unconscious; he cannot be roused to answer questions. The respiration may be stertorous, or sometimes quiet. The pupils are often contracted, there may be high fever, or the temperature may be normal or subnormal, and in this case a diagnosis of morphia poisoning may occasionally be made. The comatose condition becomes deeper and deeper, and the patient often dies a few hours after admission. The exact diagnosis can be made by microscopical methods.

The Delirious Type.—In this type, of which I have seen seven cases in Skopolje, delirium is the most marked feature; it may be followed by coma and death. These cases have occasionally been confused with alcoholic delirium tremens. *The Cerebrospinal Type*

of *Malaria* is quite common in the Balkans, and may clinically resemble cerebrospinal meningitis very closely indeed. A patient was admitted to one of the Uskub hospitals in September 1915, with extremely severe headache, vomiting, fever, retraction of head, Kernig's symptom. A diagnosis of cerebrospinal meningitis was made, the patient isolated, and a lumbar puncture performed. The cerebrospinal fluid escaped with higher pressure than normal, but was completely clear. Blood again examined and numerous malaria parasites found. All the symptoms disappeared after a few intramuscular injections of quinine.

Malaria may simulate various specific infectious diseases: for instance, Enteric, Malta Fever, Tetanus, Sleeping Sickness, and even Hydrophobia. The typhoid-like type of malaria was far from rare in South Serbia and Macedonia in 1915, and I have again seen similar cases near Monastir; more recently still at Taranto and on the Piave Front. From Gevghele, on the Greco-Serbian Frontier, it was reported in September 1915 that an epidemic of typhoid had broken out. My friend Dr. Strong, head of the American Sanitary Commission, Dr. T. Jackson, and later on myself, went there, and soon found out that more than 90 p.c. of the so-called typhoid cases were cases of typhoid like malaria. This type, as a matter of fact, was fairly common also in Skopolje, and numerous cases were admitted to the Lady Paget Hospital in September 1915. In practically all my cases the onset was slow; the patient looked apathetic and complained of headache; tongue very coated; the fever was continuous or subcontinuous; abdomen slightly tumid; spleen generally palpable, but neither very large nor very hard. The patient had certainly all the appearance of a typhoid case. The blood showed as a rule numerous malarial germs, but quinine given in large doses had practically no influence for a long time either on the fever or on the parasites. All the bacteriological examinations for typhoid, paratyphoid, and intermediate germs were, as a rule, negative; very occasionally a case of mixed infection, malaria and typhoid, was found.

Malta Fever Type.—The undulant type of malaria is extremely rare, but it certainly exists. I have seen a case in Macedonia in 1915; the fever, of a typical undulant type, continued many weeks, and was not influenced in the least by quinine 10 gr. t.i.d. given by the mouth for long periods. Malarial parasites were found in the blood repeatedly; all serological and bacteriological examinations for Malta Fever were negative. The fever finally yielded to quinine given intramuscularly.

Tetanus-like Malaria.—I have seen a typical case in Macedonia in 1915, and three in the Tropics, closely resembling lock-jaw. The patient had a normal temperature with trismus, opisthotonus and typical tetanic spasms. In all the cases the blood contained malaria parasites, and an intensive quinine treatment induced a cure.

Hydrophobia-like Malaria.—I was once called by a Ceylonese colleague to see a case which had been diagnosed as hydrophobia. At the time I saw the patient he was in a maniacal condition, temperature 102° F. At the mere sight of water a severe spasm of the larynx occurred. As he had a large spleen I examined his blood with my portable microscope; it was full of parasites. Quinine caused all the symptoms of hydrophobia to disappear in a few hours. It may possibly have been a case of hysteric hydrophobia syndrome in a malaria patient, though the man was not of neurotic tendency and no hysterical stigmata were present.

Sleeping Sickness Type.—This type of malaria, so far as I know, has never been described. I have seen a case in a tropical country where Sleeping Sickness is unknown. The patient had low fever for months, with slight trembling of the hands and tongue and progressive general weakness; he then became drowsy, and occasionally had convulsions. The blood examination was negative for every known parasite, until many months after the onset of the symptoms a few malarial germs were detected. A course of quinine injections cured the patient. A somewhat similar case, though not so severe, with general debility, tremblings of hands and tongue, very marked drowsiness for several weeks, was seen by Dr. Mitchell and myself in Serbia, but the correct diagnosis in this case was made at once, as the blood was teeming with malaria parasites.

Malaria may simulate various *Diseases of the Digestive System*: for instance, *Dysentery* and *Cholera*. I shall always remember a case with all the symptoms of dysentery I once saw in consultation in a tropical country. The patient had been treated with ipecacuanha, anti-dysentery serum, bismuth, salol, nitrate of silver irrigations, etc., for months; the condition very rapidly and completely yielded to quinine within forty-eight hours. Of course one must not forget that there are quite a number of cases of mixed infection—malaria plus bacterial and amœbic dysentery—but the case I have described was certainly not one of these, the examination of the intestinal contents which I made being negative for entamœbe and other dysenteric germs. I have seen very similar cases also in the South of Italy, in Macedonia and Albania.

Malaria may simulate *Cholera*. During the epidemic of cholera in Ceylon in 1914, I was called to confirm the diagnosis of cholera in a European assistant of one of the big tea firms in Colombo, in order that he might be removed to the Infectious Diseases Hospital, a proceeding the patient strongly objected to and was resisting with what little strength he had left. He had been taken ill suddenly in the night with profuse serous diarrhoea. When I was called to see him at 11 a.m. he was feeling very cold, his skin clammy, his cheeks sunken, and he looked very ill indeed. Temperature, 99° F.; pulse, 104. The stools were absolutely

cholera-like, of the well-known rice-water appearance. Examining the patient I found the spleen just palpable, but very hard. On questioning him I elicited the fact that he had had an attack of malarial fever three weeks previously, on an estate where he had gone for a short holiday. The blood was examined at once; it was swarming with malaria germs. Quinine was given immediately by intramuscular injection, and the diarrhoea stopped within a very few hours. The patient was up two days later. The complete bacteriological examination of the intestinal contents revealed entire absence of the cholera vibrio, or of vibrios of the para-cholera group. A somewhat similar case, which also had been taken for cholera, was seen by me in Northern Macedonia in 1915. This case also recovered very quickly on quinine. Cases of the same nature, though not so typically cholera-like, have been observed by me more recently in Corfu, and at Salonika.

I have mentioned certain internal diseases which may be simulated by malaria, but this infection may even give rise to symptoms pointing to surgical conditions such as appendicitis, acute colo-cystitis, abscess of the cerebellum, abscess of the liver.

A young Serbian soldier was admitted to hospital with symptoms pointing to acute appendicitis: violent pain in the appendicular region, vomiting and fever, but no rigors; severe tenderness and well-marked rigidity all over the right lower abdomen. A surgeon advised operation, and the appendix was removed, but did not appear to be much affected; the temperature fell during the night, and the day after the patient was feeling quite well. On the following day, however, he again complained, greatly to the surprise of the surgeon, of very severe pain in the lower right abdomen, though not so localized. Vomiting set in and the temperature rose to 105. Examination of the blood showed presence of an enormous number of parasites. Quinine given at once by intramuscular injection in large doses made all the symptoms disappear very rapidly.

Another patient in Uskub suffered from very severe headache for months, became nearly blind, had giddiness and vomiting, could hardly stand, and walked like a drunken man. Every night the temperature rose to 100. His medical attendants naturally thought that it might be a case of cerebellar abscess, and operative measures were suggested. However, after repeated examinations the blood was found to contain malaria parasites, and quinine caused a complete cure of the condition.

One could go on indefinitely describing the various strange appearances under which malaria can camouflage itself; but I will now say a few words on the prognosis of the malady.

Prognosis.—In the Balkans, as in any other malarial country, providing an appropriate treatment be given, the prognosis is good in the enormous majority of cases. It must be remembered,

however, that, firstly, in pernicious cases a high mortality may be present notwithstanding an energetic treatment; secondly, in a large number of cases, even of the usual benign type, the cure which is brought about by an appropriate treatment is merely clinical—that is, the patient feels well and shows no signs of the malady, but a complete sterilization is not obtained. The affection remains dormant for months and years, and any cause lowering the resisting power of the individual, such as a chill or a traumatism, may cause the acute symptoms to reappear, and I have known the disease to recur in patients in England ten and fifteen years after leaving the Tropics.

I have mentioned traumatism. An operation—for instance, the simplest surgical act, even a tooth extraction—may re-awaken a very old dormant malarial infection; the patient shortly after has a rigor, the temperature rapidly rises to 104° or 105° F., very severe vomiting sets in—symptoms which may cause a very great deal of anxiety to the surgeon, who, naturally, may be very far from thinking of malaria.

And now a word on the *treatment*. It seems to me that every person proceeding to a malarious zone should know something about how to deal with acute malarial cases when medical help is not at hand: and this is often the case in many tropical districts. On the treatment of malaria one could speak for hours, but it may be condensed into one word, and that word is—quinine.

Every tropical practitioner is, of course, familiar with the colonial patient who will earnestly assure him that quinine not only does not cure malaria, but is the true cause of it. Notwithstanding this “dictum,” however, quinine is the only drug that cures the disease, only it must be given—and taken—in large doses. I have said “taken” purposely: the patient must be convinced that it is not sufficient to look at the bottle—one must drink the bitter dose.

In malarious countries quinine may be given in 10-gr. doses three or four times daily to adults, without any danger. It should be given by the mouth in ordinary cases; by intramuscular injection in severe cases; intravenously in the pernicious forms. The injections should, of course, be given only by a doctor.

There are two methods of prophylaxis—the one based on anti-mosquito measures; the other based on the preventive administration of quinine. There has been a great deal of discussion as to which is best; in my opinion both measures should always be employed together. If we have several weapons with which to fight an enemy, it seems to me good policy to use all of them instead of one only. As regards anti-mosquito measures, the destruction of all larvæ by oiling every pool and pond near the military camps, hospitals, etc., is by far the most useful; mechanical protection by means of mosquito-nets and masks should also

be carried out. Of masks I prefer the one invented by Mrs. M. Simpson, called the "Simpsonette." Chemical preparations to keep off mosquitoes are advantageous—the best is citronella oil; on the Piave Front (Italy) every man of the Brigade of Marines, of which I was in medical charge, was supplied with it and the result was satisfactory. A more pleasant preparation to use, though less effective, is menthol powder. As regards prophylaxis based on quinine administration, the usual dose of 5 gr. daily is utterly inadequate in the Balkans. The daily dose should be increased to at least 8 or 10 gr., and even these doses are at times insufficient to prevent infection.

II.—TYPHUS.

The microscopical agent of typhus has not yet been found with certainty, though a spirochæte has been isolated.

The terrible epidemic of this disease in Serbia during the years 1914–1915 will not easily be forgotten. It probably wiped out one-sixth of the entire population, and made havoc especially among doctors and nurses. One-third of the Serbian doctors died of typhus, and a number of victims occurred also among the medical men and nurses of various nationalities, but chiefly British, who had answered the Serbian call for help.

Among these courageous helpers I may perhaps be permitted to mention the name of Lady Ralph Paget. I think no one who was there at that time will ever forget the impression of Lady Paget, a tall, slim figure in the dress of the Red Cross, in the wards of the make-shift subterranean hospital, which was all she had at that time—wards airless, stifling, scarcely lighted, reeking with typhus, and crowded with the dead and dying—ministering to the sick and the wounded, without a thought or a care for her own safety.

A little later Lady Paget's untiring energies succeeded in obtaining the splendid, well-equipped hospital unit which bore her name, and which, with the other fine hospitals opened by the various allied missions, etc., were the means of saving hundreds of lives and ending the outbreak. I can testify to the great amount of good these institutions did, having been attached to both the American Red Cross Hospital and the Lady Paget Hospital.

According to my Serbian experience, typhus begins generally abruptly, with pains all over the body, a feeling of prostration, and rigors; but cases in which the onset is slow, somewhat typhoid-like, are far from rare. On an average the duration of fever in my cases was from fourteen to eighteen days. In 80 p.c. of them the fever did not come down by crisis, as usually stated, but by lysis, lasting in general three to five days, and occasionally much longer. Relapses may occur, but are rare. I would call attention to the frequent co-existence of typhus and relapsing fever. This is

explained by the fact that the same insect (louse) carries the two infections. The commonest complications and sequelæ I have observed were, in order of frequency, parotitis, often proceeding to suppuration; gangrene of the feet; polyarthritis; neuritis. Several cases developed during convalescence symptoms of severe depression almost amounting to melancholia.

As regards the prophylaxis of typhus, I am a believer in the efficacy of taking every possible precaution against lice, especially in the sterilization of all soldiers' underclothing and uniforms at fixed intervals, and frequent bathing. As regards the use of various substances which are deleterious to body-lice these are, according to the experiments carried out by Dr. Jackson and myself, and in their order of efficiency: (1) petrol; (2) plain vaseline; (3) guaiacol; (4) anise preparations; (5) iodoform; (6) lysol, cyllin, and similar preparations; (7) carbolic acid solution (5 p.c.); (8) naphthaline; (9) camphor. We found that pyrethrum had a very feeble action, while boric acid, sulphur, corrosive sublimate and zinc sulphate, when used in powder form, had apparently no action whatever. As regards bed-bugs, kerosene oil is the best insecticide. Next to it comes guaiacol. It is interesting and most important to note that an insecticide substance is not equally efficacious against all parasites: a chemical having a very deleterious effect on lice may have practically no action on bed-bugs. Iodoform, which kills lice in ten to fifteen minutes, has practically no action on bed-bugs, which may live for more than twenty-four hours when exposed to it. It has also very little effect on fleas. Pyrethrum, on the other hand, has a much more powerful action on bed-bugs than on lice. It is useful, therefore, in preparing insecticide powders for general use, to mix various substances, some deleterious to lice, others to bed-bugs, and so on. A very good combined powder is naphthaline and pyrethrum in equal parts.

For use against lice on a large scale, as among troops or prisoners, perhaps the best insecticide powder is naphthaline. This substance has a lower liceicide action than kerosene oil, guaiacol, iodoform, and anise preparations such as anethol, but it has a less unpleasant odour than the first three named, and is much cheaper than anethol powder. In stored blankets and clothing it is also practicable and of use, as frequently lice are found upon the clothing and blankets stored through the summer. Naphthaline is useful for its well-known deterrent action upon moths. As regards liquid insecticides, the American Sanitary Commission sanctioned the use of kerosene by using it daily for troops and prisoners.

For the better class of patients, in practice a menthol powder (menthol 3 to 5 gr., zinc. ox. 1 oz.) is to be preferred to naphthaline in most cases, as its odour is not unpleasant, while it is

repellent to mosquitoes in addition to lice and fleas. Such powder is especially useful in summer and in hot countries, as it has a cooling effect on the skin and often prevents prickly heat.

As regards ointments, we found the rather interesting and useful fact that plain vaseline has a powerful action on lice, and it is doubtful whether the addition of white precipitate and other chemicals increases its action. In practice, however, it is useful to add a small amount of white precipitate (3 gr. to 1 oz.), as it has a beneficial effect on secondary pyogenic infections, so common in persons infested with lice.

III.—RELAPSING FEVER.

Relapsing fever was extremely common in Serbia in 1915, in the spring and summer especially. It was not rare in 1916 among the Serbian troops in Corfu, after the retreat through Albania, and cases have been seen by me, again, in the Balkans this past winter. I would call attention to the comparative frequency of mixed infections which were seen in 1915—typhus exanthematicus + relapsing fever; malaria + relapsing fever. In Skopolje in 1915 it was extremely common to see relapsing fever develop in convalescents from typhus. The frequent co-existence of the two infections is probably explainable from their being carried by the same insect, the louse; though personally I am inclined to think that relapsing fever is carried also by bed-bugs.

As regards the ætiology of the disease, as I hope to demonstrate in a future publication, I believe that in Europe, as in Africa, America, and Asia, it is due to several species of spirochætes, and not to one only (*Spirochæta recurrentis* Obermeyer). As regards clinical symptoms, I would point out how extremely difficult it is to diagnose from purely clinical symptoms, at the onset of the first attack, relapsing fever from typhus, malaria, and pappataci fever—only the microscope can help us.

IV.—PAPPATACI FEVER.

This fever is extremely common in summer all over the Balkanic and Adriatic Zone. The so-called Uskub and Skopolje Fever, epidemics of which occur regularly every year in Skopolje and surrounding Macedonian districts, I found out in 1915 to be also Pappataci Fever. The disease, but for the rash, is very similar to Dengue as I have seen it in the Far East and Ceylon. It begins suddenly with rheumatoid pains all over the body, headache, pains in the eyeballs, fever (which seldom goes higher than 104°), no rigors. The face is flushed, and has often the appearance of being slightly bloated. The flushing is often so marked and

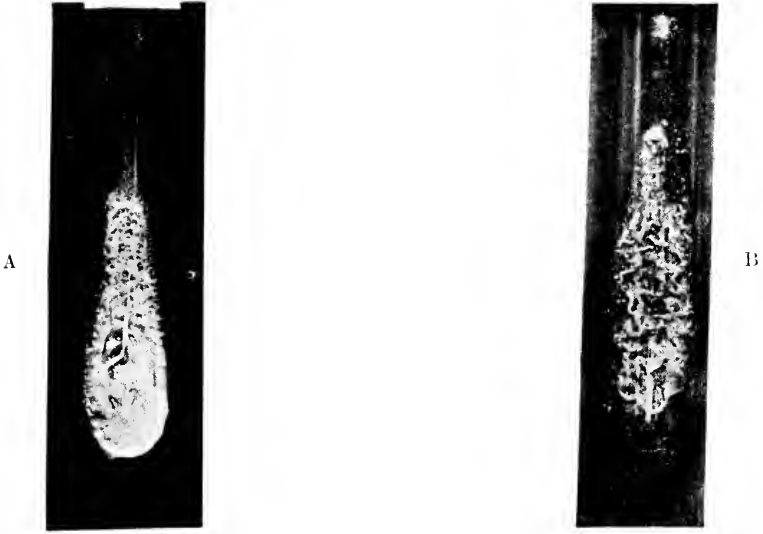

A.—*Oidium asteroides* Cast. Glucose-agar Culture.
B.—*Hemispora rugosa* Cast. Glucose-agar Culture.
C.—*Aeladium Castellanii* Pinoy. Hanging Drop Culture.

severe as to amount to an erythematous rash, which often involves the neck. I would call attention to the appearance of the skin of the chest, and at times the abdomen, which shows frequently a delicate subcuticular mottling—*cutis marmorata*. The fever keeps high (102° to 104° F.) for thirty-four to forty-eight hours; it drops by crisis on the third day. Occasionally the fever lasts for four or five days, and may not drop so suddenly. At times some superficial lymphatic glands are enlarged.

V.—OTHER TROPICAL DISEASES.

Next to malaria, the diarrhoeas and dysenteries are the most common affections in the Balkans. Attention should be called to a type of diarrhoea seen in Serbian soldiers who had suffered terribly from starvation during the Albanian retreat. This diarrhoea closely resembled the famine diarrhoea observed in India.

So-called Camp Jaundice is common (*icterus castrensis*). According to my experience two varieties can be distinguished: (1) a very severe hæmorrhagic type with high fever lasting ten to twelve days, showing occasionally a relapse—true Weil's disease, rare; and (2) a mild type (*icterus castrensis levis*), often afebrile, very common. Weil's disease, as is well known, is of spirochaetic origin, but in my opinion it is probable that many cases of the mild type are also spirochaetic.

Fevers of the enteric group are fairly frequent in the Balkans, but during the last years have never assumed an epidemic type. Paratyphoid A and B are in certain districts more frequently met with than true typhoid.

With regard to the prophylaxis of these fevers I may perhaps be permitted to say that the method of combined vaccination I devised many years ago has given good results. It has recently been adopted in all the Allied Armies.

Of Malta Fever I have seen only two cases in Macedonia and the interior of the Balkanic Zone; it is more frequently met with on the coast and in the islands.

Kala Azar of adults I have never seen in the Balkans; of the infantile type I have seen many cases in certain islands of the Adriatic and Ægean Seas. It is rare in Macedonia, where I have seen only one case.

Bronchomycosis is common: I have seen cases of bronchomoniliasis, broncho-oidiosis, broncho-hemisporosis, aspergillosis, penicilliosis and nocardiasis. Bronchospirochaetosis is not rare.

Pellagra is quite common in several districts of Macedonia, but I do not think there is any danger for our troops. I have seen a case of leprosy and a typical case of granuloma inguinale.

Of the tropical diseases which are of rarer occurrence, I may

mention Blackwater Fever, filariasis, sprue, intestinal myiasis, mycotic, spirochaetic and flagellate urethritis.

Certain tropical skin diseases are frequently met with. The following are a cause of great discomfort in summer and are often wrongly diagnosed: dermatitis interdigitalis epidermophytica, or "mango toe"; tinea cruris or "dhobie itch"; prickly heat and various types of tropical pyosis—such as Pyosis Mansoni, pyosis discoides, etc. I have seen in 1915 in Macedonian peasants cases of *ulcus tropicum*, oriental sore, *ulcus infantum*, blastomycosis, sporotrichosis, accladosis, etc.

The hour is late and I must conclude my lecture. From the experiences I have related it will be seen of what enormous importance microscopical organisms are in the aetiology of Tropical and War Zone diseases; what havoc they play in armies in the field; what ruin they can bring to a nation. Fortunately, thanks to the labours carried out before and during the war by such men as Roux, Sir Almroth Wright, Carrel, Browning, Horrock, Eyere, Martin, Hewlett, and many others, a number of microbes have been dominated by new chemical or physiological methods, and some of them have been, so to speak, placed in harness and compelled to provide the means to prevent and cure the diseases of which they themselves are the cause: I mean vaccines and sera. The typhoid bacillus induces a disease which in previous wars has caused far more mortality than have bullets. The same bacillus by a very simple method has been turned into a beneficial vaccine which in this war has saved the lives of hundreds of thousands of brave soldiers in the British and Allied Armies.

Welch's bacillus is the common cause of that horrible infection, gas gangrene. By inoculating the same bacillus into animals a serum has been obtained which has both a preventive and a curative action.

The experience in the Balkanic War Zone has also shown more perhaps than anywhere else the paramount importance for diagnostic purposes and, indirectly for curative and prophylactic purposes, of the work in which all of you are interested; of the work which your Society has encouraged and furthered so much—namely, scientific microscopical work.

VII.—*The Isolation of the Single Bacterial Cell.*

By NATHAN MUTCH, M.A., M.D., M.R.C.P.

(From the Bacteriological Laboratory, Guy's Hospital.)

(Read March 19, 1919.)

ONE TEXT-FIGURE.

THE ideal starting point of a "pure" cultivation is without doubt the single "spore" or the single vegetative cell, and in the case of a comparatively large organism such as a yeast it is easy of attainment. But the problem becomes increasingly difficult with the diminution in size of the bacterium to be studied; and in planning any method to attain the desired end three points need consideration.

1. A single organism must be separated from its fellows in a small quantity of medium.

2. This single organism must be placed under such conditions that it can multiply and produce a massed growth capable of being manipulated by ordinary bacteriological methods.

3. The original observation that one organism, and one only, was separated from the rest must be capable of confirmation.

Several methods for the isolation of the single cell have already been described, and many of them were tried out but discarded; in particular, much time and patience was expended on that recently described by Malone,* which necessitates the use of a teat capillary pipette to suck up a minute drop of water containing a solitary cell, whilst observing the process microscopically.

Failure usually resulted owing to the difficulty of illuminating the process satisfactorily, also because the end of the pipette merely indents the shallow drop of water and the lips of the orifice do not become wet, so that the drop remains on the slide and will not enter the capillary tube.

The method to be described avoids many of these difficulties, is simple and easy, and requires no elaborate or special apparatus.

Apparatus Required.

Microscope with $\frac{1}{6}$ -in. and $\frac{1}{12}$ -in. lenses.

Artificial illuminant.

"Hanging drop" slides: prepared by cementing tin alloy rings

* Journal of Pathology and Bacteriology, 1913, 22, 222-3.

$\frac{3}{4}$ -in. diameter upon ordinary 3×1 glass slides with vaseline or Canada balsam.

Square $\frac{7}{8}$ -in. cover-glasses, No. 1 thickness, clean and stored in absolute alcohol.

Platinum loop (very small), or spatula.

Filter paper.

Two cork borers (or preferably "hollow punches") $\frac{5}{8}$ -in. and $\frac{3}{8}$ -in. diameter respectively.

Normal saline solution (sterile).

Tube of liquefied nutrient agar, cooled to 42° C., in water bath.

Method.

The organism to be studied is grown upon a solid medium for a short period, say six to eight hours, and the resulting growth emulsified in sterile broth or normal saline solution. When working with delicate parasitic bacteria, such as streptococci, it is essential to use saline at or near incubator temperature for this purpose.

Narrow rings of filter paper (C) are now stamped out with the help of the hollow punches and one or two placed in the hanging drop cell and moistened with saline. The rim of the cell is prepared with vaseline in the usual manner (A and B).

A perfectly clean coverslip is flamed, and as soon as it is cool a minute drop (micro-drop), which should not be of greater diameter than about 0.5 mm. to 0.75 mm., of the emulsion of the bacterium is placed in its centre by means of a very small loop of platinum wire. A suitable gauge of wire is 0.1 mm. The slip is immediately placed in position over the moist chamber.

This procedure should be carried out with considerable speed to prevent the drop from drying up prematurely. When once the slip has been applied to the moist chamber, the drop neither shrinks nor grows, because its vapour tension is accurately balanced by that of the saline on the paper ring. If water is used to moisten the paper instead of saline, the drop grows in size and quickly assumes unsuitable proportions.

The drop is then carefully searched with a $\frac{1}{6}$ -in. objective, and any doubtful particles noted for more detailed scrutiny with an $\frac{1}{12}$ -in. oil immersion.

A series of such drops can be prepared and examined rapidly, and the dilution of the original emulsion adjusted, until a drop containing a solitary organism is found.

The cover-slip of this particular preparation is then raised from the cell with forceps, and a large drop of liquefied nutrient agar, or blood broth, or other suitable medium, placed close to the micro-drop and the slip tilted until the two coalesce.

The slip is then placed on another moist cell, incubated for twenty-four hours, and examined for growth under the microscope. When a solid medium is employed, if the original observation was correct, one colony only will have developed.

If the micro-drop really contained more than one micro-organism, separate compact little colonies can be seen after twenty-four hours, corresponding in number with the organisms originally present.

The same is true of many organisms, such as streptococci, even when incubated in hanging drops of liquid medium.

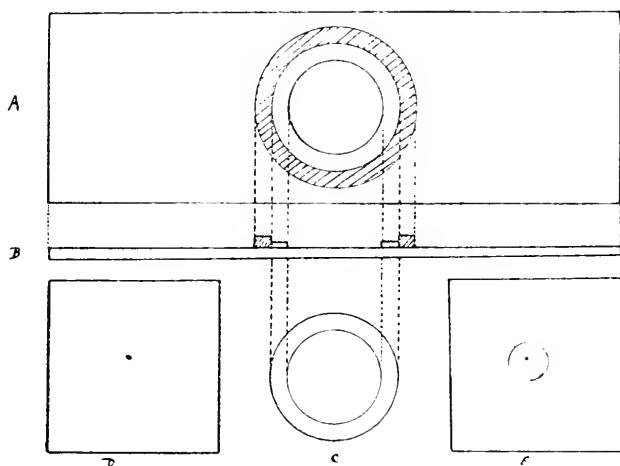

A. Hanging-drop slide with filter-paper ring in position, shown in plan, and in B longitudinal section. C. Filter-paper ring. D. Micro-drop on cover-slip. E. Drop culture after incubation with single colony.

In this way the accuracy of the original observations is controlled.

A portion of the growth thus obtained from a single cell is removed on an ordinary loop and transferred to a suitable medium for more massive growth. With ordinary care the risk of contamination is negligible, a point which has been established on a long series of observations.

In working with delicate organisms the process must be carried out at body temperature on a warm stage. In this case the centre of the cover-slip is the coldest part of the moist cell, and to avoid steaming and a rapid flooding of the micro-drop, the filter paper ring must be replaced by a small drop of saline only two or three times as large as the micro-drop.

When the observation is complete, the large drop of medium is

added and the slip transferred to a moist cell containing a paper ring, and incubated as before.

Considerable eye fatigue is avoided and the organisms themselves protected by passing the light through a filter of Crook's glass, which cuts off a large proportion of the ultra-violet rays.

The advantages of this method are that the element of chance in the successful carrying out of the manipulation is completely eliminated. No special skill or practice is called for, no special preparation is needed; and the whole procedure can be carried out without notice with the ordinary apparatus found on a bacteriological laboratory bench; the time required is only one or two hours.

VIII.—*On the Chemistry of Dendritic Growths in Paper.*

BY JAMES STRACHAN, F.R.M.S.

(Read April 16, 1919.)

1. INTRODUCTION.

ELEVEN years ago, in a communication to this Society,* the present writer reviewed the existent literature on the subject of dendritic growths in paper, and, from his practical experience of paper and paper-making, explained some features in the occurrence of these growths hitherto puzzling to microscopists.

This contribution confirmed the observations of Tait and Scales concerning the composition of these growths, and attributed their formation wholly to a process of oxidation acting upon a metallic nucleus of bronze. A point, however, which was not explained quite satisfactorily at that time was the manner in which the insoluble copper compounds crept along the surface of the fibres. All experiments performed subsequently with a view to production of artificial dendritic growths by oxidation methods ended in negative results.

This led the writer to further experiments and consideration of other theories. The publication of the above paper brought forth the criticism and expression of opinion on the part of four specialists in paper chemistry. Two of these confirmed the oxidation theory from their own experience; a third was doubtful, and remarked the occurrence of similar growths in waterproofed fabrics; while the fourth stated definitely that all dendrites in paper examined by him contained sulphide of copper.

2. RESULTS OF FURTHER INVESTIGATIONS.

Subsequent investigations carried out from time to time during the past ten years, in which many hundreds of specimens were examined, led the writer to adopt the following explanation of these interesting growths, which is undoubtedly the correct one.

We commence with a nucleus of bronze or brass imbedded in a felted sheet of cellulose fibres, containing other substances comprising paper. The following factors must be considered:—

(a) *Presence of Moisture.*—The hygroscopic moisture of the cellulose may amount to 15 p.c. in a moist atmosphere.

* Journ. R. Micr. Soc., 1908, pp. 544-50 (pl. xiii.).

(b) *Presence of Oxygen*.—Atmospheric.

(c) *Presence of Sulphur Compounds*, including sulphate of aluminium in practically all papers—certainly in all modern papers containing dendrites; ultramarine blue and aniline dyes containing sulphur in some papers; traces of organic sulphides in unbleached wood cellulose papers; sulphuric acid absorbed from atmosphere, derived from gaseous products of combustion of coal-gas, etc., in very old papers.

(d) *Presence of Chlorides* derived from water used in paper manufacture, or from bleaching residues, in some papers.

(e) *Presence of Oxidizable Organic Matter*, including primarily the various kinds of cellulose; also in many papers gelatine and starch. In this connexion it must be remembered that most papers contain the germs of living matter, moulds and bacteria, ready to spring into active development with favourable conditions of moisture and temperature.

Given such conditions, the mode of growth producing the dendrite is most probably as follows:—

Stage I.—Solution of bronze nucleus by sulphuric acid of aluminium sulphate, etc., with formation of copper sulphate. This is essentially a process of oxidation, and is aided or intensified by chlorides.

Stage II.—The soluble copper sulphate creeps along the moist cellular fibres by capillary force.

Stage III.—The sulphate of copper is reduced to sulphide of copper by hydrogen generated in *Stage I.*, and by oxidizable organic matter.

Stage IV.—The sulphide of copper is again oxidized to the soluble sulphate by atmospheric oxygen, and thus by alternate oxidation and reduction insoluble copper compounds may be deposited along the fibres in the form of a dendritic growth containing copper sulphide pseudomorphous after copper sulphate.

Stage V.—The final action in very old dendrites is oxidation resulting in the formation, with complete solution of the metallic nucleus, of a basic copper sulphate containing oxide and sulphate of copper.

Papers toned blue with ultramarine frequently show a bleached zone around dendritic growths, showing that the sulphur of the colour has taken part in the reaction, but in most papers the presence of aluminium sulphate is sufficient. On the other hand, in a very old paper in which alum could not be detected a dendritic growth containing sulphide of copper was observed, arising from a brass pin which had been stuck into the paper as a book-mark. In this case the sulphide was most probably of atmospheric origin.

3. CHEMISTRY OF PAPER DETERIORATION.

Apart from a purely academic interest in the chemistry of these curious growths, the author has followed up this matter from a more important point of view—viz. with reference to the chemical reactions taking place during the deterioration of paper by age.

The periodic oxidation and reduction actions which take place during the growth of dendrites in paper may be regarded as going on simultaneously as phases of one set of chemical reactions, in which the chief factors are the organic matter of the paper, chemical residues in the latter, and atmospheric oxygen. It is suggested, in fact, that the dendritic growths are visible indicators, by means of secondary reactions, of chemical actions going on in the pores of all paper during ageing, and resulting in the hydrolysis and oxidation of the cellulose.

This conclusion confirms a previous research* of the writer's, in which he pointed out that certain chemical reactions, which take place in glass only at elevated temperatures, occur in the pores of cellulose at ordinary temperatures.

4. MICRO-CHEMICAL REACTIONS.

The detection of copper sulphide in these dendritic growths was demonstrated chiefly by the fact that this substance is only soluble with great difficulty in mineral acids, but readily soluble in a solution of potassium cyanide.

On application of a drop of potassium cyanide solution (equivalent strength) to a dendrite of recent growth, the copper sulphide readily dissolves in the cold forming the soluble double cyanide of copper and potassium, and also potassium sulphide. Further, on adding to this solution a drop of sodium nitro-prusside (one-fifth equivalent strength), the evanescent violet coloration characteristic of the reaction with alkaline sulphides is readily observed, but this test is so delicate for minute quantities of sulphur that some chemists might object to its application in the presence of other chemical residues. It is to be noted however that even in papers containing sulphur in the form of ultramarine, this test gives a negative result on any portion of the paper except that touching a dendritic growth. In the writer's opinion it is quite a satisfactory test because experiments have shown that the production of the violet coloration with potassium sulphide is not affected by any of the chemical residues present.

However, to make matters more certain in the detection of

* "On the 'Hughes' Reaction' of Potassium Iodide on Paper," *Chem. News*, ciii., pp. 193-6.

copper sulphide the author devised another and more conclusive application of micro-chemistry. This test is based on the insolubility of cadmium sulphide in potassium cyanide and the solubility of copper sulphide in the latter. A solution is prepared (equivalent strength) of the double cyanide of cadmium and potash, to which is added a slight excess of potassium cyanide. On applying a drop of this reagent to a dendritic growth containing sulphide of copper the latter is dissolved, but each molecule of copper sulphide displaces from the solution an equivalent molecule of cadmium combined with the sulphur derived from the solution of the sulphide, with the result that in the case of some recent dendrites it is possible to obtain, as a result of the reaction, a brilliant yellow dendrite of cadmium sulphide which is an exact pseudomorph of the copper sulphide.

This principle of replacing one water-insoluble substance by another with the formation of pseudomorphs differing in colour appears to be capable of further applications and constitutes a new mode of reaction in micro-chemical manipulation.

SUMMARY OF CURRENT RESEARCHES

RELATING TO

ZOOLOGY AND BOTANY

(PRINCIPALLY INVERTEBRATA AND CRYPTOGAMIA),

MICROSCOPY, ETC.*

ZOOLOGY.

VERTEBRATA.

a. Embryology, Evolution, Heredity, Reproduction,
and Allied Subjects.

L'Année Biologique.—YVES DELAGE (*Paris*, 1918, **21**, xvii + 428). We welcome the twenty-first volume of this excellent year-book of biological progress which Prof. Yves Delage continues to edit. The summaries of papers are excellent, and the numerous collaborators have our gratitude. The chapters deal with the cell, the gametes, parthenogenesis, asexual reproduction, ontogeny, teratogeny, regeneration, grafting, sex, alternation of generations, correlation, death, general morphology and biological chemistry, general physiology, heredity, variation, origin of species, geographical distribution, the nervous system and mental functions, and generalities. The present volume deals with 1916, and we have taken the liberty of using some of the abstracts of German papers as a basis for brief reports in our present number.

J. A. T.

Effects of Iodine on Tadpoles.—W. W. SWINGLE (*Journ. Exper. Zool.*, 1919, **27**, 397-414). Iodine and its compounds when fed to the larvæ of *Rana pipiens* and *Bufo lentiginosus* stimulate metamorphosis very rapidly. Inorganic iodine when fed to thyroidless larvæ of the toad brings about metamorphosis in an abnormally short time. Iodine appears to function within the organism as a hormone itself without the intermediation of the thyroid gland. The suggestion is offered that the extraction of iodine from the blood and its storage may be the chief function of the thyroid gland.

J. A. T.

Influence of Iodine on Thyroid Gland of Tadpoles.—W. W. SWINGLE (*Journ. Exper. Zool.*, 1919, **27**, 417-25). The thyroid

* The Society does not hold itself responsible for the views of the authors of the papers abstracted. The object of this part of the Journal is to present a summary of the papers as *actually published*, and to describe and illustrate Instruments, Apparatus, etc., which are either new or have not been previously described in this country.

glands of iodine-fed tadpoles are larger than the glands of control specimens held by underfeeding at the same body length as those of the iodine-fed series. The follicles of the glands of such iodine-fed larvæ contain a much greater colloid mass than the follicles of the controls. Solutions of iodine will bring about metamorphosis in both normal and thyroidless tadpoles in a short time. Iodine is much more active in accelerating metamorphosis than any of its compounds. Next in order of activity are iodoform and potassium iodide. But potassium iodide appears to have no effect. The suggestion—a safe suggestion—is made that amphibian metamorphosis is a result of the interaction of environmental agencies, such as iodine and its compounds, with the hereditary factors controlling the growth processes. Surely this is a general formula for all development; what is new is the recognition of the rôle of iodine.

J. A. T.

Sheep Crosses and New Varieties of Wool.—J. COSSAR EWART (*Scottish Journ. Agriculture*, 1919, 2, 1-10, 10 figs.). “Up till a year ago, after interbreeding many different kinds of first crosses, there seemed no escape from the conclusion that sheep do not conform to Mendel’s law to the same extent as Andalusian fowls and Shorthorn cattle. But a lamb dropped on the Edinburgh University Farm during the last week of May 1918 clearly demonstrated that this view was untenable.” A hybrid ewe, a first cross between an imported Afghan fat-tail ram and a Cheviot gimmer, produced a ram lamb which even at birth had all the points one expected to find in a young pure-bred fat-tail. Experiments made with Southdowns and the primitive Soay sheep indicate that it will be possible to establish a breed having the chief characteristics of the first crosses; that by mating the first crosses with a Southdown ram material could be at once obtained to start a new and vigorous strain of Southdowns; and that interbreeding first crosses by the same sire leads at once to a decided loss in size and vigour, and to a decided reduction in the market value. The Southdown-Soay wool is remarkable for its strength and quality, and Southdown blackface crosses are very valuable both as regards mutton and wool. It is pointed out that the reddish colour of the fleece of primitive “peat” or “heath” sheep was probably of protective value, making the sheep inconspicuous to the eyes of eagles and ravens and other enemies, and that the loss of the coarse long hair forming the outer coat was probably due more to changes in environment than to selection by the ancient herdsmen.

J. A. T.

Superfœtation in Mice.—F. B. SUMNER (*Biol. Bulletin*, 1916, 30, 271-85). In the pocket-mouse, *Peromyscus*, it was observed that a female may produce a second litter thirteen to thirty-nine days after the preceding one. As no adult male was present, and as the young males of the first litter were quite immature, it seems clear that the ova liberated by the second ovulation must have been fertilized by spermatozoa which had remained latent in the female duct. Another possibility, that there was simultaneous fertilization of two sets of ova, and that one set began to develop while the other set were delayed, seems to the

author very improbable. If retarded fertilization is a fact it may possibly throw light on some cases of alleged telegony. J. A. T.

Fate of Homozygous Yellow Mice.—W. B. KIRKHAM (*Journ. Exper. Zool.*, 1919, 28, 125-35, 2 figs.). The failure of breeders and investigators to obtain any homozygous yellow mice and the observed smaller average litters born to yellow parents suggested the advisability of attacking the problem from the embryological side. All mouse-embryos encounter a crisis at the time of the implantation of the blastula in the wall of the uterus, and in unusually large sets of blastulæ one or more appear always to perish at this time without producing any uterine reaction. In healthy mice other than yellows, however, those blastulæ which induce a swelling of the mucosa uniformly complete their implantation, while the blastulæ resulting from yellow matings almost always lose at least one of each set after the mucosa has reacted. Apart from this loss of certain blastulæ during implantation, the embryonic and early postnatal history of yellow mice is exactly the same as that of mice of other coat-colours. The theory is that the blastulæ lost in yellow females during implantation are the missing homozygous yellow mice, and the evidence consists on the one hand in the absence of any similar phenomena in healthy white mice, and on the other hand in the statistical correspondence between the percentage of embryos so lost and the Mendelian expectation of homozygous yellows. J. A. T.

Hereditary Tumour.—MARY B. STARK (*Journ. Exper. Zool.*, 1919, 27, 507-22, 3 pls.). Cell suspension from an "hereditary tumour" in a stock of the fly *Drosophila* was injected into adult flies. Abnormal growths occurred in some of the flies and caused their death. Tumours were kept alive and showed further development in hanging drops of Locke's solution. Tumour-cell suspension was injected into meal worms, but the resistance of most of them was too great to allow the development of many tumours. Only a small percentage died, and only two of these had tumours visible to the naked eye. No growths occurred in ordinary laboratory media. The flies were bred on sterile media under absolutely sterile conditions, but the tumour continued to develop as before in successive generations, and is evidently not due to a micro-organism. The tumour develops in embryonic rudiments, destined to develop into adult organs. Its development is initiated by excessive production of melanin. Melanin occurs normally in ganglion cells, and these cells are related to some of the embryonic rudiments by ganglionated fibres. Secondary tumours or metastases occur in many of the larvæ with tumours. A mutation occurred in certain flies of such a kind that pigment appeared in the hypodermis cells of the ventral surface of the last segment, forming a pigmented bar. It occurred only in larvæ that had tumours. So far the character has not been separated from the stock with hereditary tumour. J. A. T.

Neural Plates of Chelonian Carapace.—W. J. SCHMIDT (*Zool. Anzeig.*, 1916, 47, 9-13, 2 figs.). There has been considerable difference of opinion as to the development of the neural (and costal) plates,

which some refer to the dermis and others to the endoskeleton. In young specimens of *Caretta* the author found the primordium of the neural plates in the form of a small bony disc situated in the deep layer of the dermis, and independent of the neural spine, with which there is secondary coalescence.

J. A. T.

Neural Folds.—O. C. GLASER (*Science*, 1916, 505). Observations on the development of the Amphibian *Cryptobranchus* lead the author to conclude that the folding in of the neural tube is in relation with the volume of the constituent cells, which increases with the absorption of water. But the absorption is rather a cause than a symptom of the folding.

J. A. T.

Coracoid of Pig.—F. B. HANSON (*Anat. Record*, 1919, 16, 197-202, 6 figs.). The author finds that the coracoid process is absent in the pig; that the subcoracoid is present and ossifies from a single centre; that the subcoracoid is a glenoid-sharing portion, and is the homologue of the like-named structure in man; that the subcoracoid has all the characteristics of an epiphysis, and may be the epiphysis of the posterior or true coracoid of the lower forms. More generally, "in the Amphibia, Reptilia, Aves, and Monotremes there is a coracoid throughout life from the sternum to the scapula. In the Placental mammals absorption of the coracoidal bar from the middle portion in each direction results in the complete disappearance of the sternal half of the coracoid, the rodents excepted; while the scapular half of the coracoid does not completely disappear, but is represented by its distal end, the coracoid process. The Ungulates constitute an exception to this, in which the entire coracoid bar disappears, leaving no trace at either end, excepting always its epiphysis incorporated into the glenoid, and known as the subcoracoid."

J. A. T.

Symmetry Reversal and Mirror-imaging in Monstrous Trout.—C. V. MORRILL (*Anat. Record*, 1919, 16, 265-91, 4 pls.). In some two-headed or otherwise duplicate trout the abdominal viscera of one component showed reversed symmetry in some degree. The mirror-imaging was practically perfect in some cases, while in others it was only slightly indicated or irregular. The facts are discussed in correlation with human monsters. In both fish and human monsters it is always the same component (the left) which exhibits transposition of the viscera. In cases where mirror-imaging occurs, the arrangement of the two sets of organs is always (unless in the famous Siamese twins) the same. The author discusses the theory of the difficult facts. "From the evidence at hand, it seems probable that the primary cause of visceral asymmetry in Vertebrates is to be sought for at the completion of cleavage rather than in the period of cleavage itself." J. A. T.

Pharyngeal Tonsil and Bursa in Calf.—RUTH RAND ATTERBURY (*Anat. Record*, 1919, 16, 251-64, 8 figs.). Emphasis is laid on the fact that the pharyngeal outpocketings in the calf (when present), and in the embryos of pig and man, "are merely mechanical expressions of the growth conditions of the pharyngeal region, arising in accordance

with the presence of the mechanical factors determining them." The pharyngeal bursa in man cannot be regarded as a structure of fundamental significance, essential to the development of the pharyngeal tonsil as Schwabach maintained. If it were essential, its presence might be reasonably expected in the pharyngeal roof of all forms which possess a well-developed pharyngeal tonsil. The calf has the latter, but a pharyngeal pocket corresponding to the bursa in man does not regularly develop. In the pharyngeal regions of embryos of the types discussed, an outstanding feature common to the three is a close relationship between the fibres of the fascia pharyngobasilaris and the pharyngeal epithelium.

J. A. T.

Influence of Gonads in White Rats.—CARL R. MOORE (*Journ. Exper. Zool.*, 1919, **28**, 137-60, 5 figs.). On the somatic side the early spayed female rat with implanted testis increases in weight, but it is not that the testis has any influence upon growth, it is rather that removal of the ovary allows a relative increase in weight. The same is true in regard to body length. The presence of the ovary tends to retard growth. Changes in hair and fat deposition and some other features do not seem to the author to prove a transformed sexual nature, but rats are not good material for this kind of inquiry. "The psychic behaviour of the animals, however, absolutely distinct in itself, lends great weight to the idea of a transformed sexual nature," such as Steinach insists on.

J. A. T.

Possibility of Differential Selection of Germ-cells in Fowl.—C. H. DANFORTH (*Proc. Amer. Ass. Anatomists in Anat. Record*, 1919, **16**, 147-8). If the germ-cells produced by a heterozygous animal fall into several classes, may they not react differently to chemically and physically changed surroundings, or at least show somewhat different potentialities in their competition with each other? To test this, cocks heterozygous in regard to brachydactyly, polydactyly, colour, and shape of comb were mated with hens homozygous for these features in their recessive forms. A record was made of the numbers in each class of young produced before and after treating the males with alcohol. The data thus obtained indicate that the administration of alcohol by inhalation alters the proportion of certain classes of chicks produced. This suggests that a mildly toxic agent may select between germ-cells on the basis of the Mendelian determiners which they carry. Incidentally it is observed that "a recognition of the fact that the probability that a germ cell will function is in some degree dependent upon the determiners which it carries, may lead to a satisfactory explanation for orthogenesis." This suggestion should be correlated with Weismann's germinal selection.

J. A. T.

Interstitial Cells in Gonads of Fowl.—H. D. GOODALE (*Anat. Record*, 1919, **16**, 247-50, 4 figs.). Evidence is submitted that the granular interstitial cells are really eosinophil leucocytes. They were found in relative abundance in the ovary and in degenerating tubules (not in normal portions) of the testis. Precisely similar cells may be

found in the thymus. Certain "luteal" cells, non-granular to all appearance, occur in the stroma of the chicken's ovary, and may be true interstitial cells furnishing an internal secretion. If it be true that the cells hitherto described as "interstitial" are leucocytes, this will explain the irregularities in their distribution in the ovary and the discrepancies in the accounts of various authors as to their occurrence or non-occurrence in the testis.

J. A. T.

Diet and Testicular Degeneration in Rat.—EZRA ALLEN (*Anat. Record*, 1919, 16, 93-117, 2 pls.). Reduction in the quantity of water-soluble vitamine in the diet of rats results in total degeneration of all the germ-cells of the testis, but does not interfere with growth and development in other respects. The Sertoli tissue persists. The interstitial tissue is hypertrophied. The type of degeneration of the germ-cells is like that produced by direct X-ray treatment of the testes. The Sertoli tissue is a syncytium.

J. A. T.

5. Histology.

Protoplasm and Cell Contents.—W. M. BAYLISS (*Report Brit. Ass.*, 1919, 117-22). Protoplasm in its simplest form is a liquid with particles suspended in it which may show Brownian movement. It is a dispersion of a more solid phase in a more liquid or watery phase. A great variety of structures can be produced by fixing reagents, but it is impossible to say which, if any, of these corresponds to the living state. The vacuole around the ingested alga in an amœba is spherical; an organism like *Badhamia*, filled with the brown spores of a fungus on which it feeds, can be filtered clear through cotton-wool; a needle can be repeatedly drawn through protoplasm without injuring it in any way. All these facts point to the conclusion that living protoplasm is a liquid. Ultra-microscopic examination of living nerve-cells, the only constituent cells of the tissues of higher animals as yet examined in this way, shows numerous particles in Brownian movement. From the hydrosol state protoplasm may occasionally pass to the state of a gel, when the shimmering movement suddenly ceases. This change is related to functional activity, and may be produced by weak electrical stimulation. Here are possibilities of the formation of membranes, doubtless of a gel nature, within the protoplasm, as is shown by the occurrence of different reactions at the same time in the same cell. It is as if the cell contained many minute factories. "Protoplasm is an extraordinarily complex heterogeneous system of numerous phases and components, continually changing their relations under the influence of electrolytes and other agents."

J. A. T.

Nature and Permeability of the Cell Membrane.—W. M. BAYLISS (*Report Brit. Ass.*, 1919, 122-37). "Although protoplasm is a hydrosol of low viscosity, it does not mix with water, remaining, while alive, as a separate phase. If 'killed,' as by an electrical shock or the application of an anæsthetic, it freely mixes with the surrounding watery solution. In the normal state it must be surrounded by a film

or membrane of some kind, which prevents escape of the cell contents. We may draw a similar conclusion from the fact that the products arising from the digestion of food particles in Protozoa, although consisting of such freely diffusible substances as glucose and amino-acids, are not washed out." The author discusses the nature of this membrane. "We may conclude that, when examined under normal conditions and at rest, living cells are surrounded by a membrane impermeable to most salts, to strong acids and bases, and also, as shown by osmotic experiments, to glucose and to amino-acids. There are, however, certain crystalloids to which the cell appears to be permeable under all conditions. These are urea, ammonium hydroxide, and some other ammonium salts, certain dyes of low molecular weight, alcohols, etc." "Nothing but a complex system of more than one phase will suffice to explain the changes in permeability which are shown by the surface membrane of the cell." "Since the membrane is a local concentration of components of the protoplasm of the cell, there must always be an equilibrium between the two. Hence a change in either involves a change in both." The author goes on to refer to typical physiological phenomena in which membranes of variable permeability are believed to play an essential part.

J. A. T.

Theory of Specific Plasma.—LOUIS LEGRAND (*La Sélection du Plasma Spécifique, Paris, 1916, 183*). Chemical analyses, biological reactions, grafting experiments, and other data prove the reality of specific plasmas characteristic of different species. There is plasma common to all members of a Metazoan species, and there are varietal, individual, and ancestral plasmas which are not quite so fixed. The former is cytoplasmic, the latter are nuclear. The male gamete is the vehicle of non-fixed plasmas of the individual male organism. The ovum is the vehicle in the main of the fixed plasma. Adaptation is fundamentally a cellular affair, and is effected in the course of development. The fertilized ovum is unstable, and cell-divisions are required to reach cellular adaptation. The individual plasmas are diluted more and more to the vanishing point: the specific plasma preponderates over them; there is a sort of struggle between them; degenerations and death mark the partial or complete victory of individual plasma over the specific plasma. From this point of view the author considers some of the great steps in organogenesis. The central fact is the continued chemical adaptation of the cell to its complicated environment. In the nutritive life of the organism there is a selection of specific plasma, at successive stages (physical choice of food, utilization of the food, on the part of intestinal cells, on the part of hepatic cells, and so on). This selection is not only individual, but racial. It began in the earliest individualities, which selected the most suitable environmental materials. In Metazoa the gonads themselves and the details of reproduction are adapted to secure the continuity of the specific plasma. In this connexion the female is much more important than the male. For species and individual alike the central fact is the preservation (by selection) of the specific plasma. That at least is the author's contention.

J. A. T.

Centriole and Centrosphere in Degenerating Fibroblasts.—WARREN H. LEWIS (*Proc. Amer. Physiol. Soc., 31st Meeting, in Amer. Journ. Physiol.*, 1919, **49**, 123). In the normal fibroblast the centriole lies close to one side or one end of the nucleus. The mitochondria do not appear to have any definite relation to it, being disposed more or less parallel to the long axis. As degeneration in culture proceeds granules accumulate about the centriole, and each granule usually becomes surrounded by a vacuole. The mitochondrial threads and rods become more or less radially arranged about the centriole. A clear area, the centrosphere, develops around the centriole. It is usually quite free from granules, vacuoles and mitochondria. It looks as if the centriole, and not the nucleus, was the centre of metabolic activity. J. A. T.

Passage of Solids from Nucleus to Cytoplasm.—M. v. DERSCHAU (*Arch. f. Zellforschung*, 1916, **14**, 22, 2 pls.). The passage of substances from nucleus to cytoplasm is believed to be in the main by the diffusion of materials in solution, and, in exceptional cases, by rupture of the nuclear membrane. The author denies the definiteness of this membrane. The boundary of the nucleus is due to larger and more closely packed droplets of basi-chromatin. Solid materials, e.g. of chromatin, pass readily across the vague nuclear frontier, to form chromidia and the like in the cytoplasm. J. A. T.

Minute Structure of Hagfish-skin.—K. E. SCHREINER (*Arch. Mikr. Anat.*, 1916, **89**, 109, 6 pls., 15 figs.). In the skin of *Myxine glutinosa* there are indifferent formative cells and three kinds of gland cells: (a) filament-making, (b) large vesicular mucous, and (c) small cylindrical mucous. A detailed account is given of the minute structure of these elements. The remarkable threads are produced from secreted granules and unite in an axial fibre which extends to the base of the glandular cell. It increases rapidly in length and is coiled in a spiral around the nucleus. The coils of the spiral are so numerous that it is not possible to decide whether the fibre is single or multiple. But this is only the beginning of the intricacy of structure that the author describes. J. A. T.

New Theory of Symbions.—PAUL PORTIER (*Les Symbiotes, Paris*, 1918, 315, 1 pl., 63 figs.). The author's theory, in support of which he conjures up ingenious evidence, is that all organisms except bacteria, are compound, being made up of the association of two different kinds of living creature. Every living cell includes in its cytoplasm what histologists call "mitochondria." These are really partner bacteria or symbions. The symbion or "symbiote" has two remarkable qualities, an extraordinary plasticity which enables it to adapt itself to the most varied conditions, and an extraordinary power of synthesis. The symbiotic bacteria come from without, and they may in certain cases return to an independent life. In most cases, however, the micro-organism has become irrevocably domesticated, and is unable to live outside of its partner-cell. J. A. T.

Continuity of Cells and Amitotic Karyokinesis.—I. P. MUNSON (*Proc. Amer. Assoc. Anatomists*, in *Anat. Record*, 1919, **16**, 158-9). Many cases are given of intercellular bridges connecting cells. Syncytia are common. Cell membranes are often absent. A mode of cell-division is described which is neither karyokinesis nor amitosis, but rather a combination of the two. The nucleus divides by cleavage, without forming a spindle. The centrosome divides, but the cell is not divided. "The cell theory is at fault when it fails to recognize the morphological continuity of protoplasm in many-celled organisms."

J. A. T.

Properties of Mesenchyme.—VERA DANCHAKOFF (*Proc. Amer. Assoc. Anatomists*, in *Anat. Record*, 1919, **16**, 146-7). Only under typical conditions does the greatest part of the embryonic mesenchyme become the primordium for the interstitial tissue of various organs. In experimental conditions much may proliferate into masses of granuloblastic tissue. Normally the interstitial connective tissue may retain phagocytic and digestive power. This may be an important factor in immunity. Tumour cells and erythrocytes may be surrounded and digested. The phagocytic and digestive activity of a mesenchymal cell is usually directed against dead particles, and possibly against weakened cells of its own kind. But it may operate against other cells, and this should be taken into account in interpreting the resistance of the organism to heteroplastic grafting.

J. A. T.

Distribution of Clasmatocytes.—CLAUDE S. BECK (*Proc. Amer. Assoc. Anatomists*, in *Anat. Record*, 1919, **16**, 143). Small pieces of tissue from various organs were placed in neutral red Locke's solution. In the subcutaneous tissue clasmatocytes are very abundant in the loose reticulum of the connective-tissue cells. Similarly in the sub-mucosa of stomach, intestine, œsophagus, in the sub-serous tissue. In the musculature of the gut they lie between the muscle bundles. They are absent from the endothelial lining of the gut and from the epidermis. They are plentiful in the cornea, striped muscle, and pia arachnoid. There are few in the amnion and in the sclera. There are few in the mesonephros, metanephros, and liver. They are abundant in the walls of the Wolffian duct. There are very few in the liver. None were found in optic lobes, retina, choroid. The method was unsatisfactory for the examination of the spinal cord and parts of the brain. They seem to be present in the choroid plexus and in the telencephalon medium.

J. A. T.

Structure of Clasmatocytes.—H. W. VANCE (*Proc. Amer. Assoc. Anatomists*, in *Anat. Record*, 1919, **16**, 166-7). Clasmatocytes are abundant in cultures of subcutaneous tissue. Their most striking features are the large central centrosphere, the large vacuoles, the excentric nucleus. At the centre of the finely granular centrosphere is often seen a single or double centriole. The periphery of the centrosphere is continued into the cytoplasmic framework, lying between the vacuoles which otherwise fill up the peripheral regions of the cell. There are often indications of radiations in the centrosphere which seem to

continue into the cytoplasmic framework. The nucleus is almost always crowded off to one side of the cell, often touching the edge. In many cases vacuoles separate the centrosphere from the nucleus. The centrosphere with its centriole seems to be the dynamic centre of the cell.

J. A. T.

Reissner's Fibre.—GEORGE E. NICHOLLS (*Journ. Compar. Neurology*, 1917, 27, 117-99, 35 figs.). Numerous careful experiments on this structure have been made with Selachians. If severed the fibre will generally be withdrawn in both directions from the lesion, the retraction being apparently effected by a spiral winding of the fibre, which attains a greatly increased thickness as the withdrawal proceeds. In dead or dying material this retraction may continue until the whole of the fibre has withdrawn to its points of attachment. In living specimens a tangle may be formed at the broken ends. In individual specimens in which such retraction has taken place there is a distinctive reaction—an abnormal posture when at rest, and probably an unusual motion. This reaction becomes apparent very shortly after the return to consciousness in anæsthetized fishes; it may be intermittent, and it is manifested by different specimens for widely different periods. There is probably a connexion between the degree of the reaction and the extent of the retraction of the fibre. The reaction is not observed in those individuals in which the fibre has been broken, but has, for any reason, failed to retract. Regeneration takes probably not less than a week. It commences with the uncoiling of the fibre, which extends backwards more or less slackly, becomes swollen, and probably by further growth comes once more into contact with the hinder wall of the sinus terminalis (original or secondary) into which it becomes inserted. It would appear that, as suggested by Dendy, the fibre serves to control automatically the flexure and pose of the body.

J. A. T.

Blood Supply of Areas of Langerhans.—MARY DRUSILLA FLATHER (*Anat. Record*, 1919, 16, 71-7, 8 figs.). The islets of Langerhans are groups of internally secreting glands embedded in the pancreatic tissue. Islets and pancreatic acini probably arise from common primordia. The cells of the islets, varying in form and structure, are always arranged in cords or masses separated by anastomosing blood-vessels. There is also in the islet a plexus of blood-vessels. The author studied the islets or areas in alligator, opossum, horse, racoon, skunk, badger, rabbit, and guinea-pig. With one exception, only one specimen of each species was studied, but the facts point to a distinct specificity of the cells and blood-vessels.

J. A. T.

Intercalated Discs in Striped Muscle.—H. E. JORDAN (*Anat. Record*, 1919, 16, 203-15, 1 fig.). Evidence is adduced that genuine intercalated discs occur in voluntary striped muscle under certain conditions. Support is found for the hypothesis that the intercalated discs of cardiac muscle are in essence modified irreversible contraction bands.

J. A. T.

Antiquity of Bone Structure.—ROY L. MOODIE (*Proc. Amer. Assoc. Anatomists*, in *Anat. Record*, 1919, 16, 157). The first bone arose in

the ectodermic tissues surrounding and capping the dorsal-fin spines of primitive Ordovician and Silurian sharks. This ancient tissue shows no evidence of Haversian systems or lamellæ. The first appearance of this is in a Devonian lung-fish. The perforating fibres of Sharpey are seen for the first time in the Mosasaurs of the Cretaceous, in a surface lesion of osteoperiostitis. Osteoid tissue is seen in the same lesions, similar in all respects to the osteoid tissue of modern times. Osteosclerosis and osteohypertrophy are sharply marked in the oldest known fractured bone from the Permian of Texas. There has not been much differentiation of bone since the middle of the Palæozoic. J. A. T.

c. General.

Non-existence of Nervous Shell-shock in Fishes and Marine Invertebrates.—ALFRED GOLDSBOROUGH MAYER (*Year-book, Carnegie Institution, Washington, 1917, No. 16, 185-6*). Experiments at Tortugas show that the nervous systems of fishes and marine invertebrates are remarkably resistant to the injurious effects of sudden explosive shocks. Ring-shaped strips of *Cassiopea* set into pulsation by an induction shock continued the rates of their pulsation waves within three feet of the explosion of a half-stick of dynamite. If the pulsating rings were in glass jars or tin cans, partly filled with air, the containers were crushed or shattered, but the rings though injured could be restored to normal pulsation by an induction shock if their pulsation had ceased. Bony fishes with no swim-bladder and small sharks were unaffected by an adjacent explosion. Fishes with a swim-bladder were killed, and dissection showed that the swim-bladder had burst and that the tissues were crushed in around it, often breaking the vertebral column. Echinoderms and Crustaceans are not affected. Apart from mechanical laceration, and apart from the crushing in of gas-containing cavities, there seems to be little injury to the nervous system. This supports the view that "war-shock" is a psychological rather than a physiological phenomenon. J. A. T.

Functional Correlation of Hypophysis and Thyroid.—JOHN A. LARSON (*Amer. Journ. Physiol., 1919, 49, 55-89*). The administration of the anterior lobe of the hypophysis has a very beneficial action on the maintenance and growth of thyroidectomized rat. Apart from the ameliorating effect upon the general condition, the life is definitely prolonged. It may be that there is a direct substitution of pituitary autacid for the thyroid hormone in a compensatory effect to establish normal metabolism, or the results might be due to a stimulating effect upon the total metabolic process. Further analysis is required. J. A. T.

Corneal Protection in Crawling Animals.—A. ROCHON-DAVIGNEAUD (*Annales d'Oculiste, 1916, 18 pp.*). In snakes the author finds a transparent shield continuous with the skin, separated from the true cornea by a conjunctival cul-de-sac containing tears. It seems to be a transparent lower eyelid, with a double epithelium, epidermic and conjunctival, as Müller and Dumeril described. In conger, common eel,

lamprey, and other crawling fishes, the eyelids play no part, but the true cornea is differentiated into three strata : (1) a thick, resistant, immobile superficial stratum, with external epithelium ; (2) a deep, delicate, inner layer, moving with the eye, with internal epithelium ; and (3) a median stratum, formed of lamellæ of connective tissue parallel to the surface, and loosely united so as to form a sort of articulating layer.

J. A. T.

Rate of Nerve-conduction in Sea-water.—ALFRED GOLDSBOROUGH MAYER (*Amer. Journ. Physiol.*, 1917, **44**, 591-5). In sea-water between salinities of 18 to 40 p.c., the rate of nerve-conduction in the jelly-fish *Cassiopea* varies as a straight line in relation to the electrical conductivity, or the degree of dissociation of the cations Na, K, Mg and Ca surrounding the nerves. Thus, if y be the rate of nerve-conduction, that in normal sea-water of 36·24 p.c. salinity being 100 ; and if x be the relative electrical conductivity of the sea-water, that of normal sea-water of 36·24 p.c. salinity and 8·22 P_u being 100, then

$$y = 0\cdot945x + 4\cdot4.$$

In sea-water of more than 40 p.c. salinity there is a decided and constantly augmenting reduction in the rate of nerve-conduction.

J. A. T.

Colour-sense in Fishes.—O. POLIMANTI (*Arch. Ital. Biol.*, 1915, **64**, 300-5). The reactions of the fishes studied seem to depend on the depth at which they usually live. It is well known that the rays of long wave length are absorbed not far from the surface, while those of short wave length penetrate further. Polimanti found that violet, blue, and green light had an almost constant influence on the number of respirations in the fishes studied, while red light and diffuse light had a very variable effect. By red and diffuse light the fishes experimented on are rarely affected in normal life. The general conclusion is that the fishes used are like completely colour-blind persons.

J. A. T.

Colour-discrimination in Sticklebacks and Mud-minnows.—GERTRUDE MAREAN WHITE (*Journ. Exper. Zool.*, 1919, **27**, 443-98, 10 figs.). Experiments were made with the American stickleback (*Eucalia inconstans*) and mud-minnow (*Umbra limi*) in regard to their powers of association and colour-discrimination. It was found that the mud-minnows could discriminate between many colours, and the sticklebacks to a less degree. Both established associations between food and various colours. Experiments with patterns show that these are not very important in the search for food. The perception of colour and movement seems to be of chief importance. In sticklebacks the sense of smell is also used to some extent. "The behaviour of fishes is stereotyped. The associations formed are simple, few in number, and not open to ready modification, though they may be fairly permanent, and may involve considerable acuity in sensory discrimination. Learning seems to consist for the most part in the gradual elimination of useless movements and the establishing of those which are useful." There is nothing to indicate ability to recall an image of past experience, but

impulses may be inhibited by the results of experience. In schools of sticklebacks swimming together there is no evidence of intelligent purpose, other than that many may follow the dart-movement made by one.

J. A. T.

Colour-sense in Diurnal Birds.—ERNA HAHN (*Zeitschr. wiss. Zool.*, 1916, **116**, 1-42, 1 pl., 7 figs.). Experiments with blue exotic birds, such as parrots, yielded few satisfactory data. In some, e.g. *Ara*, sight is not the only guide in seizing food. Others, e.g. *Melopsittacus* and *Cyanospiza*, seemed unable to become accustomed to take their food on an area illumined by light of different colours. On the other hand, fowls seem readily able to see blue colours. They picked up blue seeds and uncoloured seeds in a blue area; they made no use of those in ultra-blue or ultra-violet areas. Hess found that his fowls did not use blue seeds, but Hahn points out that this was probably because they had no association with blue food. Hess thought that his birds did not see blue objects because of coloured drops of oil in the cones of the retina. Hahn finds that these oil-drops vary greatly in different kinds of fowls.

J. A. T.

Reactions of Dogfishes to Injections.—E. R. HOSKINS and M. M. HOSKINS (*Journ. Exper. Zool.*, 1918, **27**, 101-155, 6 pls.). Various non-toxin solutions and suspensions (including vital dyes) were injected, and also various excretory toxins. The digitiform gland of *Mustelus* excretes about a cubic centimetre a day of clear alkaline fluid containing urea. Certain injected solutions, but no suspensions, were recovered in this excretion. Injections of excretory toxins injure this gland. The Selachian kidney is a less efficient excretory organ than the mammalian kidney. The liver is relatively a very efficient excretory organ. The spleen is very well adapted for phagocytic activity, and is stained deeply by injected insoluble dyes. Injected particles produce leucocytosis. Toxins cause congestion in the spleen, the endothelium appears to be injured, peculiarly shaped nuclei may be produced, and many nuclei become hyperchromatic. The spiral valve has some excretory function, the stomach none. Excretory toxins pass through the epithelium of the spiral valve and destroy it, although they do not injure the intestine immediately anterior to or posterior to the spiral valve. The endothelium lining the arterial arches, and especially the large sinuses in the gills, is very phagocytic to injected trypan-blue and coarsely powdered carmine. It stores such substances in concentration greater than that in any other cells examined, and at the same time it proliferates and produces free phagocytes which circulate through the body. J. A. T.

Blood and Blood Gases in Hibernating Woodchuck.—ANDREW T. RASMUSSEN (*Amer. Journ. Physiol.*, 1916, **39**, 20-30; *ibid.*, **41**, 162-172, *ibid.*, 464-82). During hibernation in *Marmota monax* the blood has an extra amount of CO_2 ; there is reduced alkalinity and this diminishes the power the blood has of absorbing CO_2 ; the difference between venous and arterial blood as regards gases is much accentuated. The amount of CO_2 increases during hibernation and decreases on awakening. The percentage of oxygen in the arterial blood is greatest immediately

before and during the sleep. In full hibernation there is a slight (5 p.c.) increase in the number of red blood corpuscles; the number of leucocytes is reduced to a half. In half-sleep, with the temperature intermediate between that of activity and that of hibernation, there is a notable increase in the number of red blood corpuscles, the quantity of hæmoglobin, and the specific gravity; the white blood corpuscles are twice as abundant as in the wideawake state and four times as abundant as in complete hibernation. In the transition period there is a peculiar state of activity. On wakening, but before eating, the animal shows a condition of the blood like that of half-sleep, except that the number of leucocytes approaches the normal. The size of the red blood corpuscles is not changed during hibernation. The number of mononuclear leucocytes is somewhat reduced in relation to the number of polynuclear leucocytes.

J. A. T.

Nerve-cells of Woodchuck during Hibernation.—ANDREW T. RASMUSSEN (*Proc. Amer. Assoc. Anatomists*, in *Anat. Record*, 1919, 16, 160-1). In *Marmota monax* the mitochondria in the chief cells of the brain and spinal cord show no noticeable change in number, size, shape, or grouping during hibernation. Five adult animals were examined before hibernation began, five towards the end of the dormant period, and five at various intervals after waking up and becoming active.

J. A. T.

Luminous Animals.—ULRIG DAHLGREN (*Year-book, Carnegie Institution*, 1918, 17, 157-8). An account of a collecting expedition, referring to Ctenophores, Noctiluca, an apparently luminous dolphin ("a moving luminous body with a diminishing trail of several yards"), some luminous Collembolids, the firefly *Photuris pennsylvanica*, an earthworm (*Microscolex*) "with an autogenous organic light in response to well-known stimuli," luminous mycelia in decaying wood, the firefly *Pyroactomena borealis*, a species of *Phenogodes*, and so on. Of a firefly (*Phausis*) in Alabama it is noted that the light is very distinctly blue, and that the adult female is a white wingless grub with multiple lights on all surfaces. The luminous organ is of the simple two-layered type, without "ovals."

J. A. T.

Death from High Temperature.—ALFRED GOLDSBOROUGH MAYER (*Amer. Journ. Physiol.*, 1917, 44, 581-5). Experiments were made with reef-corals kept in warm sea-water. The fatal temperature for different species was determined; it varied from 34°·7 C. to 38°·2 C. Those corals which live in cool, relatively agitated water free from silt are those that cannot withstand high temperatures, whereas those which live in the hot, silt-laden shallows near shore are generally speaking resistant. What causes death? The fatal temperature is too low for the coagulation of most if not all proteids; when killed the animals are fully relaxed; moreover, coagulated proteids could not readily be eliminated when the animal was restored to water at normal temperature, coagulation being practically non-reversible. Nor is death at high temperature due to asphyxiation, for the experiments showed that there is no direct relation between the oxygen supply and the fatal tempera-

ture. What then? It seems possible that death from high temperature may be due to the accumulation of acid (possibly H_2CO_3) in the tissues, the rate of formation of this acid being commensurate with the rate of metabolism of the tissues. Thus, animals of the same class having a high rate of metabolism, as measured by oxygen consumption, are more sensitive to heat and to CO_2 than are those having a low rate of metabolism.

J. A. T.

Acclimatization and Upper Thermal Death Points.—M. H. JACOBS (*Journ. Exper. Zool.*, 1919, **27**, 427-42). Experiments with starfish larvæ and Paramecium show that in the former there is practically no acclimatization effect, while in the latter acclimatization occurs even in a short time. A formula is given for expressing the acclimatization in quantitative form. The surplus resistance gained by Paramecium is very remarkable, rising to forty-three. "The animals have, in other words, added to their normal lives, so to speak, forty-three additional lives by their ability to adjust themselves to the changing environment." In general, the slower rates of temperature increase are more favourable for Paramecium and more unfavourable for starfish larvæ than the more rapid ones, and it is suggested that data on upper thermal death points should always include not only the times of exposure to the temperatures in question, but exact statements as to the methods by which these temperatures have been reached.

J. A. T.

Influence of Adrenin on Frog's Melanophores and Retina Cells.—ANDREW J. BIGNEY (*Jour. Exper. Zool.*, 1919, **27**, 391-6). Adrenin causes a contraction of the pigment in the dermal melanophores and an expansion of that in the retinal cells—processes precisely the opposite of each other. When the optic nerve of one eye was cut close to the brain, the retinal pigment was still expanded after an injection of adrenin, which shows that the drug is very probably carried in the blood.

J. A. T.

Bent Tail in Mice.—ERNST BLANK (*Arch. f. Entwicklungsmech.*, 1916, **42**, 333-46, 36 figs.). A detailed anatomical and histological account of a markedly elbowed tail in a race of mice. The bending is due to a partial fusion of vertebrae, the result of a process analogous to that which leads in ontogeny to the reduction of the number of caudal vertebrae in a good many mammals.

J. A. T.

Osmotic Pressure of the Blood.—GEORGE G. SCOTT (*American Naturalist*, 1916, **50**, 641-63). The blood of marine Invertebrates has the same osmotic pressure as the sea-water and the same content of salts. It is the same in a marine Cyclostome. In Elasmobranchs the osmotic pressure is the same, but there is only 1.7 p.c. of sodium chloride instead of 3 p.c., urea and other organic compounds making up the difference. Marine Teleosteans, without urea in the blood, show an osmotic pressure half that of the sea-water. Fresh-water Teleosteans and higher animals have a still smaller osmotic pressure. Scott points out that anadromous fishes, like salmon and eel, experience, when they leave the sea and enter fresh-water, a notable reduction (about 18 p.c.)

in their osmotic pressure. The low osmotic pressure in the blood of Amphibians and some higher Vertebrates points to a derivation from fresh-water ancestors. In Mammals' blood there are more salts than in Amphibians' blood, but the proportions of salts of sodium, potassium, calcium and magnesium is precisely parallel to the proportions in sea-water, as Quinton has shown. This is a record of the ancestral marine habitat.

J. A. T.

Evolution of the Chin.—T. T. WATERMAN (*Amer. Naturalist*, 1916, 237-42). Walkhoff and Robinson have interpreted the chin as a result of articulate speech, for it distinguishes modern man from Primates and even from the Heidelberg man. But the elephant seems to have a very pronounced chin, if the mental process is really homologous with man's. But Waterman's idea is that the human chin is a residue of a much larger mandible in ancestral forms. The reduction has been unequal, more on the upper margin (associated with smaller and more closely packed teeth) than on the lower margin of the mandible. The chin is a relic, not a new acquisition.

J. A. T.

Dentigerous Cyst on Cod's Upper Jaw.—H. CHAS. WILLIAMSON (*Journ. Pathology and Bacteriology*, 1919, 22, 255-6, 2 pls.). A condition of rare occurrence is described. A hard spherical tumour projecting from the right maxilla was found to consist of a bony capsule covered with a thick, fairly soft, rugose skin, and contained between the periosteum and the dermis a dark-red layer of tissue bearing teeth, while inside the cyst there were no fewer than seventeen hundred. The tumour had apparently arisen through the persistence on the anterior side of the premaxilla, between the periosteum and the bone, of a portion of dentigerous tissue.

J. A. T.

Fossil Fish-scales.—T. D. A. COCKERELL (*Amer. Naturalist*, 1917, 51, 61-3). Attention is directed to the work of Geinitz on fish-scales and to his careful drawings. "Although Geinitz knew little about the affinities of his scales, they had excellent characters, reminding us in certain cases of modern genera, and indicating the great antiquity and constancy of peculiarities of scale structure." The author pleads for a more systematic and critical study of fossil fish-scales.

J. A. T.

Tunicata.

Nervous System of Ascidian.—EDWARD C. DAY (*Journ. Exper. Zool.*, 1919, 28, 307-35, 5 figs.). The margins of the siphons of *Ascidia mentula* are the most sensitive part of the animal, closing when stimulated. Feeble stimulation may affect a single lobe, stronger stimulation the whole siphon, stronger still the other siphon as well. In a siphon partially slit longitudinally each half responds locally to a feeble stimulus, while stronger stimulation sends the impulse around the cut, and produces a response of the two halves in sequence. Amputated siphons retain their sensitiveness for five or six days and then die. They are replaced, and the ganglion is not necessary for the regenera-

tion. Indeed, if the ganglion be amputated with the siphon it will be regenerated. Extirpation of the ganglion has two main effects: (a) an interruption of co-ordination between the siphons, and (b) a reduction of tone and general irritability of the animal. The ganglion regenerates in four to six weeks. The new one is very quickly fatigued. An account is given of responses to chemical stimulation. Both siphons are sensitive to disturbing vibration. Amputated incurrent siphons respond only if they are cut off to include the circlet of tentacles; amputated excurrent siphons are insensitive; deganglionate animals respond with closure of both siphons, but a more vigorous stimulation than normal is needed to elicit the response. A useful summary is given of the results of previous investigators. The ganglion consists of a central fibrillar substance surrounded by a peripheral layer of cells; it develops from the larval cerebral vesicle; it is regenerated from a derivative of the same tissue as that from which the original ganglion developed. The ganglion of *Ciona* regulates reflexes in a feeble way either by inhibiting or facilitating them.

J. A. T.

Taxonomic Study of Salpidæ.—MAYNARD M. METCALF (*Bulletin U.S. Nat. Museum*, 1918, 100, 5-193, 14 pls., 150 figs.). This is a big piece of work, in which the author was assisted by Mary M. Bell. In studying the inter-relationships the greatest significance attaches to

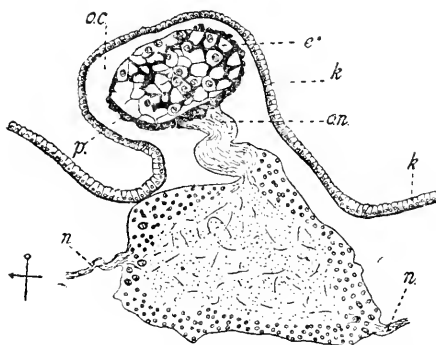

Oblique vertical section of dorsal eye of *Pegea confederata*, subspecies *bicaudata*, aggregated form. $\times 180$.

*e**, basal portion of eye; *k*, ectodermal epithelium; *an*, optic nerve; *n*, nerve leaving ganglion; *p*, pigment; *ac*, optic chamber, a lymph space.

the gut, the nervous system, and the muscles, the symmetry or asymmetry of the body and its muscles being also of some importance. The solitary form is the more conservative; the aggregated individuals are more plastic and divergent. Some features of the secondarily simplified nervous system are very inconstant, such as the number of nerves radiating from the ganglion. The eyes of the aggregated form are important taxonomically. Adaptive divergence and convergence can

be left out of consideration in connexion with these degenerating organs. The genera dealt with are *Cyclosalpa*, *Brooksia*, *Apsteinia*, *Salpa*, *Ritteria*, *Jasis*, *Thalia*, *Thetys*, *Pegea*, and *Traustedtia*; a chart of relationship is given. The major divisions are Dolichodæa, Sphærodæa, and Cir-

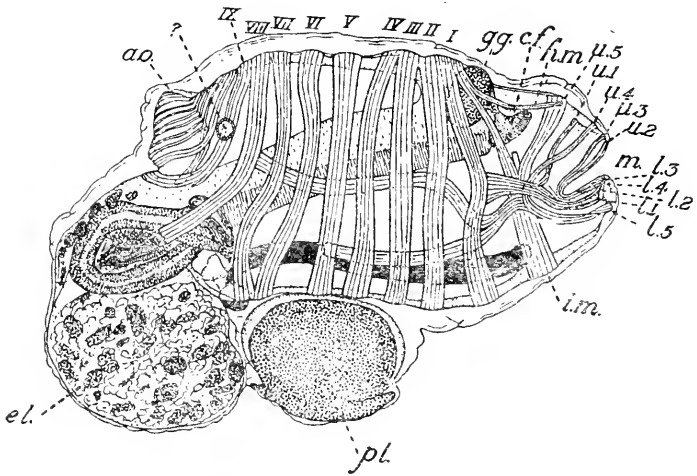

Apsteinia asymmetrica, an embryo 2.5 mm. long, viewed from the right side.

pl., "placenta"; *el.*, eleoblast; *ao.*, atrial opening; *gg.*, ganglion; *c.f.*, ciliated funnel; *m.*, mouth; the other letters refer to muscles.

codæa. In the group Salpidæ hybridization is unknown. It is probable that the Doliolidæ arose from somewhat *Pyrosoma*-like ancestors, by giving up the compact colonial form, and that from *Doliolum*-like ancestors arose the Salpidæ.

J. A. T.

Taxonomic Study of *Pyrosoma*.—MAYNARD M. METCALF and HOYT S. HOPKINS (*Bull. U.S. Nat. Museum*, 1919, 100, 195-275, 21 pls.). A fine study based on the collections in the U.S. National Museum. The family Pyrosomidæ is generally regarded as containing but one genus, *Pyrosoma*, but the groups *Pyrosomata ambulata* and *Pyrosomata fixata* might be regarded as separate genera. The authors have studied 213 colonies, comprising 13 species and varieties, including all but 4 of the forms of *Pyrosoma* hitherto described, and 6 undescribed forms. Some of the forms are probably transient, for it seems that the genus is in flux. Within the two subgenera, which are sharply distinct, there are groups of forms with much intergradation, and others which diverge. It is difficult to lay down the law about species until we know whether mutation is continuing at present. The conditions suggest that interbreeding, especially in the *atlanticum* series,

is at present going on freely. The origin of the Pyrosomes may be found in Compound Aseidians, through such forms as *Cyathocormus* and *Cælocormus*. In contrast to Salps, where species are very distinct

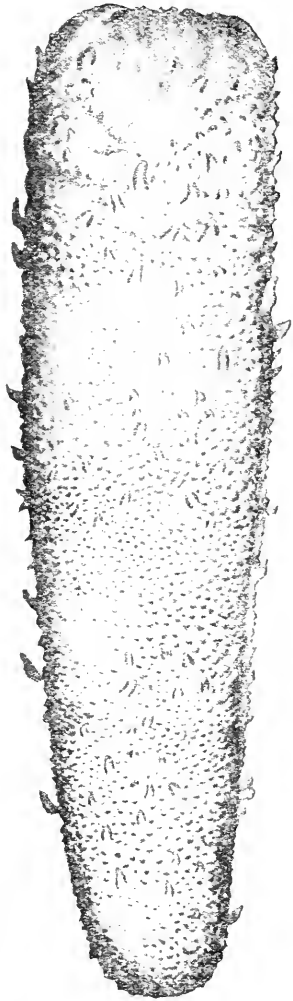
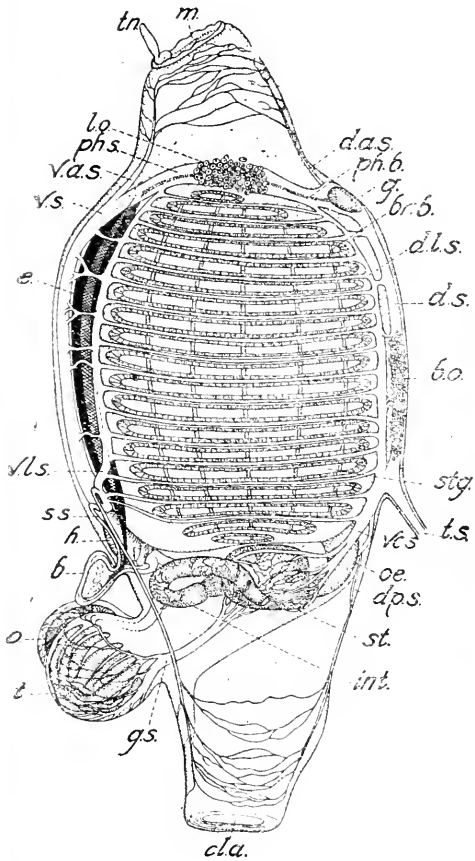

Pyrosoma atlanticum. A diagrammatic figure of a zoid. After Berghause.

Pyrosoma atlanticum, form *dipleurosoma*.

A colony seen from the flattened face. $\times \frac{1}{3}$. After Brooks.

m., mouth; *d.a.s.*, dorsal anterior blood sinus; *ph.b.*, peripharyngeal band of cilia; *g.*, ganglion; *br.b.*, branchial bars; *d.l.s.*, dorso-lateral blood sinus; *d.s.*, dorsal blood sinus; *b.o.*, blood-forming organ; *stg.*, stigma; *t.s.*, blood sinus to tunic; *vc.s.*, visceral sinus; *œ.*, oesophagus; *d.p.s.*, dorsal posterior blood sinus; *st.*, stomach; *int.*, intestine; *cl.a.*, cloacal aperture; *g.s.*, posterior gonadal sinus; *t.*, testis; *o.*, ovary; *b.*, bud; *h.*, heart; *s.s.*, stolon blood sinus; *v.l.s.*, ventro-lateral blood sinus; *e.*, endostyle; *v.s.*, ventral blood sinus; *v.a.s.*, ventral anterior blood sinus; *ph.s.*, peripharyngeal blood sinus; *l.o.*, luminous organ; *tn.*, tentacle.

from one another, those of Pyrosomes tend to intergrade. An interesting general feature is that the individuality of the cell is not only subordinated to that of the zoid, but in the case of some cells, e.g. in the making of the test, to the colony as a whole without reference to the zooids.

J. A. T.

INVERTEBRATA.

Mollusca.

Use of Foot in some Molluscs.—W. J. CROZIER (*Journ. Exper. Zool.*, 1919, **27**, 359–66, 1 fig.). To types of locomotion in Molluscs already described a new type is added, a “looping” movement seen in *Xenophora*. It involves the body-musculature generally, but the suction of the foot is also needed. It may be classed with the “gallop” of *Helix*, though it has distinctive features. A second good example of arhythmic pedal progression is described in species of *Conus*, and three species of Chitons (in the genera *Ischnochiton*, *Acanthochites*, and *Tonicia*) are added to the list of those Molluscs known to move by means of retrograde pedal waves. It is noted that *Ischnochiton* can move posteriorly, preserving the retrograde character of its pedal waves, with considerable freedom and for appreciable distances. It also exhibits a “gallop,” such as Carlson has described in *Helix*, which is independent of the pedal waves.

J. A. T.

a. Cephalopoda.

Colour-sense in Octopus.—O. POLIMANTI (*Arch. Ital. Biol.*, 1915, **64**, 293–300). There is extraordinary divergence of results in the experiments that have been made on Cephalopods in regard to colour-sense. Polimanti, working with *Octopus vulgaris*, has measured the sensitiveness by the oscillations in the respiratory movements. He finds that violet and blue light are most stimulating, green less, red still less. But he inclines to the view that there is not in *Octopus* any perception of colours. He thinks that differently coloured lights affect the metabolism, and that the changes in metabolism affect the respiratory movements. But it is evident that more experiments are required.

J. A. T.

γ. Gastropoda.

Sensitiveness of Gill-plumes of Chromodoris zebra.—W. J. CROZIER (*Proc. Amer. Physiol. Soc.*, 31st Meeting, in *Amer. Journ. Physiol.*, 1919, **49**, 147). Between 15° and 32°, and in sunlight not too intense, the gill-plumes of this Nudibranch respond by contraction when they are shaded. This contraction, due to the activation of receptors locally contained, leads to the reflex retraction of the gill crown as a whole within its collared pocket. The degree of extension of the gill crown as a whole is a function of the light intensity, but is controlled through a separate set of receptors. The animal is photokinetic. The sensitivity of the plumes to shading is abolished if the alkalinity of the water is reduced. The “protective” reaction to shading is a response

superimposed upon the simple system of fundamental activities (protrusion, retraction) which is concerned with regulating the gaseous exchange. J. A. T.

Assortive Mating in Nudibranchs.—W. J. CROZIER (*Journ. Exper. Zool.*, 1918, **27**, 247-92, 23 figs. and charts). A study of 148 conjugating pairs of *Chromodoris zebra* showed a rather high degree of correlation between total length (and other dimensions) of the two components of the pair. This correlation is the result of assortive mating. In most cases large individuals mate successfully with large, small individuals with small. The Nudibranch in question is functionally hermaphrodite, and effective reciprocal insemination occurs. The number of eggs deposited in a single mass varies from 2,000 to 20,000, and is almost directly proportional to the length of the animal. The larger animals possibly lay more egg masses in a given time than do the small ones. It is consequently of advantage to the species that large individuals should mate together. In this way the numbers of eggs fertilized, and presumably of larvæ set free, as the result of any one mating, is on the average greater than that which would be produced if random pairing were the rule. Moreover, by means of assortive mating there is conservation of eggs, and perhaps of sperms. The selective pairing may seem "purposeful," but it is clearly an automatic consequence (1) of the fact that the eggs are fertilized internally, necessitating the copulation of adults, and (2) of the fact that the size of the body is not identical in all sexually mature individuals. J. A. T.

Sex-changes in Crepidula plana.—HARLEY N. GOULD (*Proc. Amer. Ass. Anatomists*, in *Anat. Record*, 1919, **16**, 149-50). This Gastropod passes through a male phase, a transitional phase, and a female phase. The male phase is unstable, and occurs only as the result of a stimulus from a larger specimen of the same species. Large individuals of *C. fornicata* have not been found to induce male development in small specimens of *C. plana* except in a few doubtful cases. Isolation experiments of different degrees (with *C. plana*) indicate that the stimulus to male development is a substance given off from the bodies of the large specimens, diffusible through sea-water, but very unstable. J. A. T.

Arthropoda.

a. Insecta.

Vestigial Wing in Drosophila ampelophila.—ELMER ROBERTS (*Journ. Exper. Zool.*, 1918, **27**, 157-92, 2 pls., 3 figs.). It was found that selection failed to modify the size of the vestigial wing which marks one of the varieties of this fruit-fly. It behaves as a Mendelian recessive character when its bearers are crossed with individuals with normal long wings. The offspring in the first generation have long wings, while in the second generation both long-winged and vestigial-winged individuals are produced. But these are not in the ration 3 : 1, but 3.95 : 1. The size and form of the vestigial wing are affected by crossing to long-winged flies. In other words the character fluctuates.

The males show greater effects from "crossing-in" than do the females. It was found also that the size and form of the vestigial wing are affected by high temperature, and the males more easily than the females. Roberts discusses two possible interpretations of the facts:—(1) The increased size and variability of the vestigial wing may have been due to the introduction of modifying factors from the wild stock, these factors acting more effectively when the temperature was higher than the normal; or (2) a gametic contamination may have occurred when the vestigial wing factor came into association with its allelomorph, long wing (or in the association of the developer for wings with the absence of this developer).
J. A. T.

Purple Eye in *Drosophila*.—CALVIN B. BRIDGES (*Journ. Exper. Zool.*, 1919, 28, 265–305). The character "purple eye" has been very useful as a tool in the study of genetics in the fruit-fly. It is a second chromosome eye colour, very distinctive, completely and constantly recessive. Its locus is at the middle of the second chromosome, close to black. In the field of mutation purple gave with vermilion the first case in which "intensification," or "disproportionate modification," was recognized and made use of. It was the first of the class of "dark" eye-colour mutations. It has been of great service in attacking the problems of "inviability," "autosomal linkage," and the analysis of the relation between the physical chromosome and the process of "crossing over."
J. A. T.

Myrmecophilous Beetle.—A. GALLARDO (*Physiol.*, 1916, 2, 254–7, 1 fig.). In the nest of the ant *Solenopsis pylaudes* Forel the author found a small beetle, *Fustiger elegans* Raffray, and a little Hemipteron which was tolerated. The beetle was very carefully treated by the ants, which lick odoriferous hairs bordering the elytra, and carry it in their mandibles when danger threatens.
J. A. T.

Spermatogenesis in *Deilephila euphorbiæ*.—J. E. BUDER (*Arch. f. Zellforschung*, 1916, 14, 53 pp., 4 pl.). Verson's cell and the cyst-cells are regarded as modified spermatogonia. The last spermatogonia are transformed into spermatocytes at the stage of synapsis, due probably to the fusion of the chromosomes into a single filament. The conjugation of chromosomes is prepared for by the transformation of the filament. Two dyads result. The first division separates the two halves of the dyads and is equational. The second is a reducing division. There is no basis in the germinative cells for dimorphism. The existence of a heterochromosome is doubtful. Much attention has been given to the complicated changes undergone by the mitochondria and to the transformations of the centrosomes.
J. A. T.

So-called Hypnosis in Cockroach.—J. S. SZYMANSKI (*Arch. f. Ges. Physiol.*, 1916, 166, 528–31). If a cockroach (*Periplaneta orientalis*) is placed in an unnatural attitude and kept from moving, it passes for a variable period into a state of immobility. Even if it be placed on its back and kept in that position it passes into the state of "animal

hypnosis." The insect may be "awakened" by mechanical and chemical stimuli, not by optic or acoustic stimuli. After awakening it is just as lively as usual, which shows that the "hypnotic" state is not a fatigue phenomenon. J. A. T.

Mitochondrial Changes in Spermatogenesis.—D. VOINOV (*C. R. Soc. Biol.*, 1916, **79**, 451-4, 1 fig.). During spermatogenesis in *Gryllootalpa* the mitochondrial substance goes through a series of changes like karyokinesis. In a prophase in the young primary spermatocytes the mitochondria fuse into a filament which fragments transversely into segments which condense into "chondriosomes." This is like the formation of chromosomes from the chromatin spireme. In a metaphase there is a spindle of chondriosomes which divide under the attractive influence of the centrioles. This "chondriodieresis," like karyokinesis, effects a precise distribution of the cytoplasmic hereditary substance located in the mitochondria. J. A. T.

Peculiar Occurrence in Spermatogenesis of Gryllootalpa.—D. VOINOV (*C. R. Soc. Biol.*, 1916, **79**, 542-4, 2 figs.). In spermatocytes of the first order a globular mass was observed in the middle of the chondriosome. It divided into four pieces, which approached the centrosomes and passed to the second spermatocytes, two to each, and then one into each spermatid. Yet in the transformation of spermatid into spermatozoon the mysterious little body was rejected. J. A. T.

Striped Muscle of Mantis.—H. E. JORDAN (*Anat. Record*, 1919, **16**, 217-45, 3 pls.). The wing-muscle of this insect furnishes an exceptionally favourable material for the investigation of the interfibrillar sarcoplasmic granules, or sarcosomes, characteristic of insect wing-muscle. They are here unusually large and abundant. They change their shape and position during contraction of the muscle-fibre. The salient differential features between the leg- and wing-muscles pertain to a conspicuous N-disc in the leg-fibre and sarcosomes in the wing-fibre. The sarcostyles of the muscle are of lamellar form peripherally and cylindrical form centrally. Both types contain constituent myofibrils. The sarcosomes are distributed in the intersarcostylic sarcoplasm. The myofibrils are directly continuous with the tendon-fibrils. The N-disc is formed by lateral juxtaposition of intrafibrillar constituents. The sarcosomes are spherical to start with; they are modified by pressure; they are in the main analogous to fat-globules; they become hollow vesicles, which often collapse, suggesting a nutritive function. J. A. T.

Collembola of the Snow Level.—ED. HANDSCHIN (*Revue Suisse Zool.*, 1919, **27**, 65-98, 1 pl.). Thirty-four species are described from the snow level of the Central Alps, including *Onychiurus zschokksi* sp. n. and *Tetracanthella afurcata* sp. n. The Collembola live under stones, among lichens, and among such vegetation as there is; the chief desideratum is to avoid drought. They feed on decaying plant remains, including pollen-grains from the Conifers. Springing into the air is only resorted to when the danger is great. There are sometimes great mass movements—e.g. of *Isotoma saltans*. These may have something to do

with hunger, and perhaps also to some extent with the weather ; but the author notes that there are favourable places for depositing the eggs, and that the young forms migrate from these in bands seeking food. The minuteness of the body is in itself an adaptation preventing the freezing of the body-fluids. The hairs on the body and the dark colour may also help.

J. A. T.

ε. Crustacea.

Nerves of Antennules Regenerated in Place of Eyes.—CURT HERBST and H. PLESSNER (*Arch. Entwicklunsmech.*, 1916, **42**, 407-89, 11 pls.). When an antennule of *Palæmon* or *Palimurus* is regenerated in place of an eye, bundles of nerve-fibres grow centripetally from the antennule, enter the stump of the optic nerve, and traverse it to reach the brain. In the stump of the optic nerve and the oculomotor nerve there is a proliferation of cells forming the sheaths of the nerve-fibres. The old optic nerve becomes an antennary nerve. In *Palimurus* there develop at the base of the optic stump large ganglion cells such as occur normally at the root of the first antennary nerve. Some nerve-fibres from the antennule lose themselves in the head, others enter the stump of the oculomotor and reach the brain that way. The main passage of the new antennary nerve is through the stump of the old optic, and this explains how excitation of the new antennules results in reaction movements the same as those which normally follow the excitation of the eye-stalk. Herbst does not think that the brain directs the new fibres, but there may be an attractive influence from the degenerating nervous substance at the stump of the optic nerve. When the new fibres reach the brain there may be a reaction from the brain influencing their further development.

J. A. T.

Ceina egregia: an Aberrant Amphipod.—CHARLES CHILTON (*Trans. New Zealand Inst.*, 1919, **51**, 118-29, 25 figs.). An account

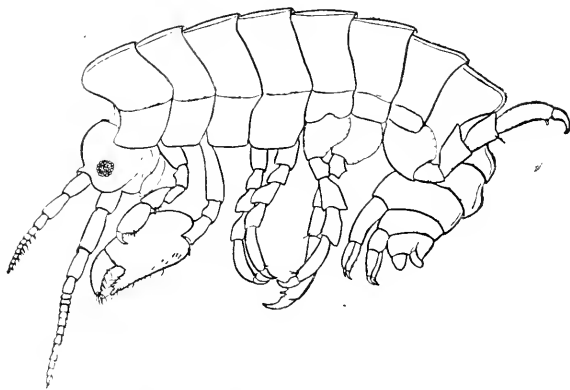

Ceina egregia. Side view of male.

is given of this aberrant form, one of the Talitridæ. In many of its characters it more or less resembles *Hyale* ; in some it approaches

Chiltonia. Only one species is known. The genus may be defined as follows:—Mandible without definite molar tubercle. First maxilla with palp absent or vestigial, inner lobe small and without plumose setæ. First gnathopoda small and subchelate in both sexes; second gnathopoda large and chelate in the male, subchelate in the female. Third uropoda

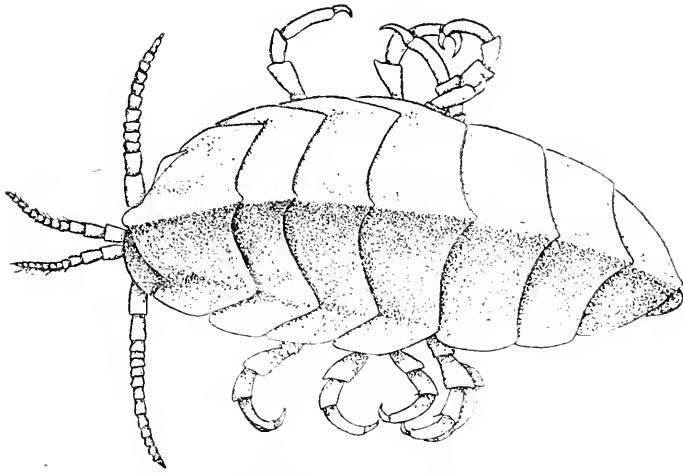

Ceina egregia. Dorsal view of female.

represented by a small rounded lobe. Telson formed of a thick plate, partially cleft. The animal occurs on New Zealand coasts, at the roots of seaweeds, generally about low-tide mark. It is protectively coloured. Its length is 6 to 7 mm.

J. A. T.

Redescription of *Orchestia tucurauna* Fritz Müller.—CHAS. CHILTON (*Ann. Mag. Nat. Hist.*, 1919, **3**, 376-86, 14 figs.). This species occurs both in South America and in New Zealand, an instance of a not uncommon distribution among Crustacea. It occurs in brackish or fresh-water. The author gives an adequate description, with good figures.

J. A. T.

Reactions of Land Isopods to Light.—CHARLES H. ABBOTT (*Journ. Exper. Zool.*, 1918, **27**, 193-246, 14 figs.). Experiments with *Oniscus asellus*, *Porcellio ratkei*, and *P. scaber* show that land Isopods respond to light stimuli by photokinesis, by phototaxis, and to a slight degree by vision. Phototactic reactions were studied. *Oniscus* is negative to diffuse daylight and to controlled horizontal illumination by artificial light. *Porcellio* is less consistently negative. The response was the same to all intensities from 100 candle metres to 0.01. No consistent change in the phototaxis of *Oniscus* was caused by repetition of stimuli, by previous exposure to strong light or weak, by maximum or minimum of moisture. *Porcellio* was somewhat less negative after living in a dry

habitat, and some individuals were found to be positive after exposure to strong light. When the Isopods were immersed in water they did not respond. The negative phototaxis appears to be a factor in keeping the land Isopods in a suitable habitat. Land Isopods are more definitely negative to light than the fresh-water *Asellus communis*. J. A. T.

Influence of Environment on *Bosmina longirostris*.—OTTO HARTMANN (*Arch. Entwicklungsmech.*, 1916, **42**, 208-21, 1 pl.). Many differences are known among individuals of the same Cladoceran species, e.g. *Bosmina longirostris*. Every basin with distinctive peculiarities has distinctive forms. The author has reproduced these experimentally, e.g. as regards shortening of the tactile antennæ, by altering the composition of the medium, e.g. by adding minute quantities of chemical reagents, such as bromide of potassium, phosphoric acid, and hydrate of chloral. The "variations" are "modifications." J. A. T.

Food of Pelagic Copepods.—CALVIN O. ESTERLY (*Univ. California Publications, Zoology*, 1916, **16**, 171-84, 2 figs.). Oil-immersion examination of the food canal showed cases of minute diatoms and some other minute organisms. All were too small to be seized by the Copepod. A current passes through the setæ of the first maxillipedes, and very minute particles are agglomerated into a pill which is ingurgitated by the pharynx. J. A. T.

Light-production in *Cypridina hilgendorfi*.—E. NEWTON HARVEY (*Year-book, Carnegie Inst. Washington*, 1918, **17**, 154-7). In previous papers the author described the substances photophelein and photogenin, which must be present with water and oxygen to produce light (bright blue luminescence in *Cypridina*). But photophelein includes two substances. There is a luciferin, analogous to that in *Pholas dactylus*; it is dialyzable and thermostable, and in presence of non-dialyzing and thermolabile luciferase (photogenin) oxidizes with light-production. There is, secondly, another substance, photophelein proper, which occurs in many non-luminous animals, but in *Cypridina* assists in promoting the luciferin-luciferase reaction. Oxyluciferin formed by oxidation is readily reduced to luciferin again, which will again give light. The reduction may be effected by reductases of muscle, liver, etc., or by bacteria, or in other ways. Luciferin and oxyluciferin seem to have identical chemical properties. They may be provisionally placed in a new group of natural proteins on the borderland between the proteoses and the peptones. Luciferase is a protein, and all its properties agree with those of the albumens. J. A. T.

Upper Cambrian Ostracods.—FREDERICK CHAPMAN (*Proc. Roy. Soc. Victoria*, 1918, **31**, 108-12, 1 pl.). From the Upper Cambrian Limestone of South Australia a number of fossils were obtained—namely, *Leperditia tatei* sp. n., *L. capsella* sp. n., and *Isophilina sweeti* sp. n. It is a striking fact with regard to the two species of *Leperditia* that they represent Southern Hemisphere forms of two distinct types of the genus, both of which are found in Canada. J. A. T.

Annulata.

Taste in Leeches.—L. LOHNER (*Arch. f. Ges. Physiol.*, 1916, 163, 239-46). A piece of skin folded into a funnel was filled with various fluids (salt, sweet, acid, alkaline, etc.), and the leeches sucked the outer surface. At a certain degree of concentration the leeches cease to suck and let go. This fact was utilized to determine when a leech discriminated between one kind of fluid and another. The limit was 7 p.c. for common salt, 5 p.c. for cane-sugar, 0.08-1 p.c. for sulphate of quinine, 0.08-0.09 p.c. for caustic potash, and so on. When two liquids different in taste were mixed the gustatory sensitiveness was lessened, as in man.

J. A. T.

Platyhelminthes.

Action of Potassium Cyanide in Planaria.—L. H. HYMAN (*Amer. Journ. Physiology*, 1919, 48, 340-71). The general view is that cyanides depress physiological processes in general, and the rate of oxygen consumption in particular. The author has made a large number of experiments on *Planaria*, which prove that its oxygen consumption is decreased in the presence of potassium cyanide. The amount of decrease ranges from 80-90 p.c. in 1/2000 mol. KCN to 5-15 p.c. in 1/200,000 mol. solution. The decrease is independent of muscular or ciliary activity. It is entirely reversible, the animals being wholly uninjured by the cyanide and returning to their normal rate of consumption when the cyanide is washed out of them. Cyanide is a general protoplasmic depressant.

J. A. T.

Effects of Cyanides on Planaria dorotocephala.—C. M. CHILD (*Amer. Journ. Physiol.*, 1919, 48, 372-95). Exposure to potassium cyanide in concentrations ranging from $m/500$ to $m/25,000$, and for periods from $\frac{1}{2}$ to $61\frac{1}{2}$ hours, decreases the CO_2 production in this Planarian. If the exposure is not too long, gradual recovery in CO_2 production occurs, apparently with a supernormal stage near the end of the recovery period. Susceptibility to lack of oxygen in *Planaria* shows in general the same regional and individual differences as susceptibility to cyanides and other toxic agents. KCN increases susceptibility to lack of oxygen, i.e. an animal which has been in cyanide dies earlier from lack of oxygen than a normal control animal. Since cyanides decrease both oxygen consumption and CO_2 production in *Planaria*, the increase by cyanide in susceptibility to lack of oxygen can mean only that cyanide and lack of oxygen are to some extent additive in their action on living protoplasm, i.e. their action must be in certain respects identical or similar in character.

J. A. T.

Japanese Polyclads.—M. YERI and T. KABURAKI (*Journ. Coll. Sci. Univ. Tokyo*, 1918, 39, 1-54, 2 pls., 48 figs.). Very little has hitherto been known of the Polyclad Turbellarian fauna of the Japanese coasts. The authors' studies have revealed 26 species, of which 17 seem to be new. These belong to 14 genera, of which *Neoplanocera* and *Pseudostylochus* are new. Numerous figures are given of the eyespots and the gonads.

J. A. T.

Echinoderma.

Hybridization Experiments with Sea-Urchins.—O. KOEHLER (*Zeitschr. induktiv. Vererbungslehre*, 1916, **15**, 1-163, 177-295, 7 figs.). Description of variations of the four-armed pluteus larva which results from crossing *Strongylocentrotus lividus* ♂ and *Sphærechinus granularis* ♀. The characters may be mainly maternal, or mainly paternal, or intermediate. The difference of result depends partly on temperature, which inhibits the primordia of one parent or the other. Another factor is the age of the gametes, the "transmitting power" diminishing after a certain degree of ripeness. The characters which find expression in the larva will depend on the relative age of the two gametes at fertilization. J. A. T.

Cœlentera.

Is there a Metabolic Gradient in Tubularia?—MARIO GARCIA-BANUS (*Journ. Exper. Zool.*, 1918, **26**, 265-73). According to C. M. Child an excised piece of the stem of *Tubularia* regenerates a new hydranth at the oral end the more rapidly the nearer this end lies to the original apex of the stem. He assumed that this regional difference in the rate of regeneration is due to a difference in "metabolic rates," i.e. to the existence of a metabolic gradient. But the differences in the time of regeneration observed by Child were so small that they seemed to lie within the limits of error of such experiments. The author repeated Child's experiments and found that the rate of regeneration of the oral hydranth of an apical piece is on the average identical with the rate of regeneration of the oral hydranth of the basal piece. There is no evidence of the existence of level or regional differentiation of the rate of regeneration in the stem of this hydroid, and no basis, therefore, on this line for the theory of axial gradient in this species. J. A. T.

Asexual Multiplication and Regeneration in Sagartia lucia.—DONALD WALTON DAVIS (*Journ. Exper. Zool.*, 1919, **28**, 161-263, 10 pl.). This anemone is typically Hexactinian in form and structure, except for the wide variation in the number of siphonoglyphs (1 to 5) and complete mesenteries (5 to 12). Asexual reproduction occurs by a process of aboral-oral fission with subsequent regeneration, which is described in detail. The resulting pieces may possess one or more siphonoglyphs and associated pairs of directive mesenteries, or they may lack these until regeneration has occurred. Another division may occur before regeneration is complete. The plane of fission is strictly vertical, rarely cutting a mesentery. There is no tendency to strict equality of the products of a division. Division tends to occur in endocoels rather than exocoels, in complete endocoels rather than in incomplete endocoels, and in non-directive rather than in directive complete endocoels. Regeneration processes begin with the rolling in and fusion of the torn edges of the body-wall. In the region of fusion new structures are gradually differentiated, eventually constituting a large proportion of the new individual. The torn edges of the œsophagus also grow together, and a new siphonoglyph is always differentiated

in the region of fusion of these edges. The regenerative development of mesenteries is described in detail. The development of the fertilized ovum has not been followed. The failure to obtain developmental stages, together with the abundance of stages in asexual reproduction, may mean that the latter constitutes the chief means of maintaining or rapidly increasing the population of a given region. J. A. T.

Dorsal Mesenteric Filaments of Siphonozooids of Pennatulacea.—CONSTANCE M. LIGHTBOWN (*Manchester Memoirs*, 1916, 62, No. 4, 1-20, 1 pl.). Mesenteric filaments (dorsal) are present in the genera examined, except in *Renilla*, throughout the siphonozooids of the more primitive genera—that is, in those genera where autozooids and siphonozooids occur together on the rachis, or where the autozooids are arranged on very primitive leaves. The dorsal mesenteric filaments have an exhalant function. In *Renilla* there is a special exhalant zooid, and in the higher genera the mesenteric filaments are similarly supplanted by special zooids. In some cases—e.g. *Pennatula grandis* and *Pteroeides pellucidum*—there are special zooids (Hickson's "mesozooids") and also filaments in the siphonozooids. Throughout the order it may be stated that generally the mesenteric filaments are present in the more fleshy species and absent in the slender forms. J. A. T.

Note on *Cavernularia lütkenii*.—J. STUART THOMSON (*Manchester Memoirs*, 1917, 62, No. 7, 1-5, 2 pls., 1 fig.). Some descriptive notes on this species and a record of its occurrence in the seas of Natal. It has been previously recorded farther north in the Indian Ocean, and it is well known that the coast of Natal is washed by a warm current from the Indian Ocean. J. A. T.

Nerve-Conduction in Jellyfish.—ALFRED GOLDSBOROUGH MAYER (*Carnegie Institution, Washington*, 1917, No. 251, 1-20, 14 figs.). Experiments on *Cassiopea xanachana* show that nerve-conduction is due to a chemical reaction involving the cations of sodium, calcium, and potassium. Magnesium is non-essential. "The probably high temperature coefficient of ionization of this ion proteid may account in some measure for the high temperature coefficient of the rate of nerve-conduction, which I find is 2.5 times as great as that of the electrical conductivity of the sea-water surrounding the nerve." "Contrary to Lillie's hypothesis, we have direct evidence that the rate of nerve-conduction may be independent of the electrical conductivity of the electrolytic solution surrounding the nerves." J. A. T.

Swarms of Fresh-water Medusoids.—HARRISON GARMAN (*Science*, 1916, 858). Millions of fresh-water medusoids appeared suddenly in a Kentucky creek, not far from Lexington. They appear to be referable to *Caraspedacusta sowerbyi*, which was first reported from the Botanic Gardens in Regent's Park. The hydroid phase was not found in the Kentucky creek. J. A. T.

Protozoa.

Life-cycle of *Diffugia*.—A. GOETTE (*Arch. Protistenkunde*, 1916, **37**, 93-138, 3 pls.). In *Diffugia lobostoma* nucleated amœboid "spores" arise from chromidia. There result asexual macro-amœbæ and conjugating micro-amœbæ. The latter grow into individuals which may exhibit either plastogamy or conjugation. In plastogamy, said to be due to hunger, a depressed individual fuses with a better-nourished individual and renews its energy. Conjugation has been attributed to a "chromatin-hunger" which leads one individual to attack another and absorb its contents, notably its chromatin. But in the micro-amœbæ the nuclei do not suffer depression, so that their conjugation cannot be due to chromatin-hunger. There must be a qualitative difference between the nuclei of the conjugates, a sort of "sex-hunger." J. A. T.

Feeding in Sun Animalcule.—MARIA SONDHEIM (*Arch. Protistenkunde*, 1916, **36**, 52-65, 2 pls.). When a victim touches the pseudopodia of *Actinophrys sol* their protoplasm coalesces round about it. This seems to be a signal for division of the nucleus. If another victim is captured a new division occurs, and thus colonies arise. When the booty is of relatively large size, such as *Paramecium*, which is captured in a big vacuole, there is a multiple division round the vacuole. Reproduction follows as the result of a meal. J. A. T.

Buccal Amœbæ.—J. MENDEL (*Ann. Inst. Pasteur*, 1916, **30**, 286-97). The presence of amœboid organisms in the mouth of a man is frequent, and is not by any means exclusively connected with alveolar pyorrhœa. J. A. T.

New Amœba.—A. PASCHER (*Arch. Protistenkunde*, 1916, **26**, 117-36, 1 pl., 4 figs.). A new marine Amœba, *Dinamœba varians*, forms plano-convex cysts in which it divides into 4-8 zoospores like *Gymnodinium*, but with less marked grooves and apparently without a longitudinal flagellum. The spores become amœboid in a few minutes. Perhaps we have here to do with a Flagellate secondarily adapted to a holozoic life. J. A. T.

***Pyxidicula operculata*.**—F. DOFLEIN (*Zool. Jahrb., Abt. Anat. Biol.*, 1916, **39**; *Année Biol.*, 1918, **21**, 261-2). This is one of the Thecamœbæ, with a shell impregnated with mineral particles, in shape like a broad hat. In multiplication half of the individual emerges in the form of a regular hemisphere, makes a new shell on its surface, and separates after nuclear division. The food consists of algæ and diatoms, but a diet of bacteria results in a modification race. The shell loses colour and becomes thin, so that the modification-form seems naked. It divides rapidly and the size decreases. The axis of nuclear division becomes longitudinal instead of transverse, and an explanation of this is offered. As to the normal structure, there are no chromidia, the nucleus has a large karyosome and no centriole, there are no true chromosomes, the nuclear division is a true promitosis. J. A. T.

Nuclei of Uroleptus mobilis.—GARY N. CALKINS (*Journ. Exper. Zool.*, 1919, **27**, 293–357, 95 figs.). This Hypotrichous Ciliate has eight macronuclei. In preparation for division of the unit they fuse into one. Prior to the division of the unit this divides twice; after division of the unit each of the four divides again so that eight result. The divisions are amitotic. The micronuclei vary in number from two to six; they do not fuse in preparation for cell-division, but the number is reduced to two, probably by absorption. With cell-division the two nuclei divide. One of the four may degenerate, or all may divide. In the latter case two degenerate while six divide to form twelve, six for each daughter-cell. Of these six, one or two may degenerate. Divisions are always mitotic, with eight single or partially fused chromosomes. Whether the chromosome division is transverse or longitudinal could not be determined.

Pædogamous conjugation lasts from twenty-eight to thirty-six hours; the macronuclei are retained, but degenerate and are absorbed. Four micronuclei is the usual number in conjugants. All or some form first maturation spindles. The prophase stage for these is a characteristic nucleus, termed the parachute nucleus, with an intranuclear division centre. The second maturation-spindles are usually two in number, each with eight chromosomes arranged in four pairs. Division separates the members of each pair, resulting in reduction in the chromosomes from eight to four. All the four may undergo the third division, or one or two may degenerate. Fusion of pronuclei begins while in the vesicular state; before fusion is complete the pronuclei assume a spindle form, which becomes the first division-spindle, with eight chromosomes. The first two nuclei divide again; one gives rise to the functional micronuclei, the other to one micronucleus which degenerates and to one which form the new macronucleus. The conjugants separate at this stage.

J. A. T.

Influence of Blood-serum on Colpidium colpoda.—SOPHIE PECKER (*Pflüger's Arch. Ges. Physiol*, 1916, **163**, 101–46, 1 pl., 39 figs.). The most striking effect is a deformation of the cysts of this Ciliate Infusorian when they are brought into contact with blood-serum. They take the form of capsules enclosing one spore or several spores. There seems to be a plasmolytic action on the part of the serum.

J. A. T.

Races of Colpidium colpoda.—S. V. PROWAZEK (*Arch. f. Protistenkunde*, 1916, **36**, 72–80, 14 figs.). There seems to be a great delicacy after conjugation. There is much individual inequality in resisting-power to poisons. Modification-differences may be induced, but they do not persist for more than a limited time. Some of the differences previously regarded as mutations behave more like modifications.

J. A. T.

Amœboid Variations in Flagellates.—A. PASCHER (*Archiv. Protistenkunde*, 1916; **26**, 8–116, 3 pls., 14 figs.). Some Flagellates readily become stationary and holophytic, but some may become amœboid. This is very marked in some which lose their flagella and zoospores. The author describes *Heterolagynion* Pascher, which recalls a Rhizopod,

but has the leucosine characteristic of Chrysomonads. In *Rhizaster* there are specialized pseudopodia, but the chromatophores and the cyst are indicative of Chrysomonads. The variations accord well with Patrick Geddes's old theory of the cell-cycle, which formulated the tendency of cells and unicellular organisms to pass from phase to phase—encysted, flagellate, amœboid, and, it may be, plasmodial. J. A. T.

Orientation in Volvox and Pandorina.—S. O. MAST (*Journ. Exper. Zool.*, 1919, **27**, 367–90, 2 figs.). Both these colonies orient fairly precisely, and both may be either negative or positive. Dark-adapted colonies are usually positive in weak and negative in strong illumination, never the opposite. Light-adapted colonies are sometimes positive in strong and negative in weak illumination. If dark-adapted colonies are exposed to continuous illumination they are neutral for a short time, then positive passing through a maximum, then neutral again, then negative passing through a maximum, then neutral, and finally positive again. In this state they remain. The reversion observed is dependent on the time of exposure and the intensity of illumination; it is not primarily dependent on photosynthesis; the green and blue rays are most potent in producing it. Increase in temperature causes negative specimens to become positive, and decrease causes the opposite, but neither the degree nor the extent of change in temperature is specific in its effect. The same is true in regard to some chemicals. The state of orientation is dependent upon the physiological state, including age, of the colonies as well as upon the constitution of the culture medium. Reversion in orientation is probably associated with changes in permeability, positive orientation being associated with an increase and negative orientation with a decrease in permeability. J. A. T.

Pseudopodial Network for Food-Catching in a Chrysomonad.—A. PASCHER (*Arch. Protistenkunde*, 1916, **37**, 15–30, 1 pl.). Amœboid individuals of a new type of Chrysomonad (*Chrysarachnium* g.n.) are united by a network of very fine pseudopodia, lying in one plane. This forms a web which captures food. Minute victims are immobilized when they come in contact with the web. Fresh pseudopodia envelop the prey, which is then digested. J. A. T.

Crossing of Two Species of Chlamydomonas.—A. PASCHER (*Ber. Deutsch. Botan. Ges.*, 1916, **34**, 228–46). Gametes of two species were seen to conjugate; the zygotes showed intermediate characters; they did not develop as readily as usual. Five heterozygotes were followed to the formation of zoospores, which were four in number, as in the parent species. In four cases two of the four zoospores were like the one species, and two like the other. In other cultures, however, only intermediate forms occurred. In others, one parental form occurred and rather unhealthy intermediates. J. A. T.

Beatricea not a Gigantic Foraminifer.—Charles Schuchert deals with the nomenclature and standing of this fossil organism, which was originally described as a cephalopod (*Aulaverra*) in 1843. In 1857 Billings described the same thing as a marine alga (*Beatricea*), though

other authors considered the specimens to be rugose corals. In 1865 Hyatt identified *Beatricea* as a cephalopod, but in 1885 he recanted and transferred the organism to the Foraminifera. Hyatt recorded specimens reaching a length of 20 feet and a diameter of 8.5 inches, and these measurements alone are sufficient to show that Hyatt's decision cannot be accepted. The organism has since been classed by Nicholson (in 1886), and by Parks, in the order Stromatoporidæ of the Hydrozoa, under the family Labechiidae. (See Sherborn's observations on the organism in his Index of the Foraminifera, Pt. I., 1893, p. 17.)

H.-A. & E.

Fossil Foraminifera of the Canal Zone, Panama.—Bulletin No. 113 of the Smithsonian Institution (1918-19) is devoted to "Contributions to the Geology and Palæontology of the Canal Zone, Panama, and Geologically Related Areas in Central America and the West Indies." Of this exhaustive "variorum" volume, pp. 45-87 (and plates 19-33) are devoted by Dr. J. A. Cushman to a study of the smaller, and pp. 89-102 (and plates 34-45) to the larger Foraminifera of the Panama Canal Zone. The material was collected by Messrs. D. F. Macdonald and T. Wayland Vaughan (the former being sometime Geologist to the Canal Commission), who contribute to the Bulletin respectively papers on "The Sedimentary Formations of the Panama Canal Zone, with Special Reference to the Stratigraphical Relations of the Fossiliferous Beds" (pp. 525-45 and 2 plates), and on "The Biological Character and Geologic Correlation of the Sedimentary Formations of Panama in their Relation to the Geologic History of Central America and the West Indies" (pp. 547-612). The papers must be considered together, as the stratigraphy of the beds is worked out principally by reference to the contained Foraminifera, especially with regard to the Orbitoids and Nummulites. The formations are Eocene, Oligocene, Miocene, and Pliocene, the Pleistocene being represented by swamp deposits, river gravels, old sea beaches, and recent deposits, and the two latter papers under consideration are illustrated by admirable charts, maps, sections and tables.

Mr. Macdonald's paper consists of a description of the beds in stratigraphical order, Mr. Vaughan dealing in more detail with their biological character, giving lists of the contained fossils, prominence being given to the Foraminifera as worked out by Dr. Cushman, upon which he founds principally the correlation of the beds. Both papers are largely based upon the two former papers by Dr. Cushman.

The paper on the smaller Foraminifera is the outcome of painstaking systematic work, and is excellently illustrated, material from seventeen stations having been examined, and seventy-two species being recorded, of which fourteen are described as new to science. Though the separation from their allied types is not always, in our opinion, fully justified, among these may be noted an interesting *Chrysalidina pulchella*, *Nonionina anomalina*, and *Triloculina projecta*, though as these appear to be described upon the strength of a single specimen we should prefer to regard them as abnormal varieties.

The paper on the larger Foraminifera is largely devoted to the genus

Lepidocyclina, including a new sub-genus, *Multicyclina*. It also includes the genera *Orthophragmina*, *Nummulites*, and *Orbitolites*, and a new genus, *Heterosteginoïdes*. Several new species are described. There can be no doubt as to the value of these larger forms as Zone fossils, but in our opinion the constant multiplication of species in these genera is to be deplored. Like the *Nummulites* they are fast becoming a highly over-specialized branch of Micro-palæontology.

H.-A. & E.

Miscellanea.

The Rounding of Grains of Sand by Solution.—J. J. Galloway contributes to the American Journal of Science (Ser. 4, vol. xlvii, 1919, pp. 270–80) a very interesting paper upon this subject. He is aware of the experiments of Daubr e in this connexion, and the results of his own experiments—i.e. that it requires 800 hours of rolling in water at four miles an hour to produce a round from an angular grain of sand—are practically identical with those of Daubr e, who put it at 3000 miles. The author is, however, of opinion that rounded sand-grains are not, as has been generally accepted, necessarily aeolian, but, below a certain diameter, which he puts at 0.1 mm., are produced by solution. He seeks to prove this by experiments with various minerals in alkaline and acid solutions, but his experiments with quartz-sand do not appear to us to be so conclusive. He says himself, “Quartz can be dissolved in a few hours in hot water under pressure. The temperature and pressure of water in which sands are accumulated, however, are not high enough to be important factors in solution.” But his observations seem to throw light upon the highly polished or frosted spherules of silica with which one is familiar in examining dredgings from considerable depths. And the solution theory may help to explain the disappearance of flint which forms so large a constituent of the shore sand in some localities, but is absent from dredgings but a short distance away. His conclusion is that while a sand consisting wholly of well-rounded grains many of which are less than 0.1 mm. in diameter is aeolian, the presence of a small percentage of minute round grains points rather to water-action and solution.

H.-A. & E.

BOTANY.

GENERAL,

Including the Anatomy and Physiology of Seed Plants.

Structure and Development.

Vegetative.

Leaf-Anatomy of *Scævola crassifolia*, with Special Reference to the Epidermal Secretion.—MARJORIE J. COLLINS (*Proc. Linn. Soc. New South Wales*, 1918, **43**, 247-59, 2 pls.). This plant (a member of the family Goodeniaceæ) forms a pronounced element in the sand-dune flora near Adelaide. It is a low-spreading shrub, the older woolly stems of which form a dense undergrowth in which blown sand and dried leaves of *Posidonia* accumulate, thus helping to build up the dunes. The buds and young leaves bear peltate glandular hairs which secrete a sticky resin in great quantity. As the leaves become older the glands become less active, the secretion loses its mobility, dries up and gives the surface of the leaf a lacquered appearance. The mature leaves are thick and succulent; the glands are sunken and no longer functional on the blade of the leaf, retaining their activity only in the region of the leaf-base and protecting the axillary buds. The mature leaves show special xerophilous adaptations in the secondary increase in size of the epidermal cells, the massive development of palisade tissue, the development of special water-storage cells, such as mucilage-cells, water-storage tracheides, and ordinary thin-walled water-storage cells. A protection from intense illumination is suggested by the yellow colour of the secretion. A. B. R.

Storied or Tier-like Structure of certain Dicotyledonous Woods.—S. J. RECORD (*Bull. Torr. Bot. Club*, 1919, **46**, 253). A considerable number of dicotyledonous woods, representing a wide range of families, are characterized by a storied or tier-like arrangement of part or all of the elements. The writer has investigated all of the woods in the extensive collection of the Yale School of Forestry. The structure is shown on longitudinal sections, typically the tangential, as fine transverse striations, "ripple-marks," which are often visible without a lens. These ripple-marks are constant enough in stems of considerable thickness to serve as a valuable diagnostic feature. In some woods pit-areas on the fibres are in seriation; and in some instances, also, the cells of the wood-parenchyma strands are arranged in a secondary seriation, visible under a lens. The writer appends a table giving for each wood the various elements storied, the uniformity and distinctness of the markings, and the height of the tiers. The storied structure is found also in the secondary phloem. A. B. R.

Technology and Anatomy of some Silky Oak Timbers.—R. T. BAKER (*Journ. and Proc. Royal Soc. N.S. Wales*, 52, 362, 13 pls.). The name Silky Oak is applied in the Australian timber-trade to a variety of timbers, each having a distinct specific origin, but all possessing one common character—namely, very pronounced rays, or in trade terms a large silver grain—and all differing in colour, weight, hardness, and anatomical structure. They all belong to the same family—Proteaceæ. The preponderance of the rays in the wood appears to break up the usual uniformity of concentricity of annual rings into arcs on a transverse section. The ray feature is so characteristic of the Proteaceæ that it differentiates it from all other families except the Casuarinaceæ. Baker has made a careful histological study of five species—namely, *Grevillea robusta*, *G. Hilliana*, *Embothrium Wickhami*, *Cardwellia sublimis*, and *Orites excelsa*. The characteristic features of each species are shown in macroscopical and microscopical illustrations. The transverse sections show the rays dividing the other wood-elements into segments, which have their concavity outwards, towards the bark, an arrangement which is found to obtain in all genera of Proteaceæ except *Persoonia*. In no other family was this found in any timbers examined. The small globular bodies found in the wood-elements of the several species is a unique feature; and the arrangement of the fibres and wood-parenchyma affords characters for specific determination.

A. B. R.

Mahogany and the Recognition of Some of the Different Kinds by their Microscopic Characters.—HENRY H. DIXON (*Scientific Proc. Royal Dublin Society*, 1918, 15, 431–86, pls. 22–44). The mahogany of commerce is derived from many different genera and species of trees. A recent list included sixty-seven species as supplying timbers the characteristics of which sufficiently coincide with the popular idea of mahogany to be marketed as that wood. The present writer has examined about forty species, of which he gives descriptions and microphotographic illustrations in the hope that they may serve as means of identification. The name was originally applied to the timber of the West Indian species, *Svietenia mahagoni*, and possibly also of the Honduras species, *S. macrophylla*; but it is uncertain if any of the timbers now on the market come from *S. mahagoni*. Dixon therefore defines as mahogany all red or red-brown timbers in which the fibres of the adjacent layers cross each other obliquely, and so give rise to a play of light and shade on longitudinal surfaces. In addition a mahogany should have scattered vessels, isolated or in small mostly radial groups; the parenchyma round the vessels should be narrow and inconspicuous, while the medullary rays are on the average well under 2 mm. in height and not more than nine cells thick. In other respects the woods classed as mahoganies have very varied properties. A key is given for the determination of the species by histological characters. This is followed by descriptions of the elements of the wood as seen in cross, transverse and radial sections, each of which is illustrated by microphotography. The woods are grouped geographically as Western, African, Asiatic and Australian. The majority of them belong to the same family as *Svietenia*, Meliaceæ; but Leguminosæ supply several kinds, and Dipterocarpaceæ, Burseraceæ, Urticaceæ, and other families are represented.

A. B. R.

Reproductive.

Embryo-sac and Embryo of *Penstemon secundiflorus*.—ARTHUR EVANS (*Bot. Gaz.*, 1919, 67, 427-37, 1 pl.). The author recapitulates the results of previous work on genera of Scrophulariaceæ, and refers to the fact that it was in members of this family that the development of the embryo-sac and the embryo were first correctly studied, Hofmeister in 1851 demonstrating in *Lathræa* and *Pedicularis* that the embryo was formed as the result of the fertilization of the egg, and not from the end of the pollen-tube, as was believed by Schleiden and his followers to be the case. The author finds that in this species the embryo-sac is developed from a single megaspore. The antipodal cells disorganize early; the micropylar end becomes bulbous, while the chalazal end becomes long and narrow, and is covered with a distinct tapetum. The mature embryo-sac is found to be constantly gorged with starch due to the non-utilization of the nutritive materials which pass into the sac at a time of inactivity just before fertilization. Several cases of double fertilization were observed. Without resting after the fusion with the sperm the endosperm nucleus divides, and free nuclei migrate into the chalazal end of the sac where wall-formation begins. The pro-embryo is pushed into this endosperm by an extreme growth of the suspensor. The micropylar end of the sac disintegrates. Two haustoria are formed, the micropylar by the growth of endosperm cells from the chalazal end into the micropylar end, and the chalazal by a growth of endosperm cells from the chalazal end out into the vascular system. False polyembryony caused by fusion of two ovules seems to be quite common in this species. A. B. R.

Observations on the Morphology of *Larix leptolepis*.—JOSEPH DOYLE (*Scientific Proc. Royal Dublin Society*, 15, 1918, 310-30, 2 pls.). The author has studied the structure and development of the reproductive organs of this species—namely, the male and female strobilus and gametophytes. There are very definite sacs in the microsporophyll apex, especially in the bud; these paired cavities are apparently homologous with the paired canals of the vegetative leaf, and not with abortive sporangia. The normal pollen-grain is large and without wings; the stalk and generative nucleus is already formed when it is shed; two marked cellulose walls bound the prothallial cells, and the vestiges of a wall surrounds the generative nucleus. The development of the grain is very similar to the irregular pollen-grain development in *Picea canadensis*. In wingless pollen and in the possession of marked apical cavities in the microsporophyll, especially in the bud, *Larix* agrees with *Pseudotsuga*, and these two genera are in marked contrast to the other genera of Abietinæ. The author also deals with some points in the anatomy of the female strobilus and gametophyte. There is a gradual transition from basal vegetative leaves to cone-bracts, as in *Pseudotsuga*, and the micropylar pollen-receiving device is similar to what obtains in that genus. The female gametophyte develops as in other Abietinæ, but the megaspore membrane, very thick below, fades over the top; there are five long archegonia; the neck-cells are in one or two layers of four to eight cells. It is very similar to the female

gametophyte of *Pseudotsuga*, but, in contradistinction to this genus, only those pollen-grains which reach the nucellus develop pollen-tubes. Fertilization is normal, but the relative sizes of the two male nuclei were not determined. The pro-embryo is of the Abietinean type, and one embryo is the rule. The author concludes that there is a distinct natural affinity between *Larix* and *Pseudotsuga*. A. B. R.

General.

Fossil Higher Plants from the Canal Zone.—ED. W. BERRY (*U.S. National Museum, Bulletin 103, 1918, 15-44, 7 pls.*). The author describes seventeen species of plants, nearly all of which are new, from the Oligocene series of Panama. The plants include ill-defined fragments of one fern, two undetermined species of palm represented by fragments of foliage, and a third represented by petrified stems; and sixteen Dicotyledons, two of which are represented by fruits and the remainder by leaves. The Dicotyledons represent fourteen families, which are also characteristic of the existing flora of the Isthmian region. The Tertiary plants indicate an abundant rainfall and relatively high equable temperatures, such as prevail at the present time in the hill country and coastal plain of the Isthmus. There is no indication of upland vegetation or any trace of the characteristic vegetation of low muddy shores. The bulk of the fossil plants clearly belong to the ever-green rain-forests, and have the appearance of having been washed into the basins of sedimentation by streams. A. B. R.

Grasses of Illinois.—EDNA MOSHER (*University of Illinois, Agricultural Experimental Station, Bulletin 205, 261-425, 287 figs.*). A useful working monograph of all the grasses which have been recorded for the State of Illinois based on a thorough examination of earlier records and available herbarium material. Mosher admits 204 species, over one-fifth of which are now recorded for the first time as occurring in the State. A brief account of the general structure of grasses is followed by an elaborate key to the genera. Adequate descriptions are given of the genera and species, and where the genus contains more than one species keys are included as aids to determination; the illustrations are numerous and helpful. The arrangement of the genera follows that of Gray's "Manual of the North American Flora"; the species follow alphabetically under each genus. A. B. R.

Regional Spread of Moisture in the Wood of Trees.—WM. G. CRAIB (*Notes from Royal Botan. Gard. Edinburgh, 1918, 11, 1-18, 10 pls.*). In the present communication the author deals with deciduous-leaved trees during the period late autumn to early spring. Working with specimens of sycamore (*Acer Pseudoplatanus*) which were felled and examined at several periods between October and March, the following facts and conclusions are formulated. With the cessation of foliar activity for the season, the tree immediately begins its preparations for the next season. The first phase is the storing up in the centre

of the trunk of a large supply of moisture, beginning at the bottom of the trunk. By the time that the centre has reached its quota of stored moisture far up the trunk another movement has begun causing a re-arrangement of the moisture at the base. As the result of the water moving inwards from the outer zones, beginning at the base of the trunk, there is created an area of maximum moisture-content in a transverse plane at the centre of the trunk. This inward current, and the consequent plane of maximum moisture-content at the centre, gradually extends upwards in the trunk to the topmost region, but before this is reached a radial movement has begun at the bottom of the trunk which likewise progresses upwards, and the region of maximum content passes almost to the outside of the trunk, leaving the centre as the driest region. The movements upwards and radial, both inwards and outwards, are going on at one and the same time at different levels in the trunk. The writer discusses these results in their relation to the best time for felling trees. The paper is illustrated by five coloured plates showing diagrammatically the average moisture distribution in the transverse section of a bole at the different periods, and by a similar number of graphs indicating moisture distribution throughout the trunk.

A. B. R.

CRYPTOGAMS.

Pteridophyta.

Australian Specimen of Clepsydropsis.—B. SAHNI (*Annals of Botany*, 1919, 33, 81–92, 1 pl., 2 figs). A description of a *Clepsydropsis* from Carboniferous rocks in New South Wales. As in *C. antiqua* of Unger, the leaf-trace arose as a close ring of xylem which became tangentially flattened, and then became clepsydroid as the result of a median constriction. In *Ankyropteris* also the leaf-trace origin is essentially the same. Hence the two genera should be united, as had previously been suggested. The two groups of the Zygopterideæ (*Clepsydroidæ* and *Dinenoideæ*) were also sharply distinct in the symmetry of their stem, which was radial in the former, dorsiventral in the latter. The apparently radial symmetry of the basal region of the leaf in the *Dinenoideæ* (due to early bifurcation of the pinna-trace) may have been associated with a strictly upright position; but it was not continued into the probably more or less horizontal laminated distal part of the leaf.

A. G.

Sporangiophoric Lepidophyte from the Carboniferous.—HARVEY BASSLER (*Botanical Gazette*, 1919, 68, 73–108, 3 pls.). An account of the fossil genus *Cantheliophorus* created to include a group of plant-impressions of sporophylls, etc. The distinctive feature of the group is a large lamellar sporangiophore developed in the radial plane of the strobilus from the superior (ventral) face of the sporophyll pedicel, bearing two large elongate sporangia, one upon each side, pannier-like.

The generic characters are discussed in detail; the systematic position of the genus is considered, and the phyletic relations are treated at some length, followed by a technical discussion of the eleven species, seven of which are new to science. The genus has a wide geological range in North America. A. G.

Archeporial and Meiotic Mitoses of *Osmunda*.—L. DIGBY (*Annals of Botany*, 1919, **33**, 135-72, 5 pls. and fig.). A fully illustrated account of cytological investigations of various species of *Osmunda*. The summary of the results is far too long for citation; but the chief results are given as follows:—(1) It is shown that telophasic events have an important bearing on the interpretation of the succeeding prophase. (2) That the sequence of events in prophase can only be interpreted in the light of the preceding telophase. (3) The above-mentioned facts have been found to be of fundamental importance in elucidating the early stages of the heterotype division. (4) In the heterotype division the prophasic stages, ordinarily included under "synapsis," do not consist in the lateral conjunction of *two entire* somatic chromosomes, but in the lateral re-association of the *threads* in pairs which together make a *single entire* somatic chromosome. (5) Conjunction in pairs of *entire* somatic chromosomes occurs in the stages leading up to, and is finally consummated during, second contraction. A. G.

Study of Apogamy in *Nephrodium hirtipes* Hook.—W. N. STELL (*Annals of Botany*, 1919, **33**, 109-32, 3 pls.). A résumé of previous work on apogamy, and an account of the author's own observations, summarized as follows:—(1) The prothallium of *Nephrodium hirtipes* arises from the germination of a spore. (2) The gametophyte never produces archegonia; but antheridia are formed which develop apparently normal antherozoids. (3) The development of secondary prothallia is readily induced by culture. (4) Attempts to induce an aposporous gametophyte development have rarely been a success. (5) The embryo originates at an early stage in the development of the gametophyte as a vegetative outgrowth of the prothallium. The apical cell of the leaf is first formed, then that of the root, and later that of the stem. No foot is produced. The later stages are like those of an ordinary embryo of fertilization. (6) At no time have nuclear migrations and fusions been observed to occur in the prothallium when the embryo begins its development. (7) At the stage when the sporangium contains eight sporogenous cells an incomplete nuclear and cell division occurs in each of these eight cells. As a result of the incomplete divisions, each nucleus contains the diploid number of chromosomes—between 120 and 130. The eight sporogenous cells, now diploid, function as spore mother-cells. The resulting spores are haploid, with 60-65 chromosomes, a number which is retained in the cells of the gametophyte and of the apogamously developed sporophyte. (8) Thirty-two spores are ordinarily formed in a sporangium of *Nephrodium hirtipes*. The smaller number of spores, sometimes occurring, is due to abnormalities of the nucleus of the spore mother-cell. (9) Sometimes more than thirty-two spores are produced owing to the formation of more than four spores from a single

spore mother-cell. Rarely more than eight spore mother-cells occur in a sporangium; but whether they can all form normal tetrads and spores has not yet been determined. A. G.

Duration of Prothallia of *Lastrea Filix-mas*.—R. W. PHILLIPS (*Annals of Botany*, 1919, **33**, 265–6). A description of the remarkable form assumed by a caespitose crop of prothallia, which had been put away in a covered basin, and forgotten for a period of twenty months. In the feeble illumination each prothallium had grown up vertically to a height of about 15 mm., and with a width of about 1–1.5 mm., and bore innumerable rootlets on the darker side, and bristled with characteristic mucilage cells on the edges. Further, the whole of the under surface was studded over with antheridia; but not an archegonium could be found. Some of them were transplanted to a more natural situation, and developed a natural appearance and produced young sporophytes. But the rest of the crop was left in the original position, and, though many of them gradually withered, a few retained vitality for about six years from the date of sowing the spores. A. G.

Contributions to a Knowledge of the Genus *Pteris*. II.—G. HIERONYMUS (*Hedwigia*, 1914, **55**, 325–75; see also *Bot. Centralbl.*, 1915, **128**, 173). A continuation of the author's work on *Pteris*, in which he discusses in detail the numerous species belonging to the *P. quadriaurita* group. He differs from Hooker and Luerssen, who included under this species many insufficiently described species, and he insists on an extensive division of this polymorphous species with a view to studying possible endemism. All the species of the section *Eupteris* are placed in the *P. quadriaurita* group which have pinnate fronds with more or less deeply pinnate lateral pinnae, the lowest pair (or pairs) of which are auriculate—that is, one to three of them more or less resembling the lateral pinnae, but always bearing small auriculate pinnulae. The already well-defined species recognized by the author are:—*P. quadriaurita* Retz., with var. *Wightii* Hieron. as a new variety; *P. armata* Presl., *P. flava* Goldmann, *P. glaucovirens* Goldmann, *P. argyræa* Moore, *P. aspericaulis* Wall., *P. tricolor* Linden, *P. Blumeana* Ag., *P. spinescens* Presl., and *P. asperula* J. Sm. Ten new species with varieties are described. E. S. G.

New *Schizæa* from Borneo (*S. Hallieri*).—ALADÁR RICHTER (*Mededeelingen van 's Rijks Herbarium Leiden*, 1916, No. 28, 38 pp., 5 pl.). A description of *Schizæa Hallieri*, a new species from West Borneo, formerly referred to *S. fistulosa*. The author discusses the wide distribution of *S. fistulosa* Labill., a Polynesian species extending west to Borneo and east to Chili, and constituting the main species of the group Pectinatae. He describes and figures the structure of the stele and chlorenchyma of the members of this group—*S. fistulosa*, *S. australis*, *S. robusta*, *S. malaccana*, *S. Hallieri*; also their physiological and systematic anatomy, and their sporophylls and spores. He then discusses the group from the point of view of their xerophily, and the effect which this has had upon the evolution of the species. A. G.

Bryophyta.

Studies on some East Indian Hepaticæ.—D. H. CAMPBELL (*Annals of Botany*, 1918, **32**, 319–38, 2 pls. and figs.). An account of the structure of *Dumortiera trichocephala*, *D. velutina*, *D. calcicola* (a new species from Sarawak, Borneo), and of *Wiesnerella denudata*, with special attention to the reproductive organs, the carpocephalum, the sporophyte. The most striking peculiarity of *Dumortiera*—i.e. the more or less complete obliteration of the air-chambers—is secondary and associated with the marked hygrophilous habit of most of the species. Of the species examined, *D. velutina* shows the least reduction, for not only are the outlines of the air-chambers quite evident, but the characteristic assimilative tissue is present in the form of very numerous superficial papillate cells. In *D. trichocephala*, which is more strongly hygrophilous in its habit, the reduction of the air-chambers is much more complete, and in one Hawaiian species (assumed to be *D. trichocephala*) the suppression is complete, as it is in the presumably related genus *Monoselenium*. *Wiesnerella* is especially interesting, as it is on the one hand unmistakably closely related to *Dumortiera*, while on the other it is obviously connected with the typical Marchantiaceæ. It may be fairly said to connect forms of the type of *Marchantia* with the reduced *Dumortiera*. Almost the only evidence of reduction in *Wiesnerella* is the character of the stomata, especially those of the receptacle.

A. G.

Andrœcium in *Plagiochasma appendiculatum* L. et L. and *P. articulatum* Kashyap.—S. R. KASHYAP (*New Phytologist*, 1919, **18**, 235–8, 2 figs.). Three different considerations are put forward to show that the andrœcium of *P. appendiculatum* and *P. articulatum* is really homologous with that of the higher Marchantiales in being a branch-system. The dorsal position, like the dorsal position of the female receptacle, is quite secondary, as has already been shown by the author (*Op. cit.* **13**, 9). In *P. articulatum* the andrœcium is quite terminal at first. The three considerations are:—(1) The arrangement of the scales at the tip of the lobes, very similar to that at the tip of the vegetative lobe; (2) the repeated branching of the receptacle, two or three times in some specimens; (3) the invariably acropetal succession of the antheridia in all lobes exactly as in *Marchantia*, the highest genus of the Marchantiales.

A. G.

New Moss from the Pleistocene of Kecskemet, Hungary.—K. SCHILBERSZKY (*Math. u. naturw. Ber. Ungarn.*, 1914, **2**, 167–77, 5 pl., text figs.). The moss here described was found at a depth of 35 m., on boggy land near Kecskemet, among various plant remains. The stratum belongs to the Pleistocene age. It differs from any existing species of *Hypnum*, and is called *H. Holloscianum* after the finder. Its closest allies are *H. Schreberi* and *H. cuspidatum*. Comparison is drawn between it and *H. Taramellianum*, which is also described in detail. Figures are given reproducing the habit of both these species, and the structure of *H. Holloscianum*.

E. S. G.

Genus Desmatodon in North America.—R. S. WILLIAMS (*Bull. Torrey Bot. Club*, 1919, 46, 207-20, 1 pl.). Descriptions of the genus and twelve species, with a key to the species, and figures of leaf-structure in transverse section. Half the species occur in Europe.

A. G.

Mosses of North Queensland.—V. F. BROTHERUS and W. WALTER WATTS (*Proc. Linnean Soc. New South Wales*, 1918, 43, 544-67). An examination of 158 species of mosses collected in the Cairns district, etc. The flora is more of Malayan affinity than Australian; and seventeen genera and thirty species are added to the Australian moss-flora. Also *Pterobryidium*, a new genus, is described, as well as fourteen new species.

A. G.

Moss Exchange Club.—*Twenty-fourth Annual Report, July, 1919*, 225-52; York: Waddington. A systematic list, with annotations, of the Bryophyta collected and distributed by the members of the Club. Particular attention has been paid to the forms of *Sphagnum* as defined in Warnstorf's "Sphagnologia Universalis" (1911).

A. G.

Thallophyta.

Algæ.

Building of an Autotrophic Flagellate.—A. H. CHURCH (*Botanical Memoirs*, No. 1, 1919, 27 pp.; Oxford University Press). An account of the origin and development of the simple self-supporting plankton cell in sea-water, with reference to the subsequent progression of life on this planet; for all the races of plants and animals must, as the author shows, have been derived from it. The subject is divided into a score of chapters, which treat of the ionic energy of the sea, solar radiation, photosynthesis, proteid-synthesis, growth, day and night, surface tension, contractility, differentiation of plasmatic tracts, polarity, the flagellum, binary fission, failure and death, holozoic nutrition, flagellar nutrition, origin of sexual fusion, differentiation of flagella, comparative dimensions, encystment and formation of the cell wall. Step by step the author works out his case, showing how inevitably phase has followed phase in the scheme of evolution. The memoir is a compressed summary of facts and arguments affording an outline survey of the whole subject viewed from the standpoint of the pelagic plankton.

A. G.

Phylogenesis of the Orthobiont.—CHARLES JANET (Limoges: Ducourtieux et Gout: 1916, 72 pp., 6 tables, 8 pl.). A systematized account of the evolution of sundry types of plants and animals from the primitive Flagellate. By special terminology and by the use of characterizing letters, the cell-colonies, individuals, reproductive cells, etc., are all particularized, and the homologous phases are indicated in the types selected—Flagellate, *Volvox aureus*, *Ulothrix zonata*, *Spirogyra*, *Fucus vesiculosus*, *Riccia glauca*. The life-histories are planned out in the tables and plates.

A. G.

Protozoa (Fauna Groenlandica. VIII).—T. ELLINGER (*Medd. om Groenland, Köbenhavn*, 1914, **23**, 743-51; see also *Bot. Centralbl.*, 1915, **128**, 581). A list of all the Protozoa hitherto recorded from the coasts of Greenland and surrounding seas, including Flagellates and Peridiniæ. The Flagellates are all chromatophore-bearing forms, and number sixteen, but not all of them are valid species. The Peridiniæ recorded are fifty-six, some of which are open to criticism. The paper is a compilation of scattered literature on the subject. E. S. G.

Trachelomonas inconstans: a New Flagellate.—NELLIE CARTER (*New Phytologist*, 1919, **18**, 118-19, fig.). A description of a new species of *Trachelomonas*, collected in May, 1918, with other Flagellates in a small rain-water pool at Sutton Park, in Warwickshire. The distinctive feature of the organism is the prominent nodule or spiny excrescence at the posterior end. The whole case or sheath also is strongly impregnated with iron. The living plasm is densely green, with a bright red stigma and several contractile vacuoles; and a long flagellum protrudes from the neck of the case. A. G.

Cytology of Two Species of Characiopsis.—NELLIE CARTER (*New Phytologist*, 1919, **18**, 177-86, figs.): An account of the structure of two species of *Characiopsis*—*C. Naegeli* (A. Br.) Lemm., and *C. saccata*, a new species—found on dead oak-leaves in a rain-water pool at Sutton Park, in Warwickshire. There is a remarkable difference in the internal structure of the two species, as is shown in detail by the author. They were also compared closely with *Characium angustum* and *C. Sieboldii*, with the result that the only constant differences to be noticeable between the two genera were the presence of pyrenoids and starch in *Characium*, and their entire absence from *Characiopsis*, where the food-reserve is in the form of oil. A. G.

Vertical Distribution of Plankton in the Lake of Geneva.—L. BAUDIN (*Bull. Soc. Vaudoise Sci. Nat.*, 1919, **52**, 275-316). The area investigated was a cove by the small town of Rolle, facing south; and the time occupied by the investigation was from the spring of 1913 to the autumn of 1916. Owing to initial difficulties, and later to the war, the sequence of operations was so disturbed that the results here given are mainly based on the work of December, 1915, January and March, 1916, for the winter months, and May, June and August, 1916, for the summer. Details of each period are given, illustrated by tables. As a rule, during the summer the number of individuals diminishes gradually. The author discusses in detail various facts relating to the vertical and horizontal distribution of the different groups, and finally gives the following conclusions:—(1) The use of the pump is indispensable for acquiring a clear idea of the vertical distribution of the plankton. (2) From the plankton point of view, the régime of the water in winter is essentially different from that in summer. (3) In winter the plankton is fairly uniformly distributed from the surface to the base, or at least to the point where the seasonal variations are perceptible. (4) In summer the plankton is confined to the surface

layers, and hardly descends below 40 m. Distribution is not uniform. (5) Both in summer and winter there are zones of superficial expansion, which are the optimum zones of development of the species. (6) In summer deeper maxima are established, more especially for the groups of lower organisms. They consist of floating senile or dead organisms. (7) Horizontal distribution is uniform. E. S. G.

Bacillariales.—C. H. OSTENFELD (*Résumé planktonique*, 3 partie, in *Bull. trim., etc., publié par Bur. Conseil perm. intern. pour l'explor. de la mer*; 4° Copenhagen, 1913, 403-508, 39 charts, pls. 55-93). A study of the numerous records of diatoms, enumerated in the plankton lists published by the International Co-operation for the Study of the Sea, 1902-1909. Only the true plankton forms are mentioned, omitting those of doubtful identification. Seventy-one species are recorded, together with the following details of each:—(1) General features of distribution and biology; (2) distribution within the regions investigated (occurrence, both geographical and seasonal: relations to the hydrographical conditions, i.e. temperature and salinity; anomalies in the occurrence); (3) summary, and observations still to be made. The geographical distribution of the most important forty-six species within the area investigated are given on thirty-nine quarto charts, together with the different relative quantities of each. The geographical and seasonal distribution of the marine plankton diatoms of N. W. European waters are now fairly well known; but our knowledge of the biology is still very poor, as also that of the life-cycle of all plankton diatoms. Remarks are made on systematics and nomenclature, especially with regard to *Chaetoceras*, of which twenty-five species are recorded.

E. S. G.

Schizophyceæ.—C. H. OSTENFELD (*Op. cit.*, 509-14; see also *Bot. Centralbl.*, 1915, 128, 554-5). This paper is a part of the working up of the numerous records found in the plankton lists published by the International Co-operation for the Study of the Sea, 1902-1909. The Schizophyceæ occurring in marine plankton are few and mainly restricted to tropical and subtropical waters, though one species of *Trichodesmium* reaches the mouth of the English Channel in summer. Certain brackish water plankton species are found in the Baltic, the most important being *Aphanizomenon flos-aquæ* and *Nodularia spumigena*. The former is really a fresh-water organism, but it is carried by the rivers into the Baltic and neighbouring waters. Its maximum occurs in late summer and autumn, but it is found all the year round. Resting spores are not found in the sea, and probably a new invasion from fresh-water occurs every year. *Nodularia* is a brackish water form which occurs on the bottom of slightly salt bays and inlets and is at times carried up into the plankton. It reproduces itself vegetatively in the plankton, but dies away every year, and is supplied afresh. Its distribution and time of occurrence in the Baltic are the same as that of *Aphanizomenon*. *Anabaena baltica* J. Schmidt, another brackish water organism, but of less importance, has the same biology as *Nodularia*.

E. S. G.

Observations on *Euglena deses*.—ROSE BRACHER (*Annals of Botany*, 1919, **33**, 93–108, 9 figs.). An account of the organism that lives on the banks of the Avon, and is dependent on certain external factors—light, tidal flow, and temperature. The influence of light is direct and most important. The *Euglenæ* are visible upon the mud during day-time, but burrow under the mud for the night, or when placed in artificial darkness. The influence of tidal flow is shown by the burrowing of the organism into the mud when covered by the tide; and the appearance of the organism is delayed or even prevented by a mid-morning or early afternoon high tide; also *E. deses* retains a tidal periodicity for about three days after being removed to the laboratory. The influence of temperature changes are less important, in that *E. deses* is active at any temperature between 2·5° C. and 25° C.; but beyond these limits its movements are arrested. The optimum temperature is about 15° C. Some of the figures show the shapes and positions assumed during activity, at rest, and at night. A. G.

Studies on the Chloroplasts of Desmids. I.—NELLIE CARTER (*Annals of Botany*, 1919, **33**, 215–54, 5 pls.). An account of the chloroplasts of *Netrium*, *Closterium*, *Tetmemorus*, *Euastrum*, *Xanthidium*. The general characters of the chloroplasts are summarized as follows:—In the Saccodermæ they are usually very simple in form. But in the higher Desmids they are, in general, very complicated and beautiful structures, and in many cases have not been previously investigated. Their delicacy of form depends upon (a) the relative amount of chlorophyll-bearing substance present in the individual, and (b) the general physiological condition of the cell, particularly as regards the quantity of free stroma-starch present in the chromatophore. The chloroplasts may be axile or parietal, and their general form is usually constant, but in a few cases there is marked variation in the disposition of the chloroplasts amongst individuals of one species. The number and position of the pyrenoids present depend on the size and shape of the chromatophore. In the most extensive chloroplast plates of both axile and parietal forms they are often very numerous and scattered. In all cases the amount of food stored in the form of pyrenoids is dependent on the condition of the cell, and at any time two or more pyrenoids may be formed by the division of an original one. In many forms the number of pyrenoids present in each semi-cell is generally supposed to be constant: but this is not true, since the actual number of pyrenoids present is dependent on various changing factors, but in such cases the points of pyrenoid formation are usually quite definite and fixed. In addition to the ordinary large pyrenoids which are usually provided with a starch-sheath, in several species numbers of small naked pyrenoids or granules of protein were observed in the superficial layers of the chromatophore. Summaries are also given of the special characters of the chloroplasts in the five genera investigated. A. G.

Studies on the Chloroplasts of Desmids. II.—NELLIE CARTER (*Annals of Botany*, 1919, **33**, 295–304). An account of the chloroplasts of *Micrasterias*. The summary of the results is as follows:—Normally

there is one chloroplast in each semi-cell, the different forms encountered being variations of one simple type. Always there is a more or less distinct axile plate parallel to the front faces of the semi-cell in the central position, and from this there usually arise numbers of ridges or plates which project towards the cell-wall in various directions. The relative size of axis and ridges varies with different species. The prominence of the ridges seems to depend on the thickness of the cell; in the more flattened cells of some species they are insignificant and may under certain physiological conditions be altogether absent, but in the thicker-celled species they are very large and may sometimes even be branched. The ridges in the latter case constitute by far the more important part of the chloroplast, the axis often becoming very thin and indefinite in form. With the increase in size and importance of the ridges, the pyrenoids become more restricted in number and disposition, occurring only in the more massive parts of the chloroplast. In most species a tendency was noticed for the axis of the chloroplast to become shortened in the apical lobe of the cell. This is more pronounced in the thicker-celled species, in which the chloroplast may even tend to become parietal in this region by reason of the absence of the axis. Sometimes the shortening of the axis in the median region extends through the whole length of the semi-cell, in which case two chloroplasts are present instead of one.

A. G.

List of Desmidiaceæ collected during the Summer of 1913 in the Government of Ufa.—A. J. LOBIK (*Bull. Jard. Imp. Bot. Pierre le Grand*, 1914, 14, 259-76; see also *Bot. Centralbl.*, 1915, 128, 702). Thirty-nine species were determined, some of which differed greatly from the recognized type—*Penium margaritaceum* Bréb. f. *incoloratum* Lobik; *Closterium siliqua* W. & G. S. West var. *majus* Lobik; *Euastrum binale* Ralfs f. *intermedium* Lobik; *Cosmarium Eichleri* Lobik comb. nov. f. *ufense* Lobik. The two species *Euastrum binale* Ehr. and *E. dubium* Näg. are united under *E. binale* Ehr., as intermediate forms were found which nullify the supposed distinguishing characters in size, form, and structure. A comparison of the diagnoses of *Cosmarium subbroomei* and of the var. *retusum* of Eichler and Gutwinski shows that the variety is wrongly placed under *C. subbroomei*. They differ in the form of the angles of the semi-cells, and in the outline of the lateral walls. The variety is here raised to specific rank as *C. Eichleri*, the name *retusum* having been already used for another species.

E. S. G.

Epiphyllie Ulothrix.—A. ECKLEY LECHMERE (*Naturw. Zeitschr. Forst-und Landw.*, 1915, 13, 30-30, 2 pls.; see also *Bot. Centralbl.*, 1915, 128, 702). The result of an investigation of the dark green growth frequently found covering pine-needles. It is formed of a species of *Ulothrix*, of which the author here describes the morphology, growth in nutritive solutions, and germination of the akinetospores. Germination may be either direct, or indirect by means of reproductive akinetæ or by a *Palmella* stage. No mobile spores are formed. The systematic position of the alga was difficult to establish, owing to want of unanimity among authors as to distinguishing characters—e.g. form of the chloro-

plasts. Finally, comparison with *Ulothrix crenulata* (Kütz.) Brand showed that the two were identical. Tubenf adds a note of warning against confusing the above-described algal growth with the greyish-white covering of a lichen on the pure black of the fungus *Apiosporium pinophilum*. E. S. G.

Retention of Vitality by Algæ from old Stored Soils.—B. MURIEL BRISTOL (*New Phytologist*, 18, 1918, 92-107, figs.). By culture of old stored soils from Rothampstead it was found that some of the Myxophyceæ, Bacillariæ, and Chlorophyceæ have extraordinary powers of retaining vitality during long periods of rest, and that the length of time after which they can resume growth appears to be affected by the degree of dryness of the soil during the resting period. The greatest power of resistance against desiccation was shown by *Nostoc muscorum* and *Nodularia Harveyana*, which resumed growth after extreme desiccation for 70 years; others—*Nostoc Passeriniianum*, *Anabæna oscillarioides* var. *terrestris*, *Cylindrospermum lichiniiforme*, *Chlorococcum humicola*—after 59 years; *Trochiscia aspera*, *Stichococcus bacillaris*, *Nitzschia Palea*, after 48 years; *Plectonema Battersii*, *Hapalosiphon flexuosus*, *Phormidium tenue*, after 47 years; and *Anabæna laxa* after 46 years. Though the algæ described from the cultures differ somewhat from typical forms, yet they are probably only cultural variants. A. G.

Malay Form of *Chlorococcum humicola* (Näg.) Rabenh.—B. MURIEL BRISTOL (*Journ. Linn. Soc., Bot.*, 1919, 44, 473-82, 2 pls.). An account of an algæ obtained by culture from a sample of soil from Kuala Lumpur, which had been dried and stored in a closed tube for two years. The vegetative cells and their contents are described. Adult cells are cœnocytic, with many pyrenoids. Propagation is effected by biciliate zoogonidia, which are asexual or may act as gametes. Aplanospores also may be formed, and enter into a palmelloid state, eventually turning into zoogonidia or developing directly into vegetative cells. *Chlorococcum humicola* occurs almost universally in English soils, and its retention of vitality in long-dried soils has been found to exceed seventy years. A. G.

Contribution to the Algal Flora of South Luxembourg.—H. KUFFERATH (*Bull. Soc. R. Bot. Belg.*, 1914, 53, 88-110). An account of a collection of Desmids from the environs of Virton and from Stockeen, a region hitherto unexplored algologically. Jurassic limestone is found there. The area belongs geologically to the Paris basin and to non-calcareous regions. The algal flora resembles partly the Ardennes flora and partly that of Lorraine. The climate is mild, and the soil varies from the hardest limestone to windswept sand. Eighty-one species and varieties are recorded, of which forty-five are new to Belgium and fifty-eight new to the province of Luxembourg. The author makes a very strong appeal to algologists to divide up the areas they study into natural regions, and not according to political limits; to study and publish more exact details as to nature of soil, formation of rock, constituents of the water, and so on. He would also have the exact locality given, according to the official ordnance maps, with indications

as to stagnation or movement of the water. He maintains that study carried out on those lines would help to solve problems of many kinds, and to define the physiological relations which govern the species-limits of Cryptogams. E. S. G.

New and Rare Fresh-water Algæ.—G. I. PLAYFAIR (*Proc. Linn. Soc. New South Wales*, 1918, 43, 497-543, 5 pls. and 11 figs.). An enumeration, including 28 species, 29 varieties, 9 forms, and 1 genus, all new to science, and figured and described. One collecting spot, frequently visited during two years, was a pool which received the drainage of a swamp after rain, and often dried up at other times. Its flora was remarkably varied; though the Desmids and Diatoms remained fairly constant, yet the Myxophyceæ, Volvocaceæ, and Proto-coccoideæ presented month after month an apparently endless succession of forms—new, rare, or not previously recorded, and often never seen again; for example, 10 forms of *Chlamydomonas*, 5 of *Carteria*, 2 of *Phacotus*, 2 of *Volvox*, 7 of *Oocystis*, 7 of *Tetraedron*, 4 of *Geminella*—which rarely were recorded again for the pool, but sometimes appeared at the same time in some other pool at a distance. The new genus is *Urnella*, placed in the Hydrogastraceæ; it contains one species, *U. terrestris*, found as a green growth on a clay path in very wet weather. It somewhat resembles *Protosiphon* and *Codiolum*, but differs from both. Every novelty appears to be figured. A. G.

Fresh-water Algæ of Africa.—F. E. FRITSCH (*Annals S. African Mus.*, 1919, 9, Pt. 7, 483-611, 43 figs. in text). A first report of the Fresh-water Algæ, mostly from the Cape Peninsula, in the herbarium of the South African Museum. The collections here dealt with were made in the year 1908 by a number of different botanists, and contain 97 genera and 238 species, of which 19 species and 6 varieties are new. The list is not in any way regarded as exhaustive, since several common genera are quite unrepresented, while of others only one or two species have been found. Two new species of *Eccallocystis* and one of *Sphæroplea* are described. *Hydrodictyon africanum* is also recorded. Many of the species are discussed in detail and figured. E. S. G.

Green Algæ of North America: Second Supplement.—F. S. COLLINS (*Tufts College Studies*, 1918, 4, No. 7, 106 pp., 3 pl.). This second supplement embodies all additions to the subject published or discovered during the last five years. Keys to certain genera are revised, a few new species are described, and valuable critical notes are appended to many of the records. E. S. G.

Working Key to the Genera of North American Algæ.—F. S. COLLINS (*Tufts College Studies*, 1918, 4, No. 8, 50 pp.). A practical key, including all well-established North American genera, omitting Diatomaceæ and such intermediate organisms as Peridiniaceæ, Flagellatæ, etc. A useful novelty is the employment of geographical distribution as an aid to generic determination. In the cases where a genus is recorded

only from the Atlantic or the Pacific, North and South, such an indication may save time and trouble. A glossary of the terms employed renders the key available for amateurs.

E. S. G.

New Pacific Coast Marine Algæ. II., III., IV.—N. L. GARDNER (*Univ. California Publ. Bot.*, 1918, **6**, 429-54, 455-86; 1919, **6**, 487-96, pls. 36-42). A continuation of the diagnoses and critical discussions of new Marine Algæ from the Pacific Coast. In Part II. the author presents thirteen new species of Myxophyceæ which, with the exception of two species of *Chloroglaea*, belong to the group Chamæsi-phoniaceæ. Certain stages of development in *Dermocarpa* and *Xenococcus* were found very troublesome to determine; as also the genera *Hyella* and *Rudaisia*, the limits of which have not been clearly defined. As regards the latter problem, the author distinguishes them as follows:—Those forms with erect filaments, more or less branched and distorted, arising from basal filaments on the surface of the substratum and growing into it, and having gonidangia at their bases near the surface of the host, have been assigned to the genus *Hyella*. Those forms with erect filaments, simple or complex, closely compact, more or less parallel, not at all or only slightly branched, arising in the same manner as those mentioned above, but extending away from the host, and with gonidangia on the outer free ends, have been placed in the genus *Rudaisia*. In Part III. twenty-three species of Myxophyceæ are described and discussed, of which twenty-one are new to science, while the remaining two present alteration of nomenclature. In Part IV. five novelties are described, belonging to Myxophyceæ and Chlorophyceæ, and two species are transferred from *Urospora* to *Hormiscia* for reasons given. In an interesting discussion on his new species, *Codium Setchellii*, the author gives his reasons for transferring thither all the hitherto recorded *C. adhærens* from the Pacific Coast of North America. With the exception of *C. Setchellii*, all the novelties appear under the joint authorship of Setchell and Gardner.

E. S. G.

Alternation and Parthenogenesis in Padina.—J. J. WOLFE (*Journ. Elisha Mitchell Sci. Soc.*, **34**, 1918, 73-109. See also *Bot. Gazette*, **67**, 1919, 278). A study of the Dictyotaceans alga *Padina variegata* found in North Carolina. The sperms, eggs and tetraspores are borne on three distinct plants, which in the vegetative state are quite alike, but are readily distinguishable in the reproductive phase. Tetraspores give rise to sexual plants only, male and female, in nearly equal numbers, so that sex appears to be predetermined during the reduction division in the tetraspore mother-cell. Fertilized oospheres give rise to tetrasporic plants. Thus there is an alternation of generations. Though unfertilized oospheres often germinate, yet these parthenogenetic plants soon wither.

A. G.

Cytology and Life-history of Nematium multifidum Ag.—RALPH E. CLELAND (*Annals of Botany*, **33**, 1919, 323-51, 3 pls. and figs.). An investigation of the red alga *Nematium*, which produces no tetraspores. The results are summarized as follows:—(1) *Nematium* has a true

pyrenoid, a densely-staining body in the centre of a radiating chromatophore, its prominence being directly proportional to its opportunities for photosynthetic activity. The pyrenoid is actively concerned in the elaboration of soluble "Floridean starch" diffused through the cytoplasm. (2) The spermatium-nucleus is in prophase of mitosis when the spermatium escapes, and divides after the latter has become attached to the trichogyne; hence the spermatium is the homologue of an antheridium. (3) Several male nuclei may pass into the trichogyne, but only one enters the carpogonium. (4) A trichogyne nucleus is only occasionally formed, and, when present, breaks down very quickly. (5) The fusion of gamete nuclei involves a fusion of the chromatic nucleoles. (6) Chromosome reduction occurs with the first division of the zygote nucleus. The threads of the delicate reticulum thicken and shorten, and finally take on a parallel arrangement. A fusion of threads then apparently takes place, followed by condensation of material to form eight bivalent chromosomes, when they become differentiated as eight pairs of chromosomes distributed about the nuclear cavity in a clear stage of diakinesis. The sixteen chromosomes of these eight pairs are segregated by the first mitosis, which is therefore a reduction division. (7) The chromosome number is eight throughout all nuclear divisions in the history of the plant, except the first mitosis of the zygote nucleus. (8) Vegetative mitoses are best studied in the cells of the developing cystocarp. The resting nucleus contains a large nucleole and a reticulum of delicate threads. Approaching mitosis is indicated by the appearance of numerous granules (where the threads cross), which, increasing in size, are brought together by the contraction of the threads, fusing successively until the eight chromosomes are differentiated. The spindle is intranuclear, and conspicuous polar structures are present. The nucleolus, empty in appearance, takes a position during metaphase on the edge of the equatorial plate, outside of the spindle, and apparently disappears with the breaking down of the nuclear membrane. The two sets of daughter-chromosomes during telophase severally organize a chromatin nucleole from which material is later distributed as a network throughout the resting nucleus. (9) The nucleus left in the carpospore cyst after the first division of the carpospore nucleus may again divide, but the resulting nuclei do not become completely organized and soon break down. (10) Since the reduction, as in *Scinaia* and *Coleochæte*, takes place with the first mitosis of the zygote nucleus, the cystocarp of *Nemalion* is not sporophytic in character, and there is no cytological alternation of generations in this plant.

A. G.

Distribution of certain British Algæ.—A. D. COTTON (*Journ. Bot.*, 1914, 52, 35-40). A discussion on the distribution of certain marine algæ in the British Isles, which calls for explanation on grounds of discontinuity or for some other reason. *Ptilota plumosa*, *Callithamnion arbuscula*, and *Codium mucronatum* var. *atlanticum* are specially dealt with. In the absence of adequate explanation of their absence from the Cornish coasts and their peculiar distribution in Wales, it is suggested that a study of the effect of adverse currents in hindering the dispersal of spores might solve the problem.

E. S. G.

Japanese Seaweed, Tosaka Nori.—A. D. COTTON (*Kew Bull.*, 1914, No. 6, 219–22). An account of the history of *Eucheuma papulosa* (Mont.) Cotton and Yendo, with synonymy, description and biology. Its identity with the edible alga of Japan had not hitherto been recognized. The authors transfer it from *Callymenia* to *Eucheuma*.

E. S. G.

Notes on Australian Marine Algæ. II.—A. H. S. LUCAS (*Proc. Linnæan Soc. New South Wales*, 1919, 44, 174–9, 1 pl.). Descriptions of four new species:—(1) *Laurencia infestans*, a dwarf species occurring in large patches on *Ecklonia radiata* var. *exasperata*. (2) *Falkenbergia olens*, which was washed in by the sea and smothered the oyster-beds, causing great damage to the industry, killing the oysters, and causing a vile stench. The plague occurs at irregular intervals. (3) *Polysiphonia zostericola*, abundant on *Zostera* leaves in Sydney Harbour. (4) *Trichodesmium scoboideum*, collected at Hope Islands, near Cooktown, in June, 1918, by A. R. McCulloch; it covered the sea, and looked like brown sawdust, being regarded locally as a sign of good weather. It is an important food item to a large number of reef animals.

A. G.

Sub-Antarctic and Antarctic Marine Algæ. II.: Rhodophyceæ.—H. KYLIN and C. SKOTTSBERG (*Wiss. Ergebn. Schwed. Südpolar Exp.*, 1901–3, 1919, 4, 88 pp., 1 pl., 38 figs. in text). A critical account of the Rhodophyceæ collected by Dr. Skottsberg on the Swedish Antarctic Expedition, 1901–3. The working-out of the different families was divided between himself and Dr. Kylin. New genera and species are described and figured. Unfortunately the war prevented all comparison with collections in herbaria outside Sweden, but the authors had access to some of the algæ collected in South Georgia by P. F. Reinsch (though not determined by him), which happened temporarily to be in Sweden. A synopsis of the geographical distribution of each species in the Antarctic and Sub-Antarctic area is given in tabular form, and is followed by an enumeration of the species in geographical groups, with remarks. The notes appended to each record in this report, together with their respective explanatory figures, form a valuable addition to Antarctic algal literature. Five species of Cyanophyceæ are recorded as being found among the collection.

E. S. G.

Calcareous Algæ from Murray Island, Australia, and Cocos-Keeling Islands.—MARSHALL A. HOWE (*Carnegie Inst. Washington*, 1918, No. 213, 291–96, 2 pls.). A record of seven species from Murray Island and three from Cocos-Keeling. Of the former, one is the cosmopolitan *Halimeda Opuntia*, and the rest belong to Corallinaceæ. Heydrich's *Lithothamnion Orthoblastum* is transferred to the genus *Goniolithon*, for reasons set forth in a discussion of its structural characters.

E. S. G.

Fungi.

Contributions to the Life-History and Cytology of *Synchytrium endobioticum*.—An investigation of this fungus has been undertaken by K. M. CURTIS (*New Phytologist*, 1919, **18**, 90-91), who now publishes a preliminary account of her work. It causes a disease of potatoes known as "black wart," which threatens to become very serious. Curtis describes the development of the fungus from its entry into the host by the motile spores, with the reaction on the host plants, the formation of zoosporangia and the liberation of the sporangia. The motile cells liberated are facultative gametes and may form a zygote, or the gametes may directly infect the host without previous fusion; a sorus is formed in the host cells. Fuller details will be published later. A. L. S.

Sexuality in *Cunninghamiella*.—OWEN F. BURGER (*Bot. Gaz.*, 1919, **68**, 134-6). The author finds that in this genus of Mucorini there is no sexual dimorphism; there exists a selective power in some strains to form zygospores with certain other strains; in some strains there is a condition that might be called hermaphroditism, but in none of them did branches of the same hyphæ conjugate. Zygospores were produced only between strains the gametes of which were compatible. The cultures that led to these conclusions are fully described. A. L. S.

Physoderma Disease of Corn.—W. H. TISDALE (*Journ. Agric. Research*, 1919, **16**, 137-54, 9 pls., 1 fig.). This disease has caused great loss to corn crops along the Atlantic and Gulf Coasts in America, and in the Mississippi Valley. The author identified the parasite as *Physoderma Zee-Maylis*, first described by Shaw as occurring in Bengal. The life-history and development of the fungus have been traced by Tisdale by artificial cultures, by inoculations, etc. The sporangia overwinter on old infected plants and in the soil: possibly they may live there and retain viability for a number of years. Crop rotation and resistant varieties are recommended as a means of controlling the disease. A. L. S.

Some *Phyllachoras* from Porto Rico.—T. L. STEVENS and NORA DALBY (*Bot. Gaz.*, 1919, **68**, 54-9, 3 pls.). Most of the species described and figured are new to science. They are parasites occurring on the leaves of the higher plants. A. L. S.

Study of *Pyrenomyces*.—J. E. CHENANTAIS (*Bull. Soc. Mycol. France*, 1918, **34**, 47-73, 123-36; 1919, **35**, 46-98, 113-39, 6 pls., 25 figs.). Chenantais in a succession of papers has made a study of classification in various groups of *Pyrenomyces*. He discusses the conception and the value of genera and species. He decides that there is no rigid rule in valuing characters of importance in classification. He passes in review a large number of genera and species, giving minute and detailed descriptions of a number both of genera and species. He has established a new genus of Sordariæ—*Lasiosordaria* with two sections, *Lasiosordariella* and *Lasiosordariopsis*. A. L. S.

Rostronitschkia, a New Genus of Pyrenomycetes.—A. M. FITZPATRICK (*Mycologia*, 1919, **11**, 163-7, 1 pl.). The fungus is parasitic on the leaves of *Gesneria albiflora* in Porto Rico, and was first called *Nitschkia neroicola*. It differs from *Nitschkia* in the long beak of the perithecium.
A. L. S.

New Species of Rust, Puccinia Corteyi Ran.—N. RANOÏÉVITCH (*Bull. Soc. Mycol. France*, 1919, **35**, 140-1, 1 fig.). The rust was found by the author of the paper on the rare plant *Heracleum minimum*. It differs from allied rusts in the form and the deeper brown colour of the teleutospores.
A. L. S.

Notes on Some Polemoniaceous Rusts.—C. R. ORTON (*Mycologia*, 1919, **11**, 168-80). This paper has been written to clear up problems of nomenclature both of host and parasite in this group of rusts. The author has critically examined all the species, and publishes diagnoses and notes.
A. L. S.

Smuts and Rusts of Utah. III.—A. O. GARRETT (*Mycologia*, 1919, **11**, 202-15). The author lists four species of *Ustilago* with a numerous series of Uredinales belonging to many genera. The host plant is always given, and, in addition, biological and historical notes.
A. L. S.

Revision of the British Clavariæ.—A. D. COTTON and E. M. WAKEFIELD (*Trans. Brit. Mycol. Soc.*, 1919, **6**, 164-98). As first outlined, the work undertaken in 1905 should have included all the Clavariæ, but it was found necessary to deal with European, more especially with British species. Much use has been made of microscopic structure combined with field characters. The list given in this revision consists of thirty-seven species, six of which have been determined as new during the course of the work. A key to the British species is given, and then follows a diagnostic and descriptive account of all the British members of the genus.
A. L. S.

Development of Stropharia epimyces.—This fungus is always a parasite on another Agaric. It grew in great abundance at Urbana, Illinois, in the summers of 1915-16, and has been collected and studied by W. B. McDUGAL (*Bot. Gaz.*, 1919, **67**, 258-63, 10 figs.). It is the development of the carpophore rather than the nature of the relationship between host and parasite that has engaged the writer's attention. He places it in the same group as *Agaricus campestris*, in which the hymenophore primordium appears before any other part of the carpophore is differentiated: the distinction of pileus and stem comes at even a later stage. The *Stropharia* grew on *Coprinus comatus*; it had previously been found on *C. atramentarius*.
A. L. S.

Relationships within the Rhodosporeæ.—In a posthumous paper by G. F. ATKINSON (*Bot. Gaz.*, 1919, **67**, 267-8) there is outlined a study of the lamellæ of the pink-spored Agarics. The author finds two distinct types indicating two phyletic lines: (1) the Pluteinæ, with cystidia and separable pileus, etc., including *Pluteus* and *Volvariæ*:

(2) hymenophores not separable and without cystidia, the Entolomatinae—*Entoloma*, *Leptonia*, *Clitopilus*, *Eccilia*, *Nolanea*, and *Claudopus*. There are also marked differences between the groups in the trama hyphae of the lamellae. A. L. S.

Thelephoraceæ of North America. IX.—EDWARD ANGUS BURT (*Ann. Miss. Bot. Gard.*, 1918, 5, 177–203, 14 figs.). This paper takes up the genus *Aleurodiscus*, of which the type species is *A. amorphus* (*Corticium amorphum* Fries). The author gives descriptions of fourteen species in North America. They are distinguished by peculiar development of cystidia or paraphyses, some of the latter with outgrowths that have been designated by Burt as of “bottle-brush” form. Several new species are recorded. A. L. S.

Notes and Observations on Agarics.—P. KONRAD (*Bull. Soc. Mycol. France*, 1919, 35, 143–6). The author gives a descriptive account of *Tricholoma tigrinum* as found in the neighbourhood of Neuchâtel. The contrast between it and other species is pointed out. It is one of the poisonous Agarics.

RENÉ MAIRE (*Bull. Soc. Mycol. France*, 1919, 35, 147–9, 1 fig.) publishes an account of *Rhodopaxillus nudus* (*Tricholoma nudum*), which had invaded a mushroom-bed and completely ousted the mushrooms. The fungus is an open-air and light-loving plant, and was considerably altered by the changed conditions of habitat, etc. The caps were less developed and the characteristic odour had disappeared, but the microscopic characters were well retained. A. L. S.

Development of *Pluteus admirabilis* and *Tubaria furfuracea*.—LEVA B. WALKER (*Bot. Gaz.*, 1919, 68, 1–21, 5 pls., 8 figs.). The various phases of growth in these two fungi have been followed from material collected in the open. In *Pluteus* special attention is given to the formation of the cystidia. In both forms the gills originate as folds which develop centrifugally. A. L. S.

Validity of the name *Discomyces* for the Genus of Fungi variously called *Actinomyces*, *Streptothrix*, and *Nocardia*.—E. D. MERRILL and H. W. WADE (*Philippine Journ. Sci.*, 1919, 14, 55–69). So many names have been used for the fungus causing actinomycosis that the authors have made a definite examination of the question. They arrive at the conclusion that priority must be given to *Discomyces*, substituted by Rivolla in 1878 for *Actinomyces*; the latter name is invalid, as it was previously used for another organism. In a final discussion they give their reasons for rejecting all other designations. A. L. S.

Additional Resupinate Hymenomycetes from the Weybridge District.—E. M. WAKEFIELD and A. A. PEARSON (*Trans. Brit. Mycol. Soc.*, 1919, 6, 136–43, figs.). The species enumerated are additional to the list already published for the district. The authors note the variation of these resupinates in the field. Thus *Corticium bombycinum* showed gradations from the typical smooth form to a blunt-toothed

Radulum: a cream-coloured *Radulum* was growing near to *Merulius tremellosus*, with which it was proved to be identical. A genus, *Platygloea*, new to Britain was found; the species *P. effusa* resembles *Corticium* or *Sebacina* in appearance, but has a transversely septate basidium. A new fungus, *Hypochnus roseo-giseus*, is abundant on old pine-roots.
A. L. S.

Further Notes on *Colus Gardneri* (Berk.) Fischer.—T. PETCH (*Trans. Brit. Mycol. Soc.*, 1919, 6, 121-32, 1 pl.). This fungus was first described by Berkeley as a species of *Lysurus*. It was removed to *Colus* by Fischer because the vertical lobes or "arms" are united at the top. There has been much discussion as to its true position, but Petch has had ample opportunity of seeing fresh specimens in Ceylon, and he finds that it differs both from *Lysurus* and from *Colus* in its glebiferous layer, which extends laterally almost completely round the arm, but is interrupted by a deep narrow furrow on the outer side; it consists of numerous plicate processes and plates perpendicular to the arm, closely packed together and presenting a granular outer surface. On this account Petch has established a new genus, *Pharus*. The fungus has been found only in Ceylon.
A. L. S.

Studies on the Biology and Culture of the Higher Fungi.—G. BOYER (*Mém. Soc. Sci. Phys. Nat. Bordeaux*, 1918, 11, 233-344, 4 pls., 20 figs.). The author deals with every aspect of the culture of the higher fungi. His method was to work with "cuttings" rather than with spores. Some forms, such as the mushroom, responded excellently; others, *Morchella* for instance, refused to grow by "cuttings," though the spores germinated freely. In no case was a sporophore obtained in this species, which caused Boyer to conclude that some parasitism or association with other organic life was often necessary for full development. He also comments on the changes in size and coloration obtained which render these characters of less importance in classification.
A. L. S.

Notes on some Saprophytic Species of Fungi associated with Diseased Potato Plants and Tubers.—G. H. PETHYBRIDGE (*Trans. Brit. Mycol. Soc.*, 1919, 6, 104-20, 2 pls.). The author has made a prolonged cultural study of these fungi during his investigations of potato-disease in Ireland. He cultivated the spores of a *Nectria* that he found on old potatoes, and from these he developed the well-known *Acrostalagmus cinnabarinus* (re-named *Verticillium* by Reinke and Berthold). An attempt was made to develop the *Nectria* perithecia from the conidial form, but that was unsuccessful. The *Nectria* has been named *N. inverta* sp. n. Pethybridge also describes *Colletotrichum tabificum* sp. n., which developed from sclerotia-like bodies. *Hypomyces Solani*, also a Saprophyte, was induced to form conidia; these are four-celled and somewhat similar to *Fusarium* conidia, but not identical with any *Fusarium* found on the potato hitherto. Two new species of *Verticillium*, *V. nubitum* and *V. nigrescens*, were found on diseased tubers, somewhat like *V. albo-atrum*, but whereas the mycelium of the

latter turns dark, the dark colour in both the new species is due to chlamydospores with very dark walls. No higher form was found for these species.
A. L. S.

British Mycology: The Selby Foray.—The twenty-second annual week's Fungus Foray was held at Selby in September, 1918. An account of the work done during the meeting is given by the Secretary, M. WAKEFIELD (*Trans. Brit. Mycol. Soc.*, 1919, **6**, 77-87, 1 pl.). A dry season had hindered the growth of the fungi, but a large and interesting collection was made. No new species were discovered, but four fungi new to Britain were obtained: *Hypochnus umbrinus*, *H. isabellinus*, *Galactinia Howsei* and *Zythia mercurialis*. The Presidential Address (pp. 91-103) was given by the Rev. David Paul, and dealt with the earlier study of fungi in Britain. The earliest mention of these plants occurs in the "Greate Herball," in 1566. Other Herbals also as a rule took some note of fungi. The gradual building up of the science, with special reference to field-work, is traced down to the time of Berkeley, "whose 'Outlines' settled for mycologists the system of classification of the higher fungi."
A. L. S.

Ecological Diversity and Generic Coefficients.—J. DUFRENOY (*Bull. Soc. Mycol. France*, 1919, **35**, 27-46). This subject had been worked out for the Phanerogams by Jaccard, who found that in regions with little ecological variation the numbers of genera in comparison with species was very high. Dufrenoy finds that the same calculation holds good for Cryptogams. Thus on sea-dunes he found 3 genera with 3 species giving 100 p.c.; on dunes at Arcachon, 10 genera with 11 species, 90 p.c.; and on dunes at Pinada, 11 genera with 12 species, also 90 p.c. The generic coefficient for Phanerogams in these same localities was also 90 p.c. Many other ecological districts are reviewed. Where there is more variation in the ecology of any given area, the percentage is much smaller.
A. L. S.

Cave Fungi.—J. LAGARDE (*Arch. Zool. Exper.*, 1913, **53**, 277-307, 2 pl., 8 figs.; 1917, **56**, 279-314, 2 pl. (1 col.), 2 figs.). These papers form part of a series entitled "Biospeologica," which take into account the organisms found in subterranean situations. The author finds that the absence of light and the abnormal conditions of humidity and temperature had exercised considerable influence on the development of the fungi collected from many different caves. He records one Mycetozoon, *Arcyria nutans*, and one Phycomycete, *Mucor* sp.; the other forms examined belong to the Ascomycetes, Basidiomycetes and Hyphomycetes. Among the latter are a number of species of *Isaria*, which were mostly found on insects. He has established a new genus, *Maheria*, for a species which he had first placed under *Isaria guignardii* Mahew; he distinguishes it from *Isaria* on account of a central sterile stalk. Another new genus and species, *Corallinopsis pilulifera*, which grew on various *Coleoptera*, belongs to the Phaeostilbaceæ. Several new species are described belonging to different genera.
A. L. S.

New British Fungi.—E. M. WAKEFIELD (*Trans. Brit. Mycol. Soc.*, 1919, 6, 132-4). A number of fungi new to this country are described in full. The more interesting are *Hypochnus umbrinus* and *H. isabellinus*, both of a somewhat dark colour, and distinguished by the warted or spinous spores. Another species, *Helotium ciliatosporum*, bears ascospores that are ciliate at one end. A. L. S.

New Mycena.—A. A. PEARSON (*Trans. Brit. Mycol. Soc.*, 1919, 6, 135-6, 1 fig.). *Mycena epipterygioides* sp. n. was found by the author in the pine-woods at Weybridge. It is marked by spinous basidia which spring from the viscid thread at the edge of the gills. A. L. S.

New or Rare Microfungi.—A. LORRAIN SMITH (*Trans. Brit. Mycol. Soc.*, 1919, 6, 149-57, 2 figs.). A list of species found or already recorded during the preceding year. One new genus, *Boydia*, is described, with peculiar long spores widening at each end like a double oar. Similar spores occur in *Vialea insculpta* Sacc. But in the latter the perithecia develop from stromata. A. L. S.

Entomogenous Fungi New to Britain.—A. D. COTTON (*Trans. Brit. Mycol. Soc.*, 1919, 6, 200-3). Three species of *Empusa* are listed, with descriptions as given in Thaxter's "Entomophthorae of the United States." Two of the species were found on aphides in Scotland; the third species was found on a small green caterpillar on grass in Somerset. *Cladosporium aphidis* is also recorded from Ross-shire, but it may probably be a form of the common *C. herbarum*; there was no evidence whether the fungus was parasitic or merely saprophytic. A. L. S.

Fluorescent Coloring Matter from *Leptonia incana*.—HAROLD WAGER (*Trans. Brit. Mycol. Soc.*, 1919, 6, 158-64). The fungus when placed in 95 p.c. alcohol gives a green solution which shows a brilliant green or green-blue fluorescence; in distilled water an opalescent yellow solution with a slight green fluorescence. The author describes the effect of repeating the solutions, of evaporating, and of adding various reagents, acid or alkaline. He contrasts fluorescence with phosphorescence, which are now classed together as photo-luminescence. He found fluorescence in a large number of fungi, which are listed along with the colour produced. A. L. S.

Some Concepts in Mycology: An Attempt at Synthesis.—W. B. BRIERLY (*Trans. Brit. Mycol. Soc.*, 1919, 6, 204-35). The writer deals mainly with the species-concept. He contends that morphological characters are not constant; that there is great plasticity in the organism which has not been sufficiently recognized; and also, by experiment, he has shown that the morphological variations depend on environment and are constant, given identical conditions. This introduces the physiological species, the morphological individual being merely the visible expression of the reactions of the physiological constitution under particular conditions. A second section of the paper deals with the educability of the fungus. A. L. S.

Bracket Fungi of Citrus Trees.—(*Rep. Agric. Dept. Dominica* (1917-18), 1919, 11-3.) The mycologist of the Department reports that fungal damage of the lime is largely due to bracket fungi, which gain entrance to the tree by any wound due to accident or to pruning, etc. It destroys the dead wood, and also in time attacks the living cells, but the rate of growth depends on the state of the host-tree. He recommends attention to soil, clearing away of all dead branches, and painting over exposed parts. A. L. S.

Occurrence of Oak-mildew on Beech in Britain.—A. D. COTTON (*Trans. Brit. Mycol. Soc.*, 1919, 6, 198-200). The writer gives a short account of the finding and naming of this fungus. It is now generally referred to *Microspheera Alni*, though Griffon and Maublanc hold that it is a distinct species, *M. alphitiodes*. The fungus is very common on oak; very rarely is it found on beech. The writer reports finding it at Sevenoaks in July, 1918. It occurred on shoots from stumps of felled trees. Only very young leaves are susceptible. A. L. S.

Phytophthora Faberi Maubl. : The Cause of Coconut Bud Rot in the Philippines.—OTTO A. REINKING (*Philippine Journ. Sci.*, 1919, 14, 131-51, 3 pls.). A study of this disease has been carried out to ascertain definitely if it were due to *Phytophthora* or to bacteria that are always associated with it. Many bacteria were isolated from the diseased tissues, but all were saprophytic except one which resembled *Bacillus coli*, and which was able to set up rot in healthy cells. The author further proved by culture experiments that *Bacillus coli* isolated from man or horse may produce disease in plants. The fungus however was proved to be the agent that caused the rot: the bacteria in the majority of cases are always secondary, but are concerned with destroying the weakened tissues. *Phytophthora Faberi* has been found to cause black rot of cacao pods, canker of cacao, fruit rot and canker of *Hevea* rubber, and rot of papaya fruit. It grows readily also as a saprophyte, on dead portions of coconut, cacao and papaya. Recommendations for combating this widespread and virulent disease in tropical lands are appended. A. L. S.

"Brown-rot" Diseases of Fruit-trees: with Special Reference to two Biologic Forms of *Monilia cinerea*.—H. WORMALD (*Ann. Bot.*, 1919, 33, 361-404, 2 pls.). The author has studied experimentally the rot that attacks the fruits of apple and plum, due to fungi that enter by wounds or abrasions and develop rapidly within the tissues. The more important of these predatory fungi are species of *Monilia*, a genus of Hyphomycetes. The author gives a history of what has been known of these fungi, and he describes various outbreaks of disease caused by them in this country. Full accounts of inoculation and culture experiments are given. A general discussion of the results is reserved for a future paper. The conclusions are: that in this country two distinct species, *Monilia fructigena* and *M. cinerea*, occur on fruit-trees; that each species has two biologic forms distinguished by the effects produced on apples: and that of the two forms of *M. cinerea*, one

produces a "Blossom Wilt and Canker Disease" of apple-trees, the other causes infection of the apple inflorescence, but only on the flowers inoculated.

A. L. S.

Account of some Field Observations on the Development of Potato Blight.—F. T. BROOKS (*New Phytologist*, 1919, **18**, 187-200.) Observations were made by the writers and others at Penzance and in the Isle of Wight on the overwintering and new infection areas of disease due to *Phytophthora infestans*. They found that the earliest outbreaks of blight developing *in situ* are of strictly limited extent, and that from them the fungus spreads centrifugally under favourable conditions until the spores are widely distributed in the air and the disease becomes epidemic. They found that tubers were early affected, but not from the main stem or from the stolons. Infection from the soil or from infected shoots seems probable, and possibly from resting oospores (proved to exist by culture experiment). Critical evidence of such infection would be difficult to find and thus to establish the method by which the disease is carried on from year to year.

A. L. S.

Studies in the Physiology of Parasitism. V. Infection by Colletotrichum Lindemuthianum.—P. K. DEY (*Ann. Bot.*, 1919, **33**, 305-12. 1 pl.). The object of the investigation was to follow the stages of infection of the bean by the above fungus. The author found that the spore, when germinating on the host plant, produces a germ-tube which develops at its end a thick-walled, dark-coloured appressorium directly it comes into contact with the host surface, to which it is attached by a mucilaginous envelope. From the appressorium a peg-like hypha grows out which ruptures mechanically the host cuticle and brings about a swelling of the subcuticular layers. Only one instance was noted of the germ hypha entering by a stoma. The action of the parasite on the host cells is described.

A. L. S.

Disease of Red Clover.—The disease due to *Macrosporium sarcinæforme* was first recorded by Cavara in 1890. It has now been thoroughly investigated by J. KRAKOVER (*Nineteenth Report, Mich. Acad. Sci.*, 1917. 273-323, 5 pls.). The fungus attacks both leaves and petioles; the morphology of the fungus does not entirely agree with Cavara's description, but the name has been provisionally retained. The course of the disease is described and the results of inoculation experiments. The fungus enters usually between the epidermal cells of the host-leaf: germinating seeds are readily attacked. The fungus was also cultured on various nutritive media, and the results are given in full detail. The author decides that the ultimate method of controlling this and other clover diseases must be the breeding of resistant varieties. A bibliography of the literature cited is published.

A. L. S.

Fusarium Wilt of Potato in the Hudson River Valley, New York.—The disease made itself specially manifest in 1914, and exhibited the characters described as being due to *Fusarium oxysporum*. ROYAL J. HASKELL (*Phytopathology*, 1919, **9**, 223-60, 3 pls.), has investigated

the Hudson River Valley attack, and has found it due to the same fungus. That *F. oxysporum* is the primary cause of the disease is shown by the constant association of the fungus with the potato, and has been proved convincingly by artificial cultures and inoculation. It causes necrosis of the tubers; the plants arising from such tubers are weak and the yield is small. The writer has examined also its relation to temperature: it develops best in hot weather. The suggestion is made that early potatoes that mature before the great heats should be grown in districts liable to the disease. A. L. S.

Philippine Plant Diseases.—OTTO REINKING, the author of this paper (*Phytopathology*, 1919, 9, 114-40), states that fungus diseases are found on practically all cultivated and wild plants in Laguna Province, Island of Luzon. The long series of forms that he describes occur mostly on economic plants, and are described under their respective hosts, alphabetically arranged from *Ananas sativus* (pineapple) to *Zea Mays* (corn maize). In most cases information is given as to the remedies used and the results obtained.

In another paper (*Philipp. Journ. Sci.*, 1918, 13, 165-274, 2 pls., 43 figs.) the author treats the subject in detail. He gives an alphabetical list of hosts and parasites with the method of treatment suitable in each case. The list is a long one, as according to Reinking plant diseases are peculiarly abundant in the islands. There are, he says, more plant diseases there than in the whole United States. A. L. S.

Leaf-spot Disease of Red Clover caused by *Macrosporium sarcinæforme*.—The author of this paper, L. J. KRACKOVER (*Nineteenth Report, Mich. Acad. Sci.*, 1917, 275-328, 5 pls.), draws attention to the diseases of red clover which he says have been very little studied. He gives an historical sketch of the occurrence of leaf-spot from its first recognition by Cavara in Italy in 1890. The disease is very widely distributed and is very destructive; it attacks both the leaves and the petioles. Krakover was able to observe that infection took place by the germinating tube piercing the leaf between the epidermal cells; it then attacks the parenchyma, which is finally killed and invaded. The fungus then sends up hyphæ through the stomata or between the epidermal cells on both sides of the leaf, and these bear spores at the tips, of the well-known *Macrosporium* type. The author made many culture and infection experiments, all of which are described in detail. He found that it grew well on a large variety of culture media without striking modifications. Finally, he recommends the breeding of resistant varieties of clover as the only method of combating the disease. The paper is well illustrated. A. L. S.

Disease of Flax Seedlings.—A disease known in the North of Ireland as "yellowing" has been investigated by G. E. PETHYBRIDGE and H. A. LAFFERTY (*Sci. Proc. Roy. Dublin Soc.*, 1918, 15, 359-84, 2 pls.). The fungus causes spots on the leaves and lesions on the stems somewhat resembling "damping off." A species of *Colletotrichum* was found associated with the injury, and infection experiments proved

it to be the cause of the malady. It is described as a new species, *C. linicolum*. The authors further discovered that the mycelium hibernated within the cells of the epidermis of the seed-coat, and the seedlings became infected during, or subsequent to, germination. Treating slightly moistened infected seed with a mixture of finely powdered copper-sulphate crystals and dry sodium carbonate suppressed the disease entirely. Other cases of "yellowing" are caused by other fungi. The local designation of the disease is lacking in accuracy.

A. L. S.

Recent Work at the Pathological Laboratory, Kew Gardens.—

Among other diseases in 1918 there have been noted several of special importance (*Journ. Board of Agric.*, 1919, **26**, 174-8). A bad attack of yellow rust of wheat (*Puccinia glumarum*) occurred in the early part of the year. Much of the wheat, however, outgrew the disease. Wheat mildew was prevalent in certain districts in July and August. American gooseberry mildew increased materially, and *Cronartium ribicola*, the black currant rust, was extremely abundant. Damping off of seedling tomatoes was caused in spring by *Phytophthora cryptogea*. A leaf-blotch in cucumber, due to *Colletotrichum oligochaetum*, caused a loss of several thousand pounds in Hertfordshire. Sclerotium disease of onions and the new onion smut caused considerable trouble throughout the country.

A. L. S.

Lichens.

Researches on Lichens of the Family Peltigeraceæ.—FERNAND and MADAME MOREAU (*Ann. Sci. Nat. Bot.*, 1919, sér. 10, **90**, 20-32). In this first paper the authors outline their course of study, which at present they have confined to one family of lichens. They see in the symbiosis and reproduction of lichens a field of study that may produce much elucidation of biological problems, and may contribute a very important chapter on general physiology and pathology.

A. L. S.

Brazil Parmeliæ.—BERT LYNGE (*Arkiv f. Bot. K. Svensk. Vet.*, 1917-18, **15**, No. 1, 1-4), publishes new records of *Parmelia* from Matto-Grosso, and two new species, *Parmelia patiscens* (Sect. *Amphigymnia*), which recalls *P. cristifera* Tayl.; and *P. coccinea* (Sect. *Hypotrachyna*), distinguished by a yellow medulla, scarlet spots and lines on the surface. The lobes of the thallus are narrowly laciniate.

A. L. S.

American Lichens.—LINCOLN W. RIDDLE (*Bryologist*, 1918, **2**, 50) publishes new records for several rare lichens—*Dirina repanda* has not been collected in the States, but specimens have been received from the Bahama Islands. *Lecidea cinnabarina*, a boreal species, has been recently collected in California. *Cetraria Fendleri*, a Mexican plant, has been found as far north as the Connecticut Valley, and *Physcia leucomela*, a tropical lichen, was found growing in Vermont.

A. L. S.

Biomorphogenesis in Lichens.—F. and MADAME MOREAU (*Bull. Soc. Mycol. France*, 1918, **34**, 84-5) describe the term biomorphogenesis as the morphogenic action of one organism on another. Under this

category they place the cephalodia which contain an alga other than that constituting the normal gonidia of the lichen concerned. They describe the growth of these cephalodia, more particularly the endotrophic forms, and draw the general conclusion that the lichen owes its peculiar formation to the action of the alga on the hyphæ of the fungus. The larger part of the thallus would be in their view the equivalent of a gall, "an algo-ecidium, a generalized biomorphosis." A. L. S.

Vegetation of Conglomerate Rocks of the Cincinnati Region.—In an account of the succession of vegetation on a bare rock surface, LUCY E. BRAUN (*Plant World*, 1917, 20, 380-392; see also *Bryologist* 1918, 21, 93) gives the first place as colonizers to lichens. She groups these lichens under *Lecidea* sp., *Pertusaria communis*, *Staurrothele umbrina*, *Verrucaria muralis* and *Placodium citrinum*. These with the xerophytic moss *Grimmia apocarpa* (of minor importance) form the first succession. In the second stage *Dermatocarpon minutum* practically covers the surface, the plants of next importance being a gelatinous lichen, *Omphalaria* sp. A few mosses are more prominent at this stage, and in shady spots the sterile lichen, *Amphitoma lanuginosum*. A. L. S.

Studies of Lichen Structure and Development.—An important paper on various aspects of lichen development has been published by O. GALLØE (*Dansk Bot. Arkiv*, 1913-15, 1, No. 3, 1-99, 240 figs.). The author discusses distribution as affected by climate, etc. He then gives a sketch of the relations of lichens to habitat. He gives special attention to the formation, function, and distribution of haptera, and to the organs of attachment in fruticose types. A. L. S.

Mycetozoa.

Mycetozoa found during the Selby Foray.—GULIELMA LISTER (*Trans. Brit. Mycol. Soc.*, 1919, 6, 88-91). A descriptive account is given of the country and of the conditions that prevailed during the week's foray in September, 1918. Recent rains had left the surface of the ground and the heaps of leaves in a moist condition, and a total of fifty-two species were collected, among them the very rare *Lycogala flavofuscum* and *Colloderma oculatum*, the latter only once before found in Yorkshire. A. L. S.

Michigan Collection of Myxomycetes.—A list of these collected during August in two summers has been prepared by H. C. BEARDSLEE (*Nineteenth Report, Mich. Acad. Sci.*, 1917, 159-62). Explanatory notes are published in connexion with a number of the species. A. L. S.

Myxomycete from Madagascar.—Under this general heading N. PATOUILLE (*Bull. Soc. Mycol. France*, 1918, 34, 86-7, figs.) has described a new genus and species of Plasmodiophoraceæ, *Trematophlyctis Leptodesmiæ*. It appears on the stem and leaves of *Leptodesmia congesta*. On the stems it causes pustules, each containing a variable number of sori; the leaves are thickened and fleshy; the

sori are distributed through the tissue, and open generally on the upper surface like small cups. A series of microfungi are also included in the paper, several of which are new to science. A. I. S.

Study of Plasmodiophora Brassicæ.—GIOVANNI BRIOSI (*Atti Ist. Bot. Univ. Pavia*, 1918, Ser. 2, 15, 281–321, 3 pls.) has published the results of his physiological and pathological researches on *Plasmodiophora*. He finds that the spore has a closed membrane, that it produces—but not constantly—flagellate bodies which become transformed to amœbæ and later unite to form a plasmodium. The amœbæ are uninucleate; then from the chromatic body other chromatic groups are formed which become in time true nuclei. As many spores are formed as there are nuclei. With *Plasmodiophora* he associates the organism that causes hydrophobia in dogs, etc., which he places in the same family under the name *Neurocytes hydrophobiæ* Williams. The parasite causing distemper (cimurro) in dogs is *N. canis* (Sinigaglia). A. I. S.

Schizophyta.

Schizomycetes.

Infections with Coccidium and Isospora in Animals in the Philippine Islands, and their possible Clinical Significance.—FRANK G. HAUGHWONT (*Philippine Journ. Sci., Sect. B., Tropical Medicine*, 1918, 13, 79–93). The author discusses the recorded cases of coccidiosis in

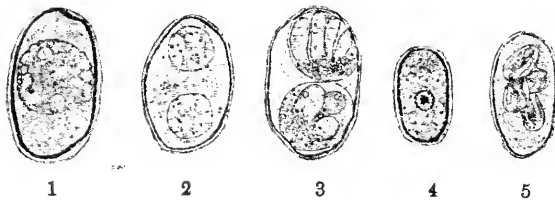

Fig. 1.—Cyst of *Isospora Bigemina* in early stage of development.
 ,, 2.—Later stage, showing development of sporocysts.
 ,, 3.—Completely developed cyst.
 ,, 4.—Cyst of *Coccidium cuniculi* in early stage of development.
 ,, 5.—Completely developed cyst.

man, including Wenyon's human *Isospora* infections. Coccidiosis of domestic animals is common in the Philippine Islands, and he suggests that as infection in man probably occurs by transmission from such animals, human coccidiosis will probably be found to exist in the islands when closer inquiry is made.

He figures three stages in the development of *Isospora Bigemina* which he obtained from a kitten (figs. 1–3), and gives the average size of the cysts, which are usually oval, as $20\ \mu$ by $16\ \mu$. When spherical, however, the diameter was about $19\ \mu$ to $20\ \mu$, a measurement corresponding very closely with Wenyon's human forms.

The cysts are very resistant to lethal agents. The author watched

them develop in various solutions, such as potassium bichromate 3 p.c., double strength Gram's iodine solution, thymol water, etc. The early stage and the completely developed cyst of *Coccidium cuniculi*, found in the Philippine rabbits, is figured (figs. 4 and 5) for comparison with the *Isospora* cyst. J. E.

Mutation in Bacteria.—L. DONCASTER (*Proc. Camb. Phil. Soc.*, 19, 5, 269). It was noticed that the recorded ratio of occurrence in cases of meningitis of the four agglutination-types of meningococcus corresponded very closely with the ratio of occurrence of the four iso-agglutinin groups of blood in a normal human population. It seemed possible, therefore, that by growing meningococcus of one type in media containing human blood of different groups, mutation to other types might be induced. Experiment showed that considerable differences in type of agglutination resulted, but it was concluded that this was caused by the sorting out of races of different agglutinability from a mass culture rather than by true mutation.

Philippine Economic Plant Diseases.—OTTO A. REINKING (*Philippine Journ. Sci.*, Sect. A, 1918, 13, 217-74, 22 pls.). The author enumerates and summarizes the plant diseases encountered in the Philippines, giving the bacterium or fungus responsible for each condition. The monograph is illustrated with plates of diseased plants and woodcuts of vegetable sections, and diagrams of the responsible microorganisms. J. E.

All Dead Bacteria are not Ag-positive.—AXEL CEDERCREUTZ (*Arkiv. för Inre Medicin*, 1919, 51, 269-81). Aage Nyfeldt in June, 1907, published investigations which led him to conclude that all dead organisms are Ag-positive, while all living—i.e. living previous to fixation—are Ag-negative. Cedercreutz, however, considers that no staining method has yet been perfected whereby dead and living bacteria may be distinguished. In bacteria life and staining power are not always correlated. In 1900, whilst studying a pleomorphic skin coccus (resembling the gonococcus, but Gram-positive), the author observed that several forms, though dead and unable to reproduce, stained well with polychrome methylen-blue. The above forms grow in cultures made on 5 p.c. dextrose-agar. The bacterial varieties retain their staining properties even after killing by heating ten to fifteen days. In these, and in even older dextrose-agar cultures (when the organisms can only be separated by the addition of sterile water) the bacteria stain quite as well as those in a young culture. Although the cocci of the fifteen-day dextrose-agar culture are dead, they seem to acquire on this medium a power of "conservation," so that even after killing they retain both their form and their staining properties. Following Nyfeldt's article, the author tried the effect of silver impregnation on these "conserved" bacteria, using the methods suggested by Nyfeldt, with the result that the majority of the cocci were Ag-negative. Although in some cases isolated Ag-positive cocci were found, these the author concluded had become impregnated with the dextrose-agar, which is in itself Ag-positive. The greater number of

dead organisms do not combine with silver, and Cedercreutz therefore asserts that "non-affinity to silver is no criterion whatever of the life or reproductive power of any bacterium." J. E.

On a New Factor in the Mechanism of Bacterial Infection.—W. E. BULLOCK and W. CRAMER (*Proc. Roy. Soc.*, 1919, **90**, Series B, 513–29). After recapitulating the fact that the bacteria or spores of gas gangrene and of tetanus, when completely freed from their soluble toxins, do not produce specific effects when inoculated into a mouse or guinea-pig—the normal animal disposing of the bacteria mainly by lysis, but partly also by phagocytosis—the authors show that if a small dose (2·5 milligram per 10–15 gm. body weight) of a soluble ionizable calcium salt (e.g. chloride) is injected together with the bacteria or their spores, the specific disease is elicited in a very virulent form. Moreover, direct contact between bacteria and calcium salt is not essential—the two factors may be injected at different times into the same site, or into different sites at the same or different times, since the calcium salts produce local changes in the tissues at the site of injection, which results in a local breaking down of the defensive mechanism against the bacteria of gas gangrene and tetanus. They propose the terms "kataphylaxis" or "defensive rupture" to designate the newly described phenomenon. J. E.

Revision des Champignons Appartenant au Genre *Nocardia*.—FRILANO DE MELLO and J. F. ST. ANTONIO FERNANDES (*Memoirs of the Asiatic Society of Bengal*, 1919, **7**, 103–38). The authors have in this monograph studied the genus *Nocardia* in considerable detail, enumerating the various recorded species in tabular form, together with the synonyms which have from time to time been used—in all some ninety-three definite species. Then follow tables giving the chief biological characters of each of the species referred to, whilst in a separate table the authors describe five new species encountered and studied by them in New Guinea. A short synoptical table designed to simplify the identification of an unknown streptothrix completes their work. Apart from the new species described, this compilation will be of considerable value to workers on this micro-organism, the only thing lacking being a comprehensive bibliography. J.E.

MICROSCOPY.

A. Instruments, Accessories, etc.

(3) Illuminating and other Apparatus.

Opacimeter for Standardizing Bacterial Emulsions.—LAMBERT, VLES and DE WATTEVILLE (*C.R. L'Acad. Sci.*, 1919, 168, No. 15, 797-9. Vles has previously suggested that the standardization of a bacterial emulsion might be effected by measuring the loss sustained by a luminous ray in traversing this emulsion. The present writers point out that in the construction of a bacteriological opacimeter certain properties of the emulsions necessitate the use of a monochromatic light with a fixed wave length, whilst bacteriological technique requires the use of absolutely sterile vessels.

Their opacimeter is a photometer made by two luminous rays in juxtaposition. Whilst one traverses the emulsion, the intensity of the

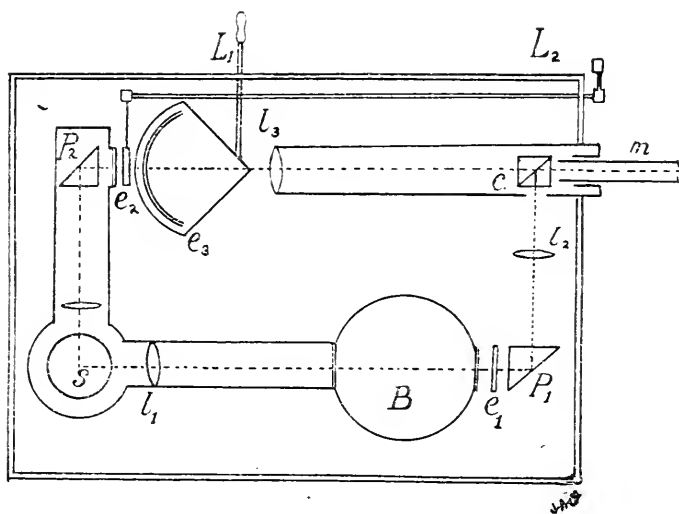

other can be varied at will to enable the two planes of light to be equalized in the observer's ocular field. The most convenient means of weakening the second ray is the use of progressively darkened photographic plates varying from zero to total opacity, previously calibrated by spectrophotometric measurements.

The apparatus (see figure), constructed in 1916 in the Sorbon'Physical Research Laboratory, and used in the French Army at the anti-typhoid vaccination laboratories, was planned as follows:—S is the source, 100-candle power nitrogen lamp in a metal shield which lets the ray

out in two directions at right angles. A lens l_1 throws a number of parallel rays through two windows in the opposite walls of a copper water-tight vessel B filled with water, in which the cylinder of emulsion is immersed. (The water serves to lessen the phenomena of refraction on the surface of this receptacle.) From the exit the rays traverse a coloured screen e_1 ($\lambda = 620 \mu$), are intercepted by a prism of total reflection p_1 and a lense l_2 , and are thrown on to a glass cube c ; this is formed by two rectangular prisms joined at their hypotenuses, one of which, partially silvered, throws the rays on to the microscope m . The other rays, reflected by p_2 and filtered by the coloured screen e_2 , are intercepted by an objective l_3 , and striking through the glass cube at its non-silvered part, come into juxtaposition with the other rays within the ocular field of the microscope. Before crossing the objective l_3 the second rays traverse a progressively darkened photographic plate e_3 . This is mounted on a glass cylinder revolving on its own axis by means of the hand-gear L_1 outside the apparatus. It has a photographic scale dividing the screen into 100 equal parts. The characteristics of the objective l_3 are such that the reflection of these divisions appears at the level of the silvered surface of the glass cube, so that it appears in the ocular field identically with the two planes of light. The observation for the equality of the planes and the reading of the graduations may therefore be done together. In order to get rid of any preconceived ideas when making the reading, a small movable shutter permits of the graduations being shut out at the wish of the operator by means of a hand-gear L_2 .

Under the heading emulsions the authors state that very dilute emulsions should be contained in cylinders, 10 cm. diameter, whilst very concentrated emulsions should be put in glass tubes of $3\frac{1}{2}$ mm. Both receptacles are easily sterilized in the ordinary oven or autoclave.

The authors also describe the method of graduating the screen which weaken the rays, as follows:—The graduation marks of the progressive screen are definite and must be gauged empirically. The gauging consists in constructing a graph connecting these divisions to the characteristic chosen as representing the quantity of bacterial substance in the emulsion—e.g. the dry weight of bacteria per cubic centimetre. The technique is briefly as under:—

The emulsion chosen as type is divided into two portions. One of these, say 80 c.cm., is centrifugalized at 7000 revolutions, the deposit washed with distilled water, re-centrifugalized, dried at 110°C . to constant weight, and weighed. This gives the dry weight p in milligrams per cubic centimetre of the type emulsion. The other part, diluted 2, 3, 4, . . . times, gives a series of derived emulsions whose dry weights are obviously $p/2$, $p/3$, $p/4$ The whole series is submitted to opacimetric measurements. A graph is then constructed having in abscissa the opacimetric measurements of these dilutions, and in ordinate the corresponding dry weights.

It might be useful to make the same experiment with several type emulsions, and to construct a mean curve for the bacterial species under consideration. In conformity with bacteriological usages, it may sometimes be necessary to express the standards, not in dry weights,

but in the "number of bacteria per cubic centimetre." The gauging is done in the same way, except that the dry weights will be replaced by microscopical numberings. It must be noted, however, that owing to the optical properties of the emulsions, the numbers obtained in this case correspond only to fictitious bacteria with a known mean weight or volume, a balance being made—in constant quantities of substance—between the number and size of the elements when these are not identical with those of the type emulsion.

Under the heading of "Opacity Constants" the authors suggest that the measurements may be verified from time to time by the use of opal glasses in sheets of varying thickness. J. E.

B. Technique.

(4) Staining and Injecting.

Note on the New Rapid Staining of Blood and Parasites in Films.—ROGER ARNAUD (*C.R. Soc. Biol.*, 1919, **82**, 208-9). Prepare film in the ordinary manner; do not fix. Place film face downwards in a Laveran-Mesnil box; cover freely with May-Grunwald stain. Cover box to prevent evaporation of the methyl-alcohol. Leave film to stain for 5 minutes, then remove excess of stain, and without washing cover film with a solution of borated blue (Manson), prepared as follows: Put a few drops of the concentrated solution in tube. Add distilled water until the fluid is almost translucent. Use this solution to cover the film. Allow stain to act 40 to 50 seconds. Wash in distilled water. Differentiate in 90 p.c. alcohol. Wash again, dry and examine. Red blood cells are stained violet-black, eosinophile granules deep red; neutrophile granules are clearly visible, as are also the basophile granules. Parasites show light blue protoplasm and deep red nuclei. (Manson's borated-blue is prepared by dissolving 2 grms. of methylene-blue in 100 c.cm. of 5 p.c. solution of borax, prepared with boiling water.) J. E.

(6) Miscellaneous.

Antiseptic Treatment of Wounds.—HIROSHI TSUJI and KAKUGORO TACHIBANA (*Actæ Scholæ Medicinalis, Kioto*, 1918, **11**, 387-97). Working on similar lines to Watson Cheyne, the authors have investigated the action of diffusive germicides upon *Staphylococcus aureus*, *Streptococcus longus*, *Bacillus pyocyaneus*, and *B. coli*, through a stratum of 2 p.c. agar, employing a modification of Edmund's cell. Among the antiseptics examined, cyanocuprol, potassium iodide, tincture of iodine, hydrogen peroxide, carbolic, creosote, and the organic pigments showed a higher diffusibility. All except potassium iodide, hydrogen peroxide, and brilliant green cause a more or less marked precipitation of the albumin in agar. The diffusibility of sublimate was not so weak as, hitherto, generally considered; it diffused in a short time deeper into agar than did alcohol. The iodine in iodo-potassium iodide solution or tincture of iodine precipitated the albumin, whilst the solvents themselves (the iodide of potassium solution and alcohol) affected the agar

very little if at all. Granted that these iodine-containing solutions diffuse deeper than the solvents, then it appears that the latter by the addition of iodine obtain a higher diffusibility. The power of diffusion of alcohol was far weaker than was formerly supposed, at least with respect to coagulation of granular tissues with numerous cells. Dakin and Duret's hypochloride solutions did not have a very penetrating bactericidal effect under these conditions. The members of the phenol group showed, more or less, bactericidal power; carbolic acid was the best antiseptic, as it had less effect on the agar. The organic colouring pigments were remarkably diffusible. Malachite-green was the most diffusible of all, but the authors preferred brilliant green, as the latter hardly ever precipitated the albumin in agar. The diffusibility of most antiseptics was proportional to the power of concentration, but with hydrogen peroxide there was an inverse ratio; the 5 p.c. solution penetrated farther into agar than the 10 p.c. solution. J. E.

METALLOGRAPHY, ETC.

Fusion Welding Applied to Drop Forgings.—S. W. MILLER (*The Iron Age*, July 31, 1919, **104**, No. 5). Oxy-acetylene and electric welds, and their applicability to effective forgings. Effect of high temperatures on physical structure.

Improved Case-hardening Process.—D. HANSON and J. E. HURST (*The Iron Age*, July 17, 1919, **104**, No. 3). Slow cooling of nickel-steel gears for automobile and airplane engines prevents flaking and chipping. Practical results.

Characteristics of Rifle-barrel Steel.—G. F. BUTTERWORTH and A. E. BELLIS (*The Iron Age*, July 24, 1919, **104**, No. 4). Metallography and heat-treatment. Best structure for the best results. Rolled and heat-treated barrels. Factors in erosion.

Synopsis of Recent Chemical and Metallurgical Literature.—*Chemical and Metallurgical Engineering*, July 1, 1919, **21**, No. 1.

Metallography of Aluminium Ingot.—ROBERT J. ANDERSON (*Chemical and Metallurgical Engineering*, Sept. 1, 1919, **21**, No. 5). Study of the microstructure of aluminium ingot. Influence of quality of ingot on the resultant castings. "Differential group-etching," a phenomenon noticed in etching aluminium. Tentative explanation of the differential etching.

Notes on the Influence of Certain Variables associated with the Anneal of Cold-worked Alpha Brass.—ARTHUR PHILLIPS and GEORGE C. GERNER (*Chemical and Metallurgical Engineering*, June 15, 1919, **20**, No. 12). Degree of plastic deformation. Temperature and time of anneal. Rate of heating through the ferminative temperature. Size and uniformity of the grains prior to the plastic deformation. Potential possibilities of rolled metal.

Researches on Bearing Metals.—E. HEYN and O. BAUER (*Metal Industry*, July 4, 1919, **15**, No. 15). Antimony. Lead. Tin. Alloys.

The Properties of Standard or Sterling Silver, with Notes on its Manufacture.—ERNEST A. SMITH and HAROLD TURNER (*Metal Industry*, Oct. 10, 1919, **15**, No. 15).

Season Cracking.—W. H. HATFIELD and G. L. THIRKELL (*Metal Industry*, Oct. 10, 1919, **15**, No. 15).

NOTICES OF NEW BOOKS.

The Living Cycads. By Charles Joseph Chamberlain. Small 8vo, xiv and 172 pp., 91 figs. Chicago: University Press. 1919. Price \$1.50.

This little volume is one of the University of Chicago Science Series, which aims to fill a position between the technical journal with its short articles and the elaborate treatise. The volumes will confine themselves to specific problems of current interest, and will be written not only for the specialist but for the educated layman. The Cycads are a family of special interest to the botanist, representing as they do the survival of a line which may be traced through Mesozoic to Palæozoic times, and the chapters dealing with their occurrence and distribution on the earth's surface at the present day, written in the form of a traveller's tale, should certainly appeal to the educated layman; the later chapters on structure and evolution require some knowledge of botany if they are to be read with profit. The author, Prof. Chamberlain, is eminently fitted for the task of presenting an account of the family. For fifteen years he has been investigating the various genera and species, and has studied them in their native homes in Mexico, Cuba, Australia and Africa. The first part of the volume is an admirable account, illustrated by excellent photographs, of their distribution, method of growth and environment, and provides an object lesson which might well be followed by workers in other groups. Botanists who are inclined to regard the Cycads as a decadent family will learn with some surprise of the frequency of some of the species in their own special locality, as, for instance, *Bowenia*, at Cairns in Queensland, growing in thousands and forming a prominent feature of the scanty Eucalyptus forest. Another Queensland genus, *Macrozamia*, the tallest of the family (*M. Hopei* may reach a height of 60 feet) is also found in considerable numbers. *Microcycas*, on the other hand, confined to Cuba, is represented only by comparatively few individuals of a single species. Though generally insignificant in size, compared with other trees, the Cycads are remarkably long-lived. A *Dioon*, with a trunk not more than 1 foot in diameter and 6 feet in height, may have reached the age of 1000 years. Age is determined not by counting annual rings of growth of wood as in deciduous trees, but by study of the armour of leaf-bases which persist round the trunk, a definite number of leaves being developed in each season of growth.

Part II. is an account of the life-history, and deals successively with vegetative structures, reproductive structures, fertilization, and the

embryo and seedling. The facts presented are based largely on the author's own observation in the field and laboratory.

Part III., on the evolution and phylogeny of the group, is somewhat speculative. In tracing the evolution of the female sporophyll from the vegetative leaf the author has a well-defined series to illustrate his point; but in the brief general discussion of lines of evolution he is compelled to be more vague and is less convincing; he has left the field and the laboratory in which he has worked so successfully.

A. B. R.

PROCEEDINGS OF THE SOCIETY.



AN ORDINARY MEETING

OF THE SOCIETY WAS HELD AT 20 HANOVER SQUARE, W., ON WEDNESDAY, JUNE 18TH, 1919, MR. J. E. BARNARD, PRESIDENT, IN THE CHAIR.

The **Minutes** of the preceding Meeting were read, confirmed, and signed by the President.

The nomination papers were read of three Candidates for Fellowship.

New Fellows.—The following were elected Ordinary Fellows of the Society :—

Mr. William F. Bumsted.
 Mr. Reginald Dunn.
 Mr. John Benbow Garnett.
 Mr. Charles Worthington Hawkesley.
 Mr. Percy Frederick Keen.
 Mr. James Alexander Murray, M.D.
 Mr. John Horsford Seager.

Mr. E. J. Sheppard exhibited 25 slides containing over 300 serial sections of an embryo chick of 72 hours' incubation. The sections were cut longitudinally laterally, complete from eye-spot on the one side to the finish of the eye on the other, and stained. He offered the slides as a donation to the Society's cabinet.

On the motion of the **President** a hearty vote of thanks was accorded to Mr. Sheppard for his valuable contribution.

The thanks of the meeting were accorded to Dr. H. Woodward for the presentation of a Collection of Reprinted Papers.

A letter was read from Miss Booth stating that Miss Sarah Monks, 223 15th Street, San Pedro, California, U.S.A., would like to exchange Diatoms, Seaweeds, etc., with the Fellows of the Society.

Mr. Martin Duncan read a paper "On Acari from the Lung of *Macacus rhesus*," and exhibited slides showing—

General section of lung of *Macacus rhesus* showing Mites in situ.
Vesicle from pleura of lung of *Macacus rhesus* opened to show Mites.

Larva of *Pneumonyssus Griffithi* from the lung of *Macacus rhesus*.

Pneumonyssus Griffithi.

The President moved a hearty vote of thanks to Mr. Martin Duncan for his interesting paper, which would be published in the Journal accompanied by reproductions of photomicrographs.

The vote of thanks was carried by acclamation.

Mr. Scourfield gave an exhibit of Marine Cladocera, and in referring to the same said these forms were remarkable in that they belonged to an essentially freshwater group of animals, the group in fact to which such a typical pond-life organism as *Daphnia* also belonged. There were only three marine genera of Cladocera, viz. *Penilia*, *Podon* and *Evalne*, each represented by a few species, but one other genus, viz. *Bosmina*, which was otherwise entirely freshwater, was represented by one species in the Baltic. *Penilia* belonged to the family Sididæ, represented in fresh water by *Sida crystallina*, etc., and was peculiar in possessing two lateral rostral points instead of the usual median rostrum. The species of the genus were only found in tropical or sub-tropical seas. *Podon* and *Evalne* belonged to the family Polyphemidæ, represented in fresh water by *Polyphemus* and *Bythotrephes*. The first-named was very similar to *Polyphemus*, but *Evalne* was rather peculiar and might be regarded as the most characteristic marine genus of the Cladocera. Both genera were probably world-wide in their distribution. The species of *Bosmina* which occurred in the Baltic—*B. maritima*—was very close to *B. obtusirostris* Lillj., and perhaps was only to be regarded as a variety of that very variable species.

The existence of these few species of Cladocera in the sea opened up the problem of why some forms could live in the sea and closely related forms only in freshwater, and *vice versa*. This, however, was practically

an unsolved problem in spite of the numerous suggestions which had been made on the subject. But it was at least very suggestive to consider in this connexion the remarkable fauna of the Caspian, where quite a number of species and varieties of *Eradne*, together with some other very peculiar Polyphemids, had been recorded by Sars.

The following specimens of Marine Cladocera were exhibited :—

Penilia schmackeri from the Bay of Islands, New Zealand.

Bosmina maritima from the Baltic (Gulf of Bothnia).

Podon intermedius from the English Channel (Plymouth).

Podon polyphemoides from the Baltic.

Podon leuckarti from the Baltic.

Eradne nordmanni from the Baltic.

The thanks of the meeting were accorded to Mr. Scourfield.

Votes of thanks were accorded to Mr. Angus and Mr. Rheinberg for platinising the mirrors of the large lantern, and to Mr. Angus for the loan of microscopes at the meeting.

The business proceedings then terminated.

JOURNAL
OF THE
ROYAL MICROSCOPICAL SOCIETY.

DECEMBER, 1919.

TRANSACTIONS OF THE SOCIETY.

IX.—On *Folliculina boltoni* (S. Kent).

By E. PENARD, Sc.D.

(Read April 16, 1919.)

TWO PLATES.

IN July 1918 I found on the underside of leaves of water-lilies in a pond of the Ariana Park, near Geneva, a Ciliate Infusorian which I thought must undoubtedly belong to the genus *Folliculina*.

Referring to the classical work of Bütschli ("Protozoa," p. 1729), I found, accompanying the diagnosis, the following lines: "Marine. Coasts of Europe and North America (fresh-water also, according to Kent, *Freia boltoni*; however, wants confirmation; Barrett also speaks of having found *Folliculina* in fresh-water)." A little further on, Bütschli says again: "In the neighbourhood of *Folliculina* might also be placed the fresh-water genus *Ascobius (lentus)*, imperfectly described by Henneguy." . . . "In case it were a *Folliculina*, it might be identical with Kent's *F. boltoni*."

Referring then to the original authors, I ascertained that Kent had seen in fact a *Folliculina*, and evidently the same as the one which I had recently found. Barrett simply says that he found, in the Thames at Moulford, his *Stentor barretti* "whilst looking for *Lagotia*,"* which I had found before on weed from the above locality (though Pritchard quotes *Lagotia* as a marine animal)."

Henneguy's description of *Ascobius* is precise enough to make us certain that he had to do with the same species; but the French author only saw retracted specimens. "I never saw," says

* Another name for *Freia* or *Folliculina*.

Henneguy, "the animalcule come out or send a lobe out of the shell . . . and I don't think the fact to be possible, given the narrowness of the aperture and the form of the animal."

We have then three *Folliculinæ* (and all of them very likely *F. boltoni*) spoken of as belonging to fresh-water; and I think we might add a fourth to the list. Zacharias, when treating of *Stentor caruleus*, writes: "On the 10th of October I found a single specimen of this last species, in a flask-shaped cyst (fig. 12), which had an aperture at the elongated anterior end. The cyst itself, as well as the animalcule, was of a pale bluish colour. There was no kind of stopper nor any operculum at the aperture of the cyst." Now according to this description, and also to the figure, Zacharias had very likely seen *F. boltoni*.

I was therefore rather astonished upon ascertaining quite recently that all the previous statements about a fresh-water type were considered due to defective observations. "The genus *Folliculina* is not represented in fresh-water," says Sahrlage ("Arch. f. Protistenkunde," vol. 37, fasc. 2, p. 144, 1916), and further, p. 145: "Kent claims to have found *F. boltoni* in fresh-water; a very doubtful species"; further still: "*F. boltoni* . . . can hardly be recognized as belonging here; more likely it is a badly observed *Vaginicola*, whose shell, according to Kent himself, is just the same. The same might be said of the 'shell-inhabiting Stentors' of Barrett, so that in fact only marine *Folliculinæ* are known to have been found to this day."

Now these rather surprising statements, as well as some others of a different nature, which went against what I had seen, induced me to a further study. Although it was now the 12th of December the pond was not frozen over, and a few leaves of the water-lilies were still floating about, from the under-surfaces of which a sufficient number of *Folliculinæ*, in perfect condition, were gathered for study.

The following pages are the result of these December observations, which, in fact, were protracted to the 15th of January so far as a few specimens were concerned.

But before going into the subject, I wish to emphasize the fact that all my observations have been made on isolated animals, kept under the cover-glass in excavated slides. This method of study cannot be too highly recommended, for it allows of facts, which might otherwise remain doubtful, being established with certainty. Wright, for instance, and also Claparède and Lachmann, supposed that certain vermiform bodies which they had seen swimming about might represent a larval form of *F. elegans*. Later on, these same vermiform bodies were several times met with, and finally described by Daday as *Lagynus ocellatus*. Sahrlage considers them still as representing an independent genus; but if the specimens had been observed after isolation in a drop of clear

water, Wright, as well as Claparède and Lachmann, would have been able to present their statement not as a possibility, but as an undeniable reality.

GENERAL CHARACTERS.

The genus *Folliculina* is characterized by the possession of a shell which, in *F. boltoni*, measures about 200 μ in length, is pyriform in shape, and at the same time very much compressed dorso-ventrally. It looks very nearly the same as the shell of *Vaginicola longicollis*, and, like this latter, adheres very firmly to the substratum. The anterior part is somewhat elevated in a neck-like prolongation, and opens in a circular aperture (fig. 6). This shell, which has been generally described as chitinous, is in reality quite different from that of *Vaginicola*, and rather might be considered as consisting of hardened mucilage. We shall later on refer again to the structure of the shell, and also to the cause of its coloration, which is of a bluish bottle-green like the body itself.

The animalcule, which hardly fills more than half the shell, differs very much in appearance when seen in a state of expansion (figs. 1, 4, 5, 7), or retracted (fig. 8). Completely expanded, the body is fusiform, attached to the bottom of the shell by its posterior extremity, while anteriorly it stretches in a very extensible neck-like prolongation, and finally expands in two long wings or lobes, whose rim carries the peristomial wreath.

The particular structure of the peristome in *Folliculina*, and the course of the adoral line along the lobes and inside the "vestibulum" have been the subject of many investigations. Claparède and Lachmann, Stein, Möbius did their best to understand its complexities. More recently Sahlrøge has done the same in a more exhaustive study (p. 153-155), and I would refer those interested to his work for details, satisfying myself with reproducing here the lines which Delage ("Traité de Zoologie," p. 463) devotes to the subject:—

"*Folliculina* (Lamarck) may be considered as being derived from a *Stentor* whose pseudostome would be developed into two lateral, very extended wings, whilst the medial anterior and posterior parts would have remained at the same level. The result is that the peristome has acquired the form of a deep funnel, split anteriorly and behind. The adoral zone follows the free border all along, begins anteriorly, continues along the free border of the right wing, descends to the base of the posterior sinus (less deep than the anterior), ascends along the left wing, and finally descends towards the original point of departure; but, instead of joining it, it plunges spirally into the buccal vestibulum, where it describes one and a half turns, and finally enters the mouth."

There are a few points, however, on which I would insist a little more at length. The "wings," or peristomial lobes, are in our species very unequal in length, and Kent describes them as such in the following terms: "Peristome lobes rounded, of unequal size; one of these, usually the left, attaining twice the dimensions of the other." Does this inequality in length really concern now one of the lobes, now the other, and more generally the left, as Kent supposes? Unfortunately my observations on the subject have been very few and the results uncertain, owing to the difficulty of deciding among the crossing lines; but in my notes I find four sketches in which the longer lobe seems to be the right, and two where the left seems the longer.

The study of the peristome is also rendered difficult by the very variable aspect of the lobes; they may be but incompletely expanded, or one of them only attains its full length; now they are more or less retracted, and now so fully expanded that the border falls back behind, etc.

Very often one of the lobes, more generally the larger, does not look rounded at the summit, but terminates in a sharp point (figs. 2, 3), which results from the fact that *F. boltoni*—like Wright's *F. stylifera*—is provided with a special appendage, a median crest which runs along the dorsal surface of the lobe, and is extremely contractile. When the contracted animalcule begins expanding, this special appendage is always in an advanced position (fig. 3), as if exploring the vicinity. When the lobe is fully expanded, the appendage usually disappears, though frequently leaving, just behind the summit of the lobe, a faint knob. Very often, however, it remains a long time in sight, like a triangle crowning the summit of the expanded lobe (fig. 3).

This special appendage seems at first sight to belong only to the larger lobe, but the smaller one is in fact provided with it, and sometimes shows a very distinct prolongation. In one specimen, for instance, where the neck of the shell had been accidentally compressed and did not allow of any expansion outside, but where

DESCRIPTION OF PLATE I.

Folliculina boltoni.

- Fig. 1.—Animal expanded; the shell (somewhat abnormal) seen nearly from the side.
 ,, 2.—One of the lobes of the peristome, seen from the side, with the protractile appendage at the top.
 ,, 3.—One of the lobes seen from the front, with the triangular protractile appendage.
 ,, 4.—An individual in its shell, expanded.
 ,, 5.—Another, seen from the side, but the shell seen from the front (owing to some contortion of the animal).
 ,, 6.—The shell seen from the side.
 ,, 7.—An expanded individual, found free from its shell.

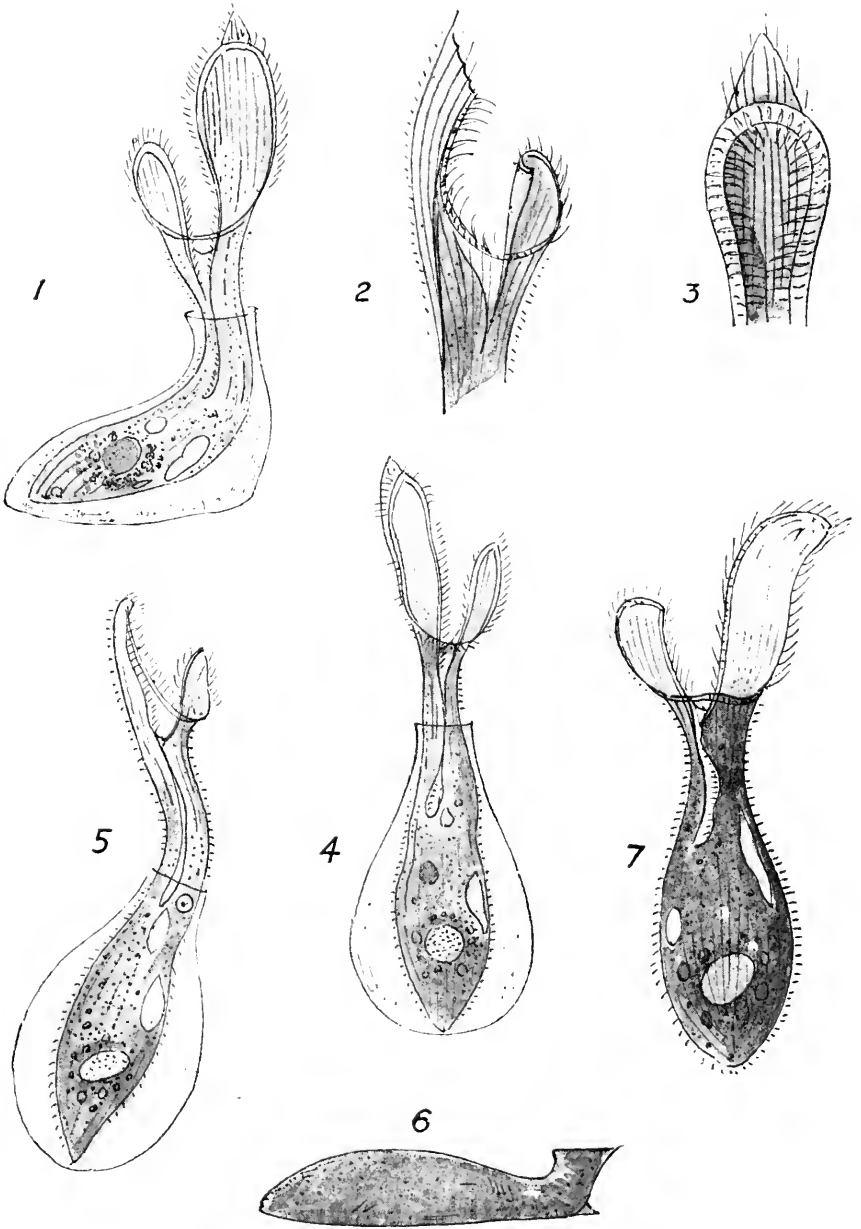

at the same time the dorsal wall of the shell had been partially broken and opened, two long pointed appendages were to be seen, one pointing to the mouth and one to the accidentally opened passage at the back; and this latter prolongation was the longer of the two, though belonging to the smaller of the lobes.

The vibratile elements which run along the peristome are not cilia, but membranellæ, or what we might with Möbius call *pectinellæ*, each of them consisting of half-a-dozen cilia. These small groups of cilia are compressed into a lamina, whose basis marks a transverse line on the peristome border, and these parallel rod-like transverse lines give to the peristome border a special scalariform appearance.

The *pectinellæ*, singly considered, possess at times an independent activity. They may vibrate in one region of the peristome and not in another; but at other times all the *pectinellæ* are seen moving together, or the whole of them are turned from right to left or from left to right; this is, for instance, what happens when the lobe expands. As long as it was still inside the shell, all the *pectinellæ* were facing towards the median line of the lobe, which had the appearance of a horseshoe with inside denticulations (fig. 3); but as soon as the lobe is expanded, the entire row of teeth rapidly turns outside, describing an arc of 180° , with the result that the horseshoe has all its teeth pointing towards the exterior (fig. 1). At the same time it looks as if the *pectinellæ* had grown much longer; perhaps, when looking towards the concavity of the lobe, they were more or less curled downwards.

The peristomial furrow, beginning on one side at the base of the funnel, runs along the whole border of the lobes, descends to the funnel again, and plunges into the vestibulum, reaching as far as the mouth at the bottom of the vestibulum itself; but the more it descends the thinner are the *pectinellæ*, and at last we find nothing but ordinary cilia. These, however, do not lose their activity, but on the contrary show more rapid vibrations, and near the bottom of the vestibulum the movements are so quick that one might be tempted to see there an undulating membrane.

The body of *Folliculina* is covered all over with cilia, disposed along longitudinal grooves or striæ (about $2\frac{1}{2}\mu$ distant from each other), which can be followed from the tip of the lobes to the posterior extremity. When seen along the line of its longitudinal axis, i.e. from above, the circular border of the body proves to be crenulated, with the cilia arising from the grooves. Very likely *Folliculina* is furnished with longitudinal myonemes, and the remarkable contractility of the body seems to confirm this, although I could not satisfy myself of their existence.

The cilia, as a rule, hardly seem to deserve their name, for they either do not move at all or their movements are very weak and slow, and moreover they are very indistinct; one might think

they were atrophied, but such is not the case, as they prove distinct and active enough as soon as need be.

So far we have considered *Folliculina* in its expanded condition; but more often the animalcule is found retracted in its shell (fig. 8). When the lobes contract, they fold and become hardly recognizable, so that one cannot wonder at *Folliculina* having been taken by Henneguy for a special genus and by Zacharias for a *Stentor* in its cyst, or by others as something quite different from what it is in reality.

Like the marine *Folliculina elegans*, our fresh-water species is coloured a pale blue, or rather we might say a bluish-green or a greenish-blue, and the colour is due to very small grains or concretions. According to my observations, the origin of these grains would be as follows: Vacuoles are first formed whose content is a clear blue fluid, and by-and-by small darker granulations appear in the liquid itself, true concretions in fact, which are deposited in greater and greater numbers, and at last fill up the entire vacuole. This latter then loses its wall, and the grains disseminate in the adjoining plasma. From time to time one of these large vacuoles with its dark concretions is seen to move slowly towards the anterior part of the body, and after several hours its contents are suddenly expelled by the anal pore, which is situated near the base of one of the lobes, and opens, not inside the vestibulum, but outside into the water.

The coloured matter when in great abundance can also very likely be expelled by a simple opening in the posterior extremity of the body; lumps of green matter are very often seen lying in the space between the shell and the body, and when the animalcule leaves its envelope to build another somewhere else, it always leaves behind in the old case a large quantity of green refuse.

These granulations must be considered as a product of excretion, useless and perhaps noxious in themselves, though at the same time they are an indication of the state of health of the animal, for the more it is coloured the more healthy it is; in fact, to be in a perfect state, the animalcule must be able to produce an abundant quantity of secretional matter. When very weak, or in a state of illness, the body gets pale and hardly furnishes any appreciable quantity of green substance. Absolute alcohol discolours these grains, but apparently without dissolving them.

The envelope or shell is quite colourless when recently formed, but acquires later the bluish hue which is characteristic of the animal; but I cannot agree with Sahlrøge, who attributes the coloration in this case to small grains. It is quite true that the shell is always more or less covered with particles of various kinds; but the coloration of these, as well as of the shell itself, is in my opinion rather due to a diffusion of colour from the animal acting like a "mordant" on such objects in the vicinity which are apt to

take it. Several of my observations seem at any rate to prove the fact; for instance, the following: One animalcule which I had met with, quite deprived of an envelope, and which remained a whole week isolated in a drop of water, became rapidly surrounded by a growth of cryptogamic vegetation, bacteria, organic particles of all sorts, etc., which in the vicinity of the posterior part of the body turned eventually to a bluish hue.

As for the distribution of the coloured matter inside the body there is no general rule, but usually the accumulation is more dense behind, and even more around the nucleus, which then looks a large clear spot surrounded by a dark green frame.

The nucleus is spherical or ovoid. At first sight it looks a homogeneous pale grey, but under slight compression it is seen to contain numerous spherical nucleoli, which are more intensely coloured by carmine. Around the nucleus are a few micronuclei, three or four as a rule, which are hardly to be distinguished except in particularly favourable conditions.

Usually the nucleus is single; sometimes, however, there are two, united in the shape of an 8; more rarely the single nucleus is deeply fissured on one side, as if resulting from a partial fusion of two nuclei into one.

Though several observers have indicated a contractile vesicle in the genus *Folliculina*, it may be considered as certain that the statement has always been due to a confusion with ordinary vacuoles, or with the nucleus itself, which looks a bright roundish spot on the dark surrounding ground. Sahlrøge could never find any, and says: "In fact there is none (if as a rule its existence is not to be denied in the marine protozoa)." My own investigations were not more successful; in *Folliculina boltoni* there is no true contractile vesicle, and the fact itself is interesting, in reference to the marine origin of the genus; one must imagine an adaptation to fresh-water without the acquisition as yet of that very characteristic feature of fresh-water animalcules.*

But if a true contractile vesicle does not exist, there is certainly something that might be considered as taking its place and function. Around the nucleus there are commonly to be seen numerous vacuoles, which appear and disappear at times, and, being quite rounded and sharply delineated, look different from ordinary vacuoles. But more important still are much larger vacuoles, "lacunæ," which grow bigger and bigger, sometimes uniting in large spaces which only the ectoplasmic layer separates from the exterior. Sometimes they disappear after having been a very long time growing; and sometimes they enlarge to such proportions that the animalcule itself looks like a bag in which the plasma

* A contractile vesicle is to be found, however, in numerous marine *Ciliata* and, perhaps even more, *Tentaculifera*.

appears suspended. These big vacuoles may be looked at for hours without their disappearing, but they are seen to get slowly bigger, or to coalesce with others. Some of my observations seem to prove that their functions might be those of a contractile vesicle, for on three different occasions I have seen them bursting, and the wounded place immediately closing.

TRANSFORMATION INTO A SWIMMING STATE.

In introducing the subject concerning division in *Folliculina*, Sahlrøge devotes a few pages to the discussion of some phenomena which have been mentioned, or rather guessed at, by several observers, and which would presuppose a voluntary abandonment of the shell; and it seems worth while to reproduce here the lines of the German author:—

“Wright claims to have observed the multiplication of his *Lagotia producta* by means of ciliate vermiform larvæ, which were swimming about, continually revolving on their long axis, but no clue could in fact be obtained about the origin of these larvæ. He describes how these vermiform larvæ stretch, become pointed behind, flatten anteriorly, and during the night (!), swimming at the surface of the water (?), secrete an envelope, and in three to four days also form the lobes of the peristome. All these statements are more than doubtful, the more so that the English investigation of Infusoria was at that time largely ‘dilettantisch,’ and rather considered as a scientific sport. Stein already doubts the statements of Wright, tries to explain them by careless observations, and supposes that the ‘larvæ’ were ordinary individuals in a young state, which had left their shells (?), or old animals which had been detached from their envelope on the bottom of the aquarium. When Stein further adds that he had not infrequently seen, in the water of his vessels in which were kept weeds with envelopes of *Folliculina*, specimens which were swimming about and had left their shells, I must on the ground of my experiences consider the statement as rather doubtful. . . .”

“Claparède and Lachmann claim also to have observed *Freia elegans* in its swimming young form. It resembles Wright’s larvæ, is able to contract into a sphere, swims ‘avec grande vivacité,’ and is about 85 μ in length. No mouth could be observed, but a black ocular spot (!) at the anterior part of the body; the nucleus was oval in shape. Lachmann was in one (!) case witness of a fixation on algæ, after which the pigment-spot dissolved, and at the anterior end a membranous extension appeared, which I should be disposed to consider as moribund phenomena. Claparède and Lachmann supposed also a subsequent formation of a shell, but unluckily the specimen concerned was lost sight of! At the same time, and

according to their own statement, the same Infusorian, which they give as a young form of *Freia elegans*, had been previously observed by Lieberkühn and by Wagner at Wismar on the Baltic, without these authors seeing in it any relation to *Folliculina*. Later on Daday described it from the Gulf of Naples under the name of '*Lagynus ocellatus*,' and regarded it as a peculiar species close to *Lacrymaria*, yet without leaving out of account the 'interesting thought' of some relation in origin with the genus *Folliculina*. Levander more recently saw it again in the Baltic, found the nucleus most of the time oval, but also more rarely chaplet-like with five beads, without perceiving, however, any new argument for a relation with *Folliculina*, which relation he considers as very improbable in itself. And yet the mistake has continued to our own time. . . ."

There was no mistake in fact! The transformation is certain, and must even be considered as of frequent occurrence. I was able to observe it on three separate occasions, and each time on specimens which had been isolated on excavated slides, and had subsequently left their envelope behind, two of them on the third and fourth day, and the last after thirteen days.

The first indication of the transformation is the retraction of the lobes; the whole of the peristome apparatus grows more and more indistinct, the vestibulum disappears, and finally no trace is left of any structure. The animalcule has now got the shape of a rather elongated egg, which rests with its posterior extremity at the bottom of the shell.*

The anterior extremity looks at first quite smooth, but very soon there appears a terminal crown of cilia, or rather pectinellæ, which moving slowly at first gradually become more and more active. At the same time, the ordinary cilia, which cover the whole body, become more and more distinct, and at last move rapidly.

The animalcule is now ready for leaving the shell, and it may be certain that here, as in other Ciliates (*Cothurnia*, etc.), its exit is very quick, though I was never able to verify the fact, being always absent at the time, and only finding on my return an empty shell with a cluster of green matter left at the bottom, and at some distance the former tenant swimming about rapidly.

The little vermiform being (fig. 10), about 160 μ in length when fully extended, and 40 μ in breadth, bears an anterior vibratile crown, and, along the body, lines of cilia which move rapidly, and are much more efficient than the crown as a means of locomotion.

* The transformation inside the body is very difficult to follow. I was best able to distinguish the details in a specimen (fig. 7) that was found on December 30 quite naked among the "débris." Up to January 4 it remained quite healthy and with expanded lobes, but on that day began reabsorbing its peristome. The vestibulum remained a long time in sight (fig. 9), like a pale narrow scalariform ribbon, due to the remnants of the nearly vanished cilia. Reabsorption of all parts of the structure seemed to take place simultaneously.

The crown itself consists of pectinellæ, disposed in a circle (or perhaps in a spiral, describing a single turn), and set in a furrow quite near the border of the truncated extremity of the animalcule. Inside this annular furrow the peristome field projects in the shape of a flattened disc; and this, with the surrounding border of the furrow, is coloured a dark emerald green, nearly black when seen under a low power. This dark extremity represents the "ocular spot" observed in some marine *Folliculina*. In reality the cause of the coloration is a particularly dense accumulation of those very small particles which have been spoken of as secreted by the cytoplasm.

The rapid swimming of the larvæ may be continued for a very long time, in fact in each case it lasted about thirty hours. After that the little creature looks weak and sluggish, and moves more and more slowly; its form becomes changed, more like a flask with elongated neck; and at last it rests, flattens on the substratum, broadening into an oval shape. It remains a long time unchanged; there is no movement, and the cilia half disappear from sight; the pectinellæ which formed the crown disintegrate; everything seems dead.

But life is not extinct. After a time of rest which may last for hours, the animalcule contracts, and the extreme limit which it had delineated when flattened remains visible, like a very thin pellicle encircling at some distance the newly acquired contour of the animal (fig. 11). This pellicle is the new envelope. It is as if the *Folliculina* when at rest after its long course had exuded a kind of varnish which hardened at once and remained where formed.

The retraction inside the newly formed pellicle is, however, not effected at the same moment in all parts of the body; the "head," or crown-bearing anterior part, remains behind for a time (fig. 11). Then the crown itself is seen to collapse, the pectinellæ

DESCRIPTION OF PLATE II.

Folliculina boltoni.

- Fig. 8.—A retracted individual in its shell.
 ,, 9.—A specimen in course of transformation to the state of vermiform larva (the same as fig. 7, a few days later).
 ,, 10.—The vermiform, free-swimming larva.
 ,, 11.—First stage of the transformation into a fixed individual and first indication of a shell.
 ,, 12.—A more advanced stage.
 ,, 13.—Details of the anterior part of the body at a somewhat more advanced stage.
 ,, 14.—A still more advanced stage, with distinct indication of a peristome.
 ,, 15.—A further more advanced stage, in which the typical form of a (retracted) *Folliculina* is beginning to appear.
 ,, 16.—A specimen without any shell, contracted.
 ,, 17.—Division; the two individuals already separated, the young one, previous to its liberation from the shell, oval; the old one somewhat cylindrical, with a new peristome already forming.

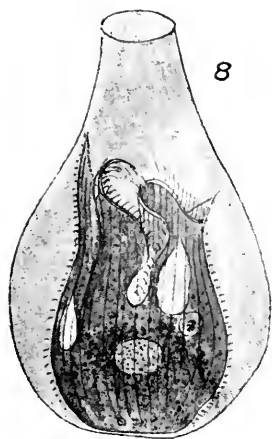

8

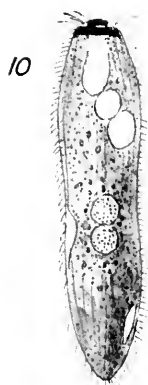

10

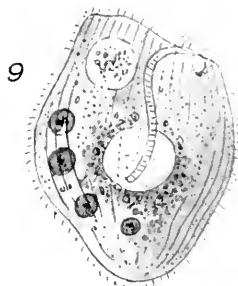

9

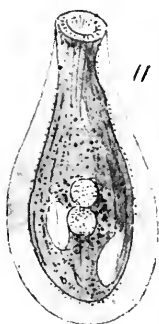

11

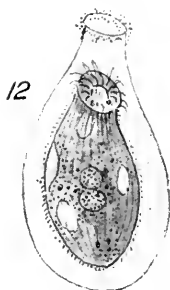

12

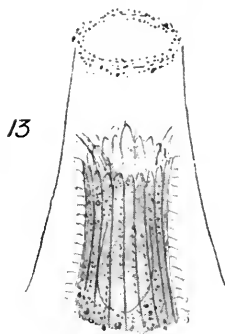

13

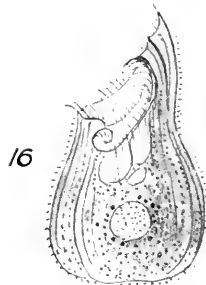

16

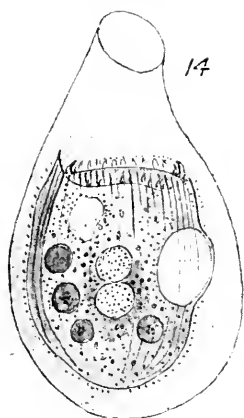

14

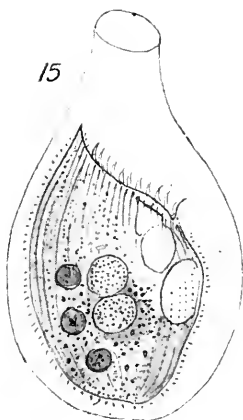

15

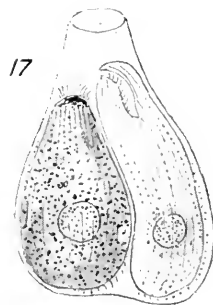

17

disappear, and a pale ring is left, which appears greenish from the amount of coloured particles left there, and from the border of the ring are seen, diverging right and left, the two lines of the new envelope; later on, the ring itself hardens and becomes the aperture of the shell.

Later still the animalcule shows the beginnings of a more complete organization (fig. 12). The first indication of the peristome appears as a simple swollen ring bearing cross-striae where feeble cilia are seen lazily vibrating. The swelling of the ring seems to be due to an invagination of the border, but after a time the invaginated parts turn out again. The ring is then no longer swollen, but appears as a serrated circle, where one of the teeth is larger than any other. This will afterwards grow into the special crest or tactile appendage of the larger lobe. The pectinellæ, few in number and still very weak, are distributed in a ring a little inside the serrated border (fig. 13).

Occasionally the anterior part of the animalcule, or, more rarely, the whole body, suddenly retracts, to lengthen very quickly again; and these sudden retractions, and some weak vibrations among the pectinellæ or along the cilia which still invest the body, are the only indications of life.

About fifteen hours later, we find a change again (fig. 14): the animalcule has now contracted, and its anterior extremity is broadly truncated at right angles to the long axis of the body, while around the truncated end runs a circular furrow, bordered by a crown of pectinellæ of peculiar appearance, looking rather like thick, short tongs firmly united together, so that the whole ring has more or less the appearance of a single undulating membrane, whose undulations follow each other like slow flames running along the ring. On one side the tactile appendage is already conspicuous, and contracts or expands alternately.

A few hours more and the animalcule shows something approaching the normal form of a retracted *Folliculina*. The broad anterior field with its circular furrow has sunk down on one side, whilst the tactile appendage has been raised on the other; the interior of the peristome-ring begins to be hollow, and along the sinking surface new lines of pectinellæ appear (fig. 15).

From that moment the development becomes more and more complicated; the peristome border lengthens, the lobes appear, and the vestibulum sinks lower down. But my observations from this point are very incomplete; circumstances did not allow of at least an hourly examination. And besides, two of the observed specimens never reached the adult state; the third attained it, however, and lived ten days more, showing during the first seven days fully expanded lobes.

This last specimen had gone through its entire evolution, such as just described, in the space of thirty hours, whilst the two former

had taken three days. Its shell, also, though still thin compared with a normal one, was stronger and thicker than in the two other cases, where from beginning to end it had remained a thin pellicle. And if I take into consideration two more individuals, born as swimming larvæ from an act of division, but perfectly similar to those produced by transformation, and which developed up to the construction of a very thin and inadequate shell, I think we can infer as a general rule that specimens isolated under the cover are not to be expected to build a perfect envelope. In my opinion this is because their swimming state lasts too long; they look in vain for a vegetal support and swim to the last before settling down on the slide. Under natural conditions they very likely settle down after a much shorter time; the number of empty, but quite fresh-looking shells which are found in the gatherings is such that one might expect to find a good number of swimming larvæ also, but these are in fact exceedingly rare. This however might easily be explained by a very short swimming period. If that period is lengthened, one might suppose that the special secretion, already prepared when leaving the old shell, and which represents the material for the new one, had been gradually lost.

Such is, as far as I could observe it, the course of events in the total transformation of *Folliculina*. Some minor facts concerning the vacuoles or lacunæ, the nucleus, which generally becomes temporarily longer and often double, the coloured grains, etc., might be referred to; I will only add a few words concerning the possibility of conjugation.

Sahlrøge, on page 169 of his work, writes as follows: "The process of conjugation would presuppose the existence of free-swimming adult *Folliculina*, which however have not yet been proved by any observer to exist." Now we have seen that such *Folliculina* do exist, and the possibility of conjugation is therefore no longer in doubt, though I have never seen any indication of the fact.

ADULT STATE WITHOUT A SHELL.

Much more frequently than vermiform larvæ are found naked specimens possessing the general characters of the shell-bearing type, and provided with lobes and a well-developed peristome. So far as can be inferred from their general appearance, it is probable that these specimens have been accidentally dislodged from their shells; perhaps, also, some of them may have been incited by abnormal circumstances to leave their envelope suddenly, without preparing for a swimming vermiform state. These specimens are mostly found retracted (fig. 16), often wounded or lacerated; when transferred to the slide in clear water they may live for days, but hardly ever depart from their retracted condition. In one case,

however, one of these individuals (fig. 7) allowed of more interesting observations; the lobes expanded, and the animalcule remained three days in perfect health; on the fourth, the peristome began to be reabsorbed, the animalcule retracted into an ovoid shape, lengthened into a ciliate vermiform larva, and swam away. On the following morning I found the animal at rest, with a half-expanded peristome and a relatively strong, thick shell, but abnormally constructed and without any neck. It lived four days more, with fully expanded lobes. This particular individual, we must observe, had only been swimming for a relatively short time, less than one night, and had been very quick in its ultimate transformation. This fact seems to corroborate the suppositions already made with regard to the production of a new shell.

DIVISION.

Sahlrage devotes a long chapter to the phenomena of division, which he was able to study at length and on a good many individuals. My own observations are few, and in fact have concerned but two specimens; but whilst confirming in all important particulars those of the German observer, they are such as to necessitate a few lines at least on the subject. Of the two specimens observed, one in fact counts for very little: the whole process of the division had been effected during the night, and in the morning I found, inside the primitive envelope, a normal individual, but smaller than it was the day before, and in the neighbourhood a vermiform ciliate, identical with those vermiform larvæ which have just been spoken of. The second specimen proved more interesting. On the 23rd of December, at 9 a.m., I met with a *Folliculina* (fig. 17) whose shell contained two individuals; it was clearly a case of division already terminated. One of them, the old one, still affixed to the bottom of the shell, was of a somewhat cylindrical shape, recurved, very pale, and already provided with a newly formed peristome in its early stage, without as yet any indication of lobes. The other, the young one, much darker in colour and into which most of the green matter seemed to have emigrated, was oval in shape, and already bore at its anterior end the characteristic crown of pectinellæ. At 11.30, it left the shell, with the typical form of the vermiform larva, and swam about rapidly the whole afternoon; on the 24th, at 6 a.m., it was still moving, though very slowly; at 9 a.m. it came to rest. On the 25th, at 9 a.m., the animalcule was found provided with a shell, and expanded its lobes; and in this state it remained up to the 28th of the month, but died on the 29th. The old one, which had been left in the old shell, remained living till the 31st of December.

CONCLUDING REMARKS.

If we now briefly recapitulate the results that have been obtained, we may sum them up as follows:—

1. The genus *Folliculina* is undoubtedly represented in fresh-water.

2. The vermiform bodies which had been supposed to represent a young state of *Folliculina* are indeed young *Folliculina*, born from an act of division, or may represent a free-swimming form acquired by the animalcule after a metamorphosis of the whole individual.

3. Daday's *Lagynus ocellatus* must disappear, as representing this vermiform state of *Folliculina*.

A few words might yet be added, about a fact concerning another Infusorian, but on which some light may be afforded by the results obtained on *Folliculina*. Claparède and Lachmann, in their "Études sur les Infusoires," 1860-61 p.191, pl. ix, figs. 7 and 8, have figured spherical or ovoid bodies which they consider as representing very young stages in the life of *Stentor polymorphus*. Bütschli (p. 1731), after examination of these and comparison with some more sketches in Lieberkühn's unpublished plates, and considering from his own observations that the Stentorean theory could not hold its ground, created for them a new name and a new family, the *Lieberkühnina*, a family without described species or genera, whose rather disconcerting diagnosis he gives in the following terms: "Moderately large, nearly spherical bodies with peristome-field rounded, equally or flattened, and a rather thick or, on the contrary, rather thin covering of cilia. Sometimes on the ventral side, either in advance of the posterior part of the body or nearer the anterior extremity, is a diagonal line of stronger cilia, like the posterior cirrhi of the Hypotrichous Infusorians. The peristome-field seems to be sometimes ciliated and sometimes naked; it is generally distinctly striated, like *Stentor*. Contractile vacuole on the left side of the body; macronucleus elliptical. Fresh-water."

Now in the course of my studies on Infusoria I have often met with representatives of Bütschli's *Lieberkühnina*. They are commonly to be found, a few days after collecting, in the gatherings where *Stentor* is in large numbers, and very variable in outward structure, more or less covered with cilia, with a partly developed peristome or no peristome at all, nucleate or without any nucleus, large or small, and some of them so perfect in all their organs that they certainly bear all the characters of defined specific types. After a long acquaintance with these little beings, however, I had finally come to the conclusion that they were neither distinct species nor precisely young stages of *Stentors*, but simply fragments

detached from the same, and which owing to an exceptional faculty of regeneration had soon acquired the normal appearance of Infusoria (some of them, indeed, provided with a portion at least of the former nucleus, would perhaps develop into a normal *Stentor*); and now these conclusions would seem to be confirmed by the facts acquired about *Folliculina*. If we keep in mind the remarkable faculties of this latter organism, which entirely re-absorbs its exterior structure to grow into a quite different being, and then regenerates again into a new dissimilar type; if at the same time we take into account the very near relation existing between *Folliculina* and *Stentor*—we are undoubtedly entitled to consider Bütschli's *Licberkühnina* as having no objective existence as a separate family.

BIBLIOGRAPHY.

- BARRETT, C. A.—On a New Tube-dwelling *Stentor*. Monthly Micr. Journ., iii. (1870).
- BÜTSCHLI, O.—Protozoa. Bronns Kl. u. Ord. Infusoria (1887-9).
- CLAPARÈDE, E., & J. LACHMANN.—Études sur les Infusoires et les Rhizopodes. Mém. Inst. Nat. Genevois (1858-61).
- HENNEGUY, L. F.—Note sur un nouvel Infusoire cilié (*Ascobius lentus*). Arch. de Zool. expér. et gén. (2) ii. (1884).
- KENT, W. S.—A Manual of the Infusoria. London, 1880-2.
- SAHRLAGE, H.—Ueber die Organisation und den Teilungsvorgang des Flaschentierchens (*Folliculina ampulla*). Arch. f. Protistenkunde, Bd 37, Heft 2 (1916).
- WRIGHT, S.—Description of New Protozoa. Edinb. n. Philos. Journ., vii. (1858); x. (1859).
- ZACHARIAS, O.—Faunistische Mittheilungen. Forschungsber. d. Biol. Stat. Plön, Bd. 1 (1893).

X.—*Note on Cajal's Formalin-Silver Nitrate Impregnation Method for the Golgi Apparatus.*

By H. M. CARLETON, B.A., Demonstrator in Histology, and
Christopher Welch Scholar, University of Oxford.
(From the Department of Physiology.)

(Read November 19, 1919.)

WITH THREE TEXT-FIGURES.

1. SILVER IMPREGNATION IN GENERAL.

By impregnation is usually meant the deposition of metallic salts in tissues. In its simplest form small pieces of tissue are treated with the salt in watery solution (e.g. silver nitrate), after which the metallic component of the salt is reduced as a coloured compound by the action of light. And owing to differences in the degree of affinity of various tissue elements for the metallic salt, such an impregnation is often differential. Thus the above method, originally introduced by Von Recklinghausen (10)* in 1860, impregnates the inter-cellular substance of endothelial cells, etc., black. Such crude methods, however, soon gave way (except for special purposes) to others more precise. Thus it was found that fixation before the silver bath increased the selectivity of the metal for certain tissue constituents by acting in respect of these as a mordant. The methods of Golgi (6) for the impregnation of axis-cylinders and dendrites of the central nervous system are examples of this. Finally, the so-called photographic methods came into vogue for certain purposes. In these the tissues undergo:—1. *Fixation*. 2. *Impregnation* with the silver-salt in solution. 3. *Reduction* of the same, usually by means of a modified photographic developer. 4. *Toning* by immersion in a solution of gold chloride, thereby inducing a partial substitution of the latter metal for the silver. Frequently sodium hyposulphite is added to the toning bath with a view to dissolving any unreduced silver.

The Cajal methods for neurofibrils (3), and the Golgi (7) and Cajal impregnations for the Golgi apparatus, embody the above processes.

The differences between impregnation and staining are often

* The italic figures within brackets refer to the Bibliography at end of the paper.

emphasized by pointing out that the former involves an opaque deposit of a metallic compound *around* tissue elements, whereas in staining the dye is *absorbed* by these, so that they retain more or less their transparency. But, as pointed out by Lee (3), successful impregnations frequently show all the gradations between the two extremes. Thus in preparations by Cajal's method of the Golgi apparatus the latter may be impregnated black, while the ground cytoplasm is stained yellow.

2. TECHNIQUE OF CAJAL'S METHOD FOR THE GOLGI APPARATUS.

This process was first introduced in its present form by Cajal in 1912 (2). The following notes have been extracted from that author's most recent account of his technique accessible to me (1):—

1. *Fixation*.—Pieces of tissue are thrown into—

Formol (40 p.c.)	15 c.cm.
Aq. dest.	85 „
Uranium nitrate	1 grm.

Material remains in this for ten to fourteen hours. For the fixation of large masses of tissue Cajal advises a preliminary injection with the fixative before immersion.

For the central nervous system, or for tissues difficult to impregnate, fix in—

Absolute ethyl or methyl alcohol	30 c.cm.
Aq. dest.	80 „
Formol (40 p.c.)	15-20 „
Uranium nitrate	1 grm.

2. Wash rapidly in distilled water—a few seconds will suffice.

3. Impregnate with a 1.5 p.c. solution of silver nitrate for thirty-six to forty-eight hours at room temperature.

4. Wash rapidly in distilled water.

5. Reduce for from eight to twenty-four hours in the following fluid:—

Hydroquinone	1-2 grm.
Formol (40 p.c.)	15 c.cm.
Aq. dest.	100 „
Sodium sulphite	0.5 grm.

The addition of the Na_2SO_3 causes the solution to go pale yellow.

6. Wash in water, dehydrate in ascending grades of alcohol, and embed in either paraffin or celloidin; or sections may be cut with the freezing microtome. But the paraffin method is the most satisfactory for general purposes.

7. Sections on the slide may be toned if necessary, the process

being controlled with the microscope. In his later paper Cajal apparently omits toning, which is usually unnecessary. Should it be indicated, use equal parts of solutions A. and B. :—

A.	Sodium hyposulphite	3	gram.
	Ammonium sulphocyanate	3	"
	Aq. dest.	100	c.cm
B.	Gold chloride	1	gram.
	Aq. dest.	99	c.cm.

If desired, the sections may be counterstained with Ehrlich's hæmatoxylin, methylen-blue, or safranin.

The method gives the best results with young Mammals; also, according to Cajal, the most constant results are given by the cat and rabbit. Nevertheless the Golgi apparatus has been demonstrated in various Invertebrates with success by many workers—Gatenby, *Helix* ovotestis (4); Sanchez, nervous system in *Hirudinea* (13).

3. OBSERVATIONS AND PRECAUTIONS.

Fixation.—The length of time tissues are left in the uranium nitrate-formol is an important factor in making for successful impregnation. This fixative apparently acts after the manner of a mordant with regard to the Golgi apparatus, preparing it, so to speak, for combination with the silver salt. Thus, underfixed tissues will not impregnate, whereas overfixation induces a coarse deposit of silver throughout the material. In the case of tissues which resist penetration the time in the fixative may be increased with advantage up to twenty-four hours. Such at any rate has been the experience of P. Del Rio Hortega (11) for Mammalian ovary. The general quality of the fixation is somewhat variable; thus while the preservation of intestine is excellent testis often shows marked shrinkage.

It is advised by Cajal that the formol should not contain free acid; this he obviates by keeping commercial formol in contact with granulated chalk. Although I usually neutralize the formol with caustic soda solution, I have never observed any harmful effects after using a fairly acid formol.

The Silver Bath.—Generally thirty-six to forty-eight hours in this will impregnate most tissues. Sometimes however the time may be considerably prolonged with advantage. Material over-impregnated with silver shows a fine deposit of the metal throughout the cells. It is of course essential to make up the solution in distilled water, ordinary tap water causing a precipitate of silver.

Reduction.—In my experience it is usually useless to reduce for longer than two hours at the most. Working with pieces

of tissue not more than 5 mm. in thickness, I have obtained satisfactory impregnations of the Golgi apparatus after one to one-and-a-half hour's reduction. By increasing the time the impregnation was not affected in any way. It would seem therefore that the developer penetrates rapidly. The pale yellow colour of the reducing fluid when fresh is apt to change after a few weeks to a dark brown. In spite of this it is still efficacious, though somewhat slower in action.

Toning.—Usually the ground cytoplasm of cells is pale yellow in the untoned sections. If desired they may be toned until grey, usually in about ten minutes by the use of the solutions described above, which should be kept in separate bottles and only mixed before use. The most economical method is to pour a few c.cm. over the slides. The fluid may be poured into a small test tube after use and used several times over. Once the gold precipitates (as usually happens after several days) it should be thrown away.

Elimination of Precipitate.—Veratti has recommended the following procedure for eliminating silver precipitate from sections:—

1. Wash sections on the slide in Aq. dest.
2. Dip for a few seconds into—

Potassium permanganate	0.5	gram.
Sulphuric acid	1	c.cm.
Aq. dest.	1000	„

3. Dip into a 1 p.c. solution of oxalic acid for a few seconds.
4. Wash in distilled water. Examine with the microscope; if precipitate is not yet removed repeat the process.

Although this method will remove deposit from the tissues, it also discolorizes the Golgi apparatus and any other impregnated elements. In my hands it has always failed to correct an over-impregnated preparation.

Counterstaining the sections after toning is often useful. Most of the common histological stains may be used without affecting the impregnation. But the selectivity of dyes is usually diminished. Nevertheless the following have given me satisfactory results:—(1) Ehrlich's haematoxylin and eosin; (2) toluidin blue eosin; (3) Mann's methyl blue eosin; (4) pyronin methyl green; (5) safranin. Of these 1, 3 and 4 (this latter especially) give fairly accurate pictures of the basophilia and oxyphility of cell-elements. For general use safranin used as follows has given me the best results:—

1. Sections on the slide are brought into a saturated solution of safranin O (Grübler) in equal parts of absolute alcohol and aniline oil-water. They are left in this for from fifteen minutes to several hours.

2. Rinse in water.

3. Differentiate partially in 90 p.c. alcohol; pass through absolute into—

4. Clove oil. Complete differentiation in this.

5. Xylol. Mount in balsam.

It is advisable to rinse the xylol after the clove oil, otherwise the sections may fade.

General Precautions.—The Cajal method is somewhat capricious, and it is often difficult to determine the cause of failure. Thus, if a number of pieces of the same tissue, equal in size, be treated together the impregnation will often be good in some and bad in others. Hence the advisability of embedding several pieces of tissue in the same block.

Generally speaking, the outer layers of the material are over-impregnated, while the central portion may not be impregnated at all. The intermediate zone is usually the best.

Every different tissue and different animal has its optimum times for fixation and silvering which have to be worked out for each individual case. This applies especially to Invertebrates.

It is, in my experience, immaterial whether the silvering process takes place in the light or dark. Tissues should be fresh, as autolysis of the Golgi apparatus occurs soon after death.

4. IMPREGNATION OF ELEMENTS OTHER THAN THE GOLGI APPARATUS BY CAJAL'S METHOD.

In addition to a black impregnation of the Golgi apparatus and the staining of the ground cytoplasm yellow, other elements may be affected. Thus mitochondria are often impregnated golden to dark brown, while collagen connective tissue fibres may go brown to black.

Further, the following intracellular elements have been described as being impregnated by Del Rio Hortega:—

(a) A spiral filament, apparently wrapped around the nuclei of unstriated muscle fibres (12).

(b) The myofibrillæ in the same tissue (*ibid.*).

(c) Several structures (11) within the nuclei of ovarian egg-cells in various Mammals, viz. (i.) a small spiral rod apparently lying free within the nucleus; (ii.) within the nucleoli several small bodies either round or in the form of stumpy rods; (iii.) a fine intranuclear network identified as linin by Del Rio Hortega.

The relationship (if any) between these elements associated with the nucleus has yet to be determined.

5. UTILITY OF THE CAJAL METHOD.

The application of this method has yielded very interesting results in the hands of Histologists. Cajal has thereby demonstrated a Golgi apparatus in the cells of nearly all Mammalian

tissues, embryonic and adult. The changes undergone by the Golgi apparatus in glandular secretion, bone formation, etc., have been described. Recently its behaviour following experimental lesions to the nervous system and in various pathological conditions (cancer, etc.) have been studied by the Spanish observers. Further details for the Histologist and Neuropathologist are available in Cajal's masterly monograph (1).

Latterly Zoologists have applied the method both to Vertebrates and Invertebrates with success. The behaviour of the Golgi apparatus in Oogenesis and Spermatogenesis is being studied at the present time with interesting results.

In fact, the Golgi apparatus being an integral part of probably all animal cells, microscopic observations, whether zoological or histological, cannot be complete without reference to this cell-constituent.

Comparison of the pictures of the Golgi apparatus obtained by

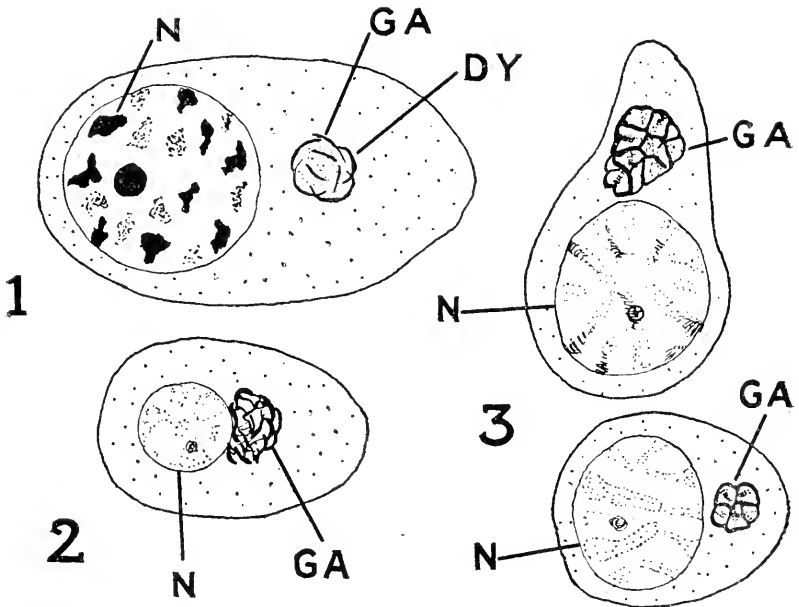

EXPLANATION OF TEXT-FIGURES 1-3.

All the figures represent *Paludina vivipara* spermatocytes.

Text-fig. 1.—Chrome-osmium fixation; stained with iron-hæmatoxylin. Rodlets (dictyosomes) discrete.

Text-fig. 2.—Kopsch technique. Golgi apparatus a reticulum.

Text-fig. 3.—Golgi method. Also a reticulum. The Cajal method gives a similar appearance to the Golgi apparatus.

Text-figs. 1 and 2 after Gatenby (5). No. 3 after Perroncito (9).

Lettering as follow :—

DY = dictyosome. GA = Golgi apparatus. N = nucleus.

the Cajal method with those furnished by the Golgi (*r*), Kopsch (*14*), and other techniques is of interest.

It is now well known that the male germ-cells of Molluscs contain a structure called the "nebenkern" or sphere. Recently Gatenby (*5*) has shown that this is the representative in the germ-cells of the nerve-cell Golgi apparatus.

Now, if the spermatogonia or spermatocytes of the Pulmonate or Prosobranch Gastropods, e.g. *Paludina vivipara*, be examined intra-vitam and with intra-vitam stains, the Golgi apparatus is seen to be made up of a number of perfectly discrete rodlets, the dictyosomes lying upon and around the archoplasm. Similar material fixed in chrome osmium and stained with Heidenhain's iron-hæmatoxylin shows these elements discrete and apparently unaltered in all respects.

Now the Kopsch, Golgi and Cajal impregnation methods for Golgi apparatus show the Molluscan spermatogonial and spermatocyte Golgi apparatus as a more or less distinct and continuous reticulum. There can be little doubt that this appearance is incorrect, since in the living cells the rodlets are seen to be perfectly discrete.

The reticular appearance is either caused by the deposition of metallic compounds, particularly around the ends of the Golgi rods, or possibly, by shrinkage, causing the closely-disposed dictyosomes to appear as a reticulum.

It follows from the above that the Cajal, Golgi and Kopsch impregnation methods, though yielding valuable results, need careful interpretation and control, so far as possible, by other techniques.

In conclusion, I must thank Professor C. S. Sherrington for his interest in this work, and my friend Mr. J. Bronté Gatenby for advice and criticism.

6. BIBLIOGRAPHY.

1. CAJAL, R. y.—Algunas variaciones fisiológicas y patológicas del aparato reticular de Golgi. Trab. del Lab. Invest. Biol., Madrid, xii. (Feb., 1915).
2. — Fórmula de fijación para la demostración fácil del aparato reticular de Golgi, etc. Trab. del Lab. Invest. Biol., Madrid, x. (1912).
3. — Trab. del Lab. Invest. Biol., viii. (1910).
4. GATENBY, J. BRONTÉ.—Identification of Intracellular Structures. Journ. Roy. Micr. Soc., June, 1919.
5. — Cytoplasmic Inclusions of the Germ-cells. Part IV. Notes on Dimorphic Spermatozoa of *Paludina*, etc. Quart. Journ. Micr. Sci., lxiii. pt. 4 (April, 1919).
6. GOLGI, C.—Arch. Ital. de Biol., vii. (1886).
7. — Arch. Ital. de Biol., xlix (1908).
8. LEE, B.—Microtomist's Vade Mecum, 7th ed.

9. PERRONCITO, A.—Contribution à l'étude de la Biologie cellulaire. Arch. Ital. de Biol., liv. (1910).
10. RECKLINGHAUSEN, V.—Virchow's Arch., Bd. 19 (1860).
11. RIO HORTEGA, P. DEL.—Détails nouveaux sur la structure de l'ovaire. Trab. del Lab. Invest. Biol., Madrid, xi. (Dec., 1913).
12. ——— Investigations sur le tissu musculaire lisse. Trab. del Lab. Invest. Biol., Madrid, xi. (Dec., 1913).
13. SÁNCHEZ, D.—El sistema nervioso en los hirudíneos. Trab. del Lab. Invest. Biol., Madrid (1912).
14. KOPSCH, F.—Die Darstellung des Binnennetzes in spinalen Ganglienzellen und anderen Körperzellen mittels Osmiumsäure. Zeit. für Wissenschaft. Mikros., Bd. 20 (1903).

SUMMARY OF CURRENT RESEARCHES
RELATING TO
ZOOLOGY AND BOTANY
(PRINCIPALLY INVERTEBRATA AND CRYPTOGAMIA),
MICROSCOPY, ETC.*

ZOOLOGY.

V E R T E B R A T A.

a. Embryology, Evolution, Heredity, Reproduction,
and Allied Subjects.

Maturation of Human Ovum.—ARTHUR THOMSON (*Journ. Anat.*, 1919, **53**, 172–208, 3 pl., 18 figs.). The human ovum is not spherical, but ovoid. The diameter, including the zona pellucida, is about 0.11 mm. The zona pellucida has its thickness reduced by the permeation of fluid through it, so that its elements separate into strands or small groups of fibrils. Lining its inner surface there seems to be a distinct vitelline membrane. The zona pellucida sometimes shows a faint appearance of concentric lamination. It is suggested that the radial striation only occurs in the later stages of maturation. There seems to be a perivitelline space, largest at the time of the extrusion of the polar bodies which eventually come to lie within it. There is evidence of a centrosome which divides into two. There are vacuoles, often with a granule within, and isolated granules in the cytoplasm. The nucleus ranges in size from 0.020×0.017 to 0.030×0.024 mm.; it may show a membrane or none; its contents include chromatin granules, isolated, paired, massed in groups, or arranged in threads. A clearly defined nucleolus may be seen. The karyoplasm is paler and more finely granular than the cytoplasm. Both polar bodies seem to be expelled before the oocyte has left the Graafian follicle. In other words, the maturation of the oocyte with its female pronucleus is complete before it has been subjected to the influence of the spermatozoon.

J. A. T.

Formation of Single-ovum Twins.—GEORGE L. STREETER (*Bull. Johns Hopkins Hospital*, 1919, **30**, 235–8, 4 figs.). In a very early twin

* The Society does not hold itself responsible for the views of the authors of the papers abstracted. The object of this part of the Journal is to present a summary of the papers as actually published, and to describe and illustrate Instruments, Apparatus, etc., which are either new or have not been previously described in this country.

human embryo ("the Mateer ovum") of the presomite period, the larger embryo is in the primitive groove stage, with an embryonic plate 0.92 mm. long by 0.78 mm. broad, probably about seventeen days old. The smaller embryo consists of an amniotic vesicle 0.1 mm. in its largest internal diameter, and a yolk-vesicle 0.03 mm. in its internal diameter, slightly detached from it, the two being suspended in the loose mesenchyme in the region of the body-stalk of the co-twin. The exact character of the mechanism by which human twins are derived from a single ovum is still unknown, but it seems that the embryonic area or node separates into a primary mass and a secondary bud. If the twin is as large as the primary embryo their chances of development in an orderly manner would be equal, and this is presumably the case in most instances of identical twins. Where the secondary bud is merely a fragment the development would soon be arrested, and at term the stunted bud would be found as a small epithelial cyst on the placenta near the attachment of the umbilical cord. If the twin-bud is only partly detached from the primary node there would exist the basis for the various types of double monsters and teratomata.

J. A. T.

Selection among Germ-cells.—C. H. DANFORTH (*Journ. Exper. Zool.*, 1919, **28**, 385-411). Experiments with heterozygous fowls exposed to alcohol vapour. The relative proportion of certain traits, brachydactyly, polydactyly, and white colour, appearing in the offspring produced during periods of alcoholic treatment was compared with the proportion of those traits produced in normal conditions. The results indicate that with at least some traits selection is possible, and that it is more rigorous the more severe the treatment. It appears that germ-cells with different genetic potentialities react differently. A possibility of far-reaching importance is suggested: that even under normal conditions the genes which determine the genetic potentialities of a germ-cell may have a real survival value for that cell, and moreover that the prevalence of certain traits appearing in the adult may be in the final analysis largely regulated by the advantages or disadvantages that the determiners for such traits confer upon the germ-cells in which they chance to be lodged.

J. A. T.

Winter Egg-production in Poultry.—H. D. GOODALE and GRACE MACMULLEN (*Journ. Exper. Zool.*, 1919, **28**, 83-124). The mode of inheritance of winter egg-production in hens has not yet been determined. It is suggested that there are two classes of winter egg-production, viz. high and mediocre; that there are two genes, both of which must be present in the female zygote in order to have high production, and that these are inherited according to the Mendelian dihybrid scheme. But larger data are needed.

J. A. T.

Development of Guinea-Pig.—D. CARAZZI (*Monitore Zool. Ital.*, 1918, **29**, 42-8, 115-21, 133-46, 18 figs.). An account is given of the small canal in the notochord. It appears to arise by partial karyolysis—a sort of schizocoel. It ruptures, and its dorsal portion is flattened to form the notochordal plate. In that region the embryo, formerly

showing three germinal layers, shows only the medullary groove and the notochordal plate. The reality of a neurenteric canal in the embryo of

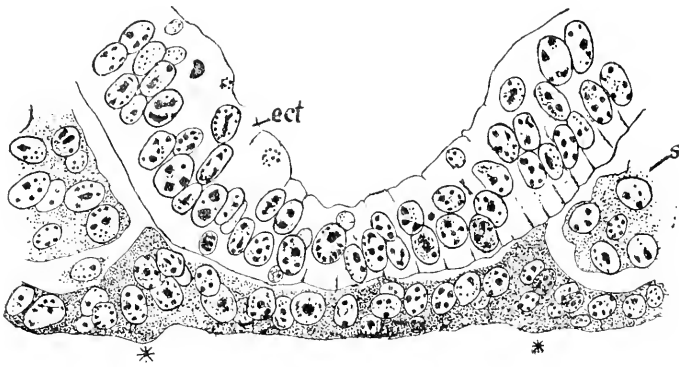

Section through anterior part of embryonic shield of guinea-pig of fourteen days. Magnified about 500. *ect.*, ectoderm of medullary groove; *s.*, a segment; **, the two asterisks show where the intervening notochordal plate stops and the endoderm recommences.

Cavia is discussed, and the conclusion is that it does not exist. Finally, the author gives an account of the origin of the amnion, emphasizing its schizocoelic nature.
J. A. T.

Development of Pig's Sternum.—FRANK BLAIR HANSON (*Anat. Record*, 1919, 17, 1-23, 6 pls.). It is maintained that the pig's sternum cannot be a derivative of the costal cartilages, since it exists as a distinct entity prior to the fusion of the ribs with the sternum. It may arise "in situ," as Whitehead and Waddell suggest, but more likely its genesis is wrapped up in some way with the coracoidal hypothesis of Paterson. Its primordium appears as two longitudinal bands, which become united anteriorly by the presternum. The sternal bands are at first unsegmented; the sternebrae and centres of ossification (double for each sternebra) appear late in development, and are always intercostal in position. The centre of ossification for the presternum appears last.

J. A. T.

Development of Pericardio-peritoneal Canals in Selachians.—EDWIN S. GOODRICH (*Journ. Anatomy*, 1918, 53, 1-13, 18 figs.). An examination of embryos of *Acanthias* and *Scyllium* confirms Balfour's suggestion that the canal leading in the adult Selachii from the pericardial to the peritoneal coelom, and opening into the latter by paired apertures, is a remnant of the wide communication between these cavities in the embryos. The canal openings are not new formations as Hochstetter maintained, but are derived from the pericardio-peritoneal passages above the mesocardia lateralia. A precise account of the development is given.

J. A. T.

Spina bifida in very early Human Embryo.—S. T. WALLIS CULL (*Bull. Johns Hopkins Hospital*, 1919, **30**, 181-3, 1 fig.). An embryo 17 mm. long, perhaps seven weeks old, showed abnormalities of brain, spinal cord, viscera and skeleton generally supposed to be characteristic only of much older monsters. The chief point of pathological attack seems to have been in the axial skeleton and central nervous system below the brain. The popular conception that mechanical influences have an important bearing upon the formation of monsters has been overthrown by recent chemical experiments. The specific action of dilute salt solutions upon Amphibian eggs, for instance, will produce spina bifida in a large proportion of the embryo. The trouble would seem to lie, therefore, not in the ovum itself, nor in the external mechanical influences acting upon it at a later date, such as amniotic bands which compress the umbilical cord, but rather in the impairment of nutrition associated with faulty implantation, or in the toxic influences arising from a diseased uterus. J. A. T.

Influence of Thyroid on Growth and Development of Amphibia.—E. R. and M. M. HOSKINS (*Journ. Exper. Zool.*, 1919, **29**, 1-70, 9 pls.). Experiments on *Amblystoma punctatum* and *Rana sylvatica*, from which the thyroid was removed at an early stage before it had begun to differentiate. The thyroidless larvæ grow much larger than the controls. They do not exhibit metamorphosis within a year. Probably they cannot undergo it at all. This is attributed to faulty metabolism, e.g. of calcium. There is deficiency in calcification and ossification. Thyroidless forms show (1) slow growth, slow differentiation, and large size of brain; (2) a relatively large liver imperfectly differentiated; (3) hyperplasia of the hypophysis; (4) eventually large thymus and epithelioid (parathyroid) bodies; (5) relatively large kidneys; (6) a long intestine of a larval character; (7) large ovaries without mature ova or oviducts; (8) prematurely mature testes, producing spermatozoa. The internal gills persist in animals kept in the larval condition by thyroidectomy. The lungs develop and become functional in both normal and thyroidless larvæ. J. A. T.

Inbreeding-effects in Albino Rats.—HELEN DEAN KING (*Journ. Exper. Zool.*, 1919, **29**, 71-111, 8 charts). The closest form of inbreeding possible in mammals, the mating of brother and sister from the same litter, is not necessarily inimical either to body growth, to fertility, or to constitutional vigour, provided that only the best animals from a relatively large number are used for breeding purposes. Selection, seemingly, is able to hold in check any tendency that inbreeding may have to bring out the undesirable latent traits inherent in the strain. Adverse conditions of environment and of nutrition produce far more detrimental effects on growth and fertility than does inbreeding. But these factors do not alter to genetic constitution. The sex ratio seems amenable to selection, for two lines were separated out. The effects of selection were not cumulative however. It is quite clear that long-continued inbreeding did not change the normal body-weight relations of the sexes, nor the form of the growth graph to any noteworthy extent, nor rate and extent of growth in weight. J. A. T.

Underfeeding Rats.—CHESTER A. STEWART (*Amer. Journ. Physiol.*, 1919, 48, 67-78). The underfed new-born rats become relatively long-tailed. In animals kept by underfeeding at birth weight the head increases about 45 p.c. in weight, compensated by corresponding decrease in the trunk and extremities. The visceral group increases 46 p.c., the integument 25 p.c., the musculature and skeleton (together) 6 p.c., counterbalanced by a corresponding decrease of 59 p.c. in the "remainder."
J. A. T.

Gonads as Controllers of Characteristics.—CARL R. MOORE (*Journ. Exper. Zool.*, 1919, 28, 459-67, 1 fig.). After early removal of the gonads the growth of the male is higher than that of the female. To this in the experiments made (on the white rat) there were no exceptions. There is, therefore, a real difference (of metabolism?) in the two sexes, which may represent an inherited difference from the original ova, but this difference may be accentuated by the presence of the ovary in the female. Riddle's researches on differences of metabolism in the two kinds of ova and in the two sexes are of first-class importance, but in speaking of "Riddle's Theory of Sex," it should be remembered (the recorder thinks) that the suggestion of correlating sex differences with fundamental differences in metabolism was elaborated by Patrick Geddes thirty years ago and more.
J. A. T.

Sex-characters and Sex-glands.—A. LIPSCHÜTZ (*MT. Nat. Geo. Bern*, 1917, xxv.-xxvii.). Confirmation of the view of Steinach and others that interstitial cells forming a "puberty-gland" in mammalian testes and ovaries exert a formative influence on sex-characters. The action of the secretions is specific. When Steinach implanted ovaries in early-castrated males of rats and guinea-pigs, these males were feminized, their nervous system was eroticized in a feminine direction, the mammary glands were stimulated, milk was secreted, the growth of the penis was inhibited. Similarly, females were masculinized. Lipschütz observed a penis-like growth of the clitoris. Perhaps what occurs is that an asexual soma becomes in a castrated animal like the form common to the two sexes. It has been shown by Goodale and Pézard that a young cock castrated keeps the characteristic plumage and grows spurs, but does not gain the normal comb and wattles. A young hen castrated gains masculine plumage and spurs. Thus the two results are closely alike. What in one sex may be independent of the stimulus of the puberty-gland may be in the other sex much changed by the same influence. So Lipschütz distinguishes for all Vertebrates: (1) sex-characters independent of the puberty-gland, but dependent on the asexual embryonic equipment; and (2) sex-characters dependent on the influence of the puberty-glands, whether that be stimulating or inhibiting, the material being again that afforded by the asexual embryonic equipment.
J. A. T.

Relation of Ovary to Causation of Sex.—JOHN G. MURRAY, JUN. (*Bull. Johns Hopkins Hospital*, 1919, 29, 275-81). In reference to the theory of E. Rumley Dawson that in man the supplying ovary is the essential factor in the causation of sex, the author has investigated

sixty cases. He finds that the supplying ovary has no influence upon the sex of the child, and that male and female children result in about equal numbers from the fertilization of ova from either ovary. He concludes that "the causation of sex is probably not due to any factor in the unfertilized ovum, that the 'chromosome theory' must be considered the only explanation of the causation of sex at present acceptable, and that the sex of an unborn child cannot be foretold, nor can either sex be produced at will, by any rules known at present."

J. A. T.

Correlation between Pigeon's Crop and Gonads.—CH. CHAMPY and P. COLLE (*Comptes Rendus Soc. Biol., Paris*, **82**, 1919, 818-9). During incubation the mucous membrane of the crop of both sexes thickens greatly, and continues to secrete for fifteen days after the eggs are hatched. The reduction in the size of the testes from the beginning of incubation onwards coincides with the multiplication of cells in the lining of the crop. The testes begin to return to their normal size from about the middle of the incubation period. There is an arrest of spermatogenesis and an absorption of more than half of the seminiferous tubules. There is no noteworthy development of interstitial tissue as is seen during the quite different winter regression. The spermatogenesis recommences some five or six days after the hatching of the eggs. In the female there is during incubation an atresia of numerous oocytes of large size; the maximum of this, which is quite different from the winter arrest of oogenesis, is towards the middle of the incubation period. It must be noted that some atresia occurs outside the incubation period altogether, but it is not so marked. It seems then that during the exaggerated glandular development of the crop there is an intense absorption of germ-cells in the gonads. This probably illustrates a nutritive balance; but the regression of the gonads does not continue during the whole secretory activity of the crop, and there is no trace of any hormone.

J. A. T.

b. Histology.

Minute Structure of Membranous Labyrinth of Tadpoles.—TAKE-SHIRO ASAI (*MT. Med. Fak. Univ., Tokyo*, 1918, **19**, 315-88, 2 pls.). An elaborate study of the tadpoles of *Bufo vulgaris* and *Rana esculenta* as regards the minute structure of the membranous labyrinth, and with special reference to the nerve-endings in the epithelium of the pars neglecta. The investigation deals first with the otolithic mass and the so-called covering membrane (over the epithelial surface of the macula), and the latter is shown to be non-existent. Next comes a description of the areas of nerve endings in the membranous labyrinth, and of the different kinds of cells. The basal-cells and the thread-cells of the crista and macula acustica are dealt with, and then the hair-cells and the auditory hairs. Subsequent sections discuss the cupula terminalis, the utriculo-saccular foramen, the pars neglecta, the membrana tectoria, and the crista acustica. We can only indicate the parts dealt with.

J. A. T.

Development of Cross-striations in Heart Muscle of Chick Embryo.—MARGARET REED LEWIS (*Bull. Johns Hopkins Hospital*, 1919, 30, 176-81, 1 pl.). In the living cell cross-striations are present, but no fibrils. The cross-striations are very thin bands on the surface of the cell. They extend across the cell and are never in the narrow threads or fibrils. The fixation of the cell causes the formation of the surface layer into fibrils in which the cross-striations are drawn together into deeper bundles and thus become evident as sharply marked structures. In places where the pull on the surface of the cell is such that the latter is not coagulated into fibrils, the cross-striations remain spread out as thin bands across the cell. The complete cross-striations are present in the muscle of the heart of very young chick embryos (10 myotomes), much earlier than was supposed by other observers. The myofibril theory is not satisfactory, at least in regard to heart muscle, and this is not surprising. For the structure on which the theory was based is not a part of the living heart-muscle cell, but only of the dead cell.

J. A. T.

Ultra-microscopic Particles.—ALBERT and MARY ALEXANDRE (*Introduction à la Biologie Micellaire, Paris, 1917, 38*). Below the cell are the micellæ that compose it, ultra-microscopic spherical corpuscles. The importance of the cell as a unit has been exaggerated. Syncytia are common; the germ-cells arise from cytogenous corpuscles (*sic*); there are Protists without nuclei; cells may disintegrate into micellæ; micrococci are free and independent micellæ; crystals and minerals are built up of petroblast micellæ. There is no transformation, only aggregation and disintegration. Nothing is born nor dies, all is assemblance and dissociation. The most diverse beings are but transient associations of ultra-microscopic beings, always fundamentally identical, which separate and rejoin according to circumstances. Thus, we think, a fact is exaggerated into a fallacy.

J. A. T.

Enamel Organ of Hake.—J. THORNTON CARTER (*Quart. Journ. Micr. Sci.*, 1918, 63, 387-400). In Gadidæ, such as the hake (*Merluccius vulgaris*), each tooth is surmounted by a pointed cap of enamel which rests on a platform of dentine, whose central area extends into the enamel cap, thus affording a firm support without increasing the outside dimensions of the tooth over this area. The origin of the tooth-germ is as in Mammals, there being an ingrowth of the deeper layer of the oral epithelium and the growth of a dentine papillæ which becomes invested by the epithelium except at its base. The development of the epithelial enamel organ is carefully traced. It consists, to begin with, of two layers of cells, the one lying in apposition to the dentine, consisting of columnar ameloblasts with well-defined cell outlines and the nuclei lying about the centres of the cells. Immediately external, separating the ameloblasts from the surrounding connective tissues, lies a layer of polygonal cells, usually two or three deep, constituting the external epithelium of the enamel organ. The ameloblasts maintain their individuality throughout the whole period of the formation of the enamel cap, and the fully developed enamel is the product of

certain changes taking place in the ameloblastic secretion, which at first occupies the vacuoles in the ameloblasts, and is then passed through the inner ameloblastic membrane to be deposited on the surface of the dentine. There is probably a gel-formation of the secretion, and then the precipitation of a large amount of the organic material causes a greater concentration of the lime salts in the fluid occupying the inter-spaces, and calcification then progresses until the organic matter is almost, if not quite, calcified.

J. A. T.

Growth of Fish Scales.—A. G. HUNTSMAN (*Trans. Roy. Canadian Institute*, 1919, 12, 61–101, 17 figs.). The general statement that the growth of the scale corresponds with the growth of the fish, though substantially accurate, requires considerable modification. In fishes belonging to such diverse groups as the Clupeidæ (*Clupea harengus*), the Labridæ (*Tautoglabrus adspersus*), and the Pleuronectidæ (*Pseudopleuronectes americanus*) there is a lack of correspondence in the rates of growth of the scales and of the body, as judged by their antero-posterior diameters (particularly as regards the anterior field of the scale). The scale begins its growth later, grows relatively more rapidly than the body during the first half of life, and less rapidly than the body during the second half.

In the alewife (*Pomolobus pseudoharengus*) scales from different regions show differences in time of appearance and in rate of growth. The anterior and posterior fields of the scale do not appear at the same time, nor grow at the same rate. The posterior field appears first, grows very rapidly for a short period, and then at approximately the same rate as the entire fish. The anterior field does not grow uniformly, there being a lack of correspondence in the increase not only of the two chief diameters (transverse and longitudinal), but also of the several longitudinal diameters (median and lateral).

There is evidence of a lack of correspondence in growth between the two principal layers of the scale, and even between the parts of one layer. It is suggested that simple variations in the rates of growth of the parts of the scale are responsible for the differences in shape and pattern of scales from different regions.

As concerns the use of the scales in determining the growth of the fish during the several years of its life, it will depend upon the degree of accuracy desired whether any notice be taken of the discrepancy between the growth of the scale and the growth of the fish. In any case the probable error arising from this source should be considered. It would not be difficult to determine the amount of correction necessary in a particular case. This would be of importance chiefly for the growth during the first year. The best diameter for use in length calculations, if no correction is to be made, is the transverse in the Clupeidæ. The posterior field would be preferable, but the indistinctness of the annual rings in that region renders it useless.

J. A. T.

Scale-reading in Salmon.—J. ARTHUR HUTTON (*Salmon and Trout Magazine*, 1919, August, 1–41). A continuation of careful readings of scale-markings and of inferences from data so obtained. By examining

the central portion of the scale one can determine with absolute accuracy the number of years which each salmon has spent in the river as a parr. It does not matter whether the fish weighs five pounds or fifty, the parr-life is indelibly marked on almost every scale. The majority of parr in the River Wye migrate to the sea as smolts at the commencement of the third year of their life. A small proportion may migrate when only one year old, and a still smaller proportion will remain three years in the river before they reach the smolt stage. The earlier the parr becomes a smolt the more probability there is of it reaching the sea and becoming a salmon. If anything is practicable, there should be encouragement of the stock which produces one-year smolts. J. A. T.

Functions of Nucleus.—VERNON LYNCH (*Amer. Journ. Physiol.* 1919, 48, 258-83). An amœba from which the nucleus has been removed may at times exhibit perfectly normal movement; in general, however, movement is somewhat affected by removal of the nucleus. An amœba deprived of its nucleus lives almost as long as an amœba deprived of food. Evidence is adduced that an amœba can use glucose in solution as a food. There is also evidence that amœbæ can synthesize glucose and urea, or some derivatives of these substances, to form a product which is of nutritive value. Glucose is also of some benefit to the enucleated amœba, but the supposed synthesis of glucose and urea cannot be effected. The non-nucleated cell is injured more quickly by either a lack or an excess of oxygen than is the normal nucleated cell; it is somewhat more susceptible to high and low temperature than the nucleated cell.

“The enucleated cell may move, respire, digest, respond to stimuli and exhibit any activity which is dependent solely upon katabolic or destructive processes of protoplasm. The group of phenomena it never shows are those of growth and of regeneration and division. The phenomena of growth are essentially phenomena of organic synthesis, and the dependence of growth upon the nucleus implies the dependence of organic synthesis upon the nucleus.” J. A. T.

Degeneration of Fibroblasts of Chick Embryos in Cultures.—WARREN H. LEWIS (*Bull. Johns Hopkins Hospital*, 1919, 30, 81-91, 21 figs.). In fibroblasts in tissue-cultures degeneration granules and fluid vacuoles appear. The author states the characteristics of these in detail. As the cultures get older there is a gradual increase in number and size of the granules and vacuoles. The author discusses the size and shape, the relation of granule and vacuole, the movements (different from and more extended than the ordinary mitochondrial movements), the changes they undergo, the mitochondria and mitochondrial vesicles. He describes the accumulation of granules, vacuoles, and mitochondria about the centriole, and the accumulation or building up of an increased amount of what seems to be a special type of cytoplasm about the centriole. This would indicate that the activities of the centriole are in some manner increased during the degeneration of the cells. Very important is the general suggestion that the living part of the cell cannot be stained by any of the so-called vital dyes, that living proto-

plasm cannot combine, either physically or chemically, with any other substances, except such as are synthetically built into itself. The granules and vacuoles are probably waste products. Their accumulation round the centriole probably interferes with the interchange of materials between centriole and periphery.

J. A. T.

Development of Heart-muscle of Pig.—LUCILLE WITTE (*Amer. Journ. Anat.*, 1919, **25**, 333-47, 18 figs.). The early heart-tissue is cellular, composed of spindle-shaped cells which afterwards anastomose terminally and laterally to form a network of fibres. The striations appear earlier than the discs, but only here and there throughout the tissue. The discs appear in the 76 mm. stage, much earlier than in any other animal studied, with the exception of the cat embryo of four days. The discs are at first dots or incomplete bands beginning at the periphery of the fibre and growing across. With the advance in development, they become straight discs across the entire fibre, then across two or more, and finally assume the more complex type of discs and "risers." The discs do not appear more numerous in contracted areas than in relaxed areas. The discs are not to be found at either end of a series of nuclei, thus forming a cell, for they are almost invariably to be found in close proximity to each other, occurring in patches, and there is seldom a nucleus to be found between them. The theory is put forward that the discs serve as strengthening bands in the muscle fibres, since they appear at about the time of the change of the cells into fibres, and increase in number and complexity with the growth and activity of the heart.

J. A. T.

Hæmolytic Action of Blood of Young Eels.—E. GLEY (*C.R. Soc. Biol. Paris*, 1919, **82**, 817-8). The blood of elvers, still transparent, and in process of ascending rivers, is very small in amount, and it is difficult to get more than a few drops. But these sufficed to show the hæmolytic action *in vitro* on the red blood corpuscles of the rabbit. G. Buglia has shown (1919) that an aqueous extract of the whole body is also strongly hæmolytic. It may be noted also that Buffa proved in 1900 that the blood of larval lampreys is as toxic as that of the adults.

J. A. T.

Changes in the Teeth of the Guinea-Pig produced by Scorbutic Diet.—S. S. ZILVA and F. M. WELLS (*Proc. Roy. Soc.*, 1919, **90**, Series B, 505-12). The authors describe a condition of fibrosis or fibroid degeneration of the teeth of guinea-pigs occurring as one of the earliest changes produced by deficiency of anti-scorbutic material in the diet—sometimes well marked after only ten days' feeding on scorbutic diet, at a period before the animal's body weight had commenced to decline. Briefly the change consists in an alteration in the fine cellular connective tissue of the normal pulp to a new firm fibrosis structure devoid of cells, nuclei, or any regular arrangements of constituent parts. Nerve cells, blood vessels and odontoblasts all share in the process of fibrification and become unrecognizable. Irregular osteoid changes in the dentine occur, and the dentine presents a different refractive appearance owing

to the hæmorrhagic condition of the dentinal fibrils. The changes originate in the odontoblastic cells at the top of the pulp, and work down to the apex followed by distended blood vessels and hæmorrhage; finally complete fibroid degeneration takes place. The condition is well shown in the contrasting normal and diseased teeth sections which accompany the communication.

J. E.

c. General.

Fauna of Ritom Lake.—G. SURBECK (*MT. Naturf. Ges. Bern.*, 1917, ix-xi). This lake in Val Piora lies at an elevation of 1831 metres, and is peculiar because of the abundance of sulphuretted hydrogen in the deeper water. This gas is extremely poisonous to the fishes in the lake and forces them to keep near shore and to surface zones of not less than 13 metres in depth. Nevertheless the trout, which show interesting variability and transitions between *Salmo lacustris* and *S. fario*, flourish well and attain a large size. They are very fat and the contents of the food-canal show that they feed well on larvæ of Plecoptera, Culicidæ, and Chironomidæ, as well as on Daphnids, Ostracods, and Hydracarina. There are also miller's thumbs (*Cottus gobio*), and not very thriving char (*Salvelinus*). All the three kinds have been introduced.

J. A. T.

Quantitative Method in Biology.—JULIUS MACLEOD (*Publications, Univ. Manchester*, 1919, 120, xl + 228, 27 figs.). A plea for more measurement. It is necessary to discover the elementary properties or primordia which are significant for an organism—e.g. the number of cells in an organ, the dimensions of the cells, the number of hairs on a particular structure. By convenient methods of measuring these primordia it is possible to determine constants, which are simply the exact expressions of observed facts. The author classifies primordia and illustrates the various methods of measuring them. More measurement will lead to greater precision in specific and generic diagnosis, increased security in taxonomy, and deeper recognition of variability, modifiability, growth-stages, and gradation axes. A species is regarded as marked by its chemical individuality, which separates it from all others. Species arise not by continuous transformation, but by mutations due, directly or indirectly, to novel conditions of life.

J. A. T.

Resistance of Red Blood Corpuscles to Hypotonic Salt Solutions.—MATSUZIRO TAKENOUCI (*Anat. Record*, 1919, 17, 45-57, 1 chart). The resistance of the erythrocytes of albino rats at different ages to hypotonic salt solutions is related to the water content of the serum normally surrounding the corpuscles. The concentration of the salt solution causing hæmolysis increases with age. The concentration of the hypotonic salt solution which causes approximately 20 p.c. hæmolysis is 0.441 p.c. for the youngest, and 0.470 p.c. for the oldest age group. The erythrocytes of the female are less resistant—i.e. respond to a higher concentration of the hypotonic salt solution than do those of the male.

J. A. T.

2 A 2

Heart of Reptiles.—EDWIN S. GOODRICH (*Journ. Anat.*, 1919, **53**, 298-304, 5 figs). There is in the ventricle of all living reptiles a muscular septum attached to the ventral wall, and passing forwards between the left auriculo-ventricular opening and the ostium of the pulmonary artery. Dorsally and to the left of this septum is the *cavum arteriosum*, while on the right the *dorsal cavum venosum* passes ventrally round the free edge of the septum to the *cavum pulmonale*. Muscular strands from the base of the septum to the dorsal wall of the ventricle separate incipient left from incipient right chambers. In the Crocodilia these strands form a wall, which, together with the septum, unite with the endocardial cushion of the interauricular septum and complete the division of the cavity into a left ventricle corresponding to the *cavum arteriosum*, and a right ventricle corresponding to the *cavum venosum* and *cavum pulmonale*. The left ventricle leads to the right aortic arch and the right ventricle to the pulmonary artery and the left aortic arch. Whereas in the Chelonia, as in the Crocodilia, the left arch receives most of its blood from the *cavum pulmonale*, in the Lacertilia and Ophidia it opens more dorsally so as to receive arterial blood as well.

J. A. T.

Two Unusual Blood Vessels in Tree-Frog.—W. B. BENHAM (*Trans. New Zealand Inst.*, 1919, **51**, 30-4, 2 figs.). An interesting persistence of the third branchial aortic arch is recorded in *Hyla aurea*. It had no connexion with the dorsal aorta or with the systemic arch, but bends round into the cutaneous artery, which has a very slender union with the parent fourth arch. This raises the question whether the cutaneous artery is not originally derived from the third arch. A second anomaly in the same species is described, namely, paired lateral abdominal veins—an interesting persistence of a larval condition, though with certain differences in detail.

J. A. T.

Brain and Cranial Nerves of Dogfishes.—G. L. PURSER (*Proc. R. Phys. Soc. Edinburgh*, 1919, **20**, 183-92, 6 pls., 2 figs.). A careful account is given of the brain and spinal cord of *Acanthias vulgaris* Risso, in comparison with those of *Galeorhinus galeus* (Linn.) and of *Pristiurus melanostomus* Gunther, and of *Scyllium* in part.

J. A. T.

Organs of Internal Secretion in Fishes.—J. NUSBAUM-HILAROWICZ (*Anat. Anzeiger*, 1916, **41**, 1-13, 6 figs.). In some deep-sea Teleosteans (*Argyrolepecus*, *Gonostoma*, *Stomias*, *Sternoptyx*) the author finds what he regards as organs of internal secretion. In *Argyrolepecus* and *Gonostoma* the anterior and median portions of the kidneys enclose a band of compact polyhedral glandular cells separated by capillaries. In *Stomias* there is a sub-oesophageal organ of internal secretion, composed by epithelial bands and tubes. Moreover, the author maintains that the luminescent organs of abyssal fishes form a secretion which is passed into the blood. They are to be regarded as in part at least endocrine organs.

J. A. T.

Myology of Shoulder-girdle and Pectoral Fin in Fishes.—E. W. SHANN (*Trans. R. Soc. Edinburgh*, 1919, **52**, 521-70, 4 pls.). A score

of types, representative of all the orders of fishes have been carefully studied as regards the lateral muscle, the posterior muscles, and the anterior muscles of the shoulder-girdle, and the adductor and abductor of the pectoral fin. A generalized comparative survey is submitted. The author's object in elucidating the musculature of the fore-limb of fishes was to clear the ground in approaching afresh the problem of the evolution of the pentadactyl limb.

J. A. T.

Feeding Habits of Young Fishes.—MARIE V. LEBOUR (*Journ. Marine Biol. Assoc.*, 1919, **12**, 9-21). There are great differences in the way various species feed. Some stalk selected food, others apparently eat the first thing that comes. Some feed at all times, others only at night. Some eat very little at one time, others as much as they can get. Some are very shy, others snap at once. Of all those observed the whiting is the greediest, and very clever at selecting the best. The pollack comes second. These stalk their food, usually Copepods, coming up from behind and giving a sure sideways dart, so that the Copepod is swallowed head foremost. The young of the Ballan Wrasse (*Labrus bergylta*) are slow and stupid; the species of *Solea* very alert. Young humpsuckers, fixed to the glass sides of the aquarium, would instantly unfix when food was near. Selecting something specially attractive, they would chase it and quickly swallow it. A post-larval angler, 8.5 mm. long, showed large and extremely brilliant blue eyes. The anterior portion of the dorsal fin bears four long processes; the pectoral fins are large and with lobed processes; the pelvic fins are almost as long as the body. The darting movements are very rapid, the pelvic fins looking like wings.

J. A. T.

Function of Swim-bladder.—A. BOUTAN (*Comptes Rendus Acad. Paris*, 1916, **163**, 529-81). Each species of Teleostean fish has its appropriate depth at which it is in hydrostatic equilibrium. By the absorption or secretion of gas in the swim-bladder the fish maintains itself automatically at its appropriate depth. The absorption or secretion is the result of a physiological reaction which the author discusses.

J. A. T.

INVERTEBRATA.

Mollusca.

γ. Gastropoda.

Spermatogenesis of Pulmonate Gastropods.—J. BRONTÉ GATENBY (*Quart. Journ. Micr. Sci.*, 1919, **63**, 197-258, 3 pls., 3 figs.). Eight species of Pulmonates, species of *Limax*, *Arion*, *Helix* and *Testucella*, have been studied. A new set of plasmatic bodies, the post-nuclear bodies, have been discovered. They resemble mitochondria in their size, but differ in staining affinities. They ultimately form a plate at the rear of the spermatid nucleus. It is large at first, but shrinks synchronously with the shrinkage stages of the nucleus. These post-nuclear granules appear to become non-staining during the maturation.

The mitochondria of all the Pulmonates studied are of much the

same general type and size, but there is no absolute regularity. It is sometimes possible to distinguish an inner core either non-colourable or faintly colourable, and an outer shell of colourable or chromophile matter. The latter part of individual mitochondria often fuses to form threads or rods, which then lie in the apparently liquid chromophobe part.

The chondrioplasts of different genera, and often of different species, tend to differ a little in shape and size. The centrosome sorts them out into two equal groups at the prophase of division. Their behaviour is described. The micromitochondria are distinguished from the macromitochondria. The changes of the mitochondria in the staining affinity and resistance to fixatives are discussed. Strong evidence is being collected against the view that the mitochondria take any part in the transmission of hereditary factors.

J. A. T.

Notes on Thecosomatous Pteropods.—GIUSEPPE COLOSI (*Monitore Zool., Ital.*, 1918, 29, 79-87, 6 figs.). Attention is called to the tetragonal symmetry of the armature of the gizzard in Thecosomata and its marked resemblance to that in Runcinidæ. A description is given of the reproductive organs of *Cavolinia longirostris* (= *Hyalæa longirostris* Lesueur), where again there is resemblance to a type like *Runcina*, the author's general view being that within the Tectibranchs there should be established a section Runcinidea, from which there have diverged the littoral Runcinidæ and the pelagic Thecosomata (Cavoliniidæ, Limacinidæ and Cymbuliidæ).

J. A. T.

Structure of *Amphibola crenata*.—WINIFRED C. FARNIE (*Trans. New Zealand Inst.*, 1919, 51, 69-85, 7 figs.). This is a pulmonate gastropod living on mud-flats on the coast of New Zealand. The gill has been replaced by a lung, but the animal, which is very sluggish, can live immersed in fresh water for a fortnight, in the sea for a month. The minute eye, not previously located with accuracy, is at the tip of

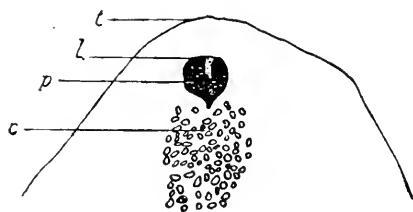

The end of a tentacle, with the eye, cleared and mounted entire.
c., carbonate; g., lime; l., lens; p., pigment; t., tip of tentacle,
Much enlarged.

the tentacles. An account is given of alimentary, nervous, vascular, excretory, and reproductive systems. Embedded in the connective tissue and amongst the muscles in all parts of the body are numerous bodies composed of carbonate of lime. They are extremely abundant, especially on the mantle-edge. They vary in size, the smallest ones

being at the base of the tentacle below the eye. Some are spherical, some ovoid, some more or less rhomboidal. Under high power some show fine circular striations.

J. A. T.

Sex Phenomena in *Crepidula plana*.—HARLEY N. GOULD (*Journ. Exper. Zool.*, 1919, **29**, 113–120, 1 fig.). The stimulus passing from larger to small specimens of this peculiar hermaphrodite mollusc, causing the latter to assume and retain the male phase, can be transmitted for several millimetres through sea-water, though its effectiveness is reduced at this distance. In three out of twenty-six cases there was indication that the stimulus may be given faintly by *Crepidula fornicata*, a related species. The stimulus acts in such a manner as to suggest that it is a specific substance given off from the bodies of the animals, diffusible in sea-water, but very unstable.

J. A. T.

Parthenogenesis in *Paludetrina jenkinsi*.—A. E. BOYCOTT (*Journ. of Conch.*, 1919, 54). The absence of male individuals and of any male anatomical elements in this species has been noticed before. Evidence is now produced that parthenogenetic reproduction actually occurs. In September, 1915, a number of the snails were put in a small aquarium; the many used for anatomical examination were all found to be females; young were produced which were first noticed in November, 1916. On the 1st January, 1917, three minute individuals, about 1 mm. long, were isolated under all proper precautions. By the 1st August, 1918, two of the jars (the third had got broken) contained each about twenty *jenkinsi*, from infants to about half-grown, that must have arisen from single individuals originally placed there. On the same date four more very young individuals were isolated: A. and B. from the first parthenogenetic broods, and C. and D. from the original aquarium. In March, 1919, all four were about full-grown, and on 8th April, 1919, a brood of young ones was found in B. The mother was then examined by a complete series of microscopical sections without finding any male organs or spermatozoa. There were, therefore, two successive parthenogenetic generations: D. produced a brood in May and C. in June. The parent D. was examined and found to be wholly female.

B. B. W.

Notes on *Hygromia limbata* (Drap.)—HUGH WATSON (*Proc. Malac. Soc. Lond.*, 1919, **13**, 120–32, 2 pl.). The anatomy of this recently discovered member of the British fauna, and that of its nearest Continental allies, with the microscopic sculpturing of their shells, is carefully described, and a new arrangement of the genus *Hygromia* of Risso founded thereon.

B. B. W.

Arthropoda.

a. Insecta.

Segregation of Germ-cells in *Trichogramma evanescens*.—J. BRONTÉ GATENBY (*Quart. Journ. Micr. Sci.*, 1919, **63**, 161–74, 1 pl., 1 fig.). In this monembryonic egg-parasite the germ-cells early become segregated from the somatic region of the egg, and while the somatic nuclei are, so to speak, undergoing phenomenal changes, losing

chromatin, becoming altered from time to time, or occasionally degenerating, the germ nuclei remain resting. It is tempting to consider that the dense germ-cell determinant is, during this time and later on, acting as a reserve store, while many changes take place in the somatic nuclei. The latter must procure their nutriment from the egg of the host (*Donacia*), and during this they are also becoming disposed to form the germinal layers. The function of the determinant seems to be that of preventing the germ-cell nuclei from being exposed to the uncertain conditions existing elsewhere in the segmenting egg and embryo. The germ nuclei do not differ at first from the other segmentation nuclei. Certain nuclei become germ-cell nuclei only because of their accidental position in the egg, towards the close of segmentation, in the region of the posterior pole.

J. A. T.

Polyembryony in Parasitic Hymenoptera.—J. BRONTÉ GATENBY (*Quart. Journ. Micr. Sci.*, 1919, **63**, 175-96, 2 pls.). The important facts are summarized. The polyembryonic Hymenoptera are generally small insects about 1 mm. in length, which lay 1-10 or more eggs in the ovum of the host. The ovum is not killed, but develops into a larva containing the parasite's ova, generally in the hæmocœl. The parasite's egg gives off polar bodies, and may or may not be fertilized. The polar bodies rest for a time, but then break into activity, forming an actively growing mass or collection of nuclei. The part of the egg-cytoplasm containing the segmentation-nucleus separates off from the outer part containing the active polar nuclei. The germ-cell determinant goes to the former, but later becomes absorbed and lost to sight. The polar cytoplasm or ooplasm containing the polar nuclei forms an investing sheath around the contained embryonic ooplasm which gives rise later to the embryos. The polar ooplasm nourishes the inner embryonic mass, and acts as an amnion (tropho-amnion) or placenta. Its nuclei, derived from the original polar body nuclei, become very numerous. Certain cells of the host-embryo, either hæmolymp or fat cells, or both, form an outer covering to the parasitic germinal mass. This host-covering afterwards becomes much stretched and epithelial in character, but in some forms it is not well developed. The primary embryonic cell which was separated off when the polar nuclei began to be active has now divided many times, giving rise to many germinal masses. This polygerm, lying in its host's hæmocœl, goes on forming more masses, and becomes constricted into areas each containing an embryonic mass, surrounded by two membranes—the outer host-epithelial and the inner tropho-amniotic layer. The shape of the whole may be a ramifying cylindrical body, or an irregular mass constricted here and there by the outer membranes. Each separate germinal mass is now a spherical or ovoid morula containing a score or more cells. The latter keep on dividing. The embryonic or germinal mass now begins to differentiate: the surfaces of the embryo become distinct, the stomodæum and proctodæum are formed by invaginations of the two extreme ends of a ventral groove, the ectoderm is formed by a rearrangement of the outer cells of the morula, the endoderm and mesoderm are formed *in situ* by a modification of the more centrally placed

cells of the embryo. The larvæ at the later stage break away from their membranes and are free-living for a time. They afterwards eat up nearly everything in the host-caterpillar's body and then pupate (usually inside, in some cases apparently outside) the body of their host. Broods may be purely female, or purely male, or mixed (from several ova). As far as is known, fertilized eggs develop into females, unfertilized into males.

In discussing these facts established by various investigators, Gatenby comes to the following conclusions:—1. The "germ-cell determinant," being possibly a nutrient cytoplasmic mass, has no other effect than that of temporarily stopping mitosis in the cells which happen to contain it. There is no evidence for supposing that the "germ-cell determinant" cells form the germ-cells of each embryo. 2. There is absolutely no evidence in polyembryonic species of a "germ-track." Everything is, in the first place, subservient to the production by haphazard divisions and fragmentations, of numerous morulae, without any discoverable definite regions. Differentiation of germ-layers follows later. Mere position in the morula is all that seems to determine whether this or that cell will be an ectoderm or endoderm cell, and so on. J. A. T.

Insect Parasites of some Coccidæ.—A. D. IMMS (*Quart. Journ. Micr. Sci.*, 1918, **63**, 293-74, 34 figs.). An account is given of *Blastothrix britannica* Gir., and *Aphycus melanostomatus* Timb., two important Chalcid parasites of the scale-insect, *Lecanium capræ*, which is widely distributed in England, especially on hawthorn. There are in the year two generations of *B. britannica*; males and females occur in approximately equal numbers; the first generation of adults are derived from hibernated larvæ and emerge during May and early June. The female lays one egg or several eggs in the young fully-grown host, perforating the body-wall and leaving the pedicel of the egg projecting on the exterior. The newly hatched larva is unique among Hymenoptera in being metapneustic; its spiracular extremity remains attached to the chorion of the egg, so that free air is available. Later on it loses this attachment and becomes peripneustic with nine pairs of open spiracles. It lies free in the cavity of the body of the Coccid; it may be enclosed in a phagocytic sheath. Pupation occurs in the host. One host may harbour forty-two pupæ.

The second generation of adults emerge in greatest numbers during the first three weeks of July. The females utilize the very young larval Coccid hosts for purposes of oviposition, and lay an egg in each. The larvæ remain through the winter with their hosts and pupate, as a rule, during the following April.

In *A. melanostomatus* there are also two annual generations. Males occur in the approximate proportion of 1:3 females. The first generation of adults emerges between the beginning of May and the end of June. The eggs have no pedicel. The newly hatched larvæ are apneustic, respiration being cutaneous. They afterwards become peripneustic with nine pairs of open spiracles, and are usually enclosed in a sheath or cyst. Pupation occurs within the host; there may be 1 to 48 pupæ in one.

The second generation of adults emerge about the same time as those of the previous species. They utilize the very young larval hosts for oviposition, only one egg being laid in each Coccid. The larval parasites winter in the apneustic condition in their hosts. A partial third generation of adults has been observed.

The results of the first generation of parasitism on the host are economically negligible for both species. The hosts do not succumb until after they have deposited their ova. The effects of the second generation of parasitism are complete; about 40 p.c. of the hosts are attacked and destroyed a long time before attaining sexual maturity. The second generation limits the abundance of the host, and keeps it from becoming a pest, notwithstanding its high fecundity. J. A. T.

Somatic Mitosis of *Stegomyia fasciata*.—LUCY A. CARTER (*Quart. Journ. Micr. Sci.*, 1918, 63, 375-86, 1 pl.). The development of the eggs of this mosquito is very rapid, the fulfilment of a condition necessary for the successful study of somatic mitosis, in order that a copious supply of dividing nuclei may be secured in a single specimen, thus rendering the seriation of stages possible. The present investigation had for its immediate aim to discover whether there is a pairing of the chromosomes in the somatic tissues. The diploid or normal number of chromosomes is four. A varying degree of parasynesis (pairing of the chromosomes) is exhibited in the somatic cells, extreme cases giving the haploid (or "reduced") number. Each telophasic (i.e. at the close of mitosis) mass of chromatin gives rise directly to a synzetic nucleus (i.e. with a clumping together of the chromatin) instead of the usual "resting" nucleus. The nuclear membrane persists throughout mitosis. The homologous chromosomes pair either in anaphase or in telophase.

J. A. T.

Seashore Diptera.—J. W. YERBURY (*Journ. Marine Biol. Association*, 1919, 12, 141-5). An annotated list of Diptera collected near Plymouth which spend a considerable part of their existence in salt or brackish water. They are grouped according to their surroundings—in salt-water pools, on wet rocks, under dead seaweed, on wet sand, on dry sand, on mud flats, in salt marshes, and so on. A few forms may be named:—*Clunio marinus*, *Aphrosylus raptor*, *Scatophaga litorea*, *Fucomyia frigida*, *Chersodromia cursitans*, *Hydrophorus bisetus*, and *Hydrophotus bipunctatus*.

J. A. T.

Lecture on Fleas.—G. H. RODMAN (*Photomicrographic Journal*, 1919, 8, 2-19, 4 figs.). A flea like that of the mole has been obtained in Eocene amber. Opinion inclines in favour of a special order, Siphonaptera. The eggs are at first sticky and adhere to the substratum on which they are laid. The larvæ hatch out in two to ten days. The egg-opener is lost after the first moult. The caudal stylets of the larvæ are used as props in creeping and wriggling. After fifteen to twenty days the larva spins a cocoon, including in the wall some débris. In about seventeen days the adult flea emerges. In *Pulex irritans* the adult can live for a long time (100 days in experimental conditions) without food; in the European Rat Flea (*Ceratophyllus fasciatus*) a month is about the limit. After pairing, the female usually requires a

meal of blood before egg-laying. The antennæ appear to be more developed in the male. The irritation following a flea-bite is due to the action of the insect's saliva. In jumping, a flea can raise its body about eight inches, about a hundred times its own height. The pygidium on the back of the ninth abdominal segment has fourteen areolæ; from the centre of each a sensory hair projects. It seems to be stimulated during copulation. The author illustrates the internal structure of fleas, compares different genera, and discusses their varied practical importance.

J. A. T.

Luminescence in Tiger-moth.—I. ISAAK (*Biol. Centralbl.*, 1916, **36**, 216–8, 2 figs.). Two luminous points occur on the prothorax of *Arctia caja*; the luminosity is due to the secretion of a yellowish fluid; it appears under the influence of mechanical stimulation, and may have protective value.

J. A. T.

Wing-markings of Sphingidæ.—J. F. VAN BEMMELEN (*Proc. Royal Acad. Amsterdam*, 1918, **21**, No. 8, 1–16, 1 pl.). From the study of patterns it is possible to decide in regard to a new group, which form is most primitive. Thus among Sphingidæ it seems probable that *Smerinthus populi* is a very primitive form, the arguments being that there is a far-going similarity between fore-wing and hind-wing, on both surfaces, and that the pattern over the entire wing-surface shows the same simple motif—a regular alternation of darker and lighter transverse lines and bands, each composed of spots. The fundamental plan is not only older than the genus *Smerinthus*, but even than the family of Sphingidæ, perhaps than the entire order of Lepidoptera. So it cannot be regarded as characteristically generic. The author proceeds to show how the colour-design on the upper side of *S. ocellata* can be derived from that of *S. populi*. The changes are such as occur in other species and in other genera; but they are accompanied by subtle nuances in *S. ocellata*. “The special refinement and the elaborate details by which the pattern of *S. ocellata* surpasses that of other Sphingidæ near akin may well be the consequences of natural selection, which could enter into action as soon as, by coincidence of hereditary variations of the fundamental Sphingid pattern with special circumstances of life, a deceptive likeness had been established to the face of a big-eyed owl, which frightened away little birds and mammals.”

J. A. T.

Genetic Studies on Mediterranean Flour-moth.—P. W. WHITING (*Journ. Exper. Zool.*, 1919, **28**, 413–43, 2 pls., 1 fig.). The study of *Ephestia kuehniella* Zeller was handicapped by the low fertility of the pairs. Variations in size are apparently not hereditary. Defects in the labial palps are hereditary, but irregular and apparently much influenced by environment. The abnormality of cleft tongue apparently depends for its expression on certain environmental conditions, among which humidity is important. A case of reversal of dominance is noted: sooty colour is a simple dominant type, while black is a simple recessive, but in the homozygous black moths sooty colour acts as a recessive. An explanation of this is suggested, and the question of the physiology of colour-production is discussed.

J. A. T.

X-rays and Beetles.—WHEELER P. DAVEY (*Journ. Exper. Zool.*, 1919, **28**, 447-58, 4 figs.). In a previous investigation the author shows that X-rays in sufficient amount shortened the life of *Tribolium confusum*. It is now shown that the life of the beetle may be prolonged by sufficiently small doses of X-rays. The prolongation of life due to a series of small daily doses is greater than that of larger doses given all at once. The lethal effect of an X-ray dose is less if it is split up into a series of small daily doses than if it is given all at once. By merely varying the size of the dose, the X-rays may be made to produce at will (1) a stimulation, (2) a destructive effect which occurs only after a latent interval, and (3) an instant destructive effect. J. A. T.

Behaviour of Tiger-beetle Larva.—ROB. STÄGER (*MT. Naturf. Ges. Bern.*, 1917, 22-44, 4 figs.). In making its burrow the larvæ presses most of the débris into the wall of the shaft. It is in the habit of turning rapid somersaults, jerking itself against the walls. The lower portion of the head forms a rounded polishing instrument. Hooks on a protuberance on the fifth abdominal segment serve for attachment to the wall of the shaft, which may be vertical, oblique, or even in steps. The larva does not leave the burrow. Its head-shield forms a lid to the shaft, and when ants or the like rest on this it is jerked very forcibly against the wall of the shaft near the entrance. The blood of the battered victim is sucked and the husk is thrown out. J. A. T.

Eye-colour in *Drosophila melanogaster*.—CALVIN B. BRIDGES (*Journ. Exper. Zool.*, 1919, **28**, 337-84). Experiments on "specific modifiers" of eosin eye-colour in this fly. A demonstration is given of eight mutant genes which by themselves produce little or no effect upon the eye-colour of flies homozygous for them, yet which modify the eye-colour in the sex-linked mutant "eosin." These specific modifications are clear and simple cases of multiple genes. Each is the result of the coaction of a specific modifying gene (cream *a*, cream *b*, etc.), and of a particular gene (eosin) which serves as a base or chief factor. Each specific modifier is a definite Mendelian gene on the same footing with the whole body of genes known in *Drosophila*. Each arose by mutation, a specific change in the hereditary constitution, by the transformation of the materials of a particular locus into a new form having a different effect upon the developmental process. J. A. T.

Lecanium persicæ and its Symbiotic Yeasts.—G. TEODORO (*Redia*, 1918, **13**, 1-5). In this Coccid, as in some others, there is a constant presence of a species of *Saccharomyces* which lives freely in the hæmolymp. A number of units, about a dozen, penetrate the ovum through the nutritive cells. They multiply during development and afterwards become diffused in the embryo. J. A. T.

Counteracting Insects by Fungi.—FRIEDERICHs (*MT. Nat. Ges. Bern.*, 1918, xv-xvi). The susceptibility of injurious insects to parasitic fungi has been utilized with the leaf-bug *Blissus leucopterus* in Kansas, with Phylloxera in Germany, with sugar-cane Cicadid parasites in

Trinidad, and in other cases. The author sought to infect the rhinoceros beetle (*Oryctes rhinoceros*), introduced from India into Samoa, with the fungoid parasite *Metarhizium anisopliæ*, and had some success. The beetles were attracted by rotting vegetable matter, in which they laid their eggs; the place was thickly infested with fungus; the grubs of the beetles all died. The fungus was present in the surroundings and thriving, and this seems to be a favourable condition. J. A. T.

Bee Diseases.—O. MORGENTHALER (*MT. Nat. Ges. Bern.*, 1918, xvi). The author distinguishes (a) the disease due to the fungoid parasite *Pericystis apis*, (b) the Nosema disease, (c) the "Foul Brood" and "Sour Brood" bacterial diseases (*Bacillus larvæ*, *B. apis*), (d) the "Sack Brood" disease due to an ultra-microscopical virus. Foul Brood disease is better understood than the others. It has been of late much reduced in Switzerland, thanks to the relevant Foul Brood Law and Foul Brood insurance. J. A. T.

Nearctic Pentatomoidea.—CHARLES ARTHUR HART (*Bull. Nat. Hist. Survey Illinois*, 1919, 13, Art. 7, 157-223, 6 pls.). A survey is taken of these Heteroptera of Illinois, and a key to the Nearctic genera is given. They are slender-beaked plant-feeders, though some such as *Euschistus*, may suck the juices of small insects. Some feed on the larvæ of the tussock moth. These are probably the most primitive Heteroptera. The author discusses the cæcal pockets of the intestine, the venation of the wings, and the nymph stages; but the paper is in the main systematic. J. A. T.

Yeasts and Insects.—J. PERCY BAUMBERGER (*Journ. Exper. Zool.*, 1919, 28, 1-81, 18 figs.). Experiments show that *Drosophila* living in fermenting fruit are dependent for their food supply on the synthetic and absorptive powers of yeast-cells. Similarly, in studying the relation of *Musca domestica* to manure, of *Desmometopa* to decaying meat, of *Sciara* and *Tyroglyphus* to wood, the investigator finds that all these Arthropods feed on micro-organisms. The general suggestion is made that insects inhabiting fermenting and decaying substrata of low protein content usually feed upon the micro-organisms present, and thus benefit by the power of the fungi to extract, adsorb, and synthesize many non-protein nitrogenous compounds. J. A. T.

Individuality of Chromosomes, with Special Reference to Synaptic Phase.—D. H. WENRICH (*Bulletin Museum Comparative Zoology, Harvard*, 1916, 60, No. 3). Whilst studying the spermatogenesis in *Phrynotettix magnus* the author has endeavoured to follow the history of individual chromosomes, using Fleming's strong solution for fixation, and Heidenhain's iron-hæmatoxylin and Fleming's tricolour methods for staining. The nomenclature is mainly that employed by Winiwarter and Grégoire, and in the introduction the terms are fully explained.

Three chromosome pairs, designated A, B, C, were found possessing individual peculiarities by which they could be recognized through all stages from the growth period to their division in the first spermatocyte division. The investigations go to prove that: 1. Each chromosome

has a definite organization, which appears at the same stages in all the animals studied. In the case of chromosome pair A it was possible to trace this through all stages from the spermatogonia to the spermatids, thus constituting a demonstration of a case of continuous identity or individuality through these stages. 2. Conjugation takes place by parasynapsis. The paper is arranged under convenient headings, and a good bibliography is appended; it is illustrated by a series of nine plates (121 figures) of camera-lucida drawings, and one containing nine photomicrographs. These are good and elucidate the author's views.

J. A. T.

β. Onychophora.

Early Development of *Peripatus capensis*.—EDITH H. GLEN (*Quart. Journ. Micr. Sci.*, 1919, **63**, 283-92, 1 pl.). A revision of material does not confirm the late Adam Sedgwick's view that in the early stages there are no cell limits. Undoubted cell walls can be seen both in ectoderm and in endoderm. By a cell wall is here meant a layer of non-protoplasmic substance which is formed as a secretion, and which separates the cells from one another. The difficulty in seeing them is due to the large size and extremely irregular shape of the cells, and to the numerous vacuoles in the endoderm cells. According to Sedgwick the whole of the nephridium is mesodermic. This is not confirmed, for the whole tube is ectodermic except the funnel, which is mesodermic. The nephridium of *Peripatus* is not a coelomduct, but homologous with the true nephridium of worms.

J. A. T.

δ. Arachnida.

A Hundred New Mites.—A. BERLESE (*Redia*, 1918, **13**, 115-92). An account is given of a fourth century of new Acarina from Zululand, Polynesia, Mexico, Brazil and other parts of the world.

J. A. T.

Heart of *Limulus*.—S. NUKADA (*MT. Med. Fak. K. Univ. Tokyo*, 1917, **19**, 1-104, 21 pls.). There is in *Limulus* the beginning of an auricle which beats in rhythmic harmony with the part corresponding to the ventricle. The minute structure of the wall of both parts is described at length. The stimulation and co-ordination is purely nervous; the muscle fibres do not assist. The automotor centres or stimulating ganglion-cells are not in permanent activity; the stimuli pass rhythmically to the heart muscle. Inhibitory and motor nerves regulate the activity of the heart as in Vertebrates. Indeed there is no essential difference between the activity of the *Limulus* heart and that of Vertebrates. But we cannot do more than call attention to this important physiological investigation.

J. A. T.

ε. Crustacea.

Abnormality in Australian Crayfish.—JANET W. RAFF (*Proc. Roy. Soc. Victoria*, 1919, **31**, 325-6, 1 pl.). A male of *Parachærapus bicarinatus* Gray showed the right eye slightly larger and longer in the

stalk, both the antennules to the right, the exopodites of the antennæ on a level with the left antennule and lying on each side of it, the right mandible in front of the left and unable to bite against it, a very abnormal epistoma, and so on.

J. A. T.

New Species of Meganyctiphanes.—G. COLOSI (*Monitore Zool. Ital.*, 1918, 29, 179–80). A definition of *M. calmani* sp. n., a Euphausid from the Mediterranean. The endopodite of the first pair of pleopods in the male forms a copulatory organ which is more complicated than in *M. norvegica*; and the thelycum in the female is also different.

J. A. T.

Boring Crustacea in New Zealand.—CHAS. CHILTON (*New Zealand Journ. Science and Technology*, 1919, 2, 3–15, 12 figs.). An account is given of two boring Isopods, the gribble (*Limnoria lignorum*) and the

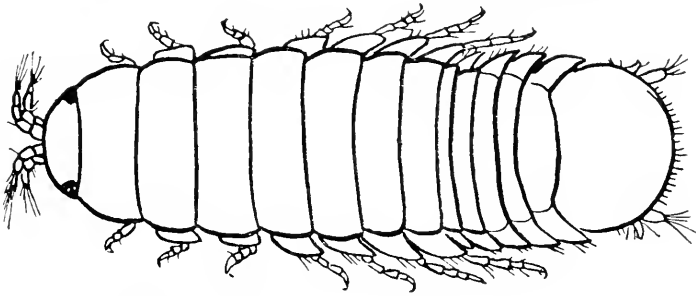

Limnoria lignorum Ratke, female. Natural size about 5 mm. in length.

closely allied *L. segnis*, and of a boring Amphipod, *Chelura terebrans*. The damage done by these borers is discussed. The woods known as "totara" and "turpentine" are very resistant, especially the latter.

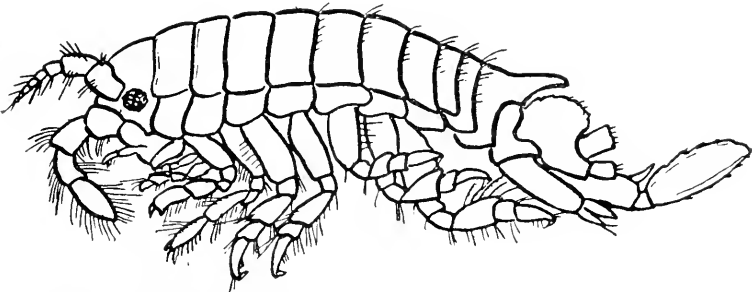

Chelura terebrans Philippi, female. Natural size about 5 mm. in length.

Marine cables are sometimes bored by the gribble. Another borer is the Isopod *Sphæroma quoyana*, which can perforate sandstone as well as wood. It has as a constant commensal a minute Isopod, *Iais pubescens* Dana, var. *longistylis* Chilton.

J. A. T.

Development of Species of Upogebia.—GLADYS E. WEBB (*Journ. Marine Biol. Association*, 1919, **12**, 81-134, 12 pls.). A careful, well-illustrated account of the larval and post-larval stages of two Thalassinidæ, *Upogebia deltura* Leach and *U. stellata* (Mont.). The larvæ were taken from the tow-nets, and their further development was observed in the laboratory. The adults live in long burrows beneath the mud. Several features of special interest in the development are noted as possibly indicating that sex differentiation commences at a very early period—perhaps from the very beginning of the larval development—and that the two sexes differ in the number of moults they undergo during the larval life. J. A. T.

Genus Phreatogammarus.—CHAS. CHILTON (*Journ. Zool. Research*, 1918, **3**, 81-6, 10 figs.). This genus was established by Stebbing in 1899, the type species being *P. fragilis* (Chilton), a blind species found in wells. It is near to *Gammarus*, but the first joint of the mandibular palp is not very short, the first and second peræopods are shorter than the third, the fifth is the longest, the third uropod is long, with two one-jointed cylindrical rami. Two New Zealand species have been added, *P. propinquus* Chilton from 2800 feet above sea level, and *P. helmsii* sp. n., from the mouths of streams near high-water mark. J. A. T.

Annulata.

Fossil Polychæts.—FREDERICK CHAPMAN (*Proc. Roy. Soc. Victoria*, 1919, **31**, 315-24, 2 pls.). Some Victorian Silurian fossils, often called "fucoids," turn out to be well-preserved gilt-plumes (prostomial appendages), referable to the genus *Trachyderma* Phillips. They have some resemblance to the gilt-plumes of *Dasychone* and other Sabelliform Polychæts, but a new family Trachydermidæ is probably required. A description is also given of *Cornulites younqi* sp. n., represented by trumpet-shaped tubes. The genus *Cornulites* has sometimes been referred to Pteropods, but Chapman holds that the evidence for the Annelid character of *Cornulites* is convincing. G. R. Vine has shown that the microscopic structure of the conical shell is identical in many points with that of some living Serpulidæ. He suggests that *Pteroconus* (or *Nereitopsis*) from Cornwall is also a tubicolous Annelid. J. A. T.

Early Development of Protula meilhaci.—A. SOULIER (*Arch. Zool. Exper.*, 1919, **57**, Notes et Revue, No. 1, 14-20, 4 figs.). An account is given of what follows the 32-cell stage in the development of this Annelid. There is an occurrence of the cellular arrangements which Wilson has called the rosette and cross. These also occur in Polyclads and Molluscs. In *Nereis*, *Capitella* and *Protula* the rosette and cross are formed from the same elements and lead to similar results. The cells of the rosette in *Protula* form the ciliated tuft, and those of the cross form the primordium of the cerebral ganglia.

J. A. T.

Nematohelminthes.

Study of Acanthocephala.—H. J. VAN CLEVE (*Bull. Nat. Hist. Survey Illinois*, 1919, **13**, 225-57, 7 pls.). The primary host of Acanthocephala is usually an Arthropod; the final host is a Vertebrate; there may be an intermediate host. The parasites effect mechanical injury, physiological disturbance and actual poisoning. There are but few evidences of a fixed specificity of hosts such as is found in the case of most parasites. A survey is taken of numerous Illinois species; a new definition is given of the family Neoechinorhynchidæ, two new

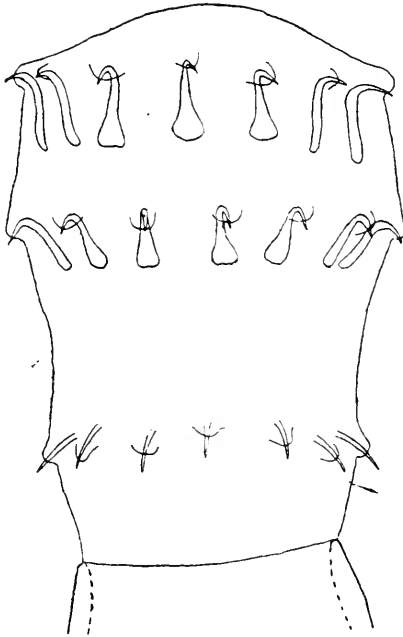

Surface view of proboscis of gravid female of *Gracilisentis gracilisentis*, showing the types of hooks and their arrangement.

genera are established, the question of specific characters is discussed, and a key is given. In *Octospinifer* n.g. the short globose proboscis has three circles of eight hooks each; in *Gracilisentis* n.g. the size is small, the body proper is unarmed, the proboscis has three circles of twelve hooks each, only a small part projects, the hooks of the terminal circle have remarkable root-processes.

J. A. T.

Study of a Nematode.—THOMAS BYRD MAGATH (*Trans. Amer. Micr. Soc.*, 1919, **38**, 49-170, 10 pls., 17 figs.). A detailed account is given of the structure of *Camallanus americanus* sp. n. from the small intestine of various species of turtle. The cuticle consists not of chitin,

but of cornein, an albuminoid probably related to the supporting tissue proteins of other animals. It is maintained that the posterior part of the œsophagus has an excretory function, waste products passing through the wall into the surrounding accessory tissue, and thence into the lateral canals. The muscular system is dealt with at length. The chief food is the blood of the host, and the fluid in the body of the Nematode is red, without doubt because of some product from the ingested blood. Only the anterior ovary and oviduct are developed; the latter contains a seminal vesicle; the species is viviparous. The nervous system consists of a nerve ring, anterior ganglia, longitudinal nerves and posterior ganglia. The anal ganglion is simple, and in the male there are large posterior lateral ganglia which supply the anal papillæ. But these are only a few of the general results of an elaborate and well-illustrated study. J. A. T.

Platyhelminthes.

Tapeworms of Vertebrates.—O. FUHRMANN (*MT. Nat. Ges. Bern.*, 1917, xii-xiii). A general discussion with many interesting points. In O. von Linstow's Compendium (1889) there were listed about 105 species of tapeworm from mammals and 230 from birds; now there are about 250 from mammals and 650 from birds. Of the latter 250 have been described by Fuhrmann and his students. Representatives of 74 genera are found in birds, 30 in mammals, 12 in both. Fuhrmann recognizes nine families of Tapeworms. Twenty-three years' work leads this authority to say that a particular species is always restricted to one particular group of birds, and many genera (44 out of 72) are represented only in one group of birds. This shows notable specificity. J. A. T.

Respiratory Metabolism in Planaria.—G. D. ALLEN (*Amer. Journ. Physiol.*, 1919, 48, 93-120). The oxygen consumption by *Planaria agilis* can be reduced to 30 p.c. of the normal rate by potassium cyanide in a concentration as low as 0.0002 molecular. Lower concentrations cause proportionately greater reduction than higher concentrations. There seems to be a residual oxidation amounting to about 20 p.c. of the normal which cannot be inhibited by KCN. Worms recover their normal level of oxidations rapidly and completely after removal from the cyanide solutions. The inhibition of oxidations could be attributed only in small part to the cessation of movement which results from the anæsthetic action of cyanide. J. A. T.

Carbon Dioxide Production in Starving Planaria.—C. M. CHILD (*Amer. Journ. Physiol.*, 1919, 48, 231-57). During the first few days of starvation the production of CO₂ decreases rapidly; it continues to decrease more slowly during several weeks; in advanced stages of starvation it increases. The more rapidly starvation, and particularly the reduction of the alimentary tract, occurs, the more rapidly these changes in CO₂ production take place. Fission and regulation accelerate the progress of starvation. Feeding restores the CO₂ production very quickly, and it seems that animals reduced by starvation and then fed are physiologically younger than at the beginning of starvation, and if

feeding is continued are capable of undergoing growth and physiological senescence again from the stage represented at the end of the starvation period. Susceptibility of the ectoderm and body wall increases from the beginning of starvation, while susceptibility of the alimentary tract at first decreases very markedly, and later increases. All the facts at present known indicate that, except for the decrease in functional metabolism in the alimentary tract, the rate of oxidation increases during starvation in Planaria.

J. A. T.

Susceptibility to Lack of Oxygen during Starvation in Planaria.—C. M. CHILD (*Amer. Journ. Physiol.*, 1919, 49, 403-19). Susceptibility of ectoderm and body wall to lack of oxygen, as measured either by loss of motility or by disintegration, increases progressively during starvation up to at least four months. The susceptibility to lack of oxygen of the animal reduced by starvation is about the same as, or slightly higher than, that of a fed, growing animal of the same size. The change in susceptibility to lack of oxygen during starvation is in the opposite direction from that which occurs during growth and progressive development in fed animals, and in the light of the facts already at hand concerning CO₂ production, oxygen consumption, and susceptibility to KCN, must be considered as evidence of an increase in rate of oxidation during starvation.

J. A. T.

Oxygen Consumption in Feeding and Starving Planaria.—L. H. HYMAN (*Amer. Journ. Physiol.*, 1919, 49, 377-402). The oxygen consumption increases markedly for several hours after the ingestion of food; it then begins to fall; and by the following day the metabolism has increased again to a marked degree. The oxygen consumption continues to fall in the early days of starvation, reaching a minimum value within the first two weeks. The oxygen consumption then begins to rise, and at the end of a period of prolonged starvation it is much higher than in animals starved only a few days. There are similar data in regard to other animals. It may therefore be concluded that starvation increases the metabolic rate of organisms, and that starved organisms are metabolically in a condition similar to that of young organisms.

J. A. T.

Respiratory Metabolism in Planaria.—G. D. ALLEN (*Amer. Journ. Physiol.*, 1919, 49, 420-73). The oxygen consumption of *Planaria maculata* and *P. agilis* decreases progressively during starvation at constant temperature, more rapidly at first and somewhat more slowly later. The body weight also decreases during starvation, and the worms become smaller in body dimensions. The rate of oxygen consumption per unit of body weight in starving *P. maculata* and *P. agilis* decreases rapidly during the first few (7) days, due to the decreasing accelerative effect of food residuum from the previous feeding. At the end of this period (7 to 14 days) the rate of oxidations reaches a constant level, which is maintained for several weeks in *P. agilis*. During this period the starvation results in a decrease in the body weight of at least one-half of the original. The ingestion of food by starving specimens results in a great increase in the oxygen consumption. After this initial

rapid rise, which reaches its maximum within the first 48 hours or less, the rate of oxidations per unit of body weight falls more slowly during 7 to 14 days to reach a constant level.

The later period of starvation, after the accelerative effects of food reserves have disappeared, is the proper basis of reference in studying respiratory metabolism in *Planaria*. Larger individuals have a lower rate of oxidations per unit of total body weight than smaller individuals when these do not owe their small size to starvation.

After fission of a large worm, the tail-piece, which becomes re-organized into a small-sized worm, gains a higher rate of oxygen consumption per unit of body weight. With regeneration in the anterior piece, which does not involve important alterations in the body, the rate of oxygen consumption remains constant within the limits of accuracy of the method. It is not assumed that the increase in rate of oxidations in the posterior piece is due to the use of measurable amounts of energy in the processes of regeneration or morphogenesis as such.

The susceptibility of *Planaria* to the toxic action of potassium cyanide and alcohol, as reported by Child, varies independently of the rate of oxidations per unit of body weight, and is, therefore, not a reliable measure of the oxidations as thus defined. J. A. T.

Rotatoria.

Oxygen and Sex-determination in Rotifers.—DAVID D. WHITNEY (*Journ. Exper. Zool.*, 1919, **28**, 469-92). The green Flagellate Chlamydomonas gives off free oxygen in the sunlight, not in darkness. No appreciable quantity of free oxygen was found to be contained within the individual cells of Chlamydomonas when they were transferred from their original culture water to other water. Culture water free from decomposing materials absorbs free oxygen from the surrounding air until its capacity of 7-8 c.c. per litre is reached. Now in the sunlight fewer male Rotifers and also fewer male-producing female Rotifers are produced in culture water containing Chlamydomonads, which have given off much free oxygen, than are produced in darkness in culture water containing less free oxygen. This is due to the fact that in the sunlight the Chlamydomonads become less available as food for the Rotifers, while in the darkness they remain more available for food throughout several days and nights. Culture water containing the minimum quantity of free oxygen (1-3 c.c. per litre) necessary for normal activities of Rotifers yields as many male-producing females as culture water with 2-8 c.c. of oxygen per litre. Therefore oxygen is not a factor in causing a production of males except inasmuch as it is necessary for all life-processes and activities. J. A. T.

Echinoderma.

Development of Heart-Urchin.—E. W. MACBRIDE (*Quart. Journ. Micr. Sci.*, 1919, **63**, 259-82, 1 pl.). As compared with the more primitive regular sea-urchin, the heart-urchin (*Echinocardium cordatum*) discards the larval appendages and relinquishes its free-swimming life at a far more advanced stage, but the time occupied in reaching this stage is much shorter. To reach the period of metamorphosis the

heart-urchin requires 18 to 20 days as compared with 6 to 8 weeks in the regular sea-urchin. The young *Echinus*, with its horizontal radial canals ending in unpaired tentacles, is really an Asterid, whereas the young *Echinocardium*, with its meridional radial canals terminating in sensory knobs and its central anus, is really a regular sea-urchin. It illustrates tachygenesis. It follows that the whole history of the changes converting the regular type into the Spatangid type is contained in the post-larval development of *Echinocardium*, but this is very difficult to follow.

The author's principal results are as follows:—1. Only one pore-canal is developed; it is formed as a vertical outgrowth from the left anterior coelom which meets a shallow indentation of the dorsal ectoderm. 2. Although there are no teeth, five dental sacs are formed in the larva; they give rise to spines with a ball-and-socket joint. 3. The left anterior coelom becomes modified into an axial sinus, but this—in contrast to what occurs in regular urchins—remains small and becomes vestigial in the adult. 4. A large madreporic vesicle is formed, arising as a dorsal outgrowth of the right anterior coelom. 5. The hydrocoele sends out five lobes which become the radial canals of the water-vascular system; the tips of these canals terminate in sensory knobs, but they never project freely as unpaired tube-feet as they do in the larvæ of the regular sea-urchin. 6. From the basal portions of the radial canals there arise a series of five freely projecting tube-feet, one from each canal. These tube-feet are the only ones which the young sea-urchin has when it assumes the adult form. They become the buccal tube-feet. 7. The young sea-urchin when it assumes the adult form has an anus in the centre of the dorsal surface, and the intestine is curved in a reversed coil like that of a regular sea-urchin. 8. All the spines of this stage are similar to those of a regular sea-urchin, except those of the sub-anal fasciole which are precociously developed. 9. After metamorphosis the epithelium of the larval gut undergoes ecdysis, just as in one of the higher insects. The epithelium of the adult gut is regenerated from pockets of cells which remain in the embryonic condition. At the same time the gut shrinks greatly in diameter, and the volume of the coelomic cavity increases. It seems that an important factor in metamorphosis is alteration in the permeability of the gut-wall. J. A. T.

Cœlentera.

Palæozoic Victorian Hydroids.—FREDERICK CHAPMAN (*Proc. Roy. Soc. Victoria*, 1919, 31, 388–93, 2 pls.). Descriptions are given of *Archæolafoëa longicornis* g. et sp. n. like *Lafoëa*, *Mastigograptus mongettæ* g. et sp. n., *Archæocryptolaria* g. n., with two species, near *Cryptolaria*.
J. A. T.

Australian Hydroids.—W. M. BALE (*Proc. Roy. Soc. Victoria*, 1919, 31, 327–61, 2 pls.). It is pointed out that in its most important peculiarity—the form of the oral portion of the hydranth—Broch's *Bonneviella* agrees absolutely with *Silicularia undulata* and *Orthopyxis calculata*. A description is given of *Sacculina arenosa* g. et sp. n., a curious zoophyte, perhaps the same as Lamarck's *Tibiana ramosa*. It has string-like monosiphonic stems, singularly irregular in form, with numerous

swellings on all sides from which the polyp-tubes originate. (The name *Sacculina* is surely appropriated for a familiar parasitic Crustacean.) Descriptions are given of *Ophiodes australis* sp. n. and *Aglaophenia bakeri* sp. n., and notes on many species of *Plumularia* and other genera. The Australian species of *Hydra* are also discussed. J. A. T.

Growth of Coral Reefs.—A. G. MAYER (*Year Book Carnegie Institution*, 1918, 17, 168–70). On the upper surface of a Samoan reef-flat, measuring 2,550,000 square feet, a computation was made of the number of heads of *Porites*, *Acropora*, *Pocillopora*, *Psammocora*, and *Pavona*, and of their growth in a year. They appear to add about 805,000 lb. of limestone each year to the upper surface, and other genera will raise the amount to 847,000 lb. On the minus side must be reckoned the loss due to the wash of the breakers (100,000 lb.), to solution by Holothurians (2,900,000 lb.), and to other destructive agencies. As the reef-flat grows outward the shorewards parts are destroyed, and the reef-flat appears to be deepening at present, though the average depth of water over it at low spring tide is less than twelve inches. This does not mean that a fringing reef must necessarily change into a barrier reef, for “as the reef-flat deepens the factors which destroy it probably diminish and a balance may be attained between the accession of limestone due to growth of corals and other organisms and its loss due to mechanical and organic causes.” Mayer finds that the Samoan corals grow fully twice as fast as do those of Florida and the Bahamas according to Vaughan. This is probably due to the better food supply in the Pacific. J. A. T.

Corals of Pacific Coast of Canada.—S. J. HICKSON (*Bionomical Leaflets, McGill University, Montreal*, 1917, 6, 21–4). The fauna of the coast from Puget Sound to Alaska is relatively little known. Attention is called to two Pennatulids: *Osteocella septentrionalis* Gray, a long fleshy sea-pen, with a skeletal rod of bone-like hardness; *Leioptilum quadrangulare* (Moroff), with kidney-shaped pinnules and marginal teeth on the calices; to five Alcyonarians, *Paragorgia arborea* (Linn.), which also occurs off Norway; *Primnoa willeyi* Hickson, also circum-polar; *Caligorgia fraseri* Hickson; *Psammogorgia teres* Verrill; and *Clavularia moresbii* Hickson. Reference is also made to *Stylaster norvegicus* Gunnerus and to two Madreporarians—namely, *Balanophyllia elegans* and *Paracyathus caltha*. J. A. T.

Respiration Rates of Samoan Alcyonarians.—LEWIS R. CARY (*Year Book, Carnegie Inst., Washington*, 1918, 17, 164–5). In *Alcyonium flexile* there was a consumption of 82.8 c.c. O₂ per kilogram of fresh weight per hour; in *Lobophytum confertum*, 55.424; in *Lobophytum rigidum*, 42.4; in *Sarcophytum glaucum*, 21.3. In the last the spicule content is only about 6 p.c.; in the species of *Lobophytum* it is near 20 p.c.; so that the oxygen consumption in the latter would appear much greater. But in *Alcyonium flexile* the proportion of spicules is only slightly greater than that in *Sarcophytum*, so the explanation of the differences in terms of spicule percentage is inadequate. The author notes that at Tortugas he observed that the species

with the greatest area in proportion to weight showed far more active respiration than do less finely divided forms. We may note that no reference is made to the symbiotic Algae, their presence or absence, their abundance or sparseness. Do they not affect the respiration rate?

J. A. T.

Protozoa.

New Coprozoic Flagellate.—A. ALEXEIEFF (*Arch. Zool. Expér.*, 1919, 57, Notes et Revue, No. 1, 1-11, 3 figs.). In macerated horse-dung there appeared on the fourth day an abundance of a new Flagellate,

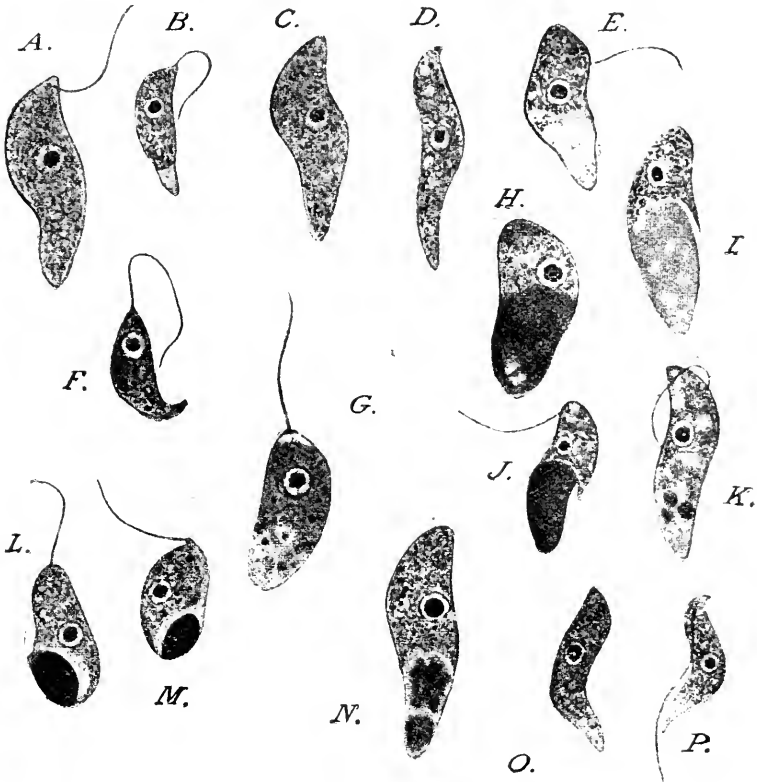

Alphamonas coprocola g. et sp. n. × 2250.

A.-D., individuals without digestive vacuole. E., I, N., individuals with well-developed digestive vacuole. L., M., the digestive vacuole almost filled with an ingested organism. D., P., young individuals soon after the multiplication by pseudocysts.

Alphamonas coprocola g. et sp. n., which persisted for three days. It is a very minute form with a sigmoid curvature, with two very delicate flagella, one anterior and one recurrent, with an anterior alveolar region

and a posterior homogeneous zone. The latter represents a large food vacuole containing a siderophilous body. There seems to be no binary fission, only an internal division into four pseudocysts. During the division the monad has no flagellum, and its shape is globular. It is probable that this new form is one of the Protomonadinæ, not far from *Ancyromonas sigmoïdes*. Perhaps it is the same as *Bodo celer* described by Klebs. According to Alexieff, *Alphamonas* is of particular interest, inasmuch as it links Bacteria and Flagella. It suggests Bacteria in its stiff curved shape, its very delicate flagella, and the formation of spores with epiplasm.

J. A. T.

Peculiar Polymastigote Flagellate.—CHARLES ATWOOD KOFOID and OLIVE SWEZY (*Univ. California Publications in Zoology*, 1919, **20**, 1-20, 2 pls., 1 fig.). A description of *Streblomastix strix* g. et sp. n.

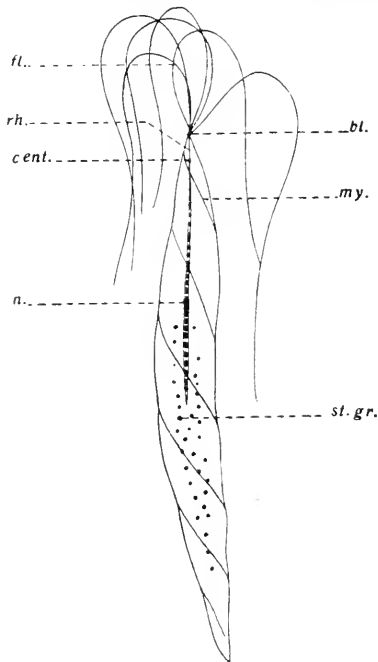

Semi-diagrammatic figure of *Streblomastix strix* g. et sp. n.

bl., blepharoplast; *cent.*, centrosome; *fl.*, flagella; *my.*, myonemes;
n., nucleus; *rh.*, rhizoplast; *st.gr.*, stained granules.

from the intestine of the Californian termite *Termopsis angusticollis*, where it is usually attached to the intestinal epithelium posterior to the Malpighian tubules. It is linear in shape, with an elongated nucleus. Its neuromotor apparatus consists of centrosome, blepharoplast, four myonemes, and six flagella connected with the nucleus by the rhizoplast. Binary fission apparently occurs without spindle formation. The nucleus

elongates and is constricted. Multiple fission also occurs. It may be preceded by the formation of giant individuals, in which the nucleus may divide several times, eight sometimes occurring. A "linear plasmodial phase" of this sort separates by plasmotomy into its constituent zooids. The parasite feeds by osmosis; there is no mouth. The spiral course of

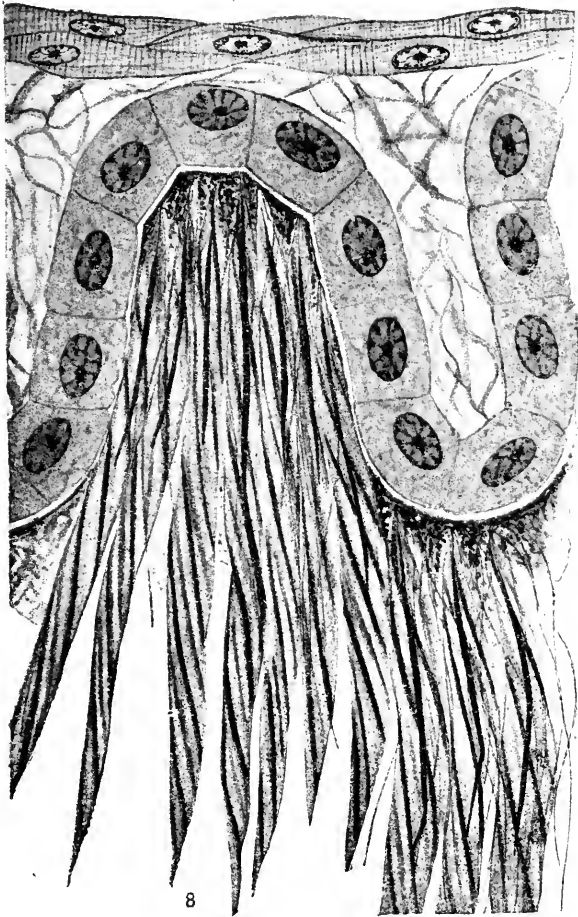

Parasites in villi of intestine attached to mucous lining. $\times 3000$.

myonemes is effective for an energetic thrust against or into the cells of the host. The long nucleus is advantageous for nucleo-cytoplasmic exchanges in the absence of marked cyclosis. The new type, which requires a new family, links Polymastigina and Trichonymphidæ, but without close relations in either group.

J. A. T.

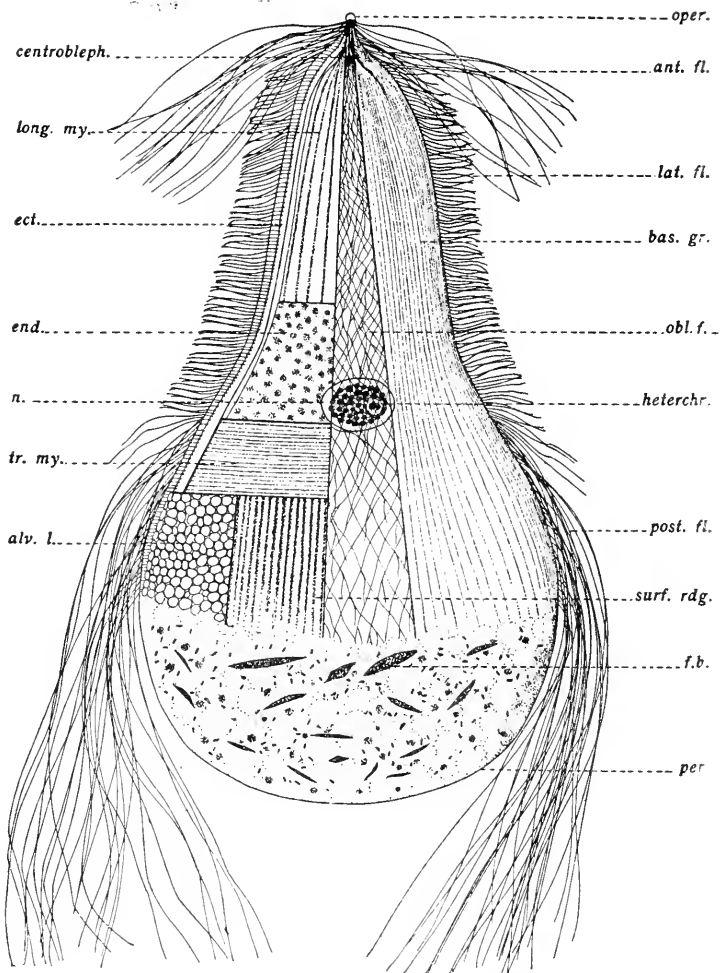

Diagrammatic figure of *Trichonympha campanula* sp. n.

Sections of the body show the structures found at different levels.

Surface ridges form the outer layer with their rows of flagella; beneath are successively the oblique fibres, alveolar layer, and transverse myonemes. In the endoplasm are the longitudinal myonemes.

alv.l., alveolar layer; *ant.fl.*, anterior zone of flagella; *bas.gr.*, basal granules; *centroleph.*, centrolepharoplast; *ect.*, ectoplasm; *end.*, endoplasm; *f.b.*, food bodies; *heterchr.*, heterochromosome; *lat.fl.*, lateral zone of flagella; *long.my.*, longitudinal myonemes; *n.*, nucleus; *obl.f.*, oblique fibres; *oper.*, operculum; *per.*, periplast; *post.fl.*, posterior zone of flagella; *surf.rdg.*, surface ridges; *tr.my.*, transverse myonemes.

New Species of *Trichonympha*.—CHARLES ATWOOD KOFOID and OLIVE SWEZY (*Univ. California Publications in Zoology*, 1919, 20, 41-98, 6 pls., 4 figs.). A description of *T. campanula* sp. n., which has a highly specialized flagellate type of structure and a highly developed neuromotor system. The centroblespharoplast is connected by a complex

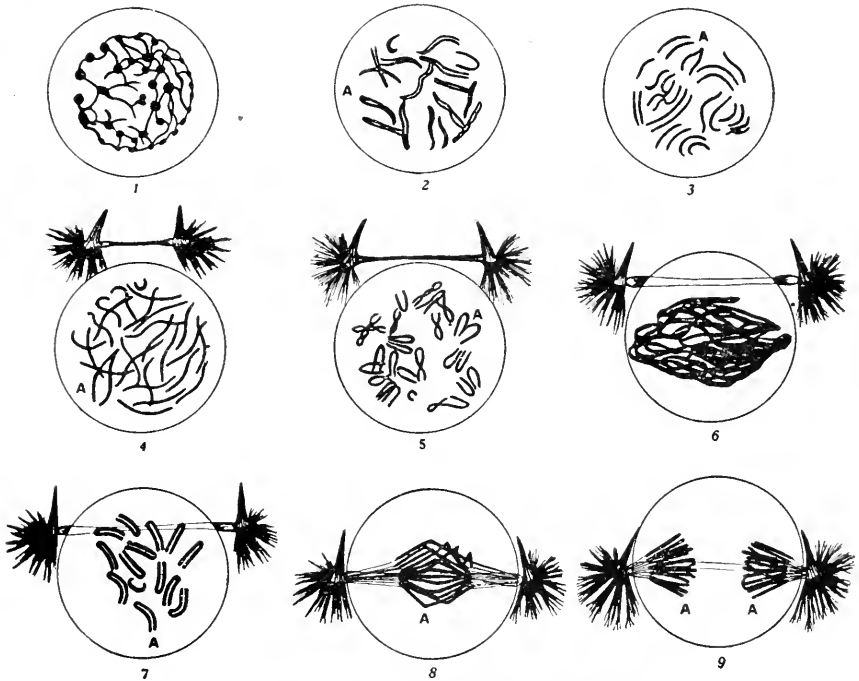

Nuclear mitosis in *Trichonympha campanula*.

One half the number of chromosomes is shown. 1-7 prophase.

1. Vegetative phase of chromatin-encrusted network. 2. Splitting of the chromosomes. 3. Separation of chromosomes resulting from splitting; paired arrangement noticeable. 4. Paradesmose formed between daughter centroblespharoplasts. 5. Formation of loops; nucleus approaching elongated paradesmose. 6. Tangled stage in which the pseudo-synapsis occurs. 7. Number of chromosomes reduced one half. 8. Metaphase; looped chromosomes unfolding on the spindle. 9. Late anaphase; paradesmose still connecting centroblespharoplasts. Chromosome marked A is splitting in fig. 2, appears as two chromosomes in 3 to 5, is re-united in 7 and 8, and separated into two distinct chromosomes in 9. The small coiled chromosome is the heterochromosome.

system of oblique fibres with the numerous flagella which cover two-thirds of the surface of the body. Besides these fibres the ectoplasm contains an alveolar layer and one of transverse myonemes. Immediately below it in the endoplasm are the longitudinal myonemes. The nucleus

is submedian, and part of its chromatin is permanently separated as a "heterochromosome" contained within a small vesicle. Nutrition is holozoic. There is no cytostome. The posterior endoplasm is usually filled with food particles, and is covered only by a thin pellicle, in contrast to the thick ectoplasm elsewhere. The body rounds up at the time of division and the centrolepharoplast divides, forming a parademose, the entire ectoplasm splitting into two parts with it. These act as the centrosome in the succeeding mitotic figures, the spindle fibres arising from the ends of the parademose or the centrolepharoplasts. Precocious splitting of the chromosome, previous to the prophase, forms 52 V-shaped threads. The type is indubitably one of the Flagellata in the family Trichonymphidae, in the order Hypermastigina Grassi, near Polymastigina. J. A. T.

New Trichonymphid.—CHARLES ATTWOOD KOFOID and OLIVE SWEZY (*Univ. California Publications in Zoology*, 1919, **20**, 99-116, 2 pls., 1 fig.). A description of *Leidyopsis sphaerica*, from the intestine of *Termopsis angusticollis* Walker, a Californian termite. This Trichonymphid is characterized by the presence of a neuromotor system, consisting of a highly developed centrolepharoplast, oblique fibres, basal granules and related flagella restricted to a single anterior zone, a differentiated ectoplasm on the anterior third of the body, surface ridges from the crest of which spring the flagella, and an alveolar layer. The

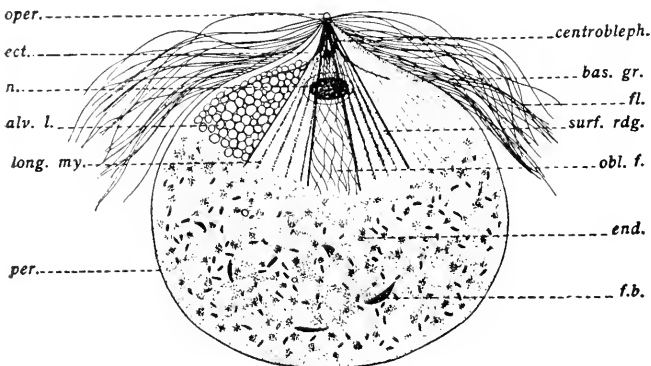

Diagrammatic figure of *Leidyopsis*. Ectoplasm drawn in sections.

alv.l., alveolar layer; *bas.gr.*, basal granules; *centroleph.*, centrolepharoplast; *ect.*, ectoplasm; *end.*, endoplasm; *f.b.*, food bodies; *fl.*, flagella; *long.my.*, longitudinal myonemes; *n.*, nucleus; *obl.f.*, oblique fibres; *oper.*, operculum; *per.*, periplast; *surf.rdg.*, surface ridges.

nucleus is anterior in position, and is distinguished by the presence of a heterochromosome contained within a small vesicle. Nutrition is holozoic. Division is of the Trichonymphid type. The centrolepharoplast, with its connecting motor organellae and ectoplasmic structures,

divides longitudinally with the formation of an extra-nuclear parades-mose between them as the two parts separate. Division of the chromosomes (about 48) is longitudinal. The nuclear membrane remains

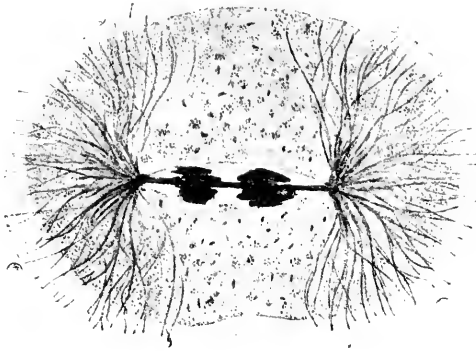

Anaphase of *Leidyopsis*. Note the flagella and other ectoplasmic structures attached to centroblespharoplasts. + 300.

intact throughout mitosis, with the spindle fibres arising from the ends of the parades-mose and centroblespharoplast and passing through it.

J. A. T.

New Species of Trichomitus.—CHARLES ATWOOD KOFOID and OLIVE SWEZY (*Univ. of California Publications in Zoology*, 1919, **20**, 21–40, 2 pls. 2 figs.). A description of *T. termitidis* sp. n. from the intestinal tract of *Termopsis*, where it is apparently not pathological. It feeds on the intestinal débris. There is a highly developed neuromotor system with parabasal body, undulating membrane, centroblespharoplast, and flagella attached by a rhizoplast to the nucleus. Binary fission occurs frequently. Mitosis is marked by the development of a large parades-mose following the separation of the centrosome from the blespharoplast. One schizont retains the old parabasal body and membrane, while new ones are formed for the other. Multiple fission results in the formation of an eight-zooid somatella, followed by plas-motomy. The new species differs so much from *T. parvus* in the process of mitosis that a new subgenus, *Trichometopsis*, is proposed for it.

J. A. T.

Flagellate of Lizard found also in Tick.—ED. REICHENOW (*Bol. Inst. Nacional Higiene, Madrid*, 1918, **14**, 183–204, 1 pl.). A Flagellate, *Eutrichomastix lacertæ* (= *Trichomastix lacertæ* Chatton), which occurs in the gecko and in other Lacertilia (*Lacerta muralis*, *L. viridis*, *L. ocellata*, *Psammodromus hispanicus*, and *Acanthodactylus vulgaris*), is also found to occur in a blood-sucking tick. In Lacertilia the parasite has been found both in the intestine and in the blood; in the tick *Liponyssus saurarum* it occurs in the cells of the intestinal epithelium.

J. A. T.

Amœba Proteus.—LUCY A. CARTER (*Proc. Roy. Phys. Soc. Edinburgh*, 1919, **20**, 193–210, 1 pl.). A careful study of amœbæ referable to *A. proteus* shows the existence of three “types,” which are described and designated as *A. proteus X*, *A. proteus Y*, and *A. proteus Z*. These three “types” should not be given new specific names until there is more certain proof that they are distinct species, rather than phases in the life-history of one species. If they can be separated as species, older names should be preferred to new ones, thus *A. proteus* Pallas (*X*), *A. princeps* Ehrenberg (*Y*), *A. nobilis* Penard (*Z*); or *Y* might be called *A. proteus* Pallas var. *granulosa*. Schaeffer’s classification into raptorial and granular amœbæ is very useful; the raptorial type being represented by *A. proteus X*, the granular types by *A. proteus Y* and *A. proteus Z*.
J. A. T.

Promitosis and Syndiæresis: two Methods of Nuclear Division co-existing in Amœbæ of the “Limax” Group.—A. DE ZALUETA (*Trab. Mus. Nac. Cien. Nat., Madrid, Ser. Zool.*, 1917, No. 33, 52 pp., 2 pls. and text-figs.). *Wasielewskia gruberi* (Schardinger), an amœba of the “Limax” group, has two quite different types of nuclear divisions, viz. promitosis and syndiæresis, the former similar to that occurring in other amœbæ. Under the name “syndiæresis” is included a complex group of nuclear divisions, consisting of a division giving rise to two daughter-nuclei which, at the moment of separation, are themselves sub-dividing to produce two grand-daughter-nuclei. Thus syndiæresis comprises three inseparably bound divisions, the first called protodiæresis, and the other two metadiæresis. Syndiæresis takes place in special pantosome nuclei, which are different from ordinary nuclei and are of unknown origin. All the amœbæ observed were taken from cultures derived from a single carefully isolated organism, and therefore belonged to one species.

The author compares his observations with those of various earlier writers, pointing out that, though Aragao and Belar recognized two types of division, their descriptions differ essentially from those founded on these new facts and recorded under the name of syndiæresis, since they had observed neither pantosome nor metadiæresis.
J. E.

BOTANY.

GENERAL,

Including the Anatomy and Physiology of Seed Plants.

Structure and Development.

Vegetative.

Importance of Epidermal Coverings.—R. B. HARVEY (*Bot. Gaz.*, 1919, **67**, 441-4, 2 figs.). A study of the function of epidermal coverings of hairs, wax, etc., in protecting plants from injury by frost. A number of plant-tissues were tested, including leaves of carnation, cabbage and *Echeveria*, petioles of *Cineraria* and tomato, etc., and it was found that undercooling occurs to a greater degree in plants possessing epidermal coverings than in plants without them. This undercooling is not due to any substance in the cell-sap, but to the prevention of inoculation from ice formed on the surface of the tissues, by means of epidermal coverings. The importance of such coverings in frost-resistance "appears to be that they allow the plants that possess them to withstand temperatures somewhat below zero, until the cells are able to adapt themselves physiologically to the changes incident upon freezing." The writer also describes an electrical method for determining the temperatures within the tissues of the plants. S. G.

Depressed Segments of Oak Stems.—J. W. BAILEY (*Bot. Gaz.*, 1919, **67**, 438-41, 4 figs.). The author contributes a short paper in answer to a criticism of his work on *Quercus*. He maintains his previous conclusion, that the depressed segments are correlated with the presence of pairs of approximated multiseriate rays rather than with the stellate arrangement of the primary elements. In support of this theory he points out that it is possible to trace the stages of disintegration and disappearance of the rays; also, that the segments are most deeply depressed when the pairs of multiseriate rays are most fully developed. On the other hand, where the rays are absent the stellate form of the first season rapidly become circular. When the rays appear late, the appearance of the depressed segments coincides with that of the rays; moreover, when one ray of a pair does not develop, the depressed segments are asymmetrical. It is also shown by comparison with *Castanea* and *Populus* that these depressed segments cannot be explained upon physiological grounds. S. G.

Detailed Structure of Wood-vessels. [Advance note].—SALUSTIO ALVARADO (*Boletín de la Real Sociedad Española de Historia Natural*, 1919, 66-75, 7 figs.).* The author prefaces his note with a short

* The same author has published an account of this process, as applied to cytological investigation, in the preceding volume, pp. 434-46.

historical abstract, from Henshaw in 1665 to Correns, Rothert and others in the present century. He criticizes all previous work on the subject as deficient for want of a proper method of staining; and supports strongly his own process—the tannin-silver process devised by Hortega, which he says he has employed for a year with surprising

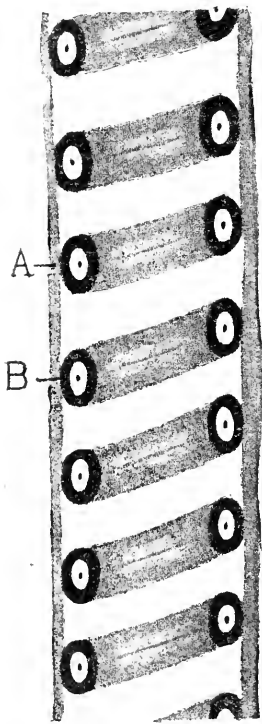

Longitudinal section of a spiral vessel of *Iris germanica*, showing staining effect. A., primary, B., secondary membrane.

results, upon wood-vessels. The wall of the vessel, apart from the thickening (to which his investigation is especially directed), he calls the "primary membrane"; this stains a barely perceptible violet. The thickenings (secondary membrane) show three very distinct concentric layers—namely, a very slender central core, which stains nearly black; this is enveloped by a fairly thick sheath which is but little affected by the stain; this in turn is surrounded by an exterior sheath of similar or greater thickness, stained with intensity intermediate between the other two. Several figures are given, making these points very clear; and the author has obtained similar results from plants of widely differing affinity. He urges the structure in question as constant for all thickened wood-elements, and attributes the differential staining to the successive addition of various substances to the elemental cellulose. He suggests analogy to the structure of starch-grains, and confirms this in a striking figure of some taken from the radicle of *Cicer arietinum*, which he treated by the same method. These show the same central deeply-stained core, a surrounding unstained part, and a moderately-stained outer coat. The author concludes that all such processes of organic development by the successive addition of layers are traceable to a few elementary chemical substances, carbohydrates and their derivatives; and that a living cell, in the

meristematic state may, by this method of staining, reveal its ultimate fate. Moreover, the constancy of the three layers suggests the constancy of these substances in question in all cases—all being derivatives of the original cellulose of the primary wall.

H. F. W.

Anatomy of the Leaf of *Lactuca saligna* Linn.—INAN CUESTA URCELAY (*Boletín de la Real Sociedad Española de Historia Natural*, 1918, 426-8, 4 figs.). A brief account of a peculiar form of hairs that occur upon the leaf of certain Compositæ. These structures have been

described previously ; but the writer draws especial attention to the facts that (1) they are present only in a small definite number of Composite genera ; and (2) they are connected intimately with the latex-tissue. This study is based upon the isobilateral cauline leaves of *Lactuca saligna* Linn., which bear cutinized hairs as well as those of the type in question. After a brief account of the internal leaf-structure, in which he describes the close relation between the latex-system and the wood-vessels, the author proceeds to describe the latex-hair as consisting usually of three cells, derived from an epidermal cell. Of these three, one much exceeds the other two in size. These cells are in such close connexion with the primary internal latex-tissue that the wall between hair-cell and latex-cell often breaks down. The author suggests from these observations that the hairs in question are actually latex-secreting hairs ; and he emphasizes the consequent continuity of these with the xylem itself.

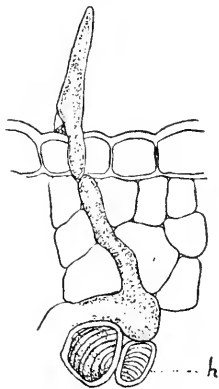

H. F. W.

The Existence of Daily Growth-rings in the Cell-wall of Cotton Hairs.—W. LAWRENCE-BALLS (*Proc. Roy. Soc.*, 1919, **90**, Series B, 542-55). The present communication describes the structure of the cellulose wall of the cotton hair, in relation to its development, as a continuation of observations previously published in "The Development and Properties of Raw Cotton" (1915). Swelling the cellulose wall

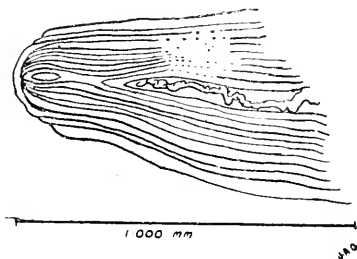

Tip of treated fuzzy hair showing details of growth-rings. The two outermost rings broken away over actual tip ; the isolated portion of the tenth ring could not be seen to be in connexion with the main bulk of the ring.

(treatment with CS_2 and $NaOH$) to some five or ten times its initial thickness renders concentric layering visible. Material of known age and development, fixed in Egypt, was examined by this method, and it was found that there is only one thin primary layer while the hair is growing in length, but that as soon as thickening of the wall sets in the number of layers increases day by day up to a maximum of twenty-five, when thickening is complete. As growth is arrested by sunshine in the

middle of each day on Egypt, the number of these layers corresponded to the number of nights during which the growth in thickness of the cell-wall had continued. These concentric layers in the wall of Egyptian cotton hairs are thus rings of nightly growth, differentiated by heterogeneity like the annual rings in timber. These rings are coarser, more sharply demarcated and less regular in fuzz hairs than in lint hairs. The later rings in fuzz hairs may resemble those of lint hairs. Certain abnormal appearances indicate that the cellulose wall may grow for a time without being in full contact with the ectoplasm. J. E.

Reproductive.

Fruit of Opuntia.—D. S. JOHNSON (*Pub. Carneg. Inst. Washington*, 1918, 1-62, 12 pls.). The author has studied *O. fulgida* with special reference to the perennation and proliferation of the fruits. Fruits of some *Opuntias* are known to remain attached to the plant and to grow actively for several years; in *O. fulgida* this condition is carried still farther, for not only does the fruit remain on the tree without shedding its seed, but both the ripe fruit and the unripe ovary may give rise to flowers and another crop of fruits. Four or five generations of fruits may thus be formed on a tree during one season. Also, when a ripe fruit falls to the ground, it may put out adventitious roots and shoots and so produce a new plant. The fleshy joints of this plant readily break off, sprout and form new plants strongly resembling those resulting from the vegetative development of the ovary; moreover, such joints become very much like a flower in appearance. Comparison of such a joint with the final development of the outer wall of the ovary and fruit, both from the morphological and physiological aspect, leads to the conclusion that the flower of this *Opuntia* has been evolved from one with a superior ovary, through progressive submergence of the ovary by stronger growth of the parts of the fertile joint. This flower is probably a primitive type among the Cactaceæ, from which the type found in *Cereus* and *Echinocactus* has been derived.

The number of well-matured seeds in a single fruit varies from 0 to 100, or even 200. Each seed contains a large coiled embryo and a small amount of endosperm, and may remain for several years in the fruit without losing the power of germination, and there appears to be reason for believing that the fruit-pulp inhibits germination. When the fruits fall on moist ground they produce adventitious roots and vegetative shoots, thus giving rise to new plants independently of the seed. This method of reproduction, together with the proliferation of detached joints, forms the chief means of multiplication and dispersal of this cactus. Similar cases of persistence and proliferation of the fruit are not unknown in other species. In *O. versicolor* and other flat-jointed *Opuntias*, this is due to the cactus-fly laying its eggs in the fruit, but at present nothing is known as to the cause in *O. fulgida*. S. G.

Embryogeny of Capsella.—R. SOUÈGES (*Ann. Sci. Nat. Botan. Paris*, 1919, Sér. 10, 1, 1-28, 69 figs.). The author has studied the development of the embryo in *Capsella Bursa-Pastoris*, with special

reference to the two lower cells of the tetrad and the tissues derived from them. The author finds that the proembryonic tetrad is comparable with that of *Myosurus minimus* and the greater number of the Ranunculaceæ, but that the two lower cells of the tetrad have a very different destiny. In *Capsella* the intermediate cell gives rise to the hypophysis and to the six cells at the distal end of the suspensory filament; the four cells forming the proximal portion of the latter, together with the large micropylar vesicle, are derived from the lowest cell of the tetrad. It will thus be seen that both cells take part in the formation of the suspensor. In this respect *Capsella* differs from *Myosurus* where the two lower cells give rise to two distinct portions of the proembryo—i.e. one cell is entirely concerned with the formation of the hypophysis, while the other develops into the short thick suspensor. It seems unlikely that the conditions of cell-division in the tetrad of *Capsella* are the same in other members of the Cruciferae. The work of other writers appears to indicate that there are most important differences in the development, number, order of formation and differentiation of the cells of the suspensor. The author concludes that while the further development of the upper cells of the tetrad is very constant, a careful study of the development of the lower cells would throw considerable light upon the comparative embryogeny of this family, and would probably prove of great use in the determination of affinities. S. G.

CRYPTOGAMS.

Pteridophyta.

Apogamy in the Cyatheaceæ.—ALMA G. STOKEY (*Bot. Gaz.*, 1918, **65**, 97–102, 10 figs.). An account of a few cases of apogamy observed for the first time in the Cyatheaceæ. The method adopted for obtaining pure cultures is described; and the factors which may or may not cause apogamy are discussed—namely, intense light, high temperature, drought, bad culture, physiological conditions. Apogamy was discovered in *Dicksonia squarrosa*, *Cyathea muricata* and *C. Tussacii*; and the anatomical conditions observed in each case are described and figured. A. G.

Observations on the Tuber of Phylloglossum.—T. G. B. OSBORN (*Ann. of Bot.*, 1919, **33**, 485–516, 1 pl. and figs.). *Phylloglossum Drummondii* occurs in South Australia as a member of the geophytic element in the flora of an area subject to prolonged summer desiccation. The average depth of the current tuber is about 1 cm., but may range from the surface down to 2 cm. at least. Whatever the depth may be, the growing plant tends to form its new tuber at an average depth of 1 cm. A new method of vegetative reproduction is described for the plant—namely, a regeneration from leaves that are injured or have become detached by accident. In such a case an adventitious cell mass is produced near the proximal end of the leaf on the abaxial surface—in fact, a sort of protocorm. On this latter a growing point is differentiated, and from it is produced a tuber. Reasons are given for regarding the protocorm and tuber as two distinct and independent structures. The

results of the investigation emphasize the biological value of the tuber, and morphological interpretations, based on anatomical evidence only, should be accepted with caution. A. G.

Anatomy of *Lycopodium reflexum*.—J. BEN HILL (*Bot. Gaz.*, 1919, 68, 226–31). In this species the two points of interest are the presence of typical cortical roots and the various “types” of stele in the stem. In the steles of the cortical roots the development and differentiation of the tissues are parallel to those in the stele of the stem. There are three arrangements of the xylem—namely, radial, parallel-banded, and radial modified so as to consist of an inner cylinder of xylem enclosing a small strand of phloem. This last arrangement is the most frequent. Thus are confirmed the author’s previous suggestion that all arrangements of xylem may occur in the same stem in species of *Lycopodium*. A. G.

Method of staining Antherozoid of Fern.—W. N. STEIL (*Bot. Gaz.*, 1918, 65, 562–3, 1 fig.). A satisfactory method of staining differentially the constituent parts of the antherozoid. The nucleus is rendered bright red by safranin, and the cytoplasm bluish pink by acid fuchsin, the blepharoplast having a deeper colour. As shown in the figure the cilia are attached for some distance along the blepharoplast, but none to the anterior end. The envelope at the anterior end extends a short distance beyond the nucleus, which is small and rod-like at this extremity. A. G.

Ferns of South Africa.—T. R. SIM (*Cambridge Univ. Press*, 1915, second edition, xi and 384 pp., 186 pls.). The region covered by the present edition is extended so as to include all territory to the south of the Zambesi. The nomenclature now adopted is that of Christensen’s *Index Filicum*; and 61 genera and 220 species are enumerated, including descriptions of six species and several varieties which are new to science. This means an increase of 27 plates and about 40 species beyond those contained in the first edition, where the area covered was much less—namely, that part of Africa lying south of the Tropic of Capricorn. The present edition treats of the whole of Africa south of the Zambesi; and the northern colonies thus brought in have proved to be much richer in ferns than had been anticipated. The features of the work are a description and figure of each species, keys to the genera and species, chapters on cultivation, ecology, distribution, etc. A. G.

Bryophyta.

Columella in *Marchantia polymorpha*.—J. E. CRIBBS (*Bot. Gaz.*, 1918, 65, 91–6, 2 pls.). Treats of the tendency of the capsule to form a columella, a point not previously noted in literature. In *Marchantia* the elaters are sometimes developed so abundantly in the middle of the capsule as to produce a columella. Intermingled with the elaters are chains of cells derived from sporogenous tissue, but failing to reach the spore mother-cell stage, and persisting until the elaters develop their wall thickenings. These sporogenous cells then disintegrate, not apparently as serving any nutritive function, but through pressure from the

elaters. A columella of this type strongly suggests the elaterophore of *Pellia*, and an advancement in the sterilization of tissues in Marchantiaceae comparable with that observed in Anacrogynæ. The author does not attribute this unusual occurrence to external factors, but considers it to be the first stage in the tendency to break up the sporogenous mass. The initial separation of sterile cells at the apex may occur even before the intrusion of the proximal part to form the foot, or it may first be recognized at the time of initial elongation of the sporogenous cells. The group of cells thus separated at the tip may be added to either by the division of the wall cells or by periclinal walls in the elongating sporogenous cells. This occurrence of a cap of sterile cells at the apex of the capsule is likewise a feature appearing prominently in members of the Anacrogynæ, where in *Aneura* it bears attached elaters. The occasional appearance of three or four layers of sterile cells at the tip, and the convergence of the elaters, together with the close relation they frequently bear to this point, are further evidences of transitional features from the diffuse arrangement of elaters (as in other Marchantiaceae) to a definite organized structure such as the elaterophore found in members of the Jungermanniales. A. G.

Contribution to the Anatomy of Mosses.—H. W. VON DANKEN-SCHWEIL (*Hedwigia*, 1915, 57, 14–61, 3 tabs., 9 text-figs.; also as a *Dissertation*, Freiburg, 1915, 48 pp. See also *Bot. Centralbl.*, 1917, 135, 392–3). The following results were obtained:—I. *Polytrichum formosum*. The rhizome exhibits:—1. A bark (“Rinde”), consisting of a thickened epidermis with rhizoids, beneath that two to three layers of thin-walled cells, and still deeper a large-celled layer (“mit 3-Teilung”), called by the author endodermis; all alive. 2. A central part, of which the living cells form, as stereome, the principal mass of the three-lobed central part, in addition to living unthickened cells on the margin of the central strand towards the endodermis (= rudimentary pericycle). The dead cells form “hydroids” (without contents, occurring scattered in the central strand and in the rudimentary pericycle), and “hypodermal” and “radial” strands; these penetrate the bark (“Rinde”) in three places. Inside the radial strands lie the “leptoids,” larger cells with somewhat wide ends, and amylome as “auskleidung” of the indentations of the central strand in a stratum of regular polygonal cells. The change from rhizome to shoot is very gradual. In the shoot five strata are to be recognized: (1) strongly thickened epidermis; (2) thickened subepidermal zone; (3) a well-developed parenchyma of the bark—a “hydrom sheath” rich in starch, and a layer with leptoids; (4) a central strand with empty cells; and (5) true leaf-traces (four to five central cells, “deuter” of leptoid-like form, and “comites”). II. *Atrichum undulatum*. The rhizome no longer exists, merely an underground organ of simple structure, very like the aerial green shoot. The central strand consists, however, of living and dead cells. III. *Mnium* has in the central strand a group of empty cells, whose power of water conduction is certainly very slight; the leaf-traces end blindly, since they cannot draw enough water from the central strand. IV. *Funaria hygrometrica* has a protective sheath

between the central strand and the bark; the central strand is mostly empty, and the remaining tissue takes over the water supply externally, since the epidermis along the entire stem is only thickened on the inner side. The development of a good system of conduction is decidedly connected with suitability to the habitat. A well-developed net of cells lies before us, devoid of all contents. Whether water is only stored in the cells, or whether it is sufficiently well-conducted as to maintain the plant in a fresh state in dry air, is an unsolved problem, and must be further studied.

E. S. G.

Scapania curta and its Allies.—H. BUCH (*Medd. Soc. Fauna et Flora Fennica*, 1916, **42**, 85–96; see also *Bot. Centralbl.*, 1917, **135**, 263–4). A revision of the three critical species *Scapania curta*, *S. rosacea* and *S. helvetica*. The author distinguishes two groups: the first including *S. curta* and *S. rosacea*, and characterized by having leaf-cells translucent, leaf-margins with two or more rows of strongly thickened cells, inner leaf-cells thickened only at the angles and having a round lumen; and the second group having the leaf-cells obscured, uniform and more or less nodose at the angles. In the second group he places *Scapania helvetica* Gottsche, and two new species, *S. mucronata* and *S. lingulata*. The first group represents the *Martinellia rosacea* of S. O. Lindberg, and the second group represents his *M. curta*.

A. G.

Desmatodon Wilczekii.—CH. MEYLAN (*Bull. Soc. Vaudoise Sci. Nat.*, 1919, **52**, 383–4). Description of a new and interesting moss gathered at 8600 feet in the Parc National on the southern slope of the Piz del Fuorn. It is a link between *Desmatodon* and *Pottia*, resembling the capsule of the latter and the gametophyte of the former. It differs from *Desmatodon latifolius* in its flat-margined leaves and smaller more papillose leaf-cells, and especially by its lack of a peristome and the adherence of the operculum to the columella. From *Pottia intermedia* it is distinguished by the shape, areolation and papillosity of its leaves.

A. G.

Notes on Braithwaite's "Sphagnaceæ Exsiccatae."—J. A. WHELDON (*Journ. of Bot.*, 1919, **57**, 142–7). A critical revision of the "Sphagnaceæ Britannicæ Exsiccatae" issued by the late Dr. R. Braithwaite contemporaneously with his monograph, "The Sphagnaceæ or Peat-Mosses of Europe and America" (1880). It brings this important series of difficult plants into line with the modern classification of C. Warnstorff.

A. G.

Miscellanea Bryologica. VI.—H. N. DIXON (*Journ. of Bot.*, 1919, **57**, 73–80). Descriptive and critical notes on some exotic mosses:—(1) *Chaetomitrium Deplanchei* Duby, and its allies; (2) *Gymnostomum oranicum* Rehm.; (3) *Anæctangium scabrum* Broth.; (4) *Taxithelium Gottscheanum* (Hampe) Broth.; (5) *Hypnum scabrellum* Lac., and its allies, with the structural characters of a new Bornean species, *Semato-phyllum decipiens* Dixon; (6) *Bryum Bescherellei* Jaeg., and the confusion that enveloped *B. erythrocarpoides* Hampe et C. Müll.; (7) *Barbella Levieri* (Ren. et Card.) Fleisch.

A. G.

Thallophyta.

Algæ.

Plankton-phase and Plankton-rate.—A. H. CHURCH (*Journ. of Bot.*, 1919, 57, Suppl. iii., 8 pp.). An account of pelagic plankton, its meaning and importance in relation to higher plant-life. Many higher plants and animals retain evidence of their plankton origin. By "plankton-rate" is meant the amount of cytoplasm in millions of spores or other organisms per litre of sea-water—a mere empirical means of estimate, based on Lohmann's observations at Kiel; and examples of this are cited and compared with the spore-output of the male fern and of *Araucaria brasiliensis*. The phytoplankton life is probably limited by the available supplies of nitrogen and phosphorus in sea-water, while animal plankton is limited by the oxygen supplies. A. G.

Melosira Røseana Rabenh., a Luminous Diatom.—B. SCHRÖDER (*Ber. Deutsch. Bot. Gesell.*, 1916, 34, 796–800; see also *Bot. Centralbl.*, 1918, 137, 23). Record of *M. Røseana*, found by the author in a grotto on the eastern side of Zobtenberg, in Silesia, where it formed a dark chocolate-brown, soft covering, 1–3 mm. thick, on the inner, dimly lighted, be-trickled wall. Although the sun was on the other side of the mountain, there could be seen, at one particular angle of vision, brilliantly green luminous patches. The date was October 29, 1916. The main constituent of the brown slime was *M. Røseana*, but *Fragilaria virescens* Ralfs, *Pinnularia borealis* Ehrb., *Hantzschia amphioxys* Grun. were present in small quantity, as well as single specimens of *Synechococcus aeruginosus* Naeg., and two species of *Cosmarium*. The reflection of the green light is ascribed principally to *M. Røseana*, and is probably caused by the same process as in *Schistostega* protonema. Whether the globular auxospores only are luminous, or whether the vegetative cells form a cylindrical mirror as well, is uncertain. Nowhere is this luminosity of *M. Røseana* mentioned in botanical literature, due possibly to its having been overlooked. It may be also that it is only luminous when it is present in great quantity, or, on the other hand, when it has a rich growth of auxospores. E. S. G.

Remarks on certain Adriatic Plankton Bacillariæ.—B. SCHUSSNIG (*Sitzungsber. Ksl. Akad. Wiss. Wien*, 124, Abt. 1, 1915, 377–406, 14 text-figs.; see also *Bot. Centralbl.*, 137, 6). A preliminary report on the observations made during the cruise of the "Najade" in 1913. A systematic enumeration of the Bacillariæ is given, with remarks on the distribution, morphology, and systematic position of each. *Rhizosolenia calcar-avis* Setzge. and *R. alata* Brightw. are very variable in form. *Chaetoceras Janischianum* Castr. is an antarctic form and variable. *C. dichæta* is however distinct from it, and must not be referred to it. New species and varieties are described. Many of the records are new for the Adriatic, or have very rarely been found there. E. S. G.

Remarks on the Bacillariaceæ Flora of the Numburg Stream.—QUELLE (*Mitt. Thüring. bot. Ver. N.F.*, 1916, 33, 68–9; see also

Bot. Centralbl., 1918, **137**, 22-3). A refutation of Lutze's contention that the presence of Bacillariaceæ in the western Numburg Stream in North Thüringen is a proof of a former ice-sheet covering this region. *Chaetoceras*, *Amphiprora* and *Bacillaria*, "true pelagic species," were said to occur inland only in this stream. In this paper it is shown that all genera are recorded from other inland stations; as well as *Nitzschia*, *Closterium* from the saline waters of Naheim, and *Pleurosigma* and *Sarirella* from other localities. The Bacillariaceæ of the western Numburg Stream must be regarded as merely an indication of the saline water from the gypsum mountains. The diatoms have been brought to the stream from the neighbouring fresh and salt water basins by the various water birds.
E. S. G.

Bacillariaceæ of the Streams near Nagyvárad.—J. L. LACSNY (*Bot. Közlemények*, 1916, **15**, 161-8, fig.; Magyarisch, with German résumé; see also *Bot. Centralbl.*, 1918, **137**, 5). Three streams flow through Nagyvárad, one of which—the Pece—is thermal. The flora of these closely adjacent streams is so different that only one species is common to all three. Three new species are described, and several new varieties.
E. S. G.

Studies of Danish Aerophilous Algæ.—J. B. PETERSEN (*Mém. Acad. Roy. Sc. Lettr. Danemark*, 1915, **12**, 271-379, 4 pls.; see also *Bot. Centralbl.*, 1918, **137**, 22). A monograph. Under the title "aerophilous," the author designates those algæ which are content to absorb moisture from the atmosphere and can sustain frequent droughts, though not having special resting periods. *Prasiola* can bear a drought of three weeks; and certain species of *Navicula* can exist in earth containing little over 5 p.c. of water. The author frequently found terricolous species, especially on fields, rocks and straw roofs. In woods or on dry heathland he found practically none. There are about 25 terricolous species, and 9 amphibious. All aerophilous forms are small, but always motile. They belong entirely to the Raphideæ. Aerophilous green algæ are much commoner. The author discusses Danish associations in detail, and groups them according to their habitat—on earth, rock or roof, under stones or wood, or on trees. *Cystococcus humicola*, *Pleurococcus lobatus*, *Trentepohlia* (even on conifer needles) are very capable of resisting adverse conditions. These species were studied under culture.
E. S. G.

On some New and Rare Chlorophyceæ of the Adriatic.—B. SCHUSSNIG (*Sitzungsber. Ksl. Akad. Wiss. Wien*, 1915, **124**, Abt. 1, 425-45, 4 pls.; see also *Bot. Centralbl.*, 1918, **137**, 5-6). Three new species of *Ulothrix* are described, of which two appeared in a culture and have not been observed in the open. One of these, *U. longicauda*, was found growing among small algæ from the Bay of S. Bartolomeo, and consisted of small tufts of filaments up to 1 cm. long, attached to the substratum by a long acuminate rhizoid. A new genus and species, *Sphærosiphon solitarius*, is described, also unknown in the open. Interesting observations are given on *Phæophila floridearum* Hauck., which was found by the author both epiphytic and endophytic on many of the larger algæ, as well as on the wall of a culture-glass. The form of

the cells varies considerably in the different habitats. The bristles (seta in Huber's sense) are homologous with branch cells, and arise singly or in pairs on every cell. The zoospores vary much in their form. The escape of the zoospores takes place through the bristles, a stopper being thrust out from the apex. The occurrence of gametes has not been observed, and Hauck's statement as to the copulation of swarm-spores does not hold good. Coloured plates show habit and detailed structure.

E. S. G.

Cytology of the Cladophoraceæ.—NELLIE CARTER (*Ann. of Bot.*, 33, 1919, 467-78, 1 pl. and figs.). In *Cladophora*, *Chætomorpha*, and *Rhizoclonium* the chloroplast consists invariably of a parietal film lining the cell-wall, and often more or less reticulated in proportion to the cell-contents; in well-nourished cells numerous trabeculæ traverse the lumen. Pyrenoids are numerous in both peripheral and internal parts of the chloroplast. The nuclei are mostly confined to the chloroplast, rarely occurring in the colourless cytoplasm, which layer is difficult to detect. The nuclei are proportionately large in some narrow forms of *Rhizoclonium*, and may project from the chloroplast into the cavity of the cell. The nuclei in *R. hieroglyphicum* are more numerous than was formerly believed, and in thick forms they frequently are as many as twenty-four in a cell. In autumn much starch is stored as small grains lodged in the interstices of the chloroplast-reticulum, thus distending the chloroplast. During mitosis the nucleus of *Rhizoclonium* and *Cladophora* is characterized by a long thin spireme and very numerous chromosomes. After the migration of the latter to opposite poles of the spindle the daughter-nuclei are separated by constriction of the spindle in the region of the equator.

A. G.

New Nitella.—G. R. BULLOCK-WEBSTER (*Journ. of Bot.*, 1919, 57, 1-2, 1 pl.). A description and figures of a new species of *Nitella*, from a lake near Kindrum, in the Fanad Peninsula of County Donegal. *N. spanioclema* is a delicate fragile species, abundant in the lake, and remarkable for its depauperate ramification and other peculiarities. It is closely allied to *N. flexilis*.

A. G.

Chara fragilis and C. delicatula.—J. GROVES and G. R. BULLOCK-WEBSTER (*Journ. of Bot.*, 1919, 57, 69). A note on the structural characters which justify the separation of *C. delicatula* as a distinct species from *C. fragilis*. The former plant has well-developed stipulodes, and has its primary cortical-cells wider than the secondary cells, and discernible spine-cells.

A. G.

Notes on Lychnothamnus.—JAMES GROVES (*Journ. of Bot.*, 1919, 57, 125-9). A discussion of the distinctive characters of the genus, and a consideration of certain species that have been referred to it. One of the latter, *L. stelliger*, has been made the type of *Nitellopsis* Hy., and its synonymy is now revised. As to *L. macropogon*, the question is considered whether it should be transferred to *Lamprothamnion* or to a separate genus, *Macropogon*, or, as the author prefers, back again to *Chara*. This leaves in *Lychnothamnus* the one well-marked species, *L. barbatus*.

A. G.

On some Fossil and Recent Lithothamniæ of the Panama Canal Zone.—M. A. HOWE (*Bull. Smithsonian Inst. U. S. Nat. Mus.*, 1919, **103**, 1-13, pls. 1-11). Detailed descriptions of, and critical discussion on, three new species of fossil coralline algæ from Oligocene strata of the Panama Canal zone—*Archæolithothamnium episporum*, *Lithothamnium Vaughanii* and *L. isthmi*. *Lithoporella melobesioides* Foslie is also recorded from the same stratum in the Canal zone. Hitherto only one species of fossil Lithothamniæ has been recorded from the Western Hemisphere—namely, *Lithothamnium curasavicum* K. Martin, from the Island of Curaçoa. In outward form and in its habit of overgrowing old corals, *A. episporum* resembles *A. erythræum* Foslie f. *durum* from the Red Sea and East Indies, but differs in internal structure and in its more superficial sporangia. In size and external appearance *Lithothamnium Vaughanii* resembles coarse eroded conditions of the living *L. glaciale* Kjellman, but differs in structure. Both the habit and structure of the three new species are well represented by photographs. E. S. G.

Historical Review of the Florideæ.—A. H. CHURCH (*Journ. of Botany*, 1919, **57**, 297-304). An historical account of the study of the red seaweeds from about 300 B.C.—of the early attempts at record and classification, and the striking advances that have followed successively the work of Bornet and Thuret on sexual reproduction; of Schmitz on the development of the cystocarp and on the nature of cell-fusions, together with his re-grouping of the families and genera; of Oltmanns on the true nature of the cell-fusions; of Yamanouchi and others on the life-cycle of *Polysiphonia* and other genera. A. G.

Additions to our Knowledge of Sargassum.—A. GRUNOW (*Verh. Zool. Bot. Ges. Wien*, 1915, **65**, 329-448; 1916, **66**, 1-48, 136-85; see also *Bot. Centralbl.*, 1918, **137**, 4-5). A posthumous work, in which the author describes in detail numerous species and forms of *Sargassum*, both new and old, and adds critical notes on synonymy and distribution. The arrangement of J. G. Agardh is retained with but few exceptions. *S. vulgare* and *S. subrepandum* are very variable species, and many others are difficult to determine. The paper includes 230 species, and is invaluable as a handbook to the genus, since the author had access to a large number of types. An index of species and synonyms completes the work. E. S. G.

Phæophycean Zoïd.—A. H. CHURCH (*Journ. of Bot.*, 1919, **57**, Suppl. ii., 7 pp.). A summary of our knowledge of the ciliated reproductive cells of the brown algæ—for example, the zoogonidia of *Ectocarpus*, the gametes of *Laminaria*, the antherozoids of *Fucus*. The minute structure of these cells is described, and their resemblance to typical Flagellate. The asymmetrical habit, with the lateral insertion of the two unequal flagella, is suggested to be of secondary origin. The anterior flagellum is a tractor mechanism, while the posterior flagellum is a trailer. The flagella are most efficient when measuring three to four times the length of the body. Their primary function is to provide a means of vertical ascent towards the light, and a speed of 1-2 ft. per

hour is obtainable; of the duration of their motility not much is known. Examples are given of stages in the progression of heterogamy, culminating in oospores and antherozoids; also of variants from the type found in different phyla of Phæophyceæ. A. G.

Historical Review of the Phæophyceæ.—A. H. CHURCH (*Journ. of Bot.*, 1919, 57, 265-73). A history of the brown seaweeds from the time of Theophrastus (300 B.C.), showing how ideas of classification were developed and have been modified by advancing knowledge and means of investigation, and giving references to the best modern works and papers on questions of morphology, anatomy, reproduction, etc. A. G.

Fungi.

New Balansia on Cyperus.—C. W. EDGERTON (*Mycologia*, 1919, 11, 259-61, 1 pl.). This fungus was discovered in the summer of 1917 attacking the fruiting parts of *Cyperus virens*. Large black sclerotia were found replacing the seeds. The young flower-buds are attacked, and the sclerotium develops as the bud enlarges. Perithecia are formed in the black outer layer of the mature sclerotium. A diagnosis of the fungus *Balansia Cyperi* sp. n. is appended. A. L. S.

Parasite of the Tree-fern (Cyathea).—F. L. STEVENS and NORA DALBEY (*Bot. Gaz.*, 1919, 68, 222-5, 2 pls.). "*Cyathea arborea*, one of the most beautiful of the tree-ferns, is usually heavily affected by black fungous growths." These have been investigated by the authors, and they have diagnosed the perfect condition of the fungus as *Griggsia Cyathea* sp. n., with solitary perithecia, without any ostiole, and with oval, hyaline one-celled spores. There is also a conidial or pycnidial form, in which the pycnidium opens by a ragged cleft, and bears one-celled brown conidia. A. L. S.

Note on a Cordyceps.—ETIENNE FOEX (*Bull. Soc. Vaud. Sci. Nat.*, 1919, 52, 461-4, 1 pl., 1 fig.). The author gives careful descriptions and figures of a species of *Cordyceps* found in the forest of Jorat. It approaches near to *C. capitata*, and the author scarcely feels the necessity of making a new species, though it differs in several respects from published accounts. A. L. S.

Phylogeny and Relationship in the Ascomycetes.—G. F. ATKINSON (*Ann. Missouri Bot. Garden*, 1915, 2, 315-76). This paper was written by Atkinson some time before his death. In it he outlines and discusses the views put forward by various botanists as to the origin of the Ascomycetes or sac fungi. Atkinson himself would derive them from fungus ancestry, rather than from the red algæ. He thinks we are not in a position to name any known phycomycete as a probable ancestor, though the ancestral stock probably possessed phycomycetous characters. He goes further, and suggests *Dipodascus* as such a primitive form. From that plant he traces *Endomyces Magnusii* and other Protoascomy.

ctes, and on to the lower forms of the Euascomycetes, such as *Monascus*, *Gymnoascus*, etc. He also suggests the different lines of development within the group. A full bibliography is appended. A. L. S.

Minimum, Optimum, and Maximum Temperatures of Spore Germination in some Uredinales.—W. M. D. DORAN (*Phytopathology*, 1919, 9, 391-402). The spores tested were the æcidiospores and urediniospores of *Cronartium ribicola*, æcidiospores of *Gymnosporangium clavipes*, urediniospores of *Puccinia Antirrhini* and of *Uromyces caryophyllinus*, and the telentospores of *P. malvacearum*. The various results are recorded. It was found that these spores germinated over a wide range of temperature, but that there is a material degree of host-infection only when the temperature is near the optimum, and that temperature is relatively low. Apparently there exists a relation between the time of year when spores occur and the optimum temperature for their germination. A. L. S.

Undescribed Timber Decay of Hemlock.—ERDMAN WEST (*Mycologia*, 1919, 11, 262-6). *Polyporus Tsugæ*, which causes the decay of hemlock timber, is at first a sap-rot, but it eventually destroys the heart-wood also. Few stumps or dead trunks escape its attack. West gives an account of the action of the fungus on the host tissues, and he gives a revised diagnosis; he rejects Lloyd's statement that it is a form of *P. lucidus*. A. L. S.

Pineapple Fungus, or Enfant du Pin or Warabou.—J. H. FAULL (*Mycologia*, 1919, 11, 267-72). An account of *Fomes officinalis*, which grows on various conifers. It was valued by the Indians for its medicinal properties. It has been used by early settlers in the making of home-brewed beer, and as a substitute for hops in the making of yeasts. A. L. S.

Some described Species of Poria.—W. A. MURRILL (*Mycologia*, 1919, 11, 231-44). An account is given of American species of the white or brightly coloured resupinate *Poriæ*; care is necessary to distinguish between true resupinate and the resupinate growth of some pileate Polypores. Murrill has examined and described thirty-five species. As a rule it is only possible to give size and measurements of the pores, as in most cases spores are lacking. A. L. S.

Some Colorado Fungi.—L. D. OVERHOLTS (*Mycologia*, 1919, 11, 243-58). Very little work has as yet been done on the larger fungi of the Western American States. Overholts has been working in this region for some seasons, and he now publishes 152 different plants; they comprise Ascomycetes, Basidiomycetes, and a few Uredineæ. He has given notes on the climatic and soil conditions, and the way that these affect the occurrence of fleshy fungi. A. L. S.

Fungi as Members of the Subærial Transmigration.—A. H. CHURCH (*Thalassiophyta and the Subærial Transmigration*, Bot. Memoirs, No. 3, 1919, 48-64). Church considers that the great majority of plants included under Fungi are derived from phytobenthon,

their origin being polyphyletic. Neither Ascomycetes nor Basidiomycetes show the slightest direct affinity with any existing Marine Algae, although it may be certain that they were derived from forms existing in the sea. Several of the lower groups with motile antherozoids he regards as the decadent survivors of Marine Algae. He traces the progression of benthic life from the sea (with regard to fungi) as (1) the possible removal from water giving encysted perennation stages; (2) the saprophytic habit, with loss of chloroplasts, and "cell" organization; and (3) increased possibility of wastage in subaerial dispersal. After discussing the various groups from different points of view, he states that "the special biological interest of the Fungi centres in the fact that owing to the adoption of an entirely new mode of heterotrophic nutrition, the insistence of new problems can be traced quite independently in the reproductive organisation." Of great importance is the manifold evolution of the air-borne spore, a minute "plankton" of the air.

A. L. S.

Contribution to the Study of the Mycological Flora of the Chateau d'Œx Region.—EUG. MAYOR (*Bull. Soc. Vaud. Sci. Nat.*, 1919, 52, 395-418). Mayor has confined his attention to fungal parasites, and to certain groups only of these, Peronosporineæ, Ustilagineæ, Uredineæ, Protomycetaceæ, and Erysiphaceæ. The Uredineæ bulk largest in the long list of species. Locality and habitat are mostly given.

A. L. S.

Fossil Micro-organisms from the Jurassic and Cretaceous Rocks of Great Britain.—DAVID ELLIS (*Proc. Roy. Soc. Edinb.*, 1915, 35, 110-2, 113-32, 2 pls.). While examining a series of slides from various rocks of the Jurassic and Cretaceous periods, gathered together in connexion with borings for ironstone, the author devoted special attention to micro-organisms that might be associated with iron deposits. The fungus which he found and described as *Phycomycitis Frodinghamii* was found in the Frodingham ironstone of Lincolnshire. The parts of the fungus identified include hyphæ, sporangia, and spores. Another fungus, found in the ironstone of Raasay (North-west Scotland), and consisting of branching hyphæ only, has been designated as *Palæomycesis a*. He also records an *Actinomycesis a* and several bacteria from the same or similar rocks. The organism called *Phycomycitis Frodinghamii* seems to have had a chemiotactic affinity for iron-compounds, and may have enriched the deposits where it was found. All these fossil fungi were found in the cells of plant tissues that were in a rotting condition when fossilizing processes took place.

A. L. S.

Rose Graft Disease.—IRWIN H. VOGEL (*Phytopathology*, 1919, 9, 403-12). A characteristic symptom of the disease is the occurrence of lesions on the scion of the union and just above the union, which results in the sudden wilting and death of the young rose graft. Pycnidia of *Coniothyrium rosarum* developed in these areas. This fungus, which was found to cause the disease, was tested by cultures and by infection experiments. The most satisfactory way of combating the disease is to grow the more resistant varieties, and also to exercise

great care in the selection of scion-wood, which should not be taken from a rose-house in which the disease is known to exist. Much damage was done by the fungus at Council Bluffs, Iowa. A. L. S.

Is the Common Potato Scab Controllable by a mere Rotation of Crops?—M. SHAPOVALOV (*Phytopathology*, 1919, **9**, 422-4, 1 fig.). The author has found that the Scab fungus, *Actinomyces Scabies*, can exist on a comparatively moderate amount of cellulose, so that there will always be enough of material in any soil to enable *Actinomyces* to propagate from year to year. Control is thus almost impossible. A. L. S.

Publications of George Francis Atkinson.—H. M. FITZPATRICK (*Amer. Journ. Bot.*, 1919, **6**, 303-8). G. F. Atkinson, one of the foremost mycologists in America, died last Spring while on a collecting trip in the Far West. He had made his mark in other botanical subjects, but in late years he had devoted himself especially to the study of mycology. The author of this list has given a short account of Atkinson's career (*Science*, 1919, **49**, 371-2), and in this published list of papers evidence is given as to the many branches of botany that claimed his interest, though the greater proportion deal with mycology, more especially from the side of plant pathology. A. L. S.

Banana Wilt.—E. W. BRANDES (*Phytopathology*, 1919, **8**, 339-89, 14 pls.). The examination of this disease has been undertaken in Porto Rico. The author gives, however, a general account of the importance of the banana as a food; many varieties of the banana-plant are cultivated, and a number of them are liable to the disease, which is widespread in the American tropics. It has been found that the causal organism is *Fusarium cubense*, of which a full account is given as it occurs on the tree and as it grows in artificial cultures. Sporodochia of the fungus occur on the surface of the leaf-stalks and blades or of leaf-bases, emerging through the stomatal openings. Within the host the mycelium is mainly intracellular, though there is evidence that it is also intercellular. The germinating conidium pierces the epidermis by means of a germinating tube, and passes from cell to cell. The vessels of the xylem are usually filled with the mycelium. The plant shows yellowing or wilt of the leaves, which soon droop and die; finally the tree itself falls to the ground and quickly rots. Remedies are suggested and experiments to cope with the disease are described. A. L. S.

Destructive Disease of Seedling Trees of *Thuja gigantea*.—G. H. PETHYBRIDGE (*Quart. Journ. Forestry*, 1919, April, 4 pp.). Specimens of diseased larch and *Thuja* seedlings were found at Baunreagh, Queen's County, and were examined by the author. The larches were infected by *Botrytis*; the *Thuja* trees were about three years old, and many hundreds had been killed by a fungus which on examination proved to be an Ascomycete, *Keithia Thujiina*. It was first found on leaves of *Thuja occidentalis*, near Lake Superior, in Wisconsin, in 1908. Hitherto it has not been reported outside America, and there seems to be no satisfactory explanation as to how the fungus may have been imported. A. L. S.

Lichens.

Contribution to the Lichen Flora of the West Coast.—A. H. MAGNUSSON (*Svensk Bot. Tidsk.*, 1919, **13**, 75-92). The author sketches work previously done in collecting lichens in the district of Sweden selected by him for examination. He then gives a list of the lichens found by him, with habitat and locality. A. L. S.

Concerning the Species of Brown Parmeliæ and Hypogymniæ, their Occurrence and Fertility, especially on the West Coast.—A. H. MAGNUSSON (*Svensk Bot. Tidsk.*, 1916, **10**, 365-73). The author gives a descriptive list of these lichens. The notes are full and instructive. A. L. S.

Mycetozoa.

Notes on Species of Myxomycetes.—CH. MEYLAN (*Bull. Soc. Faud. Sci. Nat.*, 1919, **52**, 447-50). Abundant growths of the species *Trichia botrytis*, *T. lateritia* and *T. subfusca* induced Meylan to make a comparative study of their specific characters. He finds that they differ in habitat, in the form of the elaters, and in the plasmodium. He found also, on the bark of *Picea excelsa*, a new species, which he names *Lamproderma Gulielmæ*, distinguished from neighbouring species by the minute size of the stalk and sporangia, and by larger spores. Meylan further describes two new forms of *Dödermæ*. A. L. S.

MICROSCOPY.

A Study of the Forms Assumed by Drops and Vortices of a Gelatinizing Liquid in Various Coagulating Solutions.—EMIL HATSCHEK (*Proceedings of the Royal Society, Series A*, 95, 303). The investigation to be described in the present paper was begun with the object of testing experimentally some suggestions made by Professor d'Arcy Thompson. The substance of these suggestions is that many organic forms show symmetries corresponding closely to those of vibrating bodies of similar shape, and that many others recall very strikingly the shapes exhibited temporarily by splashes and by vortices. In the usual method of producing vortices, causing drops of a coloured liquid to fall, or jets of it to emerge, into another with which it is completely miscible, the various stages of the phenomenon succeed one another with great rapidity, so that either unusually acute observation or instantaneous illumination and photography is required to isolate any particular one. Even apart from this difficulty, the procedure has a serious defect when viewed as a method of imitating organic form, inasmuch as organisms cannot possibly consist of liquid alone, but are either colloidal solution enclosed in membranes, or possess the physical properties of gels.

It appeared to the author that it would be possible to obtain permanently various stages of the vortex on the one hand, and on the other, to approach much more closely to nature in respect of secondary features of possible importance by using a gelatinizing sol (e.g. a suitably coloured gelatine sol), and producing with it drops or vortices in one of the numerous solutions which promote the setting of gelatine sols, or cause hardening of gelatine gels. Apart from the possibility of arresting the vortex at any given stage by a suitable choice of solution and concentration, this procedure seemed to promise results not obtainable with liquids alone. It may be said in anticipation that all these expectations were fully realised, and that the experimental technique was gradually perfected.

The paper is one of considerable interest to microscopists, particularly those engaged in biological investigation; but it must be read in full to appreciate the argument. No abstract can possibly give a proper idea of the experiments described.

J. E. B.

An Investigation of Extreme Ultra-violet Spectra, with a Vacuum Grating Spectrograph.—J. C. MCLENNAN, F.R.S. and R. J. LANG, M.A., University of Toronto (*Proceedings of the Royal Society, Series A*, 95, 258). The results of some studies with quartz and fluorite spectrographs have already been published; and in the present communication an account is given of some preliminary observations made with a vacuum grating spectrograph. The results obtained show that it is quite feasible to investigate with comparative ease spectra including wave-lengths as short as 584 angstrom units.

J. E. B.

GEOLOGY.

Rocks of Italian Somaliland.—E. MANESSE (*Atti della Società Toscana*, 1917, 31). Much information of interest to crystallographers is included, together with some remarkable photomicrographs.

On the Four Visible Ingredients in Banded Bituminous Coal: Studies in the Composition of Coal, No. 1.—M. C. STOPES (*Proc. Roy. Soc.*, May 15, 1919, Series B, 90). The author recognizes "fusain," "clairain," "durain," and "vitrain," as distinct microscopical constituents in bituminous coal.

The Chellaston Gypsum Breccia in relation to the Gypsum-Anhydride Deposits of Britain.—B. SMITH (*Quart. Journ. Geol. Soc.*, Sept. 5, 1919, 74). Microscopical evidence and photomicrographs are appended.

The Kelestomniæ: a Sub-family of Cretaceous Cribimorph Polyzoa.—W. D. LANG (*Quart. Journ. Geol. Soc.*, Sept. 5, 1919, 74).

METALLOGRAPHY, ETC.

The Mechanical Properties of Steel, with some Consideration on the Question of Brittleness.—W. H. HATFIELD (*Journ. Inst. Mech. Eng.*, June, 1919). The conclusions arrived at show:—1. That general reliance cannot be placed upon any one test. 2. Real brittleness occurs less frequently than is generally imagined. 3. Notched-bar brittleness must be dissociated from true brittleness, since whilst the former is always associated with the latter, the converse is not necessarily true. 4. The tensile test is fundamental, the other being useful for special purposes, though auxiliary. F. I. G. R.

The Acid Hearth and Slag.—J. H. WHITELEY and A. F. HALLIMOND (Iron and Steel Institute Meeting, May, 1919). Part I. Description of structure of slowly-cooled acid slags. Part II. Structure of the hearth. Part III. Reactions in the molten slag. (With illustrations.)

The Experimental Investigation of the Influence of the Rate of Cooling on the Hardening of Carbon Steels.—A. M. PORTEVIN and M. GARVIN (Iron and Steel Institute Meeting, May, 1919).

Some Points in the Manufacture of Files.—G. TAYLOR (Iron and Steel Institute Meeting, May, 1919).

Macro-etching and Macro-printing.—J. C. W. HUMFREY (Iron and Steel Institute Meeting, May, 1919).

Improvements in the Case-hardening Process.—D. HANSON and J. E. HURST (Iron and Steel Institute Meeting, May, 1919).

The Manufacture and Working of High-speed Steel.—J. H. ANDREW and G. W. GREEN (Iron and Steel Institute Meeting, May, 1919).

The Molecular Constitutions of High-speed Tool Steels, and their Correlations with Lathe Efficiencies.—J. O. ARNOLD and F. IBBOTSON (Iron and Steel Institute Meeting, May, 1919).

NOTICES OF NEW BOOKS.

The Theory of Modern Optical Instruments. A Reference Book for Manufacturers of Optical Instruments and for Officers in the Army and Navy. By Dr. Alexander Gleichen. Translated from the German by H. H. Emsley, B.Sc., and W. Swayne, B.Sc., with an appendix on Range-Finders. Published for the Department of Scientific and Industrial Research by His Majesty's Stationery Office, 1918.

The Committee of the Privy Council for Scientific and Industrial Research realized at an early stage the necessity for rendering assistance to the optical instrument making industry; and it was suggested by their Advisory Council, assisted by the Committee on Glass and Optical Instruments, that one way of doing this lay in the translation and publication of certain foreign works.

The volume here noticed has been prepared under the direction of an Editorial Committee. The Committee have not been asked to review the terminology and the use of symbols adopted by the translators. For this, by raising the whole question of nomenclature in optics, would not only have caused a serious delay in the appearance of the work, but would have raised difficult and far-reaching problems which could not at the present moment receive the attention they deserve.

The text of the original has been closely followed, with certain exceptions, to which reference is made in the translators' preface. During the last decade many noteworthy improvements have been made in the manufacture of optical instruments which have not been published collectively. The object of this book is to remedy this deficiency. In order to make the matter clear to the non-technical reader a section on General Theory is included, dealing with information on elementary geometrical principles, and having particular reference to the dioptric conception developed by Guhlstrand and since further elaborated.

Dr. Gleichen has divided his work into two portions. In the first he has given a very clear résumé of the more important laws of refraction at spherical surfaces, and of the formation of images by lenses and their combinations. The second portion deals with the direct application of these laws to the particular instruments described therein. Both portions are written so as to be intelligible to the more elementary student, who may not possess the advanced mathematical training necessary for the understanding of more difficult treatises, and, moreover, in such a manner as to permit of ready application.

In rendering the volume into English the translators have adhered to the literal meaning of Dr. Gleichen's text. Nothing has been deleted from the original, and any additions thought to be desirable have been incorporated in explanatory footnotes and appendices.

A short section is devoted to the theory of the microscope; but it cannot be said that the subject has been treated adequately. The treatment follows orthodox lines, and the Abbe theory of microscopic vision is the accepted one. The description of optical parts is in relation to a microscope of typically Continental design. Such subjects as dark-ground illumination and ultra-microscopy are also referred to, but the fundamental difference between objects which are illuminated by transmitted light and those which are rendered self-luminous is not in any way dealt with.

In general, it cannot be said that the portion devoted to the microscope adds anything to that already available in English treatises.

J. E. B.

Scattering of Light by Solid Substances. By the Hon. R. J. Strutt, F.R.S., Imperial College, South Kensington. Proceedings of the Royal Society, Series A, 95, 476-79.

The observations already published on scattering of light by gases and liquids naturally led to an examination of the behaviour of solids in this respect. At the first trial it was found that glass scatters very freely, the scattered light being blue, and in many cases almost completely polarized. The observation is so easy that it must almost certainly have been made before, though no mention is made of it. If a narrow parallel beam, say of 6 mm. diameter, from the condenser of an electric lantern is allowed to traverse the interior of a block of glass, the scattered light along the track will be conspicuous. This is a ready method of demonstrating the scattering by small particles.

Numerous specimens of plate-glass and optical glass have been examined. These all show the scattering, though they differ among themselves in respect of intensity and completeness of polarization. Further experiments were carried out with quartz and with Iceland spar. It was found that yellow quartz and smoky quartz have the property of scattering light very strongly, the colouring matter being evidently distributed in the crystal in the form of small particles analogous to those found in glass.

J. E. B.

Mirrors, Prisms and Lenses. A Text-Book of Geometrical Optics. By James P. C. Southall, Associate Professor of Physics, Columbia University. 579 pp., 247 figs. Published by The Macmillan Company, New York. Price \$3.25.

A Monograph of the British Lichens. A Descriptive Catalogue of the Species in the Department of Botany, British Museum. Part I., second edition. 519 pp., 71 pls. and 11 figs. in the text. Annie Lorrain Smith, F.L.S., Acting Assistant, Department of Botany. Printed by Order of the Trustees of the British Museum. 30s. net.

This volume, as will be seen by the above, is described on the title-page as Part I., second edition, but on turning to the preface one learns that it is much more than a second edition, for it has been completely re-written and re-arranged so that it forms an independent work companion to Part II. by the same author, issued in 1911.

Among the new features of this edition is an introduction to the study of lichens, which gives a lucid and concise summary of the chief points of our present-day knowledge of these plants. It is arranged under the following sections: the lichen plant, morphology, reproductive organs, physiology, ecology and distribution, phylogeny and classification.

In the description of the lichen plant Miss Lorrain Smith states that it is formed "from the union, in intimate symbiotic relationship, of two separate plants, a fungus and an alga." This point of view appears to accord more nearly with the facts of present-day knowledge than does the theory of pure parasitism on the part of the fungus; a theory which is based to a large extent upon the penetration of the algal cell by the fungus hypha. Such penetration, although figured and described in text-books, cannot be claimed as the prevailing state of the relationship between the fungus and the alga in the lichen thallus. In a large number of British fruticose and foliose lichens penetration of the algal cell by the hypha takes place seldom, if ever. The vast majority of algal cells in a lichen thallus have the appearance of being perfectly healthy, and the number of dead, or partially empty cells is, in many species, exceedingly small. The algal cell of a lichen thallus can no longer be regarded as influenced so profoundly by the fungus as to cause it to lose its power of reproduction except in a vegetative manner, for at certain seasons of the year great numbers of algal cells sporulate, and it is by this means, and not by vegetative cell division, that the number of algal cells (gonidia) is increased. The formation of spores with the rapid development of these within the mother-cell into gonidia, is similar to that observed in free *Chlorella* cells.

We cannot agree with Bruce Fink, who has stated recently that the theory of symbiotic relationship is "wrong." He has further asserted that "in America, at least, and we believe in Europe as well, there has been a marked recent trend of opinion among students of lower plants to the effect that the dual hypothesis regarding lichens is untenable, and that the lichen must be a fungus after all, parasitic on an alga."

Bruce Fink has in no way justified this pronouncement, which, as far as we know, is unsupported by lichenists in Europe, with the possible exception of A. A. Elenkin and A. N. Danilov. The results of recent research, as noted above, give no evidence in support of parasitism.

The illustrations to the introductory matter represent highly magnified sections of the thallus and apothecia of the lichen. These illustrations bear evidence of the fact that field characters are not always

sufficient for the identification of lichens. The lichenist finds it more and more necessary to include in his equipment a microscope with an objective giving a considerable magnification. Spore measurements, given in multiples of the micron, occur on every page of the text, and drawings of highly magnified asci, paraphyses and spores appear on each of the seventy-one plates at the end of the volume, which illustrate the microscopical characters of typical species.

The classification used is one based upon the form and structure of the reproductive organs. British lichens are arranged in two great series: (1) *Gymnocarpeæ*, the fruits of which have the form, more or less, of an open disc; and (2) *Pyrenocarpeæ*, with closed fruits. The *Gymnocarpeæ* are further divided into three sub-series, each of which has distinctive fruit characteristics.

Another welcome and very helpful feature of this volume is the series of keys to the genera. In the case where a genus includes a large number of species a key to its sub-divisions has been added. These keys have been frequently tested, so that it can be said of them that they will prove a valuable time-saving aid for the identification of unfamiliar species. Considerable thought and skill have been given in the arrangement of this part of the book.

To those who are more or less acquainted with the lichen flora of Great Britain the changes in nomenclature and the re-arrangement of the Orders (Families) will appear unfamiliar, but the very full list of synonyms that follows the description of each species, sub-species, variety and form, and the well-prepared index will enable the student to trace any plant with the name of which he may be acquainted. As the knowledge of British lichens accumulated, changes in nomenclature became inevitable.

The writer of this Monograph is to be congratulated on the successful completion of so important a piece of work, a work that has occupied several years of painstaking investigation and critical weighing of evidence, possibly associated sometimes with the feeling of a heavy weight of responsibility.

The Completed Monograph of British Lichens becomes at once a landmark in British Lichenology which will be for some time to come the standard for reference. It will take a high rank among the several excellent Natural History publications issued from time to time by the Trustees of the British Museum.

ROBERT PAULSON.

PROCEEDINGS OF THE SOCIETY.

AN ORDINARY MEETING

OF THE SOCIETY WAS HELD AT 20 HANOVER SQUARE, W., ON WEDNESDAY, OCTOBER 15TH, 1919, MR J. E. BARNARD, PRESIDENT, IN THE CHAIR.

The Minutes of the preceding Meeting were read, confirmed, and signed by the President.

The nomination papers were read of ten Candidates for Fellowship.

New Fellows.—The following were elected Ordinary Fellows of the Society :—

Mr. Douglas Coghill.
Mr. Charles Lees Curties.
Mr. Quincey C. Tucker, M.B., Ph.G.

Donations were reported from :—

Sir David L. Salomons, Bart, J.P., M.A., etc.—

A Silver Microscope, by François Watkins (1754).

(A full description of this microscope, with illustrations, will be found in the Society's Journal for 1908, pp. 137–45.)

Mr. T. B. Rosseter—

Two Microscopes, Collection of Slides, Slide Cabinets, etc.

The British Museum—

“British Lichens,” by A. Lorrain Smith, F.L.S.

On the motion of the **President**, very hearty votes of thanks were accorded to the above donors for their valuable gifts to the Society.

The Deaths were announced of :—

Mr. John Whiteley Dunkerley. Elected 1883.

Mr. John Hopkinson. Elected 1867.

The **President** said that it was with very sincere regret that he had to make this announcement, and he was sure it would be the wish of the Fellows that a message of their deep sympathy should be forwarded to the relatives of Mr. Dunkerley and Mr. Hopkinson. Mr.

Hopkinson was well known to those present, and would be long remembered for his geniality and his great interest in the work of the Society.

The President explained that when arrangements were being made for that evening's Meeting the country was in the midst of a strike on the railways that was disorganizing all traffic. The Council therefore had to decide whether to abandon the Meeting or to hold it as a formal Meeting. It was decided to hold the Meeting, and to devote it mainly to an

EXHIBITION OF MICROSCOPICAL SPECIMENS AND APPARATUS.

Some most interesting exhibits were being shown, and the Society was greatly indebted to those gentlemen who had brought them. Personally, he regarded them as of considerable importance, and it was a matter of considerable regret that Fellows did not take more opportunities of showing them what occurred in the course of their work touching on the subjects in which they had a definite interest.

The President announced that the Biological Section would meet on November 5, when Mr. R. Paulson would read a communication on "The Nucleus and Pyrenoid in certain Spherical Algae."

The business proceedings then terminated.

The following Objects were exhibited —

Mr. J. E. Barnard and Mr. F. Welch	}	Mercury Vapour Lamps, in Quartz and Glass, for Microscopical Illu- mination.
Mr. D. Davies . . .		Foraminifera from Timaru, New Zealand.
Mr. E. Maxwell . . .		Fresh-water Rhizopod, <i>Nebela col- laris</i> .
Mr. H. H. Mortimer . .		<i>Beggiatou</i> sp., a large form, slowly moving and rotating.
Mr. J. M. Offord . . .		<i>Coscinodiscus robustus</i> , showing se- condary markings. (Under $\frac{1}{12}$ th obj.)
Mr. R. Paulson . . .		Algal cell (<i>Chlorella</i>) in process of division.
Mr. J. Rheinberg . . .		"Chessboard" Eye-piece Microme- ters.
Mr. J. Richardson . . .		<i>Amphipleura Lindheimerii</i> illuminated by Wenham's Reflex Illuminator.
Mr. D. J. Scourfield . .		White blood corpuscles in the body of <i>Cyclops</i> ; sometimes to be seen creeping over the ventral nerve- cord. (Under $\frac{1}{10}$ th water imm. obj.)

- Mr. R. S. W. Sears . . . Rotifers.
 Mr. E. J. Sheppard . . . Characteristic chromosomes in *Triton cristata*.
 Mr. T. J. Smith . . . Fiery opal in matrix; shown with Amici's Prism.
 Mr. J. Wilson . . . Fresh-water Rhizopod, *Cyphoderia ampulla*; also various Desmids.

AN ORDINARY MEETING

OF THE SOCIETY WAS HELD AT 20 HANOVER SQUARE, W., ON WEDNESDAY, NOVEMBER 19TH, 1919, MR. F. MARTIN DUNCAN, VICE-PRESIDENT, IN THE CHAIR.

The Minutes of the preceding Meeting were read, confirmed, and signed by the President.

The nomination papers were read of ten candidates for Ordinary Fellowship and one for Honorary Fellowship.

New Fellows.—The following were elected Ordinary Fellows of the Society :—

- Mr. Richard A. Alston, Assoc.M.C.T.
 Rev. Allan William Constantine.
 Mr. Aubrey H. Drew.
 Mr. William H. Gibson, M.B.E., D.Sc.
 Mr. Percy Hampshire.
 Mr. Leslie Gordon Lawrie.
 Capt. Frank Oppenheimer, R.A.M.C., S.R., M.B.
 Mr. R. Swainson-Hall, F.L.S.
 Mr. Henry St. John-Ward.
 Mr. Sydney Renoden Wycherley.

Donations were reported from :—

- Mr. Frank Rowley—
 A Case of Ivory Mounts.
 Lieut.-Colonel F. K. McClean—
 A Collection of Microscopical Works (48 volumes).

On the motion of the **Chairman**, hearty votes of thanks were accorded to the donors.

Mr. Scourfield gave an exhibit of the Green Paramecium (*P. Bursaria*).

A vote of thanks was accorded to Mr. Scourfield.

Mr. H. M. Carleton, B.A., read a "Note on Cajal's Formalin-silver Nitrate Impregnation Method for the Golgi Apparatus." The paper was accompanied by lantern illustrations and microscopical slides, and will appear in the Journal.

After some comments by Dr. Murray, the Chairman said that he could not help feeling that they must still look with considerable caution upon the use of the silver salts. It would be extremely interesting to know if different formulæ had been used as the developing agents, because in photo-chemistry it had long been demonstrated that different developing agents, such as pyrogallic acid, iron, amidol, hydrokinone, or metol, in combination with varying quantities of sulphite and carbonate of soda, had a marked effect on the silver salts, with the result that one would in all probability get a varying amount of deposition of silver, which might lead to a totally wrong impression of what was being looked at. Mr. Carleton's paper was a very valuable one, and they were glad to hear that there was the possibility of more interesting material from him coming before the Society in the future. He would ask the meeting to accord Mr. Carleton a very hearty vote of thanks.

This was carried by acclamation.

Mr. Rawlins read a Report on the Collection of Metallurgical Specimens presented to the Society by Sir Robert Hadfield, Bart.

The Chairman said that the Society owed a debt of gratitude to Sir Robert Hadfield for the valuable collection of specimens he had presented. The science of metallurgy had developed in an extraordinary way in the past few years, and he was sure that it would be of considerable value to the Fellows of the Society to have the opportunity of examining the specimens that had been exhibited.

Mr. Rowley asked what method was adopted to preserve the surfaces of the specimens. He suggested they might be covered with glass for low-power work, and duplicates could be obtained for high-power work.

Mr. Rawlins replied that he had tried various methods of covering surfaces, but the defect of all of them was that when using vertical illumination they caused a scattering of light. He mentioned that a catalogue of the specimens was in preparation and would be ready shortly.

Mr. T. G. Elliott gave an exhibition of Lantern Slides of Metallurgical Photomicrographs, and drew attention to the fact that Dr. Sorby did cover his specimens with glass, but they did not do that

in practical work. Nothing in the way of covering had been found successful. Keeping the specimens in a desiccator was as good as anything.

On the motion of the **Chairman**, hearty votes of thanks were accorded to Mr. Rawlins and Mr. Elliott.

Messrs. H. F. Angus and Co. were thanked for the loan of Microscopes.

The Chairman announced that the next meeting of the Biological Section would be held on the 3rd December, when Mr. Akehurst would read a communication on "*Corethra plumicornis*."

The business proceedings then terminated.

ROYAL MICROSCOPICAL SOCIETY.

THE ORDINARY MEETINGS FOR THE SESSION

1919—1920

WILL BE HELD AT 20 HANOVER SQUARE, LONDON, W.1, ON

Wednesday, Oct. 15, 1919	Wednesday, Feb. 18, 1920
„ Nov. 19, „	„ Mar. 17, „
„ Dec. 17, „	„ Apr. 21, „
„ Jan. 21, 1920	„ May 19, „
(<i>Annual Meeting for Election of Council and Officers.</i>)	„ June 16, „

AT 7.30 for 8.0 P.M.

Council Meetings are held on the third Wednesday, Meetings of the Biological Section on the First Wednesday in each month from October to June.

Fellows intending to exhibit any Instruments or Objects, or to bring forward any Communications at the Ordinary Meetings, are requested to inform the Secretaries a week before the Meeting if possible.

The Library and Rooms of the Society are open for the use of Fellows on Wednesday Evenings, other than Meeting evenings, from six to nine o'clock, except during the vacations.

INDEX

A

- Abbott, Charles H., Reactions of Land Isopods to Light, 253
- Abey, L. B., 34
- Acanthocephala, 353
- Acari, 303
- Acid Hearth and Slag, 385
- Ackert, James E., Transmission of Fowl Tapeworms, 43
- Actinaria, Irish, 151
- Actinomycetes, 283
- Morphology of the Genus, 180
- Æciospores of *Cronartium ribicola*, Overwintering of, 63
- Aerophilous Algæ, Danish, 376
- Agarics, 283
- of Denmark, 180
- Agaricus campestris*, Inverted Hymenium in, 180
- Akehurst, S. C., 395
- Alecock, N. L., Rose-blotch Fungus, 72
- Aleyonacea, Significance of Calyx in, 150
- Aleurodes vaporarium*, Fungi on, 66
- Alexandre, Albert and Mary, Ultra-microscopic Particles, 335
- Alexiciff, A., New Coprozoic Flagellate, 359
- Algæ, Australian Marine, 280
- British, Distribution of certain, 279
- Calcareous, from Murray Island, etc., 280
- Fresh-water, 277
- — from Madagascar, 169
- — of Africa, 277
- from old Stored Soils, Retention of Vitality by, 276
- Genera of North American, 277
- Green, of North America, 277
- Marine, Developmental Forms of, 173
- New Pacific Coast Marine, 278
- of Commonwealth Bay, 174
- of the Danish West Indies, 174
- Red, Parasitism among the, 172
- Algal Flora of South Luxembourg, 276
- Algae, Oceanic, 173
- Allee, W. C., and E. R. Stein, Jun., Light Reactions of May-fly Nymphs, 139
- Allen, Bennett M., Experiments on Tadpoles, 31
- Endocrine Glands of Frog and Toad, 31
- Allen, Ezra, Diet and Testicular Degeneration in Rat, 234
- Allen, G. D., Respiratory Metabolism in Planaria, 354, 355
- Alloy Steel, Flakes in, 82
- Alloys of Copper and Zinc, 81
- Alpha Brass, Anneal of Cold-worked, 299
- Alsop, Florence M., Influence of Temperature on Developing Nervous System, 27
- Aluminium, Metallography of, 81
- and its Alloys, Micrography of, 81
- Ingot, Metallography of, 299
- Alvarado, Salustio, Detailed Structure of Wood-vessels, 367
- Ambiosis, 146
- Amblyomma dissimile* Koch, 39
- Amnion in Bat, 129
- in Mammals, 129
- Amœba Proteus*, 366
- Excretion Crystals in, 47
- Amœbæ, Buccal, 258
- New, 258
- of the "Limax" Group, Promitosis and Syndiateresis, Two Methods of Nuclear Division co-existing in, 366
- Amphibia, Influence of Thyroid on Growth of, 332
- Amphibola crenata*, Structure of, 342
- Anderson, C. E., 24
- Anderson, P. J., Index to American Species of Phyllosticta, 177
- Anderson, Robert J., Metallography of Aluminium Ingot, 299
- — of Aluminium, 81
- Andrew, J. H., and G. W. Green, The Manufacture and Working of High-speed Steel, 386
- Angle, E. J., Development of Wolffian Body of Pig, 27
- Animalcule, Sun, Feeding in, 258
- Anthony, R., Muscle-fibres of Molluscs, 135
- Anthraxnose-resistant White Marrow-bean, 69
- Ants, Australian, 36

- Apple-trees, Blossom Wilt and Canker of, 73
- Aquatic Micro-organisms, Axial Rotation of, 167
- Aqueous Humour, 133
- Arbutus Uredo*, Parasite of, 185
- Arcella, Nuclear Re-organization in, 46
— Variations in, 46
- Archangioperis, 161
- Archbutt, S. L., 81
- Archer, R. S., Grain Limits in Heat-treated Alloy Steels, 82
- Arnaud, Roger, New Rapid Staining of Blood and Parasites in Films, 297
- Arnell, H. W., Mosses of the "Vega" Expedition, 166
— and C. Jensen, *Bryum vermigerum*, 165
- Arnold, J. O., and F. Ibbotson, Molecular Constitutions of High-speed Tool Steels, 386
- Arthur, J. C., New Species of Uredineæ. XI., 179
— Study of the Genus *Kuehneola*, 64
— and G. R. Bisby, Rusts of North America, 63
- Asai, Takeshiro, Minute Structure of Membranous Labyrinth of Tadpoles, 334
- Asai, Toichi, New Tannery Fungus, 69
- Ascaris lumbricoides*, 42
- Ascidian, Nervous System of, 244
- Ascochyta, North American, 178
- Ascomycetes, Phylogeny and Relationship in the, 379
- Atkinson, G. F., 382
— Phylogeny and Relationship in the Ascomycetes, 379
— Relationships within the Rhodosporea, 282
- Atterbury, Ruth Rand, Pharyngeal Tonsil and Bursa in Calf, 232
- Atwell, Wayne J., and Ida Sitler, Development of Hypophysis, 26
- Autospore Formation, 59
- B**
- Bacillariaceæ of the Numburg Stream, 375
— of the Streams near Nagyvárad, 376
- Bacillariales, 273
- Bacteria, Dead, are not all Ag-positive, 293
— Mutation in, 293
- Bacterial Cell, The Isolation of the Single, 221
— Emulsions, Opacimeter for Standardizing, 295
— Infection, New Factor in the Mechanism, 294
- Badertscher, J. A., Ultimobranchial Bodies in Pig, 26
- Bagworms, South African, 137
- Bailey, J. W., Depressed Segments of Oak Stems, 367
- Baker, R. T., Technology and Anatomy of Some Silky Oak Timbers, 264
- Balansia, New, on *Cyperus*, 379
- Bale, W. M., Australian Hydroids, 357
- Balkan Zone Diseases, 209
- Banana Wilt, 382
- Banta, Arthur M., Rarity of Sex Intergrades in Cladocera, 40
- Barnacles, Structure of, 144
- Barnard, J. E., The Limitations of Microscopy, 1
- Barrus, Mortier F., Varietal Susceptibility of Beans to Strains of *Colletotrichum Lindenuthianum*, 67
- Basidia, Two-spored, 65
- Basidiomycetes, Conidial Forms of, 181
— Philippine, 182
- Bassler, Harvey, Sporangiphoric Lepidophyte from the Carboniferous, 267
- Bassler, Ray S., 42
- Bat, Amnion in, 129
- Bataille, F., French Mycology, 181
- Baudin, L., Vertical Distribution of Plankton in the Lake of Geneva, 272
- Bauer, O., 299
- Baumberger, J. Percy, Yeasts and Insects, 349
- Baumgartner, E. A., Development of Hypophysis in Dogfish, 27
— — — of Reptiles, 26
- Bayliss, W. M., Nature and Permeability of the Cell Membrane, 234
— Protoplasm and Cell Contents, 234
- Beardslee, H. C., Michigan Collection of Myxomycetes, 291
- Bearing Metals, Researches on, 299
- Beatrice, not a Gigantic Foraminifer, 260
- Beck, Claude S., Distribution of Clastocytes, 237
- Bee Diseases, 349
- Beetles, X-rays and, 348
- Belgrave, W. N. C., Disease due to Cytospora, 73
- Bellis, A. E., 299
- Benham, W. B., Two Unusual Blood Vessels in Tree-Frog, 340
- Benson, Margaret J., Mazocarpon, or the Structure of *Sigillariostrobus*, 53
- Berlese, A., A Hundred New Mites, 350
- Berry, Ed. W., Fossil Higher Plants from the Canal Zone, 266
— Notes on the Fern Genus *Clathropteris*, 55
- Bessey, Ernst A., Undescribed Species of *Ophiolothella* on *Ficus*, 186
- Bethel, Ellsworth, *Puccinia subnitens* and its Aerial Hosts, 178
- Bigney, Andrew J., Influence of Adrenin on Frog's Melanophores and Retina Cells, 243

- Bijl. P. van der, Cane-leaf Spot, 185
 Bilharziasis in Natal, 44
 Billard, Armand, New Species of Sertulariella, 153
 Billiard, G., Mites in Culture Tubes, 39
 Biologique, L'Année, 223
 Birds, Diurnal, Colour-sense in, 241
 Bisby, G. R., 63
 "Black Neck," or Wilt Disease of Asters, 71
 Blanc, H., Remarkable Case of Echinococcus in Lemur, 147
 Blank, Ernst, Bent Tail in Mice, 243
 Bliss, M. C., Inter-relationships of the Taxinæ, 160
 Blood and Parasites in Films, New Rapid Staining of, 297
 Bodkin, G. E., Study of *Amblyomma dissimile* Koch, 39
 Bone Structure, Antiquity of, 238
 Børgesen, F., Marine Algæ of the Danish West Indies, 174
 Bortunowsky, Isaac, Minute Structure of Monkey's Pharynx, 131
Bosmina longirostris, Influence of Environment on, 254
 Bot-flies, 138
Botrytis cinerea, Cell-regeneration in, 66
 — Polymorphism of, 65
 Boutan, A., Function of Swim-bladder, 341
 Boycott, A. E., Parthenogenesis in *Paludestrina jenkinsi*, 343
 Boyer, G., Biology and Culture of the Higher Fungi, 284
 Bracher, Rose, *Euglena deses*, 274
 Brachydactyly in Fowl, 25
 Bracket Fungi of Citrus Trees, 287
 Brandes, E. W., Banana Wilt, 382
 Braun, Lucy E., Vegetation of Conglomerate Rocks of the Cincinnati Region, 291
 Bridges, Calvin B., Chromosome Dislocation, 36
 — Purple Eye in *Drosophila*, 250
 — Eye-colour in *Drosophila melanogaster*, 348
 Brierley, W. B., Cell-regeneration in *Botrytis cinerea*, 66
 — Polymorphism of *Botrytis cinerea*, 65
 — Some Concepts in Mycology: An Attempt at Synthesis, 286
 Briosi, Giovanni, *Plasmodiophora Brassicæ*, 292
 — and Rudolfo Farnete, Disease of Chestnuts, 185
 Briquet, J., Flower and Fruit of *Diaperia*, 160
 Bristol, Muriel B., Malay Form of *Chlorococcum humicola* (Näg.) Rabenh., 276
 — Retention of Vitality by Algæ from Old Stored Soils, 276
 British Drug Houses, Ltd., 88
 British Science Guild, Report of the Microscope Committee, 199
 Broch, Hjalmar, Cœlentera of Gunnerus, 153
 — Structure of Barnacles, 144
 Brocher, Frank, Pulsatile Tergal Organ in Lepidoptera, 137
 Bröleman, Henry W., and Jean L. Lichtenstein, Vulvæ of Diplopoda, 143
 Bromus, Fungi on, 68
 Bronze, Effect of Heat Treatment on, 81
 Brooks, F. T., Development of Potato Blight, 288
 — Silver-leaf in Fruit-trees, 186
 — and A. Sharples, Pink Disease of Plantation Rubber, 70
 Brotherus, V. F., Moseniella, a New Moss Genus from Brazil, 165
 — Moss-flora of the Argentine, 167
 — and W. Walter, Mosses of North Queensland, 271
 Brown, Elizabeth Wuist, Regeneration in *Phegopteris polypodioides*, 56
 Brown, J. G., Abnormal Conjugation in Spirogyra, 171
 Brown, N. E., 193
 "Brown-rot" Disease of Fruit-trees, 287
 Bryologica, 374
 Bryophytes and Lichens of Calcareous Soil, 74
 Bryozoa, Fossil of Panama Canal Zone, 42
Bryum vermigerum, 165
 Buch, H., *Scapuria curta* and its Allies, 374
 Buder, J. E., Spermatogenesis in *Deilephila euphorbiæ*, 250
 Bugnion, E., Cockroach Head, 142
 — New Ceylonese Termite, 38
 — Termitoxenia, 39
 Bujard, E., Split Fore-brain in Sheep Embryo, 28
 Bullock, W. E., and W. Cramer, New Factor in the Mechanism of Bacterial Infection, 294
 Bullock-Webster, G. R., New Nitella, 377
 Buren, G. V., Mycelium of the Genus Volkartia, 177
 Burger, Owen F., Sexuality in *Cunninghamiella*, 281
 Burkholder, Walter H., Production of an Anthracnose-resistant White Marrowbean, 69
 Burt, Edward Angus, Theleporaceæ of North America, 283
 Butler, E. J., Fungi and Disease in Plants, 70
 Butterworth, G. F., & A. E. Bellis, Characteristics of Rifle-barrel Steel, 299
 Byrnes, Esther F., Life-history of Cyclops, 41

C

- Cabbage, Disease of, 72
 Cacao Disease, 70
 Cajal's Formalin-silver Nitrate Impregnation Method for the Golgi Apparatus, 321, 394
 Calf, Pharyngeal Tonsil and Bursa in, 232
 Calkins, Gary N., Nuclei of *Uroleptus mobilis*, 259
 Cameron, A. E., 138
 Campbell, D. H., East Indian Hepaticæ, 270
 Cane-leaf Spot, 185
 Canu, F., and Ray S. Bassler, Fossil Bryozoa of Panama Canal Zone, 42
 Capelle, G., Botanical Observations on Various Plants, 57
 Capsella, Embryogeny of, 370
 Carazzi, D., Development of Guinea-pig, 330
 Carbon Steels, The Experimental Investigation of the Influence of the Rate of Cooling on the Hardening of, 385
 Carleton, H. M., Cajal's Formalin-silver Nitrate Impregnation Method for the Golgi Apparatus, 321, 394
 Carnations, Diseases of, 73
 Carpenteria-Limestone from B. N. Borneo, 61
 Carter, J. Thornton, Enamel Organ of Hake, 335
 Carter, Lucy A., *Amœba Proteus*, 366
 — Somatic Mitosis of *Stegomyia fasciata*, 346
 Carter, Nellie, Chloroplasts of Desmids, 274
 — Cytology of the Cladophoracæ, 377
 — — of Two Species of Characiopsis, 272
 — *Trachelomonas inconstans*, a New Flagellate, 272
 Cary, Lewis R., Respiration Rates of Samoan Alcyonarians, 358
 Case-hardening Process, Improved, 299, 386
 Castellani, Aldo, Tropical Diseases due to Microscopic Organisms in the Balkanic Zone, 83, 209
 Cat's Skull, Development of, 27
Caudate Amphibia, Fenestral Ear Plate in, 28
 Caullery, M., and F. Mesnil, Development of Testes in Parasitic Copepod, 144
 — Parasitic Rhabdocœl, 43
Cavonularia lütkenii, 257
 Cawston, F. G., Bilharziasis in Natal, 44
 — Cercariæ of Transvaal, 44
 Cedercrentz, Axel, All Dead Bacteria are not Ag-positive, 293
Ceina egregia, an Aberrant Amphipod, 252
 Cell Membrane, Nature and Permeability of the, 234
 Cell-structure and Autospore Formation in *Tetraodon minimum*, 59
 Centriole and Centrosphere in Degenerating Fibroblasts, 236
 Cephalozeliacæ, Mixtures of Species among the, 58
 Cercariæ of Transvaal, 44
 Cestodes, Methods of Reproduction in, 147
 Chamberlain, Charles Joseph, The Living Cycads, 300
 Chamberlin, Ralph V., Lithobiid Genera, 33
 Champy, Ch., and P. Colle, Correlation between Pigeon's Crop and Gonads, 334
 Chapman, Frederick, Devonian Foraminifera, 59
 — Fossil Polychæts, 352
 — Palæozoic Victorian Hydroids, 357
 — Upper Cambrian Ostracods, 254
 Chapman, Royal Norton, Pelvic Structure and Burrowing Habits, 33
Chara fragilis and *C. delicatula*, 377
 Characiopsis, Cytology of Two Species of, 272
 Chatton, Edouard, and Ch. Pérard, Ciliata from Intestine of the Goudi, 157
 Cheel, Edwin, 65, 181
 Chellaston Gypsum Breccia in relation to the Gypsum-Anhydride Deposits of Britain, 385
 Chelonian Carapace, Neural Plates of, 231
 Chemical and Metallurgical Literature, 299
 Chenantais, J. E., Pyrenomycetes, 281
 — Three Discomycetes, 176
 Chestnuts, Disease of, 185
 Chick Embryo, Cross-striations in Heart Muscle of, 335
 — Wound Healing in Early Embryo of, 25
 Chifflet, J., Ergots of Rye on Wheat, 185
 Child, C. M., Carbon Dioxide Production in Starving Planaria, 354
 — Effects of Cyanides on *Planaria dorotocephala*, 255
 — Susceptibility to Lack of Oxygen during Starvation in Planaria, 355
 Chilton, Chas., Boring Crustacea in New Zealand, 351
 — *Ceina egregia*, an Aberrant Amphipod, 252
 — Genus Phreatogammarus, 352
 — *Orchestia tucurauma* Fritz Müller, 253
 Chin, Evolution of the, 244
 Chlamydomonas, Crossing of Two Species of, 260
Chlorococcum humicola (Näg.) Rabenh., Malay Form of, 276
 Chlorophyceæ, Development and Nutrition of, 61
 — of the Adriatic, New and Rare, 376
 Chondriome, Significance of the, 51

- Chopard, L., Hermaphrodite Specimen of a Phasmid, 38
- Chromatin Maturation, 141
- Chromodoris zebra*, Gill-plumes of, 248
- — Sensory Reactions and Coloration of, 34
- Chromosome Dislocation, 36
- Chromosomes, Individuality of, 349
- Chryomonad, Pseudopodial Network for Food-catching in a, 260
- Church, A. H., Building of an Autotrophic Flagellate, 271
- Fungi as Members of the Subærial Transmigration, 389
- Historical Review of the Floridæ, 378
- — — of the Phæophyceæ, 379
- Phæophycean Zooid, 378
- Plankton-phase and Plankton-rate, 375
- Ciliata from Intestine of the Gondi, 157
- Citrus Diseases, Geographical Distribution of, 69
- Trees, Fungi of, 287
- Cladocera, Marine, 303
- Rarity of Sex Intergrades in, 40
- Cladophoracæ, Cytology of the, 377
- Clark, Eleanor Linton, and Eliot R. Clark, Vital Staining of Tadpole's Tail, 29
- Clark, Eliot R., 29
- Clasmatocytes, 237
- Clathropteris, 55
- Clathrus cancellatus* in Scotland, 182
- Clausen, Curtis P., Life-histories of Californian Coccinellids, 37
- Clavariæ, British, Revision of the, 282
- Cleland, J. Burton, and Edwin Cheel, Notes on Australian Fungi, 65
- — — Polyporus, Fomes, and Hexagona, 181
- Cleland, Ralph E.—Cytology and Life-history of *Nemalion multfidum* Ag., 278
- Clepsydrapsis, Australian Specimen of, 267
- Cleve, H. J. Van, Acanthocephala, 353
- Clibborn, Lieut.-Col. J., A Standard Microscope, 125
- Closterium phurilocellatum*, Formation of Vacuoles in, 170
- Clover, Leaf-spot Disease of, 289
- Red, Disease of, 288
- Coal, Banded Bituminous, Four Visible Ingredients in, 385
- Coccidæ, Insect Parasites of, 345
- Mutation in, 141, 142
- Coccidia Parasitic in Man, 48
- Coccidium and Isopora, Infections with, 292
- Coccinellids, Californian, Life-histories of, 37
- Cockerell, T. D. A., Fossil Fish-scales, 244
- Cocking, T. T., 84
- Cockroach Head, 142
- So-called Hynopsis in, 250
- Cod's Upper Jaw, Dentigerous Cyst on, 244
- Coker, Dorothy, North American Species of Encalypta, 166
- Coleoptera, Male Genital Tube in, 138
- Coles, A. C., Spirochæte of Infectious Jaundice in English Rats, 47
- Collembola of the Snow Level, 251
- Colletotrichum Lindemuthianum*, 67
- — Infection by, 288
- Collinge, Walter E., New Isopod of Natal, 144
- Collins, F. S., Green Algæ of North America, 277
- Woods Hole Laboratory, 170
- Working Key to the Genera of North American Algæ, 277
- Collins, H. H., Molt and Regeneration of Pelage in Deer-mice, 31, 133
- Collins, Marjorie J., Leaf-anatomy of *Scævola crassifolia*, with Special Reference to the Epidermal Secretion, 263
- Colosi, G., New Species of Meganyctiphanes, 351
- Thecosomatous Pteropods, 342
- Colour-sense in Fishes, 240
- Colpidium colpoda*, Influence of Blood-serum on, 259
- — Races of, 259
- Colton, A. D., Onion Smut, 178
- Colus Gardneri* (Berk.) Fischer, 284
- Comstock, G. F., New Light on Transverse Fissures, 82
- Conglomerate Rocks of the Cincinnati Region, Vegetation of, 291
- Coons, G. H., Treatment of Scab in Potato Tubers, 72
- Copepod Ovum, Yolk formation in, 145
- Parasite of Cod, New, 41
- Parasitic, Development of Testes in, 144
- Copepods, New Parasitic, 41
- Pelagic, Food of, 254
- Copper Alloys, 81
- Coral Reefs, Growth of, 358
- Corals of Pacific Coast of Canada, 358
- Cordero, E. H., Ciliate Protozoon from Uruguay, 49
- Notes on Gastrotricha, 44
- Cordyceps, 379
- Corethru plumicornis*, 395
- Coriulus prolificans* and *C. versicolor* on Peach Trees, 66
- Corneal Protection in Crawling Animals, 239
- Corpus adiposum buccæ*, Structure of, 30
- Corpuscles, Red Blood, Resistance of, to Hypotonic Salt Solutions, 339
- Coscinasterius tenuispina*, Asexual Multiplication in, 45
- Costa, A. Celestino da, Amnion-formation in a Bat, 129
- — — in Mammals, 129

- Cotton, A. D., Diseases of Parsnip, 72
 — Distribution of certain British Algæ, 279
 — Entomogenous Fungi New to Britain, 286
 — Japanese Seaweed, *Tosaka Nori*, 280
 — Oak-mildew on Beech in Britain, 287
 — and E. M. Wakefield, Revision of the British Clavariæ, 282
 Cotton Hairs, Existence of Daily Growthings in the Cell-wall of, 369
 Cox, H. S., 186
 Craib, Wm. G., Regional Spread of Moisture in the Wood of Trees, 266
 Cramer, W., 294
 Cranberries, Spoilage of, after Harvest, 185
 Crayfish, Australian, Abnormality in, 350
Crepidula plana, Sex-changes in, 249
 — — Sex Phenomena in, 343
 Cribbs, J. E., Columella in *Marchantia polymorpha*, 372
 Crisp, Sir Frank, Bart., 194
Cronartium rubicola on the White Pine, Incubation Period of, 63
 Crozier, Blanche C., 45
 Crozier, W. J., Asexual Multiplication in *Coscinasterias tenuispina*, 45
 — Assortive Mating in Nudibranchs, 249
 — Bottom Material Ingested by Holothurians, 150
 — Gill-plumes of *Chromodoris zebra*, 248
 — Use of Foot in some Molluses, 248
 — and L. B. Abey, Coloration of *Chromodoris zebra*, 34
 — Sensory Reactions of *Chromodoris zebra*, 84
 — and Blanche B. Crozier, Buds in Sponges, 45
 Cruchet, Paul, Fungi on Bromus, 68
 — Uredineæ, 63
 Crustacea, Boring, in New Zealand, 351
 Cull, S. T. Wallis, *Spina bifida* in very early Human Embryo, 332
 Cunningham, Bert, Cross-conjugation in *Spirogyra Weberi*, 171
 Cunninghamiella, Sexuality in, 281
 Curtis, K. M., Life-history and Cytology of *Synchytrium endobioticum*, 281
 Cushman, J. A., Fossil Foraminifera from Panama, 48
 — and Others, Fossil Foraminifera of the Canal Zone, Panama, 261
 Cutler, D. Ward, *Entamoeba histolytica*, 47
 — Remarkable Flagellate from Hind-gut of Termite, 157
 Cyathaceæ, Apogamy in the, 371
 Cycads, the Living, 300
 Cyclops, Life-history of, 41
Cypridina hilgendorfi, 254
 Cytolysins on Embryos, 129
 Cytospora, Disease due to, 73
- D
- Dahlgren, Ulric, Luminous Animals, 242
 Dalby, Nora, 281, 379
Daldinia vernicosa, 62
 Dauchakoff, Vera, Properties of Mesenchyme, 237
 Danforth, C. H., Brachydaetyly in Fowl, 25
 — Differential Selection of Germ-cells in Fowl, 233
 — Selection among Germ-cells, 330
 Darnell-Smith, G. P., Gametophyte of *Psilotum*, 54
 — Inverted Hymenium in *Agaricus campestris*, 180
 — *Phoma citricarpa* McAlp., 177
 Davey, Wheeler P., X-rays and Beetles, 348
 Davis, Donald Walton, Asexual Multiplication and Regeneration in *Sagartia luciae*, 256
 Davis, J. J., North American Ascochytae, 178
 — Parasitic Fungi in Wisconsin, 186
 Day, Edward C., Nervous System of Ascidian, 244
 Death Points, Upper Thermal, 243
 Dehorne, Armand, Crystalloids of Entamoeba, 157
Deilephila euphorbiae, Spermatogenesis in, 250
 Delage, Yves, L'Année Biologique, 229
 Demandt, Ernst, Cacao Disease, 70
 Dendritic Growths in Paper, 225
 Dentary Enamel, Structure and Origin of, 131
 Derschau, M. v., Passage of Solids from Nucleus to Cytoplasm, 236
 Desmatodon in North America, 271
 — *Wilczekii*, 374
 Desmidiaceæ collected during 1913 in Ufa, 275
 Desmids, Chloroplasts of, 274
 Dey, P. K., Physiology of Parasitism. V. Infection by *Colletotrichum Lendemuthianum*, 288
 Diaperia, Flower and Fruit of, 160
 Diatom Flora of Martin Beck, Yorks, 168
 Diatoms, Economic Importance of, 169
 — Fresh-water, from Upper Jämtland in Sweden, 168
 — from the Pacific, 169
 Dicephalic Pig, 28
 Dickey, L. B., 41
 Dicotyledonous Woods, Tier-like Structure of, 263
 Diffugia, Life cycle of, 258
 Digby, L., Archesporial and Meiotic Mitoses of *Osmunda*, 268
 Diplopoda, Vulvæ of, 143
 Diptera, Seashore, 346
 Discomycetes, 283

- Discomycetes, 176
- Dixon, Henry H., Mahogany and the Recognition of some of the Different Kinds by their Microscopic Characters, 264
- Dixon, H. N., *Miscellanea Bryologica*, 374
- Mosses Collected by the Smithsonian African Expedition, 60
- Uganda Mosses, 167
- Dobell, Clifford, Coccidia Parasitic in Man, 48
- Dodge, B. D., Study of Gymnosporangium, 64
- Doffein, F., *Pyxidicula operculata*, 258
- Dogfishes, Brain and Cranial Nerves of, 340
- Injections in, 241
- Dolley, W. L., Jun., Effect of Light on *Vanessa antiopi*, 35
- Doncaster, L., Mutation in Bacteria, 293
- Doran, Wm. D., Minimum, Optimum, and Maximum Temperatures of Spore Germination in some Uredinales, 380
- Dosdall, Louise, Overwintering of *Æcio*-spores of *Cronartium ribicola*, 63
- Douin, Ch., Mixtures of Species among the Cephalozeliaceae, 58
- Doves, Post-mortem Melanin Formation in Eyes of, 25
- Doyle, Joseph, Observations on the Morphology of *Larix leptolepis*, 265
- Dreschler, Charles, Morphology of the Genus Actinomyces, 180
- Drips, Della, Ovary of Spermophile, 23
- Drisophila ampelophila*, Vestigial Wing in, 249
- Gynandromorphism in, 36
- *melanogaster*, Eye-colour in, 348
- Purple Eye in, 250
- Duboseq, O., *Selysina perforans* Dub., 48
- Dufour, Léon, Vegetation of *Plicaria leiocarpa*, 176
- Dufrenoy, J., Ecological Conditions in the Development of Parasitic Fungi, 183
- — Diversity and Generic Coefficients, 285
- Parasite of *Arbutus Unedo*, 185
- Significance and History of Pine-needles, 159
- Dumortiera, Taxonomic Study of, 163
- Duncan, F. Martin, 303
- Dunkerley, J. W., 391
- Durand, E. J., *Peziza proteana* var. *spar-assoides* in America, 62
- E
- Earthworms, Anabiosis in, 146
- Echinococcus in Lemur, 147
- Echinoderms, Egg Secretion in, 149
- Ecological Diversity and Generic Coefficients, 285
- Edgerton, C. W., New Balansia on Cyperus, 379
- Eel, Varieties of, 33
- Effects of Quinine on Production of Yolk and Albumen, 24
- Elenkin, A. A., Formation of Vacuoles in the Desmid *Closterium plurilocellatum*, 170
- Green Algæ from the Genus Stigeoclonium Kütz, 170
- Ellinger, T., Protozoa (*Fauna Greenlandica*. VIII.), 272
- Elliott, J. A., *Coriolus prolificans* and *C. versicolor* on Peach Trees, 66
- Smut on Resine, 178
- Elliott, J. S. Bayliss, Hyphomycetes, 64
- New Species of "Fungi imperfecti," 68
- Elliott, T. G., 394
- Ellis, David, Fossil Micro-organisms from the Jurassic and Cretaceous Rocks of Great Britain, 381
- Empusa Muscæ* on *Musca domestica*, 66
- Enamel Organ of Hake, 335
- Encalypta, North American Species of, 166
- Endocrine Glands of Frog and Toad, 31
- Endothia parasitica*, 184
- Entamoeba, Crystalloids of, 157
- *histolytica*, 47
- Enumeratio Sperierum Nematelionis et Helminthocladia Japonica*, 173
- Ephemeropsis tibodensis* Goebel, 165
- Epidermal Coverings, Importance of, 367
- Epiphyllie Ulothrix, 275
- Epiphysis Nerves in Sprat and Herring, 31
- of Dogfish, 30
- Epithelial Movement in Tissue Culture, 130
- Epithelium, Corneal, Cell Movements in, 131
- Equisetum in Sweden, 162
- Ergots of Rye on Wheat, 185
- Eriksson, Jakob, Potato Disease. *Phytophthora infestans*, 175
- Study of *Phytophthora infestans*, 62
- Eseltine, G. P. van, Allies of *Selaginella rupestris* in S.E. United States, 162
- Esterly, Calvin O., Food of Pelagic Copepods, 254
- Euglena deses*, 274
- Eurotium verruculosum*, New Brown Aspergillus, 175
- Eutramorus globosus*, 169
- Evans, Alexander W., Air Chambers of *Grimaldi fragrans*, 58
- American Species of Marchantia, 163
- Hepaticæ of St. Croix, St. Jan, St. Thomas, and Tortola, 164
- Notes on New England Hepaticæ, XIII., 164
- Noteworthy Lejeuneæ from Florida, 164
- Taxonomic Study of Dumortiera, 163

- Evans, Arthur, Embryo-sac and Embryo of *Penstemon secundiflorus*, 265
- Evans, I. B. Pole, 68
- Ewart, J. Cossar, Sheep Crosses and New Varieties of Wool, 230
- Eye-pieces with Adjustable Compensation, 15
- F
- Fage, Louis, Cavernicolous Spiders, 143
- Fairman, Ch. E., New or Noteworthy Fungi from New Mexico, 68
- Falcons, Reproductive System in, 130
- Farnete, Rudolfo, 185
- Farnie, Winifred C., Structure of *Amphibola crenata*, 342
- Faull, J. H., *Fomes officinalis*, a Timber-destroying Fungus, 65
- Pineapple Fungus, or *Enfant du Pin* or *Warabou*, 380
- Fauna, Deep-water, of Lake Neuchatel, 32
- of Eichener Lake, 32
- of Ritom Lake, 339
- Fauvel, P., Intercalary Growth in a Maldivian Worm, 146
- Fawcett, H. S., Geographical Distribution of Citrus Diseases, 69
- Relation of Temperature to Growth of Fungi in Cultures, 69
- Fern, Antherozoid of, Method of Staining, 372
- Fernandes, J. F. St. A., 294
- Ferns, Apogamy in, 56
- Madagascar, 162
- of South Africa, 372
- Fibroblasts of Chick Embryos in Cultures, 337
- Files, Manufacture of, 385
- Filum terminale*, Formation of, 29
- Fink, Bruce, New Lichen Genus, 74
- Fischer, Ed., Experiments with Uredineæ, 178
- Mycological Contributions, 179
- Fishes and Marine Invertebrates, Non-existence of Nervous Shell-shock in, 239
- Organs of Internal Secretion in, 340
- Respiration in, 135
- Young, Feeding Habits of, 341
- Fish-scales, Fossil, 244
- Fitzpatrick, A. M., *Rostronitschkia*, a New Genus of Pyrenomycetes, 282
- Fitzpatrick, H. M., Publications of George Francis Atkinson, 382
- Flagellate, Autotrophic, Building of an, 271
- from Hind-gut of Termite, 157
- New Coprozoic, 359
- Peculiar Polymastigote, 360
- Flagellates, Amœboid Variations in, 259
- Flather, Mary Drusilla, Blood Supply of Areas of Langerhans, 238
- Flax Seedlings, Disease of, 289
- Fleas, 346
- Flesh-flies, Effect of Diet of Ductless Glands on, 139
- Flies, Hibernation of, 36
- Floridæ, Germination of the Spores of, 171
- Historical Review of the, 378
- Flour-moth, Mediterranean, 347
- Foa, A., Intestinal Epithelium of Silkworm, 138
- Foex, Etienne, Cordyceps, 379
- Folliculina boltoni* (S. Kent), 305
- Fomes officinalis*, a Timber-destroying Fungus, 65
- Fontell, C. W., Fresh-water Diatoms from Upper Jämtland in Sweden, 168
- Foraminifera, Devonian, 50
- Fossil, from Panama, 48, 261
- Forbes, S. A., & R. E. Richardson, Changes in Life-conditions in Illinois River, 134
- Foster, W. D., 42
- Fowl, Differential Selection of Germ-cells in, 233
- Tapeworms, Transmission of, 43
- Fowls, Blood-fat and Egg-production in, 24
- Friederichs, Counteracting Insects by Fungi, 348
- Fritsch, F. E., Fresh-water Algæ from Madagascar, 169
- — — of Africa, 277
- Frog, Parietal Organs of, 30
- Frog's Melanophores and Retina Cells, Influence of Adrenin on, 243
- Froggatt, John L., Spiracles of some Muscid Larvæ, 138
- Frye, T. C., Age of *Pterygophora californica*, 61
- The Western Sphagnaceæ, 164
- Fundulus and Mackerel, Hybrids between, 130
- Fuller, Claude, Wings and Trachæ of Termites, 140
- Fungi and Disease in Plants, 70
- as Members of the Subærial Transmigration, 380
- Australian, 65
- — No. IV. Polyporus, Fomes, and Hexagona, 181
- British, 68
- Cape, 68
- Cave, 285
- Ceylon, 183
- Colorado, 380
- Counteracting Insects by, 348
- Entomogenous, New to Britain, 286
- Exotici: xxiv., 68
- from New Mexico, 68
- Higher, Biology and Culture of the, 284

Fungi, Illustrations of, 66
 — — imperfecti," New Species of, 68
 — in Cultures, Growth of, 69
 — Michigan, 182
 — Microscopic Methods for the Study of, 182
 — New British, 286
 — — Japanese, 68, 182
 — — or Noteworthy, 63
 — Parasitic, Ecological Conditions in the Development of, 183
 — — Effect of Weather on the Attacks of, 66
 — — in Wisconsin, 186
 — Relation of Temperature and Humidity to Infection by certain, 67
 — — to other Organisms, 69
 — Saprophytic Species of, 284
 — Wood-destroying, Introduction of, 182
 Fungus from Weybridge, 67
 Fuhrmann, O., Tapeworms of Vertebrates, 354
 Fusarium Wilt of Potato in the Hudson Valley, 288
 Fusion Welding Applied to Drop Forgings, 299

G

- Gallardo, A., Myrmecophilous Beetle, 250
 Galløe, O., Lichen Structure and Development, 291
 Galloway, J. J., The Rounding of Grains of Sand by Solution, 262
 Garcia-Banus, Mario, Is there a Metabolic Gradient in Tubularia? 256
 Gardner, N. L., New Pacific Coast Marine Algæ, 278
 Garman, Harrison, Swarms of Fresh-water Medusoids, 257
 Garrett, A. O., Smuts and Rusts of Utah, 282
 Garvin, M., 385
 Gastropods, Pulmonate, Spermatogenesis of, 341
 Gastrotricha, 44
 Gatenby, J. Bronté, Dimorphic Spermatozoa in *Paludina vivipara*, 135
 — Gametogenesis and Early Development of *Limnæa stagnalis*, 136
 — Germinal Nurse-cells of Testacella, 136
 — Polyembryony in Parasitic Hymenoptera, 344
 — Segregation of Germ-cells in *Trichogramma evanescens*, 343
 — Spermatogenesis of Pulmonate Gastropods, 341
 — The Identification of Intracellular Structures, 93, 189
 Gemmill, James F., Rhythmic Pulsation in Madreporic Vesicle of Young Ophiroids, 150
 Germ-cells, Selection among, 330
 Gerner, G. C., 299
 Gilchrist, J. D. F., Crawling Medusa from the Cape, 153
 — Transverse Fission in Phoronopsis, 148
 Ginseng, Root-rots of, 70
 Glaser, O. C., Neural Folds, 232
 Gleichen, Alexander, Theory of Modern Optical Instruments, 387
 Glen, Edith H., *Peripatus capensis*, 350
 Gley, E., Hæmolytic Action of Blood of Young Eels, 338
 Goebel, K., Organography of Plants, 57
 Goette, A., Life-cycle of *Diffugia*, 258
 Gold, Absorption of, by Fungi, 69
 Golgi Apparatus, 321
Gomontia lignicola sp. n., a Wood-penetrating Alga, 61
 Gonads as Controllers of Characteristics, 333
 Goodale, H. D., Interstitial Cells in Gonads of Fowl, 233
 — and Grace Macmullen, Winter Egg-production in Poultry, 330
 Goodrich, Edwin S., Heart of Reptiles, 340
 — Pericardio-peritoneal Canals in Sela-chians, 331
 Goodspeed, T. H., Modification of Hand Microtome, 78
 Goor, A. J. C. van, *Noctiluca miliaris* Sur., a Cytological Investigation, 168
 Gorgonacca, Membranous Forms of Colonies in, 151
 Gould, Harley N., Sex-changes in *Crepidula plana*, 249
 — Sex Phenomena in *Crepidula plana*, 343
 Graff, Paul W., Philippine Basidiomycetes, 182
 Graham-Smith, G. S., Hibernation of Flies, 36
 Grasses of Illinois, 266
 Grayson, H. J., 20
 Green, E. Ernest, Mutation in Coccidæ, 142
 Green, G. W., 385
Grimaldi fragrans, Air Chambers of, 58
 Grotts, F., The Metallography of Heat Treatment of Metals used in Aeroplane Construction, 82
 Grove, W. B., British Species of Melanconium, 62
 — New or Noteworthy Fungi, 63
 Groves, J., *Lychnothamnus*, 377
 — and G. R. Bullock-Webster, *Chara fragilis* and *C. delicatula*, 377
 Grunow, A., Sargassum, 378
 Gryllofalpa, Spermatogenesis of, 251
 Guilliermond, A., Significance of the Chondriome, 51
 — *Zygosaccharomyces Nadsonii*, sp. n., 176
 Guinea-pig, Development of, 330
 — Teeth of, 338

- Guinea-pigs, Effect of Alcohol on, 128
 Gunnerus, Cœlentera of, 153
 Güssow, H. T., *Empusa Muscæ* on *Musca domestica*, 66
 Guyer, M. F., and E. A. Smith, Effect of Cytolysins on Embryos, 129
 Gymnosporangium, 64
 Gynandromorph Daphnids, 40
 Györfy, L., *Ephemeropsis tjibodeusis* Goebel, 165
- H
- Hadwen, S., and A. E. Cameron, Bot-flies, 138
 Hæmolytic Action of Blood of Young Eels, 338
 Hagfish-skin, Minute Structure of, 236
 Hahn, Erna, Colour-sense in Diurnal Birds, 241
 Hallimond, A. F., 385
 Hanschiu, Ed., Collembola of the Snow Level, 251
 Hanson, D., Rapid Re-crystallization in Deformed Non-ferrous Metals, 81
 — and J. E. Hurst, Improved Case-hardening Process, 299
 — — Improvements in the Case-hardening Process, 386
 — and S. L. Archbutt, Micrography of Aluminium and its Alloys, 81
 Hanson, F. B., Coracoid of Pig, 232
 — Development of Pig's Sternum, 331
 Haplotaxis, New North American Species of, 42
 Hardenberg, C. B., South African Bag-worms, 187
 Harper, Edward T., Notes on Hypholoma, 66
 Harris, J. A., 24
 Hart, Charles Arthur, *Nearctic Pentatomidea*, 349
 Hartman, Carl, Development of Opossum, 28
 Hartmann, Otto, Influence or Environment on *Bosmina longirostris*, 254
 Hartridge, H., A Method of Adjusting Tube Length, 119
 — Eye-pieces with Adjustable Compensation, 15, 84
 Harvey, E. Newton, Light-production in *Cypridina hilgendorfi*, 254
 Harvey, R. B., Importance of Epidermal Coverings, 367
 Haskell, Royal J., Fusarium Wilt of Potato in the Hudson River Valley, New York, 288
 Hatai, S., Feeding Sudan to Young Albino Rats, 128
- Hatfield, W. H., The Mechanical Properties of Steel, 385
 — and G. L. Thirkell, Season Cracking, 299
 Hatscher, Emil, Forms assumed by Drops and Vortices of a Gelatinizing Liquid in Various Coagulating Solutions, 384
 Hattori, H., Microbiological Researches on Japanese Water-supplies, 60
 Haughwout, F. G., Infections with Coccidium and Isospora in Animals in the Philippine Islands, 292
 — Protozoa of Manila, 46
 Haupt, Arthur W., *Pallaricinia Lyellii*, 163
 Hausen, F. F., and O. A. Knight, Effect of Heat Treatment on Bronze, 81
 Haviland, Maud D., Red-currant Aphis, 140
 Hayata, Bunzo, Protomarattia, a New Genus of Marattiaceæ, and Archangiopteris, 161
 Heart-Urchin, 356
 Hegner, R. W., Variations in Arcella, 46
 Hemlock, Timber Decay of, 380
 Henderson, M. P., Disease of Cabbage, 72
 Hepaticæ, East Indian, 270
 — New England, 164
 — of St. Croix, St. Jan, St. Thomas, and Tortola, 164
 Herbst, Curt, and H. Plessner, Nerves of Antennules Regenerated in Place of Eyes, 252
 Herdman, W. A., and others, Intensive Study of Isle of Man Plankton, 134
 Hernández, F. F., New Sponges from Spain, 45
 Herzog, T., Two Cleistocarpic Mosses of the Bolivian High Cordilleras, 166
 Heterosis and Double Fertilization, 34
 Heyn, E., and O. Bauer, Researches on Bearing Metals, 299
 Hickson, S. J., Corals of Pacific Coast of Canada, 358
 Hieronymus, G., The Genus Pteris, 269
 Hilgendorf, F. W., Insect Life of New Zealand Mountain Station, 141
 Hill, J. Ben, Anatomy of *Lycopodium reflexum*, 372
 H-ions, Reaction of Fishes to, 33
 Hodgson, Robert W., Sterigmatocystis Smut of Figs, 70
 Holly Tortrix Moth, Germ-band in, 136
 Holmgren, Nils, Epiphysis Nerves in Sprat and Herring, 31
 — — of Dogfish, 30
 — Parietal Organs of Frog, 30
 Holothurians, Bottom Material Ingested by, 150
 Hopkins, H. S., 246
 Hopkinson, John, 391
 Horne, A. S., Fungi on *Aleurodes vaporarum*, 66

- Hoskins, E. R., and M. M., Influence of Thyroid on Growth and Development of Amphibia, 332
 — — Reactions of Dogfishes to Injections, 241
 Hott, Samuel L., Static, Dynamic and Notch Toughness, 82
 Howe and others, Flakes in Alloy Steel, 82
 Howe, Marshall A., Calcareous Algæ from Murray Island, Australia, and Cocos-Keeling Islands, 280
 — Fossil and Recent Lithothamnizæ of the Panama Canal Zone, 378
 Hubert, E. E., 64
 Huie, L. H., Germ-band in Holly Tortrix Moth, 136
 Humfrey, J. C. W., Macro-etching and Macro-printing, 385
 Huntsman, A. G., Growth of Fish Scales, 336
 Hurst, J. E., 299, 386
 Hutton, J. Arthur, Scale-reading in Salmon, 336
 Hydatina, Sex Determination in, 149
 Hydroid, New South African, 153
 Hydroids, Palæozoic Victorian, 357
 — Pigment of, 152
Hygromia limbata (Drap.), 343
 Hyman, L. H., Action of Potassium Cyanide in Planaria, 255
 — Oxygen Consumption in Feeding and Starving Planaria, 355
 Hymenomyces, Resupinate, 283
 Hymenoptera, Parasitic, Polyembryony in, 344
 Hypoholoma, 66
 Hyphomycetes, 64
 — and the Rotting of Timber, 64
 Hypocreales, Organogenic Researches on, 176
 Hypogymizæ, 383
 Hypophysis and Thyroid, Functional Correlation of, 239
 — Development of, 26
 — in Dogfish, 27
 — of Reptiles, 26
- 1
- Ibbotson, F., 386
 Illinois River, Changes in Life-conditions in, 134
 Imms, A. D., Insect Parasites of some Coccidæ, 345
 Insect Life of New Zealand Mountain Station, 141
 Interstitial Cells in Gonads of Fowl, 233
 Intracellular Structures, The Identification of, 93
 Iresine, Smut on, 178
 Isaak, I., Luminescence in Tiger-moth 347
 Isopod, New, of Natal, 144
 Isopods, Land, 253
- J
- Jackson, H. S., Puccinia on Carduaceæ, 64
 Jacobs, M. H., Acclimatization and Upper Thermal Death Points, 243
 Janet, Charles, Phylogenesis of the Orthobiont, 271
 Jellyfish, Nerve-conduction in 257
 Jensen, C., 165
 Johnson, D. S., Fruit of Opuntia, 370
 Johnson, F., Mechanical Properties of the Alloys of Copper and Zinc, 81
 Jones, D. F., Heterosis and Double Fertilization, 51
 Jordan, H. E., Histogenesis of Blood-platelets in Yolk-sac of Pig, 29
 — Intercalated Discs in Striped Muscle 238
 — Striped Muscle of Mantis, 251
 Juillard, G., and H. Pierre, French Mycology, 183
- K
- Kaburaki, T., 255
 Kannan, K. Kunhi, Mutation in Coccidæ, 141
 Karyokinesis, Amitotic, 237
 Kashyap, S. R., Androecium in *Plagiochasma appendiculatum* L. et L. and *P. articulatum* Kashyap, 270
 Kauffman, C. H., Michigan Fungi, 182
 Kelestomniæ: a Sub-family of Cretaceous Cribimorph Polyzoa, 385
 Kepner, W. A., Reactions of Proboscis of *Planaria albissima*, 148
 Kesteven, H. Leighton, Yolk-formation in Copepod Ovum, 145
 Kew Gardens Pathological Laboratory, 290
 Kindred, James E., North American Representative of *Trichodrilus*, 42
 King, Helen Dean, Inbreeding and Body Weight in Albino Rats, 128
 — — and Fertility in Albino Rats, 128
 — — and Sex-Ratio in Albino Rats, 127
 — — effects in Albino Rats, 332
 Kirknam, W. B., Fate of Homozygous Yellow Mice, 231
 — Suckling and Embryonic Development in Mice, 128
 Knight, O. A., 81
 Koch, Mathilda L., and Oscar Riddle, Analysis of Ataxic Bruins of Pigeons, 32

- Kodak Ltd., 189
 Koehler, O., Hybridization Experiments with Sea-Urchins, 256
 Kofoid, Charles Atwood, and Olive Swezy, New Species of *Trichomitus*, 365
 — — — of *Trichonympha*, 363
 — — — *Trichonymphid*, 364
 — — Peculiar Polymastigote Flagellate, 360
 Kollman, Max, Female Reproductive System in Falcons, 130
 Konrad, P., and René Maire, Agarics, 283
 Krakover, J., Disease of Red Clover, 288
 Krakover, L. J., Leaf-spot Disease of Red Clover caused by *Macrosporium sarcinaforme*, 289
 Krogh, A., and Isabella Leitch, Respiration in Fishes, 135
 Krynitzky, A. I., Decomposition of Metals, 81
 Kuehneola, 64
 Kufferath, H., Algal Flora of South Luxembourg, 276
 Kunkel, B. W., Effect of Diet of Ductless Glands on Flesh-flies, 139
 Kusano, S., Life-History and Cytology of *Olpidium*, 62
 Kylin, Harald, Germination of the Spores of Florideæ, 171
 — and C. Skottsbjerg, Sub-Antarctic and Antarctic Marine Algæ. II.: Rhodophyceæ, 280
- L
- La Mer, Victor K., 25
 Lacsny, J. L., Bacillariaceæ of the Streams near Nagyvárad, 376
Lactuca saligna Linn., Leaf of, 368
 Lagarde, J., Cave Fungi, 285
 Lambert and others, Opacimeter for Standardizing Bacterial Emulsions, 295
 Lang, R. J., 384
 Lang, W. D., The Kelestomniæ: a Sub-family of Cretaceous Cribromorph Polyzoa, 385
 Langdon, L. M., Ray-System of *Quercus*, 52
 Lange, Jakob E., Agarics of Denmark, 180
 Langerhans, Blood Supply of Areas of, 238
Larix leptolepis, 265
 Larson, John A., Functional Correlation of Hypophysis and Thyroid, 239
 Larson, Mary Elizabeth, Endocrine Glands of Toad, 31
Lastrea Felix-mas, Duration of Prothallia of, 269
 Lauritzer, J. L., Relation of Temperature and Humidity to Infection by certain Fungi, 67
 Lawrence-Balls, W., The Existence of Daily Growth-rings in the Cell-wall of Cotton Hairs, 369
 Lawson, A. Anstruther, Gametophyte Generation of the Psilotacæ, 54
 Leach, Julian G., Parasitism of *Puccinia*, 179
 Lebour, Marie V., Feeding Habits of Young Fishes, 341
Lecanium persicæ and its Symbiotic Yeasts, 348
 Lechmere, A. Eckley, *Epiphyllie Ulothrix*, 275
 Leeches, Taste in, 255
 Legraud, Louis, Theory of Specific Plasma, 235
 Leigh-Sharp, W. Harold, New Copepod Parasite of Cod, 41
 — New Species of Lernæopoda, 41
 Leitch, Isabella, 135
 Lejeuneæ from Florida, 164
 Leitini, Ceylon, 181
 Leonard, Elizabeth J., Genus *Tænitis*, with Notes on *Tænitidinae*, 162
 Leonie, Michael, Non-odible Mushrooms in Cultivated Mushroom Beds, 184
 Lepidoptera, Genital Apparatus in, 35
 — Pulsatile Tergal Organ in, 137
 Lepidopterous Larvæ, Olfactory Sense of, 35
Leptogorgia irramosa (Grieg), 151
Leptonia incana, Fluorescent Colouring Matter from, 286
 Lernæopoda, New Species of, 41
 Lewis, Margaret Reed, Development of Cross-striations in Heart Muscle of Chick Embryo, 335
 Lewis, Warren H., Centriole and Centrosphere in Degenerating Fibroblasts, 236
 — Degeneration of Fibroblasts of Chick Embryos in Cultures, 337
 Lice, Biology of, 37
 Lichen Flora of the West Coast, 383
 — Genus, New, 74
 — Structure and Development, 291
 Lichenology in Great Britain, 73
 Lichens, American, 290
 — Biomorphogenesis in, 290
 — British, 73, 389
 — Ecology of, 74
 — of a Boulder-clay Area, 74
 — of Sand-dunes, 74
 Lichtenstein, J. L., 143
 Light scattered by Gases: its Polarization and Intensity, 76
 — Scattering of, by Solid Substances, 388
 Lightbown, Constance M., Dorsal Mesenteric Filaments of Siphonozooids of Pennatulacea, 257
 Limitations of Microscopy, 1
Limnæa stagnalis, Gamatogenesis of, 136
 Limulus, Heart of, 350

- Lipschütz, A., Sex-characters and Sex-glands, 333
- Lister, G., Haunts of the Mycetozoa, 75
- Mycetozoa found during the Selby Foray, 291
- — in Britain, 75
- Shrewsbury Mycetozoa, 75
- Lithobiid Genera, 39
- Lithothamnium, Fossil and Recent, of the Panama Canal Zone, 378
- Lizard, Flagellate of, found also in Tick, 365
- Lloyd, C. G., Mycological Notes, 181
- Xylaria, 184
- Lobik, A. J., Desmidiaceæ collected during the Summer of 1913 in the Government of Ufa, 275
- Locusta viridissima*, Chromatin Maturation in Spermatogenesis of, 141
- Lohner, L., Taste in Leeches, 255
- Long, J. A., Oestrous Cycle in Rats, 24
- Longley, W. H., Colours of Reef-fishes, 33
- Louse, Mouth-parts and Mode of Feeding in, 37
- Lucas, A. H. S., Algæ of Commonwealth Bay, 174
- Australian Marine Algæ, 280
- Luminous Animals, 242
- Lund, E. J., Respiration in Paramecium, 47
- Lychnothamnus, 377
- Lycopodium reflexum*, Anatomy of, 372
- Lycopods in South Australia, 54
- Lyle, Lilian, Developmental Forms of Marine Algæ, 173
- Lynch, Vernon, Functions of Nucleus, 337
- Lyngbe, Bernt, Brazil Parmeliæ, 290
- M
- Macacus rhesus*, 303
- Macbride, E. W., Development of Heart-Urchin, 356
- MacCardy, H. M., Nuclear Re-organization in Arcella, 46
- McClellan, F. K., 393
- McDougal, W. B., Development of *Stropharia epimyces*, 282
- McIndoo, N. E., Olfactory Organs of Orthoptera, 38
- Olfactory Sense of Lepidopterous Larvæ, 35
- McJunkin, F. A., Origin of Phagocytic Mononuclear Cells, 29
- McLennan, J. C., and R. J. Lang, Extreme Ultra-violet Spectra, with a Vacuum Grating Spectrograph, 384
- Macleod, Julius, Quantitative Method in Biology, 339
- Macmullen, Grace, 330
- Macro-etching and Macro-printing, 385
- Macrosporium sarcinæforme*, 289
- Madreporic Vesicle of Ophiurods, 150
- Maffei, Luigi, 184
- Magath, Thomas Byrd, Study of a Nematode, 353
- Maggots in Sterilized Tissue, 139
- Magnusson, A. H., Lichen Flora of the West Coast, 383
- Species of Brown Parmeliæ and Hypogymniæ, their Occurrence and Fertility, especially on the West Coast, 383
- Mahogany, Microscopic Characters of, 264
- Maire, René, 283
- Maldanian Worm, Intercalary Growth in, 146
- Mammals, Amnion in, 129
- Manesse, E., Rocks of Italian Somaliland, 385
- Mann, Albert, Economic Importance of Diatoms, 169
- Mantis, Striped Muscle of, 251
- Marattiaceæ, 161
- Marchantia, American Species of, 163
- *polymorpha*, Columella in, 372
- Mast, S. O., Orientation in Volvox and Pandorina, 260
- Reversion of Orientation to Light in *Spondylomorom quarternarum*, 157
- Matsumoto, Shinichi, Cell Movements in Corneal Epithelium, 131
- Epithelial Movement in Tissue Culture, 130
- Mayer, Alfred Goldsborough, Death from High Temperature, 242
- Growth of Coral Reefs, 358
- Nerve-conduction in Jellyfish, 257
- Non-existence of Nervous Shock in Fishes and Marine Invertebrates, 239
- Rate of Nerve-conduction in Sea-water, 240
- Mayfield, A., Lichens of a Boulder-clay Area, 74
- May-fly Nymphs, Light Reactions of, 139
- Mayor, Eug., Mycological Flora of the Chateau d'Œx Region, 381
- Mazza, Angelo, Oceanic Algology, 173
- Medusa, Crawling, from the Cape, 153
- Medusoids, Fresh-water, 257
- Meganyctiphanes, New Species of, 351
- Melampsora Cultures, 64
- Melanconium, British Species of, 62
- Melanophores, 132
- Mello, Froilano de, and J. F. St. Antonio Fernandes, Revision des Champignons Appartenant au Genre *Nocardia*, 294
- Melosira Raeseana* Rabenh., a Luminous Diatom, 375
- Mendel, J., Buccal Amœbæ, 258
- Merrill, E. D., and H. W. Wade, Validity of the name *Discomyces* for the Genus of Fungi variously called *Actinomyces*, *Streptothrix* and *Nocardia*, 283

- Mesenchyme, Properties of, 237
 Mesnil, F., 43, 144
 Metallography, Non-ferrous, Etching
 Media used in, 81
 — of Heat Treatment of Metals used in
 Aeroplane Construction, 82
 Metallurgical Literature, 299
 Metals, Decomposition of, 81
 — Deformed Non-ferrous, Rapid Re-
 crystallization in, 81
 Metcalf, Maynard M., Taxonomic Study
 of Salsidæ, 245
 — and Hoyt S. Hopkins, Taxonomic Study
 of Pyrosoma, 246
 Meylan, Ch., *Desmatodon Wilczekii*, 374
 — Myxomycetes, 383
 Mice, Bent Tail in, 243
 — Fate of Homozygous Yellow, 231
 — Pocket, Autotomy in, 31
 — Suckling and Embryonic Development
 in, 128
 — Superfoetation in, 230
 Microbiological Researches on Japanese
 Water-supplies, 60
 Microfungi, New or Rare, 286
 — Parasitic, 184
 Micro-organisms, Fossil, from the Jurassic
 and Cretaceous Rocks of Great Britain,
 381
 Microscope, a Standard, 125
 Microtome, Hand, Modification of, 78
 Miller, S. W., Fusion Welding Applied to
 Drop Forgings, 299
 Millipede, Food of, 39
 Mirrors, Prisms and Lenses, 388
 Mites, A Hundred New, 350
 — in Culture Tubes, 39
 Mitra, S. K., Effect of Salts on the Growth
 of Wine-yeast, 67
 Mohr, Otto L., Chromatin Maturation in
 Spermatogenesis of *Locusta viridis-*
sima, 141
 Molander, Arvid R., *Leptogorgia irramosa*
 (Grieg), 151
 — Membranous Forms of Colonies in
 Gorgonacea, 151
 — Significance of Calyx in Alcyonacea,
 151
 Möller, H., Moss Distribution in Sweden,
 166
 Molluscs, Mucle-fibres of, 135
 — Use of Foot in, 248
 Monard, A., Deep-water Fauna of Lake
 Neuchâtel, 32
Monilia cinerea, 287
 Monkey's Pharynx, Minute Structure of,
 131
 Moodie, Roy L., Antiquity of Bone Struc-
 ture, 238
 Moore, Carl R., Gonads as Controllers of
 Characteristics, 333
 — Influence of Gonads in White Rats,
 233
 Moore, G. T., A Wool-penetrating Alga,
Gomontia lignicola, sp. n., 61
 Moreau, Fernand, Discoloration of Paper
 Pulp due to Fungi, 183
 — Microscopic Methods for the Study of
 Fungi, 182
 — and Madame, Biomorphogenesis in
 Lichens, 290
 — — Researches on Lichens of the Family
 Peltigeraceæ, 290
 Morgan, T. H., Gynandromorphism in
Drosophila, 36
 Morgenthaler, O., Bee Diseases, 349
 Morrill, C. V., Symmetry Reversal and
 Mirror-imaging in Monstrous Trout,
 232
 Mortierella, 175
 Moseniella: a New Moss Genus from
 Brazil, 165
 Mosher, Edna, Grasses of Illinois, 266
 — Pupæ of Notodontoidea, 38
 — — of Sphingidæ, 137
 Moss Distribution in Sweden, 166
 — Exchange Club, 271
 — New, from the Pleistocene of Kec-
 skemet, Hungary, 270
 Mosses, Anatomy of, 373
 — and Ferns from the Pacific, 167
 — Cleistocarpic, of the Bolivian High
 Cordilleras, 166
 — of North Queensland, 271
 — of the "Vega" Expedition, 166
 — Uganda, 167
 Moss-flora of the Argentine, 167
 Muir, Frederick, Male Genital Tube in
 Coleoptera, 138
 Müller, R. T., Fauna of Eichener Lake, 32
 — Study of *Tanymastix lacunæ* Guérin, 40
 Munson, I. P., Continuity of Cells and
 Amitotic Karyokinesis, 237
 Murisier, P., Division of Melanophores of
 Trout, 132
 Murray, John G., Jun., Relation of Ovary
 to Causation of Sex, 333
 Murrill, W. A., Illustrations of Fungi, 66
 — *Poria*, 380
 Muscid Larvæ, Spiracles of, 138
 Muscle, Stripe-1. Intercalated Discs in, 238
 Mushrooms, Non-edible, in Cultivated
 Mushroom Beds, 184
 Mutch, Nathan, The Isolation of the
 Single Bacterial Cell, 189, 221
 Mycelium of the Genus *Volkartia*, 177
 Mycena, New, 286
 Mycetozoa, Haunts of the, 75
 — in Britain, 75
 — of Chingford District, 75
 — (Selby Foray), 291
 — Shrewsbury, 75
 Mycological Contributions, 179
 — Flora of the Chateau d'EX Region,
 381
 — Notes, 181

Mycology, British, 65
 — — The Selby Foray, 235
 — French, 181, 183
 — Greek, 182
 — of Shoulder-girdle and Pectoral Fin in Fishes, 343
 — Some Concepts in, 286
 Myrmecophilous Beetle, 250
 Myxomycete from Madagascar, 291
 Myxomycetes, 383
 — Michigan, Collection of, 291
 Myxosporidia, Indian, 47

N

Nakaharo, Waro, Structure of Oocytes of Stone-fly, 38
 Nakano, H., Researches on the Development and Nutrition of some Chlorophyceæ, 61
 Narcissus Disease, 185
 Narita, Seiichi, *Enumeratio Specierum Nemalionis et Helminthocladia Japonica*, 173
 National Physical Laboratory, Report for the Year 1917-1918, 77
Nebela scutellata Wailes, 189
Nemalion multifidum Ag., Cytology and Life-history of, 278
 Nematode, New, in Calves, 147
 — Parasite of Chicken, 42
 — Study of a, 353
 Nerve-conduction in Sea-water, Rate of, 240
 Nerves of Antennules Regenerated in Place of Eyes, 252
 Nervous System, Influence of Temperature on, 27
 Neural Folds, 232
 Newman, H. H., Hybrids between Fundulus and Mackerel, 130
 Nicholls, George E., Reissner's Fibre, 238
Niphrodium hirtipes Hook., Apogamy in, 268
 Nitella, New, 377
 Nocardia, 283, 294
Noctiluca miliaris Sur., 168
 Nordqvist, O., Are there Varieties of Eel? 33
 Notodontoidea, Pupæ of, 38
 Nucleus, Functions of, 337
 — to Cytoplasm, Passage of Solids from, 236
 Nudibranchs, Assortive Mating in, 249
 Nukada, S., Heart of Limulus, 350
 Nusbaum-Hilarowicz, J., Organs of Internal Secretion in Fishes, 340
 Nuttall, George H. F., Biology of Lice, 37

O

Oak-mildew on Beech in Britain, 287
 — Stems, Depressed Segments of, 367
 — Timbers, Technology of, 264
 Obituary—
 Crisp, Sir Frank, Bart., 194
 Grayson, H. J., 20
 Octopus, Colour-sense in, 248
 Oligochæts of the High Alps, 147
 Olpidium, Life-history and Cytology of, 62
 Onion Smut, 178
 Onychomyrmex, 36
 Ophiodebella on Ficus, Undescribed Species of, 186
 Ophiuroids, Young, Rhythmic Pulsation in Madreporic Vesicle of, 150
 Opossum, Development of, 28
 Optical Instruments, Theory of Modern 387
 Opuntia, Fruit of, 370
Orchestia lucrauna Fritz Müller, 253
 Organography of Plants, 57
 Orthobiont, Phylogenesis of the, 271
 Orthoptera, Olfactory Organs of, 38
 Orton, C. R., Polemoniaceous Rusts, 282
 Osborn, T. G. B., Habitat and Mode of Occurrence in South Australia of two Genera of Lycopods unrecorded for the State, 54
 — The Tuber of Phylloglossum, 371
 Osborne, W. A., Aqueous Humour, 133
 Osmotic Pressure of the Blood, 243
 Osmunda, Archiesporial and Meiotic Mitoses of, 268
 Ostenfeld, C. H., Bacillariales, 273
 — Schizophyceæ, 273
 Ostracods, Upper Cambrian, 254
 Ovary, Relation of, to Causation of Sex, 333
 Overholts, L. D., Colorado Fungi, 380
 Ovum, Human, Maturation of, 329

P

Padina, Alternation and Parthenogenesis in, 278
Pallavicinia Lyellii, 163
 Palm, Bj., Scandinavian Taphrina Species, 177
Palulectrina jenkinsi, Parthenogenesis in 343
Paludina ricipara, Dimorphic Spermatozoa in, 135
 Papanicolaou, George N., 128
 Paper Pulp, Discoloration of, due to Fung 183
 Paramecium, Respiration in, 47
 Parker, G. H., Renilla, 151
 Parmeliæ, Brazil, 290
 — Brown, 383
 Parsnip, Diseases of, 72

- Pascher, A., Amœboid Variations in Flagellates, 259
 — Crossing of Two Species of Chlamydomonas, 260
 — New Amœbæ, 258
 — Pseudopodial Network for Food-Catching in a Chryomonad, 260
 — Undulating Marginal Cilia in a Green Flagellate, 168
 Patonillard, N., Conidial Forms of Basidiomycetes, 181
 — Myxomycete from Madagascar, 291
 Patten, Bradley M., Reactions of Whip Scorpions, 40
 Paul, D., *Clathrus cancellatus* in Scotland, 182
 Paulson, R., Ecology of Lichens, 74, 392
 Peacock, A. D., Mouth-parts and Mode of Feeding in Louse, 37
 Pearson, A. A., 67, 283
 — New Mycena, 286
 — Two-spored Basidia, 65
 Pecker, Sophie, Influence of Blood-serum on *Colpidium colpoda*, 259
 Pegler, Alice, and I. Pole Evans, Cape Fungi, 68
 Pelage in Deer-mice, Moults and Regeneration of, 133
 Pelagic Eggs in Port Erin Bay in 1918, Monthly Occurrence of, 134
 Pelvic Structure and Burrowing Habits, 33
 Penard, E., On *Folliculina boltoni* (S. Kent), 193, 305
 Pennatulaceæ, Dorsal Mesenteric Filaments of Siphonozoids of, 257
Penstemon secundiflorus, Embryo-sac and Embryo of, 265
 Pentatomoidea, Nearctic, 349
 Pérard, Ch., 157
 Perch, Climbing, Tumours in, 32
Peripatus capensis, 350
 Petch, T., Ceylon Lentini, 181
 — — Fungi, 183
 — — Polypori, 181
 — *Colus Gardneri* (Berk.) Fischer, 284
 Petersen, J. B., Danish Aerophilous Algæ, 376
 Pethybridge, G. E., Disease of Flax Seedlings, 289
 Pethybridge, G. H., Destructive Disease of Seedling Trees of *Thuja gigantea*, 382
 — Saprophytic Species of Fungi associated with Diseased Potato Plants and Tubers, 284
 Peltigeraceæ, Researches on, 290
Peziza proteana var. *sparassoides* in America, 62
 Phæophyceæ, Historical Review of the, 379
 Phæophycean Zoïd, 378
 Phagocytic Mononuclear Cells, Origin of, 29
 Phasmid, Hermaphrodite Specimen of a, 38
Phegopteris polypodioides, Regeneration in, 56
 Phillips, Arthur, and George C. Gerner, Influence of Certain Variables associated with the Anneal of Cold-worked Alpha Brass, 299
 Phillips, R. W., Duration of Prothallia of *Lastræa Felix-mas*, 269
Phoma citricarpa McAlp., 177
 Phoronopsis, Transverse Fission in, 148
 Phreatogammarus, 352
 Phyllachoras from Porto Rico, 281
 Phylloglossum, Tuber of, 371
 Phyllosticta, Index to American Species of, 177
 Physoderma Disease of Corn, 281
Phytophthora Faberi Maubl., 287
 — *infestans*, 62
 Pierre, H., 183
 Pig, Coracoid of, 232
 — Heart-muscle of, 338
 Pig's Sternum, Development of, 331
 Pigeon's Crop and Gonads, Correlation between, 334
 Pigeons, Ataxic Brains of, 32
 — Hereditary Ataxia in, 32
 — Identical Female Twins in, 23
 Piguët, Emile, Oligochæts of the High Alps, 147
 Pineapple Fungus, 380
 Pine-needles, Significance and History of, 159
 Pine Seed-beds, Fungus Flora of, 65
 Piper, C. V., and H. S. Cox, Rhizoctonia on Lawns and Pastures, 186
Plagiobasma appendiculatum L. et L. and *P. articulatum* Kashyap, 270
 Planaria, Action of Potassium Cyanide in, 255
 — *albissima*, Reactions of Proboscis of, 148
 — *dorocephala*, Effects of Cyanides on, 255
 — Oxygen Consumption in Feeding and Starving, 355
 — Respiratory Metabolism in, 354, 355
 — Starvation in, Lack of Oxygen during, 355
 — Starving, Carbon Dioxide Production in, 354
 Plankton Bacillariæ, Adriatic, 375
 — in the Lake of Geneva, 272
 — Isle of Man, Intensive Study of, 134
 — phase and Plankton-rate, 375
 Plant Diseases, Philippine, 289, 293
 — Formations, Statistical Investigations on, 52
 Plants, Fossil, from the Canal Zone, 266
 Plasma, Specific, Theory of, 235
Plasmodiophora Brassicæ, 292
Platyzoma microphyllum R.Br., 55
 Playfair, G. I., Fresh-water Rhizopoda of Sydney and Lismore, N.S.W., 48
 — New and Rare Fresh-water Algæ, 277

- Pledge, J. H., 189
 Plessner, H., 252
Plicaria leiocarpa, 176
 Plum-trees, "Wither Tip" of, 73
Pluteus admirabilis and *Tubaria furfuracea*, 283
 Pohlman, A. G., Double Ureters in Pig and Man, 28
 Polimanti, O., Colour-sense in Fishes, 240
 — Colour-sense in Octopus, 248
 Politis, Ioannes, Greek Mycology, 182
 Polychæta of Northern Coasts of Spain, 146
 Polychæts, Fossil, 352
 Polyclads, Japanese, 255
 Polypori, Ceylon, 181
 Pond-life Exhibition, 195
 Poria, 380
 Portevin, A. M., and M. Garvin, Experimental Investigation of the Influence of the Rate of Cooling on the Hardening of Carbon Steels, 385
 Portier, Paul, New Theory of Symbiosis, 236
 Potato Blight, 288
 — Disease, *Phytophthora infestans*, 175
 — Leaf-roll, 72
 — Scab, Common, 382
 — Tuber, Potential Parasites of, 71
 Poultry, Winter Egg-production in, 330
 Poynter, C. W. M., Wound Healing in Early Embryo of Chick, 25
 Prashad, B., 32, 41, 43, 47, 147
 Pratt, H. S., Cuticula and Sub-cuticula of Trematodes and Cestodes, 44
 Prenant, Marcel, Rhabditides of Turbellaria, 148
 Presidential Address, 1917-18: The Limitations of Microscopy. By Joseph E. Barnard, 1
 Proceedings of the Society—
 Meeting, December 18, 1918, 83
 — January 15, 1919, 84
 — February 19, 1919, 88
 — March 19, 1919, 187
 — April 16, 1919, 191
 — May 21, 1919, 194
 — June 18, 1919, 302
 — October 15, 1919, 391
 — November 19, 1919, 393
 Primitosis and Syndiæresis, 366
 Prothallia of *Lycopodium* in America, 54
 Protococcoidea, 170
 Protomarattia, a Few Genus of Marattiaceæ, and Archangiopteris, 164
 Protoplasm and Cell Contents, 234
 Protozoa, Ciliate, from Uruguay, 49
 — (Fauna Groenlandica), 272
 — of Manila, 46
Protula meilhaci, 352
 Prowazek, S. V., Races of *Colpidium colpoda*, 259
Ptergyandrum filiforme (Timm) Hodw.,
 Vegetative Increase of, 165
 Psilotaceæ, Gametophyte Generation of the, 54
 Psilotum, Gametophyte of, 54
 Pteris, 269
 — *sulcata* L., Apospory in, 161
Pterygophora californica, Age of, 61
Puccinia Corteyi Ran, New Species of Rust, 282
 — on *Carduaceæ*, 64
 — Parasitism of, 179
 — *subnitens* and its Æcial Hosts, 178
 Pulsation, Rhythmic, of Ophiuroids, 150
 Purser, G. L., Brain and Cranial Nerves of Dogfishes, 340
 Pyrenomyces, 281
 Pyrosoma, Taxonomic Study of, 246
Pyxidicula operculata, 258
- Q
- Quantitative Method in Biology, 339
 Quelle, —, the Bacillariaceæ of the Numburg Stream, 375
Quercus, Ray-system of, 52
- R
- Rabaud, E., Colour Adaptation in Spiders, 40
 — Food of a Millipede, 39
 Raff, Janet W., Abnormality in Australian Crayfish, 350
 Ramsbottom, J. K., Narcissus Disease, 185
 Ranoievitch, N., New Species of Rust, *Puccinia Corteyi* Ran, 282
 Ransom, B. H., and W. D. Foster, Life-history of *Ascaris lumbricoides*, 42
 Rasmussen, Andrew T., Blood and Blood Gases in Hibernating Woodchuck, 241
 — Nerve-cells of Woodchuck during Hibernation, 242
 Rat, Diet and Testicular Degeneration in, 234
 — Norway, New Mendelian Variety of, 133
 Rathburn, Annie E., Fungus Flora of Pine Seed-beds, 65
 Rats, Albino, Feeding Sudan to Young, 128
 — — Inbreeding and Body Weight in, 128
 — — — and Fertility in, 128
 — — — and Sex-ratio in, 127
 — — — Effects in, 332
 — — — Estrous Cycle in, 24
 — Underfeeding, 333
 — White, Influence of Gonads in, 233

- Raunklaer, C., Male and Female Plants in Rumex, 161
 — Statistical Investigations on Plant Formations, 52
 Rawlins, F. I. G., 394
 Rea, Carleton, British Mycology, 65
 Reehinger, K., Marine Diatoms from the Pacific, 169
 — Mosses and Ferns from the Pacific, 167
 Record, S. J., Significance of Resinous Tracheids, 159
 — Tier-like Structure of Dicotyledonous Woods, 263
 Red-currant Aphis, 140
 Redfield, Alfred C., Melanophores of Horned Toad, 132
 Reed, H. D., Fenestral Ear Plate in Caudate Amphibia, 28
 Reef-fishes, Colours of, 33
 Reichenow, Ed., Flagellate of Lizard found also in Tick, 365
 Reinking, Otto A., Philippine Economic Plant Diseases, 293
 — — Plant Diseases, 289
 — *Phytophthora Faberi* Maubl., The Cause of Coconut Bud Rot in the Philippines, 287
 Reissner's Fibre, 238
 Renilla, 151
 Report of the Microscope Committee of the British Science Guild, 199
 Reptiles, Heart of, 340
 Retterer, Ed., Cortex of Roots of Teeth, 131
 — Structure and Origin of Dentary Enamel, 131
 Reverdin, L., Accessory Genital Parts in Lepidoptera, 35
 Rhabdites of Turbellaria, 148
 Rhabdocœl, Parasitic, 43
 Rhizopoda, Fresh-water, of Sydney and Lismore, N.S.W., 48
 Rhizopods, British Fresh-water, 157
 Rhoads, Arthur S., *Dalmania vernicosa*, 62
 — and others, Host Relationship of the North American Rusts which attack Conifers, 63
 Rhodophyceæ, 280
 Rhodosporeæ, Relationships within the, 282
 Rhubarb Diseases, 186
 Rhynchelmis, New Species of, 41
 Rhyzoctonia on Lawns and Pastures, 186
 Richardson, R. E., 134
 Richet, Charles, Nutritive Value of Sterilized Food, 139
 Richter, Alkdar, New Schizæa from Borneo (*S. Hallieri*), 269
 Riddle, Oscar, Hereditary Ataxia in Pigeons, 32
 — Identical Female Twins in Pigeons, 23
 Riddle, Oscar, and Carl E. Anderson, Effects of Quinine on Production of Yolk and Albumen, 24
 — and J. Arthur Harris, Blood-fat and Egg-production in Fowls, 24
 — and Victor K. La Mer, Post-mortem Melanin Formation in Eyes of Doves, 25
 Riddle, Lincoln W., American Lichens, 290
 Rioja, Enrique, Polychæta of Northern Coasts of Spain, 146
 Roberts, Elmer, Vestigial Wing in *Drosophila ampelophila*, 249
 Robinson, W., "Black Neck," or Wilt Disease of Asters, 71
 Rochon-Davigneaud, A., Corneal Protection in Crawling Animals, 239
 Rocks of Italian Somaliland, 385
 Rodman, G. H., Fleas, 346
 Roell, J., Sphagna and Mosses of Thüringen, 164
 Rose-blotch Fungus, 72
 Rose Graft Disease, 381
 Rosenbaum, J., Tomato-fruit Rots, 71
 Rosendahl, H. V., Collections of Madagascar Ferns, 162
 — Species and Forms of Equisetum in Sweden, 162
 Rosenhain, W., Copper Alloys, 81
 Ross, Joseph, Mycetozoa of Chingford District, 75
 Rosseter, T. B., 391
 Rostromitschikia, a New Genus of Pyrenomyces, 282
 Rotation, Axial, of Aquatic Microorganisms, 156
 Rotifers, Oxygen and Sex-determination in, 356
 Rubber Disease, 72
 — Plantation, Pink Disease of, 70
 Rumex, Male and Female Plants in, 161
 Rust Fungi, British, 179
 Rusts of North America, 63
 — Polemoniaceæ, 282

S

- Sagartia lucia*, 256
 Sahni, B., Australian Specimen of Clepsydropsis, 267
 Saller, Seaweed as Raw Material for Industry, 174
 Salmon, Scale-reading in, 336
 Salomons, Sir David L., Bart., 391
 Salsidæ, Taxonomic Study of, 245
 Samoan Aleyonarians, Respiration Rates of, 358
 Sand, The Rounding of Grains of, 262
 Sand-dune Fungi, Biology of, 67
 Sargassum, 378

- Scab in Potato Tubers, Treatment of, 72
Scæwala crassifolia, Leaf-Anatomy of, 263
 Scales, Fish, Growth of, 336
 Scammon, R. E., Structure of *Corpus adiposum buccæ*, 30
Scapania curta and its Allies, 374
 Schaeffer, A. A., Excretion Crystals in *Amœba*, 47
 Schilberszky, K., New Moss from the Pleistocene of Keeskemet, Hungary, 270
Schistostega osmundacea, 59
Schizæa Hallieri from Borneo, 269
 Schizophyceæ, 273
 Schmidt, Peter, Anabiosis in Earthworms, 146
 Schmidt, W. J., Neural Plates of Chelouian Carapace, 231
 Schreiner, K. E., Minute Structure of Hagfish-skin, 236
 Schröder, B., *Melosira Bæseana* Rabenh., a Luminous Diatom, 375
 Schuchert, Charles, and others, *Beatricea* not a Gigantic Foraminifer, 260
 Schussnig, B., Adriatic Plankton Bacillariæ, 375
 — New and Rare Chlorophyceæ of the Adriatic, 376
 Scorpions, Whip, Reactions of, 40
 Scott, A., Monthly Occurrence of Pelagic Eggs in Port Erin Bay in 1918, 134
 Scott, George G., Osmotic Pressure of the Blood, 243
 Scourfield, D. J., 189, 303
 Season Cracking, 299
 Sea-Urchins, Hybridization Experiments with, 256
 Seaweed as Raw Material for Industry, 174
 Selachians, Pericardio-peritoneal Canals in, 331
Selaginella rupestris, Allies of, in S.E. United States, 162
Selysina perforans Dub., 48
 Sertularella, New Species of, 153
 Setchell, W. A., Parasites among the Red Algae, 172
 Sex-characters and Sex-glands, 333
 Shann, E. W., Myology of Shoulder-girdle and Pectoral Fin in Fishes, 310
 Shapovalov, M., Is Common Potato Scab Controllable by Rotation of Crops? 382
 — Some Potential Parasites of the Potato Tuber, 71
 Sharples, A., 70
 — Rubber Disease, 72
 Shear, C. L., and others, *Endothia parasitica* and Related Species, 184
 — — Spoilage of Cranberries after Harvest, 185
 Sheather, A. L., New Nematode in Calves, 147
 Sheep Crosses and New Varieties of Wool, 230
 — Embryo, Split Fore brain in, 28
 Shelford, V. E., Reactions of Fishes to H-ions, 33
 Sheppard, E. J., 302
 Shōji, Rinnosuke, Luminescence of *Watasenia scintillans*, 34
 Shull, A. Franklin, Sex Determination in *Hydatina*, 149
Sigillariostrobus, Mazocarpon, or the Structure of, 53
 Silkworm, Intestinal Epithelium of, 138
 Silver Leaf Disease, 71
 — — in Fruit-trees, 186
 — Standard or Sterling, 299
 Sim, T. R., Ferns of South Africa, 372
 Simpson, J. J., Bionomics of Tsetse Flies, 36
 Sittler, Ida, 26
 Skene, M., Acidity of Sphagnum and its Relation to Chalk and Mineral Salts, 164
 Skottsberg, C., 280
 Smith, A. Lorrain, Hyphomycetes and the Rotting of Timber, 64
 — Lichenology in Great Britain, 73
 — Monograph of British Lichens, 73, 389
 — New or Rare Microfungi, 286
 — Relation of Fungi to other Organisms, 69
 — and others, New or Rare British Fungi, 68
 Smith, B., The Chellaston Gypsum Breccia in relation to the Gypsum-Anhydride Deposits of Britain, 385
 Smith, E. A., 129
 — and Harold Turner, Properties of Standard or Sterling Silver, 299
 Smith, Frank, New North American Species of *Haplotaxis*, 42
 — and L. B. Dickey, New Species of *Rhynchelmis*, 41
 Smith, Gilbert Morgan, Cell-Structure and Antospore Formation in *Tetradron minimum*, 59
 Smithsonian African Expedition, 60
 Smolak, T., Silver-leaf Disease, 71
 Smout, J., Etching Media used in Non-ferrous Metallography, 81
 Smuts and Rusts of Utah, 282
 Sondheim, Maria, Feeding in Sun Animal-cule, 258
 Souèges, R., Embryogeny of *Capsella*, 370
 Soulier, A., *Protula neilhaci*, 352
 Southall, James P. C., Mirrors, Prisms and Lenses, 388
 Southwell, T., and B. Prasad, Fish Trematodes, 43
 — — Indian Myxosporidia, 47
 — — Methods of Reproduction in Cestodes, 147
 — — New Parasitic Copepods, 41
 — — Tumours in Climbing Perch, 32

- Spermatogenesis, 141
 — Mitochondrial Changes in, 251
 Spermophile, Ovary of, 23
 Spessard, Earle Augustus, Prothallia of Lycopodium in America, 54
 Sphagna and Mosses of Thüringen, 164
 — their Habitats, Adaptations and Associates, 59
 "Sphagnaceæ *Erziccatæ*," Braithwaite's, 374
 — the Western, 164
 Sphagnum, Acidity of, and Relation to Chalk and Mineral Salts, 164
 Sphingidæ, Pupæ of, 137
 — Wing-markings of, 347
 Spiders, Cavernicolous, 143
 — Colour Adaptation in, 40
Spina bifida in very early Human Embryo, 332
 Spirochæte of Infectious Jaundice in English Rats, 47
 Spirogyra, Abnormal Conjugation in, 171
 — *Weberi*, Cross-conjugation in, 171
Spondylomorun quarternarum, Reversion of Orientation to Light in, 157
 Sponges, Buds in, 45
 — Fresh-water, 154
 — New, from Spain, 45
 Sporangiophoric Lepidophyte from the Carboniferous, 267
 Stäger, Rob., Behaviour of Tiger-beetle Larva, 348
 Standfuss, R., Male Genital Apparatus in Lepidoptera, 35
 Stark, Mary B., Hereditary Tumour, 231
 Steel, High-speed Manufacture and Working of, 386
 — Mechanical Properties of, 385
 — Rifle-barrel, 299
 Steels, High-speed Tool, Molecular Constitutions of, 386
Stegomyia fasciata, Somatic Mitosis of, 346
 Steil, W. N., Apogamy in *Niphradium hirtipes* Hook, 268
 — Apospory in *Pteris sulcata* L., 161
 — Method of Staining Antherozoid of Fern, 372
 — New Cases of Apogamy in Ferns, 56
 Stein, E. R., jun., 139
 Stephenson, T. A., Irish Actinaria, 151
 Sterigmatocystis Smut of Figs, 70
 Sterilized Food, Nutritive Value of, 139
 Stevens, Frank Lincoln, Illinois Rhubarb Diseases, 186
 — and Nora Dalby, Parasite of the Tree-fern (*Cyathea*), 379
 — — Some *Phyllachoras* from Porto Rico, 281
 Stevens, Neil E., and R. B. Wilcox, Rhizopus Rot of Strawberries, 175
 Stewart, Chester A., Underfeeding Rats, 333
 Sticklebacks and Mud-minnows, Colour-discrimination in, 240
 Stigeoclonium Kütz, Green Algæ from, 170
 Stiles, M. H., Diatom Flora of Martin Beck, Yorks, 168
 Stockard, Charles R., and George N. Papanicolaou, Effect of Alcohol on Guinea-pigs, 128
 Stokey, Alma G., Apogamy in the Cyathaceæ, 371
 Stone, R. E., Incubation Period of *Cronartium rubicola* on the White Pine, 63
 Stone-fly, Oocytes of, 38
 Stopes, M. C., Four Visible Ingredients in Banded Bituminous Coal, 385
 Strachan, James, On the Chemistry of Dendritic Growths in Paper, 193, 225
 Strawberries, Rhizopus Rot of, 175
 Streeter, G. L., Formation of *Filum terminale*, 29
 — — of Single-ovum Twins, 329
 Streptothrix, 283
Stromatopteris moniliformis Mett., 56
Stropharia epimyces, 282
 Strutt, R. J., Scattering of Light by Solid Substances, 388
 — The Light scattered by Gases: its Polarization and Intensity, 76
 Sumner, F. B., Superfætation in Mice, 230
 — and H. H. Collins, Autotomy in Pocket Mice, 31
 Surbeck, G., Fauna of Ritom Lake, 339
 Swezy, Olive, 360
 Swim-bladder, Function of, 341
 Swingle, W. W., Effects of Iodine on Tadpoles, 229
 — Influence of Iodine on Thyroid Gland of Tadpoles, 229
 Swinnerton, H. II., Facial Suture of Trilobites, 34
 Symbiosis, New Theory of, 236
Synchytrium endobioticum, Life-history and Cytology of, 281
 Szymanski, J. S., So-called Hynopsis in Cockroach, 250

T

- Tænitidinæ, 162
 Tænitis, 162
 Tachibana, K., 297
 Tadpoles, Effects of Iodine on, 229
 — Experiments on, 31
 — Minute Structure of Membranous Labyrinth of, 334
 Tadpole's Tail, Vital Staining of, 29
 Takenouchi, Matsuziro, Resistance of Red Blood Corpuscles to Hypotonic Salt Solutions, 339
 Tanaka, Tyôzaborô, New Japanese Fungi, 68, 182

- Tannery Fungus, 69
Tanymastix lacunæ Guérin, 40
 Taphrina Species, Scandinavian, 177
 Tapeworms of Vertebrates, 354
 Taxineæ, Interrelationships of the, 160
 Taylor, G., The Manufacture of Files, 385
 Teeth, Cortex of Roots of, 131
 Temperature, High, Death from, 242
 Teodoro, G., *Lecanium persicæ* and its Symbiotic Yeasts, 348
 Termite, New Ceylonese, 38
 Termites, Wings and Trachæ of, 140
 Termitoxenia, 39
 Terry, R. J., Development of Cat's Skull, 27
 Testacella, Germinal Nurse-cells of, 136
 Thecosomatous Pteropods, 342
 Thelephoraceæ of North America, 283
 Thirkell, G. L., 299
 Thompson, John MacLean, *Platyzoma microphyllum* R.Br., 55
 — *Stromatopteris moniliformis* Mett., 56
 Thomson, Arthur, Maturation of Human Ovum, 329
 Thomson, J. Stuart, *Cavernularia lütkenii*, 257
Thuja gigantea, Destructive Disease of Seedling Trees of, 382
 Thuringer, J. M., Dicephalic Pig, 28
 Tiger-beetle Larva, Behaviour of, 348
 Tiger-moth, Luminescence in, 347
 Tisdale, W. H., Physoderma Disease of Corn, 281
 Toad, Horned, Melanophores of, 132
 Toda, Y., Studies on *Schistostega osmundacea*, 59
 Tomato-fruit Rots, 71
 Tosaka Nori, Japanese Seaweed, 280
 Toughness, Static, Dynamic and Notch, 82
 Tracheids, Resinous, Significance of, 159
Trachelomonas inconstans: a New Flagellate, 272
 Transverse Fissures, New Light on, 82
 Tree-fern (*Cyathea*), Parasite of the, 379
 Tree-Frog, Two Unusual Blood Vessels in, 340
 Trematodes and Cestodes, Cuticula and Sub-cuticula of, 44
 — Fish, 43
 Trichodrilus, North American Representative of, 42
Trichogramma evanescens, Segregation of Germ-cells in, 343
 Trihomitus, New Species of, 365
 Trichonympha, New Species of, 363
 Trichonymphid, New, 364
 Trigf, A. van, Fresh-water Sponges, 154
 Trilobites, Facial Suture of, 34
 Tropical Diseases in the Balkanic Zone, 209
 Trout, Division of Melanophores of, 132
 — Monstrous, Symmetry Reversal and Mirror-imaging in, 232
 Trypanosomiasis of Camels, 47
 Tsetse Flies, Bionomics of, 36
 Tsuji, Hiroshi, and Karagoro Tachibana, Antiseptic Treatment of Wounds, 297
Tubaria furfuracea, 283
 Tube Length, a Method of Adjusting, 119
 Tubularia, Metabolic Gradient in, 256
 Tumour, Hereditary, 231
 Turbellaria, Rhabdites of, 148
 Turconi, Malusio, and Luigi Maffei, Parasitic Microfungi, 184
 Turner, Harold, 299
 Twins, Single-ovum, Formation of, 329
- U
- Ultimobranchial Bodies in Fig. 26
 Ultra-microscopic Particles, 335
 Ultra-violet Spectra, with a Vacuum Grating Spectrograph, 384
 Undulating Marginal Cilia in a Green Flagellate, 168
 Upogebia, 352
 Urcelay, Inan Cuesta, Anatomy of the Leaf of *Lactuca saligna* Linn., 368
 Uredinales, Spore Germination in, 380
 Uredineæ, 63
 — Experiments with, 178
 — New Species of, 179
 Ureters, Double, in Pig and Man, 28
Uroleptus mobilis, Nuclei of, 259
- V
- Van Bemmelen, J. F., Wing-markings of Sphingidæ, 347
 Van der Bijl, P. A., Diseases of Carnations, 73
 Vance, H. W., Structure of Clasmatoocytes, 237
Vanessa antiopi, Effect of Light on, 35
 Vanlx, R. de La, Gynandromorph Daphnids, 40
 "Vega" Expedition, 166
 Vincens, F., Character of Taxonomic Value in Xylariaceæ, 176
 — Organogenic Researches on Hypocreales, 176
 Vogel, Irwin H., Rose Graft Disease, 381
 Voinov, D., Mitochondrial Changes in Spermatogenesis, 251
 — Spermatogenesis of Gryllotalpa, 251
 Volvox and Pandorina, Orientation in, 260
 Von Dankenschweil, H. W., Anatomy of Mosses, 373
 Vuillemin, Paul, New Brown Aspergillus, *Eurolium verruculosum*, 175
 — Notes on Mortierella, 175

W

- Wade, H. W., 283
- Wager, Harold, Fluorescent Colouring Matter from *Leptonia incana*, 286
- Wailles, G. H., British Fresh-water Rhizopods, 157
- Wakefield, E. M., 282
- Biology of Sand-dune Fungi, 67
- Diseases of Yams, 71
- New British Fungi, 286
- and A. A. Pearson, Fungus from Weybridge, 67
- — Fungi Exotici: xxiv., 68
- — Resupinate Hymenomyces from the Weybridge District, 283
- Wakefield, M., British Mycology: the Selby Foray, 285
- Walker, Leva B., Development of *Pluteus admirabilis* and *Tubaria furfuracea*, 283
- Walter, W., 271
- Walter, C., Water-mites from Peru and Brazil, 143
- Walton, L. B., Axial Rotation of Aquatic Micro-organisms, 156, 167
- *Eutetramorus globosus*: a New Genus and Species of Algæ belonging to the Protozoocoeidea (Family Cœlstridæ), 169
- Warnstorff, C., Vegetative Increase of *Pterogynandrum filiforme* (Timm) Hedw., 165
- Warren, Ernest, Pigment of Hydroids, 152
- Structure of New South African Hydroid, 153
- Watasenia scintillans*, Luminescence of, 34
- Water-mites from Peru and Brazil, 143
- Waterman, T. T., Evolution of the Chin, 244
- Watson, Hugh, *Hygromia limbata* (Drap.), 343
- Watson, W., Bryophytes and Lichens of Calcareous Soil, 74
- Lichens of Sand-dunes, 74
- Sphagna, their Habitats, Adaptations and Associates, 59
- Webb, Gladys E., Development of Species of Upogebia, 352
- Weir, James R., Introduction of Wood-destroying Fungi, 182
- and E. E. Hubert, *Melampsora* Cultures, 64
- Weiss, J. E., Effect of Weather on the Attacks of Parasitic Fungi, 66
- Wells, F. M., 338
- Wenrich, D. H., Individuality of Chromosomes, with Special Reference to Synaptic Phase, 349
- West, Erdman, Undescribed Timber Decay of Hemlock, 380
- Wharton, L. D., Nematode Parasite of Chicken, 42
- Wheeler, W. M., Australian Ants of Genus *Onychomyrmex*, 36
- Wheldon, J. A., Braithwaite's "*Sphagnaceæ Essiccatae*," 374
- White, Gertrude Marean, Colour-discrimination in Sticklebacks and Mudminnows, 240
- Whiteley, J. H., and A. F. Hallimond, The Acid Hearth and Slag, 385
- Whiting, P. W., Mediterranean Flour-moth, 347
- and Helen Dean King, New Mendelian Variety of Norway Rat, 133
- Whitney, David D., Oxygen and Sex-determination in Rotifers, 356
- Wileox, R. B., 175
- Williams, Maud, Absorption of Gold by Fungi, 69
- Williams, R. S., Genus *Desmatodon* in North America, 271
- Williamson, H. Chas., Dentigerous Cyst on Cod's Upper Jaw, 244
- Wilson, Malcolm, British Rust Fungi, 179
- Wiltshire, S. P., Infection and Immunity, 69
- Wine-yeast, Effect of Salts on, 67
- Witte, Lucille, Development of Heart-muscle of Pig, 338
- Wolfe, J. J., Alternation and Parthenogenesis in *Padina*, 278
- Wolffian Body of Pig, Development of, 27
- Wollman, E., Development of Maggots in Sterilized Tissue, 139
- Wood of Trees, Regional Spread of Moisture in, 266
- Woodchuck, Hibernating, Blood and Nerve Cells of, 241
- Wood-vessels, Detailed Structure of, 367
- Woods Hole Laboratory, 170
- Woodward, Avalyn E., Egg Secretion in Echinoderms, 149
- Wormald, H., Blossom Wilt and Canker of Apple-trees, 73
- "Brown-rot" Disease of Fruit-trees: with Special Reference to two Biologic Forms of *Monilia cinerea*, 287
- "Wither Tip" of Plum-trees, 73
- Wortley, E. J., Potato Leaf-roll, 72
- Wounds, Anti-septic Treatment of, 297

X

- Xylaria, 184
- Xylariaceæ, Taxonomic Value in, 175

Y

- Yabe, H., Carpenteria-Limestone from B. N. Borneo, 61
 Yakimoff, W. L., and others, Trypanosomiasis of Camels, 47
 Yams, Diseases of, 71
 Yeasts and Insects, 349
 Yerbury, J. W., Seashore Diptera, 346
 Yeri, M., and T. Kabaruki, Japanese Polyclads, 255
 Yolk-sac of Pig, Histogenesis of Blood-platelets in, 29

Z

- Zalueta, A. de, Promitosis and Syndiæresis: two Methods of Nuclear Division co-existing in Amœbæ of the "Limax" Group, 366
 Zilva, S. S., and F. M. Wells, Changes in the Teeth of the Guinea-Pig produced by Scorbutic Diet, 338
 Zinssmeister, C. L., Root-rots of Ginseng, 70
Zygosaccharomyces Nadsonii sp. n., 176

MBL WHOI LIBRARY



WH 18WP T

