

B. E. STECHBART





From the collection of the

o P^zreⁿL^minger^a
v Library
t p

San Francisco, California
2007

JOURNAL
OF THE SOCIETY OF
MOTION PICTURE ENGINEERS

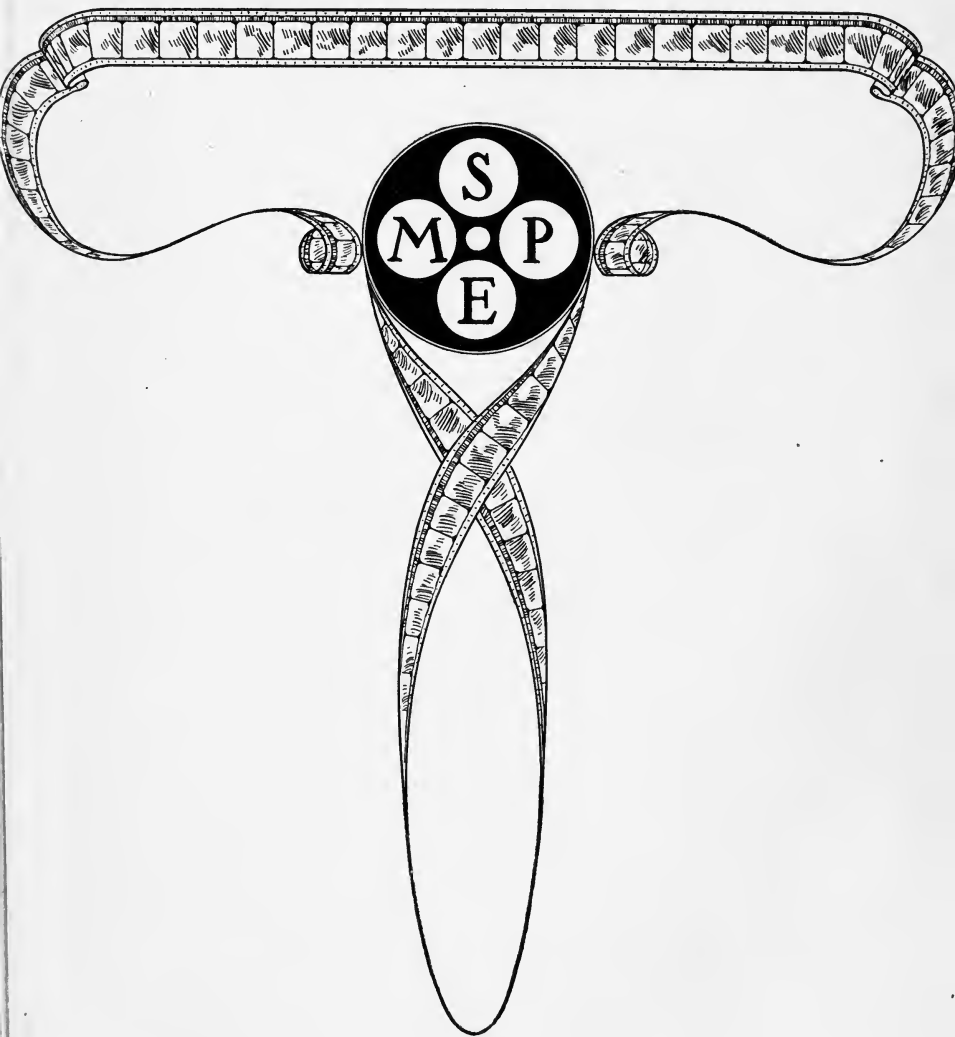

INDEX VOLUME XIV

Digitized by the Internet Archive
in 2007 with funding from
Microsoft Corporation

CLASSIFIED INDEX, VOL. XIV

Absorption, Optical. (See OBJECTIVES.)

Absorption of Sound. (See ACOUSTICS.)

Acoustics, Studios.

Acoustic Control of Recording for Talking Motion Pictures, J. P. MAXFIELD,
p. 85.

Acoustics, Theaters.

Some New Aspects of Reverberation, EDWARD W. KELLOGG, p. 96.

Theater Acoustics for Sound Reproduction, S. K. WOLF, p. 151.

Apertures.

Camera and Projector Apertures in Relation to Sound-on-Film Pictures, LESTER
COWAN, p. 108.

The Aperture Effect, ELLSWORTH D. COOK, p. 650.

Arcs, Projection.

Characteristics of High Intensity Arcs, D. B. JOY and A. C. DOWNES, p. 291.

Arcs, Studio. (See ILLUMINATION IN PHOTOGRAPHY.)

Artistic Considerations.

Rectangle Proportions in Pictorial Composition, LOYD A. JONES, p. 32.

Art and Science in Sound Film Production, JOE W. COFFMAN, p. 172.

Blooming Patches. (See SPLICING.)

Camera Accessories.

Film Numbering Device for Cameras and Recorders, M. W. PALMER, p. 327.

Cameras and Camera Mechanisms.

Camera and Projector Apertures in Relation to Sound-on-Film Pictures,
LESTER COWAN, p. 108.

Camera Mechanism, Ancient and Modern, ARTHUR S. NEWMAN, p. 534.

Committee Reports.

Report of Standards and Nomenclature Committee, October, 1929, p. 122.

Progress in the Motion Picture Industry. Report of the Progress Committee,
p. 222.

Theater Lighting, Report of Theater Lighting Committee, November, 1929,
p. 441.

Report of Projection Committee, October, 1929, p. 444.

Annual Report of the Treasurer of the Society, p. 578.

Development of Motion Picture Film.

A Quick Test for Determining the Degree of Exhaustion of Developers, MERLE
L. DUNDON, G. H. BROWN, and J. G. CAPSTAFF, p. 389.

Electrical Machinery and Equipment.

Elimination of Commutator Ripple from Direct Current Generators, O. K.
BUCK and J. C. ALBERT, p. 399.

Filters, Electrical. (See ELECTRICAL MACHINERY AND EQUIPMENT.)

Fixing of Motion Picture Film.

A Method of Testing for the Presence of Sodium Thiosulfate in Motion Picture Films, J. I. CRABTREE and J. F. ROSS, p. 419.

Some Properties of Chrome Alum Stop Baths and Fixing Baths, J. I. CRABTREE and H. D. RUSSELL, Part I, p. 483; Part II, p. 667.

General.

A Milestone, p. 2.

Our New Journal, p. 7.

The Sound Film Situation in Europe, N. D. GOLDEN, p. 11.

The Human Equation in Sound Picture Production, TERRY RAMSAYE, p. 219.

A Year of Sound, HAROLD B. FRANKLIN, p. 302.

The Academy of Motion Picture Arts and Sciences and Its Service as a Forum for the Industry, FRANK WOODS, p. 436.

Historical.

The Early History of Wide Films, CARL LOUIS GREGORY, p. 27.

Camera Mechanism, Ancient and Modern, ARTHUR S. NEWMAN, p. 534.

Home Motion Picture Equipment. (See SIXTEEN MILLIMETER EQUIPMENT.)

Illumination in Photography. (See also INCANDESCENT LAMPS—PHOTOMETRY.)

Radiation Characteristics of Two Mercury Arcs, FRANK BENFORD, p. 404.

Illumination, Projectors. (See PROJECTION.)

Illumination, Theaters. (See also PHOTOMETRY.)

Theater Lighting, Report of Lighting Committee, November, 1929, p. 441.

Incandescent Lamps for Photography.

Water Cooling of Incandescent Lamps, N. T. GORDON, p. 332.

Loud Speakers.

Loud Speakers for Use in Theaters, D. G. BLATTNER and L. BOSTWICK, p. 161.

Loud Speakers and Theater Sound Reproduction, LOUIS MALTER, p. 611.

Lubrication of Motion Picture Film.

The Surface Treatment of Sound Film, J. I. CRABTREE, OTTO SANDVIK, and C. E. IVES, p. 275.

Mazda Lamps and Lighting. (See INCANDESCENT LAMPS.)

Mechanical Accessories.

Flexible Drive Shafts—Their Application to Sound Pictures, J. C. SMACK, p. 384.

Medical Photography.

Sound Films for Surgical Instruction, P. E. TRUESDALE, p. 513.

Miniatures. (See also TRICK PHOTOGRAPHY.)

Dimensional Analysis as an Aid to Miniature Cinematography, C. F. HUTCHINS, p. 377.

Narrow Width Film. (See SIXTEEN MILLIMETER EQUIPMENT.)

News Reel.

The Modern News Reel, HARRY W. JONES, p. 204.

Objectives.

Measuring the Effective Illumination of Photographic Objectives, J. HRDLICKA, p. 531.

Optics. (See also OBJECTIVES.)

The Optical Problems of Wide Film Motion Pictures, W. B. RAYTON, p. 50.

The Optics of Motion Picture Projectors, ARTHUR C. HARDY, p. 309.

Perforation.

Film Perforation and Its Measurement, WALTER H. CARSON, p. 209.

Photometry.

A Light Intensity Meter, J. L. MCCOY, p. 357.

Printers.

Curved Gates in Optical Printers, WILLIAM S. VAUGHN and FORDYCE TUTTLE, p. 663.

Processing of Film. (See DEVELOPMENT—FIXING—LUBRICATION.)**Progress.**

Progress in the Motion Picture Industry, Report of the Progress Committee, October, 1929, p. 222.

Projection, General Information.

Camera and Projector Apertures in Relation to Sound-on-Film Pictures, LESTER COWAN, p. 108.

The Optics of Motion Picture Projectors, ARTHUR C. HARDY, p. 309.

Report of Projection Committee, p. 444.

Projectors, Continuous.

Apparatus Developed to Simplify Manufacture of Lens Wheels for Continuous Projectors, ARTHUR J. HOLMAN, p. 623.

Projectors, Special Type. (See SIXTEEN MILLIMETER EQUIPMENT.)**Secretary, Reports.**

Report of the Secretary, October, 1928, to October, 1929, p. 466.

Sensitometry, Methods and Instruments.

Photographic Characteristics of Sound Recording Film, LOYD A. JONES and OTTO SANDVIK, p. 180.

A Quick Test for Determining the Degree of Exhaustion of Developers, MERLE L. DUNDON, G. H. BROWN, and J. G. CAPSTAFF, p. 389.

Sixteen Millimeter Equipment.

A New Sixteen Millimeter Motion Picture Camera, JOSEPH A. DUBRAY, p. 427.

Sound Reproduction, Disk.

A New Synchronizing Apparatus for 16 Mm. Films with Disk Records, WM. H. BRISTOL, p. 361.

Sound Reproduction, General Information Concerning.

Photographic Characteristics of Sound Recording Film, LOYD A. JONES and OTTO SANVIK, p. 180.

Multiple Exposure Cinematography in Sound Pictures, WILLIAM STULL, p. 318.

The Illusion of Sound and Picture, JOHN L. CASS, p. 323.

A New Method of Blocking Out Splices in Sound Film, J. I. CRABTREE and C. E. IVES, p. 349.

Some Aspects of a Western Electric Sound Recording System, S. S. A. WATKINS and C. H. FETTER, p. 520.

The Aperture Effect, ELLSWORTH D. COOK, p. 650.

Sound Reproduction by Variable Width.

The Photographic Treatment of Variable Area Sound Films, J. A. MAURER, p. 636.

Sound Studio Equipment.

Some Aspects of a Western Electric Sound Recording System, S. S. A. WATKINS and C. H. FETTER, p. 520.

Splicing.

A New Method of Blocking Out Splices in Sound Film, J. I. CRABTREE and C. E. IVES, p. 349.

Spot Lights. (See ARCS, PROJECTION.)

Standardization.

Some Practical Aspects of and Recommendations on Wide Film Standards, A. S. HOWELL and J. A. DUBRAY, p. 59.

Standards and Nomenclature.

Report of Standards and Nomenclature Committee, October, 1929, p. 122.

Standards Adopted by the Society of Motion Picture Engineers, p. 545.

Studio Equipment. (See ELECTRICAL MACHINERY AND EQUIPMENT—ILLUMINATION IN PHOTOGRAPHY—SOUND REPRODUCTION.)

Studio Lighting. (See ILLUMINATION IN PHOTOGRAPHY.)

Synchronization.

A New Synchronizing Apparatus for 16 Mm. Films with Disk Records, WM. H. BRISTOL, p. 361.

Television and Telephonic Transmission of Pictures.

The Development of Television and Radiomovies to Date, C. FRANCIS JENKINS, p. 344.

Theater Design and Equipment. (See ACOUSTICS, THEATERS—ILLUMINATION, THEATERS.)

Theater Lighting. (See ILLUMINATION, THEATERS.)

Treasurer's Report.

Annual Report of the Treasurer of the Society of Motion Picture Engineers, September, 1928, to October, 1929, p. 578.

Trick Photography. (See also MINIATURES.)

Multiple Exposure Cinematography in Sound Pictures, WILLIAM STULL, p. 318.

Tungsten Lamps. (See INCANDESCENT LAMPS.)

Waxing. (See LUBRICATION.)

Wide Pictures.

The Early History of Wide Films, CARL LOUIS GREGORY, p. 27.

Rectangle Proportions in Pictorial Composition, LOYD A. JONES, p. 32.

The Optical Problems of Wide Film Motion Pictures, W. B. RAYTON, p. 50.

Some Practical Aspects and Recommendations on Wide Film Standards. A. S. HOWELL and J. A. DUBRAY, p. 59.

AUTHOR INDEX, VOLUME XIV

ALBERT, J. C. (and O. K. BUCK)	Elimination of Commutator Ripple from Direct Current Generators	399
BENFORD, FRANK	Radiation Characteristics of Two Mercury Arcs	404
BLATTNER, D. G. (and L. G. BOSTWICK)	Loud Speakers for Use in Theaters	161
BOSTWICK, L. G. (and D. G. BLATTNER)	Loud Speakers for Use in Theaters	161
BRISTOL, WM. H.	A New Synchronizing Apparatus for 16 Mm. Films with Disk Records	361
BROWN, G. H. (and MERLE L. DUN- DON and J. G. CAP- STAFF)	A Quick Test for Determining the Degree of Exhaustion of Developers	389
BUCK, O. K. (and J. C. ALBERT)	Elimination of Commutator Ripple from Direct Current Generators	399
CAPSTAFF, J. G. (and MERLE L. DUN- DON and G. H. BROWN)	A Quick Test for Determining the Degree of Exhaustion of Developers	389
CARSON, WALTER H.	Film Perforation and Its Measurement	209
CASS, JOHN L.	The Illusion of Sound and Picture	323
COFFMAN, JOE W.	Art and Science in Sound Film Production	172
COOK, ELLSWORTH D.	The Aperture Effect	650
COWAN, LESTER	Camera and Projector Apertures in Re- lation to Sound-on-Film Pictures	108
CRABTREE, J. I. (and C. E. IVES)	A New Method of Blocking Out Splices in Sound Film	349
(and J. F. ROSS)	A Method of Testing for the Presence of Sodium Thiosulfate in Motion Picture Films	419
(and OTTO SANDVIK and C. E. IVES)	The Surface Treatment of Sound Film	275
(and H. D. RUSSELL)	Some Properties of Chrome Alum Stop Baths and Fixing Baths, Part I	483
DOWNES, A. C. (and D. B. JOY)	Part II	667
DUBRAY, J. A.	Characteristics of High Intensity Arcs	291
(and A. S. HOWELL)	A New Sixteen Millimeter Motion Picture Camera	427
	Some Practical Aspects of and Recommen- dations on Wide Film Standards	59

DUNDON, MERLE L. (and G. H. BROWN and J. G. CAPSTAFF)	A Quick Test for Determining the Degree of Exhaustion of Developers	389
FETTER, C. H. (and S. S. A. WATKINS)	Some Aspects of a Western Electric Sound Recording System	520
FRANKLIN, HAROLD B.	A Year of Sound	302
GOLDEN, N. D.	The Sound Film Situation in Europe	11
GORDON, N. T.	Water Cooling of Incandescent Lamps	332
GREGORY, CARL LOUIS	The Early History of Wide Films	27
HARDY, ARTHUR C.	The Optics of Motion Picture Projectors	309
HOLMAN, ARTHUR J.	Apparatus Developed to Simplify Manu- facture of Lens Wheels for Continuous Projectors	623
HOWELL, A. S. (and J. A. DUBRAY)	Some Practical Aspects of and Recommen- dations on Wide Film Standards	59
HRDLICKA, J.	Measuring the Effective Illumination of Photographic Objectives	531
HUTCHINS, G. F.	Dimensional Analysis as an Aid to Minia- ture Cinematography	377
IVES, C. E. (and J. I. CRABTREE)	A New Method of Blocking Out Splices in Sound Film	349
(and J. I. CRABTREE and OTTO SANDVIK)	The Surface Treatment of Sound Film	275
JENKINS, C. FRANCIS	The Development of Television and Radio- movies to Date	344
JONES, HARRY W.	The Modern News Reel	204
JONES, LOYD A. (and OTTO SANDVIK)	Rectangle Proportions in Pictorial Compo- sition	32
JOY, D. B. (and A. C. DOWNES)	Photographic Characteristics of Sound Re- cording Film	180
KELLOGG, EDWARD W.	Characteristics of High Intensity Arcs	291
MALTER, LOUIS	Some New Aspects of Reverberation	96
MAURER, J. A.	Loudspeakers and Theater Sound Repro- duction	611
MAXFIELD, J. P.	The Photographic Treatment of Variable Area Sound Films	636
MCCOY, J. L.	Acoustic Control of Recording for Talking Motion Pictures	85
NEWMAN, ARTHUR S.	A Light Intensity Meter	357
PALMER, M. W.	Camera Mechanism, Ancient and Modern	534
RAMSAYE, TERRY	Film Numbering Device for Cameras and Recorders	327
RAYTON, W. B.	The Human Equation in Sound Picture Production	219
ROSS, J. F.	The Optical Problems of Wide Film Motion Pictures	50
	A Method of Testing for the Presence of	

(and J. I. CRABTREE)	Sodium Thiosulfate in Motion Picture Films	419
RUSSELL, H. D. (and J. I. CRABTREE)	Some Properties of Chrome Alum Stop Baths and Fixing Baths, Part I	483
	Part II	667
SANDVIK, OTTO (and J. I. CRABTREE and C. E. IVES) (and LOYD A. JONES)	The Surface Treatment of Sound Film	275
	Photographic Characteristics of Sound Recording Film	180
SMACK, J. C.	Flexible Drive Shafts—Their Application to Sound Pictures	384
STULL, WILLIAM	Multiple Exposure Cinematography in Sound Pictures	318
TRUESDALE, P. E.	Sound Films for Surgical Instruction	513
TUTTLE, FORDYCE (and WM. S. VAUGHN)	Curved Gates in Optical Printers	663
VAUGHN, WM. S. (and FORDYCE TUTTLE)	Curved Gates in Optical Printers	663
WATKINS, S. S. A. (and C. H. FETTER)	Some Aspects of a Western Electric Sound Recording System	520
WOLF, S. K.	Theater Acoustics for Sound Reproduction	151
WOODS, FRANK	The Academy of Motion Picture Arts and Sciences and Its Service as a Forum for the Industry	436

JOURNAL

OF THE SOCIETY OF

MOTION PICTURE ENGINEERS

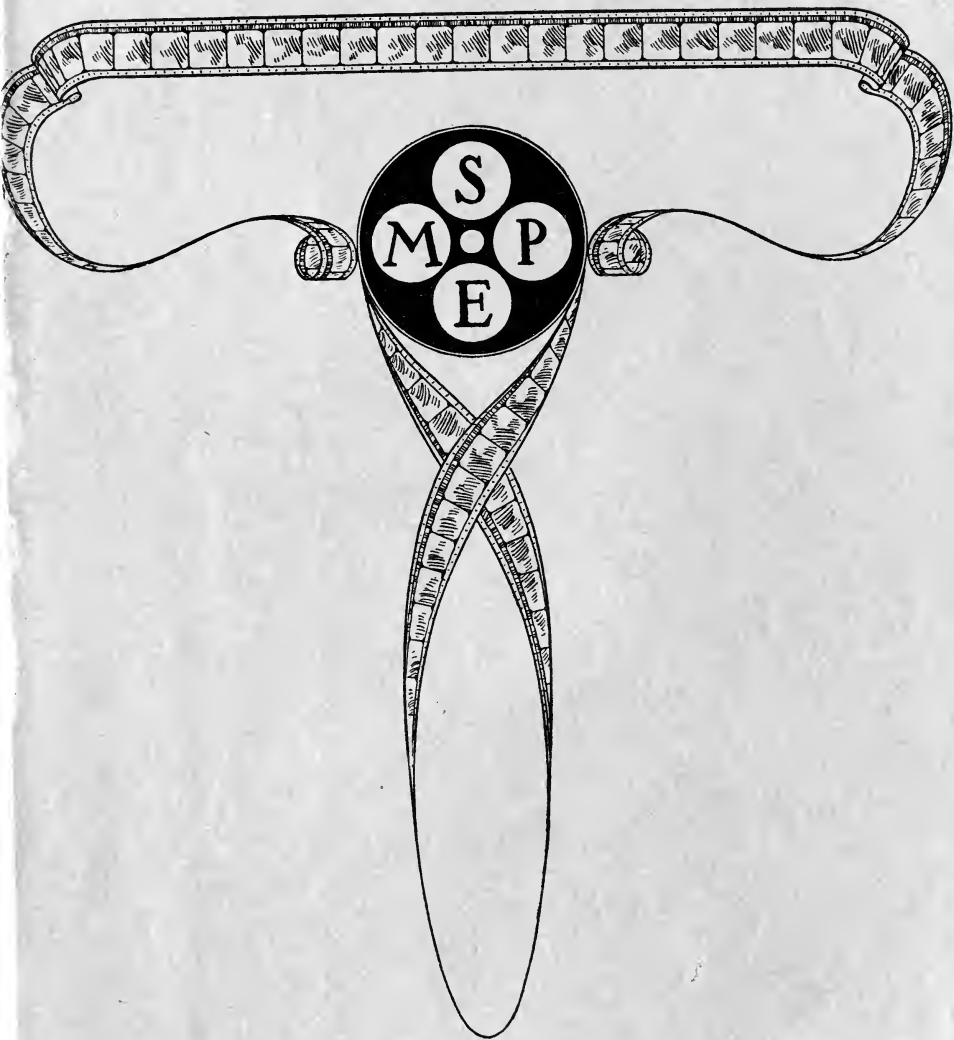

JANUARY, 1930

B. E. STECHERT

PUBLISHED MONTHLY, AT EASTON, PA., BY THE SOCIETY OF MOTION PICTURE ENGINEERS

The Society of Motion Picture Engineers

Its Aims and Accomplishments

The Society was founded in 1916, its purpose as expressed in its constitution being, "advancement in the theory and practice of motion picture engineering and the allied arts and sciences, the standardization of the mechanisms and practices employed therein, and the maintenance of a high professional standing among its members."

The Society is composed of the best technical experts in the various research laboratories and other engineering branches of the industry in the country, as well as executives in the manufacturing and producing ends of the business. The commercial interests also are represented by associate membership in the Society.

The Society holds two conventions a year, one in the spring and one in the fall, the meetings being generally of four days' duration each, and being held at various places. At these meetings papers are presented and discussed on all phases of the industry, theoretical, technical, and practical. Demonstrations of new equipment and methods are often given. A wide range of subjects is covered, and many of the authors are the highest authorities in their distinctive lines.

Papers presented at conventions, together with discussions, contributed articles, translations and reprints, abstracts and abridgements, and other material of interest to the motion picture engineer are published in the *Journal of the Society*.

The publications of the Society constitute the most complete existing technical library for the motion picture industry.

4036

JOURNAL OF THE SOCIETY OF MOTION PICTURE ENGINEERS

LOYD A. JONES, EDITOR *pro tem.*

Associate Editors

G. L. CHANIER
O. M. GLUNT
A. C. HARDY

P. MOLE
W. B. RAYTON
P. E. SABINE

S. E. SHEPPARD
J. L. SPENCE
L. T. TROLAND

Volume XIV

JANUARY, 1930

Number 1

CONTENTS

	Page
A Milestone.....	J. I. CRABTREE 3
Our New Journal.....	LOYD A. JONES 7
The Sound Film Situation in Europe.....	N. D. GOLDEN 11
Early History of Motion Picture Cameras for Film Wider than 35 mm.....	CARL LOUIS GREGORY 27
Rectangle Proportions in Pictorial Composition..	LOYD A. JONES 32
The Optical Problems of Wide Film Motion Pictures.....	W. B. RAYTON 50
Some Practical Aspects of and Recommendations on Wide Film Standards.....	A. S. HOWELL AND J. A. DUBRAY 59
Acoustic Control of Recording for Talking Motion Pictures....	J. P. MAXFIELD 85
Some New Aspects of Reverberation....	EDWARD W. KELLOGG 96
Camera and Projector Apertures in Relation to Sound-on-Film Pictures.....	LESTER COWAN 108
Report of Standards and Nomenclature Committee.....	122
Abstracts.....	138
Book Reviews.....	142
Officers.....	144
Committees.....	145

Published Monthly by the
SOCIETY OF MOTION PICTURE ENGINEERS
20th & Northampton Sts., Easton, Pa.
Editorial Office: 343 State St., Rochester, N. Y.

Subscription to non-members \$12.00 per year, single copies \$1.50. Order from the Secretary of the Society of Motion Picture Engineers, 5th & Sussex Streets, Harrison, N. J.

Copyright
BY THE SOCIETY OF
MOTION PICTURE ENGINEERS

PERMANENT MAILING ADDRESS OF THE SOCIETY

Engineering Societies Building
29 West 39th Street
New York, N. Y.

Papers or abstracts may be reprinted if credit is given to the Journal of the Society of Motion Picture Engineers.

The Society is not responsible for statements made by authors.

Application pending for entry as second-class matter at the Post Office at Easton, Pa.

A MILESTONE

The Society of Motion Picture Engineers was founded in the year 1916 by Mr. C. Francis Jenkins for the purpose, as expressed in the Constitution, of "advancement in the theory and practice of motion picture engineering and the allied arts and sciences, the standardization of the mechanisms and practices employed therein, and the dissemination of scientific knowledge by publication." From its inception, the activities of the Society, including the proceedings at the semi-annual conventions, have been recorded in the *Transactions*. The initial amount of published scientific data was of very modest dimensions, in 1920 the size of the *Transactions* had increased to 240 pages; in 1924 to 508 pages; in 1927 to 768 pages; and in 1928 to 1200 pages. Up to this period, the engineer had been regarded by many motion picture executives as a being very much apart from the industry and, in fact, one of the outstanding executives admitted at a banquet tendered by the Academy of Motion Picture Arts and Sciences to the Society in Hollywood in 1928, that previous to that occasion he had not even heard of the Society of Motion Picture Engineers.

The engineers had been working diligently, however, and in 1927 presented to the industry a new medium for expression, namely, sound, which when wedded to the silent motion picture gave birth to a new art form which, if it has not already done so, is destined to overshadow the stage, the novel, and the short story.

Although it is little more than a year ago that the first all-talking picture was exhibited before the Society, since that time the entire industry has been revolutionized. Old studios have been replaced by those having the desired acoustical properties and have been equipped with expensive recording apparatus, while in the theater old projectors have been scrapped for the newer sound reproducing equipment and the "operators" of a few years ago have been replaced by projection engineers upon whose technical knowledge and skill the excellence of the theater entertainment now largely depends.

It is also encouraging to note that the motion picture technician has at last been given the spotlight and is receiving some of the recognition which he deserves. The motion picture producers, most

of whom are now also exhibitors, fully realize that the future success of their business lies to a great extent in the hands of the technician and are welcoming advice from scientific societies and the various universities.

The Society of Motion Picture Engineers has contributed in no small way to the successful accomplishment of this transition. Our *Transactions* have contained the first published accounts of the various systems of sound recording and reproducing. These papers and the accompanying discussions have not only been a means of educating the motion picture technician but have served as a stimulus for new ideas.

With this new order of events, the Board of Governors of the Society realized that by retaining the existing method of publication, the Society would not be rendering a maximum service to the industry. In many cases, the *Transactions* have not been issued until four or five months after the conventions and, owing to the fact that the "transactions" of a society are, strictly speaking, a record of the proceedings at the society's meetings, it has not been possible to publish the many valuable technical papers and articles which have appeared from time to time in the foreign press and other scientific journals at home. Valuable technical information is being recorded by the Deutsche Kinotechnische Gesellschaft in the *Kinotechnik*, by the Société Française de Photographie in the bulletin of the society, and by the Royal Photographic Society in their journal.

It has long been the dream of the Board of Governors to publish a monthly journal and this dream has finally been realized in this the first issue of the JOURNAL OF THE SOCIETY OF MOTION PICTURE ENGINEERS. The planning of this was largely a result of the efforts of the Journal Committee under the chairmanship of Past President L. A. Jones, whose report is presented elsewhere in this issue. Mr. Jones has also consented to act as temporary editor until a permanent editor is appointed. The editor will be assisted by a Board of Associate Editors but the general policy of the JOURNAL will be determined by the Journal Committee which, in turn, is responsible to the Board of Governors. By means of this new mouthpiece, a minimum of time will elapse before the technical papers presented at the conventions are available, while the reader will be kept more closely in touch with progress in the motion picture engineering field both at home and abroad. Moreover, since the JOURNAL is

available to non-members at a very nominal sum, the scientific information which it contains will be more widely distributed among the many technical workers in the industry. Although the make-up of this, the initial issue, is very much along the lines of the *Transactions*, bigger and better Journals are in store.

An important matter upon which the success of the JOURNAL will largely depend is the securing of the necessary income to provide a permanent editor who will also act as assistant secretary and treasurer with permanent headquarters in New York City. To date, the routine work attached to the various offices such as Secretary, Treasurer, Chairman of Publications Committee, *etc.*, has been a labor of love and the burden has been valiantly carried by a few loyal individuals and firms. In order to give the various firms and corporations an opportunity to share the expense of carrying on the routine business of the Society and the publication of the JOURNAL, the Board of Governors has established three classes of sustaining memberships, the subscriptions for which are \$1000, \$500, and \$100. The various companies will be approached by the chairman of the Solicitations Committee, Mr. E. P. Curtis, and I urge every member to use his influence to prevail upon his company to take up one or more sustaining memberships.

The motion picture engineer has a Herculean task to perform for the future. The quality of sound reproduction must be improved if the sound motion picture is to maintain its hold on the public as an entertainment medium. The scope for technical advance in the field of color motion picture photography is almost unlimited. For the immediate future, the definition or sharpness of color motion pictures must be made at least equal to that of the black and white picture if the public is to remain interested. Also, few of the many problems in connection with the enlarged motion picture screen are as yet solved. Will a wide film be ultimately necessary for the successful showing of a large screen picture? This question can only be answered by extensive research. Moreover, to date, no truly stereoscopic motion pictures have been projected without the use either of auxiliary devices by the observer or of apparatus too complicated to be practical. The three-dimensional picture will probably not emanate from one man's brain but will be the result of a combination of effort on the part of many workers.

The new JOURNAL OF THE SOCIETY OF MOTION PICTURE ENGINEERS is destined to play a very important part in the solution of these and

other problems if only by virtue of the resulting stimulation of ideas among its readers and the greater facilities which it will provide for coöperative effort. Its publication represents an important milestone in the progress of the Society.

J. I. CRABTREE, *President*

OUR MONTHLY JOURNAL

At various times during the past six or eight years it has been suggested that the Society of Motion Picture Engineers should publish a monthly journal in lieu of its semi-annual or quarterly *Transactions*. The Board of Governors has discussed this proposal from time to time but not until recently has it seemed wise to commit the Society to an undertaking involving the necessarily increased financial burden. Within the last year or so, however, the membership has increased to such an extent that the Society's income is appreciably enhanced. About a year ago, President Porter appointed a committee to consider the desirability and feasibility of the Society undertaking the publication of a monthly journal. The committee was instructed to report its findings to the Board of Governors in order that that body might take some definite action on this subject. The personnel of the committee appointed was as follows: Messrs. P. M. Abbott, J. W. Coffman, W. B. Cook, W. C. Hubbard, P. A. McGuire, H. T. Cowling, and L. A. Jones, *Chairman*.

After making an analysis of the expense involved in the publication of a monthly journal, the Society's present and probable future income, the desirable results to be obtained by the publication of a monthly journal instead of its present quarterly *Transactions*, and of methods which might be adopted for providing the required increase in the Society's annual income, this committee prepared a report, with definite recommendations, which was presented to the Board of Governors at their meeting during the Toronto convention, October 7 to 10, 1929. This report was given careful consideration by the Board of Governors and the recommendations made by the Journal Committee were accepted, with slight modifications. These final recommendations are as follows:

1. That the Society undertake the publication of a monthly journal beginning January, 1930. It is understood that this journal will replace the present *Transactions*.
2. That the name of the journal be

THE JOURNAL
of the
SOCIETY OF MOTION PICTURE ENGINEERS

3. That the size of the journal be the same as that of our present *Transactions*, namely, 6 inches by 9 inches.

4. That the type of journal be strictly scientific or technical, carrying only articles of the highest scientific, technical, and engineering quality, and that it shall be kept free from semi-popular, commercial, trade, and advertising types of articles.

5. That the contents shall consist in general of the following categories of material:

(a) Papers read and discussed at the semi-annual meetings of the parent society which have received the approval of the Chairman of the Papers Committee.

(b) Papers read at meetings of the local sections which have received the approval of the authorized individual or body.

(c) Other papers offered for publication which have received the approval of the authorized individual or body.

(d) Reprints of papers of special value and interest, these to be selected by the editorial management from both domestic and foreign sources, including probably translations of the outstanding contributions from foreign countries. These papers are to be approved by the authorized individual or body.

(e) Abstracts of current scientific literature of direct interest to the motion picture engineers.

(f) Book reviews of current publications of interest in this field.

(g) Selected patent notes (possibly).

(h) Society business, committee reports, notices of meetings, etc.

6. That editorial services be obtained to take charge of the work involved in the publication of this journal.

7. That a class of Sustaining Memberships be established to provide the required additional income.

The present issue, No. 1, Vol. XIV, January, 1930, of the JOURNAL OF THE SOCIETY OF MOTION PICTURE ENGINEERS is the direct result of the Board of Governors' acceptance of these recommendations and of its subsequent action in setting up the machinery for the publication of this JOURNAL. The recommendations of the committee contain in condensed form fairly complete information as to the style and character of the JOURNAL, of which this is the first issue. However, it may not be out of place at this time to enlarge somewhat upon these rather concise and formal statements in order that the membership as a whole may have a more definite conception of the ideals which exist in the minds of the Board of Governors as to the future quality and character of this publication.

While the *Transactions* of the Society as they have appeared during the past fifteen years have served admirably as a medium for the publication of papers presented at our semi-annual conven-

tion, there is little doubt that the great majority of members will agree that the decision to publish a monthly journal represents a distinct step forward in the growth and evolution of our organization. It seems quite certain that a publication reaching the membership at regular monthly intervals will be more valuable and will better serve to keep alive the interests of the members of the Society in its welfare than issues of *Transactions* appearing at more or less irregular intervals. It should be remembered also that so long as our publications were appearing under the title *Transactions*, we could not logically include in these publications any papers which were not presented, or business which was not transacted at one of our semi-annual meetings. A monthly journal suffers no such limitation. The subject matter which can be brought to the attention of Society members and non-member subscribers through such a medium is at once increased in its scope. We feel, therefore, that the JOURNAL when fully developed will be of immensely greater value and interest.

There has been considerable discussion relative to the most desirable size in which to publish this new JOURNAL. The final decision to adopt the dimensions 6 inches by 9 inches was reached from a consideration of two factors. Our old *Transactions* were of this size and doubtless many members have preserved these in the form of bound volumes. Future volumes of the JOURNAL can therefore be bound uniformly with the *Transactions* and thus retain continuity of external appearance. Moreover, by far the greater number of purely technical and scientific journals appear in sizes of approximately these dimensions. It seemed to the committee, therefore, that the publication of the JOURNAL in this size will tend to identify it as a purely technical journal and to set it apart, in physical appearance, from the more commercial or trade journal type of publications.

The fourth item of the committee's recommendations is a general statement as to the type of subject matter to be published. The committee and the Board of Governors are unanimous in agreeing that every effort must be made to keep the JOURNAL on the highest possible technical plane. The Society of Motion Picture Engineers has, during the past years, earned the respect and esteem of the motion picture industry largely through the high quality of its *Transactions* and its freedom from any taint of commercialism. Our new JOURNAL must be in harmony with this reputation, for this

reputation is one of our most valuable assets and must be safeguarded at all costs.

In the fifth item of the recommendations an attempt has been made to outline the content of this JOURNAL. These statements seem to be adequate and need no further explanation.

We cannot, of course, expect this JOURNAL to appear fully grown and developed in its initial issues. It will take considerable time and a great deal of hard work on the part of the editorial staff to bring it into a fully developed form. Moreover, it probably will not be found advisable to fix rigidly the relative proportion of the various types of material in each issue. For instance, it may be desirable in the issues appearing simultaneously with and soon after each of our semi-annual conventions to devote by far the largest percentage of space to the publication of convention papers. As this source of material is exhausted more space can be given in subsequent issues to contributed material, translations of foreign papers, abstracts, book reviews, *etc.* This problem of proportioning space to the various departments, which it is hoped will become regular features of the JOURNAL, is one which will have to be worked out as time goes on.

It will be noted that the seventh item relates to the provision of additional income to meet the financial burden of publishing the monthly JOURNAL. The Board of Governors at the present time is giving this matter attention. The outcome of the effort to increase the income of the Society will determine whether it will be feasible to secure part-time or full-time editorial services for the JOURNAL. In the meantime the Chairman of the Journal Committee has agreed to act as editor *pro tem.* Every effort will be made to publish this JOURNAL in a manner creditable to the Society. Suggestions, advice, and constructive criticism will be welcomed.

LOYD A. JONES, Chairman of Journal Committee,
Editor *pro tem.*

SOUND MOTION PICTURES IN EUROPE

NATHAN D. GOLDEN*

In selecting this subject I may be taking many of you over familiar territory. Nevertheless I have chosen "Sound Motion Pictures in Europe," because I regard it as the outstanding problem confronting American exporters of motion pictures today.

The advent of sound pictures has given rise to many conjectures as to how American made sound and talking pictures are being received in foreign countries, how the talkie will affect our export markets, and how the language problems abroad will be solved. An attempt to answer these questions is the purpose of this paper. Before going into that phase of the subject, however, it might be well to give you an idea of our exports for the first six months of 1929 and the corresponding period for 1928.

During the first six months' period for 1929, exports of American motion pictures to all countries amounted to over 121,000,000 linear feet as compared to 112,000,000 linear feet in 1928. This increase of over 9,000,000 linear feet of American motion pictures indicates pretty fairly that sound or talking pictures have not curtailed our exports in this commodity, at least not up to the present time.

My first observation is that Europe still remains our most important market and offers the greatest potentialities for sound and dialog films, dependent, of course, upon the rapidity of sound installations. Such installations have not been made as commonly as might have been expected, owing to the fact that European theater owners are confronted with the financial burden necessary for installing the required apparatus. Relief along this line seems to be approaching, with the recent announcement by certain large American electric companies of a smaller apparatus and facilities for the financing of it. This smaller apparatus, comparable with the best makes in Europe, will serve well in the smaller theaters which literally dot Europe.

With approximately 27,000 theaters in Europe seating about

* Assistant Chief Motion Picture Division, Bureau of Foreign and Domestic Commerce.

12,000,000 people, only 19 have a seating capacity of over 3000; 23 seat from 2500 to 3000; only 84 have from 2000 to 2500 seats; 267 have a seating capacity from 1500 to 2000, and 1250 from 1000 to 1500 seats each. There are more than 18,000 theaters with less than 500 seats each. A good proportion of these barely qualify as motion picture theaters. The average cinema capacity in Europe is less than 480.

Let us now discuss briefly sound film conditions in the more important European markets, beginning with Germany where the more technical aspects of sound film production have received more attention than in the others.

GERMAN SOUND FILM PRODUCTION

The first German sound film appeared in Germany seven years ago as an experiment. Three years ago, the Tri-Ergon system was much spoken of, but owing to lack of German capital its company was compelled to exploit the patents in Switzerland.

Only in 1928, spurred by the increasing success of American sound film activities, did Germany turn to furthering, organizing, and financing its domestic sound film industry. The Tonbild-Syndikat A. G. (Tobis) was then established.

The Tonbild-Syndikat was later joined by a number of smaller companies holding various sound patents; then the leading German electric concerns, A. E. G. and Siemens-Halske, which had worked out a number of useful processes and had even produced some experimental pictures, entered into action. Together with Polyphon-Werke A. G., they founded the Klangfilm G. m. b. H. After several months of competition and patent war, Tobis and Klangfilm joined their interests, Klangfilm dealing with the production and sale of reproduction apparatus under the patent of A. E. G. and Siemens, and Tobis producing recording apparatus under its own patents, of which it possesses about 500, and awarding licenses for the production of sound pictures. It has already signed a contract to this effect with Ufa, and is preparing to exploit the same licenses in other German speaking countries.

Agreement between Klangfilm and Ufa.—The German sound film production was actually started April 8, 1929, when an important contract was signed between Klangfilm and Ufa. Under this contract Klangfilm-Tobis is to furnish recording equipment for four large sound studios, which are being built by Ufa in Neubabelsberg, Berlin.

Ufa is now producing its first sound film in the Klangfilm studios, and it is planning to release 22 talkies during the 1929-30 season, under the Klangfilm system. It seems that the wiring of theaters is keeping pace with production, for by May 1, 30 German theaters were equipped with Tobis apparatus. The present monthly output of Klangfilm is said to amount to 20 such installations, and it is expected that this output will later reach 80 monthly.

Latest prices announced in Germany for Klangfilm-Tobis sound apparatus for theaters run from approximately \$3200 to \$15,000, according to the size of the installation.

German Theaters Suitable for Installation of Sound Equipment.—Of the 5200 German motion picture theaters, only a few are large enough to install sound equipment at the present time. It may be roughly estimated that 193 theaters with seating capacities over 1000 and approximately 700 theaters with seating capacities from 500 to 1000 offer an early market for reproducing apparatus.

One American company had installed its apparatus in five Berlin theaters, but a permanent injunction handed down against it forced the withdrawal of this apparatus and of the company in question from the German market. However, negotiations are in progress between German and American electrical concerns to bring about a combine which will end all patent suits of the parties concerned.

German feature film production has slumped badly in recent months. This is due to the German inability, so far, to turn out sound films, and the native industry's fear of producing too many silent films. Exhibit demand is irregular, and spot-booking is sought more now than formerly, since cinema owners are afraid to contract too far in advance for silent production. Feature imports are also necessarily lower than last year because of the "*kontingent*" limitations. But while some slump was due in view of the sound film departure, a general depression was in no way expected.

Sound Film Production in Germany during 1928-29.—During the year from July 1, 1928, to June 30, 1929, the German sound film industry produced and submitted to censorship 75 short sound pictures totaling 17,814 meters in length, making the average length of each sound picture about 235 meters, which comprised short speeches, musical scenes, and similar sound experiments. During the same period two foreign sound features and three shorts were censored in Germany.

The production industry is at present in a state of defense against

any foreign talkie invasion. The producer is today faced with lack of capital—and because of the talkies, the possibility of marketing German films abroad, especially in England and America, has almost collapsed.

German producers are losing no time, however, in solving the language problem. One producer in coöperation with an English company, is now producing a bi-lingual talkie in England.

Censorship of Sound Pictures.—Much space is devoted by the German press to the question of sound film censorship in so far as sound shorts are concerned. Sound features are subject to contingent regulations and are treated as silent films. A number of American sound shorts have already been brought on the German market without any import restrictions. One American company, however, has recently registered 20 more short sound pictures to be imported into Germany; but since the Foreign Trade Committee claims that the existing regulations do not include provisions for sound shorts, it has refused to grant an import permit for them.

At present there is under consideration by the German government a proposal to establish a special contingent for talking pictures. The proposal is drastic. It will allow the importation of only one foreign talkie to every German talkie shown. Moreover, the Reichsrat, the governing committee representing the German States, has recently adopted new amendments to the German cinema law. Although these amendments are contrary to the ruling of German courts, they subject all dialog of sound film to censorship.

All pictures disparaging Germany abroad will be banned for exhibition, even if the German censors have passed the picture after deleting the objectionable scenes.

It is not likely that all the new rules will become law, for they will have to be considered by the Reichstag in about four to five months' time.

Italian Interests in German Sound Films.—It is extremely interesting to follow the international aspect of the German sound film industry. It appears that Ufa's first sound pictures will be synchronized musical films, intended for world distribution. As a matter of fact, by a sound film agreement between Ufa and the Italian Ente Nazionale per la Cinematografia, the latter's product will be released in Germany and exhibited in all theaters equipped with Klangfilm apparatus. On the other hand, the Ente Nazionale is reported to have acquired the entire Ufa sound production for 1929-30, with

a view to showing these pictures in properly equipped Italian theaters.

Relations with Other Countries.—The German industry has a double tie-up with Great Britain; the British Union Corporation, Ltd., has an important share in the Polyphon Werke A. G., which is one of the founders of the Klangfilm, and the British Photophone, Ltd., has a financial interest in the Tobis. There is, moreover, a German coalition with Russia. In fact, a contract is said to have been concluded in April between the German Prometheus A. G., the British Photophone, and the Russian Meschrappon-Film, for joint production and distribution of sound pictures, and the sale of German and British sound apparatus for Russian theaters.

For the exploitation in other countries, a company is now being established in the Netherlands by Dutch financial companies with Tobis reported to be having a 25 per cent share in the capital and profits.

German sound film interests were furthered recently with the creation of the International Talking Screen Production, Ltd., a registered British company which acquired the entire capital of the Filmwerke Staaken A. G. (German) and Derussa (German-Russian), and 51 per cent of an American company.

These German sound film developments and international tie-ups show the German industry still to be in a rapidly evolving stage, but there does exist a possibility of such a well organized and efficiently conducted program as to overcome the present difficulties in the film industry, and to acquire a domination of the Continental sound film market.

GREAT BRITAIN

In proportion to the number of theaters, sound motion pictures in this country are progressing as rapidly as in the United States. It is estimated that there are over 4000 theaters in Great Britain, of which 680 have a seating capacity over 1000 and 2231 with seating capacity ranging between 500 and 1000.

At the present time there are about 400 sound reproducing installations in the theaters of Great Britain. While this figure is small as compared with the 6000 or more installations in the United States, other theaters are being equipped as rapidly as the apparatus can be received in Great Britain.

The advent of sound pictures has brought about a situation in the quota system, unlooked for at the time of its framing. It is understood that there is a movement afoot in Great Britain to repeal the Film Act, the promulgation of which, 18 months ago, led to the

formation of a number of British film companies with the object of producing a large part of Great Britain's requirements. Had the trade developed along expected lines, the formation of these companies would have been justified, and the British industry would have been in a thriving condition. But nobody dreamed that in the short space of twelve months the demand for pictures would be reduced from 700 features to 300 or 400 per year. The leading theaters in the country have gone in for the talkies almost exclusively, and the silent picture is fast disappearing from the British market.

Producers in Great Britain are losing no time in reorganizing their studios and reshaping their production schedules to cope with a situation similar to the one that existed in the United States 18 months ago, when all the producers began laying plans for the production of sound pictures on a large scale. At the British International Studios, at Elstree, there are ten pictures in production. First International Pictures, a newly formed company, also has under production its first sound picture. Gainsborough Pictures, Nettlefold, and various other companies have sound feature films under actual production. The Blattner sound system, which operates differently from all others, the sound being recorded on a metal tape, is to be used by Max Rhinehart in all his feature stage shows. Rhinehart intends to include scenes in sound and color film in these productions, the first of which is now in the process of production. A new company has recently been formed to turn silent films into synchronized form, probably with dialog. This firm has secured a studio within easy reach of London, for which a complete American recording apparatus has been ordered. A large number of British and other films which are now being offered as silent features, will thus be available in sound and talking form.

Production of talking pictures in several languages is taking on large proportions. British press reports indicate that at the Twickenham Studios ambitious plans for the making of two 100 per cent talking pictures will shortly be under way. They will be made in English, French, and German, the English version by an English director, the French by a French director, and the German by a well known German. Another press report informs us of the extensive plans of another producer for the creation of an international talkie studio, which is to have twenty stages, to be built near London with the latest devices and manned by the best technicians that Great Britain and the world can supply. It is the plan of this multi-lingual

film center to produce the English version of the picture with the the continental producers present, with whom arrangements for co-operation are to be made. When the English version is completed the first of these producers will bring over his native stars and make the talking version for that country. He in turn will be followed by another continental producer, and so on. In this way talkies for France, Italy, Spain, Sweden, and other continental nations will be made. By using the same story, sets, costumes, *etc.*, and with each of these continental producers paying his share of the expenditure, it is felt that the cost of production of the first version will be from 30 to 40 per cent lower than for a picture made for Great Britain and Empire distribution only; and at the same time the continental versions will have been produced at correspondingly lower costs.

Sound Equipment.—The number of British sound reproducing apparatuses at present on the market are too numerous to mention. Several of them have proven their interchangeability with American sound pictures, but opinion of those in the trade is that they do not have the quality of tonal reproduction credited to our American devices. Prices for the various English made synchronizers range anywhere from 195 to 3000 pounds.

FRANCE

The development of sound film in France has been at a standstill owing to the protracted delay in settling the regulations for the administration of the French Film Control Decree for the film release season 1929–30. Coupled with the decision of American distributors to withhold contracts for the 1929–30 product in view of the uncertainty of the number of films which could be imported into the country under the terms of the new French film regulations, the leading American sound film equipment manufacturers, last March, ceased making contracts for the delivery of either recording systems or reproducing apparatus.

Demand for Sound Picture Apparatus.—The fundamental demand expressed by the theater goes themselves has already forced three of the Boulevard first-run theaters to install sound equipment. Concerning the potential demand for this equipment, however, it is safe to predict that it will be several years before there will be as many sound installations in France as there are in the United States at present, in proportion to the population or to the number of theaters. The majority of French exhibitors are either too conserva-

tive to try out this invention before their public advises them to do so, or else the investment looks larger to them than it really is.

As regards the potentiality of reproducing equipment sales, it is believed by those well versed in French film circles that the wiring of a great many houses other than the so-called first-runs, will depend upon the supply of French dialog films. Foreign talkies, either in part or full, or the sound synchronized films, will not induce the owners of these neighborhood and small town cinemas to invest in expensive house wiring. Exhibition leaders in France are outspoken in their claims that the provincial cinema going public generally will not tolerate the substitution of synchronized sound for orchestral music; nor will they be expected to absorb foreign dialog films. American super productions, however, with short dialog sequences and box office names, and those strictly sound synchronized in manufacture, will continue for a long while to attract capacity audiences in French first-runs. At the present time there are about ten theaters in France wired for showing sound pictures, and it is estimated that there are close to 350 theaters in France with a seating capacity over 1000, and 1300 theaters with a capacity from 500 to 1000 which are potential talkie houses.

Sound Studios.—There are at present but two French studios equipped to record sound films. These are the Menchen studio at Epinay, just outside Paris, which is controlled by Les Films Sonores Tobis, the French subsidiary of the Tonbild Syndikat of Germany (Tobis); and the Gaumont studio in Paris.

Although it is said that plans are under way to equip for sound film purposes the studios at Billancourt and at Neuilly, immediately adjacent to Paris, the information is not authentic.

Recording Processes in France.—While no American recording equipments have been delivered in France to date, it is felt certain that, with the settlement of the French film controversy and the resumption of trade activities of American interests, several orders for recording equipment will be placed with American companies.

The only equipment announced as available for purchase in France is Tobis-Klangfilm. This recording apparatus is installed at the Menchen studio, but so far nothing from this studio has been exhibited. The Petersen-Poulsen system, a Scandinavian invention, which is being fostered in France by the Gaumont Company, has been used more extensively for short films. One feature is also known to have been released. In this system, sound is recorded on

a second film, similar to that of British Acoustics. The results have not been satisfactory, according to the trade, and little hope is held that the system will be much in favor. The Cinevox process is being sponsored by a well known French producer and distributor, but little is said about this system, except that it is for sound on the film. It should offer no real competition for American outfits.

In view of the unsatisfactory credit conditions in film circles, and the heavy demands made on sales of recording equipments, it is probable that only the few larger producers will be able to contract for the expensive American installations. So far as the numerous smaller producers are concerned, they will be obliged either to rent space in equipped studios or to confine their activities to silent film production as in the past.

Reproducing Equipment.—Several American companies and representatives of Tobis, Petersen-Poulsen, Cinevox, and Melovox are in the French market for sales of reproduction equipment. The Thomson-Houston Company is advertising a non-synchronous reproduction device. Companies selling the Boma apparatus, Ampliphonaubert, Survox, Erkaphototone, and Synchronphone are reported to be in the formative stage.

ITALY

Sound and talking movies have been introduced into this market, and, with the exception of the language difficulties, have been well received. Italy with more than 2000 theaters, 155 of which have a seating capacity of 750, should offer a very fertile field for American sound installations.

Production.—Production in Italy is limited. The Ente Nazionale, a concern aided by the government, and the Pittaluga Company are the chief producers. The Ente, which has adopted British talking picture apparatus, has already taken the exterior sets of their first Italian talking picture. The making of this film has aroused considerable interest in Italy, since it marks the government's entry into a new field. Of all Italian producers, Pittaluga has announced the most ambitious production schedule. Six features with sound are scheduled, and twenty-six shorts are under contemplation.

The progress that has been made in the United States in the development of sound pictures has prompted various persons in the moving picture industry in Italy to consider the possibility of utilizing them for the production of Italian grand opera. In the making of

the silent picture, Italy has had little success but sound pictures should offer Italy an opportunity in this regard.

AUSTRIA

The prospects for sound films in Austria are not very promising, owing to the number of small theaters. There are but 19 theaters with a seating capacity over 750, and 53 with seating capacities between 500 and 750, which may lend themselves to sound installations. But it is estimated that even the five largest cinemas in Austria could not afford to pay more than \$2000 to \$4000 for complete sound equipment and installation.

No cinema in Austria has yet been wired for sound films, but it is planned to equip a small theater in Vienna at an early date. The Filmtone Ges. claims that it has Austrian patents on a sound film system similar to an American system which can be fitted to any type of apparatus with practically no difficulty or loss of time. The Marconi-Gefra system was recently presented in Vienna; the prices of this device range from \$1500 to \$4000.

Austrian interest in sound films has increased enormously within the past few months. Already one company, Astra Film A. G. near Vienna, has begun the manufacture of sound films on an American system, using the disk method. Another company, Filmtone Ges. I. G., has recently been formed and production is expected to start during the next twelve months. Back of the Filmtone Ges. I. G. are Gefra, the leading radio concern of Vienna, and the Marconi people. Reproduction sets are at present made by Astra Film A. G., while Gefra, which is interested in Filmtone Ges. I. G., claims that it is already making recording apparatus.

HUNGARY

Hungary has approximately 450 motion picture houses, 93 of which are located in Budapest. Only five houses in the entire country are capable of accommodating over 750 people, the average seating capacity being about 300. Plans are under way in Budapest to equip the three largest theaters in that city with reproduction sets. With the exception of the Ufa theater, which will have a Tobis installation, the others will be wired with American equipment.

With the scarcity of large houses, the prevailing limitations for the immediate installation of sound equipment in Hungary are very evident. Important as this feature may be it is not the only obstacle in the way of sound pictures in Hungary. The Hungarian

language is the only one spoken in this country, and this, quite naturally, would eliminate talking pictures unless produced in the native tongue. Sound accompanied pictures may find a market in Hungary after installations are made in theaters with reproducing apparatus, and leaders in the Hungarian industry feel that sound synchronized pictures will prove popular.

At the present time none of the Hungarian studios are equipped for the production of sound films; neither has Hungary manufactured any type of recording or reproduction apparatus. Owing to the scarcity of capital, it is doubtful whether the necessary funds could be obtained at this time to acquire or manufacture recording apparatus in Hungary.

SPAIN

The development of sound motion pictures for the present is not very promising in Spain. English speaking films will naturally be barred because they would not be understood by the Spaniards. But synchronized pictures, such as those reproducing musical scores and sound effects, will have a future in this country. It is suggested that as theaters in Spanish speaking countries are adapted to sound films, there might be an opportunity for Spanish producers to supply Spanish speaking films to those markets.

Equipment now offered in Spain is considered to be expensive, running as high as \$18,000; it is felt by those in the trade that if these prices were brought down within reach of the Spanish exhibitors, there would probably be room for five installations in Madrid this year, three in Barcelona, with a possibility of one each in Bilgao, Zaragoza, Valencia, and Seville.

Spain, with more than 2000 theaters, has nearly 300 with a seating capacity of over 1000; 600 seating from 750 to 1000; and 450 with a seating capacity of from 500 to 750, which should lend themselves to sound reproduction installations. So far only one theater is wired for the reproduction of sound films, but two others will be wired in the near future.

None of the Spanish studios are as yet equipped for the recording of sound pictures, and no such apparatus has been manufactured in Spain.

CZECHOSLOVAKIA

At present five motion picture theaters in Czechoslovakia, representing a total seating capacity of 4500, are equipped with sound

reproduction sets. All of these are in Prague. Two of these theaters have American apparatus, two have German "Klangfilm" equipment, and the fifth has installed a Dutch reproduction set. There are some 40 theaters in this country seating over 750, and 368 theaters seating from 500 to 750, which could be wired for sound pictures.

The distribution of talking films will be very limited, since the Czechoslovak theater goers will come two or three times out of curiosity to see and hear a talking film whose language they do not understand, but are unlikely to attend regularly. German dialog pictures might find a fair distribution in the territory close to the German and Austrian frontiers inhabited by German speaking people, provided theater owners equip their houses with reproducing equipment.

It seems improbable that dialog films could be produced in this country under present circumstances, since domestic production of motion pictures suffers from lack of capital and will not be able to afford the purchase of expensive recording apparatus. In addition, the domestic market is rather small, and there are no export possibilities for Czech talkies.

The sound film proper has better prospects, according to leaders in the industry. It is reported that motion picture producers of Czechoslovakia contemplate making sound films with the coöperation of foreign producers, whose sound recording studios could be used for this purpose. The Elekta Film Company is now taking Czech sound pictures in a studio in Vienna for a film which is partly sound synchronized.

Czechoslovakian film distributors are rather skeptical as to the lucrativeness of the distribution of sound films in their country, maintaining that the expensiveness of the reproducing equipment will permit only a limited number of theaters to install the necessary apparatus. Thus the circulation of sound films will be very restricted and their price very high.

POLAND

No theaters as yet have been wired for the reproduction of sound films in Poland. The situation is causing considerable perplexity among cinema owners. They have been experiencing poor business for the past six months and are reported to be in a very poor financial state. Their ability to go into the sound film field, therefore, depends chiefly on the willingness of the banks or other financiers to aid in the

wiring of their theaters. If this financial backing can be secured, probably fifty cinema owners in the large cities of Poland may arrange for the installation of sound reproducing apparatus when they can satisfy themselves as to how the Polish public will accept sound pictures in a foreign tongue.

SWEDEN

According to reports sound motion pictures have met with the approval of the Swedish cinema goer, and several additional theaters will be wired in the near future. Sound pictures have been shown in Stockholm since May 2, 1929, and the attendance has been unusually high. While there is considerable adverse criticism regarding the talking picture, there are strong indications, at least in Stockholm, that the public prefers the sound film to the silent. Talkies have been limited to a few short length news reels with the exception of one American feature. However, a great number of features have been shown using sound effects, music, and singing.

It is estimated that there are about 1500 motion picture theaters throughout Sweden, 25 of which have a seating capacity over 750, but at present there are only 7 theaters in Sweden equipped for showing sound pictures, 6 of which are located in Stockholm and the other in Malmo. Six of these installations are of American manufacture, while the other one is the invention of a Swedish engineer. The prospects for the sale of sound equipment in Sweden depends, to a large extent, on the initial cost and whether or not the apparatus can be used with both American and European sound films.

Production.—Sound pictures have not yet been produced in Sweden but it is reported that the Svensk Film Industri of Stockholm intends to produce two sound pictures during the current year. Neither recording nor reproducing sets have been manufactured in Sweden. The German Klangfilm sound reproducing equipment is being installed in one theater in Stockholm and in another in Gothenburg. The Svensk Film Industri is contemplating using this system in a number of theaters which it operates.

DENMARK

Denmark has only 270 theaters, thirty of which have a seating capacity over 500, so it is evident that sound installations will be comparatively limited. A few of the larger theaters have already been wired, and it is understood that apparatus will be installed in several more of the leading theaters later in the year. Leaders in

the motion picture industry in Copenhagen feel that immediate prospects for the general sound development are very good.

The old company, "Nordisk Film," has completely discontinued operations, because of heavy competition with American and German made pictures. A new company, "Nordisk Tone-Film," has now been organized. It has been producing one reel sound pictures, running not more than from five to eight minutes in length and composed chiefly of singing or short talks, the cast consisting entirely of local artists.

The recording process now in use is the Petersen-Poulsen system of Danish make. This system differs greatly from that of the American recording process, the picture being made on one film and the sound on another, but they are so arranged that the result is perfect synchronization. With the present apparatus it would be impossible to use sound films of any other process, owing to the fact that two separate sets of apparatus are required. This device is the only type of recording apparatus and reproduction set used in the Danish motion picture industry.

The Nordisk Tone-Film company is in close contact with British Acoustic, Ltd., and the strong Gaumont company of France, and in this way keeps in touch with the trend of the trade and the types of pictures demanded by the public.

NORWAY

At present there are no studios equipped for sound film production in Norway. Neither is there any local manufacture of reproduction sets or recording apparatus. There are approximately 10 theaters in Norway having a seating capacity over 750 and 20 others ranging in seating capacity between 500 and 750, which should lend themselves to wiring for sound pictures.

In Oslo the theaters are owned and operated by the Commune. One independent theater outside the city with a large modern building seating 2000 has been in negotiation with an American company for the installation of sound film equipment. The Commune has also been in touch with the same company for the wiring of its theaters. In addition, one other downtown Oslo theater is expected to be wired in the near future. If sound films prove popular, three or four other installations may follow soon after. The larger houses in Bergen, Trondhjem, and Stavanger will also undoubtedly be interested in the new development.

It may therefore be said that the immediate prospects for sound film development in Norway are very good, and once the equipment is installed, sound films should be as popular in Norway as anywhere else.

SWITZERLAND

At the present time, three theaters in Switzerland have been wired for sound pictures, all three installations being American reproducing units. It is felt that at the end of this year the larger Swiss cities, with the exception of Berne, will have at least one theater each equipped to handle talkies. Out of total of 300 motion picture theaters in Switzerland, 25 have a seating capacity over 750. These theaters are potential purchasers of sound equipment.

This country has no moving picture industry, except for very small concerns, each turning out a few reels per year. Thus, practically all films must be imported. At present, all silent films are provided with subtitles in two languages, either French and German, or French and Italian. Possibly the greatest handicap for sound pictures is the very heavy expense involved in the original installation. The Swiss cinema field is at present reported to be greatly overcrowded, and theaters are constantly reported to be in difficulties.

The American system of sound projection is almost universally favored. It is regarded as very much better than the German systems, but is also about ten times as expensive. Once the problem of installing such expensive apparatus is solved, it is probable that the language difficulties will be overcome in much the same way as is the case now in Paris theaters, in which the music only is registered, while on the screen the subtitles remain in two languages. The extensive use of sound films is a thing of the future, however, and will not be realized in Switzerland for some years to come.

CONCLUSION

I hope I have made clear to you, from the foregoing, that the introduction of dialog and sound synchronized films will, within the next few years, create an entirely different situation in the field of motion pictures in Europe. Beyond a doubt, this new invention has been received abroad as enthusiastically as Americans have welcomed it. Time alone will solve the problem of language difficulties at present encountered in foreign markets where English is not the predominating language. However, production of American dialog

pictures in more than one language should not meet with serious handicaps.

Inasmuch as it will undoubtedly be at least two years before the total sound installations abroad will equal or even approach the number in the United States, it is safe to assume that exports of American motion pictures should continue to maintain the same high level as in the past. Those theaters abroad not equipped to present sound pictures will continue to show silent versions of pictures. Recently published production schedules of American producers indicate that there will be a sufficient number of silent versions of sound pictures to meet the requirements of those theaters in this country as well as abroad.

The American silent film and the sound film without dialog should continue to dominate the foreign field from a qualitative standpoint. Whether films of this type of manufacture can actually maintain America's prestige abroad, rests entirely on the upkeep of quality and the production of a sufficient number to meet European demand. On this score there should be slight uneasiness.

I desire to express my thanks to C. J. North, Chief of the Motion Picture Division, for his coöperation and capable assistance in the preparation of this paper. My thanks are also extended to George R. Canty, Motion Picture Trade Commissioner to Europe, and other European representatives of the Bureau of Foreign and Domestic Commerce for their valuable reports, which have made this paper possible.

THE EARLY HISTORY OF WIDE FILMS

CARL LOUIS GREGORY*

It has been claimed that there is only one standard of measurement which is common to all nations of the earth. That measurement is the width of a piece of standard theatrical size motion picture film.

Many persons actively engaged in the industry seem to be unaware that other widths and dimensions of film were ever used and some even believe that the use of wide film is a recent invention.

History moves in cycles and recent events in the use of wide film of various gauges show that we are in the midst of a repetition of the unstandardized efforts and struggles that marked the work of so many of the early pioneers of the industry.

To those who have never had occasion to refer to the early history of the motion picture it may come as a surprise that scores of scientists, mechanics, and inventors in nearly every civilized country were working simultaneously during the 90's to perfect a system for taking and showing motion pictures. While they were all, in the main, working along the same lines, yet each adopted whatever width of film seemed to him to be best suited for his experiments.

That the 35 mm. width of film came to be the measurement which survived and eventually became standardized is, so far as the writer has been able to ascertain, a coincidence. It was not foresight that caused Mr. Edison in this country and Lumière Frères in France to select film widths that were so nearly the same that they were practically interchangeable. It was pure chance, also, that these two firms happened to be the most powerful commercially in their respective countries.

Edison selected $1\frac{3}{8}$ inches as the width of film best suited for his Kinetoscope only after a long series of experiments with films in cylinders, disks, and narrow ribbon form run horizontally instead of vertically.

This measurement coincides within $\frac{1}{100}$ of an inch with the 35 mm. width selected by Lumière and, while Lumière used only one round

* 76 Echo Ave., New Rochelle, N. Y.

perforation on each side of the film and Edison used four rectangular ones, it was possible, by altering sprockets or by re-perforating the Lumière film, to use them interchangeably. Lumière later reluctantly abandoned the two-hole perforation and copied the Edison standard in order to sell film to users of Edison machines.

In the early days France led the rest of the world in production, and many a pioneer film man in this country profited by pirating and duping French films for distribution in the Nickelodeons here.

It is a difficult and almost impossible task to locate chronologically all the different sizes of films. Often the details of perforations and frame size are entirely omitted in the records which have been preserved.

An advertisement in Hopwood's *Living Pictures*, edition of 1899, offers the "Prestwich" specialties for animated photography—"nine different models of cameras and projectors in three sizes for $\frac{1}{2}$ in., $1\frac{3}{8}$ in., and $2\frac{3}{8}$ in. width of film." Half a dozen other advertisers in the same book offer "cinematographs" for sale and, while the illustrations show machines for films obviously of narrow or wide gauge, no mention is made of the size of the film.

During 1899 there were in England and on the Continent Muto-graph films $2\frac{3}{4}$ inches wide, Demeny Chronophotographs 60 mm. wide, Skladowsky film 65 mm. wide, Prestwich wide film $2\frac{3}{8}$ inches wide, Birtac film $1\frac{11}{16}$ inch wide, Junior Prestwich $\frac{1}{2}$ inch wide, besides the present standard established by Paul, Edison, and Lumière.

Henry V. Hopwood in 1899 described more than fifty different models of projectors made by different manufacturers and gave the names of about seventy more. Curiously enough the size of film used in the various machines is mentioned only in two or three instances. It is probable that most of them used the Edison standard, although it is obvious from the descriptions that many of them used other sizes.

Probably the first example of motion picture "film" as it is photographed today was a scene taken in the Champs Élysées in Paris in 1886 by Dr. E. J. Marey. Although the "film" was paper, sensitized celluloid not being available until a year or two later, and cine projectors having not yet been invented, this paper negative could be printed as a positive film and run as a Fox Grandeur film today.

In May, 1889, William Friese-Greene, 92 Piccadilly, London, made a motion picture negative of a scene on the Esplanade, Brighton,

England, using paper film negative with frames $2\frac{1}{2}$ inches wide and $1\frac{1}{2}$ inches high. Later in the same year he used celluloid film displacing the paper used earlier.

One of the first to project successfully upon a large sized screen was Mr. Woodville Latham, inventor of the Latham Coop which caused much patent litigation in the early days. Latham called his machine the Eidoloscope and used film 2 inches wide with frames $\frac{3}{4}$ inch high by $1\frac{1}{2}$ inches long.

In the fall of 1897, Enoch J. Rector, an inventor and promoter, showed pictures of the Corbett-Fitzsimmons prize fight in the Academy of Music on 14th Street in New York City. His apparatus was called the Veriscope and the same mechanism used to show the pictures was employed in the camera with which 11,000 feet of film were taken at Carson City, Nevada, March 17, 1897. Thereafter about twenty machines for projecting this large size film were manufactured and these fight films were exhibited all over the country.

In the late 90's the motion picture was regarded as a great novelty which would soon die out. Conditions were chaotic and everyone who went into the business worked with frantic eagerness to reap the rich harvest before the fickle interest of the public should pass on to some new fancy. Just as there was no standard of film size, no rate of frames per second was established and the taking rate varied from 8 per second to 60 per second among the different systems, each of which was distinguished by some fantastic and polysyllabic name. Out of the hundreds of such coined trade names only a few, such as Kinetoscope, Vitagraph, Biograph, and Mutoscope, are remembered today.

Subjects were confined almost entirely to news events, prize-fights, short scenic shots, and theatrical or spectacular bits many of which were considered very risqué in those conservative days. The *May Irwin Kiss*, *Little Egypt*, *Loie Fuller's Fire Dance*, *Bridget Serves Salad Undressed*, and many others brought gasps of amazement at their audacity.

On November 3, 1899, the Jeffries-Sharkey fight was held at Coney Island at night. Wm. A. Brady, now well known in the theatrical and motion picture world, and a promoter named O'Rourke sponsored the bout and induced the American Mutoscope and Biograph Company to film the fight. Wm. Bitzer, a cinematographer still on the staff of D. W. Griffith, had charge of the photography. Four hundred arc lights were hung over the ring. The film used

was $2\frac{3}{4}$ inches wide and each frame was $2\frac{1}{4}$ inches high. Three hundred and twenty feet of this wide film were used per minute, the perforations being made in the camera at the instant of taking. The fight lasted for twenty-five rounds of three minutes each, and more than seven miles of film were exposed. Four cameras were on the job so as to obtain a continuous record. Buckling of the film in the cameras was frequent although the film could be watched through a red glass peep-hole by the light of a small ruby lamp inside the camera box. The perforations in the large Biograph film were used in printing, but not in projecting. The projector pulled the film down by means of a set of mutilated rubber rollers and the projectionist had to watch the frame continuously to prevent creeping of the frame line on the screen.

Oscar B. Depue, a member of this Society and partner of Burton Holmes, in 1897 purchased a machine in Paris from Leon Gaumont for taking 60 mm. wide film, then put up in one hundred foot lengths. It was a darkroom model, not a daylight proposition. Unwinding and rewinding were done inside the camera on aluminum spools. This machine he took to Italy and the first motion picture turned out on the machine was of St. Peter's Cathedral with the fountain playing in the foreground and a flock of goats passing by the machine. He then took other pictures of Rome and from there visited Venice, making pictures of the canal and Doges Palace and the waterfront along the canal with views of feeding the pigeons at St. Marks with the great cathedral in the background. From there he went to Milan for a scene of the Plaza in front of the Milan Cathedral; thence to Paris where pictures of the Place de la Concord with its interesting traffic and horse drawn busses, fountains, obelisks, statues, bicycles, wagons, trucks, and carriages were made. These negatives are still in his possession although the prints from them have long since been lost on account of our having changed from that size of picture to the standard size. This Gaumont wide film camera was used for five years by Mr. Depue and most of the negatives, many of which are of great historical value, are still in good condition, so that either full size or standard sized reduction prints can still be made from them.

During the first few years of the new century all of the sizes of wide film died out or changed to the Edison standard and, until the present vogue for sound pictures caused a revolution in the cinematographic world, the Edison standard with very slight modifica-

tions seemed to be so well established that nothing could shake its supremacy. During these quiet years a few inventors cried aloud in the wilderness that they had worked out larger and better methods for making cinematograph films, but their pleas fell, for the most part, upon deaf ears. Spoor and Bergren have worked for more than ten years upon a 63 mm. film called Natural Vision pictures. Widescope sponsored a double frame picture on standard film. After that an Italian patent was acquired in which a film about $2\frac{1}{4}$ inches wide is held in cylindrical form about the axis of rotation of a revolving lens so that each frame is photographed using the same principle as a panoramic still camera. Unfortunately this method of taking pictures introduces the same curvilinear distortion often noticed in panoramic still photographs.

Fox Grandeur pictures are 70 mm. in width with a frame 48 mm. by 22.5 mm., leaving space available for a sound track about 10 mm. wide. Lorenzo Del Riccio, a member of this Society, is perfecting the Magnafilm for Paramount. This film is 56 mm. wide and the frames are $19\frac{1}{2}$ mm. high. Several other sizes of wide film are being used experimentally and other new sizes are being advocated but these are current and not early history and do not properly belong in this chronicle.

We have been looking back over the years since 1886 when Dr. E. J. Marey, of Paris, made the first paper band of negative on the same principle as motion pictures are made today. We shall look forward over the years to come with a strong conviction that the Society of Motion Picture Engineers will bring the sponsors of these new film sizes together to work out standards which will prevent a repetition of the chaotic conditions which hampered the industry in its early days.

DISCUSSION

MR. TAYLOR: It strikes me as strange that some one with an historical mind has not accumulated a library of old film. Such a hobby would not cost very much or take up much space. Here are fifty types of machines with no record of the film. The Society might well give this some consideration and appoint a committee to look into the matter.

MR. GREGORY: I agree with the speaker. I know of a tremendous collection of that kind of material in the possession of Mr. Jean A. LeRoy. I should like to have this matter presented to the Society at the proper time.

RECTANGLE PROPORTIONS IN PICTORIAL COMPOSITION*

LOYD A. JONES

Since the birth of the motion picture some thirty years ago there have been discussions from time to time concerning the most satisfactory shape of the picture area. In the early stages of development several different shapes and sizes were proposed and tried experimentally. Using the ratio of width to height as a specification of the shape of the rectangle, we find among the very early productions values of this ratio varying all the way from 1.25 up to 2.0. Practice finally crystallized, however, and a rectangle having a width of four units and a height of three units ($R = 1.33$) was adopted as standard. This continued as almost universal practice until the advent of sound which, in the case of sound-on-film positives, necessitated the narrowing of the available picture area in order to provide space for the photographic sound record. If the height of the positive image is maintained at its old value, that is, four perforations less the necessary allowance for frame line, the resultant positive picture area has a ratio of approximately 1.15.

Even under the old conditions where the 4 to 3 ratio ($R = 1.33$) obtained, many individuals, including motion picture directors, art directors, scenario writers, camera men, *etc.*, felt that the resultant picture was too "fat," that is, too narrow relative to its height, for most pleasing and satisfactory results. The subtraction of the area required for the sound track has served to make available picture area on the positive film even more nearly square. It is almost universally agreed among those who have given this problem careful consideration that this change in shape of the projected picture is in the wrong direction and gives an area of which the proportions are extremely unsatisfactory from the standpoint of both pictorial composition and practical utility. This situation has served, therefore to focus attention again on the question of picture shape, and

* Communication No. 410 from the Kodak Research Laboratories.

during the past months the merits and demerits of various proposed shapes have been vigorously discussed.

Motion picture technic cannot be classified as belonging entirely to either the realm of art or that of science but is made up of many factors that fall within the category of applied science and many that are of an artistic nature. In a discussion of picture shape there are many mechanical and optical requirements that should be considered but no attempt will be made to deal with these at this time. It is desired rather to call attention to one or two aspects of the problem which may be classified as artistic, or, since they are dealt with by a method of mathematical analysis, the term pseudo-artistic might be more appropriate.

DYNAMIC AND STATIC SYMMETRY

A search through the literature of art shows that the question of rectangle proportions is one which has occupied the attention of many artists and that most exhaustive studies have been made in an effort to determine the rectangle shapes which may be considered satisfactory from the standpoint of pictorial composition and design. The literature on the subject is voluminous and it will be possible in this paper to give only a very brief summary of the conclusions reached by a number of eminent authorities in this field.

From the standpoint of pictorial composition and design, rectangles may be classified as of two general types, namely, (a) those exhibiting static symmetry, and (b) those exhibiting dynamic symmetry. Rectangles of the former class may be analyzed into series of squares. For instance, a rectangle having a height of 2 units and a width of 3 units may be analyzed into 6 equal square areas, while one having a height of 3 units and a width of 4 units may be analyzed into 12 equal squares. Such areas are considered by the artist to be more formal and of less merit from the aesthetic point of view than rectangles of dynamic symmetry type.

The proportion of the motion picture on standard 35 mm. film previous to the introduction of sound on film was 4 wide by 3 high. This is a rectangle belonging definitely to the static symmetry classification. Even previous to the introduction of sound and when the usual projected picture had the ratio of 1.33, many observers of artistic training had criticized the shape as not being particularly pleasing or well adapted to the requirements of best pictorial composition.

Rectangles of the dynamic symmetry type are based almost entirely on two general proportion principles.¹ One of the series of these rectangles is referred to as the *square root* series, while the other group is termed the *whirling square* series. In the former group are found rectangles for which the ratio values are equivalent to the square roots of whole numbers, as, for instance,

$$R = \sqrt{2} = 1.414$$

$$R = \sqrt{3} = 1.732$$

$$R = \sqrt{4} = 2.000$$

$$R = \sqrt{5} = 2.236$$

From these basic rectangles many other more complicated rectangles can be derived all of which have the characteristics of dynamic symmetry. Those based directly on the whole number roots represent the simplest forms and, perhaps as a consequence of this simplicity, are considered to possess greater strength than the more

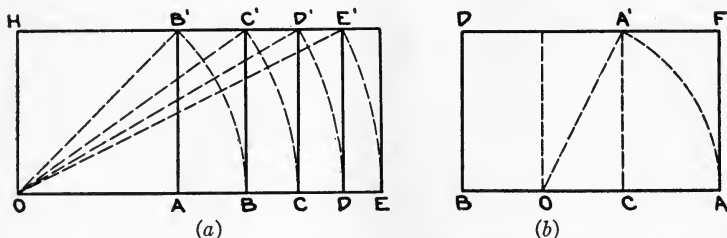

FIG. 1. (a) Method of constructing the root rectangles. (b) Method of constructing the whirling square rectangle.

complicated derived proportions. It will be noted that the third member of the series above can be analyzed directly into a series of squares, and therefore belongs also to the static symmetry classification. This rectangle is considered by authorities on this subject to be the weakest and least desirable of the various root rectangles. Of this series it appears that the first two represent the strongest and most desirable members from the standpoint of pictorial composition, while the fourth member has many virtues when considered from the standpoint of conventional design and decoration. Additional members may be added to this series by using the square roots of higher numbers, for instance, $\sqrt{6}$, $\sqrt{7}$, etc., but these are of minor importance and less suitable to the requirements of average pictorial composition than those already mentioned.

In Fig. 1 at (a) is shown a method of constructing the root rec-

¹ "The Diagonal," I, 1919-20. Yale University Press.

tangles. The line OB' is the diagonal of the square $OAB'H$. As indicated by the dotted construction the line OB is equal in length to the diagonal OB' and the rectangle constructed on the base OB is the *root two* rectangle. Likewise, the rectangle constructed on the base OC is the *root three* rectangle, that on the base line OD is the *root four* rectangle, and that on base line OE is the *root five* rectangle.

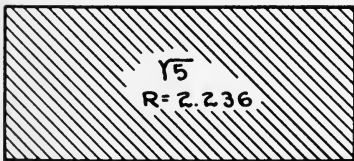
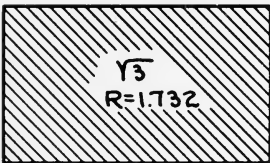
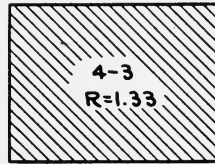

Dynamic symmetry

Static symmetry

FIG. 2. A series of rectangles exhibiting dynamic symmetry and static symmetry.

The whirling square rectangle is illustrated at (b) in Fig. 1. The construction of this rectangle is shown by the dotted lines. $BDA'C$ is a square, the point O being located at the middle of the base line BC . The diagonal OA' rotated about O establishes the point A . The line BA then becomes the base of this rectangle, one side of the basic square BD being the altitude. The rectangle $ABDF$ has the ratio 1.618 and is the famous whirling square rectangle so intimately connected with classical Greek art. Many of the finest compositions in Greek architecture, sculpture, painting, mural design, and pottery can be broken down into this rectangle which, in the opinion of many artists, exhibits the characteristics of dynamic symmetry to the most marked extent.

In Fig. 2 are shown series of rectangles representing both the dynamic and the static symmetry types. The top of the left-hand column is the root two rectangle. Immediately below this is the root three rectangle, and at the bottom of this column the root five rectangle. In the right-hand column are shown a few examples of rectangles exhibiting static symmetry; that at the top having a ratio of 4 to 3 (1.33), the proportions of the present standard motion picture positive. Below this is the 3 to 2 rectangle (1.5), the next in the series being the 7 to 4 rectangle (1.75). At the bottom of this column is the 2 to 1 rectangle which is also the root four rectangle sometimes placed in the dynamic series. There seems to be little doubt, however, that this rectangle exhibits static characteristics much more strongly than dynamic. It is only when used in a treatment combined with the whirling square rectangle or one of the other root rectangles that it can be said to exhibit satisfactorily dynamic symmetry characteristics. It seems better, therefore, in a simple classification such as that in which we are interested, to place it specifically in the static class.

RECTANGLE PROPORTIONS IN ART

In a consideration of the rectangle proportions adapted to the requirements of pictorial composition, it seems reasonable to assume that some valuable information may be obtained by a study of what has been done by the master artists during the past three or four centuries. While it may be true that we are not justified in drawing definite conclusions as to the most satisfactory rectangle shape for motion picture purposes from data based upon artistic compositions which necessarily are of static character, it seems probable that a

knowledge of what has been done in this field may prove interesting and may give some indication of what is most desirable in motion picture practice. A rather superficial study has been made of the rectangle proportions used by artists in the creation of their pictures. It has been found, as was to be expected, that a very great variety of picture shapes has been used by the masters in this field. Hence, to make the results of such analyses conclusive and convincing, an enormous number of examples should be studied and the final conclusion based upon the statistical averages. Unfortunately, time has not been available to carry this analysis to the point where the

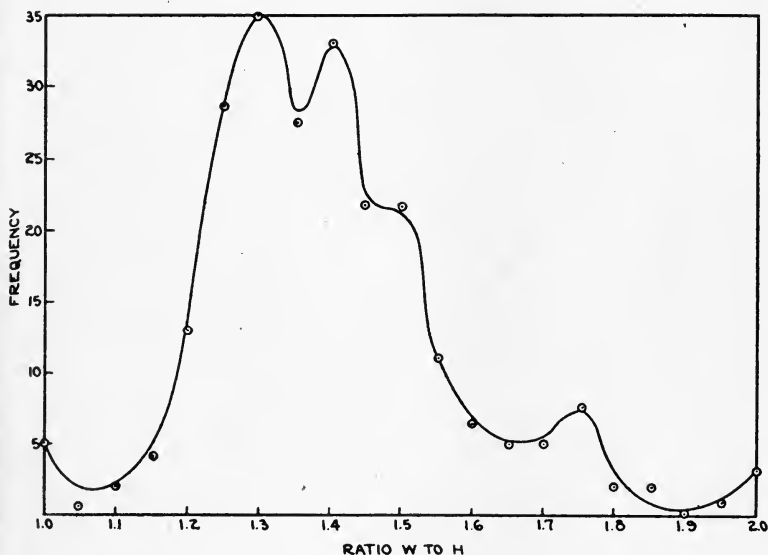

FIG. 3. Ratio-frequency curve of some two hundred and fifty paintings by about fifty well known artists.

results may be considered representative of the whole field. It may be of interest, however, to present a few of the preliminary values obtained in this manner.

As an initial step the width to height ratio of some two hundred and fifty paintings by about fifty well known artists was determined. The artists represented include not only old masters but some of the more modern painters. Since it seems fairly certain that the rectangle shape most satisfactory for motion picture technic must be wider than it is high, it was decided to exclude from this group all pictures with the ratio of width to height less than unity. The very

nature of the subject matter which it is desirable to include in the *average* motion picture composition seems to necessitate horizontal dimensions greater than the vertical. It is obvious, of course, that no one rectangle proportion can be best adapted to every composition that may possibly be desired and that, in choosing a rectangle proportion, compromises must be made with specific requirements and some value chosen fitting as closely as possible the *average* requirements.

It should be remembered also that in making any classification of rectangle proportions used in pictorial composition some consideration must be given to the subject type and picture content before any final conclusion can be drawn. In this preliminary study, however, this factor has been neglected and the ratio-frequency curve obtained applies to a group of paintings embracing practically the entire gamut of pictorial composition, with the exception of all vertical types. The results of this analysis may be shown graphically by plotting the number of compositions as a function of the width to height ratio. The curve obtained in this manner is shown in Fig. 3. It will be noted that a maximum exists at $R = 1.3$, another maximum at $R = 1.4$, with a suggestion of a third maximum at $R = 1.5$. Relatively few examples were found for which the ratio value is less than 1.2. Likewise, relatively few compositions in this particular group have a ratio value greater than 1.6.

The same line of thought has been carried further and a rather complete study of the work of one of the old masters has been analyzed from the standpoint of rectangle proportions. In any statistical study it is desirable to base conclusions on a large number of observations and in a given group to include all available examples without the arbitrary exclusion of any which may apparently be unusual. From a monograph on the work of Rubens¹ containing authentic reproductions of the entire work of this master, the rectangle proportion for each of his compositions was determined. An attempt was made to classify these pictures from a standpoint of motion picture technic. As a matter of fact, the work of this artist seems particularly adapted to this purpose. The majority of his compositions represent situations which might very conceivably fit into a motion picture practice, representing as they do movement, action, dramatic situations, emotional expression, *etc.* The usual

¹ Adolf Rosenberg, "The Work of Rubens," Brentanos, 1913.

classification of pictures into portrait, landscape, *genre*, still life, *etc.*, does not seem to fit the requirements of this analysis. The author has therefore attempted to make a classification which is interpretable more directly into terms of motion picture technic, and while it is admittedly far from complete, it does seem to permit the classification of paintings into groups having some significance from the standpoint of our current motion picture practice. The classification is based largely on the number of human figures included, further modified by a consideration of whether the picture is a close-up, semi-close-up, medium, or long shot representation. For instance, among the pictures including a single human figure, representing of course the portrait class, may be found those in which only the face or head is shown, while others include the bust, half length, three-quarter length, or full length representation. Most of these may be classed as close-up compositions although in the case of the three-quarter or full length representations they become analogous to semi-close-up or even medium distance shots. In the case of compositions including two figures it seems satisfactory to make but two subdivisions, those which may be considered semi-close-up, the figure being shown as somewhat less than full length, and a medium distance shot where the two figures are shown in full length. The same is true of those compositions including from three to five figures, while in the case of larger groups the subdivision may be made most advantageously in terms of medium distance shots, semi-long shot, and long shot groupings. Among the works of Rubens we find but few landscapes, and in practically all these, figures occupy a position of subordinate importance. These can quite conceivably be compared with certain types of motion picture technic, exterior shots either of semi- or long shot characteristics including figures representing either static or dynamic action. On the whole, the works of Rubens seem to be particularly adapted to an analogous motion picture technic classification. The groups into which his works have been classified are as follows:

I. Single-figure compositions

- (a) Head only, close-up type
- (b) Head and shoulders, close-up type
- (c) Half length figure, close-up type
- (d) Three-quarter length figure, semi-close-up type
- (e) Full length figure, semi-close-up type

II. Two-figure compositions

- (a) Less than full length, semi-close-up type
- (b) Full length figures, medium distance type
- III. Three- to five-figure compositions
 - (a) Less than full length, semi-close-up type
 - (b) Full length figures, medium distance type
- IV. Six- to ten-figure compositions
 - (a) Full lengths, medium distance type
- V. Ten- to twenty-five-figure compositions
 - (a) Medium distance type
 - (b) Semi-long shot type
- VI. More than twenty-five-figure compositions
 - (a) Medium distance type
 - (b) Long shot type

VII. Landscape, exterior long shots with architectural element or figure group, and compositions of miscellaneous character in which human figures are entirely absent or occupy subordinate or inconspicuous positions, generally of the semi-long shot or long shot type.

In Table I are shown the values of ratio for the compositions which fall in the subdivisions of the single-figure compositions. At the bottom of each column is given the mean value and below that the number of compositions in the group. The number of observations in each of these groups is insufficient to warrant the plotting of a frequency curve. While theoretically the use of the arithmetical mean in work of this kind is not a particularly satisfactory way of arriving at a definite conclusion as to the predominant characteristic of the group, it seems to be the only method available where the number of observations is so limited. In case there is more than one maximum in the frequency distribution this effect will be masked by taking the arithmetical mean. For instance, it is evident from an inspection of Fig. 3 that had a straight arithmetical average been made the true distribution of frequency as a function of ratio would have been obscured. The use of the arithmetical mean, however, in the case of rather homogeneous groups, such as are obtained by the classification of compositions into distinct types, seems to be a fairly satisfactory method of obtaining some idea as to the predominant shape factor. It will be noted that the ratio decreases from the I (a) toward the I (c) grouping. This of course is a logical consequence when composition factors are considered.

In Table II are given the ratio values obtained for the two-figure compositions and the three- to five-figure compositions. The values obtained for the II (a) group are fairly homogeneous and a single arithmetical mean seems to be a satisfactory indication of character-

TABLE I

Ratio of Width to Height for Single-Figure Compositions

Classification	I (a)	I (b)	I (c)	I (d)	I (e)
	0.72	0.64	0.66	0.58	0.35
	0.77	0.71	0.74	0.68	0.35
	0.80	0.73	0.74	0.69	0.36
	0.81	0.73	0.74	0.70	0.36
	0.85	0.74	0.75	0.71	0.38
	0.91	0.74	0.75	0.72	0.38
	1.04	0.75	0.75	0.72	0.45
	1.15	0.75	0.76	0.73	0.45
		0.76	0.78	0.74	0.47
		0.77	0.78	0.74	0.47
		0.77	0.78	0.74	0.48
		0.77	0.79	0.75	0.48
		0.77	0.79	0.76	0.52
		0.78	0.79	0.76	0.55
		0.79	0.79	0.76	0.55
		0.79	0.79	0.76	0.59
		0.79	0.79	0.77	0.59
		0.79	0.79	0.77	0.62
		0.79	0.79	0.78	0.62
		0.80	0.79	0.78	0.63
		0.80	0.80	0.78	0.65
		0.80	0.81	0.78	0.66
		0.81	0.81	0.79	0.67
		0.82	0.82	0.79	0.67
		0.82	1.17	0.79	0.70
		0.82		0.79	0.70
		0.84		0.79	0.71
		0.84		0.79	0.74
		0.85		0.80	0.76
		0.85		0.80	0.82
		0.86		0.80	0.85
		0.86		0.81	
		0.86		0.83	
		1.02		0.84	
		1.17		0.84	
				0.85	
				0.85	
				0.88	
Mean ratio	0.88	0.81	0.79	0.77	0.57
Number of pictures	8	35	25	38	31

TABLE II

Ratio of Width to Height for Two-Figure Compositions and the Three- to Five-Figure Compositions

Classification	II (a)	II (b)		III (a)		III (b)	
		R < 1	R > 1	R < 1	R > 1	R < 1	R > 1
	0.59	0.58	1.26	0.66	1.02	0.69	1.01
	0.65	0.59	1.26	0.70	1.07	0.74	1.02
	0.75	0.63	1.26	0.70	1.09	0.74	1.04
	0.75	0.68	1.31	0.70	1.09	0.74	1.05
	0.77	0.72	1.33	0.71	1.28	0.76	1.05
	0.78	0.72	1.33	0.72	1.30	0.76	1.05
	0.79	0.74	1.33	0.72	1.31	0.78	1.05
	0.84	0.74	1.37	0.73	1.31	0.78	1.07
	0.92	0.74	1.38	0.73	1.45	0.79	1.07
		0.76	1.43	0.73	1.89	0.79	1.12
		0.77	1.45	0.74		0.79	1.13
		0.78	1.45	0.74		0.79	1.13
		0.78		0.75		0.79	1.16
		0.78		0.76	(10)	0.83	1.19
		0.79		0.76		0.83	1.21
		0.79		0.77		0.84	1.22
		0.82		0.79		0.85	1.22
		0.90		0.79		0.85	1.25
		0.98		0.79		0.87	1.28
				0.79		0.93	1.31
				0.79		0.94	1.31
				0.80		0.96	1.33
				0.81		0.96	1.33
				0.82			1.33
				0.83			1.35
				0.83			1.35
				0.84			1.37
				0.84			1.37
				0.85			1.37
				0.85			1.38
				0.86			1.38
				0.86			1.39
				0.88			1.41
				0.88			1.41
				0.97			1.41
							1.43
							1.45
							1.45
							1.45
							1.47
							1.51
							1.54
							1.56
							1.59
							1.64
							1.64
							1.66
							1.72
							1.95
							1.95
							1.97
Mean ratio	0.76	0.75	1.35	0.78	1.28	0.81	1.48
Number of pictures	9	19	12	34	10	23	50

TABLE III

Ratio of Width to Height for the Six- to Ten-Figure Compositions and the Ten- to Twenty-Five-Figure Compositions

Classification	IV (a)		V (a)	V (b)	
	R < 1	R > 1		R < 1	R > 1
	0.65	1.04	1.28	0.69	1.11
	0.65	1.04	1.30	0.70	1.20
	0.68	1.06	1.33	0.74	1.22
	0.70	1.07	1.38	0.74	1.25
	0.72	1.10	1.45	0.76	1.25
	0.75	1.11	1.47	0.76	1.25
	0.75	1.11	1.60		1.25
	0.76	1.15	1.64		1.28
	0.77	1.16	1.66		1.28
	0.78	1.16			1.38
	0.79	1.20			1.39
	0.80	1.20			1.44
	0.82	1.20			1.45
	0.83	1.22			1.45
	0.85	1.23			1.47
	0.91	1.28			1.47
	0.99	1.30			1.47
	0.99	1.30			1.56
		1.31			1.61
		1.31			1.79
		1.31			2.32
		1.31			2.77
		1.33			
		1.35			
		1.35			
		1.37			
		1.37			
		1.37			
		1.38			
		1.39			
		1.42			
		1.43			
		1.43			
		1.47			
		1.47			
		1.48			
		1.49			
		1.49			
		1.54			
		1.54			
		1.54			
		1.54			
		1.54			
		1.56			
		1.56			
		1.58			
		1.59			
		1.66			
		1.75			
		1.92			
Mean ratio	0.79	1.36	1.46	0.73	1.49
Number of pictures	18	49	9	6	22

istic mode. An inspection of values applying to those compositions which are put into the II (*b*) class shows two distinct groups, for one of which R is less than unity and for the other greater. These values have therefore been split into two groups on the basis of an evident marked difference in character. After this secondary classification within the group has been made, two groups of values, each relatively homogeneous in character, are obtained, one of which represents vertical compositions (R less than unity) and the other horizontal compositions.

A similar state of affairs was found in the case of the III (*a*) class, the ratio values being rather definitely divided into groups greater than and less than unity.

In class III (*b*) it was again found necessary to separate the vertical from the horizontal types of compositions in order to obtain homogeneous groups of ratio values. It is interesting to note that in the case of two-figure compositions (classes II (*a*) and II (*b*)) the number of vertical type compositions is very much in excess of the horizontal type. This is also true in the case of three- to five-figure compositions falling within the III (*a*) class and including those compositions where the figures are shown as somewhat less than full length and in a semi-close-up rendition. In the III (*b*) class, also including three- to five-figure compositions, but where the distance is increased to correspond to a medium distance type, this condition is reversed and compositions for which the ratio value is greater than unity exceed the number of those of the vertical type for which R is less than unity.

In Table III are given the data relative to the six- to ten-figure compositions and the ten- to twenty-five-figure compositions. In the case of class IV it seemed to be impossible to further subdivide the compositions on the basis of the distance from point of view. Practically all these may be classified as medium distance types. Here again, a small, fairly homogeneous group of vertical compositions is obtained and a much more numerous group, also relatively homogeneous in ratio value, of the horizontal composition type.

In class V (*a*) all the compositions are of the horizontal type although this group is limited in number. In group V (*b*) it was necessary to subdivide again in order to obtain homogeneous groupings. Those of the vertical type are few in number, while those of the horizontal type are relatively numerous and the mean value of ratio relatively great. Among the compositions including many

figures (this term "many" is defined as applying to all figure groupings containing more than twenty-five members) none of the vertical type are found and the ratio values in the case of both subdivisions of this group are relatively high. Those compositions falling within the last subdivision, VII, are also fairly homogeneous with respect to their ratio values. No vertical compositions appear and the mean value for R is relatively high.

The results of this statistical analysis are summarized in Table V. As shown by the total at the bottom of the second column 460 compositions are included. Columns 3 to 7 give information as to the character of the groups used in this classification. In the columns "Min." and "Max." are the minimum and maximum values of R

TABLE IV

Ratio of Width to Height for Composition Including Many Figures, and for Landscapes

Classification	VI (a)	VI (b)	VII
	1.35	1.33	1.30
	1.50	1.33	1.35
	1.51	1.35	1.37
	1.51	1.41	1.41
	1.53	1.53	1.43
	1.61	1.56	1.45
	1.61	1.57	1.45
	1.61	1.66	1.49
	1.66	1.66	1.51
	1.72	1.72	1.51
	1.81	1.81	1.54
	1.88	1.81	1.54
		1.88	1.56
		1.88	1.56
		1.96	1.56
			1.57
			1.61
			1.64
			1.66
			1.69
			1.72
			1.75
			1.78
			1.88
			1.96
Mean ratio	1.61	1.63	1.57
Number of pictures	12	18	25

for each of the classes. In the case of the first six classes these are of some significance since the compositions included within these classes are relatively similar in shape. For those classes which contain both vertical and horizontal compositions these maximum and minimum values are of little significance since they represent the extremes of a distribution containing two definite maxima. For these groups no value of the mean ratio is shown. In the last two columns, however, are given the mean value for the vertical compositions and the mean value for the horizontal compositions. It is interesting to note the progressive manner in which the rectangle shape changes as the number of figures included in the com-

TABLE V
Summary of Statistical Analysis of 460 Compositions

Class	No.	Min. R	Max. R	Mean R	R < 1	R > 1
I (a)	8	0.72	1.15	0.88	0.88	
(b)	35	0.64	1.17	0.81	0.81	
(c)	25	0.66	1.17	0.79	0.79	
(d)	38	0.58	0.88	0.77	0.77	
(e)	31	0.35	0.85	0.57	0.57	
II (a)	9	0.59	0.92	0.76	0.76	
(b)	31	0.58	1.45		0.75	1.35
III (a)	44	0.66	1.89		0.78	1.28
(b)	73	0.69	1.64		0.81	1.48
IV (a)	67	0.65	1.92		0.79	1.36
V (a)	9	1.28	1.66	1.46		1.46
(b)	35	0.69	2.77		0.73	1.49
VI (a)	12	1.35	1.88	1.61		1.61
(b)	15	1.33	1.96	1.63		1.63
VII (a)	26	1.30	1.88	1.57		1.57
Total	460					

position increases. For instance, for single-figure compositions the ratio value remains below unity and with the exception of the full length compositions is fairly constant at a value of approximately 0.80. As we progress into the two-figure compositions there is an immediate subdivision into horizontal and vertical types. This persists throughout the three to five, six to ten, and ten to twenty-five classes, the relative number of vertical compositions steadily decreasing as the number of figures in the composition increases. Where more than twenty-five figures are included, the vertical type disappears entirely and the same is true for class VII including landscape compositions, either with or without figure groupings.

In considering the requirements of our modern motion picture technic, it seems probable that, because of the presence of movement and action of a given number of figures within the composition, a somewhat greater dimension in the horizontal direction than that used in static composition is desirable. It is quite evident that in the consideration of the most desirable shape for the motion picture screen many factors other than those of pictorial composition as applying to still pictures must be considered. The author feels, therefore, that a study of this subject is of some interest and significance.

DISCUSSION

MR. COFFMAN: I think this paper is a most unusual example of the ways in which the scientific mind and the artistic complement each other. I believe that the basis of both art and science are similar in a great many respects. It is certain that they come together in insisting on general symmetry, at any rate, and this paper, illustrating the service which science can render to art, deserves a place in the classics of the motion picture engineers.

There are several features in connection with the material that Mr. Jones has presented that deserve consideration. Rubens, as Mr. Jones stated, is probably nearer to the motion picture director than any of the other classic masters. He could work in a little sex appeal in his paintings, and sometimes he went in for commercialism rather than for the highest possible artistic standards.

We should, however, keep in mind that his paintings of figures do rarely recognize the architectural features of the background. In dramatic composition the architectural set must have considerable recognition. If we take a static moment as is usually presented in the still picture painted or photographed, it is not necessary for us to recognize much of the architectural background, but in the dramatic composition it is hovering over the characters and must complement their actions. It is probable that the ultimate proportions of the motion picture frame will be different from those needed by any single dramatic composition that can be proposed, because you can't establish a background and its dominance of the scene by a static scene.

MR. FARNHAM: The fact that the projection room is usually located at an elevation above the screen results in projection at an angle. Distortion of the picture shape makes the screen more nearly square. A recommendation as to the most desirable picture proportion should specify the picture as it appears on the screen. A conversion factor based on projection angle will have to be obtained to determine the projector aperture proportions.

MR. RICHARDSON: Projection angle has in some cases resulted in square pictures; in others, the height has been greater than the width.

DR. HICKMAN: I should like to join Mr. Coffman's tribute to Mr. Jones if I might. I think this is an extraordinarily stimulating paper.

There are one or two points that occur to me. When an amateur photographer or artist makes a close-up he afterwards trims the picture to the size he likes best. The director achieves the same object by vignetting the sides, so that he is chang-

ing the effective area to suit his needs. We need the picture which will house the largest thing we have to photograph, provided the frame lines of which the eye is always conscious are not offensive. I find a very wide picture an offensive shape. In looking at the group on the left of Fig. 2 one might be able to choose the most pleasing shape. I don't know whether the assembly would be interested in expressing their opinions. I believe the top and the third are the most pleasing for the normal type of subject.

MR. TAYLOR: I think we want not one proportion for the motion picture rectangle but that this should be variable with the subject material. Can Mr. Jones tell us what is called the "Golden Rule" in proportion?

MR. JONES: The "Golden Rule" in proportion is stated as follows, "Height is to length as length is to the sum of height and length." Mathematically expressed, this gives a ratio of length to height equal to 1.62. This is the same as the Whirling Square rectangle ratio.

MR. RICHARDSON: I have received in the past ten or fifteen years four or five hundred styles of projection apertures sent me by projectionists.

MR. COFFMAN: I believe that regardless of the possibilities of vignetting or using a mask, at all times you subconsciously work with the proportions of the whole picture. This will dominate in the composition of the thing as you see it.

MR. JONES: I want to add one or two words. I want to call your attention to the fact that this paper is a study of one particular factor. There are many others if you want to extend this into a complete discussion of the best possible solution of this problem. I have not attempted to deal with other factors. Mr. Farnham's and Mr. Richardson's points are well taken. I did not attempt to consider them; I was talking specifically about a rather abstract thing.

I want to agree with Mr. Coffman in his opinion that you cannot change the rectangle proportion by masking. The artist can do a great deal by concentrating attention on the proportion. He can use displeasing or pleasing compositions to fill in, but I believe the rectangle proportion will predominate, and it is important for this to be right.

MR. BALL: One of the great merits of the wide picture is that the borderline can be removed from consciousness, and that is the reason for the pseudo-stereoscopic effect, which is very real and important.

I should like to ask Mr. Jones about the angle and size and shape of that portion of the field of vision which is mostly used. I believe there is a small area of the retina upon which an image must fall if we are to see with any degree of acuity. Beyond that limiting angle we are not aware of objects.

MR. JONES: The fovea is relatively small, subtending an angle of about one degree. It is on this area of the retina that most acute vision is obtained and it is the spot upon which the image of any object, to which we are giving direct attention, falls. We are, however, aware of objects well outside of this area and I do not believe that the angular size of the fovea can play a dominant roll in the determination of the most pleasing rectangle proportions in pictorial composition. While things which fall on the peripheral area are not seen as sharply and are subject to aberrations, they are certainly present in consciousness and do contribute very profoundly to our general impression of the whole visual field. It is probable that the general shape of the entire visual binocular field has more influence on the most desirable rectangle proportion than the angular dimensions

of the area of acute vision. At an average viewing distance from the screen, it is probable that an area not more than 2 feet in diameter covers the entire fovea and it is obvious that a picture of that size would not be either of pleasing size or of pleasing shape.

There are many other factors to be considered and I am not prepared at this time to make a more complete analysis. I should like to emphasize the fact that the whole discussion presented in this paper relates to the rectangle proportion and not to the most desirable angular size of picture.

MR. PALMER: I should like to have Dr. Hickman's suggestion carried out—that we have a vote on which of the four proportions (left column, Fig. 2) we like best.

MR. JONES: Before doing that, I should like to point out that I do not consider this is a fair test, because you have a rectangle within a rectangle here. If you want to take any such vote as that, a group of lantern slides should be prepared and shown one at a time with no contributing distracting surroundings. I have no objection to your going ahead, but it will not mean anything because you can't exclude from your judgment the effect of the other things.

MR. PALMER: I agree with Mr. Jones that it would be better to do as he suggests.

MR. ELMS: I think the projection of motion pictures of different proportions will give you what you want.

DR. HICKMAN: I think one cannot judge without information about the dimensions of the theater.

MR. JONES: I do not agree entirely with Dr. Hickman. While there are undoubtedly extraneous factors in the theater which influence our perception of the picture, they are in general of a much lower brightness and hence have much less weight in building up the total visual impression than the picture area itself which is illuminated to a relatively high level. For instance, in an average theater we may take it that the screen surface itself has a brightness of approximately 10 apparent foot candles. The illumination on areas outside of the picture is seldom higher than 0.1 apparent foot candles and when it is considered that the screen surface is of high reflecting power and the surrounding objects of relatively low reflecting power, it will be seen that the screen surface itself is probably one thousand times brighter than the surrounding objects. This certainly will serve to suppress the importance of objects outside of the picture area, and I believe that under such conditions it would be possible to make a more reliable judgment as to the most pleasing rectangle proportions. In this room at present we do not have such conditions and I doubt if our estimates would be of much value.

THE OPTICAL PROBLEMS OF WIDE FILM MOTION PICTURES

W. B. RAYTON*

The employment of film wider than the standard 35 mm. seems imminent. No one can say whether we will have to deal with one size or several, but, however that question may be settled, the difficulties encountered in designing adequate optical systems are of the same kind in all cases but differ in degree with the variations in width of film and size of projected image. It seems probable that they are of sufficient interest to this Society to justify a brief statement of them and of the degree to which we have been able to meet the requirements.

It will probably not be out of place first to set forth the reasons which are impelling the industry to take a step involving such drastic changes in equipment while it is still struggling with conversion of equipment to permit sound pictures to be made and reproduced. While there may be other reasons, there are two, at least, discoverable by a brief consideration of sound pictures. The first rests on the fact that in the sound-on-film processes part of the area formerly available for the picture now has to be given up for the sound track. The second reason rests on the possibilities inherent in sound pictures which were lacking in the silent pictures of presenting entertainment more of the nature of spoken drama of the stage. Although the second of these conditions leads to a demand for a larger picture area, the first results in an actual decrease in picture area.

As soon as speech was added to the picture it was found that the picture area did not allow enough characters to be included in a scene if the projected images were to appear large enough to be commensurate with a sufficient volume of sound. The effect of a series of conversations between two or three characters appearing in a small, practically square frame in the remote distance is dis-

* Scientific Bureau, Bausch & Lomb Optical Co.

tinctly not entertaining after the novelty has worn off. Further, the producers are ambitious to attempt to record the stage settings as well as the music of opera and musical comedies.

To meet the situation it is necessary to project a picture in which the figures remain of a sufficiently large size but which includes more of them. This means, obviously, a wider included angular field of view and a larger projected picture.

To accomplish this, two methods of attack occur at once. One method would consist in moving the camera farther from the set or in using lenses of shorter focal length thereby reducing the size of the images of the individual components of the set and permitting more of them to be included. Now, if this picture is projected through a projection lens of sufficient power to restore the figures to the customary size on the screen, a much larger total picture size will result. It will be larger in height as well as in width. Since we are only infrequently interested in any great amount of space above the heads of the human figures in the set we would be embarrassed with this superfluous space, in general. It would be possible, however, to reduce the frame height, let us say, to the point where its relation to the height of the human figures was restored to something like what we have been accustomed to. Now this all sounds very good. Several more frames, possibly twice as many, could be recorded on a foot of film; film consumption would be decreased and film magazines reduced in size or else hold a much longer record.

This procedure, however, is impractical, first because the resolving power of photographic emulsions of adequate speed is insufficient to permit a satisfactory screen image to be obtained by such a process. Graininess would be very pronounced and detail would be lost. It would, furthermore, be impractical in the present state of development of the optical systems employed in the sound-on-film processes since it would be impossible to get a satisfactory reproduction of sound because of the loss of high frequencies. Finally, it is not at all sure that such a picture could be projected with anything like a satisfactory degree of brightness.

A modification of this solution was demonstrated at the meeting of the Optical Society of America at its meeting in Washington in November, 1928, which is interesting enough to justify examination. You have probably all observed that if you hold a telescope of any kind before your eye in a reversed position all objects seen through it are apparently reduced in size and look more remote. If you hold

a telescope before the lens of your camera you will be able to observe the same effect on the ground glass. If the telescope be held before the camera lens in its ordinary operative condition the image on the ground glass will be larger than the image formed by the camera objective alone. To be more specific, if we hold a 2X Galilean telescope in front of the camera lens with the objective lens of the telescope facing the camera as shown in Fig. 1 the size of all the individual details in the image on the ground glass will be just half as large as they are without the telescope. If you try this experiment do not be surprised, however, if the total image fails to cover the whole ground glass area; the ordinary Galilean telescope optics serve only to demonstrate the principle but will not give results of any value. Provided, however, the optical system was satisfactory we would have achieved a result identical with the result we might

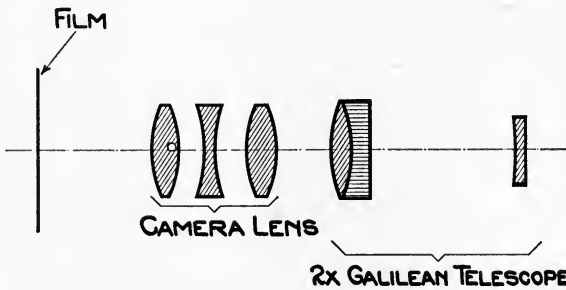

FIG. 1. A photographic lens to which a 2X Galilean telescope is added to reduce the focal length to half of its original value.

have obtained with a new camera objective of just half the focal length of the original. You will remember that this is one of the expedients mentioned a moment ago for increasing the angular field of view. The proposal under examination, however, is unique in that instead of lenses with spherical surfaces it employs lenses with cylindrical surfaces so that the added telescope, if we may still call it such, has magnifying power in one direction only, while in the direction at right angles it has no optical effect at all. If such a system be added to a camera lens it will have the effect of apparently altering the focal length of the latter in one diameter while having no effect on focal length in a second diameter perpendicular to the first. If the added system be located such that its active plane is horizontal we would be in effect taking a picture through a lens of,

let us say, two inches in the vertical plane and one inch in the horizontal. The result would be that all vertical lines would be brought closer together and more space could be covered in the horizontal plane while the height of the figures would be normal for a 2 in. lens. The image on the film would be a very unusual looking image but projected through a projection lens with a similar added cylindrical system it will be restored to normal proportions and theoretically the projected picture would give no indication that it has been subjected to such unusual treatment.

If an optical system of this type could be designed to work satisfactorily in respect to speed and image quality, a task bristling with difficulties, it would overcome the difficulty mentioned earlier of poor sound reproduction and it would probably be somewhat easier

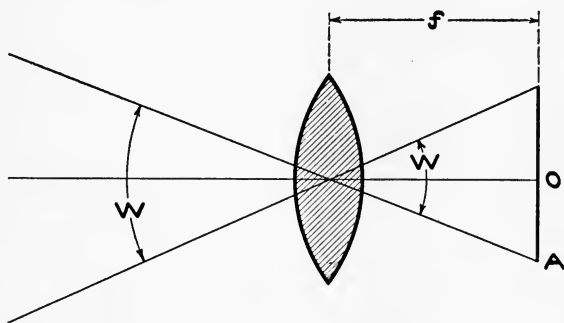

FIG. 2. Illustrating the meaning of the expression "angular field of view." AO/f equals tangent of one-half of angular field of view.

from the illumination standpoint. From the standpoint of image quality, however, even neglecting the effect of aberrations in the added system itself it is not obvious that we would obtain results of any better quality than we would secure by photographing with an ordinary photographic lens of correspondingly short focus and projecting with correspondingly higher magnification.

We would, to be sure, have the great reduction in photography and the extraordinary magnification in projection in the horizontal plane only instead of in all directions but it does not seem likely that this would reduce in any appreciable degree the difficulties due to grain and limited resolving power of the film.

The successful application of the methods previously outlined imposes problems on both the lens designer and on the emulsion

maker. There is one possibility, however, which leaves the film manufacturer free from embarrassment in so far as his emulsions are concerned but which still depends for its success on the lens designer. The method referred to consists in enlarging the picture area without changing the focal length of the lenses. This, translated in optical language, calls for both photographic and projection lenses of larger field of view. For the sake of any who may be unfamiliar with the meaning of the term field of view it may be well to explain that the quotient of half the diagonal of the picture area divided by the focal length of the lens is the tangent of half the angular field of view.

Referring to Fig. 2, $\frac{AO}{f} = \tan \frac{w}{2}$ where f is the focal length of the lens and w is the angular field of view.

The commonly used focal lengths in motion picture practice run from 40 mm. to 150 mm. Lenses both shorter and longer are used on occasion but not frequently. The following table presents the values of the angular fields of view demanded by three different picture areas for lenses within these limits.

Table of Angular Field of View

Focal Length of Lens	19 × 25 Mm.	Picture Area 18 × 36 Mm.	23 × 46 Mm.
40 mm.	42° 52'	53° 24'	65° 28'
50	34 52	43 50	54 26
75	23 38	30 02	37 50
100	17 50	22 46	28 50

Beyond doubt the most popular lens in motion picture photography is the 50 mm. lens. On standard film the field of view covered is slightly less than 35°. For the 23 × 46 mm. picture area the field covered is practically 54½°. This is not by any means an unheard-of angle in lenses of relative aperture of $f/4.5$ or even $f/3.5$ but no photographic lens appeared to be available with sufficient speed and satisfactorily sharp definition to cover a picture size 23 × 46 mm. at the time this size was first attempted. I am happy, however, to announce that I have been able to design a 50 mm. lens of a relative aperture of $f/2.3$ which covers this area very satisfactorily. An attempt has been made in Fig. 3 to indicate the quality of its performance. To cover the field with lenses of longer focal length is a task of less difficulty, but here one must guard against a deteriora-

tion of general definition due to residual aberrations which become the more noticeable the longer the focal length.

Now, it would not be strictly necessary for the production of the wide film pictures to have lenses as short as 50 mm. in focal length. If the distance from camera to set could be chosen at will, any given area which can be photographed with the desired reduction on a film of given size can be photographed at the same scale of reduction on a film of the same size with a longer focus lens. Two obstacles present themselves however; first, the distance from camera to set becomes too great involving excessive expense in studio space and, second, the perspective of the view becomes flatter. The latter might be overcome by a different arrangement of the set but this

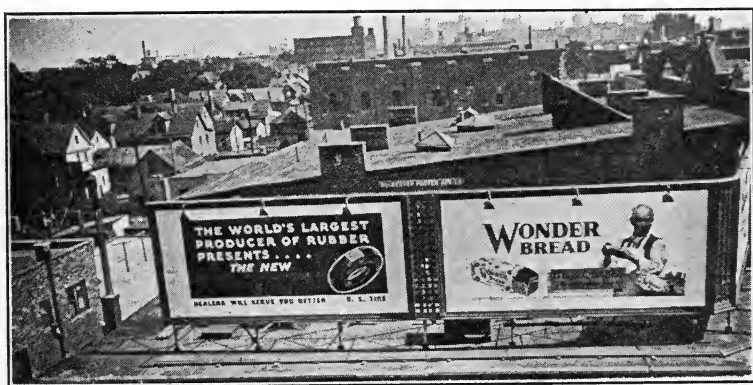

FIG. 3. Reproduction of 23 mm. \times 46 mm. shot made with 50 mm., $f/2.2$ Raytar lens.

again involves increased expense as compared with the possibility of varying perspective by the simple process of selecting the camera lens of most appropriate focal length.

After the pictures have been taken the problem of projection offers difficulties in illumination and in finding a projection lens competent to project them with satisfactory definition.

It is obvious that if the same amount of light which passes through the aperture of the film gate in an ordinary projector be spread over a screen area twice as large the illumination of the screen image will be only half as great. If a pair of ordinary $4\frac{1}{2}$ in. condensers and high intensity arc be employed in their usual adjustment it will be found impossible to illuminate an area 23×46 mm. The illuminated

area in the plane of the film is not large enough. The size of the illuminated area can be increased, however, by reducing the distance from arc to condenser. An adjustment can be found in which the spot at the film gate will be large enough to circumscribe the 23×46 mm. rectangle. Such a condition is represented in Fig. 4. It is obvious that much light will be intercepted by the film gate, but still the illumination will be greater than we might expect as a result of comparison of screen image sizes. In reducing the distance from arc to condenser we have increased the amount of light picked up by the condenser and we are not limited entirely to the light flux which

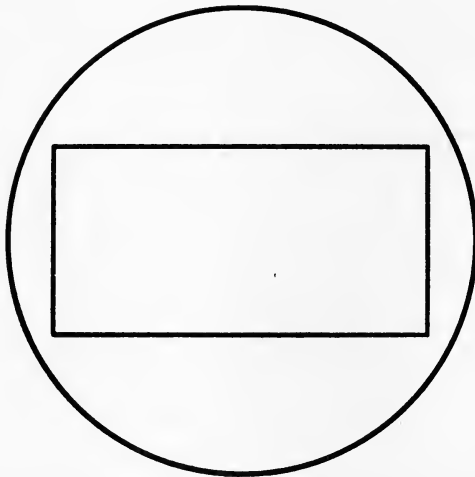

FIG. 4. Ordinary round spot projected on the plane of the film showing great loss of light for pictures of 1:2 ratio of height to width.

passed through the aperture in the film gate while we were projecting ordinary 35 mm. film.

The old $4\frac{1}{2}$ in. diameter condensers with the high intensity arc, however, did not exhaust the possibilities of the projection lens in respect to its angular aperture. One obvious means of increasing illumination, therefore, lay in employing condensers of larger converging angle. Since the approach of the arc to the condenser cannot be carried on indefinitely this led at once to larger condensers. We found it possible to obtain a marked increase in angle with condensers of 6 in. diameter with aspheric surfaces, of course. A substantial increase in illumination resulted.

Some additional illumination, however, is possible by using an astigmatic condenser, one whose focal length in one meridian is shorter than its focal length in the other principal meridian. Such a condenser can be realized by employing one cylindrical surface, as we have done for several years in one of our ophthalmic instruments, or by employing a toric surface. Such a condenser will yield a spot of light in the plane of the film such as is shown in Fig. 5. A preliminary investigation subject to possible correction indicates a gain of something like 25 per cent obtainable in this manner.

If, now, the arc be run at something like 150 amperes with condensers as described above a satisfactory illumination will be found possible. It still remains a question as to just what degree of illumination will be required. It is possible that the relatively enormous

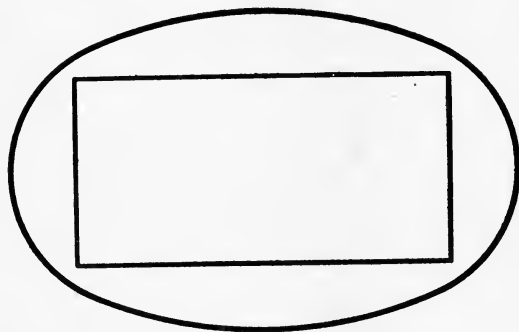

FIG. 5. Elliptical spot of light results in less loss by interception than in the case of a round spot.

picture on the screen may prove more satisfactory at a level of brightness lower than we have been accustomed to in the smaller picture. Certainly, a projected picture of, say, 23×46 feet illuminated as brightly as some of the news reels we see might be expected to raise the general illumination of the theater to an undesirable level.

For the projection of the pictures ordinary projection lenses are entirely out of question except in the longest focal lengths because of objectionable curvature of field. It happened that I had been working on an improved form of lens for the shorter focal lengths for the projection of ordinary film when the demand came for lenses to project the large pictures. The design had progressed to the point where it was possible to offer lenses of 4 in. equivalent focal length

and of a speed of $f/2.2$ which projected a picture 23×46 mm. with satisfactory results. Since then it has been found entirely possible with lenses of 3 in. focal length. These lenses are, of course, anastigmats.

For the benefit of those who may have seen the demonstrations, I might say that both the Grandeur Film shown at the Gaiety Theater in New York and the earlier demonstration by Paramount Famous Lasky were for the most part accomplished with the aid of the optical developments described above.

SOME PRACTICAL ASPECTS OF AND RECOMMENDATIONS ON WIDE FILM STANDARDS

A. S. HOWELL AND J. A. DUBRAY*

THE DESIRABILITY OF WIDER FILM

Modern motion pictures, and especially motion pictures synchronized with sound, have of late brought about a new problem bearing within itself as far reaching consequences as any problem the industry has had to face since its advent. We refer to the obviously insistent demand for a complete departure from old established standards and the creation and establishment of picture images of more appropriate size and proportions.

The problems which are a consequence of such a change are, in our estimation, so vast and so vital that we consider it essential to present to this Society an analysis of the principal factors involved—psychological, artistic, technical, and economical, and to propose a definite recommendation on the course which, in our estimation, it is the most logical to follow.

Sound pictures of the sound-on-film systems have altered the size and shape of the screen. From a rectangle whose sides were in the ratio of 3 to 4, the screen image has become almost square. It has assumed a shape which not only presents no advantage whatsoever over the rectangular shape, but which imposes doleful aesthetic limitations upon the artisans of the screen. The natural consequence of this situation is retrogression in artistic expression and rebellion on the part of the final judge, the public.

We purposely use the expression, "rebellion," because it is supported by the fact that, for perhaps the first time in the history of motion pictures, a number of exhibitors and at least one of the greatest distributing and exhibiting organizations in America have taken matters into their own hands and have reduced the height of the projector aperture. They have considered it essential to maintain the rectangular form of the screen even at the risk of

* Bell and Howell Camera Co., Chicago, Ill.

cutting off parts of the heads of the performers, or some detail at the lower part of the picture area essential to the story and part of the general scheme of composition. Such procedure *is* rebellion and, what is more important, it is, seemingly, justifiable.

We do not want to impose upon you a long dissertation on the reasons which sustain the preference accorded the rectangular shape of picture in pictorial representations. Volumes have been written on this subject. The psychological, metaphysical, and physiological effects and influences that a certain form may have upon the mind and eye have been analyzed and discussed from the point of purely aesthetic considerations following complete and detailed investigations based upon undeniable scientific axioms. The deductions derived from such analyses have been invoked not only as proof that a rectangular form is the most logical to adopt for pictorial representations, but also have led to the establishment of a definite ratio of 3 to 5 as the dynamic ratio between the sides of the rectangle. This ratio has been called the "Golden Rule" of design proportion. It is pertinent to this Society to consider the influence exerted by these conclusions and their applications to the motion picture screen.

The main function of motion pictures is to give a faithful reproduction of life. It is true that incidents are dramatized, that more emphasis is given to details, that outdoor scenes are selected with an eye to scenic beauty, and that interiors are always chosen, dressed and decorated in accord with the general theme of the story and the personalities of the characters which are the human elements representing what we would call an exaltation of emotions. However the exposition of this essence of life through motion pictures demands truth of presentation and naturalness in even its most minute details.

An ideal motion picture production is one which causes the onlooker to forget his own personality and make him *live* with the characters of the story and in their ambient. If this psychological effect is not reached, the picture is classed as indifferent, if not entirely bad.

One of the most important reasons which make us declare the square form of the screen objectionable is the fact that the eye in its continual horizontal motion is constantly and unnaturally arrested by the black nothingness at each side of the screen. This barrier, which abruptly arrests the natural horizontal sweep of the

eye, has an effect entirely opposite to that which the motion picture artist strives for, and is much more disturbing than the arresting of vision which takes place in the vertical direction.

Motion pictures are portrayals of life which can be analytically expressed as figures in an ambient and in which the figure plays the most important part.

A study of our artistic heritage left to us by the masters of design will vividly bring forth the proof of the care taken by the artists to stress the points of interest in a horizontal area. We have selected for demonstration only two sketches, taken at random from



FIG. 1. "The Colonel," a pen and ink sketch in which the center of interest is contained in a 3 by 5 rectangle.

the illustrations of a work on figure composition by the Honorable Richard Hatton. A sketch is usually most representative of the inspiration of the artist since it is executed without taking care of the minute technic usually displayed in a more finished work.

Fig. 1 shows a pen sketch, the title of which is "The Colonel." The artist has placed the entire emphasis on the head of the subject. The shoulders have been given less attention and the rest of the figure is merely outlined. The whole is extremely pleasing and unconventional and our attention is forcibly brought to the upper part of the sketch. If we trace an imaginary line joining the points A and

B, we find that the center of interest is composed within a rectangle whose sides bear to each other the ratio 3 to 5.

Art has no age and we find that even at the very time when the world was emerging from the retrograding influence of the Dark Ages, the psychological influence of the horizontal sweep was recognized by the masters of the epoch, as is strikingly proven by the etching by Hans Burgmair, illustrated in Fig. 2. Here the artist has grouped his figures in as compact a group and in as limited space as the subject and his conception of it would permit; but through a remarkably fine arrangement of the lances which forces the eye to follow a natural horizontal sweep, he injected into its compo-

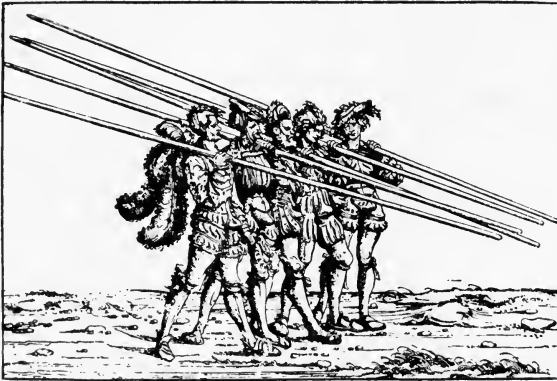

FIG. 2. An etching by Hans Burgmair which illustrates a natural horizontal sweep for the eye.

sition that intangible something which spells Space, Breath, Movement, Life.

These two examples have been chosen for their apparent contradiction between the nature of the subjects and their relation to a rectangular frame form. We could multiply these examples *ad infinitum*, but we should then lead our minds too far from our subject, Motion Pictures. It will be sufficient to remark that since, in life, motion usually takes place in a horizontal direction, our sense of vision is much more accustomed to a horizontal than to a vertical sweep.

Since motion pictures are a true representation of motion, it is essential to provide a sufficient and adequate horizontal breadth to the screen, image in order to approach more nearly the condition

that the human eye meets in real life. It is only when this condition is satisfied that pictures of life and action will be presented in their most natural form.

No definite reason can be traced which will explain why the present 3 to 4 ratio has been chosen as the standard for the motion picture frame size. Perhaps space consideration in the small theaters which were exhibiting motion pictures in the early days was the deciding factor in the matter.

Since the time when motion pictures emerged from their chrysalis and made serious attempts at art, the artisans of the screen have constantly been striving to make the best out of a rather irregular situation. One of their constant cares has been to fill the foreground. The era of silhouetted objects in the foreground arrived. A piece of furniture in an interior, a pile of stones, a hedge or fence in an exterior, served the purpose which can, at the end, be analyzed as an effort to elongate the screen in a horizontal direction. Dark, heavy masses across the lower part of the screen will force the eye away from them and limit its field of vision within the brilliant area of interest, usually covering approximately two-thirds of the upper part of the screen.

These expedients were very cleverly resorted to and at times taken advantage of with characteristic boldness and very fine results. They were, nevertheless, expedients, and when talking pictures came to annihilate the already scanty resources which were at the disposal of the artists of the screen, a cry of protest arose, especially from cinematographers and art directors, who were most affected by the new state of things.

Directors and producers felt keenly on the subject and sympathized with cinematographers and art directors. Directors needed a greater freedom of action and new means through which they could tell the story in a much more natural way by properly developing the new technic of talking pictures and arranging the balanced distribution of dramatic points of interest. Producers realized the fact that motion pictures cannot survive if not presented to the public under the most favorable conditions of technical and dramatic perfection.

Other factors besides the psychological and artistic considerations thus far expressed must be taken into consideration.

We are convinced that everyone having some knowledge of the technicalities of motion pictures agrees with the fact that a change

in screen size and proportions cannot be satisfactorily brought about by reduction of the picture area, but involves, on the contrary, its increase. It would perhaps require too much time and be too tedious to enumerate here all the quite obvious technical reasons which lead to this conclusion.

What is perhaps less well known are the problems that the directors of photography encounter in that all-important phase of their work which relates to the lighting of motion picture sets. The square, or nearly square, shape of the picture area has been the cause of building sets of height disproportionate with their width and depth. The back lighting effects, which are so essential to a rendition of pleasing roundness and relief in the finished picture, and which are obtained by placing spotlights at strategical points high up on the set, have always presented serious problems to the cinematographer, due to the excessive height of the sets themselves. On many occasions the so-called back lightings are nothing less than top lightings which have to be corrected with painstaking and difficult manipulations of the floor lighting system. The architects of the screen are also confronted with serious and, we might say, unnecessary problems in the design of the composition of the decorative schemes.

And so on down the line through the legion of those responsible for the artistic presentation of pictures, the square shape of the screen is considered as a stifling curse which limits the possibilities of expressing beauty and harmony.

The demand for a change in the proportions of the screen is not a mere desire to give the public a "bigger show," as has been stated at times, but is, in our estimation, one of the most striking and significant steps in the evolution of the motion picture art.

PROPOSED FILM DIMENSIONS AND PROBLEMS PERTAINING TO THEIR ADOPTION

It is very obvious that an alteration in the proportion and size of the motion picture image creates complex problems which involve all branches of the motion picture industry and which are of such nature that they demand the close attention and coöperation of all allied industries. The reaching of definite conclusions in regard to this new development must follow a very definite plan, worked out in complete detail as to the technical problems involved, and with a perfect understanding of the economic condition created. It is necessary that the plan can be met not only by the motion picture industry as a producing unit, but also by the exhibitors

of motion pictures, in such manner as to insure the endorsement of the public.

It is in consideration of these factors that the Bell & Howell Company, conscious of the responsibilities of the motion picture industry toward itself and toward the public, has conducted a painstaking investigation of this vital question. It has derived from it some definite conclusions which have led to the presenting of three dimensional proposals.

Departing from the commonly accepted routine, we shall first

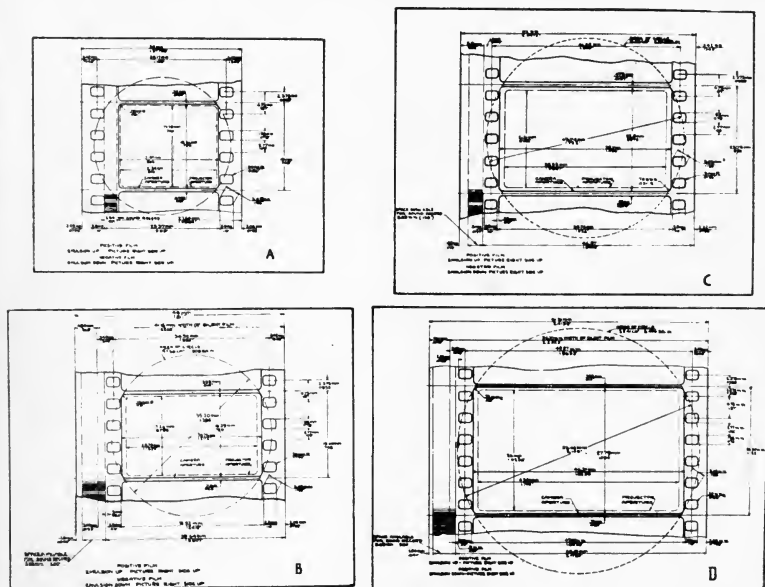

FIG. 3. Proposed dimensions of wide films compared with the 35 mm. standard. (A) 35 mm. film. (B) "Economic." (C) "Spectacular." (D) "Extreme."

present our recommendations and afterward detail the reasons which have led to them. To facilitate the discussion, we shall distinguish the proposed dimensions as follows: (A) the "Economic;" (B) the "Spectacular," and (C) the "Extreme."

The "Economic" has been so named because its adoption would involve a minimum of expenditure of both time and capital for the necessary alterations and developments of the apparatus in use throughout the motion picture industry.

The "Spectacular" is so called because it presents greater possi-

bilities than the "Economic" in the matter of refinement of execution, and lends itself to a more spectacular presentation of pictures. The expenditure involved in the adoption of this dimension as standard would be far greater, perhaps three times the expenditure necessitated by the adoption of the "Economic."

The "Extreme" is so designated because its adoption would involve extreme expenditure of time and money in its development. It would require perhaps four to five times the expenditure involved in the "Economic," and it would present extreme, perhaps excessive abuses in exploitation without accomplishing any great advantage over the "Economic."

Fig. 3 shows, in one illustration, for the purpose of comparison, the three dimensions and their characteristics together with the standard film in use today. The most apparent features which are common to each of the three proposed dimensions are:

1. The sides of the rectangular images are in all instances in the ratio of 3 to 5 in opposition to the 3 to 4 ratio in force according to the present standards, and also in opposition to the 3 to 3.5 ratio of the present standard 35 mm. sound-on-film pictures.
2. The position of the sound record is outside of the film perforations.
3. The dimensions of the perforations are the same for the three proposed dimensions and are equal to those of the standards in force.
4. The rectangular perforation with rounded corners is recommended for both negative and positive films.

The proposed dimensions differ from the existing standards in that the over-all width of the films and of the picture frames is greater than the same dimensions adopted for the standard 35 mm. film. In the case of the "Spectacular" and the "Extreme," the height of the image is increased so as to answer the condition of the 3 to 5 ratio between the sides of the image area. These dimensions will be analyzed in detail later on in the course of this paper.

It will be noticed that the pitch and all other dimensions of the film perforation have been kept equal to the standard 35 mm. in force at the present time. This feature permits reducing to a minimum the problem of sprocket design for all motion picture machinery and permits the industry to take full advantage of the knowledge it possesses of the behavior of film in regard to shrinkage. This laboriously acquired knowledge has formed the basis of long,

painstaking, and complete investigation, upon which the shape, thickness, diameters, and gauges of sprockets and teeth design have been based.

We do not believe that the increased width of the film, at least for two of the proposed sizes, will demand an increase in its thickness. This thickness should remain according to the adopted standards of 0.006 in. or 0.1524 mm., since the proposed dimensions are within the accepted tolerances pertaining to the relation existing between critical width, critical length, and critical thickness of the film.

This is an all-important consideration, not only because of the fact that an increase in film thickness would necessitate a long and exhaustive research on its shrinkage characteristics, but also because of the fact that an increase in thickness would present serious problems for the correct registering of the sound record on film, because of the more pronounced and extended halation fringes which would be produced by the inevitable reflections of light from the back surface of the film base. These characteristic halation fringes have proven at times to be the cause of distortions in the reproduction of sound, even when using the 35 mm. film of standard thickness.

The recommended form of perforation is the rectangular with rounded corners, for both negative and positive film, because it will permit the marginal guiding of the film (which, incidentally, will take place on the sound record side) to be controlled at the lateral faces of the perforations independently of the edges of the film.

This perforation control is to be preferred to the edge control used today because it will greatly reduce the possibilities of even the slightest error in registration. The guiding of the film by the perforation faces will permit what we may call a "unit control" for all machinery used in perforating, photographing, printing, splicing, and projecting. This control will be practically independent of the shrinkage that the film suffers during the laboratory processing operations. The advantages of such control are quite obvious. We would mention that it would prove invaluable in color processes and that in sound printing and reproducing it would afford a more assured control of the possible side motion of the sound record. A change in film size would necessarily involve mechanical reconstruction of all motion picture apparatus. Therefore, a com-

plete change in the standard shape of the perforation could be made without extraordinary inconvenience to the industry.

The sound record is located, for all proposed dimensions, outside of the perforations, because it may be found advisable in future times, for economical and mechanical reasons, to use in the photographic camera negative films of a width narrower than that of the finished prints—a width sufficient to include only the picture record to the exclusion of the additional width of the sound record. This would be in accordance with the practice of photographing the sound record independently and with different apparatus than that used for photographing the picture record.

The placing of the sound record outside of the perforations has also the important effect of reducing to a minimum the distance between perforations and guide control rails, thereby providing better support for both the picture and the sound records.

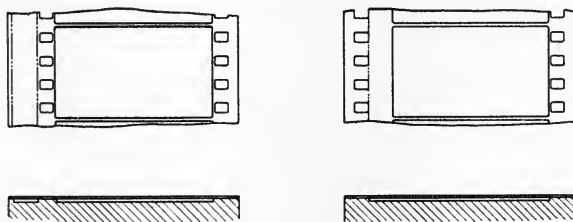

FIG. 4. Film support in regard to position of perforations.

Fig. 4 represents such a condition. Where the perforations are situated near the edge of the film, the film itself is unsupported for a greater length, as shown in the section, than is the case where the perforations are located nearer each other. It is quite obvious that the greater the gap between the two supporting points, the greater are the possibilities for the film to bend or curl out of the position of essential flatness, which must necessarily be kept within extremely small tolerances.

Up to the time of writing of this paper, it was quite evident that the sound engineers engaged in research and development activities were quite undecided and reluctant about expressing themselves with regard to the best arrangement for the sound record. This was evidently due to the complexities and the large number of factors involved in the problems which were presented to them for solution. It seems logical, however, to reach the conclusion that a longer sound record per picture area would permit the recording

of higher frequencies than is possible on the present standard sound record length. It is also quite apparent that a wider sound record would permit an increase in the volume of sound during reproduction.

Increases in the length and the width of the sound record involve, indeed, many problems and considerations which we hope will be brought to the attention of this Society. We may, nevertheless, mention that the advisability of separating the sound record from the picture record, not only during the process of recording but also during that of reproducing in order to record higher fre-

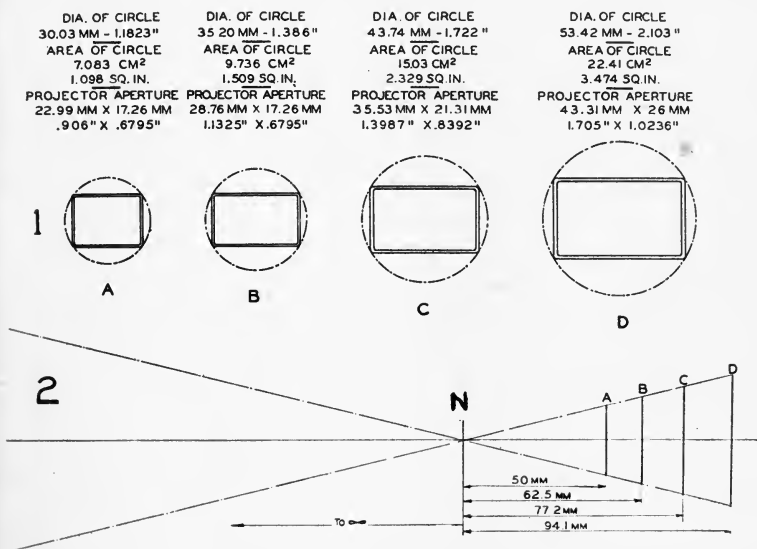

FIG. 5. (1) Area of aberrationless covering power of photographic lenses required for 35 mm. and larger area films. (2) Focal lengths required to cover larger images compared to a 50 mm. lens with 35 mm. film image.

quencies than those which are obtained today, has been expounded and supported by arguments of both technical and economical nature.

In considering the changes of dimensions in the sound record, Bell & Howell engineers have kept present in their minds the possibility of new developments. The proposed new dimensions and position of the sound record offer the advantage that such alterations, in either the direction of expansion or contraction, would require but little, if any, mechanical modifications in the apparatus constructed according to the new proposed standards.

Since we are at the present time in the field of generalities, it may be appropriate to survey the problems pertaining to the photographic and projection optical systems.

In Fig. 5 (1) are shown at B, C, and D, the areas of aberrationless covering power that a photographic objective must possess for the three proposed new dimensions, and, at A, for the 18×24 mm. image dimension, which is the standard in force for the 35 mm. film. Both camera and projector apertures have been traced.

Photographic Objective.—In Fig. 5 (2) the photographic objective is represented in its simplest expression, with the point N representing a system in which the two nodal points coincide.

If we consider a lens of 50 mm. focal length, focused at infinity as the standard, since such a lens is the most used in actual practice for an image size of 24 mm. width, we find that:

A 62.5 mm. ($2\frac{1}{2}$ ") lens will embrace the same object space width for the image size of 30.76 mm. width of the "Economic" dimension.

A 77.2 mm. (3") lens will embrace the same object space width for the image size of 35.33 mm. width of the "Spectacular."

A 94.1 mm. ($3\frac{3}{4}$ ") lens will embrace the same object space width for the image size of 46.31 width of the "Extreme" dimension.

If we now take as a point of departure a 35 mm. lens as the shortest focal length lens used in actual studio practice, we find that in order to cover the same object space width we shall use, for the "Economic" dimension, a lens of a focal length of approximately 45 mm., one of approximately 55 mm. focal length for the "Spectacular," and one of approximately 67 mm. for the "Extreme."

This brings to our attention the fact that for the same distance from object to camera, and in order to photograph the same object space width, the wider area film would require the use of lenses of longer focal length than those in use today with the 35 mm. standard film.

This phase of the question is important in regard to the depth perspective of the sets photographed. There is no question in our minds that the use of lenses of extremely short focal length, such as 35 mm., introduces a noticeable and disturbing distortion in the perspective depth rendition of the average motion picture set. It is our belief that the use of, say, a 47 mm. lens, instead of a 35 mm., would tend to add to the beauty and naturalness of the picture.

It is well known that studio practice requires that all scenes pertaining to one single sequence of a talking picture be photo-

graphed simultaneously with a battery of cameras, equipped with lenses of different focal lengths. This arrangement permits the taking of all long shots and close-ups with a single setting of microphones and simultaneously synchronizes all the picture records on a single sound record.

The cameras equipped with the shorter focal length lenses which are used for the photographing of the "long shots" are more concerned with the width of the object than with its height. *Vice versa*, the cameras equipped with the lenses of longer focal length and used for the taking of the close-ups are more concerned with the height than with the width of the object. In other words, the long shot cameras photograph the ambient, while the close-up cameras photograph the performers.

For the long shots, and for reasons previously expressed, lenses of a focal length greater than those in use for the 35 mm. standard will prove more adaptable in the photographing on larger area films, since they produce better perspective and a better relation between the size of the figures and the ambient. On the other hand, it must be borne in mind that the height of the proposed wide films is either the same as that of the standard 35 mm. film or not increased proportionately to the increase of their width. Therefore, in the photographing of close-ups, where only the height of the subject is to be considered, practically to the exclusion of its width, and where the height is to be determined only by a sense of pictorial composition, lenses of the same, or nearly the same, focal length as those in use with 35 mm. film will answer the cinematographer's requirements.

The practical range of focal lengths used with the standard 35 mm. film varies from 35 mm. to 150 mm. In order to obtain the same image width in the long shot and the same composition of figures in regard to height in the close-ups, lenses of the following approximate range of focal lengths will be used for the larger area images:

47 mm. to 150 mm. for the "Economic"

55 mm. to 190 mm. for the "Spectacular"

70 mm. to 233 mm. for the "Extreme"

The advantages derived from the use of a smaller range of focal lengths in photographing the different scenes pertaining to the same sequence are too obvious to be enumerated in detail. We may, however, remark that the smaller the range of focal lengths, the

less noticeable will be the differences in depth of focus, a characteristic of photographic objectives too well known to warrant discussion in this paper. We may also mention that the constant use of an extremely large range of focal lengths imposed upon the cinematographer by the technic of sound and picture synchronization has been one of the causes which have justified general severe criticisms on the photographic quality of talking pictures.

It may prove of interest here to give some consideration to the covering power of the photographic objectives in use today and to consider their adaptability to the proposed new dimensions. Let

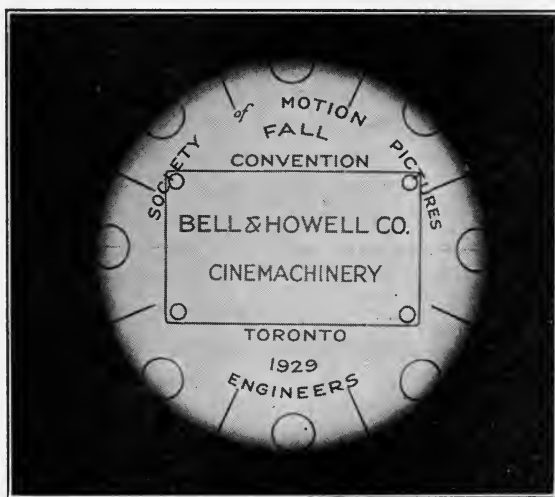

FIG. 6. Covering power of an $f/2.5$, 47 mm. lens.

us take, as an example, a 47 mm. lens and its adaptability to the "Economic" dimensions.

Fig. 6 shows the full area covered by an $f/2.5$, 47 mm. focal length Taylor-Hobson Cooke lens. The actual diameter of the object was 10 ft. and the camera was set 8 ft. 8 in. away from it. The subject was so prepared and photographed that the rectangle traced in the center of the circle was reduced on the photographic plate to the size of the camera aperture for the "Economic." The 8 ft. 8 in. distance from the lens to the object was decided upon for convenience in manipulation, with due consideration to the fact that the diameter of the image area would be only slightly increased over the diameter

which would have been obtained if the lens had been focused upon an object at infinity. It is quite logical to conclude that the lenses of longer focal length which will be used for the "Spectacular" and the "Extreme" dimensions will also answer the requirements of sufficient aberrationless covering power.

Although we are aware of the fact that opticians have been designing lenses for motion picture photography with a reasonable disregard of the aberrations outside of the image portion which is limited by the size of the motion picture camera frame, we also believe that the adoption of any one of the three proposed dimensions would involve no radical change in the present stage of development of motion picture photographic objectives.

The above brief exposition of the use of photographic objectives for film of a greater area than the one used as standard today is, of course, far from being a complete dissertation on the subject. We have merely introduced in this paper this phase of the new development with consideration to studio practice as a corollary to this survey of the wide film situation.

Projection Problems.—The average size of the screen in large auditoriums is 18×24 feet. This size involves, for the standard full aperture of the 35 mm. film, a 320 times linear magnification and approximately a 100,000 times magnification in area. The size of the screen image for this magnification and proposed dimensions would be 18×30 ft. for the "Economic," 22×36 ft. for the "Spectacular," and 27×45 ft. for the "Extreme."

We would mention here that the 320 times linear magnification has been increased approximately 10 per cent, without apparent loss of photographic quality, by a number of exhibitors who have reduced the height of the projector aperture in order to maintain the 3×4 screen dimensional ratio, and have magnified the 21 mm. width of the sound-on-film aperture to the 24 foot screen width.

We do believe that this magnification could be increased still further perhaps up to 400 times, after appropriate projection optical systems and the light source apparatus have been developed, without unduly impairing the appearance of the screen image for the optimum viewing point of the auditorium.

The increase of 25 per cent in magnification would bring the screen image to 22.5×37.5 ft. for the "Economic," 27.5×45 ft. for the "Spectacular," and 33.75×56.25 ft. for the "Extreme." We shall consider this magnification as reaching the extreme per-

missible limits which can be attained without undue loss in image quality, and we shall rapidly survey the factors involved.

It is our first thought that a screen greater in width than 37 feet would be quite distracting to the intimate character of most of the scenes which form the average story telling photoplay.

There is no question in our minds, however, but that some pictures of an exceptionally spectacular nature would be shown to better advantage on the 45 foot screen corresponding to the "Spectacular" dimension. This film width, however, involves a picture height of 27.5 feet, which may be found to be excessive because of the great effort imposed upon the eye by its eagerness to cover rapidly such a large span in a direction opposite to its normal sweep. A reduction in this height of the image would defeat the 3 to 5 ratio between the image sides and would give rise to a hybrid shape, in most cases unpleasant to the eye and difficult to manage artistically, as well as mechanically.

We find ourselves also facing other problems of a more technical nature, which we shall rapidly survey.

Although a greater screen image, as well as the diffusing surfaces of the screens used in the projection of talking motion pictures, broaden the viewing angle in regard to correct distribution of illumination, they also increase the distance of the optimum viewpoint from the screen.

Without entering into a long discussion of this phase of our survey, we shall mention that these factors considerably reduce the number of seats in the front part of the auditorium from which the screen can be viewed under acceptable conditions of good visibility in regard to light distribution of the screen surface and picture perspective. These factors assume serious proportions, especially if we take into consideration the great number of small auditoriums disseminated throughout the country. Furthermore, the greater the increase in size of the film image, the more complex are the problems involved in the design of the appropriate optical system for the projection apparatus.

It is quite obvious that a greater film image area demands a greater condenser magnification. Although we believe that the "Economic" dimension would permit the use of existing condensers, we want to suggest that image sizes greater than this, and especially those as great or greater than the "Extreme" dimension, would demand not only a complete redesigning of the condenser system,

but would even require a greater area of the cathode spot of the projection carbon lamp in order to have the condenser system sufficiently filled by the rays of light emitted by it. This alteration would necessarily require the discarding of all carbon lamps and lamp houses of the projection apparatus in use today.

The above briefly outlined considerations seem to confirm the inadvisability of taking into consideration extremely large film sizes as well as extremely large screen image areas, and seem to suggest a reduction in the accepted image magnification in preference to its increase for the film image of an area greater than the "Economic" or the "Spectacular."

If this course should be decided upon, we would indeed obtain better projection in regard to photographic rendition and screen illumination, and at the same time reduce the problems pertaining to the development of projection optical systems. We wish, however, to state that we do not consider these advantages of sufficient magnitude and importance to warrant the great expenditure of time and capital which would be necessary to bring about the mechanical developments necessitated by the adoption as a standard of any too great film image area.

In further consideration of the optical system of the projector, we may mention that since projection lenses are usually of the Petzval type, and that since the standard picture area of the 35 mm. film is approaching the limit of its aberrationless covering power, the adoption of larger image areas would probably mean a complete departure from the present practice of projection lens design and would demand the development by opticians of projection lenses of the anastigmatic type.

This apparently inevitable development in projection optics applies to any image area greater than the standard area of the 35 mm. film, but would involve only a minor economical consideration, in view of the greatness of the present movement in favor of wider area films.

MECHANICAL OPERATIONS INVOLVED IN THE ADOPTION OF NEW STANDARDS

In the third and last part of this paper we shall consider more in detail the dimensional characteristics of the three proposed picture areas. We shall, in so doing, invert the progression of presentation and consider the three sizes in the following order, first, the "Extreme," second, the "Spectacular," and third, the "Economic."

Fig. 7 illustrates the dimensions of the "Extreme." The proposed height of the picture is 27.79 mm. for the camera aperture and 26 mm. for the projector aperture. The height of the camera aperture corresponds to the sum of the pitch of six perforations less a dividing space between picture frames 0.71 mm. in width. The proposed width of the picture is 46.31 mm. for the camera aperture and 43.31 mm. for the projector aperture. The width of the space available for the sound record is 5.08 mm. or double the width available in today's 35 mm. standard film for the same purpose. The over-all width of the film is 61.31 mm.

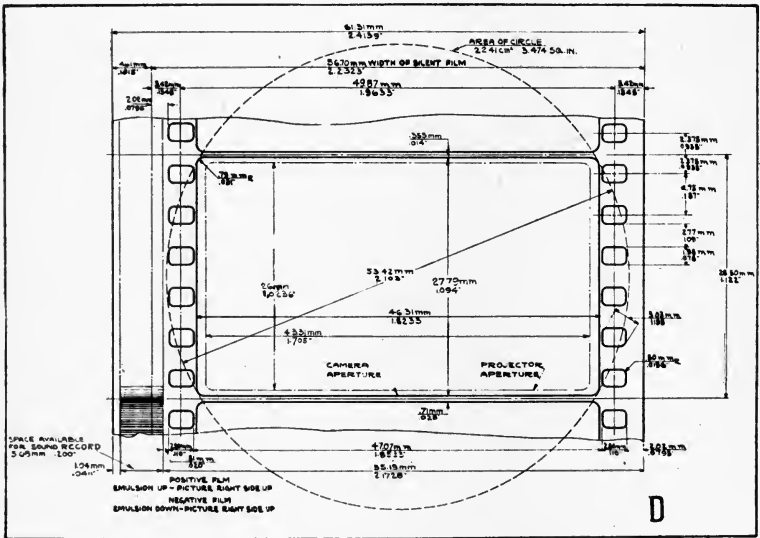

FIG. 7. Dimensions for the "Extreme."

If we consider a speed of 24 pictures per second as the standard, the length of sound record recorded per second would be 684 mm. as compared with 456 mm. for the 35 mm. standard film, or an increase of 1.5 times. It is apparently the consensus of opinion that the frequency which it is possible to record is proportional to the running speed and, therefore, to the length of the sound record. Considering this as a true expression, it appears logical to suggest that the high frequencies which it would be possible to record with the "Extreme" dimension would enhance the quality of sound reproduction.

The possibility of varying the width of the sound record, if future developments in this field should so require, is apparent, as the sound record is placed outside of the film perforations.

With the "Extreme" dimensions here presented, the picture area would be nearly three times the picture area of the 18 × 21 mm. sound standard in use today.

The dimensions of the "Spectacular" film size are illustrated in Fig. 8. It is seen that the proposed height of the picture is 22.8 mm. for the camera aperture and 21.31 mm. for the projector

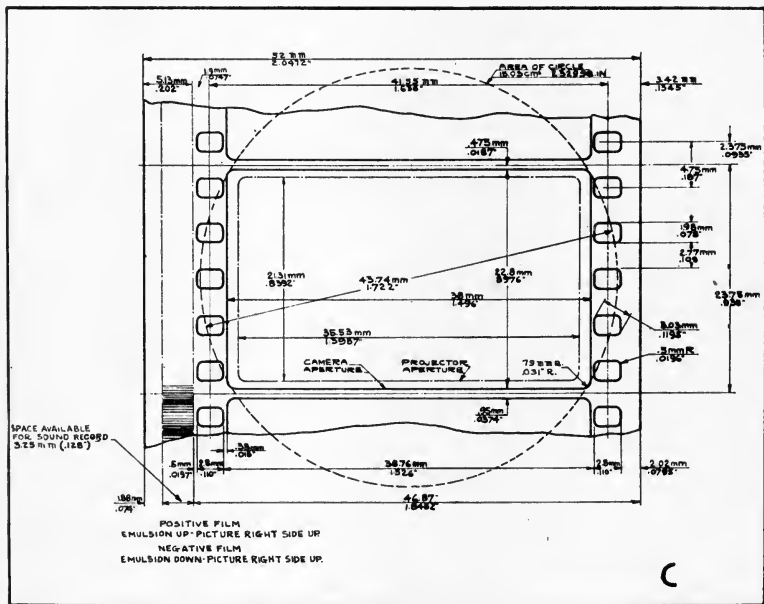

FIG. 8. Dimensions for the "Spectacular."

aperture. The dimension of the camera aperture corresponds to the sum of the pitch of five standard perforations less a dividing space between picture frames 0.95 mm. in width. The proposed width of the picture is 38 mm. for the camera aperture and 35.53 mm. for the projector aperture. The space available for the sound record has a width of 3.25 mm., or a little over 25 per cent more than that of the sound record as used today in the 35 mm. standard film. The over-all width of the film is 52 mm.

Again, the position of the sound record is outside of the perfora-

tions, and if we consider a speed of 24 pictures per second as the standard, the length of sound record registered per second would be 570 mm. as compared with 456 mm. for the standard film of 35 mm. width, or an increase of 1.25 times.

Again, the possibility of varying the width of the sound record for further possible developments is apparent.

Both these dimensions, "Extreme" and "Spectacular," and especially the first, would involve, if accepted, considerable expense due to the necessity of bringing about entirely new developments in the different apparatus in use in motion picture production, film processing, and exhibition.

This reconstruction of apparatus would involve complete re-designing of perforators, cameras, printers, developing machines splicers, and all other minor laboratory apparatus, as well as require a reconstruction of projectors, involving extreme developments which could not be devised and put into execution before a considerable length of time.

The "Extreme" proposed dimension, especially, would also present not a little difficulty in the solving of the problems pertaining to film shrinkage and to the evident necessity of maintaining the films in a perfectly flat position at the critical operating point, or area, in all motion picture apparatus.

We would suggest that unless the "Extreme" dimension perfectly meets the sound recording and reproducing requirements not only at the present stage of development, but with due consideration to future possible developments, it should be considered only with a good deal of caution and forethought.

The "Spectacular" dimension, though requiring considerable mechanical engineering development, would nevertheless present some distinct advantages which may compensate for the expense of time and capital involved.

We shall now review the dimensions of the "Economic" proposal which are shown in Fig. 9.

The proposed height of the picture is 18.29 mm. for the camera aperture and 17.26 mm. for the projector aperture. The height of camera aperture is equal to the same dimension standardized for the 35 mm. film and corresponds, therefore, to the sum of the pitch of four perforations less a dividing space 0.71 mm. in width. The proposed width of the camera aperture is 30.76 mm. and the proposed width of the projector aperture, 28.76 mm. For the same

picture height the new dimension is nearly 1.5 times greater in width than the standard film in use today. The space available for the sound record is 5.08 mm. or double the space available for the sound record in the standard 35 mm. film. The over-all width of the film is 46 mm., and the width of the silent film may be reduced to 41.16 mm., should the decision be taken to eliminate the sound record space in the taking of the picture records.

The position of the sound record is, as in the other two proposed dimensions, outside of the perforations, and offers the same ad-

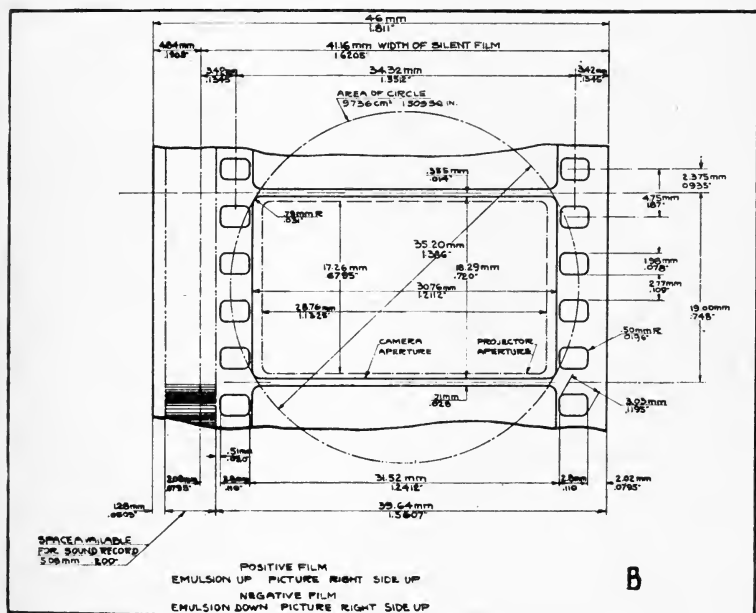

FIG. 9. Dimensions for the "Economic."

vantages in regard to expansion or contraction of its width, as well as to the possibility of its severance from the picture record.

The length of the sound record is, according to this proposed dimension, and always considering a speed of 24 pictures per second, equal to the length of the sound record standardized for the 35 mm. film.

If we are willing to concede that the limits of perfection are near enough at hand in the present system of sound recording on film, then it is safe to say that in order to record faithfully all desirable

frequencies of the sound scale, it would perhaps be necessary to increase the running speed of the film to perhaps three, or possibly four, times the speed at which it would be practical or correct to run the picture.

If this difference actually exists, it would appear that any attempt in the direction of enlarging the film size sufficiently to do full justice to the adequate running speed of the film sound record would necessitate an even greater enlargement of the picture area than the enlargement proposed for the "Extreme" dimension.

At this point of the survey we find it necessary to bring up the points of financial and commercial consideration involved in the question which has formed the subject matter of this paper. Although we do fully realize that commercial considerations are quite incompatible with the work conducted by a scientific and technical society, we, nevertheless, consider that a change in motion picture standards is of such consequence and import that the financial side of the question cannot be overlooked.

We do not think that we would be very far from the truth if we would mention the fact that the partial reconstruction of machinery, in order to adapt it to the "Economic," would represent an approximate investment equal to from 40 to 60 per cent of the value of the apparatus in use, while the "Spectacular" dimension, which would call for duplication of all apparatus already manufactured, would involve an expenditure which we estimate at over 150 per cent of the investment by the industry for the apparatus in existence.

The "Extreme" dimension, due to the engineering developments which would be required, would bring the investment to a figure which we conservatively estimate would be equal to approximately 200 to 300 per cent of the present investment. These figures, which, we hasten to say, are only approximate, are dictated by our own experience in cinematographic matters, and although not based upon actual statistics, we do not hesitate in presenting them for your consideration, since we consider them as nearly an expression of the facts as can be roughly estimated.

Alteration of machinery for the "Spectacular" and especially for the "Extreme" dimensions would mean a complete scrapping of all apparatus in existence. It would involve change of dimensions of all parts, which would necessitate as a consequence the redesigning and remaking of all tools necessary to their production. The

"Economic" would involve increases of dimensions in one direction, width only, which would permit a salvage of approximately 40 to 60 per cent of machinery parts in existence, and permit the use of most of the tools accumulated through the years by machinery manufacturers.

Finally, we wish to bring to your attention the fact that the "Economic" dimension would represent a time saving in getting under way, which we estimate at 50 per cent of the time required to complete the adaptation of the "Spectacular" and 75 per cent for the adaptation of the "Extreme." Engineering developments in motion picture machinery are necessarily slow, due to the research necessary to arrive at perfection of design and manufacture as is required by the extremely reduced tolerances permissible. We estimate the engineering development, necessitated by the "Economic" dimension, could be completed in approximately four to six months. Those for the "Spectacular" would demand from six months to one year, and the "Extreme" would require not less than from eight to eighteen months. This estimate of the time element is expressed only in regard to the engineering development, and not in regard to the time which would be required for a complete change-over within the industry from the present to the new standards. The industry itself will, of necessity, be called upon to determine this factor.

An improvement as radical as a change in dimensional standards must of necessity be brought about with a broad visualization of future possibilities and so completely that it will present a reasonable guarantee of stability for years to come. It also demands that its adoption should not bring a halt or a reduction in the activities of either the production or the exhibition fields.

It is our opinion that the production end of the industry is more concerned with the technical and the spectacular advantages which are to be obtained through the introduction of a new standard, than with the expenditure involved. It is not illogical to consider that the change would handicap and perhaps meet with strong opposition from the exhibitors, especially from those who confine their activities to small theaters. Furthermore, the time element involved in the complete change-over is of special interest to both producers and exhibitors.

It will undoubtedly be found necessary to have recourse to a system of interchangeability between the standards in force and

those which will be adopted. It is difficult to foresee to what extent this problem of interchangeability will be solved. It may be possible that some arrangement be devised in the projection apparatus whereby one machine could be made to be interchangeably adaptable to run both sizes of film, or some arrangement by which one projector could be changed for another of different size with reasonable celerity whenever the program of the show demanded it.

Arrangements of this type would be in order during the time in which the production end of the industry would effect the change-over, and during the time for which 35 mm. films would be distributed.

The complete change-over in the exhibition end will necessarily be a much slower process and will present obstacles the overcoming of which may appear too great a task to many less aware than we are of the resourcefulness of the engineers of the screen.

We venture to say that the solution of these problems may lie in the development of optical reduction printing processes in order to make possible the distribution of films to small theaters. As an example we may mention that if the "Spectacular" dimension should be chosen as standard, the negative image could be so reduced in the prints as to include four perforations only in its height.

This reduction of the image height would call for a 25 per cent reduction of the sound record, which seems at first thought to possess possibilities of execution.

CONCLUSION

In consideration of all the factors of an artistic, technical, and economic nature pertaining to a change in film dimensional standards which have been merely outlined in this paper; in consideration of the fact that a change of film dimensional standards is conceded by the industry to be a necessity for the fitting survival of motion pictures; and also in consideration of the fact that such change will affect all branches of the industry in America as well as abroad; we consider it the duty of this Society to take upon its shoulders the responsibility of standardizing development.

We propose that a special standing committee, which would include representative members of all branches of the motion picture industry, as well as members of all recognized technical and business associations within the industry, be immediately formed, and be given power and authority to discuss and make definite decisions in regard to the creation and adoption of a new standard.

Further, the Bell & Howell Company is prepared to present to such a committee, and in a comparatively short period, a finished film of any standard which may be agreed upon, so that a visual presentation to, and further discussion with, producers and exhibitors may be possible.

It would be pertinent for this committee to devise the means by which the financial burden of the investigation could be equitably distributed within the motion picture industry as a whole. We feel sure that such a committee would be in position to secure all the necessary moral and material coöperation that would be needed because of the far reaching importance of this subject, upon which depends the stability and longevity of the motion picture industry throughout the world.

DISCUSSION

MR. HEISLER: (Communicated.) There seems to be no objection to placing a sound record track outside of the sprocket holes, when considering only the making of sound records and pictures. It may be well, however, to consider this proposed location of the sound record track with respect to reproducing sound.

When a film passes through a combined picture projecting and sound reproducing machine, each sprocket hole comes into active engagement with sprocket teeth perhaps no fewer than four times. This may be repeated in theater service several times daily. Consequently, the relatively soft and very thin film edges in the sprocket holes soon suffer mutilation and wear, and many times are torn, particularly when the picture aperture gate pressure is not properly adjusted. The thin perforation contact edges frequently are burred or lifted several mils above the plane surface of the film. Old films often have several holes torn out in the sprocket hole path. Frequently the narrow film border outside of the holes is notched, cut, or torn away.

The periphery spacing between the teeth on sprocket rollers is usually milled below the film contact circumference, but often not. Sometimes this surface is too high, consequently it can never be used as a film supporting surface. Because of this, the only support for the sound record track on the proposed wide film standard is the very narrow film surface at its extreme outer edge and that disposed directly inside of the sprocket holes and outside of the picture frames. The consequence is an objectionably excessive unsupported overhang for the sound track when an imperfect outer edge does not provide a proper support.

Since films often crack from sprocket holes outward, the sound track of the proposed arrangement would not only be mutilated but would also be improperly supported.

To correctly reproduce sound, it is absolutely essential not only to provide perfectly uniform motion of the film lengthwise, but we must also prevent the slightest film movement in a direction perpendicular to its surface as well as a weaving movement edgewise. The latter should be held within two mils and there should be no perpendicular movement exceeding one-half mil, preferably much less.

Even with the present 35 mm. film having the sound track disposed inside the sprocket holes, and relatively well protected and supported, much difficulty is experienced in obtaining the necessary degree of refinement in the motion of the film through a microscopic light beam. Careful consideration should therefore be given any proposed change of sound track location which will not provide equally ample or better means for proper support and safeguard against the slightest mutilation and irregularity of motion. This is now possible on correctly designed sound reproducing machines when locating the sound track inside the sprocket holes. If, however, the track were located outside of the sprocket holes, it would be impossible for reasons given. We would therefore be taking a step backward in the development of such machines.

Because of the foregoing, perhaps it would be well to hesitate in changing the location of the sound path from the inside to the outside of the sprocket holes. There seems to be no possibility of trouble coming from a slightly wider spacing of the sprocket hole path.

MR. DUBRAY: (Communicated.) Mr. Heisler is apparently justified in objecting to the arrangement of the sound record outside of the perforations.

We wish, however, to remark that Mr. Heisler's contentions are mainly based upon the performance of existing apparatus, while the adoption of a new standard in film dimensions would necessarily call for a complete redesigning of the projection machine. This would give the mechanical engineers the opportunity of devising adequate means for the proper support and registration of the sound record.

We wish also to state that we do not quite agree with Mr. Heisler's statement that with the sound track inside the perforation, as in the present practice, all the objectionable points are entirely eliminated. The mutilation of the perforation due to excessive pressure on the sprocket tooth is nearly always equal in both directions and tends to mar the sound record, regardless of which side of the perforation it happens to be on.

It seems that in order to provide a reasonable degree of protection for the sound record on the film, it would be necessary to provide a much greater space from the side adjacent to the perforation than is now the practice. This applies equally whether or not the sound record is placed outside or inside the perforation.

We have considered this greater protection of the sound record when proposing a much greater width for the light-shield between sound track and perforation and a much greater width between perforation and edge of film than in today's dimensional standards.

ACOUSTIC CONTROL OF RECORDING FOR TALKING MOTION PICTURES

J. P. MAXFIELD *

The purpose of this paper is to describe the fundamental basis of sound recording as applied to motion pictures and to give certain results which have been obtained by the use of these principles in the actual production of pictures for release. The quantitative methods of applying the material have not been completely worked out and the work described is therefore largely of a qualitative nature. Some indication has been obtained, however, regarding the approximate magnitude of the more important factors.

The problem to be solved is that of obtaining a sound record which correlates with the picture in such a manner that a member of the audience is given the illusion of being an actual spectator in the scene. This problem readily divides itself into three parts: *First*, a determination of the factors which are of importance to an actual observer in a scene in the appreciation of depth of sound and direction of sight. *Second*, a determination of which of these factors are usable under the conditions of photography and acoustic pickup for a talking picture. *Third*, the control of the acoustics in the set and the position of the pickup device in order to best make use of the available factors.

When a person is viewing a real scene in real life, he is viewing it with lenses—that is, the eyes, and pickup devices—that is, the ears, which are in a fixed relationship, one to the other. This observer is equipped with two eyes and two ears. The two eyes enable him to appreciate distance or depth with much more facility than would be possible with one eye, while the two ears enable him to appreciate direction and perhaps, to a slight extent, depth where sound is concerned. The point of importance, however, is the fact that the eyes and ears maintain a fixed relationship to one another.

* Electrical Research Products, Inc., New York City.

The method by which we determine direction with either one or two eyes is obvious and need not be discussed. The factors which enter into our appreciation of depth or perspective in sound are the ones of interest to this paper. It is probable that the most important factor, particularly where monaural hearing is concerned, is that which deals with the relative change in loudness of the direct and reflected sound. Since the intensity of the reflected sound varies relatively little from place to place in a room, while the direct sound from the source to the pickup device varies quite rapidly with its distance, the ratio of the intensity of the direct to the reflected sound also varies considerably. Hence, as a source of sound such as a person speaking recedes from the microphone, the loudness of the voice appears to decrease slightly while the reverberation appears to increase materially. With binaural listening, this is unconsciously interpreted as distance. It has been found that this effect, when properly controlled, can also be interpreted as distance with monaural listening.

In the case of a talking motion picture, the camera has only one lens and the recording system only one ear, so that those effects which were brought about by the binocular seeing and binaural hearing cannot be made use of. Long experience with the photography has enabled the cameramen to create a part of the depth illusion by the proper choice of the focal length of the lens used and by the proper type of lighting. Fortunately, for the acoustic engineer, the impression of depth depends upon factors which are almost as effective with monaural as with binaural listening; namely, the change in the ratio of the intensity of the direct sound to the reverberation present.

The loss of direction brought about by the use of one ear only, causes some rather unexpected results. When two ears are used, a person has the ability to consciously pay attention to sounds coming from a given direction to the partial exclusion of sounds coming from other directions. With the loss of the sense of direction which accompanies the use of monaural hearing, this conscious discrimination becomes impossible and the incidental noises occurring in a scene, as well as any reverberation which may be present, are apparently increased to such an extent that they unduly intrude themselves on the hearer's notice. It is, therefore, necessary to hold these noises, including the reverberation, down to a lower loudness than normal if a scene recorded monaurally

is to satisfactorily create the illusion of reality when listened to binaurally.

This apparent increase in incidental noises and reverberation may easily be heard by completely stopping up one ear and listening with the other only. It is easier to detect this effect in a room where the incidental noises are fairly loud and where the amount of damping is frequently less than in the normal living room.

Before starting the discussion of the third part of the problem, namely, the control of the acoustics in the set and the position of the pickup device in order to best make use of the available knowledge, it might be interesting to point out some of the conclusions which were drawn from the foregoing brief analysis and which led to the method of pickup and acoustic control to be described. One of the most important requirements for obtaining the illusion of reality is that the sound shall appear to come from the visible source on the screen.

Since it is possible to create the illusion of depth or distance in both the visual and audible parts of the talking picture, it is necessary that the amount by which the voice appears to move forward and backward in the set should correspond with the amount the image actually moves. This amount by which the voice appears to move forward and backward in the set depends upon the amount of reverberation present and upon the relative distance of the microphone from the foreground and background action. In general, the more reverberation present, or the further the microphone from the source of sound, the greater is the apparent distance of the voice from the near foreground. It has also been found by experience that if the conditions have been made correct to obtain this illusion, the voice or sound also appears to follow the picture across the screen.

Before discussing the design of the acoustics of the set itself, it is necessary to consider the acoustics of the space in which the set is built. Where outdoor sets are used or on "location," very little acoustic trouble is experienced—the natural conditions of the outdoors being satisfactory for recording. In this connection it should be remembered that most outdoor scenes are not free from reflection as the majority of them contain buildings or other acoustically hard objects. If, therefore, an outdoor scene is being imitated in an indoor studio, this fact should be taken into account. In the case of indoor sets, it has been found desirable that the studio

in which they are built should be dead and as nearly as possible imitate open outdoor conditions. This insures that any sound leaving the set will not return and create an echo.

It has also been found that the character of the reverberations present should be that which one would expect to find were he actually placed in the scene being shown. As mentioned previously, the amount of reverberation should be somewhat less than that actually occurring in real life. A set which has no ceiling and with one end open, approximately fulfills the proper acoustic conditions provided the amount and nature of the reflections from its walls approximate the amount and nature of the reflection which would occur from the real walls being depicted. Were it not for expense, it would be desirable to build the set of the same materials which would have been used under actual conditions for a real building. In practice, however, satisfactory materials can be found which acoustically imitate the real ones and which are considerably more economical to handle. The extra deadness needed for monaural recording has, therefore, been obtained by the fact that the sound which would normally be reflected from the ceiling and the one missing wall, now receives no reflection but spreads out into the dead studio and is absorbed there. In some cases sets with two walls only are built, usually for photographic reasons. In general, these sets do not have sufficient reverberation and it is then necessary to move in a third wall even though this be behind the lights, in order that proper acoustics may be obtained. Fig. 1 shows such a set-up.

It is therefore seen that this method of acoustic pickup really amounts to the building of a set having proper acoustic conditions inside of a very dead room. By this means it is possible to obtain the desired acoustic properties without continually changing the nature of the surfaces on the large sound stage itself. It is obvious that from a practical standpoint this is a very important item.

Having obtained a set with the proper acoustic properties, the next phase of the problem might well be termed "The Trail of the Lonesome Microphone." The term "lonesome" is used advisedly, for it has been found that the use of more than one microphone in a set at one time tends to destroy the proper depth illusion and as a result the voices very frequently fail to follow the artist about the scene. The use of only one microphone for each camera condition cannot be too strongly stressed. In several cases where difficulty

has been experienced with one microphone and a multiplicity was therefore resorted to, the final sound track picked and used was the one made with the single instrument. This has happened so often that it would appear as a reasonable conclusion that for the same over-all artistic result, it is easier and simpler to obtain high quality with one microphone than with a multiplicity of them.

While it is true that the eyes and ears of a speaker are always maintained in a fixed relationship, one to another, it is not possible to obtain the correct effect for talking pictures with a constant relationship between the position of the camera and the microphone. If all pictures were taken with lenses of the same focal length, such a

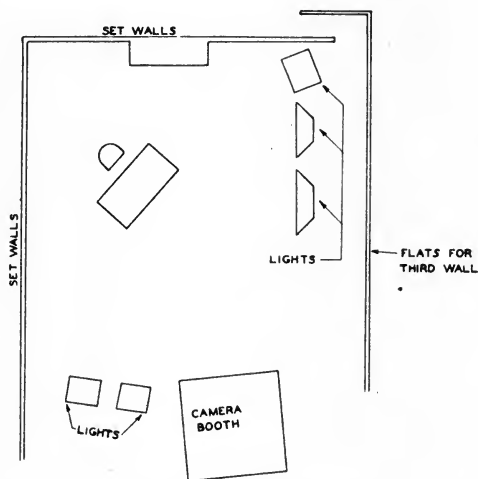

FIG. 1. Location of an acoustic wall in a set.

relationship would exist, but in actual practice lenses of various focal lengths are used and each of these requires a microphone position to correspond. For instance, in Fig. 2, it will be noted that the microphone's position for the long shot camera is quite different from the positions used for the three close-up cameras occurring in the same set.

An interesting experiment was tried in this connection, namely, piecing up the long shot sound track with a close-up in position No. 2, Fig. 2. While it was not difficult to understand every word that was said, the illusion produced was that of the voices coming through the open window directly behind the speakers instead of

coming from their lips as should have been the case. This effect is somewhat weird and is certainly quite displeasing if it occurs very often or for any length of dialog. It is, therefore, necessary to use separate sound tracks for long shots and close-ups particularly where the close-up is of action occurring in the back of the set. This

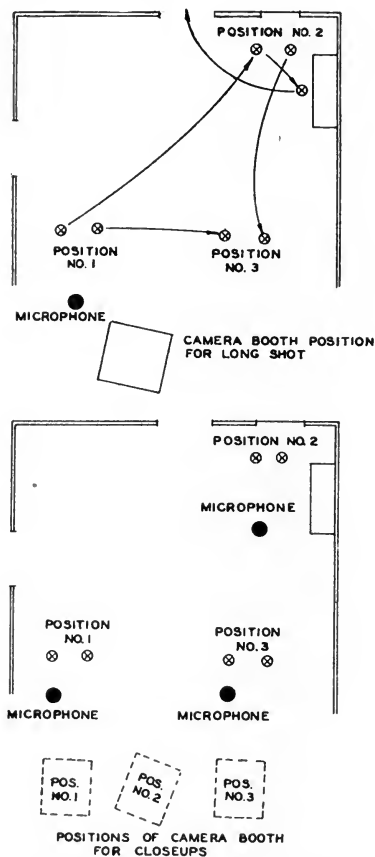

FIG. 2. Microphone and camera placement.

is no more than is to be expected as a close-up is merely the photographer's method of bringing distant action into the near foreground and it is obviously necessary that the voices corresponding to this action should be brought into the near foreground also. While a photographer may obtain his close-up either by moving the camera

closer to the subject or by changing the focal length of the lens, this double method is not open to the acoustic engineer who can change his perspective only by moving the microphone. Were he able to decrease the amount of reverberation in the set, he could, of course, get a close-up sound track without moving the microphone into as close a position as would otherwise be necessary. This latter method is, however, impracticable.

Inasmuch as we are now recognizing the difference in the sound of a voice in the foreground and of one in the background, it becomes necessary that the microphone be placed in the same general direction from the scene as is the camera so that when an actor recedes from or approaches the camera, he also recedes from or approaches the microphone. Under these conditions it is possible to take a dialog with the actors facing directly at, across or even directly away from the microphone, since the change in quality which accompanies the changes in direction is only that which would be expected as the person turns in the picture. In this connection, it might be well to mention that with many of the dead sets which have been used, this statement does not apply, as these sets in general tended to reduce the intensity of the high frequencies and this reduction often became so great when a speaker talked away from the microphone that the intelligibility of the record was considerably impaired. However, with a set having considerable reverberation, the high frequencies which fail to reach the microphone directly, do reach it after reflection from the walls and therefore leave the intelligibility relatively unimpaired. This failure to get these higher frequencies of speech directly, but by reflection only, is probably one of the factors which bring about the change in quality in a voice when a person turns away and talks with his back toward the listener.

It might be well at this time to summarize briefly the proper type of arrangement of set, microphone, and camera. Fig. 2 shows two diagrams of the same set, one arranged for a long shot of a rather extended scene and the other arranged for the taking of three close-ups to be inserted at the proper places in the long shot. This figure is a diagrammatic representation of a scene actually taken. It will be noted that for the long shot, there is only one microphone and that for the close-up conditions, there is only one microphone for each close-up. In some studios these three close-ups would have been photographed separately, in which case there would

have been only one microphone in the set at a time. However, for continuity of action, the director in this case preferred to photograph these three close-ups by repeating the long shot action completely, and it was therefore necessary to set up the three microphones and the three cameras on the set. The use of this method of pickup with its attendant improvement of quality is causing the producers gradually to use fewer cameras on the set at any one time and to bring the talking picture practice more nearly into line with the practice formerly used on silent pictures. Discussions with the cameramen regarding the desirability of taking close-ups and long shots simultaneously indicate that the cameramen prefer to take them separately as it makes the problems of photography, and particularly lighting, much simpler.

For simplicity of discussion, we will confine ourselves to the use of a single camera and a single microphone. It is seen from the diagrams, Fig. 2, that the camera and microphone are situated in the same general direction from the action and that the relative distance of the microphone and camera from the scene depends upon the focal length of the lens being used. We have found no occasion in the six pictures which have been made by this method, to deviate from this type of set-up.

When the set is arranged in this manner, some very useful and interesting results are obtained. In the first place, very complete freedom of action is permitted to the actors as it is not necessary for the people speaking to know where the microphone is placed and they are therefore enabled to carry on their action in a natural manner. This has done a great deal toward helping the director and actor improve the quality of action.

It has also been found that with such an arrangement a much wider range of loudness can be recorded without loss of intelligibility and in a very few cases has it been necessary to operate the mixer dials during a take. This freedom from operation of the mixer dials cannot be too strongly emphasized as such operation during a take may completely change the emotional effect which the director is trying to obtain with the dialog. If, therefore, an arrangement can be found such that the dialog is recorded without any mixer manipulation, the audience is much more likely to be presented with the emotional result which the director intended the scene to portray.

With this arrangement in a set, the incidental noises occurring

have been found to be much more natural and very little faking is necessary. In fact, the experience to date with this new method has indicated that where these noises have been faked, they have been less convincing than when they were taken naturally.

There is one other important matter in connection with sound recording for talking pictures and that is the addition of a musical score to a silent picture or the recording of a large orchestra or chorus. In the industry this is generally called scoring. The acoustic conditions governing this type of recording differ somewhat from those under which dialog scenes are usually produced.

A considerable amount of work has been done regarding the

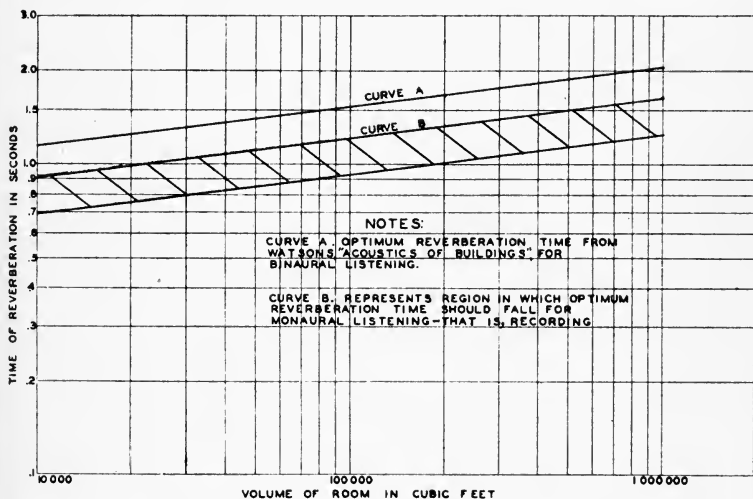

FIG. 3. Optimum time of reverberation as a function of room size.

optimum time of reverberation which an auditorium should have for best conditions of music and speech. All of this work has assumed a real audience and therefore binaural listening. Curve A, Fig. 3, shows a plot of time of reverberation as a function of the size of the auditorium in cubic feet. The shaded area marked Curve B, Fig. 3, shows the region in which the optimum time of reverberation of the room should lie for monaural listening or recording. It is probable that when sufficient data have been obtained a single line may be plotted which represents the best condition as is the case with Curve A. Present experience indicates that a line about midway between the upper and lower edges of the area marked

Curve B gives the best results, but there is still too much difference of opinion to warrant too definite a statement. This time of reverberation given by Curve B is that which the room should have with the musicians in it. For convenience, it is useful to build the room to have this time of reverberation when the largest number of people ever used in it are present. If the music being recorded requires less people than this number, the additional damping material must be brought in to compensate.

It has been pointed out in the literature¹ that the best place for the production of music is a place where there is considerable reverberation, while the best position for listening is one in which there is relatively little reverberation. In rooms large enough to be used for good scoring, namely, 50,000 cubic feet or larger, these two sets of conditions can be realized by placing the larger part of the damping material on the end not occupied by the musicians. The microphone is then placed in this end containing the maximum amount of damping material.

The arrangement of musicians used is that which would be used were their end of the scoring room a real stage and were the microphone end occupied by an audience. It is not necessary, therefore, that the musical director make any special arrangement for the purpose of recording. In scoring as in the taking of talking pictures, the best results have been obtained with the use of one microphone placed at a considerable distance from the orchestra, that is, 20 to 50 feet. This statement applies and has experimental verifications up to musical aggregations having as many as 95 people. In case of an orchestra up to thirty pieces, it has not been found necessary to operate the mixer dials during the recording as has been the practice in the highly damped scoring rooms.

There is one very interesting effect which has been noticed, both in scoring and in some of the earlier work on phonograph recording, where rooms with considerable reverberation were used for recording of orchestral selections. It would be found that records made in these live rooms appeared to be very much louder than similar records made in heavily damped rooms. Where dead rooms were used, it seemed impossible to obtain adequate loudness without cutting over from one groove to another, in the case of a record, or overloading the film recording system, in case of film. On the

¹ F. R. Watson, "Acoustics of Buildings."

other hand, no difficulty has been experienced in obtaining the requisite loudness under the same conditions of overload in live rooms. This would lead one to believe that the ear interprets loudness, not only by means of maximum intensity which reaches it, but that it also, to a certain extent, integrates this intensity in time.

Regardless of the exact nature of this phenomenon, it is of considerable commercial importance as not only the quality but the loudness of such records is improved by the use of scoring rooms having the proper time of reverberation.

From the foregoing, it is believed that a considerable improvement in the naturalness of talking moving picture reproduction can be obtained by a proper control of the following items:

1. Reverberation in the set.
2. Proper placement of the microphone.
3. The use of only one microphone at a time.
4. Refraining from operating the "mixer" to any extent during the take.

SOME NEW ASPECTS OF REVERBERATION

EDWARD W. KELLOGG*

OPTIMUM REVERBERATION

A year ago Dr. Paul E. Sabine presented a paper before this Society on "The Acoustics of Sound Recording Rooms." I must refer you to Dr. Sabine's paper for a fuller discussion of the fundamental principles of auditorium acoustics, but wish to review one aspect of the problem. The most common fault of auditoriums is excessive reverberation. This can be cured by the introduction

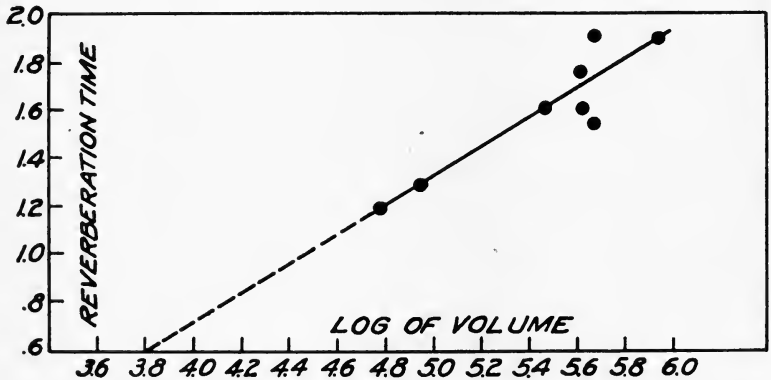

FIG. 1. Reverberation times of acoustically good rooms of different volumes.

of sound absorbing materials. On the other hand it has been possible to carry this process too far and obtain a room with too little reverberation. Fig. 1 of Dr. Sabine's paper, which I am reproducing for your convenience, shows what is considered a desirable degree of reverberation for auditoriums of various sizes. The reverberation period for a given room is the time required for the sound energy in the room to die down to a millionth part of its initial value, or value at the time the source is stopped. You will note from Fig. 1 that the desirable reverberation time increases with the

* Research Laboratory, General Electric Co., Schenectady, N. Y.

size of the room from about 1.2 seconds for a room of about 70,000 cubic feet to nearly 2 seconds for a room of 1,000,000 cubic feet. It is generally agreed that the most favorable conditions for music call for a somewhat greater reverberation period than is best for speech. This is best brought out by Prof. F. R. Watson in his book, "Acoustics of Buildings," from which my Fig. 2 is taken. Music produced in rooms with too little reverberation has usually been criticized as "dull." I know of no theories about why we like what we like in music. Why the musical effects resulting from re-

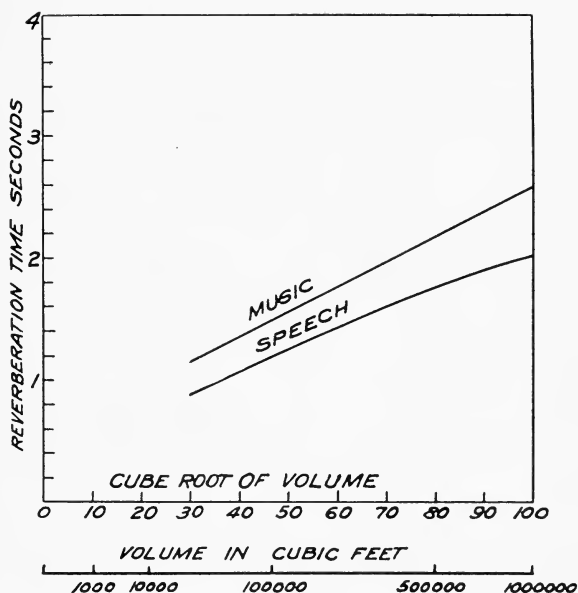

FIG. 2. Preferred reverberation time for music and speech (F. R. Watson).

verberation should give greater pleasure to listeners than the same music produced, for example, out of doors, may be left to psychologists rather than to engineers to explain. Certain of the effects of reverberation, however, can be understood even by an engineer.

SOME OF THE EFFECTS OF REVERBERATION

First and probably most important is the increase in total sound volume. Power of expression in music calls for reaching high levels of loudness. In fact, it is probably more for the sake of loudness obtainable than for any other reason that orchestras are made up

having as many as two hundred artists. Not only is the loudness increased through room reverberation, but the distribution throughout the room is equalized. Twenty feet from the source, the loudness is probably not greatly increased, but one hundred feet from the source, the loudness may be increased ten or twenty fold as compared with that of a similar source at the same distance out of doors. Thus the reverberation makes it possible to play satisfactorily for a larger audience.

The second effect of reverberation is a mixing of the various elements so that too sharp a discrimination in the direction from which the bass and treble parts come is avoided. Both the loudness and blending factors are even more important to the artists than to the audience. To produce adequately loud sound when desired is part of the pleasure of playing or singing. The satisfaction which comes from the power to produce plenty of sound is not confined to trained musicians, but is exhibited early in life by most of us. The blending of parts, which is helped by reflections from walls, gives the individual musicians a better appreciation of the effect produced by the entire orchestra, since his own instrument does not so completely drown out those fifteen or twenty feet away as would be the case out of doors. A soloist as a result of room reverberation and echoes probably experiences less sense of loneliness, and subconsciously feels the support and encouragement of other voices.

The third effect of room reverberation is the overlapping of sounds. It is hard to imagine that this is anything but detrimental, since it inevitably produces many discords. The effect is similar to that of pressing the loud pedal of a piano,* except that the foot may readily be removed from the pedal but reverberation cannot be stopped at will. We tolerate many discordant sounds in music provided their magnitude is not too great. But it is probably toleration rather than actual pleasure in such elements. The choice of reverberation time which gives the most pleasing over-all effect is evidently a compromise between the first two desirable factors and the undesirable factor of excessive overlapping.

When it comes to speech the preferred reverberation is entirely a question of compromise between a desirable reinforcement of volume

* The similarity applies only to the factor of overlapping. The loud pedal causes a change in tone quality by freeing all the strings so that those corresponding to harmonic overtones of the note struck are set into sympathetic vibration, while all of the strings are in some measure shock-excited.

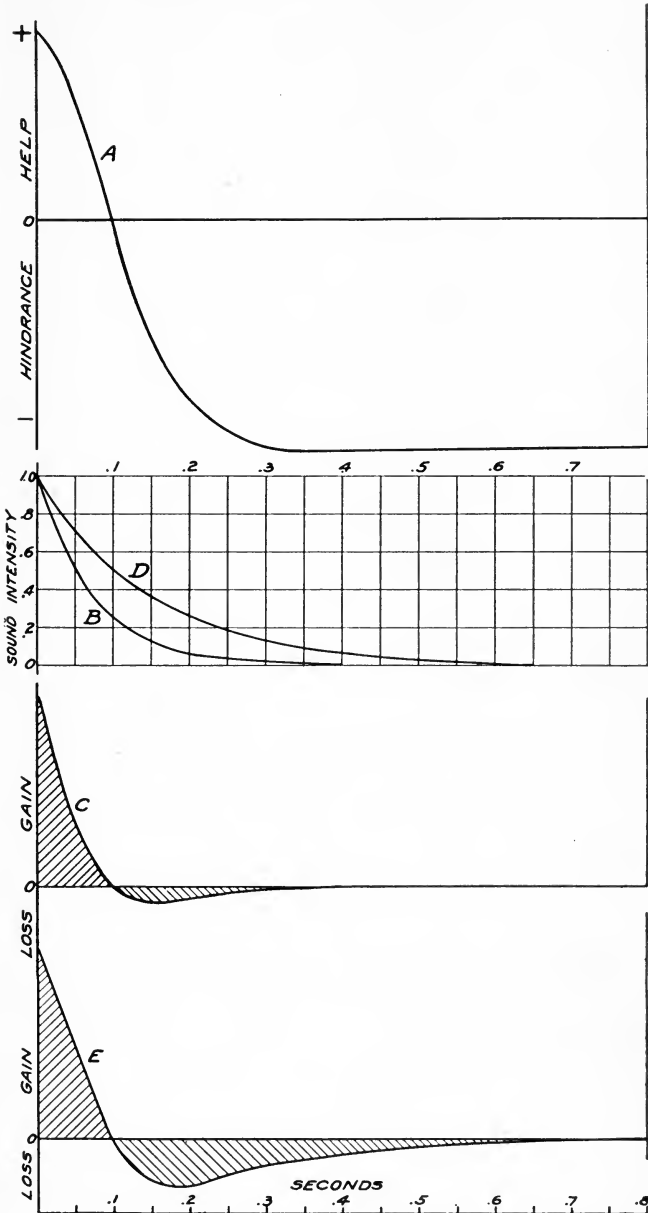

FIG. 3. Help and hindrance from echoes.

and detrimental overlapping. The auditors near the speaker could hear better without any reverberation, but in the remote parts of the room the voice is too faint without the assistance of echoes. If the sound from an echo follows the original sound very quickly it is helpful, whereas if it is delayed it produces only confusion. The effect of an echo on speech perception might be represented by a curve such as Fig. 3A. The curve would obviously be different if the initial loudness were changed. Thus if the initial sounds were loud enough, there would be no help from echoes. Since, however, the purpose of the curves of Fig. 3 is simply to help us form a mental picture of how increasing the reverberation period shifts the balance from no help where there is zero echo, through a condition of substantial help, to one of serious detriment, it is only necessary that curve A be a reasonable approximation to the over-all gain or loss from an echo in the rear part of an auditorium where an average voice would fail to carry without reinforcement. Since reverberation consists in a series of echoes of gradually decreasing amplitude, the first and strongest of these will help and the later weaker echoes (resulting from repeated reflections) will hinder. Let Fig. 3B represent the reverberation curve showing the manner in which the sound dies out in a room with considerable damping. The net help or hindrance to the auditor would be represented by Fig. 3C, whose ordinates are the product of those of A and B. The area above the zero line exceeds that below, which means that the echoes have been more help than hindrance. On the other hand, with the same initial loudness and a longer period of reverberation as illustrated in Fig. 3D, the product curve, E, has a larger area below the zero line, or there is more hindrance than help. There is an intermediate value of reverberation time at which the maximum help is obtained. This optimum reverberation is, as has been pointed out, shorter for speech than for music, and well-designed auditoriums have usually aimed at a compromise between the best values for each.

ALTERED REQUIREMENTS RESULTING FROM ELECTRICAL SOUND EQUIPMENT

I have so far simply attempted to review the fundamental principles of auditorium acoustics in so far as they can be expressed in terms of reverberation, and to suggest some of the reasons for the acceptable reverberation being what it is. During the past ten years much information has been accumulated, many new and better materials have become available for acoustic treatment, and

the principles of good acoustics have been much more widely appreciated, but I believe that the general conclusions reached in the pioneer work of Prof. Wallace Sabine have not been materially altered. Within the past two years, however, a new factor has come strongly into the picture, and I believe that it will call for some radical revisions of our criteria for best acoustics. I refer to the electrical reproduction of sound, and my thesis is that *the future auditoriums will be designed for more nearly the maximum possible sound absorption than for an intermediate or what has been called an "optimum value."* I shall attempt to persuade you of this, using a voice which represents a power output in sound of probably a quarter or a half milliwatt, but the next time you go to a movie the hero will address you in a magnificent five-watt voice, or perhaps you will listen while he whispers a half watt into his sweetheart's ear. Does he need any room reverberation to help make his voice audible? If I cannot convince you of the proposition, listen to him. If room reverberation is not wanted to produce sufficient loudness, then its effect on clearness of speech is always detrimental.¹

The case is not so simple when it is music that is being reproduced. The power available in present day electrical sound equipment is not in general in excess of that of an orchestra and it is distinctly below that of a large organ. Hence the building up of sound intensity by room reverberation is generally as helpful today with electrical music as it is when an orchestra is playing, but I am speaking especially of future developments and of auditoriums in which expensive equipment can be employed to secure the best effects. The power from electrical sound producing devices can unquestionably be raised to whatever levels are desired. If the best conditions for speech call for a highly damped room, the intensity factor for music can certainly be cared for in the amount of sound generated.

ELECTRICAL SUBSTITUTES FOR ROOM REVERBERATION

Suitable equalization of the sound in the different parts of the room may be obtained in a number of ways without the help of reverberation. In the first place, many of the sound producing devices are highly directive and may be made more so if desired. By directing the sound more strongly at the remote parts of the room a satis-

¹ The conclusions of K. S. Wolf as reported to this Society at the Toronto meeting in his paper, "Theater Acoustics" and in the discussion following that paper are not at variance with the above statement.

factory degree of equalization can be had. If it is desired to avoid the effect on the hearer of the sound emanating all from a small source, sound producing devices can be distributed at various points around the room and used during the reproduction of music. The mixing or blending of the various instruments in an orchestra has been completed before the recording of the sound, and the auditorium where the sound is reproduced is not depended upon to accomplish this mixing through reverberation. It is thus possible to take care of the loudness, the distribution, and the blending factors without the help of room reverberation. There remains the overlapping or echo effect as such. This is usually supplied by the characteristics of the room in which the sound is recorded and is subject to a wide range of control by the placing of microphones, the selection of a suitable recording room, and other elements of recording technic. So far as we can see, then, there is practically nothing which auditorium reverberation accomplishes which cannot be secured in a highly damped auditorium by other means, and the other means which I have suggested are susceptible to a high degree of control, which is not possible when reverberation is depended upon to accomplish these results. The reverberation characteristics of the room are constant except for changes in the size of the audience, and the audience factor is a bothersome variable in lively auditoriums, but much less so in highly damped rooms.

VOICE AMPLIFYING SYSTEMS

The foregoing applies only to sound which is recorded and subsequently reproduced, to the voices of the characters we are watching on the screen, but in spite of whatever optimism we may possess in regard to the future of the talking movie we may be fairly sure that for a good while to come, three-dimensional persons with first-hand voices will continue to address audiences, live artists will sing and play for the public, and people will occasionally go to hear an orchestra. Will the highly damped auditorium meet the requirements for such performances? The case is not so simple and clear as is that of recorded speech and music, and improvements and refinements in equipment may be necessary before the advantages of the damped auditorium are realized in full, but I believe that the advantage will lie with the auditorium having maximum damping or a very short reverberation period. I shall only attempt to suggest some of the possibilities of the electrical substitutes for reverberation.

We are all of us more or less familiar with what has been called the "public address system" for enabling a single voice to reach large audiences. It has certainly made possible the understanding of speech in places where this would not otherwise be possible. It consists essentially of a microphone, amplifiers, and loud speaker by which the original voice is magnified. A serious limitation, however, is imposed by the fact that the microphone fails to discriminate between the voice of the person talking and that of the loud speakers. The latter must therefore be held down to a moderate magnification and the microphone placed close to the person who is addressing the audience. A very useful gain in loudness is possible in spite of these handicaps and I believe that those who have worked with public address systems will bear me out in saying that the difficulties from feedback are much less in a well damped room than in a room having strong reverberation. That a public address system is capable of magnifying the voice of a speaker so that he will be more easily understood, has been abundantly demonstrated, but many will probably doubt its applicability where the utmost of voice quality is to be preserved and aesthetic considerations control. I can fancy an artist, jealous of her reputation, exclaiming, "What, let the people listen to that tin horn and call it my voice?" and our sympathies would be with the artist, or the people, or both. I am not in a position to say whether a voice amplifying system suitable for application to music has been developed, but we would be in serious error if we formed our estimates of the possibilities from some of the public address systems which we know. Their shortcomings from an aesthetic standpoint are no reflection upon the skill or judgment of those who designed and built them. They were developed for a very specific purpose—to get the words across—and cheapness and simplicity were important considerations. The carbon microphone usually employed can hardly approach a condenser transmitter in quality. One of the chief factors in controlling feedback is the use of directive loud speakers, and directivity can be much more easily controlled with a moderate sized device if the low frequency components of sound are not amplified. The low frequencies, say, below 300 cycles, contribute little to understanding of speech. In a system designed for speech amplification they have therefore been sacrificed. A system suitable for amplifying music would of course have to retain the low frequency components, and it would be much more expensive but by no means out of the question. The horns, or what-

ever directive device is employed, would have to be much larger than those used in the usual public address system. It may be desirable to impart directive properties to the sound pickup or microphone system as well as to the loud speakers. With the retention of low frequency components of voice and music it may develop that increased attention will have to be given to the sound deadening of the auditorium to low frequency sounds. In his paper already referred to, Dr. Sabine mentions the difficulty of securing large absorption of low frequency sounds, but progress is steadily being made in this direction.

The use of a high quality reproducing system will go far toward reducing feedback difficulties especially if the auditorium is adequately damped. High quality systems must amplify all frequencies within the essential acoustic range nearly equally. Systems which are more imperfect amplify certain frequencies much more than others. It is these resonance points where the amplification is high that always start the "singing" or feedback. Even though the amplification is held below the singing point, regeneration causes an exaggeration of those frequencies for which the amplification is already too high and distortion becomes intolerable unless the amplification is held far below the singing point. The more nearly uniform the amplification of the system the closer to the singing point it is possible to work without objectionable distortion. The objection that by employing a public address system we shall necessarily lose the fine quality of voice or instrument is therefore unfounded. Let us assume, however, that a system having perfectly uniform amplification is not employed and distortion results. Will the artist have a right to object? The alternative would be to go back to the reverberant auditorium. What does this do to voice quality? Not only does it give the overlapping and resultant blurring which is objectionable, but it results in great inequalities in the loudness of the various frequencies present in the voice. The high quality amplification system does no worse. There is one form of distortion which the auditorium in general does not produce, namely, what is known as non-linear distortion or the production of overtones not present in the original sound. An electrical system may give rise to non-linear distortions, but here again the question is only one of proper design and adequate power in order to eliminate such effects.

Given a high quality amplification system, a small amount of

feedback is similar in its action to reverberation, having the tendency to prolong sounds, but the reverberation period corresponding to this would be very short. If a greater degree of overlapping and sound prolongation is found desirable, there are many expedients possible by which it can be supplied. For example, I was told that a certain British broadcasting station used the device of picking up the initial sound with a microphone, reproducing it in a separate reverberant chamber, picking it up there with a second microphone, and then broadcasting it.

I believe that I have gone far enough to indicate that the desirable effects of reverberation can all be simulated by a high grade electrical system and that these effects will be subject to complete control while some of the undesirable effects of reverberation can be eliminated. Prejudice against such electrical amplifying systems is inevitable, but if artists find that other people's voices sound better with electrical reinforcement than in reverberant rooms and find that the public appreciates their own voices better, prejudice will quickly subside.

APPLICATION OF AMPLIFYING SYSTEMS TO ORCHESTRA MUSIC

In applying electrical reinforcement to orchestra music a favorable circumstance is that microphones can be located close to the individual players, the mixing being done in the electrical circuit. As I have said, feedback troubles are reduced whenever we can place the microphones close to the original source. In view of this favorable condition it should be possible to direct a certain amount of the reproduced sound toward the orchestra itself, in order that the musicians may get the desired sense of reinforcement and blending.

NEW MUSICAL EFFECTS

While it is not a part of the reverberation problem, I should like to mention another application of the electrical reinforcing system, which I believe may become an important factor. It contemplates the same equipment which I have already described, with possibly certain additional pickup arrangements. In the January, 1929, issue of *Radio Engineering* is an article on "New Musical Effects by Electrical Means."¹ The article was inspired by some of my experiences with one of the first high powered loud speakers. Some of the selections most enjoyed by myself and others were vocal and

¹ Reprinted September, 1929, by *Projection Engineering*.

violin solos. While we are accustomed to thinking of the purpose of electrical sound equipment as that of faithfully imitating sounds which have been produced by voices or musical instruments, there is no reason why its function should be so limited. A voice multiplied to one hundred times the original power is not exactly a faithful imitation but it may be very pleasing, and I take it that the primary function of all music production is to give pleasure or satisfaction to listeners. A single voice or a violin is a faint source of sound for a large auditorium. The only means hitherto possible for producing sound in large volume has been to multiply the number of singers or violins, so that choruses of two hundred voices and one-hundred-piece orchestras have been employed where the finest possible in musical entertainment has been sought, but in the effort to bring up volume we have made great changes in tone quality. Multiplication of sources gives a sound wave of great complexity as compared with the wave from one source. Why not have both types of sound available at all degrees of volume? We have heretofore had our choice between a single voice, always faint, and a chorus either faint or loud. Let us add the fourth possibility, making the list include a single voice either faint or with abundant volume as well as the faint or loud chorus. This added element is made possible by electrical equipment and it is a distinctly new musical effect. It has been well established¹ that a change in volume results in an alteration of sound quality. We shall still have our large choruses and orchestras, but is anyone prepared to say that a quartette of fine well trained voices reproduced with the volume of the large chorus will not afford still greater pleasure to many listeners, or that a violin solo at band volume may not be a delightful form of music? The electrical system may go even further and give us what are essentially new musical instruments. A magnetic pickup attached to a violin bridge, for example, would probably give us a violin with a different but pleasing voice quality while preserving all the power of expression which the violin now possesses. Musical instruments have been developed, first, to produce vibrations and, secondly, to

¹ "Auditory Masking of One Pure Tone by Another," R. L. Wegel and C. E. Lane, *Phys. Rev.*, Vol. 23, 1924, p. 266.

"Physical Measurements of Audition," H. F. Fletcher, *Bell System Tech. Jour.*, Oct., 1923, p. 145. *Jour. Franklin Inst.*, Sept., 1923.

"High Quality Transmission and Reproduction of Speech and Music," W. H. Martin and H. Fletcher, *A. I. E. E.*, Vol. XLIII, 1924, p. 385.

radiate the sound. The radiation of sound is by no means a simple problem especially when it is required that the radiation cover a large range of frequencies. This problem of radiation has probably been more nearly solved in the case of electrical loud speakers than in any musical instrument. Let us imagine that the designer of a musical instrument is relieved of all necessity for worrying about sound radiation and needs consider only the production and control of vibrations of various types. May we not look as a result of this for many new musical effects by which the musical entertainment of the future may be enriched?

DISCUSSION

MR. SILENT: In the case of the orchestra, it would seem to be going too far to recommend a dead theater. Many of the larger auditoriums reinforce both the orchestra and the stage voices. However, in producing an orchestra in a dead theater, we are taking instruments which by virtue of their purpose are designed by men who had to play in live houses, and the sudden transport of the instruments into the dead auditorium makes it necessary to compensate in their design. Perhaps an entirely new set of musical instruments will result. In the case of artificial reinforcements of the instruments for the purpose of simulating reverberation things seem precarious for the reason that one listens to reverberation from a tremendous number of different sources. It is almost impossible to reproduce this effect with loud speakers.

Mr. Kellogg has offered a very valuable contribution, and while undoubtedly his theories are very favorable for the reproduction of speech, they call for a little modification along the lines of our experience.

CAMERA AND PROJECTOR APERTURES IN RELATION TO SOUND-ON-FILM PICTURES

LESTER COWAN*

Recently much concern was aroused among Hollywood studio technicians by the fact that in some theaters the heads and feet of characters, important words in titles, and other vital elements of the picture were being cut off in projection of sound-on-film pictures. Projectionists were inserting in the film gate a solid sliding aperture (Fig. 1) which masked out from the top and bottom

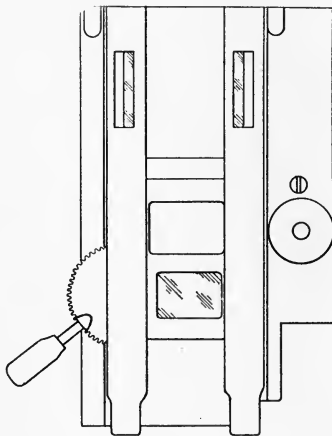

FIG. 1. Drawing of one attachment used to simplify change from small oblong aperture to large aperture.

of the picture an amount sufficient to restore the normal picture proportions. The smaller aperture reduced the height to three-fourths of the width which had been diminished by the addition of the sound track. The smaller rectangular picture when projected with a one-half inch shorter focal length lens filled the screen with a picture equal in area to the silent picture.

* Assistant Secretary, Academy of Motion Picture Arts and Sciences.

Except in a few cases cinematographers had not been warned of the reduced aperture practice. They did not anticipate it in their photography. The result was that parts of the picture were being cut out which cameramen assumed would reach the screen as usual. Studio technicians in general were at a loss to know what to do; they did not know the extent of the practice or the exact size of the reduced aperture. An immediate coördination of studio practices with existing theater methods was imperative. To this end a nation-wide survey of theater chain and production studio practices was launched by the Academy of Motion Picture Arts and Sciences with the assistance of the Technical Bureau of the Association of Motion Picture Producers. Theater chains listed in Table I and studios listed in Table II responded to the inquiries which were sent out.

SUMMARY OF SURVEY DATA—THEATER PRACTICES

Replies from theaters reveal four different practices, alike in that each provides for matting out the sound track by a movable masking device, but different in their manner of compensating for the screen area left blank because of reduced picture width due to the addition of the sound track. For the sake of convenience let us refer to these four practices or methods as methods A, B, C, and D.

Method A—Combination of Reduced Aperture with Shorter Focal Length Lens.—An aperture is inserted in the film gate which masks out, in addition to the sound track, a portion from the top and bottom of the picture sufficient to reduce the height to about three-fourths of the reduced width. The smaller 3 by 4 picture is enlarged by a one-half inch shorter focal length lens to fill the screen. Recentering is accomplished by auxiliary devices which enable the lens on the machine to be moved from right to left. Unless due allowance has been made in production for this smaller aperture vital portions of the picture will almost certainly be cut out. The estimated cost of installing this method is \$200.

Method B—Movable Mask or Flipper.—A movable mask or flipper about 30 inches wide at the left side and facing the screen changes the screen shape to correspond with the picture shape. When sound-on-film pictures are being shown it is moved over to cover the blank strip on the left of the screen. The flipper is operated by a stage

TABLE I Summary of Data on Theater Projection Aperture Practices

Theater Chain	Report by	Projector Aperture Policy for Sound-on-Film Pictures	Projector Aperture Dimensions for Sound-on-Film Picture*
Publix Theaters, Inc.	Dr. N. M. Laporte, Research Dept.	Method A standard for all larger houses	0.593" × 0.796"
Loews, Inc.	Lester B. Isaacs, Supt. of Projection	Method A standard for all larger houses	0.607" × 0.800"
Fox-West Coast	R. H. McCullough, Supt. of Projection and Electrical Equipment	Method A standard for all houses. About 65 houses already installed	0.597" × 0.796"
Fox-New England	Herschell Stuart, General Manager	Method B in all houses; if no better improvement by fall, will adopt Method A	0.680" × 0.820" (approximate)
Balaban and Katz	J. H. Goldberg, Supt. of Projection	Method A standard for circuit	0.609" × 0.815"
Warner Brothers-Skouras Bros. Circuit	Charles Skouras, Manager	Method B in all theaters	0.680" × 0.820" (approximate)
Saenger Theaters	F. Sander, Mgr. Supply Dept.	Method A standard for circuit for Silent and Vitaphone as well as sound-on-film	0.610" × 0.829"
Universal Theaters	D. B. Lederman, Constr. Dept.	Methods B, C, and D	0.680" × 0.820" (approximate)
Commerford Theaters	Edw. W. Parsons, Chief Projectionist	Method A standard for circuit	0.600" × 0.810"
R. B. R. Amusement Company	J. H. Rowley, Manager	Methods B, C, and D	
R. & R. Circuit	B. L. Brockman, Manager	Methods B, C, and D	
R. C. A. equipped theaters. (R-K-O, etc.)	M. C. Batsil, Chief Engineer	Method B standard for all houses	0.687" × 0.812"
		Method A in not more than 5%	0.624" × 0.812"

TABLE I (Continued)

Theater Chain	Report by	Projector Aperture Policy for Sound-on-Film Pictures	Projector Aperture Dimensions for Sound-on-Film Picture*
E. R. P. I. equipped theaters in Western U. S. A. (306 theaters)	Nathan Levinson, W. Division Mgr.	Out of 306 theaters about one-third use Method A; about one-third Method B; and about one-third Methods C and D	
Method A—Combination of reduced aperture with shorter focal length lens			
Method B—Movable mask or flipper			
Method C—Blank strip on the left side of picture			
Method D—Small blank strip on each side of the picture			

* S. M. P. E. standard projection aperture— $0.680'' \times 0.906''$.

When sound track only is masked out the aperture is reduced to approximately $0.680'' \times 0.820''$.

Simplex standard apertures—Vitaphone or silent picture, $0.679'' \times 0.904''$.

—Movietone picture, $0.6093'' \times 0.7968''$.

hand, some member of the regular house staff, or by remote control from the booth.

Method C—Blank Strip on the Left Side of Picture.—A sliding plate masks out the sound track. A blank strip shows on one side of the screen.

Method D—Small Blank Strip on Each Side of the Picture.—Rather than leave a blank strip on the left side of the picture some theaters shift the projection machine in order to center the picture, so as to divide the blank area between the two sides.

As conditions are constantly changing it does not seem possible at this time to give an accurate estimate of the number of theaters employing each of the four methods referred to above. From information received it is reasonable to assume that theaters using methods C and D are almost exclusively the smaller houses with less critical audiences due to lower admission prices. These theaters proceed cautiously before adding new devices which increase their overhead or operating expenses. The installation of a flipper costs only about \$50 but to this must be added the labor cost of operating it. In many localities the flipper can be operated only by the employment of an extra stage hand. The alternative—a new set of lenses and aperture plates—would cost approximately \$200, a very considerable amount to the small theater owner. It is likely that many of these small houses will continue to show their sound-on-film pictures with a blank strip either on one side or on both sides of the screen.

Practically all of the better class or *de luxe* houses fall within classes A or B. At present the theaters in class B probably outnumber those in class A but the tendency is definitely toward the spread of the reduced aperture-shorter focal length lens method.

The following example illustrates the rapidly changing conditions and the tendency. Electrical Research Products, Inc., undertook on behalf of the Academy a complete survey of the aperture situation in all theaters west of Denver using E. R. P. I. equipment. The current practice in 306 theaters was reported by E. R. P. I. field representatives. A tabulation of the reports made on August 9th gave the following results:

Theaters using method A	35
Theaters using method B	123

Theaters using method C	136
Theaters using method D	12
	—
Total	306

On August 20th—eleven days later—a supplementary report gave the following additional information: “Since our last report of August 9th Fox West Coast Theaters has decided to equip all of its theaters with the proportional masks and change of lenses.” Publix Theaters, Incorporated, are also doing this in all of their theaters in the western part of the country, except those of the

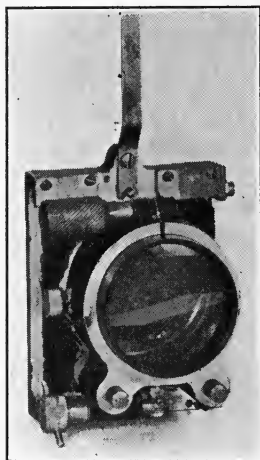

FIG. 2. Movable lens mount to center under-sized aperture as developed by Publix Theaters.

Marcus enterprises recently acquired. These new developments would raise the number of theaters first reported as using method A from 35 to at least 100.

Recentering.—Probably the most difficult problem in connection with the reduced aperture method (A) is to recenter the picture after it has been enlarged. The amount masked out from the top and bottom of the picture in reducing the aperture is calculated to balance the increased magnification so that from the standpoint of height the picture will fit into the screen frame. Magnification

extends the left margin of the picture to cover about half of the blank strip. The right margin is extended an equal amount beyond the black border so that the picture must be moved to the left in order to be properly centered. Standard equipment now in use does not provide for this need. Movement of the picture from left to right is not possible due to the stationary base which gives a fixed position to the projection machine.

There are two ways in which recentering may be accomplished, both involving the use of auxiliary devices. The first and most

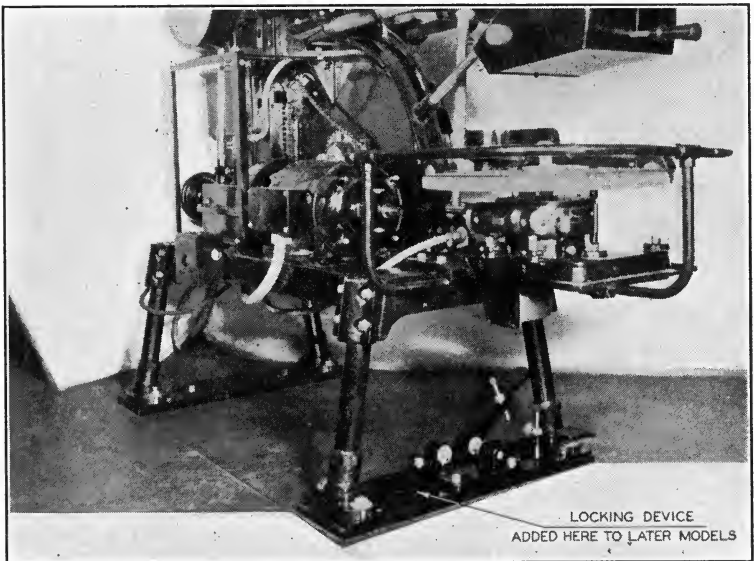

FIG. 3. Screen centering base incorporated in new models of Electrical Research Products, Inc., reproducer set equipment.

common method of recentering is by moving the lens slightly to the left. Publix theaters use a lever operated, horizontally movable lens mount (Fig. 2) which moves the optical center of the lens 0.080 in. to the left. This introduces spherical aberration which is sometimes noticeable on the screen but usually not enough to be considered a defect. An "Ilex" lens has been developed with optical corrections permitting sharp definition at two focal lengths, thus simplifying the procedure by eliminating the necessity of actual lens changing. The second method of recentering is by use of a device which makes it possible to move the equipment on the horizontal

plane. A lever at the front moves the front end of the machine laterally to preset stops.

The newest development which promises a satisfactory solution to the problem is a shifting device (Fig. 3) developed by the Bell Laboratories for the E. R. P. I. reproducer set for the specific purpose of centering small aperture pictures on the screen.

The shifting device consists primarily of these two units: a pivot plate for the forward pair of legs, and a plate incorporating a pedal mechanism for the rear pair of legs. Provisions are made for anchoring the foot pads of the reproducer set to these units, which in turn are bolted securely to the floor. By proper adjustment of the stop screws on the foot pedal mechanism a full sized picture is centered by depressing the right hand pedal until further motion is halted by the adjustable stop, and the smaller picture is centered by depressing the left hand pedal. The locking device, which consists of a quick release screw clamp, maintains either position and assures the picture remaining centered. Briefly, the device permits the operator to quickly center either sized picture at will and maintain that position constantly.

Other Aspects of the Reduced Aperture Method.—Attention has been called to several other aspects of the reduced aperture practice.

1. The shorter focal length lens increases the graininess of the picture on the screen. No theater reported this as a serious defect.

2. One theater chain called attention to the fact that the smaller aperture slightly reduces the amount of light that gets to the screen. Due to the fact that the size of the picture is increased, this reduced light must cover a larger screen area. However, there has been no indication that this constitutes a serious problem.

3. The projectionist's problem of keeping his picture in the frame is more difficult and requires painstaking care. Although the cameraman may keep his action within the smaller area he usually fills up the balance of the frame with foreground and background for the benefit of theaters using the standard aperture. This means that the projectionist finds no indication on the picture as to the exact line of its upper and lower limits. More is dependent upon his own judgment than formerly and his responsibilities are greater.

SUMMARY OF SURVEY DATA—STUDIO PRACTICES

Now let us turn our attention to the studios to see what, if anything, they are doing to meet these changing conditions in the theater.

Twelve studios reported in the Academy survey. All were making allowance in photography for the sound track either through a definite marking on the camera ground glass or through instructions to cameramen to center their pictures to the right so that the addition of the sound track would not affect their composition. Two of the twelve studios, Fox and Paramount, who had been in communication with their own theater chains, were informed of the new practices and accordingly had markings put on their camera ground glasses delineating a smaller rectangle within which all action was to be photographed. The pictures photographed within these new ground glass markings did not suffer from the reduced aperture practice.

As the ground glass markings shown in Table II indicate, when compared with the dimensions of the reduced projection machine aperture, most of the studios had done nothing to anticipate the new theater methods.

TABLE II. *Summary of Survey of Studio Aperture Practices*

Studio	Dimensions of Ground Glass Markings
Paramount	0.623" × 0.812"
Fox	0.650" × 0.835"
Metro-Goldwyn-Mayer	0.723" × 0.835"
Columbia	0.725" × 0.950"
United Artists	0.700" × 0.920"
Universal—Bell & Howell	0.720" × 0.969"
Mitchell	0.723" × 0.835"
Sennett	0.720" × 0.865"
R-K-O—Bell & Howell	0.720" × 0.855"
Mitchell	0.723" × 0.835"
Educational	0.723" × 0.895"
Darmour	0.700" × 0.840"
Tiffany-Stahl	0.700" × 0.868"
Pathe	0.723" × 0.887"

Note: Aperture on Bell & Howell cameras is 0.720" × 0.969"; on Mitchell cameras, 0.720" × 0.923".

It is interesting to note that twelve studios reported twelve different dimensions marked on camera ground glasses. This is partly explained by the fact that some studios have had the sound track width indicated by a line on the ground glass while others simply instructed cameramen to center their compositions to the right so as to make room for the sound track.

When the cameraman looks into his ground glass he must bear in

mind that the picture which he is composing is likely to be projected through apertures of three different sizes:

1. Movietone—0.680" × 0.820" (approximately)
2. Reduced Aperture—0.600" × 0.800" (approximately)
3. Standard Aperture for Silent and Disk Release—0.680" × 0.906" (approximately)

Restoration of Aperture to 3 x 4 Proportion on Basis of Dimensions Recommended by Academy of Motion Picture Arts and Sciences.

Circle Represents a Head Close-up.

A—Original "B and H" Silent Aperture—.720" x .9375".

B—A with Sound Track—.085".

C—Recentering of B—Account of Sound Track.

D—C Recentered—with Camera Aperture as shown—.620" x .835".

E—Head Reduced to meet projection requirements of Proj. Aperture in F.

F—New Proj. Aperture, size .600" x .800", inside Camera Aperture showing Head reduction.

G and H represent cutting of Head in Projector by improper Framing.

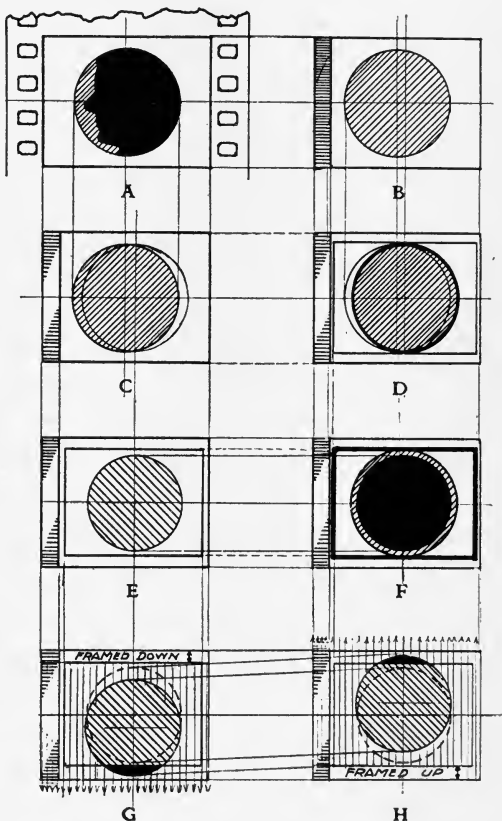

By V. E. Miller, Paramount-Famous-Lasky

The picture must look well in all three forms. The practice of most cameramen is to favor the reduced Movietone apertures by centering their picture a bit to the right. A properly composed picture will confine the action within the smaller area with a suitable background and foreground for theaters using the Movietone or standard apertures. If any of the three forms suffer it will most likely be

the picture for silent or disk release. Successful examples of triple composition have been made proving that it is possible to have the picture look well under all conditions. In this connection a comment made at a recent Academy meeting is interesting:

"There is a way, I think, whereby we can satisfy both the silent picture exhibitor and the sound picture exhibitor, giving them both an identical composition in the 3 by 4 ratio. The method is just the reverse of what Photophone did when they first began. The method is to take the picture in the camera on a smaller size, masking off the rest of the film, then printing the release for the sound version in the usual manner and printing the release for the silent version on optical printers. Such a printer is being used back in New York. It is made by Bell & Howell. At one time nobody knew how to do optical printing, but with all the skill there is in the business, it could be done."

CONCLUSION

The facts summarized above were presented at a joint meeting of the 'Technicians' Branch of the Academy of Motion Picture Arts and Sciences with the American Society of Cinematographers and the local chapters of the Society of Motion Picture Engineers and the American Projection Society, held in the Academy assembly room on August 15th. After an extended discussion the meeting decided to refer the survey data to a joint committee composed of representatives of the four organizations. This Joint Committee was constituted as follows: Gerald F. Rackett, John Arnold, E. W. Anderson, Sidney Burton, Albert Feinstein, John F. Seitz, J. F. Westerberg.

At a second joint meeting of these four societies the joint committee reported the recommendations embodied in the following resolution, which was adopted by unanimous vote of the four societies.

WHEREAS, investigation has revealed wide variance in theater projection practices and that there is no effective standard aperture for projection of sound-on-film talking motion pictures:

Be it resolved: That as a temporary measure this committee recommends that all studios and cinematographers using sound-on-film methods make marks on the camera ground glass equally spaced from the top and bottom in addition to the mat or mark for the sound track; these marks to delineate a rectangle 0.620 by 0.835 inch in size and that all vital portions of the picture be composed within these limits.

Be it also resolved: That the committee further recommends that theaters which make a practice of reestablishing the full screen proportions from sound-on-

film pictures do so by the use of an aperture whose size would be 0.600 by 0.800 inch on the basis of projection on the level, the horizontal center of the aperture coinciding with the horizontal center of the S. M. P. E. Standard Aperture.

Copies of this resolution have been sent to executives of all motion picture studios and leading theater chains. The following Hollywood studios have already reported that markings would be made on the ground glass of all cameras in accordance with the specifications contained in the resolution: Paramount-Famous-Lasky, Metro-Goldwyn-Mayer, United Artists, Pathe, Universal, R-K-O, Tiffany-Stahl, Mack Sennett, Darmour, and Educational. Present markings on Fox Studio cameras approximate the recommended practice. This assures a uniform practice in the studios that anticipates and is in accord with existing practices in the theaters. The aperture dimension recommended to theaters represents a mean of dimensions reported by theaters now using the smaller aperture and may serve as a guide to theaters which may choose to adopt it in the future.

Copies of this resolution have also been sent to the Standards Committee of the S. M. P. E.* and the Projectionists Advisory Council in the hope that these two important bodies would interest themselves in working out a set of permanent standards to meet the new conditions.

ADDENDA

The following item, although not a part of this paper, I thought might be an interesting sidelight to some members of the Society.

A supervising projectionist of one of the largest theater chains in his reply to our inquiry raises a very pertinent question. He says: "The matting off at the top and bottom of the picture seems essential to members of the profession but the thought occurs to us, 'Does the shape of the projected picture matter to the general public?'" Our curiosity aroused, we put the question of the comparative advantages of the square and rectangular screen among others, to Dr. Walter R. Miles of Stanford University. Dr. Miles is professor of experimental psychology and an outstanding authority in his field. He was passing through Hollywood on his way east to attend international congresses of physiology and psychology. His comments on the proportions of the screen are given below.

* *Editor's note:* This resolution was recommended as standard practice by the Standards Committee of the S. M. P. E. See report in this issue.

According to the view of Dr. Miles, the physical nature of the eye as well as long habit is against the nearly square shape of the sound-on-film picture for the motion picture image as compared with the rectangular shape silent picture. He says:

"No generation of man is entirely free from former generations. Whether this is accident or intention it is hard to determine. If we make a survey of the tools and household articles that were used in Egypt as compared to those that are used today we find, perhaps to our surprise, considerable uniformity in shapes and sizes. For example, there is an optimal size and weight for the hammer that is used in one hand. There is an optimal size and shape for the hand mirror to be used by a woman. Many illustrations of this come to one's mind.

"The proportions of the rectangle have been a subject of scientific study since about 1875. At that time it was noted that man, in using the rectangle in nearly all of his buildings, furniture, and conveniences, adopted a ratio which was strikingly different from the perfect square. Although there is no correct exactness in this ratio it tends to be about five to eight, a combination which has been called the golden cut, frequently found in crosses, windows, *et cetera*. The formula has been: the short side is to the long side as the long one is to the sum of the two. This must not be regarded as a law to be striven for or which will bring punishment if it is transgressed.

"If we seek for a basis in the physiology of the eyes and in the psychology of perception the following points come to our notice. The eyes have one pair of muscles for moving them in the horizontal but two pairs for moving them in the vertical. Vertical movements are harder to make over a wide visual angle. As man has lived in his natural environment he has usually been forced to perceive more objects arranged in the horizontal than in the vertical. This has apparently established a very deep-seated habit which operates throughout his visual perception. Perhaps we can see the whole thing typified in the opening through which the human eye looks; it is characteristically much wider than it is high.

"If one thinks over the famous paintings with which he is familiar or visits a gallery he finds most of the canvases with a longer horizontal axis than vertical. They are thus true to nature as man experiences nature. Movement can take place more easily on the horizontal and therefore this axis may well be a longer one than the vertical.

"One final feature in the psychology of visual perception is that the vertical axis is over-estimated. A true square looks about three units too high.

"We therefore see conformity with man's general experience as well as with the accepted art practice in projecting a picture that is wider than it is tall."

Upon his return from the east Dr. Miles took pains to reassure us that some of the leading physiologists and psychologists of the world with whom he had discussed this very interesting subject had in general confirmed his opinions. This is very interesting especially in view of the fact that the proportions of some of the wide films in use are two to one and the opinion expressed by Dr. Miles gave eight to five as the proportion for maximum efficiency.

REPORT OF STANDARDS AND NOMENCLATURE COMMITTEE*

Two meetings of the committee were held during the period between the New York and Toronto meetings of the Society. The first of these, held in May, was poorly attended, the following members being present: Dr. Sease, Messrs. Channier, Brown, Spence Griffin, and Jones, *Chairman*. At the second meeting, held September 26th, the attendance was somewhat better, the following members being present: Mr. H. N. Griffin, Dr. Sease, Messrs. Burnap, Sponable, M. C. Batsel (representing Dr. Goldsmith), Channier, Brown, Spence, F. L. Whiting (representing Mr. Sponable during his absence), and Jones, *Chairman*.

At these meetings a large number of problems connected with the work of standardization were discussed at considerable length. In some cases the committee has been able to arrive at definite proposals for standardization and recommended practice. In other cases it has been impossible to formulate definite proposals for presentation to the Society. In this report is given a brief summary of the work with which the committee has been occupied during the past six months.

At the last meeting of the Society in New York, May 6-9, 1929, the following proposals for standardization were presented to the Society and received the preliminary approval of the Society:

1. Taking speed, for sound recording practice.
2. Projection speed, for sound recording practice.
3. Location of scanning slit.
4. Location and width of sound track on positive.
5. Definition of "Number of teeth in contact."
6. Definition of "Safety Film."

Having stood for six months, these proposals, with the exception of the definition of Safety Film, are now submitted for final approval. They may then be added to the list of the Society's approved standards and recommended practice.

* October, 1929.

SAFETY FILM

The definition of Safety Film, as formulated by the committee prior to the last meeting and submitted to this Society at the New York meeting, has been subjected to severe criticism from various sources. Many objections have been raised to the adoption of the definition in the form previously submitted. The committee has considered these objections and feels that some of them are valid and to meet them has formulated a new definition which it feels represents appreciable improvement. It will be recalled that the definition as formulated specified that any material having a burning time less than 15 seconds when tested under certain specified conditions should be called Safety Film, the burning time being determined by using a sample of the material of specified dimensions. The dimensions of the proposed sample are:

Length 36 inches, 914.4 mm.

Thickness 0.005 to 0.006 inch, 0.122 to 0.152 mm.

Width 0.63 to 1.378 inches, 16 to 35 mm.

It has been brought to the attention of the committee that it is undesirable to base the definition of Safety Film on a burning time determined with a sample of these dimensions since motion picture materials are, or soon will be, in use varying over a much greater width range. For instance, film as narrow as 7 mm. has been proposed and several wider products (up to 70 mm.) have been made. Moreover, the thickness tolerances are not sufficiently great to include the possible materials which it may be desirable to use. For instance, some very thin materials, down to approximately 0.002 inch thick, have been produced, and it seems quite possible that it might be desirable to use materials appreciably thicker than the upper limit specified by the definition.

This point of view raises the entire question as to the fundamental intent and purpose of formulating a definition of Safety Film. It has been pointed out that the definition should relate to the combustion rate of the product as manufactured and distributed. This point, that the factor of importance is the rate at which a material burns regardless of its thickness or width, seems to the committee to be well taken and that it should be adopted in the formulation of the definition of the term *Safety Film*. In order that the definition shall conform with this point of view it is necessary, therefore, to eliminate from the specifications of the sample, with which the burning rate is determined, statements relative to width and thickness

and merely to state that the time of combustion for a sample of the material in question shall be less than some specified value.

Objection was also raised to the combustion time specified in the previous definition. Reference to the data relating to the burning time for various samples of news print shows in one case the burning time for a sample of standard length, namely, 36 inches, was as low as 10 seconds. It was pointed out that it seems illogical to formulate a definition of Safety Film which could be interpreted to indicate that some news print papers would fall in the unsafe category. Of this the committee feels that the point is well taken and that the burning time should be specified as 10 seconds rather than 15 seconds, the value mentioned in the previous definition. This still leaves ample margin between the class of Safety Film and that of the commercial nitrate films which have burning times of 3 and 4 seconds.

It seemed desirable also to define somewhat more clearly the classes of materials to which this definition is intended to refer, limiting specifically its application to motion picture materials but at the same time making it include all types of materials that are used or may be used for this purpose. After careful consideration and lengthy discussion the committee therefore wishes to withdraw the definition submitted at the last meeting and to substitute the following:

The term "Safety Film," as applied to motion picture materials, shall refer to materials which have a *burning time* greater than ten (10) seconds and which fall in the following classes: (a) support coated with emulsion, (b) any other material on which or in which an image can be produced, (c) the processed products of these materials, and (d) uncoated support which is or can be used for motion picture purposes in conjunction with the aforementioned classes of materials.

The *burning time* is defined as the time in seconds required for the complete combustion of a sample of the material 36 inches long, the determination of burning time being carried out according to the procedure of the Underwriter's Laboratory. This definition was designed specifically to define Safety Film in terms of the burning rate of the commercial product of any thickness or width used in practice. The test of burning time therefore shall be made with a sample of the material in question having a thickness and width at which the particular material is used in practice.

In making a determination of burning time the Underwriter's Laboratory prescribes that a strip of the material shall be sus-

pended vertically by a small wire through a pinhole at one end of the test strip. A gas test flame $\frac{3}{4}$ inch long and $\frac{1}{4}$ inch in diameter is applied at the lower end of the suspended strip. The relative ease of ignition, height of flame, and time required for complete combustion are observed. Tests shall be made in a place protected so far as possible from drafts although no definite hoods or shields are used.

We wish to emphasize the fact that the definition is intended to refer specifically to a commercial product and to serve as a specification of the safety of this material as used in practice. It is realized that a given film base formula as used for making products which differ in thickness and width might in one case give rise to a product which may be classified as "safety" and in other cases the product would have to be classified as unsafe. We feel that this is desirable and that the whole object to be achieved by the formulation of the definition is to promote safety in the utilization of motion picture film products.

LOCATION OF SCANNING SLIT

The wording of the specification as to the position of the scanning slit as presented in our last report seems to be a little ambiguous. It is therefore desired to change the wording of this proposed standard without changing the intent. It does not seem necessary to withdraw the previous proposal, but merely to ask the Society's permission to alter the wording for the sake of clarification and to assume that the definition has had its six months' probationary period.

NOTCHING OF NEGATIVES

This problem has been before the Standards Committee for several years and no solution has as yet been found. In the last report of this committee a drawing was published showing three forms of commercial practice and a form proposed by the Seventh International Photographic Congress. The Congress requested that the Society give this proposal consideration and, if possible, its approval. It does not seem advisable to approve the recommendation of the Congress. The notch is located directly on the splice line. This is not satisfactory in the case of printers using a resistance control of printing intensity on account of the time lag in change of intensity when the current flow through the lamp is changed over a wide range. The position of the light control relative to the splice

line depends upon the type of light control used in the printing machine. It seems evident, therefore, that before any standardized negative notching system can be used the method of light control in the printing machine must be standardized. There does not seem to be any hope of producing such standardization. As a matter of fact there is more or less time lag in any form of light change mechanism. The position of the notch relative to the splice line is conditioned by the magnitude of this time lag. Placing the notch on the splice line does not seem to meet the requirements of any of the light change systems in extensive commercial use at present. This problem also involves the consideration of an enormous footage of negative already in existence and notched according to various systems. The committee feels the only thing it can do at present is to publish the drawings showing the various notching according to various methods of printing and to urge strongly that in the design of new machinery no different methods of notching be introduced. This will serve to prevent a multiplication of the methods in use and it is possible that as time goes on commercial practice will become more and more predominantly in agreement with one present system and in this way automatically tend towards standardization.

SOUND FILM PRACTICE

The committee has prepared a drawing showing proposed dimensions relating to the position of the scanning line relative to the edge and sound track area of sound-on-film positive. This is shown in Fig. 3. This standard is in conformity with the dimensions already preliminarily adopted for the location and width of sound track presented in our last report. The dimensions are such that the scanning line falls symmetrically within the sound track area. The length of scanning line, 0.084 inch, is in conformity with present practice. We recommend this for initial adoption.

In connection with the projection of sound film it has been suggested that if each reel of film is provided with a leader on which a definite indication of the distance between a given picture and the corresponding sound is indicated, it would materially assist the projectionist in threading the film into the reproducing machine. The committee wishes to recommend, therefore, that manufacturers of this type of film provide each reel with a leader indicating clearly the framing of picture and the respective sound.

35 MM. SPROCKETS

It has been brought to the attention of the committee that the sprockets now being made by one of the leading manufacturers of projection equipment do not conform entirely with the standard dimensions as adopted by this Society. This matter has been taken up with this manufacturer and information has been submitted stating wherein sprockets manufactured by this organization differ from the standards of this Society, and also the reason for this deviation. The sprockets conform in every respect to the adopted standards with the exception of the thickness at the base of the tooth. The value specified in our standards for this dimension is 0.050 inch. The dimension being used in the manufacture of the sprockets in question is 0.060 inch, making the thickness of the tooth at the base 0.010 inch greater. It is stated that in the opinion of the mechanical experts of this organization this represents better shop practice and enables them to produce sprockets of greater precision than when using the smaller thickness value. The only consequence of this difference in thickness of tooth base is that the shrinkage range of film which will run satisfactorily over the sprocket is decreased. Sprockets made according to standard dimensions will run film under best conditions from a shrinkage of 0.13 per cent up to 2 per cent, 6 teeth in contact. Increasing the thickness of the tooth base to 0.060 inch will reduce the maximum shrinkage limit to approximately 1.5 per cent. It is contended that in practice this shrinkage limit is adequate and that a negligible amount of film showing shrinkage greater than this value is in circulation for projection. It has been stated that no complaints are being received from the trade relative to the improper handling of film by the mechanisms equipped with sprockets having the thicker tooth base. It seems wise, however, before recommending that the Society change its present standard that definite evidence be obtained showing conclusively that the shrinkage limit of 1.5 per cent is adequate to meet all of the demands of practice.

TESTING AND APPROVING EQUIPMENT

The President of the Society has received a communication from one of the manufacturers of sound reproducing equipment suggesting that the Society should consider the problem of testing and placing its stamp of approval on equipment being manufactured for the reproduction of sound. The President has referred this corre-

spondence to the Standards Committee with a request that it be given consideration. A tentative proposal to establish some such procedure as this has been sent by the manufacturer in question to other manufacturers of equipment of this nature and it is stated that all of the replies thus far received have been favorable to some such scheme. The idea involved may be best presented by a quotation from the communication in question.

"The condition which presents itself to the industry at the present time is serious in many respects and confusing to the exhibitor and the industry at large.

"The Society of Motion Picture Engineers have been in existence for a number of years and the writer's thought in the matter is that various manufacturers of sound equipment should submit their equipment to a committee appointed by the Society of Motion Picture Engineers and give a demonstration. Such equipment should measure up to the standard adopted by the Society of Motion Picture Engineers and after same has been demonstrated, satisfactorily to the Committee, it should be certified to by your organization. Of course, this may entail some expense, but this expense should be borne by the manufacturers of the equipment.

"We would like to have some expression from you as to the advisability of some action of this kind. We are sure that you would have the hearty coöperation of every distributor and producer of motion pictures, as well as the manufacturers of sound equipment."

The committee has discussed this matter at some length and feels at the present time the Society is not in a position to undertake the work suggested. Obviously it would involve a large expenditure. In order to do the work well it would be necessary to have a well equipped laboratory staffed by experts in this line. While we do not feel that this work can be undertaken by the Society, some of the members of the committee feel that perhaps in the future something of a similar type might be done and would be a real service to the industry as a whole. It is proposed, therefore, to bequeath to the next standards committee the information now at hand with the suggestion that it give consideration to the idea or to some modification thereof.

LENGTH OF TITLES

It has been suggested that the Society formulate some approximate rules relating to the length of time during which a title should be permitted to remain on the screen. The committee has not had

time, since the receipt of this request to investigate the subject thoroughly. However, inquiry has been made and it has been found that in the case of one laboratory the following rule is applied. One second is allowed per word of 6 letters, or more, up to 7 words. The minimum length of title should correspond to 2 seconds on the screen. Assuming 90 feet per minute as projection speed, this would require 1.5 feet per word of 6 letters, or more, up to 7 words with a minimum length of 3 feet. For titles containing more than 7 words, the equivalent time is decreased gradually until at 25 words the length is sufficient to allow $\frac{2}{3}$ second per word of 6 letters. From this point on the time per word remains constant at $\frac{2}{3}$ second per additional word. Before any definite recommendation can be made, however, the practice followed in other laboratories should be investigated and a recommendation formulated based upon what seems to be average good practice.

WIDE FILM

The committee has been watching with interest the developments leading to the introduction into the industry of film wider than the standard 35 mm. product. An attempt has been made to keep closely in touch with the developments and to obtain definite quantitative information as to the various proposals of the organizations interested in the wide products. This attempt has not been entirely successful since it has been impossible in some cases to obtain precise information as to the dimensions of the film which it is proposed to use. In some cases the committee has been supplied with dimension prints showing the proposed practice. The committee had hoped to be able to publish with this report dimensional drawings of the films being promoted by the various groups, but since these have not been obtained from all sources it does not seem advisable to publish any of them. However in order that the Society may have general information as to the developments in this field, we have prepared a table in which is given approximate information as to the various proposals. In some cases these dimensions have been scaled from samples of film and hence cannot be considered as representing precisely the dimensional characteristics. The various proposals which have come to the attention of the committee are as follows.

Grandeur film, which has been developed by the William Fox organization, is 70 mm. wide and employs perforations of special dimensions as indicated in column B of the table.

The Paramount-Famous-Lasky Corporation has produced a film 56 mm. wide with standard perforations, the pull-down being 4 perforations as in present practice.

RCA Photophone, Inc., it is understood, is proposing to introduce the Spoor type using a film 63.5 mm. wide. While no definite information has been obtained as to the dimensional details of the final form which it is proposed to develop, the values in column D give the dimensions taken from published reproductions of the Spoor "Natural Vision" picture.

One other proposal which, while it does not involve the use of wide film, but does give a wide picture in the theater should be mentioned. This is the proposal made by Mr. Ralph G. Fear to use the present camera and projector with an optical system attachment which rotates the image through 90° and in this manner gives a wide picture on 35 mm. film. The tentative dimensions of negative picture area available by employment of this idea are given in column A of the table.

Table of Film Dimensions for Wider Pictures

	B	C	D	A
Width of film	70 mm.	56 mm.	63.5 mm.	35 mm.
Picture width	1.840"	1.62"	2.06"	1.813"
Picture height	0.910"	0.742"	1.12"	0.800"
Perforation pitch	0.234"	0.187"	0.187"	0.187"
Pull-down no. of perforations	4	4	6	10
Perforation dimension	0.130" × 0.080"	Standard	Standard	Standard
Width of sound track	0.240"	0.125"		0.200"

It is interesting to note that practically all of these lead to pictures in which the ratio of width to height is 2 or more. This is in distinct contrast to the standard practice in which this ratio (width to height) is 1.33, and in even greater contrast to the sound-on-film positive in which this ratio decreases to approximately 1.15.

There seems to be little doubt that there is a real need for a film wider than the present 35 mm. product. Even previous to the introduction of sound it was felt by many that the picture proportion available was not well adapted to certain types of productions, being too narrow relative to its height. The necessity of using a strip on the positive film for the sound record aggravated this condition, giving a picture area approaching much too closely the pro-

portions of a square to be pleasing artistically and of practical utility from the standpoint of motion picture technic. It seems obvious, however, that the introduction of more than one wide film is highly undesirable from the standpoint of the best interests of the motion picture industry as a whole. The cost of building new equipment, including cameras, processing machinery, projectors, *etc.*, for any one new width will be great. The multiplication of widths will increase enormously the final cost to the industry of obtaining a more satisfactory picture width. The committee urges very strongly that these factors be considered and that every effort be made to reach an agreement on one standard wide film.

STANDARD APERTURE FOR PROJECTION OF SOUND-ON-FILM POSITIVES

Since the introduction of the use of positives carrying sound records, considerable confusion has resulted from the change in shape of the available picture area and no definite standard practice has been established. In some theaters it is practice to mask off one end of the screen, thus giving a picture area having a width to height ratio of approximately 1.15. In this case the regular projection lens is used. Other theaters, in an effort to retain the old picture proportion of 1.33, have used somewhat shorter projection lenses increasing the magnification sufficiently so as to fill the standard screen. This of course masks out a portion at the top or bottom, or both, of the printed positive. In some cases this is a serious objection in that it cuts out some action or seriously interferes with the composition of the picture. On the west coast this problem has been receiving the attention of various organizations and at a joint meeting of the Academy of Motion Picture Arts and Sciences, Technicians' Branch, the American Society of Cinematographers, the local section of the Society of Motion Picture Engineers, and the American Projection Society, the problem was discussed and preliminary resolutions drawn up and adopted. They are as follows:

"WHEREAS, Investigation has revealed wide variance in theater projection practices and that there is no effective standard aperture for projection of sound-on-film talking motion pictures;

Be it resolved: That as a temporary measure this committee recommends that all studios and cinematographers using sound-on-film methods make marks on the camera ground glass equally spaced from the top and bottom in addition to the mat mark for the sound track; these marks to delineate a rectangle 0.620 by 0.835 inch in size and that all vital portions of the picture be composed within these limits.

“Be it also resolved: That the committee further recommends that theaters which make a practice of reestablishing the full screen proportions from sound-on-film pictures do so by the use of an aperture whose size would be 0.600 by 0.800 inch on the basis of projection on the level, the horizontal center of the aperture coinciding with the horizontal center of the S. M. P. E. standard aperture.”

This committee has considered these recommendations and feels they represent the most satisfactory solution, at least for immediate adoption. If the lines as recommended are drawn on the ground glass of the camera and the essential action confined to this area, then the old 4 to 3 ratio of picture shape in the theater can be obtained without danger of cutting out important elements. This, of course, involves the use of a somewhat shorter focal length of projection lens and an increase of about 11 per cent in magnification. At the same time a positive without sound printed from such a negative can be projected exactly as in presound practice. The committee therefore concurs in recommending that this procedure be adopted as standard. While it is not entirely free from objectionable features it seems to represent the best compromise.

Information has been received from the International Projector Corporation that it is at the present time manufacturing two masks for insertion in the projector when sound-on-film positive is being used. One of these, referred to as the proportional mask, has an aperture of 0.800 inch by 0.607 inch, and the other, for use when it is not desired to correct the projected picture shape, has an aperture 0.800 inch by 0.6795 inch. The proportional mask dimensions coincide very closely with the Pacific Coast recommendation on this subject, there being a discrepancy of only 0.007 inch in the vertical dimension. The recommendation contained in the above resolution, however, adheres strictly to the Society's recommendation that a ratio of 3 to 4 be maintained. The committee feels, therefore, that it should approve the dimensions 0.800 inch by 0.600 inch for the proportional mask and further recommends the acceptance of the International Projector Corporation's dimensions, 0.800 inch by 0.6795 inch, for use on sound-on-film positive where correction to proportional dimensions is not desired.

SUMMARY

Recommendations Previously Approved.—The following recommendations have been presented previously and have received the first

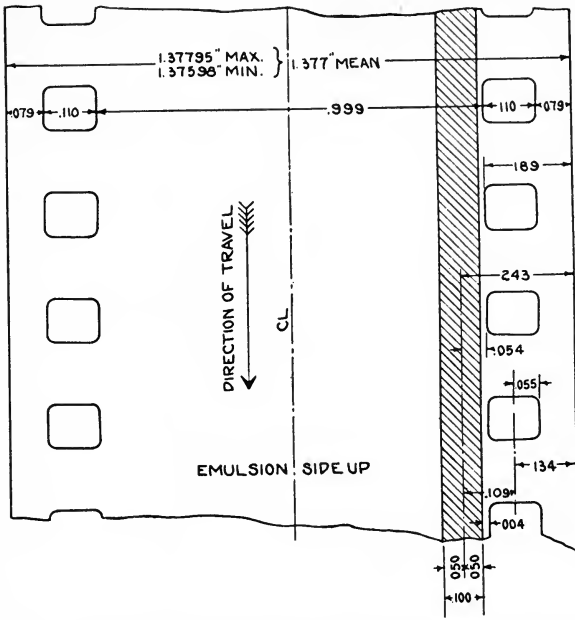

FIG. 1. Dimension and position of sound track on 35 mm. sound and picture positive.

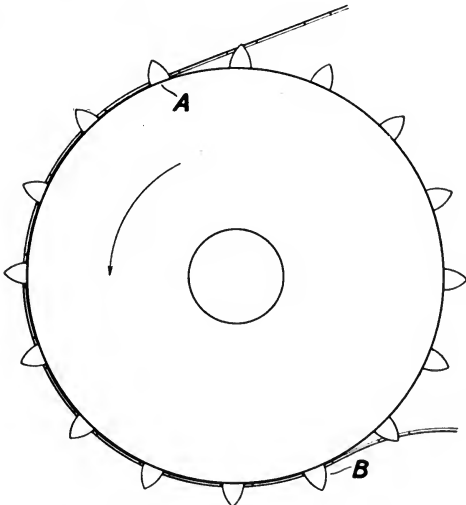

FIG. 2. Sprocket teeth in contact.

approval of the Society. They are now presented with a recommendation that you give them your second and final approval.

1. Taking speed for standard 35 mm. sound pictures shall be 24 pictures per second.

2. Projection speed for standard 35 mm. sound pictures shall be 24 pictures per second.

3. The scanning slit (for combined sound and picture on 35 mm.

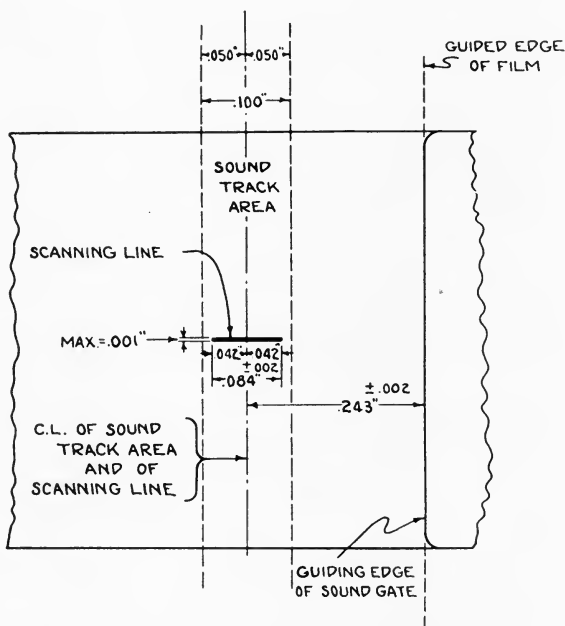

FIG. 3. Position of scanning line for sound-on-film positive.

film) shall be located at an average distance of 14.5 inches measured along the film below the center of the picture gate.

4. The location and width of the sound track on combined sound and picture positives shall be as shown in Fig. 1.

5. The number of teeth in mesh with the film (commonly referred to as "teeth in contact") shall be the number of teeth in the arc of contact of the film with the drum of the sprocket, the pulling face of one tooth being at the origin of the arc, as shown in Fig. 2.

New Proposals.—

6. The term "Safety Film," as applied to motion picture materials, shall refer to materials which have a burning time greater than ten (10) seconds and which fall in the following classes: (a) support coated with emulsion, (b) any other material on which or in which an image can be produced, (c) the processed products of these materials, and (d) uncoated support which is or can be used for motion picture purposes in conjunction with the aforementioned classes of materials.

The burning time is defined as the time in seconds required for the complete combustion of a sample of the material 36 inches long, the determination of burning time being carried out according to the procedure of the Underwriter's Laboratory. This definition was designed specifically to define Safety Film in terms of the burning rate of the commercial product of any thickness or width used in practice. The test of burning time, therefore, shall be made with a sample of the material in question having a thickness and width at which the particular material is used in practice.

7. The position and dimensions of scanning line shall be as shown in Fig. 3.

Recommended Practice.—

8. It is recommended that manufacturers of sound film place a leader on each roll of film on which is designated the framing of the picture and the corresponding sound.

9. It is recommended that the Society approve the proposals of the joint committee of the Academy of Motion Picture Arts and Sciences, Technicians' Branch, the American Society of Cinematographers, the local section of the Society of Motion Picture Engineers, and the American Projection Society relative to practice in the photography and projection of sound-on-film,

Respectfully submitted,

N. H. DREYER
A. N. GOLDSMITH
H. GRIFFIN
D. MACKENZIE
T. E. SHEA

W. R. G. BAKER
F. L. BROWN
R. S. BURNAP
G. L. CHANNIER
E. HUSE

W. B. RAYTON
V. B. SEASE
J. L. SPENCE
E. I. SPONABLE
LOYD A. JONES, *Chairman*

Errata

In No. 37 *Transactions*, Standards Report, Fig. 4, p. 38, 0.099 should be 0.109 as shown in Fig. 1 of report dated October, 1929.

DISCUSSION
SAFETY FILM

MR. TAYLOR: It is not clear to me whether the definition of Safety Film refers to a specific material as manufactured—i. e., safety stock, or to the film as actually used—of a given width, perforation, and thickness.

MR. JONES: We propose to define Safety Film in terms of the burning rate of an actually used commercial product and specifically do not want to attempt to define the combustibility of some particular chemical compound.

MR. STOLLER: Would it not be more specific to state in the specification of burning time, "according to the procedure of the Underwriter's Laboratory *as of this date?*"

MR. JONES: I think that is a good suggestion.

LOCATION OF SCANNING SLIT

MR. RICHARDSON: I believe that the committee should work on as wide a sound track as possible, the greater the width the greater the amount of overtone.

MR. JONES: The committee has been in constant contact with the sound engineers trying to obtain their reaction. It stands ready to recommend whatever experts in the field say is the best practice.

35 MM. SPROCKETS

MR. GREENE: Mr. Jones spoke of the non-conformity of one manufacturer to the sprocket standard. Was it the opinion of this concern that they got steadier running over a sprocket which differed from the S. M. P. E. standard?

MR. JONES: The information was that they felt by having a somewhat thicker metal support it allowed them to machine with somewhat greater precision; it represented better shop practice and led to a more precise sprocket which would tend to give a steadier picture.

MR. GREENE: Would it help the committee in deciding whether or not to recommend the approval of this sprocket, if they were to receive during the coming year on a blank form reports from a thousand or so projectionists in all parts of the country relative to the behavior of different grades of film on this sprocket? Shrinkage in each case could be measured with one of the film pitch rules shown us earlier in the convention.

MR. JONES: I doubt a little the wisdom of such a procedure because there are too many undetermined variables. Reports from a thousand different theaters and projectionists would make it impossible to evaluate other variables which could not be specified. It must be done in a standardizing laboratory where conditions can be controlled and everything measured under identical conditions. I should like to ask if Mr. Griffin has anything to contribute on this matter.

MR. GRIFFIN: I have nothing to add to what was submitted. We discovered by measuring up several hundred pieces of film procured from various sources that the extreme shrinkage with which the 0.050 in. base tooth was concerned was never experienced in the field. The shrinkages run far below the maximum shrinkage limit, so that we are well within the limits in using the extra 0.010 in. on the tooth. I might say that all the sprockets which we have turned out for the past three or four years have been of that dimension.

GENERAL DISCUSSION

MR. FARNHAM: This does not apply directly to Mr. Jones' report, but to many of the papers and reports presented at our conventions. Frequently, in a single illustration, some dimensions are given in English units and others in the metric system. To visualize the size of the object illustrated necessitates considerable mental gymnastics on the part of those not equally conversant with both systems. I believe the Society should make itself definite on this point of uniformity through either the Papers Committee or the Standards and Nomenclature Committee. I would suggest all dimensional figures be given in both systems. This is a practice followed by other engineering societies.

The question of the S. M. P. E. standards pamphlet was brought up. The present issue is out of print. Mr. Jones was of the opinion that reprinting should be held up pending the ratification of standards proposed in the foregoing report.

ABSTRACTS

Contribution to the Search for a New Motion Picture Frame Proportion. A. P. RICHARD. *Cinemat. franç.*, 9, Nov. 26, 1927, pp. 54-5. A picture frame having the dimensions 18 by 30 mm. is proposed for 35 mm. film. The perforations would be placed between pictures.

Difficulties of the Sound Films. *Lichtbildbühne*, 21, Nov. 10, 1928, pp. 22-3. Aside from reproduction, amplification, and acoustic problems in connection with sound presentation, difficulties such as omissions and physical damage (ground noise) in the film record are important. A special idler roller, patented by a German firm, does not touch the sound record in its travel over the sprocket. (This device is especially useful with the film made by the firm because the sound record is between the perforations and the film edge.—*Abstr.*) The roller is only slightly longer than the distance between perforations and is notched to match the sprocket teeth. It rotates like a gear in mesh with the sprocketed teeth. Mention is made of the Tri-Ergon 42 mm. film in which the sound record is carried near the center of the extra 7 mm. width. Condenser loud speakers are briefly described.

This Matter of Volume Control. C. DREHER. *Mot. Pict. Projectionist*, 2, February, 1929, pp. 11, 20-1. The author summarizes the principal faults of volume in the sound motion pictures as follows: (1) General level of speech reproduction too high. (2) Failure of volume to follow the action or to maintain a natural proportion. (3) Abrupt jumps from one musical selection to another as scenes change. (4) Inability to adapt sound reproduction to audience reaction in special cases.

Slits Mechanical vs. Optical. *Mot. Pict. Projectionist*, 2, July, 1929, pp. 16-7. The major troubles with mechanical slits are: (1) The process of manufacturing a fine slit in a metal plate is so difficult that the results often vary. (2) The slit does not allow all the available light to pass. (3) The slit becomes dirty and clogged which interferes with projection or recording. The optical slit overcomes these difficulties.

Perspective in Photography. F. F. RENWICK. *B. J.*, 75, Dec. 14, 1928, pp. 750-2. An analysis from the geometrical viewpoint of the true perspective in photographs. Objects separated by considerable distances can be seen sharply and simultaneously with one eye (as with the camera) but when two eyes are used, only one plane of the object can be appreciated clearly at one time. Complete examination of a scene in both depth and area is necessarily a complicated operation involving many rapid movements of the eyes with adjustments of focus of the eye lenses. Photographs usually possess correct geometrical perspective and depict sharply a far wider angle than is seen by the eyes focused on one point. Artists rarely include an angle greater than 40° in pictures, but photographs often include as much as 75°. Artists add naturalness to their work by separating the vanishing points; photographers either take the picture with a long focus lens (which if carried too far results in a loss of solidity or soundness) or else use a short

focus lens and enlarge the picture to produce the desired effect. It is suggested that views seen with two eyes might be simulated by using a twin lens camera adapted to give a fused image single and sharp only for the principal object.

Cinematographic Record of Sunrise on the Moon. R. F. ARNOTT, E. G. F. ARNOTT, A. L. BENNETT, and J. Q. STEWART. *Nature*, **124**, July 13, 1929, pp. 56-7. A camera taking 16 mm. film was used at the focal plane of a refractor of 30 ft. focal length, and exposures of about $3\frac{3}{4}$ secs. were made at intervals of 6 secs. for about 4 hrs. The results were in some ways unsatisfactory but an interesting film was secured of a region about 200 by 300 miles around Copernicus.

Theory of the Photographic Processes. H. KIESER. *Z. wiss. Phot.*, **26**, April, 1929, pp. 321-40. The author gives hypotheses of the formation of the photographic latent image on the basis of the photoconductivity (inner photoelectric effect) combined with Einstein's equivalence law of photochemical processes. First he discusses the action of water in the gelatin as a bromine absorber. Solarization is explained by Lüppo-Cramer's theory—that the photolytically formed silver at the surface of the silver halide grain is destroyed by halogen, liberated by the photolytic decomposition within the grain, that migrated to the surface. The solarization on plates which were first fixed and then developed is caused by a coagulation of the silver during fixation. The Clayden and Villard effects (reversal phenomena on lightning pictures and X-rays) are regarded as closely connected with solarization. They differ from solarization in that the latent image lies deeper within the grain. The regression attacks more the ripening nuclei than the photolytically formed silver. The failure of the reciprocity law, and the intermittency effect are explained by regression. During this regression not only photolytically formed silver is bromated but also the ripening nuclei as in the case of solarization. The optical sensitizing with dyes is possible if the excited dye molecule excites the neighboring bromine ions in the crystal lattice. Desensitizers are substances which have electron affinity; they are not able to excite the bromine atoms so that a regression with an already formed silver atom by the liberated bromine atoms takes place. The Herschel effect is explained by comparison with the solarized silver halide grain, which has a greater number of developable nuclei within the grain than on the surface of the grain. Infra-red and red light penetrate the grain and liberate electrons, which establish a regression within the grain. A number of free electrons migrate to the surface of the grain and form in the layers with less nuclei new silver atoms which introduce developability.

Color Camera Making Rushed to Get Set for Increased Use Next Season. *Ex. Herald World*, **96**, July 6, 1929, pp. 70, 131. Plans are announced by Technicolor, Inc., to increase the number of color cameras from 12 to 50 and the capacity of the processing laboratories from 12,000,000 to 100,000,000 feet of film per year. Three improvements in the process are described. (1) The use of a negative film requiring no more light for exposure than black and white film; (2) the application of the final color records on one side, instead of both sides of the film as previously required; and (3) the possibility of using three basic colors instead of two as formerly used. The color camera contains a prism which divides the image into two parts; one is passed through one ray filter, and the other through the next in succession at the negative film. This negative record is "printed" by a mechanism which exposes every alternate frame, so that the red corrected pictures appear

on one continuous film and the blues on another continuous film. These prints are developed to give a film covered with minute hills and dales, much like an engraving plate. The celluloid plate is hardened, dyed, and run under pressure, along a steel plate in contact with a transparent film on which the dye image is printed. Then the other film containing the second color record is printed on the transparent film now bearing the first record. Fatigue tests made on audiences have shown that color motion pictures are less tiring than black and white and still less than reading news print for over an hour.

Story of Stereoscopic Motion Pictures. C. BARTH. *Plastische Bild*, No. 9/10, Sept.-Oct., 1928, pp. 98-102. A review of systems for the production of stereoscopic motion pictures. Some of the first attempts consisted in projecting separate images side by side of a subject taken from two points of view. Special prism glasses were used to view the pictures, and it was necessary that the observer be equidistant from the two pictures. Another method used images projected alternately on the same screen. Glasses with shutters synchronized with the projector allowed the observer's eye to see the image from its corresponding point of view. Other stereoscopic systems employed are: (1) Complementary monochrome images projected on the same screen, to be observed through corresponding complementary filters for each eye; (2) plane polarized light for projection and observing glasses with nicol prisms; and (3) images projected through gratings placed near the screen and observed from a different position through similar gratings.

Putting the Light Where You Want It. *Amer. Cinemat.*, 10, April, 1929, p. 13. Curves for luminous flux are given for a two-lamp broadside and a high efficiency reflector. The latter directs 45% of the light within a 60° angle, compared with 15% by the broadside. Silvered glass and aluminium are compared as reflectors, the advantage lying with the glass.

Magnesium Light for Photography and Cinematography. BRILLE. *Bull. soc. franç. phot.*, 17, June, 1928, p. 156. This magnesium flare consists of a tube containing a pile of disks or balls of magnesium making only slight contact with each other. The space around them can contain an oxidizing substance. The small area of contact between the pieces of magnesium decreases the rate of propagation of the combustion down the tube and gives a light of long duration.

Incandescent Lighting Improves. R. E. FARNHAM. *Amer. Cinemat.*, 10, April, 1929, pp. 31-3. Four thousand eight hundred lamps, totaling 3900 kw., have recently been used on a Universal set. Portable lamp equipment is in favor. The 10,000 watt lamps now contain tungsten powder for mechanically removing blackening from the bulb. Small bare lamps are favored for natural starlight effects.

Maximum Light for Projection with a Minimum of Heat. M. SCHOLZ. *Filmtechnik*, 4, Dec. 22, 1928, pp. 512-4. The use of mirrors and condensers of heat-absorbing glass or crown glass mirrors and condensers protected from the heat by plates of heat-absorbing glass is advocated. Graphs are included which show: (1) Temperature increase of different condenser lenses with an increase in the light flux. (2) The relative transmission of heat and visible light from an arc source with glass of varying thickness. (A plate of 1 mm. thickness transmitted about 80% visible and 50% heat, compared with 50% visible and 10% heat for a thickness of 5 mm.)

Description of the Mechanical and Optical Principles of the Mechau Projectors. L. BURMESTER AND E. MECHAU. *Kinotechnik*, 10, Aug. 5, 20, Sept. 5, 1928, pp. 395-401, 423-6, 447-51. Uniformity of illumination as the film travels across the first condenser, and the provision of an optically imaged gate for continuous projection are considered. Light from the crater of an arc is collected by a reflector and projected on a condensing lens which forms on an aperture an image of it proportional in size to the film frame. The light after passing the lens is collimated and reflected by a tilting mirror and collected by another lens combination which images the first aperture on the film at a magnification sufficient to fill one frame. On the other side of the frame is a Petzval form of projecting lens which delivers parallel rays to a second tilting mirror. These rays are collected and thrown on the screen by a final projecting lens. The 8 mirrors, situated vectorially round a disk, are actuated by the revolution of the disk. Each revolution brings 4 consecutive pairs of mirrors into operation and corresponds to 4 frames.

Zoechrome. *Kinemat. Weekly*, 145, Mar. 21, 1929, pp. 69-70. The Zoechrome process of color motion pictures, invented by T. A. Mills, was shown at a demonstration in London. One double length negative is used. Every alternate space of 8 perforations is occupied by a complete negative image of the object, while the intermediate spaces are occupied by $\frac{3}{4}$ size images taken through filters cutting out the red, blue, and yellow-green, respectively. The black and white negative is taken with an $f/3.5$, 3 in. lens, while the color-selective negatives are made with three lenses of about $f/4.0$ and of shorter focus, bunched together to reduce parallax, and placed immediately below the main lens. All four lenses are mounted together for focusing. In printing, the alternate full images of the negative are printed in immediate succession; the positive is developed as usual, varnished, and then recoated with emulsion. One of the small images is printed by enlargement in register with the key image, developed, and dye-toned. The film is again varnished, and recoated with emulsion and the cycle of operations is repeated for the two remaining colors. The final film is no thicker than ordinary film. - On a basis of an output of 50,000 ft. a week the cost is figured at 5 cents a foot.

Rapid Cameras. *Lichtbildbühne*, 21, Nov. 3, 1928, pp. 16-9. Short history of the development of high-speed cameras is given. The French scientist Marey used a high-speed camera as a scientific implement and attained velocities of 140 exposures per second with a simple intermittent mechanism. Paper negative was used in the earliest tests. His successor, by using a double pull-down, was able to attain speeds of 250 pictures per second. Mention is made of rapid cameras which use continuous moving film. In one type for certain kinds of subjects the light source is intermittently flashed and speeds of 2000 to 100,000 exposures per second are possible. The Lehmann "Zeitlupe" introduced in 1916 employed optical compensation in the form of a rotating mirror-wheel, and could be operated either at normal rate or as much as 300 to 500 pictures a second. Modern high-speed cameras briefly described are the Debie, Askania, Lyte, Bell and Howell, and the Thun "Zeitdehner." The last named camera employs continuous moving film and a rotating wheel of lenses, with which velocities greater than 4000 exposures per second are possible.

BOOK REVIEWS

Speech and Hearing. H. FLETCHER. *D. Van Nostrand Co., Inc.*, New York City, \$5.50. 331 pp. The book is arranged in four parts to deal with the topics: (a) speech, (b) music and noise, (c) hearing, and (d) the perception of speech and music. Among the subjects discussed are the organs and the mechanism of speech and hearing, recording instruments, speech power, audition limits, acuity of hearing, and the various factors affecting the perception of speech and music. The book has much experimental and theoretical information.

Motion Pictures with Sound. J. R. CAMERON. *Cameron Publishing Co.*, Manhattan Beach, New York, 1929, \$5.00. 393 pp. There is a brief description of developments in sound picture reproduction from Edison's early attempts in 1886 to the latest methods of reproduction. General information, in popular language, is given on sound transmission, the phonograph, telegraphy and telephony, vacuum tubes, and light-sensitive cells. New methods of lighting studio sets with incandescent lights have been adopted as well as new silent running cameras for sound work. The methods in common use for recording and reproducing sound are: Recording with the light valve, R. C. A. Photophone, Movietone, Bristolphone, Vitaphone, Cinephone, Simotone, and Phonofilm. Construction details of each are given, followed by instructions for operating R. C. A., Movietone, and Vitaphone equipment. The following types of amplifiers are in use: Samson Pam, and Silver-Marshall phonograph, and Rack and Panel ("PA") amplifiers. Characteristics of the Western Electric horns, R. C. A. horns, and electro-dynamic speakers are enumerated. Other chapters give information on the new sound screens, film splicers, film speed indicators, and storage batteries. The Telegraphone is announced as still being at the experimental stage; this, instead of having a disk or sound track on film record, depends on a variably magnetized wire for its sound record.

Colour and Colour Theories. C. LADD-FRANKLIN. *Harcourt, Brace and Co.*, New York, 1929. 287 pp. A complete discussion of three color theories, namely: (a) Trichromatic, with no yellow and no white (Helmholtz). (b) Tetrachromatic with white added (Hering). (c) Three stage evolution (Ladd-Franklin). In the first stage, the elements are black and white, in the second stage, yellow and blue are added, and in the third, red and green. The outer zone of the retina is still in the front stage, the intermediate zone in the second, and only the central area of the retina has reached the third. In red-green blind individuals, the central area remains in the second stage, and in the totally blind the whole retina is still in the first stage.

Yearbook for Photography, Cinematography, and Reproduction Processes, for the Years 1921-7. (*Jahrbuch für Photographie, Kinematographie und Reproduktionsverfahren für die Jahre 1921-7.*) Vol. 30, Parts I and II. J. M. EDER AND E. KUCHINKA. *W. Knapp*, Halle (Saale), 1928, \$7.50. 480 pp. 960 pp. The previous volume of this excellent review of photographic progress covered the years 1915-20. Part I deals with apparatus for various kinds of photographic

work. A historical review prefaces a description of cameras of all types, film holders, shutters, exposure meters, camera supports and tripods, studios, *etc.* Developments in lens design are comprehensively treated. Apparatus for processing films and papers are discussed, including enlargers, reducers, and projectors. Equipment for applications of photography and processes of color photography are described. Part II deals with cinematography, color sensitizing and desensitizing, and physical and chemical actions of the photographic emulsion. A list of some of the important subjects covered includes spectrum photography, luminescence, sensitometry, the foundation of photographic negative processes, photochemistry, radiations, silver bromide gelatin, emulsion making, dry plates, and film.

SOCIETY OF MOTION PICTURE ENGINEERS

OFFICERS

President

J. I. CRABTREE, Eastman Kodak Co., Rochester, N. Y.

Past President

L. C. PORTER, Edison Lamp Works, Harrison, N. J.

Vice-Presidents

H. P. GAGE, Corning Glass Works, Corning, N. Y.

K. C. HICKMAN, Eastman Kodak Co., Rochester, N. Y.

Secretary

R. S. BURNAP, Edison Lamp Works, Harrison, N. J.

Treasurer

W. C. HUBBARD, Cooper-Hewitt Electric Co., Hoboken, N. J.

Board of Governors

R. S. BURNAP, Edison Lamp Works, Harrison, N. J.

H. T. COWLING, Eastman Teaching Films, Inc., 343 State St., Rochester, N. Y.

J. I. CRABTREE, Research Laboratory, Eastman Kodak Co., Rochester, N. Y.

H. P. GAGE, Corning Glass Works, Corning, N. Y.

K. C. HICKMAN, Research Laboratory, Eastman Kodak Co., Rochester, N. Y.

W. C. HUBBARD, Cooper-Hewitt Electric Co., Hoboken, N. J.

W. C. KUNZMANN, National Carbon Company, Cleveland, Ohio.

D. MACKENZIE, Bell Telephone Labs., 463 West St., New York, N. Y.

P. MOLE, Mole-Richardson, Inc., 941 N. Sycamore Ave., Hollywood, Calif.

L. C. PORTER, Edison Lamp Works, Harrison, N. J.

S. ROWSON, Ideal Films, Ltd., 76 Wardour St., London, W. 1, England.

E. I. SPONABLE, Fox-Hearst Corp., 460 West 54th St., New York, N. Y.

SolicitationE. P. CURTIS, *Chairman*

J. W. COFFMAN

E. A. WILLIFORD

Standards and NomenclatureA. C. HARDY, *Chairman*

M. C. BATSEL

P. H. EVANS

W. B. RAYTON

W. H. CARSON

H. GRIFFIN

V. B. SEASE

A. DEBRIE

R. C. HUBBARD

T. E. SHEA

L. DEFOREST

L. A. JONES

J. P. SPENCE

J. A. DUBRAY

N. M. LAPORTE

E. I. SPONABLE

E. W. ENGSTROM

W. P. POWERS

L. T. TROLAND

G. F. RACKETT

Studio LightingA. C. DOWNES, *Chairman*

L. J. BUTTOLPH

R. E. FARNHAM

M. W. PALMER

K. C. HICKMAN

Theater LightingC. E. EGELER, *Chairman*

F. A. BENFORD

F. FALGE

E. HUSE

A. C. DOWNES

R. E. FARNHAM

L. A. JONES

C. GREENE

LONDON SECTIONSIMON ROWSON, *Chairman*A. NEWMAN, *Vice-Chairman*PAUL KIMBERLEY, *Manager*L. EVELEIGH, *Secretary*ALAN WILLIAMSON, *Manager*H. WOOD, *Treasurer*WILLIAM VINTEN, *Manager***PACIFIC COAST SECTION**P. MOLE, *Chairman*C. DUNNING, *Manager*G. F. RACKETT, *Sec.-Treas.*E. HUSE, *Manager***Membership Committee**J. COURCIER, *Chairman*

E. JEWELL

Papers and ProgramsE. HUSE, *Chairman*

Membership

in the

Society of Motion Picture Engineers

is open to all who are engaged in any branch of the motion picture industry or allied work. The society is international in character and its convention papers with complete discussions are furnished free to members.

REASONS WHY

YOU

SHOULD JOIN

The Society of Motion Picture Engineers

- 1—The S. M. P. E. is an internationally recognized organization of Motion Picture Engineers.
- 2—The S. M. P. E. is becoming an ever more important factor in developing, stabilizing, and standardizing the motion picture industry.
- 3—At two conventions each year reliable data concerning a wide range of subjects are presented long before they become available elsewhere.
- 4—Papers read at conventions are printed with full discussions in a monthly Journal and distributed free to all members.
- 5—The S. M. P. E. affords unique opportunities for personal contact with leaders in the industry.
- 6—S. M. P. E. publications are recognized standard authority on Motion Picture Engineering.
- 7—The S. M. P. E. will help you in many ways. Join now.

COUPON

HERFORD TYNES COWLING, *Chairman*
Membership Committee, Society of Motion Picture Engineers
343 State Street, Rochester, N. Y.

Dear Sir—

Please mail application blank and requirements for membership in the S. M. P. E. to—

Name.....
(Please print)

Position.....
(Company or other Affiliation)

Street and City Address.....

Name.....

Position.....

Street and City Address.....

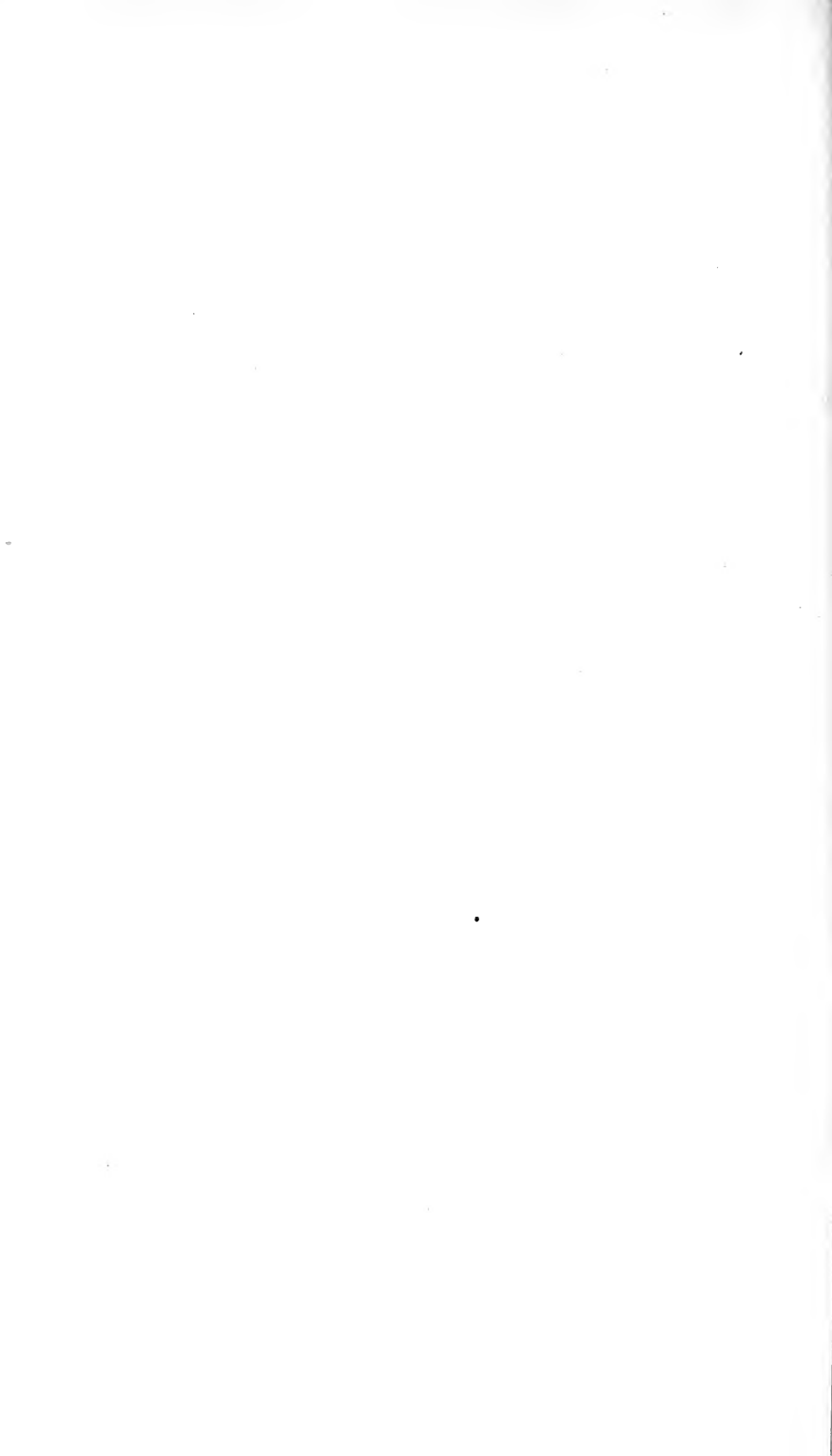

JOURNAL

OF THE SOCIETY OF

MOTION PICTURE ENGINEERS

LOYD A. JONES, EDITOR *pro tem.*

Associate Editors

G. L. CHANIER
O. M. GLUNT
A. C. HARDY

P. MOLE
W. B. RAYTON
P. E. SABINE

S. E. SHEPPARD
J. L. SPENCE
L. T. TROLAND

Volume XIV

FEBRUARY, 1930

Number 2

CONTENTS

	Page
Theater Acoustics for Sound Reproduction.....S. K. WOLF	151
Loud Speakers for Use in Theaters.....	
D. G. BLATTNER AND L. G. BOSTWICK	161
Art and Science in Sound Film Production..JOE W. COFFMAN	172
Photographic Characteristics of Sound Recording Film.....	
LOYD A. JONES AND OTTO SANDVIK	180
The Modern News Reel.....HARRY W. JONES	204
Film Perforation and Its Measurement..WALTER H. CARSON	209
The Human Equation in Sound Picture Production.....	
TERRY RAMSAYE	219
Progress in the Motion Picture Industry. Report of the Progress Committee.....	222
Abstracts.....	259
Book Reviews.....	262
Officers.....	264
Committees.....	265
List of New Members and Transfers.....	267
Society Notes.....	267

Published Monthly by the
SOCIETY OF MOTION PICTURE ENGINEERS
20th & Northampton Sts., Easton, Pa.
Editorial Office: 343 State St., Rochester, N. Y.

Subscription to non-members \$12.00 per year, single copies \$1.50. Order from the Secretary of the Society of Motion Picture Engineers, 5th & Sussex Streets, Harrison, N. J.

Copyright
BY THE SOCIETY OF
MOTION PICTURE ENGINEERS

PERMANENT MAILING ADDRESS OF THE SOCIETY

Engineering Societies Building
29 West 39th Street
New York, N. Y.

Papers or abstracts may be reprinted if credit is given to the Journal of the Society of Motion Picture Engineers.

The Society is not responsible for statements made by authors.

Application pending for entry as second-class matter at the Post Office at Easton, Pa.

THEATER ACOUSTICS FOR SOUND REPRODUCTION

S. K. WOLF*

The advent of sound pictures is, no doubt, the chief single cause of the practical importance now conceded to acoustics. The science of acoustics is being greatly extended and altered by this most popular diversion.

Professor Wallace C. Sabine was the first to study architectural acoustics with practical as well as academic interest. For years after the first publication of his results, commercial interest was entirely lacking. Although theatrical interest in acoustics is limited almost solely to its practical phases, a theoretical study must also be maintained for the advancement of the science. Advances in our knowledge of acoustics, as well as in the physiology of hearing, have materially aided us in the study of practical acoustics.

During our brief study of theater acoustics, for reproduced speech, we have found the empirical deductions of Sabine and others, whose study was made for original speech conditions, are not wholly applicable to acoustics for sound reproduction in their present form. Differences in acoustic requirements for original and reproduced speech have been observed by other workers in the field of acoustics. Dr. W. H. Eccles in a recent address entitled, "The New Acoustics," identifies the field of acoustics dealing with the reproduction of sound as "electro-acoustics."

The first important observation, in our study of electro-acoustics, was that theaters theoretically meeting the optimal periods of reverberation advocated by Sabine and others were not as satisfactory for sound reproduction as would be expected. The second observation was that some theaters were more satisfactory for reproduced sound although these theaters had lower periods of reverberation. In the two foregoing observations the reproduction of speech as well as music was considered, resulting in what we believe to be a fair compromise. Being convinced that lower periods were desirable

* Electrical Research Products, Inc., New York City.

for reproduced sound than for original sound our problem was then to determine the cause of this discrepancy.

Reverberation vs. Intensity.—Our first and perhaps the most obvious consideration was the inherent difference in sound intensities of original speech and reproduced speech. In large theaters it is necessary to increase sound intensities in order to obtain proper distribution throughout the audience. There is, in addition, the psychological effect due to increased size of characters on the screen as compared with stage characters. Aside from the theoretical considerations there are those of carelessness, resulting in the improper level of

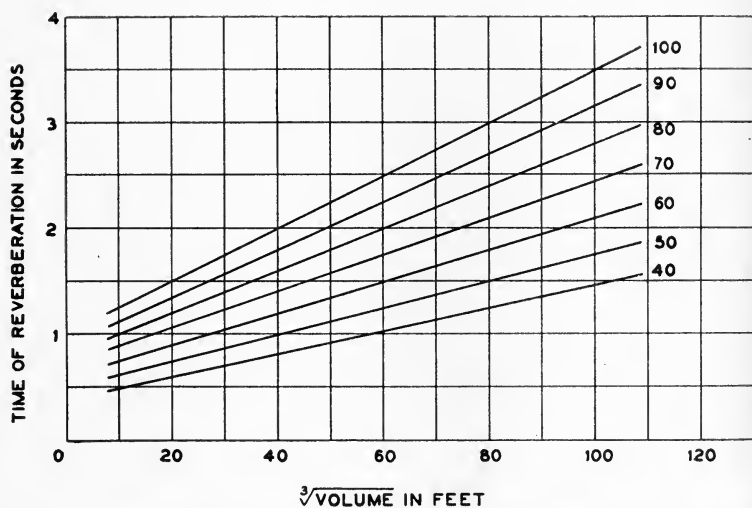

FIG. 1. Relation of reverberation time to volume of an auditorium at various loudness levels above the threshold of audibility.

operation of the reproducing system. This fact is often brought to our attention by friends who have been driven out of theaters by the deafening level at which reproducing systems are sometimes operated. Even today there are Broadway houses where pictures of unusual merit and excellent recording are shown which nevertheless lose patrons nightly because of the discomforting and unnatural sound level at which the program is being reproduced. However, this paper is concerned only with proper level operation.

In determining theoretically the magnitude of the effect of increased sound intensity on the factors affecting reproduction, we naturally

consider first, the most important and most serious obstacle to good acoustics—*reverberation*.

From the work of Sabine, Jaeger, Buckingham, and others, who have laid the foundation for our present accepted theory of reverberation, we are able to evaluate the effects of increased intensity on reverberation. From these effects we have described, graphically, a family of curves showing the time of reverberation in relation to the size of the theater. These various sound intensity relations have been computed at intervals of ten decibels, from 40 to 100 above the threshold of hearing, at C-4 or 512 cycles. These curves are shown in Fig. 1. The curve of 60 decibels represents a million times the threshold intensity, and is the intensity used by Sabine, and others, in the standard method of measuring the time of reverberation.

The following is a list of symbols which will be used throughout this discussion.

- V = volume of the room in cubic meters.
- E = acoustic output of source of sound in ergs per second.
- I = energy density expressed in ergs per cubic meter.
- I_0 = steady state of energy density.
- i = threshold of audibility.
- t_1 = time of reverberation in seconds.
- K = substitution constants.
- v = velocity of sound in meters per second.
- p = mean free path of any sound element between reflections.
- a = total absorbing power of the room.
- S = total area of bounding surfaces.
- $\frac{v}{p}$ = average number of reflections per second.
- $\frac{a}{S}$ = mean absorption coefficient.
- A = constant of proportionality, the ratio of the rate of decay of the residual sound to the intensity at the instant.

Derivation of Steady State and Reverberation Time Relations.—The rate of change of the average sound intensity due to absorption at the bounding surfaces of the room is given by

$$-\frac{dI}{dt} = AI \dots \dots \dots (1)$$

The rate of change of energy density in the room with the source speaking is

$$\frac{E}{V} - AI = \frac{dI}{dt} \dots\dots\dots(2)$$

Under the steady state conditions at which absorption at the boundaries is just balanced by generation of sound energy at the source, the energy density or intensity I_o is

$$\begin{aligned} \frac{E}{V} - AI_o &= 0 \\ I_o &= \frac{E}{VA} \dots\dots\dots(3) \end{aligned}$$

For the transient condition of decay we find that by integrating (1) and supplying the steady state constants the solution becomes

$$At = \log_e \frac{I_o}{I} = \log_e \frac{E}{VAI} \dots\dots\dots(4)$$

From this we find if t_1 is the time required for the energy density level to decrease to i , the threshold of audibility, that (4) becomes

$$At_1 = \log_e \frac{E}{VAi} \dots\dots\dots(5)$$

By the kinetic theory we find that the mean free path may be thus expressed

$$p = \frac{4V}{S} \dots\dots\dots(6)$$

But by the general theory

$$A = \frac{v}{p} \times \frac{a}{S}$$

or substituting (6)

$$A = \frac{av}{4V}$$

Thus equation (5) becomes

$$\frac{av}{4V} t_1 = \log_e \frac{4E}{avi}$$

or

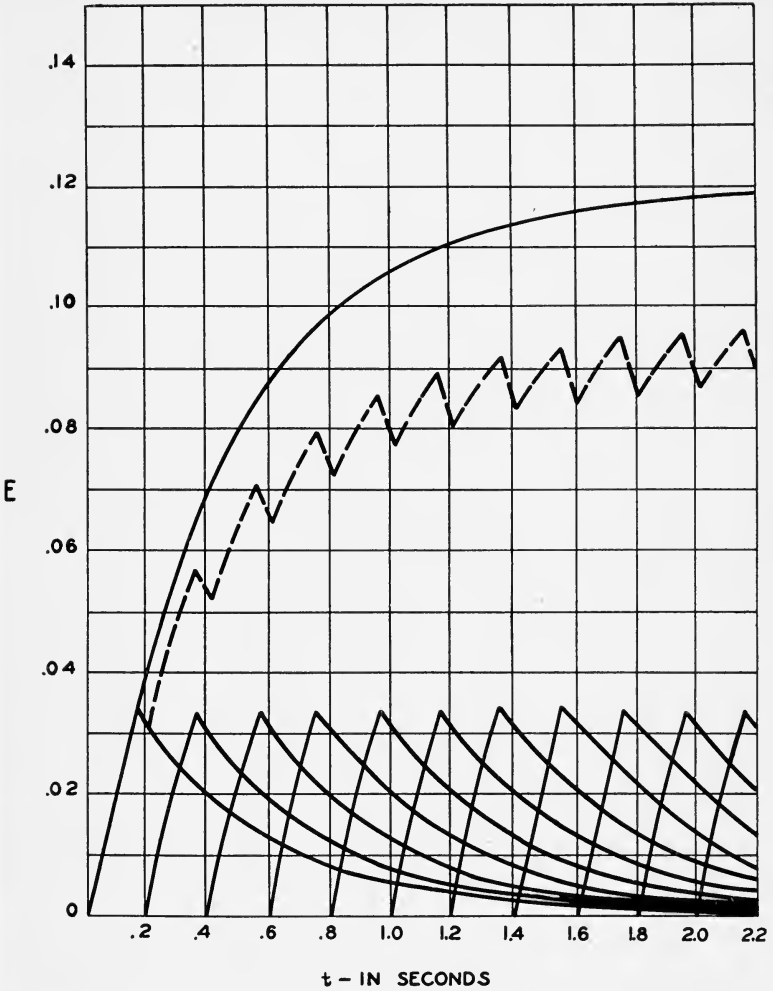

FIG. 2. Growth and decay of sound intensity for syllable emission originally produced in an auditorium having excessive reverberation time.

$$at_1 = \frac{4V}{v} \log_e \frac{4E}{avi} = 9.2 \frac{V}{v} \log_{10} \frac{4E}{avi} \dots\dots\dots (7)$$

For the particular problem involved we have then two available equations to use, namely

$$I_o = \frac{4E}{av}$$

and

$$t_1 = 9.2 \frac{V}{av} \log_{10} \frac{4E}{avi}$$

Theoretical Component Reverberations.—The effect of reverberation on the quality of original speech is admirably shown in the work of

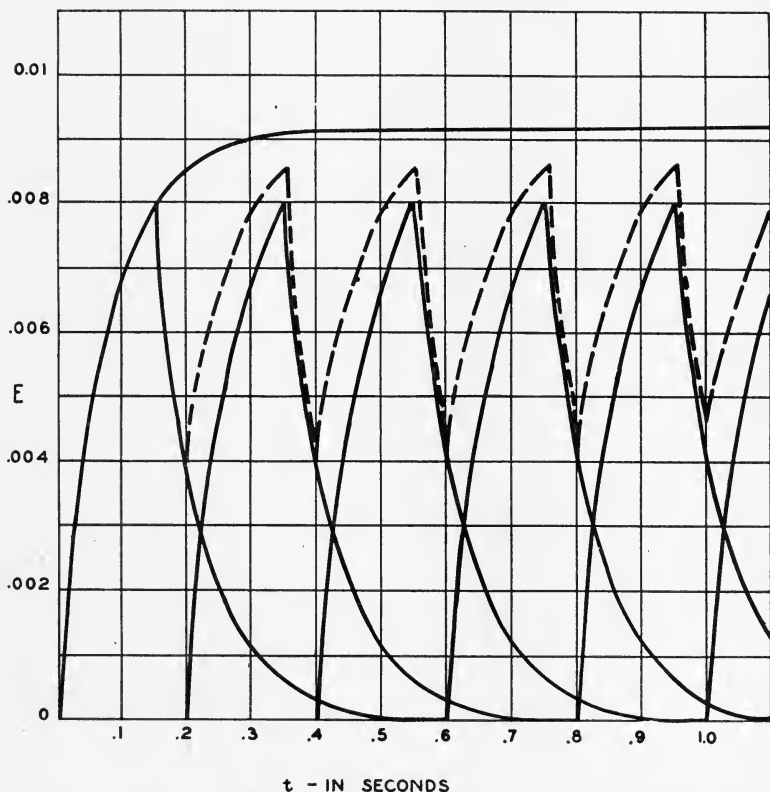

FIG. 3. Growth and decay of sound intensity for syllable emission originally produced in an auditorium having acceptable reverberation time.

Dr. Eckhardt. In Fig. 2 are shown the intensity and growth curves and decay curves of a number of successive syllables computed for a room of small absorbing power. The total intensity curve for the room is obtained by adding the intensity time curves of all syllables. This curve is shown by the dotted line in Fig. 2, and clearly illustrates the effect of reverberation on intelligibility. In Fig. 3 the values

are shown for a room in which the interior finish has been provided with sufficient absorbing material to produce the proper period of reverberation for original speech. It is clear, from a comparison with Fig. 2, that a more satisfactory condition of intelligibility could be expected. Fig. 4 carries the absorption of sound one step farther, producing a highly damped condition. In this case, the intensity of each syllable practically reaches the saturation value for continuous emission at the same rate. Fig. 4 also shows that very little sound intensity of a syllable remains when the succeeding syllable begins.

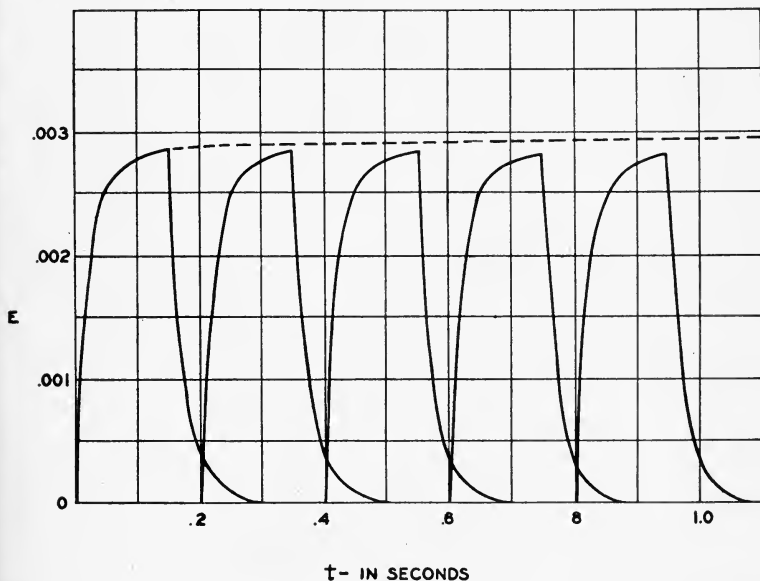

FIG. 4. Growth and decay of sound intensity for syllable emission originally produced in an auditorium having too small reverberation time.

Fig. 5 is a theoretical curve showing the combined effects of studio and theater reverberation on reproduced sound. It seems logical to assume that the combined effects of sound growth in a studio and sound growth in a theater will produce an intensity growth curve, the slope of which will never be greater than, and generally less than, that for direct speech. The assumption is based on the fact that the sound source in the theater is not constant and is less continuous than the original sound. Likewise, in considering the decay curve, resulting from the combined effect of the studio and theater acoustic condi-

tions, we would expect the rate of decay never to be greater than, and generally less than, that of original speech. These combined effects, of both studio and theater growth and decay, will tend to increase the duration of reproduced sound over original sound. From these phenomena we may deduce that reproduced sound will always require shorter periods of reverberation than will original sound. This factor is likely to be somewhat small. Under practical conditions and to the average hearer, these differences are not as great as the theoretical curves would indicate; nevertheless they should be con-

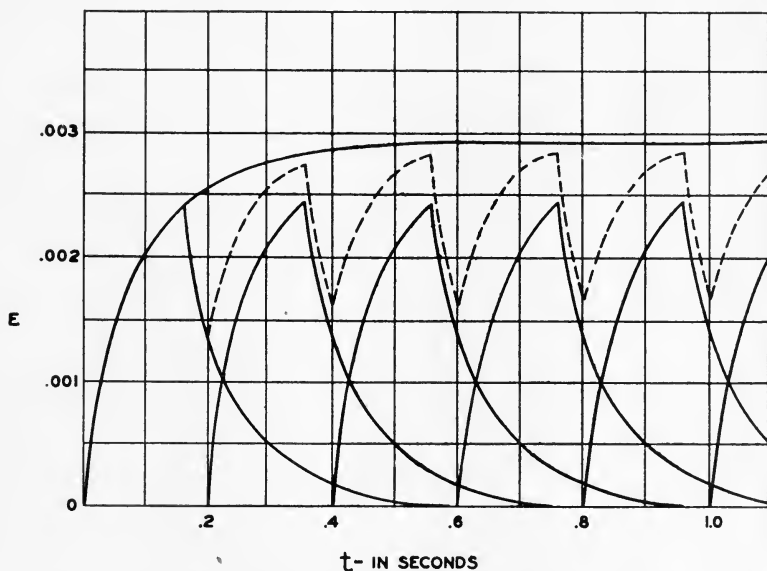

FIG. 5. Theoretical curve showing growth and decay of sound intensity for syllable emission reproduced in an auditorium having too small a reverberation time for direct audition.

sidered—particularly because an accumulative effect is produced under the existence of increased intensity of reproduced sound.

Reproduced Speech Intensity vs. Original Speech Intensity.—If we assume that the average increased level of reproduced speech intensity over original speech intensity is of the order of magnitude of 10 decibels, we may determine the proper relative time of reverberation for reproduced speech as the time of reverberation varies directly with the intensity in decibels. This conclusion having been reached, and knowing the curves of Sabine, and others, to be based on 60 decibels

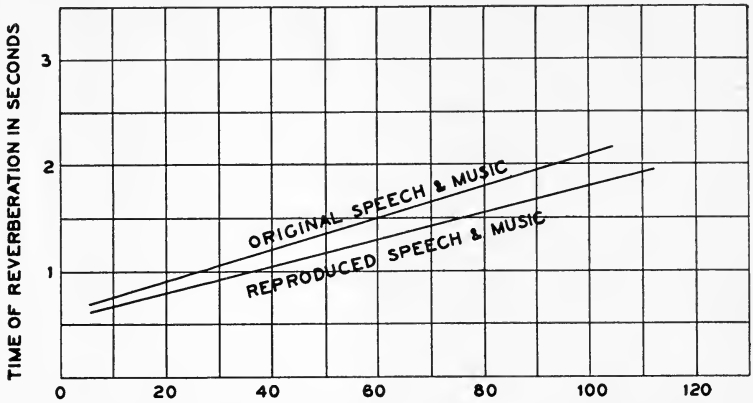

FIG. 6. Calculated optimum reverberation time for reproduced speech in comparison with that for original speech.

for original speech, we may determine the optimum curves for reproduced sound by the simple ratio of 60 to 70. This relation is shown in Fig. 6.

Comparison of Optimum Reverberation Times.—A large number of theaters were selected to determine, in a practical way, the optimum

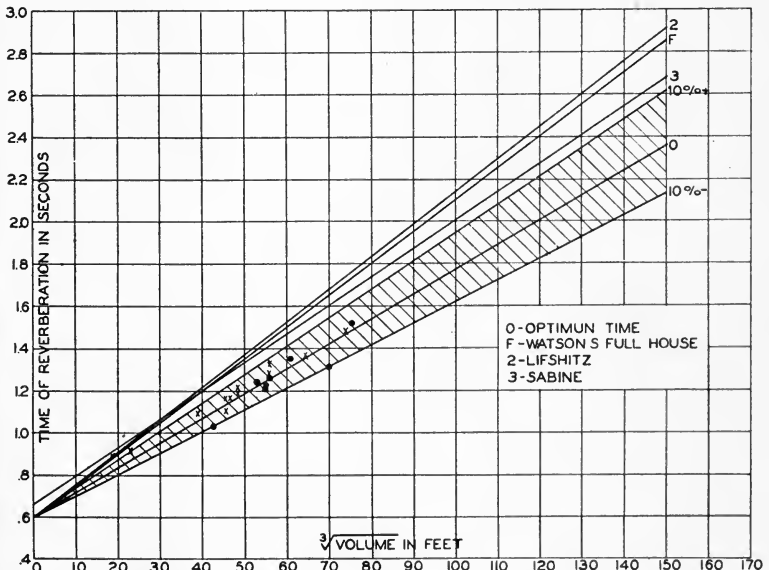

FIG. 7. Optimum reverberation times as advocated for original sound by Watson (F) Lifshitz (2) Sabine (3) and for reproduced sound (O).

time of reverberation for sound reproduction. These theaters were all considered to be excellent by competent observers for sound reproduction as judged on a qualitative basis. We have subjected them to a quantitative analysis to determine their characteristics for sound reproduction. Fig. 7 shows the comparison of optimum reverberation times that have been advocated and the relative location of the selected theaters. Curve 2 shows Lifshitz' advocated optimum time of reverberation. Curve *F* shows Watson's full house values and curve 3 shows the optimum times of reverberation advocated by Sabine. The curve labeled "O" is an optimum time of reverberation which we believe to be an optimum for reproduced sound.

REFERENCES

- ECKHARDT, E. A.: "Acoustics of Rooms," *Jour. Frank. Inst.* (June, 1923), p. 799.
- FLETCHER, H.: "Useful Numerical Constants of Speech and Hearing," *Bell System Technical Jour.* (July, 1925).
- JAEGER, G.: "Zur Theorie des Nachhalls," *Acad. Wiss. Wien, Sitzungsberichte* (May, 1911).
- LIFSHITZ, SAMUEL: *Phys. Rev.*, 27 (1926), pp. 618-621.
- SABINE, P. E.: "Measurement of Sound Absorption Coefficients."
- SABINE, W. C.: "Collected Papers on Acoustics."
- WATSON, F. R.: "Ideal Auditorium Acoustics," *Jour. Am. Inst. Architects* (July, 1928).

DISCUSSION

MR. KELLOGG: I should like to ask Mr. Wolf whether there were many theaters that they had a chance to test having a shorter reverberation than was found to be good. Getting a short period of reverberation is expensive. Theaters are generally built for good acoustics in view of previous standards, and theaters falling below those conditions might be good for acoustical work, but they are so few in number that they might not have been available for test.

MR. WOLF: In our analysis, we have found a number of theaters whose period of reverberation falls below the 10 per cent line given in my paper. In these theaters articulation and intelligibility of speech were improved somewhat while the loss in brilliance of music reproduction was considerable. The periods advocated represent a compromise between speech and music.

LOUD SPEAKERS FOR USE IN THEATERS

D. G. BLATTNER AND L. G. BOSTWICK*

INTRODUCTION

There are at the present time two types of loud speakers generally available for use in theaters, the horn type and the free radiator baffle type. Although these two types as usually used in theaters are similar in that they employ moving coil driving elements, they differ materially in their performance characteristics, and for theater purposes where large sound powers are required these differences become very important. Some of the inherent characteristics of these two types of loud speakers are discussed in a general way in the following paragraphs and the effects of these characteristics upon the requirements of theater systems are illustrated.

PERFORMANCE CHARACTERISTICS

Efficiency.—The absolute efficiency¹ (the ratio of the actual acoustic power delivered to the air load to the acoustic power that would be delivered from the same electrical source if the loud speaker were ideal) of the baffle type speaker is inherently lower than that of the horn type. This is due to the fact that the baffle device depends upon the existence of a mass controlled vibrating system² for its uniformity of response at different frequencies. The radiation resistance of such a system is small in comparison with the mass reactance so that the driving force is largely consumed in accelerating the mass and but little is effective in producing sound. An inefficient loud speaker must therefore result. In the horn type speaker, however, the situation is quite different. In this case the load resistance on the diaphragm can be made large compared to the mass reactance of the vibrating system at least for a considerable portion of the frequency range. The impedance relations are therefore much more

* Bell Telephone Laboratories, New York City.

¹ See definition in Report of I. R. E. Standardization Committee of 1929.

² RICE AND KELLOGG—A. I. E. E. (April, 1925).

favorable and in this type of device absolute efficiencies of 25 per cent³ or better can be obtained over a broad frequency range. In comparison with this, uniform efficiency values greater than 2 or 3 per cent over a comparable frequency range are difficult to obtain with the baffle type although baffle devices that resonate within the transmitted frequency range may have efficiencies near resonance somewhat greater. Aural observations in theaters and response⁴—frequency measurements in laboratories indicate that for a given sound loudness, the source of electrical supply to good horn type loud speakers is 8 to 12 decibels less than that required for good baffle speakers, the exact figure being somewhat dependent upon the individual speakers and the energy distribution in the frequency band of the program supply source.

Frequency Range and Uniformity of Response.—Fundamentally the horn and the baffle type of speaker appear to be about equally satisfactory from the standpoint of frequency range of sounds that can be produced efficiently. Well designed speakers of either kind using a single type of driving unit can be relied upon to be quite uniform in response for frequencies up to about 6000 cycles. Above this frequency the response of both speakers diminishes rather rapidly. At the low frequencies the horn cut-off limits the range of the horn type speaker and the size of baffle, the natural period, and the permissible amplitude limit the range of the baffle device.

Horns can be readily constructed to have very low cut-off frequencies but the dimensions and the costs of such horns become increasingly large as the cut-off frequency is lowered.

Baffle type speakers on the other hand need not be seriously restricted by the baffle size or the natural frequency but in commercial devices there is a limiting low frequency range due to the maximum amplitude of vibration allowable by the construction. At low frequencies the radiation resistance of a small piston varies as the square of the frequency so that for frequencies of the order of 50 or 60 cycles the radiation resistance is very small. Very high velocities and large amplitudes of vibration are therefore required to radiate sound powers readily radiated by lower velocities and smaller amplitudes at the higher frequencies. A piston type diaphragm 10 inches in diameter and designed to have a maximum double amplitude of

³ WENTE AND THURAS, *Bell System Tech. Jour.* (January, 1928).

⁴ See definition of response in Report of I. R. E. Standardization Committee of 1929.

vibration of 0.25 inch (a value requiring large dimensions, and possibly some difficulty in the design, of the supporting and driving system) will radiate a maximum acoustic power of about 0.2 watt from each side at a frequency of 60 cycles. At higher frequencies the radiation resistance increases rapidly so that for the same amplitude of motion the output from the above diaphragm at a few hundred cycles may be several times the maximum 60 cycle value. Consequently for constant sound power outputs greater than 0.2 watt, the minimum frequency must be higher than 60 cycles. It will thus be clear that for large sound power outputs such as are required in theaters, the vibration amplitude and the baffle size constitute

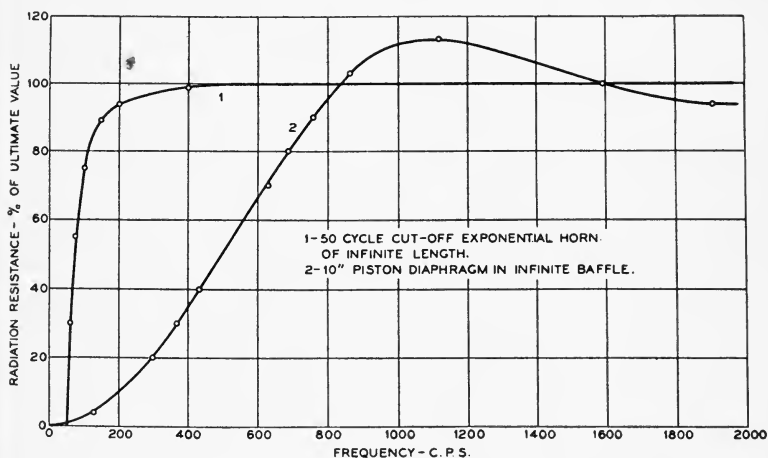

FIG. 1. Curves showing radiation resistance of two types of radiators for various frequencies.

a low frequency limitation of the baffle speaker somewhat analogous to the cut-off frequency of the horn in the horn type speaker.

As to the uniformity of response at different frequencies the best designs of horn and baffle type speakers show no definite advantage of one over the other. Good horn and good baffle type speakers having comparable frequency ranges, sound very much alike when installed in a theater and alternately connected to the same program supply source.

Sound Field Distribution Characteristics.—The angle subtended by the more intense portion of the sound field at any given frequency is somewhat greater for the baffle than for the conventional horn type

speaker. The baffle speaker therefore permits a larger departure of the listener from the axis of the sound field. This difference in the two types does not seem to be fundamental but is effectively overcome when two or more horns are used simultaneously and pointed at different portions of the theater. Such a scheme has the further advantage of increased reliability of operation.

Another difference in the distribution characteristics of the two types of speakers results from the fact that the baffle speaker radiates effectively from both sides of the diaphragm while the horn type radiates effectively from only one side. Because of this characteristic of the horn type speaker less attention need be given to the region back of the horn to prevent certain acoustic effects that might adversely influence the performance as observed from the front.

*Input Power Capacity.*⁵—The input power capacities of baffle and horn type loud speakers are usually limited either by excessive temperature rise of the moving coil or by mechanical restrictions of the vibration amplitude. The temperature rise depends upon the electrical resistance of the moving coil which in turn is determined by the size and material of the coil conductor. It is necessary in both types of loud speakers to use very light coils in order to obtain suitable response at high frequencies and there appears little basis for choosing either type as having the advantage from this standpoint.

As discussed under the section, "Frequency Range," the acoustic power output from the baffle type speaker is definitely limited at low frequencies due to mechanical restriction of the vibration amplitude. Since the radiation resistance of the baffle speaker becomes very small at low frequencies, much larger amplitudes are required to radiate a given sound power than are required by the horn type in which the radiation resistance is large and essentially constant. Fig. 1 shows the approximate relation between frequency and radiation load for a 50 cycle cut-off exponential horn and also for a 10 inch piston. For the same ultimate radiation load it will be clear from the figure that at low frequencies the amplitude of the horn type

⁵ The input power capacity is determined by the ratio

$$\frac{e^2}{4r}$$

where e is the maximum open circuit r.m.s. voltage of the electrical supply source (amplifier), measured at the loud-speaker terminals, for which satisfactory operation of the speaker will result; and r is a resistance equal in magnitude to the impedance to which the receiver is designed to be connected.

speaker will be much less than that of the baffle speaker when equal acoustic outputs obtain. Measurements on commercial speakers and considerations as to practical design indicate that the maximum vibration amplitudes of baffle and horn type speakers allow acoustic power outputs over the frequency range of interest in sound picture work that are about in the ratio of the respective efficiencies. It follows then that the input power capacities of the two types of speakers are roughly equal.

The above discussion of the relative performance characteristics of horn and baffle type speakers may be summarized briefly as follows: The baffle type speaker is 8 to 12 decibels lower in efficiency; the frequency range and uniformity of reproduction are not fundamentally different for the two types; the sound field distribution characteristics are about equally favorable for theater work; and the input power capacities for suitable commercial devices of broad frequency range are about the same, although the acoustic output capacity of the horn type device is considerably greater. While the considerations upon which these conclusions are based are of a general rather than a specific nature it seems reasonable to apply these deductions to the discussion to follow.

THEATER INSTALLATIONS

For theaters where large acoustic powers are required the differences between the performance characteristics of the baffle and the horn type loud speakers discussed above are very important, if equally satisfactory results are to be obtained. Due to the horn being about 10 decibels (8 to 12 decibels mentioned above) more efficient than the baffle speaker the amplifier associated with the baffle must be capable of delivering ten times as much electrical power as the amplifier associated with the horn speaker. Unless the greater power capacity amplifier is provided in the baffle speaker system excessive distortion will result if equal sound powers are to be obtained. As the acoustic power required becomes larger the difference in cost between the amplifiers required to supply adequate powers without distortion becomes an increasingly important item. Also, the horn type speaker has the further advantage of greater acoustic power output capacity and this also becomes increasingly valuable for larger acoustic powers. Thus if the acoustic power required is greater than the baffle speaker is capable of delivering, several baffle speakers would have to be used and the number would

be greater than the number of horns required to deliver the same power. The importance of these considerations obviously depends upon the required acoustic power output, the larger the requirement the more important it becomes to have the loud speaker of higher efficiency and larger acoustic power capacity. In order to obtain a more definite idea of the significance of these differences of performance capabilities some general information as to the acoustic power requirements for theaters of different sizes will be given below together with certain requirements necessary for two typical sizes of theaters; first when using horn type loud speakers and then when using baffle type loud speakers.

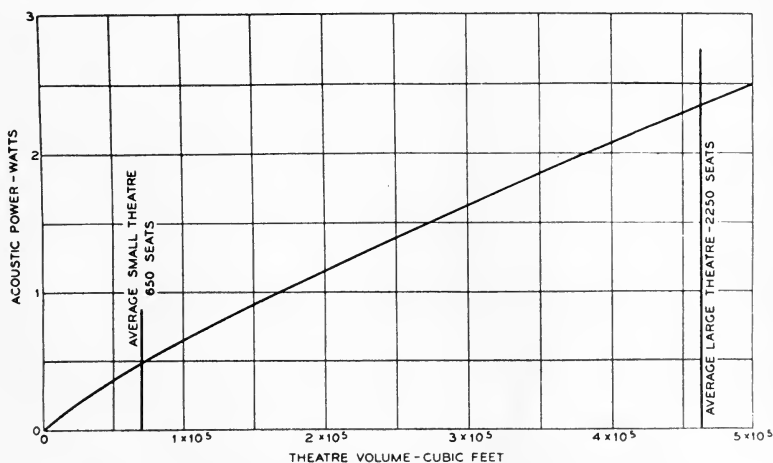

FIG. 2. Acoustic power required in theaters of various sizes.

General Acoustic Power Requirements for Theaters.—Fig. 2 shows a curve expressing the relation between theater volume in cubic feet and the maximum sinusoidal acoustic power in watts which the loud speaker must be capable of delivering in order that the sound loudness in the theater be satisfactory for sound picture use. The curve was obtained from calculations based upon experience in a large number of typical theaters of various sizes. In such places the reverberation times are usually such as to justify the application of steady-state theory so that⁶

⁶ Crandall, "Theory of Vibrating Systems and Sound," p. 210.

$$E = \frac{4P_A}{ac} \dots\dots\dots (1)$$

where

- E = the average energy density.
- P_A = the acoustic power delivered by the sound source.
- c = the velocity of sound propagation.
- a = the summation of the products of the surface areas by their respective absorption coefficients.

From Sabine's reverberation equation the quantity a may be expressed in terms of the room volume V and the reverberation time T . Thus

$$aT = KV$$

or

$$a = \frac{KV}{T} \dots\dots\dots (2)$$

Substituting (2) in (1) and rearranging gives

$$P_A = \frac{KVC E}{4T} = K'E \frac{V}{T} \dots\dots\dots (3)$$

Theater observations with known values of P_A and V and computed values for T (using Lifshitz' equation⁷) permitted an evaluation of $K'E$ for sound intensities which were judged satisfactory for sound picture work. Assuming that the same energy densities are required for other theaters it is then possible by means of equation (3) to evaluate P_A for a properly damped theater of any size. Fig. 2 shows the results of such computations. While this curve is based on observations in a number of theaters it has not been verified extensively and is presented here merely as an aid in the following discussion.

Small Theater Installation.—Consider now the case of a small theater. It has been found from surveys of a large number of sound picture theaters that the average size of the small theater (less than 100,000 cubic feet) is about 70,000 cubic feet with a seating capacity of about 650 people. Assuming this value of 70,000 cubic feet for purposes of discussion and referring to Fig. 2 it will be clear that the average small theater should have loud speakers capable of delivering an acoustic power of 0.46 watt. Such theaters will then require the

⁷ *Physical Review* (March, 1925).

use of an amplifier of 1.84 watts output capacity for use with horn type speakers 25 per cent efficient, or 18.4 watts capacity for use with good baffle speakers. Assuming that the horn type speaker and the baffle type speaker each are capable of handling a maximum sinusoidal electrical power of 6 watts (a value that seems to have some experimental backing), it will be clear that in the first case a single horn type speaker is capable of handling the total output required of its amplifier but we will assume that two such speakers would be used in order to obtain satisfactory distribution. In the second case it will be observed that three baffle speakers are required to handle the power output required from their amplifier. Therefore for an economical balance in cost of equipment the three baffle speakers should cost less than the two horn type speakers by an amount equal to the difference in cost of the two amplifiers.

Now let us consider the relative costs of the two types of amplifiers. On the above basis as to efficiency and power capacity of the speakers the amplifier for the baffle speaker installation should have 10 decibels more gain and ten times the power capacity of the amplifier for the horn installation. An increase in gain of 10 decibels if effected at low power capacity is not particularly expensive, but where the gain is already considerable and the circuits are otherwise complicated this increase in gain may increase the cost of design and installation to insure satisfactory operation. From the standpoint of power capacity the increase required necessitates the use of higher power vacuum tubes and current supply apparatus which requires larger amounts of iron and higher voltage insulation in transformers and choke coils and more costly mountings. In view of these factors and the large powers required in theaters, it might be assumed that the relative cost of two amplifiers having the same features would not be greater than the ratio of their power capacities, nor perhaps less than the square root of their capacities. Assuming the relative cost to be the latter figure as an approximation it will be clear that since the power capacities are in the ratio of 10:1 the cost of the baffle speaker amplifier will be approximately three times that of the horn speaker amplifier.

For the small theater installation it, therefore, appears that baffle type speakers can be justified only if three such speakers are procurable at a cost less than that of two horn type speakers by twice the cost of the horn speaker amplifier.

Large Theater Installations.—The situation in large theaters is even

less favorable for the use of the baffle speaker than it is in small theaters. This is due to the fact that as the required acoustic power increases, the difference in the number of speakers necessary to carry the power becomes greater and the additional power capacity of the amplifier becomes more expensive. Consider for example a theater having a seating capacity of 2250 and a volume of 460,000 cubic feet. From the curve in Fig. 2 such a theater would require an acoustic output from the loud speakers of about 2.3 watts. Horn type loud speakers used in this theater would require an amplifier capable of delivering 9.25 watts, and the number of horn type speakers required to carry the power need not in general be greater than in the case of the small size theater discussed above.⁸ On the other hand baffle type speakers would require an amplifier capable of delivering 92.5 watts and at least 15 speakers to carry the power. The power capacities of the amplifiers are still in the ratio of 10:1, so that for the above assumptions it would appear that fifteen baffle type speakers must be procurable at a cost less than that of two horn type loud speakers by twice the cost of the horn speaker amplifier. The cost of the baffle speaker for large theaters must therefore be considerably less than that justified for the small theater installation.

CONCLUSION

In this paper the performance characteristics of baffle and horn type loud speakers have been discussed in a very general way and the bearing of certain inherent differences between the two types upon the economy of theater installations has been illustrated. It is, of course, impossible to draw any precise conclusions from such reasoning since baffle and horn type speakers may each vary considerably in their performance characteristics. The comparative values assumed in this paper, however, are fairly well substantiated not only by the better existing designs but also by theoretical consideration of possible future improvements. For example, it may be quite possible to improve the efficiency of existing baffle speakers, but on the other hand a considerable improvement in horn type speakers also seems practicable. The same may be said of the power capacity of each type. Other factors such as the use of several loud speaking receivers on the same horn, the effect at low frequencies of using a plurality of

⁸ In some cases where distribution difficulties are encountered as many as three or four horns have been used in theaters of this size.

baffle speakers in close proximity, and design considerations have been outside the scope of this paper, but such factors do not greatly influence the case and an advantage to one type of speaker is offset by other advantages to the other type. It, therefore, does not seem unreasonable to conclude in a very general way that for theater installations general considerations favor the use of horn type loud speakers.

DISCUSSION

MR. PALMER: Can Mr. Blattner tell us anything about the condenser type of speaker and its relative advantages?

MR. BLATTNER: Dr. Kranz has done a considerable amount of work on the electrostatic type of loud speaker and I am sure will be able to describe its outstanding characteristics better than I.

DR. KRANZ: I can't give you any quantitative, comparative data on this point. Mr. Blattner has described in his paper a serious limitation in the baffle type of speaker resulting in a low sound power capacity at low frequencies. So far as the electrostatic speaker is concerned this limitation does not apply.

MR. CRABTREE: Do I understand that one watt is sufficient for a theater of 500-seat capacity? Is that amount of power capable of reproducing with any degree of realism, for instance, a bass drum, or a bass horn, or a falling building?

MR. BLATTNER: Let me repeat for Mr. Crabtree's benefit that the ordinate of the curve Fig. 2 is the *acoustic* power output required from the loud speaker. So far as we are able to determine the curve shows the acoustic power actually delivered in theaters today. In discussing a previous paper someone in this audience complained that the theater managers are "blowing their customers out of their seats." In general I believe that voices are reproduced at least as loud as the original. As for incidental noise effects, I doubt if it is practical or even necessary to reproduce the noise of a falling building as loud as the original.

MR. KELLOGG: I think one of the first calculations of the efficiency of a cone in a baffle was in a paper by Chester W. Rice and myself published in the *A. I. E. E.* in 1925, based on formulas given in Rayleigh's "Theory of Sound." The efficiency came out about three per cent, which is the figure Mr. Blattner gave. I didn't know of that figure being challenged until Mr. E. D. Cook, who was with the General Electric Company at that time, when making careful measurements by means of the motional impedance of the cones came out with a figure of 9 per cent. It was a surprise to me, and I cannot vouch for that figure, but I think 3 per cent is low. The 3 per cent estimate was based on the assumption of a perfect plunger in a baffle. In most of our units, the cabinet seems to build up the response in the bass range, above that obtained with a baffle. In the high frequency range the efficiency is raised by the fact that the cone cannot function as a perfect plunger, but it breaks up into resonance and under these conditions is more efficient than a simple, ideal plunger. On the other hand, the tests that Mr. Cook made with the horns indicated that while they might give a theoretical efficiency of 25 or 30 per cent in the mid range, there was a loss difficult to explain in the high frequency range, and these factors offset the large predicted difference in efficiency between cones and horns. Further measurements are needed, but

measurements as ordinarily made are hardly a satisfactory basis for estimating efficiency because of the concentration of sound in a beam. The efficiency is not a complete measure of utility; the beam intensity may be a better measure of utility than total sound radiated. Both factors come in, their relative importance depending largely on room acoustics, but when we talk about efficiency, we have to base it on the total sound radiated, and it is difficult to make a comparison.

MR. TOWNSEND: I am wondering about the same thing that Mr. Crabtree spoke about with regard to the amount of power required. I use an amplifier in my home which has an undistorted output of approximately 15 watts. I don't use that for loudness but for quality. If we go down to one watt in even a small theater it appears to me that the quality of sound would be rather poor. The theater with which I am connected happens to have six dynamic speakers, and six air column horns with dynamic units.

I can switch from the horns to the baffle type speakers and as nearly as the ear can follow, either will give the same volume in the theater. It is impossible to get any difference in volume between those two sets of speakers connected to the same output transformer and using the same gain. It has been a puzzle to me to find out where the difference in efficiency really is.

MR. BLATTNER: Referring to Mr. Kellogg's remarks, we agree that efficiencies of 8 or 10 per cent can be obtained with baffle speakers over a limited frequency range. Our figure of 3 per cent refers to the overall efficiency for a broad band and checks satisfactorily with the difference between the generally accepted efficiency figure for the better grade of horn type speakers and the difference in loudness between the two types as observed throughout the theater auditorium. I believe we have adequately covered the question as to relative high frequency response and directivity in the paper.

As for Mr. Townsend's remarks I am unable to explain the lack of difference in performance in his two types of speakers. To do so, it would be necessary to know the characteristics of the particular device that he uses. There is a considerable range in the merits of the device of both types generally available in the market. The discussion in the paper applies to what we termed "well designed" devices of the two types.

ART AND SCIENCE IN SOUND FILM PRODUCTION

JOE W. COFFMAN*

Much has been said about the conflict, real or apparent, between science and religion. We also hear of bickerings between science and art. It would seem that Lady Science, to whom we all profess devotion, has her very feminine moments devoted to spying upon her sisters, whom she scandalizes by broadcasting the intimate items she discovers by such investigations.

But science and art are not natural enemies—rather, they are natural complements. Science reveals nature—art makes life livable in spite of those revelations. Science represents the accomplishments of man—art, his aspirations. Science moves slowly but surely toward the conquest of the air—but the Pegasus of art has for centuries sailed the skies. And as aspiration tends to become accomplishment, the art of today becomes the science of tomorrow. And yet, paradoxically enough, art begins where science ends, for the foundation of all art is science, whether that science be conscious or unconscious. Art is empirical—science, mathematical. Science seeks realism—art seeks illusion. But, for the tools to create illusion, art turns to science, the sturdy champion of reality.

This interdependence of science and art is nowhere more striking than in motion picture production. We cannot be really scientific in the attack upon our problems unless we recognize and evaluate the many artistic factors bearing upon the work at hand. So let us review the industry as it stands today.

The first year of active sound film production has been devoted largely to experimentation and to the struggle for survival of the fittest among technicians and their respective technics. Much of the production reaching the public screen has been produced hastily, with inadequate equipment and by inexperienced personnel. These handicaps have not been without beneficial result, however, for they forced experimentation. This sometimes resulted in the development of very useful equipment and flexible production methods, and re-

* Audio-Cinema, Inc., New York City.

vealed the fact that sound pictures may be produced successfully under a wide range of conditions which had previously been considered impossible.

Art is at its best when not limited by rigidity in its medium of expression; and it is strongly believed that every step toward removal of the present restricting factors in sound film production will result in marked improvement of the product. It is in the nature of things that technicians not wholly mature in their work should try to establish taboos and conditions for the guidance of co-workers not yet initiated into the deep mysteries of technical "expertness;" for it is by supposed knowledge of these taboos and conditions that "expertness" is established.

Just now, production is beginning to settle down to routine, and all experts are breathing easier, feeling safe in the many tricks and expedients that they have used in producing the relatively satisfactory results now being secured. But not all these tricks are necessary or even desirable. It is well to keep the art still in a plastic state and not let some of these mistakes harden into the traditions of production. The silent film industry suffered much from traditional wrong approaches to some of its problems, although the industry as a whole was never aware of it. The worship of false gods is difficult to abandon in periods of prosperity; and the industry, if not careful, is likely to expend millions on incorrect production methods, although it will doubtless continue to prosper.

The evidence seems to indicate that much originally accepted as authentic practice in the field of microphone placing, monitoring, mixing, recorder operation, and laboratory procedure is actually diametrically opposed to the most efficient practice. Fortunately, the indicated changes are nearly all in the direction of greater simplification and greater flexibility.

There is probably more "hokum" practiced by the man at the mixing panel than by any other talking picture artisan. The old-line film man has felt himself helpless before the onslaught of the electrical and recording technicians and has permitted a great deal of guess work to pass as "art."

In some ways it is unfortunate that the radio industry supplied most of the sound experts to the film industry. In radio broadcasting it usually is desirable to present all sounds as coming from approximately the same plane—that of the microphone. And so levels are raised and lowered to bring all sounds out at approximately the

same volume, the microphone being placed as near as possible to the sources of sound.

But in talking picture presentations, it is very desirable to achieve space effects, and dramatic variation of volume level. The monitor operators are realizing this to some extent, but the old habits die hard. It is difficult to resist the tendency to place microphones all over the set, to switch from one to another, and to twist the dials which vary the volume levels.

At the present time, the ideal condition is not always possible to achieve because of technical considerations, but it seems unquestionable that eventually the first rule of successful dramatic recording will be: "Use one microphone, in the general vicinity of the apparent camera location; rehearse the scene to determine the highest permissible level; set the dials, and forget them." Not all sound men will agree with this statement, yet its validity can be demonstrated readily. It is believed that general application of this rule would do more than any other one thing to free the talking picture from its present characteristic stiffness.

The general tendency in all the studios seems to be to permit mixers to follow their own judgment, and their judgment is not universally good. This probably is a good policy in the long run, for it does permit of experimentation, and the poor mixer will eventually eliminate himself. However, it also encourages a tendency toward "artiness" on the monitor's part, and to develop the belief that there is some magic in the twisting of the dials that is beyond the grasp of ordinary men. As a general rule, it may be said that the best mixer is he who does the least mixing, and the best microphone placer is he who places the fewest number of microphones.

At the time the industry's new sound stages were designed, they undoubtedly reflected the most advanced production practice. But it should not be forgotten that production practice at that time was based largely upon laboratory experience in recording sound, perfection being achieved when the graphic curve representing the result fell exactly in its theoretically perfect position. Perfection in sound picture production, however, should be measured in terms of audience reaction, and includes many things not considered in mere sound recording. A monotonous voice, repeating, "I eat pea soup at six-fifteen" may make a perfect sound recording, but it will not bring in money at the box office.

The large monitoring rooms included in nearly all the stages are

probably of some assistance in determining correct microphone placement, and they confer dignity and a sense of ease upon the mixer's calling, but it is very doubtful whether they justify their cost.

In the first place, they do not, as originally supposed, duplicate acoustic conditions in the average theater. It is now apparent that, from the acoustic standpoint, there is no average theater. Theaters differ very widely in reverberation time and in all other acoustic factors. The same theater has very different characteristics when half full from those which it has when completely occupied. And it becomes every day more obvious that an auditor unconsciously perceives and adapts his mental response to the acoustic conditions prevailing at the moment. It has also become obvious that the mixer or monitor operator soon develops a factor of judgment under any given circumstances, so that it is practically as easy for him to determine good quality in one size room as in another.

The fixed monitoring room, by removing control of the voice currents far from the scene of action, tends toward lessening directorial authority, and toward difficulty in general coördination. If the mixer is to see the action clearly, it forces an inflexible placement of sets on the stage, and difficulties in the location of camera booths, lights, "props," and other stage paraphernalia.

In view of these facts, it would appear that the best immediate solution of the monitoring problem is the small portable monitoring room, about ten by twelve by eight feet in size. Monitoring with head-phones, as practiced on many improvised stages, presents difficulties in that the best phones now available are not equal in quality to the usual loud-speakers, unless used with rubber ear muffs and transformers of proper impedance. At best, the head-phones are uncomfortable. However, it is understood that head-phones of excellent reproducing characteristics will soon become available, and it is probable that some form of helmet will be devised which will permit of comfort to the wearer and efficient connection to the ear. It is believed that this arrangement, with portable mixing panel trucks of the type devised for use on some improvised Hollywood stages, would be by far the most flexible system for monitoring, and would make it possible to develop that really close coördination of sound and scene without which all claims to art are merely presumptuous.

There is some confusion in the use of the terms "sound proofing" and "acoustic treatment." "Sound proofing" is accepted by acoustic

authorities to mean insulation against external sounds; while "acoustic treatment" refers to control of internal reverberation, *etc.*, by the use of sound absorbing or other materials having the desired acoustic characteristics.

The complete sound proofing of sound stages is undoubtedly wise, although the result probably might have been attained less expensively than was the case with many new stages. The set must, of course, be acoustically independent of all noises not purposely originated thereon. Failure to make this provision is expensive.

At present it is doubtful whether the ultimate sound stage construction will include permanent acoustic deadening of the interior. In the first place, no sound-absorbing material used for this purpose absorbs all frequencies equally. Unfortunately, most "deadening" materials do what the term signifies, that is, they absorb most of the high frequencies which give life and brilliance to sound, and reflect much of the low frequency component which creates "boominess." The natural responses of the recording and reproducing equipment also tend to suppress the higher frequencies, so that this effect is doubly undesirable. A "dead" stage tends to create false security on the part of the personnel of the sound department, making it feel that no particular attention to the acoustic characteristics of the set is necessary. On a dead stage, with absorbing materials used for set construction, the recording inevitably lacks life and brilliance unless the microphones are placed very close to the sources of sound, so as to pick up nearly all their sound energy from the direct wave. This technic, while it may result in technically good recording, will cause all voices to seem to come from the same plane and thus destroy the effect of spatial depth, so necessary for dramatic effect.

It would seem best to develop a system whereby each set is treated as a separate acoustic unit, and is completely isolated in a space only large enough for the necessary work to go on.

Normally, sets should be constructed from materials which would be used in the actual scene being represented. Some resonance is natural in any actual scene, and should be present in that scene as recorded. It is true that this technic makes the placing of the microphone more difficult, because the microphone picks up the sound as would a single ear, and therefore may demonstrate undesirable selectivity as regards the reflected sound. However, a suitable position may usually be found by listening at various possible locations with one ear closed, and this expedient will usually save much time.

It is believed that ultimate sound stage design will call for a relatively large stage floor, sound proofed as regards external sounds, but untreated on the interior. On this floor the sets will be built, practically following the old silent film procedure. When the set is complete, with lights and properties in place, acoustic "flats" will be used to build up a complete wall around it. If monitoring or camera booths be used, their fronts can be incorporated in this wall at any desired locations. This arrangement should have many advantages over any now in use, and is recommended for experimentation.

Friction between directors and engineers developed early in sound picture history, with the engineers eager to establish themselves in a position of strong authority, and with the directors resisting encroachment on their traditional position. The noise of battle has now subsided somewhat, with the advantage going in various directions in the different studios.

It is strongly believed that authority on the set should be centered in one person, and that person should be the director. Engineering qualifications can never be substituted for dramatic perception, nor science for showmanship.

The average director of today is working in an unfamiliar medium, and he needs much technical assistance. If he is wise, he will listen to all the technical advice that is offered, make sure that he understands the point involved, and then make his own decision, which should be final. If his decisions are ill advised, the results will show it, and he will soon improve the quality of his decisions, or look for employment elsewhere.

Eventually, a new type of director will be evolved, who understands his microphone placing as well as his camera angles, and who has an ear as well as an eye. The sound man's relative position is similar to that of the cameraman, which, of course, makes his position still one of large responsibility.

As previously pointed out, there is nothing particularly mysterious in the art of microphone placing. The director is usually nearly as well qualified as the "mixer" to judge it. He can readily learn the trick of listening to the sound with one ear, and so determine for himself the relative merit of various possible microphone locations. He should particularly train himself to judge depth or space effects, which are essentially dramatic, and are very often ignored by the mixer, who is too frequently listening only for a technically perfect reproduction of the sound as he hears it close up.

A pair of head-phones connected into the monitoring circuit, and worn by the director during rehearsal and "shooting" of the scene frequently proves of much assistance in determining production values and his efficiency is greatly increased by a complete signalling system for his use, placing at his fingertips control of every possible production factor.

Arbitrariness is, of course, not a desirable quality in a director, and these remarks are not intended to approve that frequently observed fault. But it is believed that much of the rigidity to be observed on the talking screen of today is due to too scrupulous attention to the sound man's advice upon the part of the director. Unless he understands for himself the limitations and capacities of his medium, no director can put much dramatic meaning into his work.

It is sincerely believed that utilization of the possibilities offered by dubbing is of supreme importance to the advancement of the art of talking picture production. It has long been recognized that a silent picture is made or marred in the cutting room—similarly, in the not distant future it will be generally admitted that a talking picture is made or marred in the dubbing room. The emphasis on this last statement will be far stronger than ever was placed on the former. It is probable that within a year no original sound records will be used for the making of release prints of feature productions of high quality.

By proper dubbing, it is possible to raise or lower volume levels so that an entire production can be run without change of the projection room fader setting, except in case of extremely loud noises such as artillery fire. This possibility alone would make dubbing worth while, for the greatest popular complaint against sound pictures now is that the volume levels are unsatisfactory and are continually changing. Dubbing places the relationship between volumes in the control of the producer, and prevents the necessity for manipulation of volume by the projectionist. Dubbing also makes it possible to record all sounds at the most practical level, since the volume relationship is established in the dubbing room. It makes possible those fine touches by the director which have previously marked the best stage productions—touches which are not possible until the production can be viewed as a whole. It makes acoustic cutting even more flexible than pictorial cutting; it makes possible the improvement of voices and effects through changing their frequency content by use of the requisite filters; it permits almost any imaginable acoustic trick,

and the inclusion of effects which occur as afterthoughts; and it insures the valuable original negative against the damage it always incurs in the printing room.

It is believed that equipment for dubbing will be vastly improved during the coming year, and that development will be hastened by efficient use of the equipment now available. It is probable that the ultimate dubbing machine will bear no resemblance to the dummy projectors now being used, but will consist of an associated group of sound pick-ups mounted on a panel, with faders, filters, amplifiers, *etc.*, arranged for easy connection thereto. A device somewhat like the present printer light-shift, actuated by notches in the film, will determine which particular records are to be picked up at any given time. Fader settings and filters can be similarly cut in. If the driving motor is capable of being interlocked with a picture projector, it will be possible to determine by projection exactly the effects to be secured on the dubbed record. These effects can be decided upon by the picture director, the editor, or by conference, before any actual re-recording is undertaken.

Seven million Americans walked up to motion picture theater box offices yesterday, and paid the price of admission. Today, and each tomorrow, holds the prospect of similar parades. But they enter those doors not for the purpose of seeing realistic presentations of their own lives—they seek relief from reality. But the presentations must be masked to pass for reality, upon the acceptance of the premises laid down by author, actor, and producer. The more sophisticated the mind of the viewer, the greater the task becomes, for the practiced eye detects the sham behind the mask, unless art has functioned well indeed.

PHOTOGRAPHIC CHARACTERISTICS OF SOUND RECORDING FILM*

LOYD A. JONES AND OTTO SANDVIK

The various methods and general principles involved in the recording of sound by photographic methods are too well known to require detailed description and discussion. The methods at present in use commercially may be divided broadly into two classes: (1) The variable density type, and (2) the variable width type. The former may be subdivided, with respect to the method used for obtaining the variable exposure, into (a) those using the "light valve," and (b) those employing a "flashing lamp." In variable width recording the film is moved at a uniform linear velocity past a slit, or an optical image thereof. By suitable means the transverse length of this slit image is so modulated that the exposed area varies in lateral dimensions giving a sound record of the so-called "saw tooth" type. At any point within the exposed area the exposure incident on the photographic material is constant, both factors of exposure, namely, intensity (I) and time (t), being constant. This statement requires some modification since with the film moving continuously in one direction past a slit of finite width and the boundary of the illuminated area moving in a direction perpendicular to that of the film there must be a narrow envelop in which the t factor of exposure varies to some extent.

In variable density recording with the light valve the film is moved at a constant linear velocity past an illuminated slit, or an optical image thereof, the width of which is modulated. In this case it is evident that the intensity factor (I) of exposure is constant, while the time factor (t) is variable. In variable density recording with the flashing lamp the film is moved at a constant linear velocity past an illuminated slit of fixed width, the intensity of the illumination being modulated. In this case it is evident that the exposure at any point on the photographic film is variable due to the variation in the inten-

* Communication No. 414 from the Kodak Research Laboratories.

sity factor of exposure. From the photographic standpoint, therefore, the general problem of sound recording has at least three distinct phases, since, if the best possible results are to be obtained, each of the methods mentioned above requires a photographic material having characteristics and requiring processing treatments differing radically from each of the other two.

Regardless of which method of sound recording is being used, the energy required for modulating the photographic record is derived from the plate current flowing from the last tube in the recorder amplifier. In all cases it is desired that the sound record positive, printed from the sound negative, shall carry a distribution of density which will control the intensity of the radiation incident upon the photo-electric cell of the reproducing mechanism in such a manner that the instantaneous intensity of this radiation is directly proportional to the instantaneous sound pressure on the microphone diaphragm.

In case of the variable density record this end is accomplished by a variation of density from point to point along the length, that is, in the direction of travel, of the record, with no variation of density in the transverse direction, that is, along a line perpendicular to the direction of travel. When such a record is moved at a uniform linear velocity past the scanning slit, or the optical image thereof, the intensity of the radiation transmitted by this slit is directly proportional to the mean transmission of the photographic image covering the slit at any instant. It is evident, therefore, that if it be desired to cause the intensity incident upon the photo-electric cell to vary, let us say, according to a sine function of time, the transmission of the photographic image must vary as a sine function of distance measured along the length of the record. A micro-photometric analysis of such a record should therefore show a gradual increase and decrease in transmission along the length of the record which, when plotted as a function of linear displacement, should give a sine curve. Assuming that the characteristic of the recording system (microphone, amplifier, light valve, *etc.*) is linear, the exposure ($I.t$) incident on any point of the photographic recording material is directly proportional to the instantaneous sound pressure on the microphone. If this condition is fulfilled then the photographic problem resolves itself into that of obtaining a positive in which the distribution of transmission along the direction of travel is directly proportional to the distribution of exposure on the negative. This problem is fundamentally identical,

in principle at least, with the usual photographic problems involved in the production of motion pictures, portraits, landscapes, *etc.*, and, in fact, in all cases where the correct reproduction of a series of vari-

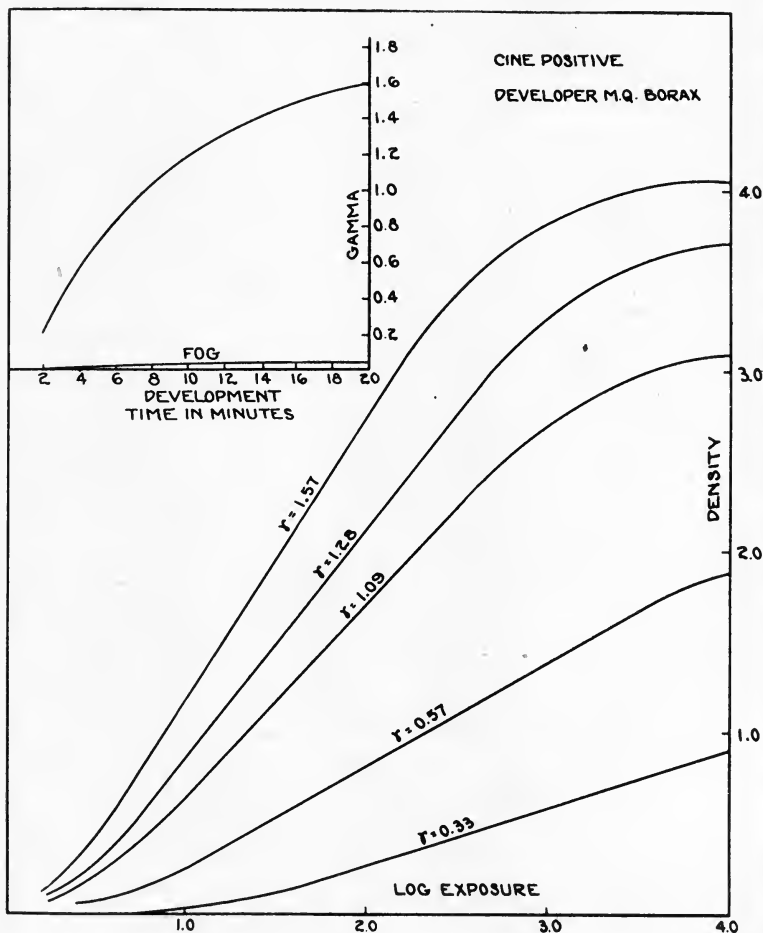

FIG. 1. Sensitometric curves for motion picture positive developed in metal hydroquinone borax.

able brightnesses is of prime importance. In motion picture photography, for instance, the camera man builds up in the studio a series of brightnesses spacially distributed. Photographic methods are then called upon to produce in the positive a series of brightnesses directly

proportional to those existing in the set. By means of a lens an image of the object in question is formed on the photographic material. The exposure time for all points on the negative area is the same and hence the distribution of brightnesses existing in the object produces a corresponding distribution of exposure at various points on the negative surface which are directly proportional to the brightnesses existing in the object. In the case of sound recording an analogous situation occurs since the light valve or "flashing lamp" subjects the negative to a series of variable exposures. In the case of picture records and sound records the desirable condition from this point on is a reproduction in the positive of transmission values which are directly proportional to the exposure values incident upon the negative record.

The theory of tone reproduction, applying particularly to general photographic work, has been treated at length in previous publications and the general laws and relationships derived can be applied with certain modifications in details, which may be desirable for the sake of convenience, to the general problem of photographic sound reproduction. For instance, it has been shown that for perfect reproduction of brightness relationships, the product of the negative gamma (γ_n) by the positive gamma (γ_p) should be equal to unity, assuming that only the straight line portions of each of the characteristic curves are used. This law is of equal validity in the case of sound reproduction by the variable density method.

In the case of sound on film, the positive sound record must be developed along with the picture positive and hence must necessarily receive the same development treatment, thus being developed to the same contrast (γ) as that required to give the desired picture quality. The present predominant practice in the making of motion pictures involves the use of a picture negative developed to a relatively low gamma (0.5 to 0.6), thus requiring for the fulfillment of the above relationship that the positive be developed to a relatively high gamma (1.8 to 2.2). A fair approximation to practice is represented by the following figures:

$$\begin{aligned}\gamma_n &= 0.55 \\ \gamma_p &= 2.00 \\ \gamma_n \cdot \gamma_p &= 1.10 = \gamma_r\end{aligned}$$

It will be noted that the product of these negative and positive gammas is slightly greater than unity. It has been found that this is

desirable in order to compensate for certain contrast losses which occur at different points in the process. For instance, a certain amount of flare may exist in the projection lens, thus spreading a veiling glare over the projected image. In many cases also there is an appreciable amount of stray light incident upon the screen from the general lighting in the theater. These factors all tend to decrease the effective contrast and it seems desirable to make the gamma of the reproduction (γ_r), the so-called "over-all gamma," somewhat greater than unity. Since the sound positive must be developed to a gamma of approximately 2.0, it follows that the sound negative should be developed to a gamma of 0.5 or 0.6 in order that the required quality of exposure variations to which the sound negative is subjected can be reproduced in the sound positive as proportional variations in transmission.

In establishing a laboratory technic for the handling of sound records it is therefore necessary to determine the development conditions which will result in a sound record negative of the desired contrast. The required information can be derived from a sensitometric study of the characteristics of the photographic material. In Fig. 1 are shown the sensitometric curves for motion picture positive film, the material which is used almost exclusively in making the sound record when using the light valve method. These curves show the relationship between density (ordinates) and log exposure (abscissas) for a series of different development times. The exposures from which the data are derived were made in a high intensity sensitometer employing a time scale exposing system, the time factors of exposure varying from 2.5×10^{-4} to 0.5 seconds. The light source used in this sensitometer is a high efficiency tungsten lamp with the filament operating at a color temperature of approximately 3100°K . The exposed strips were developed in the standard metal hydroquinone borax formula at 20°C . The resultant densities were read with the emulsion side of the film in contact with an illuminated disk of pot opal glass. The values obtained are therefore those of diffuse density. The times of development used in obtaining the various curves are shown in the first column of Table I.

In the upper left-hand corner of Fig. 1 are plotted the time (of development)-gamma and the time-fog curves for this material. The time-gamma curve obtained by plotting gamma as a function of development time shows the way in which gamma increases with increasing times of development.

TABLE I

Sensitometric Data for Motion Picture Positive Developed in M. Q. Borax

T_d	γ	i	$\frac{d\gamma}{dT_d}$	L	R.P.	Fog
2.5	0.32	$\bar{1}.90$	1.90	2.9+	81.0	0.01
4.5	0.64	$\bar{1}.62$	1.43	2.9	80	0.02
8.0	1.03	$\bar{1}.10$	0.93	2.0	78	0.03
12.0	1.30	$\bar{1}.02$	0.66	1.8	76	0.04
20.0	1.60	$\bar{2}.96$	0.17	1.6	75	0.05
4.2	0.60	$\bar{1}.66$	1.48	3.1	80	0.02

In Table I various data derived from the curves in Fig. 1 are given. The significance of the various symbols used as column headings are as follows:

T_d denotes the development time in minutes.

γ is defined as the slope of the straight line portion of the characteristic curve.

i (inertia) is expressed in terms of visual candle-meter seconds, the radiation quality (spectral composition) being that emitted by a high efficiency tungsten lamp operated at a color temperature of approximately 3100°K. Inertia is defined as the value of exposure ($I.t$) at the point where the straight line portion of the D -log E curve extended cuts the log E axis.

$\frac{d\gamma}{dT_d}$ denotes the rate of change of gamma with development time and is defined as the slope of the γ - t curve at the point corresponding to the specified development time. This value is useful as a measure of how rapidly gamma is changing at any instant and can be used to compute the variation in development time corresponding to any specified tolerable variation in gamma.

L (latitude) denotes length of the straight line portion of the characteristic curve and is measured in terms of the projection of this straight line upon the log E axis. The value is expressed in log exposure units. It will be noted from an inspection of the curves in Fig. 1, and also in the succeeding figures, that the actual length of the straight line portion tends to remain approximately constant for all development times; but since latitude (more properly referred to as exposure latitude) is measured as the projection of this line on the log E axis, the value decreases for increasing gammas. This value is a

direct measure of the exposure range over which direct proportionality between log exposure and density exists.

The value of *R.P.* (resolving power) is not derived from the curves shown in Fig. 1 but from measurements of an entirely different nature. Since, however, this value is of great importance in sound reproduction, it is included in this table. The value of resolving power given in this case is that resulting from the use of a high contrast test object and the optimal exposure value. It will be noted that this value of resolving power tends to decrease slightly for prolonged development. The entire problem of resolving power and its dependence on contrast, exposure, development, *etc.*, is extremely complicated and is treated at greater length in a later section of this paper.

The heading "*Fog*" denotes the value of density produced on a portion of the photographic material which has received no exposure but which has been subjected to development for the times indicated.

TABLE II
Sensitometric Data for Reprotone B Developed in M. Q. Borax

T_d	γ	i	$\frac{d\gamma}{dT_d}$	L	<i>R.P.</i>
2.0	0.25	$\bar{1}.77$	1.28	2.9+	90
4.0	0.47	$\bar{1}.60$	0.89	2.9	85
8.0	0.73	$\bar{1}.43$	0.50	2.5	78
12.0	0.87	$\bar{1}.40$	0.29	2.0	74
20.0	1.00	$\bar{1}.31$	0.11	1.9	72
5.6	0.60	$\bar{1}.52$	0.65	2.8	81

At the bottom of the table are given the interpolated values for the various factors corresponding to the development time yielding a gamma of 0.6. As stated previously, present practice demands that the sound record negative be developed to a gamma of approximately 0.6 and the values as indicated in the bottom line of the table therefore give definite information as to the characteristics of the material when developed to this extent. It should be kept in mind, however, that the data shown in the various tables and figures in this paper represent the average derived from tests made on several different coatings of the various materials. There are some unavoidable variations in characteristics from batch to batch in any photographic material. These are relatively small but it should be remembered that a single set of measurements made on one particular sample of material may not check precisely with the values given here.

In Fig. 2 and Table II are given data relative to the characteristics of Reprotone B film, a material developed particularly for use in sound recording by the light valve method. The characteristics of this material are very similar to those of motion picture positive with the exception of rate of development and the maximum attainable contrast (γ_{∞}). An inspection of the time-gamma curve in Fig. 2 will show that it rises much less steeply and obtains an ultimate value

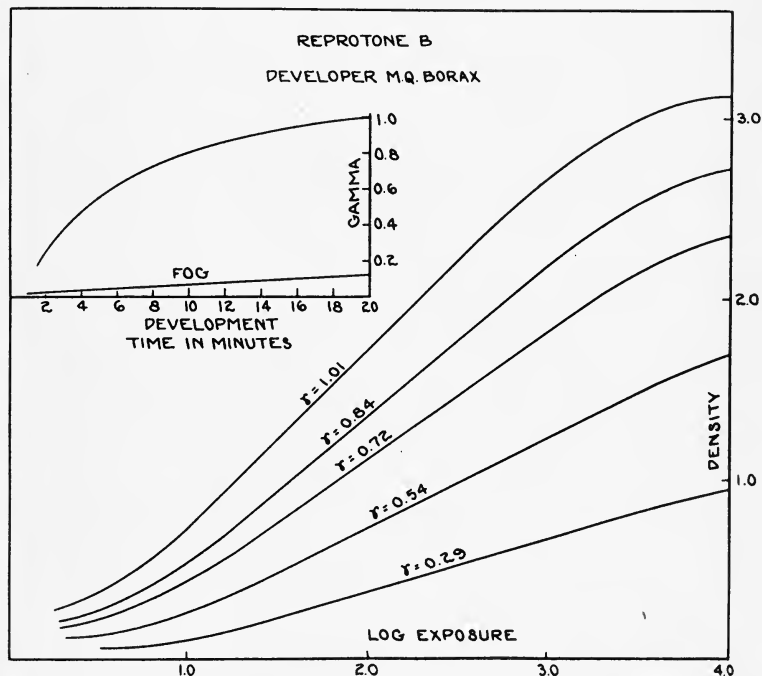

FIG. 2. Sensitometric curves for Reprotone B developed in metol hydroquinone borax.

appreciably lower than that for the regular motion picture positive film. It is considered that this represents a desirable factor in material for this purpose. As stated previously, it is necessary to stop development when gamma reaches approximately 0.6. In the case of positive film the rate of change of gamma with time of development at this point as represented by the d_{γ}/dT_d is 1.48, while for the Reprotone B material the value of this factor for the same contrast is only 0.65. This means that at the time when it is desired to stop

development the value of gamma in the case of the Reprotone is changing much less rapidly, hence a much greater error in time of development can be allowed without introducing an intolerable variation in the value of negative gamma. The latitude for a gamma of 0.6 is 2.9, practically the same as that of the positive material and amply sufficient to accommodate the maximum desirable exposure variation in recording.

The general requirements imposed upon the photographic material for use with the "flashing lamp" are practically identical with those

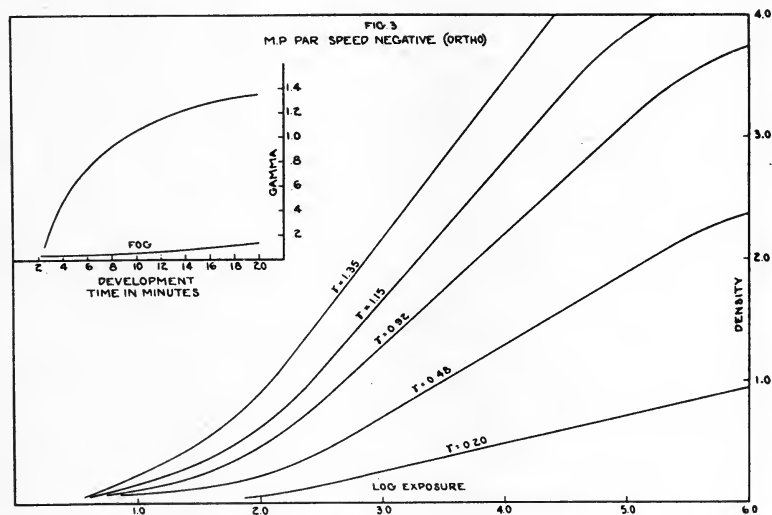

FIG. 3. Sensitometric curves for motion picture par speed negative (ortho) developed in metol hydroquinone borax.

TABLE III

Sensitometric Data for Par Speed Motion Picture Negative Developed in M. Q. Borax

T_d	γ	i	$\frac{d\gamma}{dT_d}$	L	R.P.	Fog
2.5	0.20	$\bar{1}.58$	2.5	3.2+	55	0.04
4.5	0.58	$\bar{1}.42$	1.4	3.2	55	0.04
8.0	0.92	$\bar{1}.24$	0.72	2.5	40	0.05
12.0	1.14	$\bar{1}.20$	0.45	2.2	40	0.08
20.0	1.34	$\bar{2}.96$	0.14	2.2	35	0.12
4.7	0.60	$\bar{1}.40$	1.30	3.1	54	0.04

required by the light valve method, with the exception of speed. The photographic intensity of the radiation emitted by the "flashing lamp" is not in general sufficiently great to give fully exposed negatives when using positive motion picture film. For this type of recording, therefore, it is common practice to use regular negative materials.

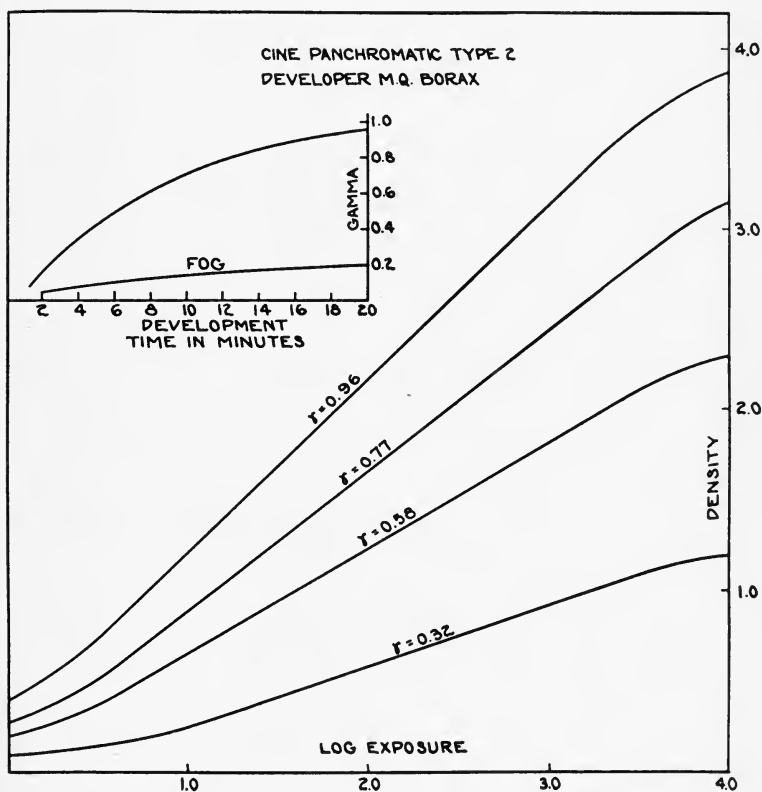

FIG. 4. Sensitometric curves for motion picture panchromatic negative Type 2 developed in metal hydroquinone borax.

In Fig. 3 and Table III are given the data relative to regular par speed motion picture negative film developed in standard metal hydroquinone borax. The factors tabulated are identical with those shown in the previous cases. In the bottom line of the table are the values applying to the materials when developed to a gamma of 0.6.

In Fig. 4 and Table IV are the corresponding data for motion pic-

ture panchromatic Type 2 film developed in the standard metol hydroquinone borax formula. The most noticeable difference between these two materials from the standpoint of sound recording is the relatively low rate at which gamma increases with time in the case of the panchromatic film as compared with the par speed (orthochromatic). The rate at which contrast is changing at the point where

TABLE IV

Sensitometric Data for Motion Picture Panchromatic Type 2 Developed in M. Q. Borax

T_d	γ	i	$\frac{d\gamma}{dT_d}$	L	$R.P.$	Fog
2.0			1.00		50	0.04
4.0	0.32	$\bar{2}.74$	0.80	3.3+	46	0.07
8.0	0.58	$\bar{2}.33$	0.50	3.3	44	0.12
12.0	0.77	$\bar{2}.28$	0.37	3.1	42	0.15
20.0	0.96	$\bar{2}.17$	0.17	2.7	41	0.19
8.3	0.60	$\bar{2}.32$	0.48	3.2	44	0.13

gamma becomes equal to 0.6 is appreciably less in the case of the panchromatic material. It should be easier, therefore, to control contrast with the desired precision in the case of the panchromatic material. The speed of the panchromatic as indicated by the value of inertia is also much greater.

The general requirements imposed upon a photographic material for variable width recording are radically different from those demanded by the variable density methods. Here the problem is more analogous to that met in process work, such as the reproduction of a line (black and white) drawing. One portion of the sound track area should be covered by a silver deposit which is opaque, or at least very dense, while the other should receive so little exposure as to remain almost completely transparent. In other words, a very high contrast between the two areas is desired. Practical experience indicates that a density difference of from 1.3 to 1.6 (corresponding to transmission ratios of 20 and 40, respectively) is sufficient. The boundary line between the two areas should be as sharp as possible and obviously the resolving power of the material should be high. The regular motion picture positive film when developed in the formula commonly used for picture work (formula D-16) meets these requirements admirably and is the material at present in general use for variable density recording.

In Fig. 5 and Table V are given the sensitometric data relative to this material. It will be noted that gamma rises very rapidly with time of development reaching a value of 2.0 in six minutes. In this type of recording the latitude of the material is of little importance,

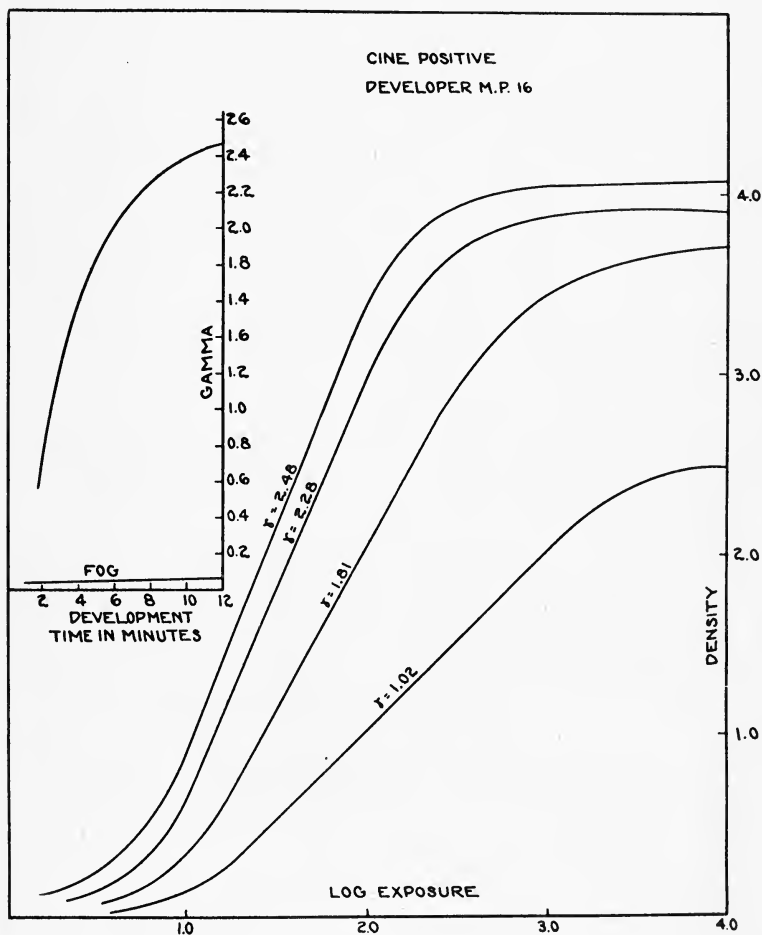

FIG. 5. Sensitometric curves for motion picture positive developed in D-16.

nor is the usual method of expressing sensitivity in terms of inertia of practical utility. If we assume that a density of 1.5 in the exposed portion of the sound track negative is adequate (and practical experience supports the validity of this assumption), then it seems more

logical to express the effective speed of the material in terms of the exposure required to give this density. In the third column of the table ($\log E_{1.5}$) are given values of the exposure required at the various development times to produce this arbitrarily assumed density (1.5).

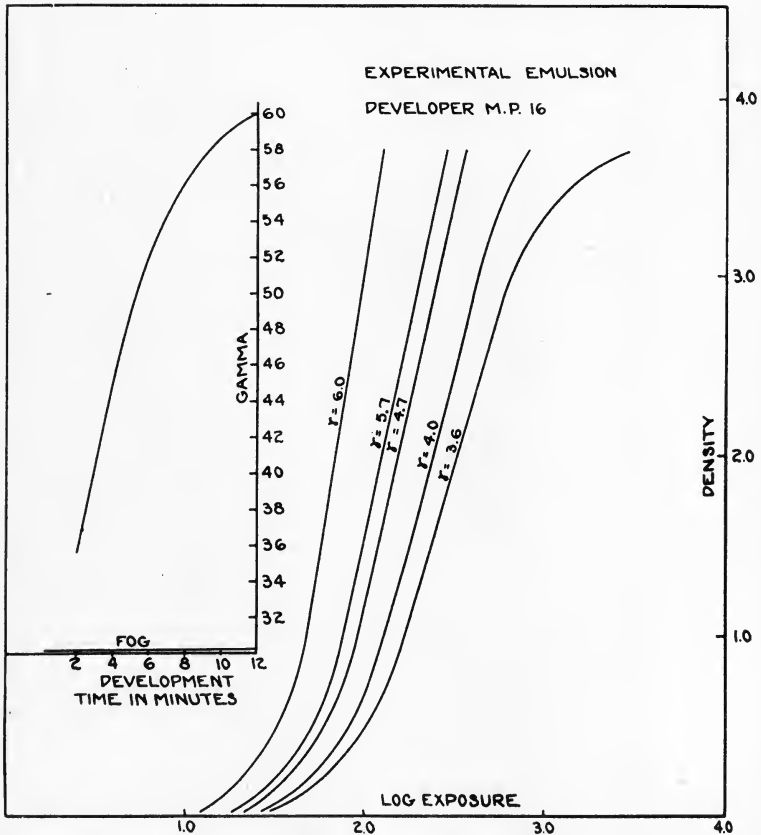

FIG. 6. Sensitometric curves for an experimental emulsion developed in D-16.

In Fig. 6 and Table VI are given some interesting data relative to a special experimental material not at present commercially available. This is a material of extremely high contrast and should be particularly adapted to the variable area sound recording. From a standpoint of contrast, resolving power, and sharpness it offers con-

TABLE V

Sensitometric Data for Motion Picture Positive. Developed in D-16

T_d	γ	$\text{Log } E_{1.5}$	Fog	R.P.
2.5	1.02	1.18	0.04	74
5.0	1.81	0.40	0.05	73
8.0	2.28	0.07	0.06	71
12.0	2.48	$\bar{1}.93$	0.07	71
6.0	2.00	0.22	0.05	72

siderable promise, but further experimental work must be done before definite conclusions as to its utility and practical value can be drawn.

As stated previously, the photographic process is concerned with two factors, namely, the rendering of tone and the reproduction of form. The former depends on the sensitometric characteristics of the emulsion, whereas the latter depends primarily on its resolving power and sharpness. This distinction is only partial, however, because those factors obviously affect the tone values; furthermore the properties of an emulsion which determine its sensitometric character-

TABLE VI

Sensitometric Data for an Experimental Emulsion. Developed in D-16

T_d	γ	$\text{Log } E_{1.5}$	Fog	R.P.
2.0	3.6	0.10	0.02	120
4.0	4.0	0.00	0.02	117
6.0	4.7	$\bar{1}.80$	0.02	114
8.0	5.7	$\bar{1}.70$	0.03	112
12.0	6.0	$\bar{1}.50$	0.03	98
4.0	4.0	0.00	0.02	117

istics also determine largely its resolution and sharpness. The nature of the problem should necessarily determine the type of emulsion to be used. Thus in the case of sound recording, where high frequencies consist of photographic images very close together, it is necessary to use an emulsion which has high resolution; yet it must be sufficiently sensitive to attain the required density with the exposure available. Unfortunately, these two factors bear in general a reciprocal relation.

The resolving power of an emulsion is an extremely complex problem depending on a number of variables such as distribution of intensity and contrast in the object, density of the photographic image,

time of development, type of developer, quality (spectral composition) of the exposing radiation, and several other minor factors. It is impossible, therefore, with our present knowledge at least, to express the resolving power of an emulsion in terms such that one can calculate very closely the depression in volume of a sound record incurred by imperfect resolution. It may prove useful, however, to consider the nature and the effect of some of the above variables. In order to simplify the problem as much as possible, we shall consider each variable separately.

Let us consider first the effect of a change in the image density, keeping all other factors as nearly constant as possible. Fig. 7 shows

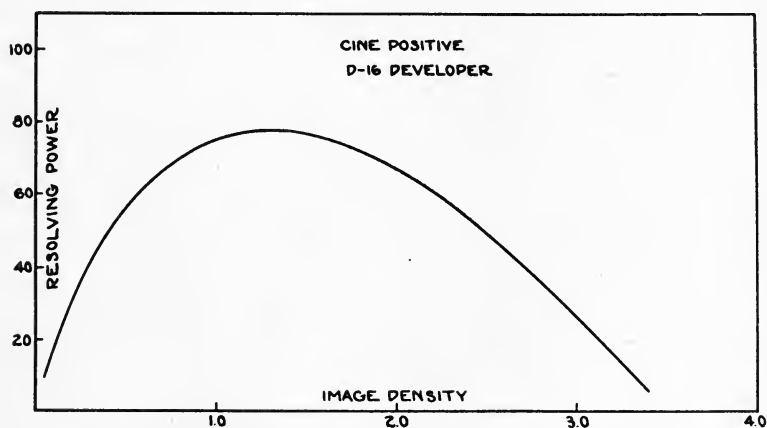

Fig. 7. Resolving power-image density curve for motion picture positive developed 8 minutes in D-16.

a typical curve for cine positive, the object contrast being 1000 and the development time 8 minutes in D-16. This curve shows that the resolution increases from zero at a density of zero to a maximum value of 80 at an image density of 1.3. This density we shall call the optimal density. The general character of this curve is similar for any type of emulsion, although in general the lower the inherent contrast of the emulsion, the lower is the optimal density. Keeping the time of development constant and varying the object contrast, if we measure maximum resolving power, that is, resolving power at optimal image density, we obtain the curve *B*, shown in Fig. 8. The resolution increases exponentially with the log contrast approaching its maximum value asymptotically. It is seen that cine positive

emulsion very nearly reaches its maximum value when the object contrast is 3.0. If we now vary the time of development, keep the object contrast 1000, and determine the resolving power for each time of development at an image density of 0.3, we obtain the curve shown in Fig. 9. It is interesting in this case to note the rapid decrease in resolution with increasing time of development. This is due to the fact that the optimal density is greater than 0.3 and that the entire curve shifts to the right as the time of development increases, thus depressing the low density end. If the image density and the development time both vary, we obtain a family of curves;

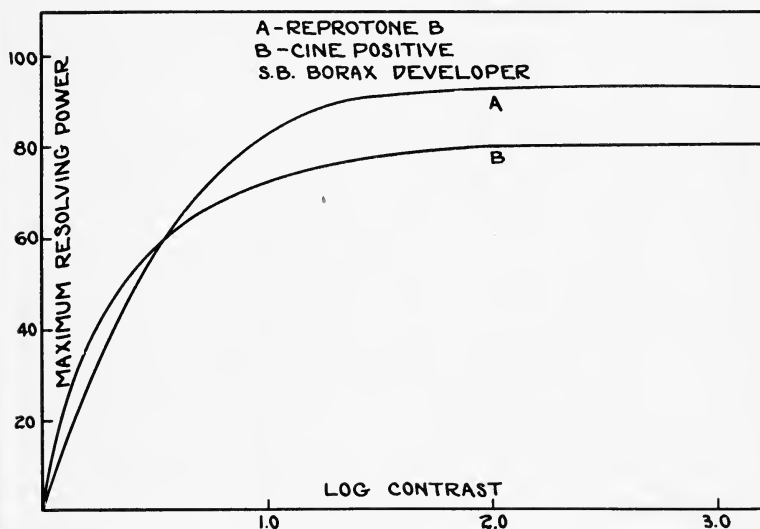

FIG. 8. Resolving power-object contrast curves for motion picture positive (B) and Reprotone B (A) developed in metol hydroquinone borax.

and if the object contrast varies as well, the resolving power is represented by a family of complicated surfaces.

So far we have considered only one type of emulsion, namely, motion picture positive. Reprotone B is of the same general type and its resolving power as a function of image density is represented by curves similar to that shown in Fig. 7. Referring again to Fig. 8, it will be seen that the resolving power-log contrast curve for Reprotone B (curve A) crosses the same curve for motion picture positive (curve B) at a log contrast value of 0.5 corresponding to a contrast value of 3.2. For contrast ratios less than 1 to 3.2, therefore, the resolving

power for Reprotone B is slightly lower than motion picture positive. For values of contrast greater than 1 to 3.2, however, the resolving power of Reprotone B is markedly greater than that of motion picture positive. The effective contrast in sound recording is a function of the modulation of exposure and the amount of scattered light present due to lens aberrations, lens flare, dirty lens surfaces, *etc.* It is difficult to determine the mean effective contrast existing under practical

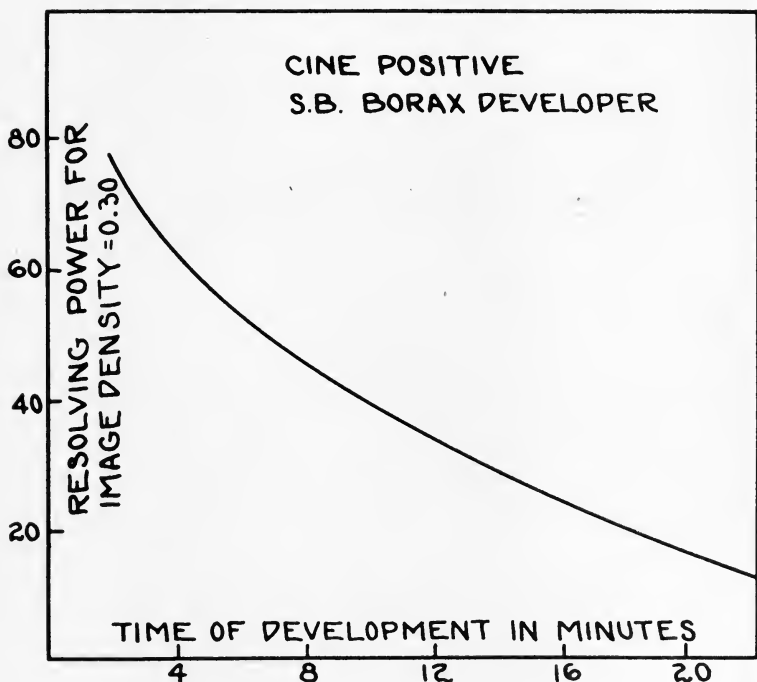

FIG. 9. Resolving power-time of development curves for motion picture positive for an image density of 0.30, developed in metol hydroquinone borax.

sound recording conditions. It seems almost certain, however, that with a high quality optical system in perfect adjustment the mean effective contrast should be well above the 3.2 ratio and under such conditions Reprotone B should be somewhat superior to motion picture positive from the standpoint of resolving power.

We have seen above (Fig. 6) that the sensitometric characteristic curve of the experimental, high contrast emulsion is quite different from that of the motion picture positive. Likewise, the resolving

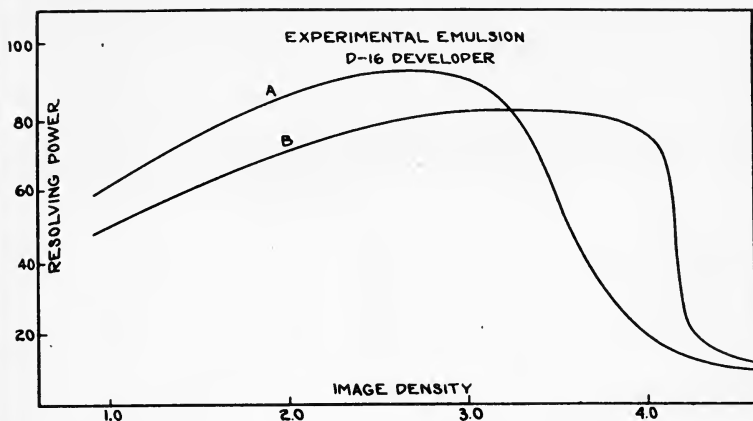

FIG. 10. Resolving power-image density curves for the experimental emulsion. Curve A is for 4 minutes' development and curve B for 12 minutes' development.

power-image density curve is quite different in character from the corresponding curve of ciné positive as shown in Fig. 10, the optimal density of curve A representing 4 minutes' development and curve B 12 minutes' development, both being very high. This type of emulsion is particularly well adapted for variable area recording.

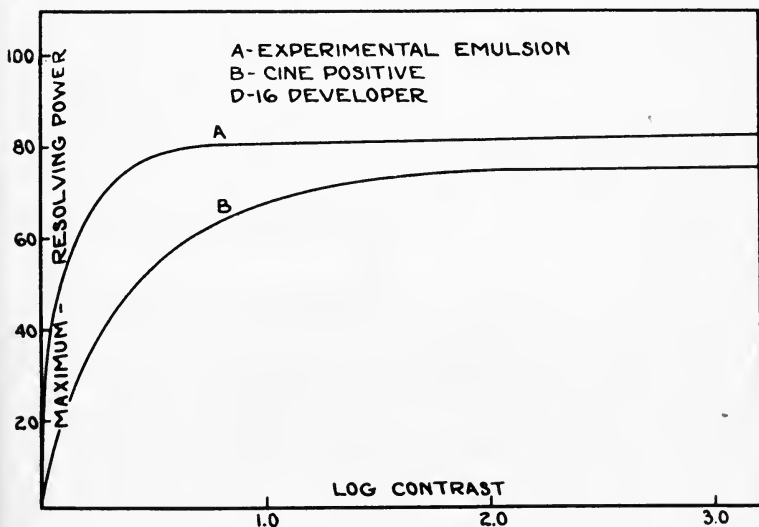

FIG. 11. Resolving power-object contrast curves for (A) experimental emulsion, (B) motion picture positive developed in D-16.

First, because of its high optimal density, the negative could be exposed to a density of two to three, corresponding to a contrast of 100 to 1000, and we have seen in Fig. 8 that resolving power as a function of contrast has nearly reached its maximum value at a contrast of 100.

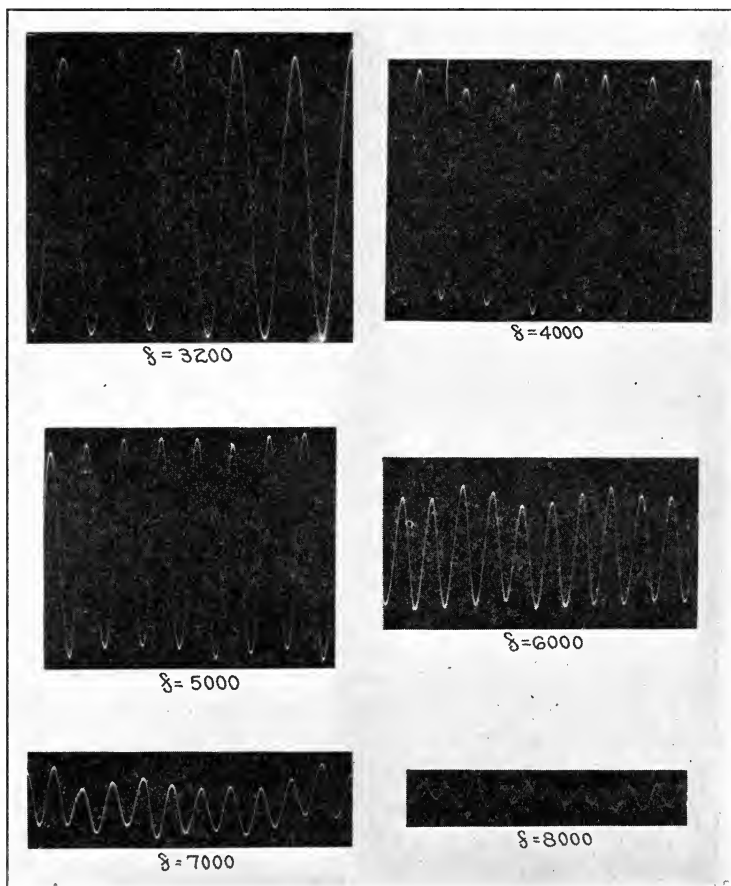

FIG. 12. Micro-densographs of variable density sound records of several different frequencies as shown.

On making a print, therefore, the loss in definition due to lack of contrast would be small. Second, the density gradient at the image edge or sharpness is high because of its high contrast, thus reducing the shading effect at the boundary of the sound record to a minimum.

In Fig. 11 it is seen that the experimental emulsion is definitely superior to cine positive, especially at low contrast. It is true, in general, that the resolution of an emulsion whose inherent contrast is high, gives better definition at low object contrast than one whose inherent contrast is low.

We conclude from the above consideration that to determine the resolution obtainable in a given practical case requires an integration of the effects due to these several variables. This is not possible,

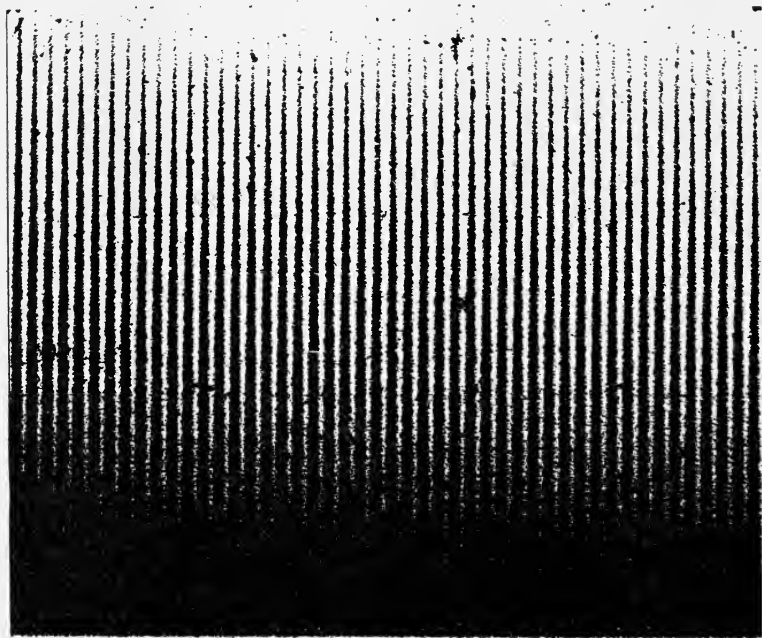

FIG. 13. A photomicrograph of a variable width sound record of an 8000 cycle constant frequency.

with our present knowledge at least. It is probably a fair assumption to make, however, that an emulsion having a maximum resolution of 80, when correctly used with a high quality optical system, will give excellent rendering of tone and form at frequencies well above the highest frequencies now used, and that the volume of those frequencies will not be materially reduced due to lack of definition. As a matter of fact it is possible to record frequencies of 13,000 to 15,000 and obtain excellent definition. In order to do so the adjustment of

focus has to be carried out with the utmost care. A displacement of the objective lens, imaging the slit on the film, by a small fraction of a millimeter causes a change from excellent definition, that is, a high modulation in the density, in one case, to a practically uniform density in the other. In Fig. 12 are micro-densographs of variable density sound records of several different constant frequencies as indicated. These in themselves do not convey much information, but wave form analyses and a study of the various types of distortions and their

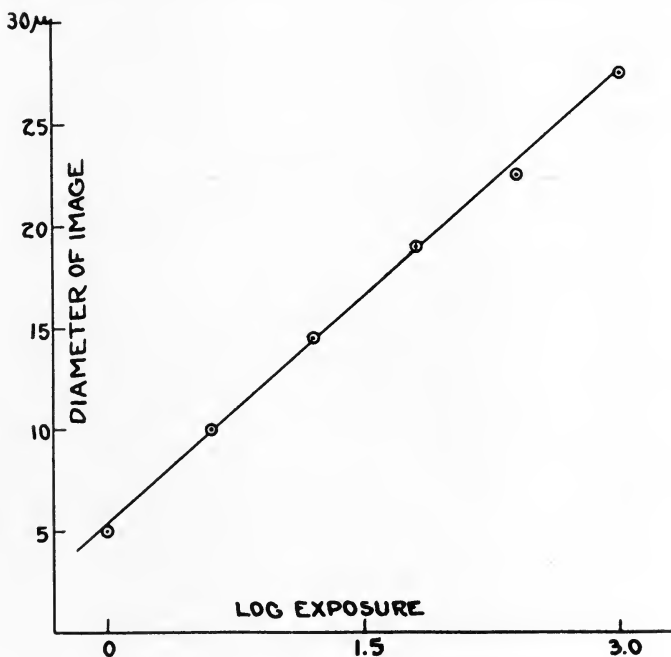

FIG. 14. Curve showing growth of diameter of the photographic image with the log exposure.

causes will be the subject of a future communication and we shall not devote any space to it in the present paper. Fig. 13 is a photomicrograph of a variable area sound record of 8000 cycle frequency. The definition is not perfect, yet the volume depression at this frequency from that cause certainly would not be very large.

The necessity for careful adjustment of the optical system in the reproducer is also of great importance because a decentered filament image on the slit causes a reduction in volume and introduces micro-

phonic noises; and a slightly out-of-focus slit image on the film causes a depression in volume of the higher frequencies of as much as 10 to 15 decibels.

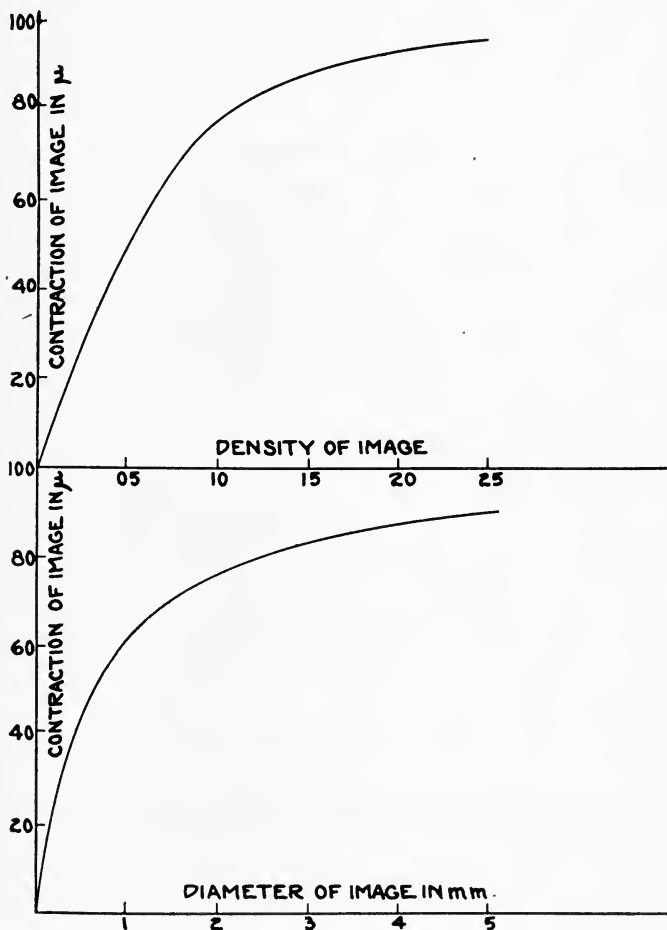

FIG. 15. The upper curve shows the contraction of a 4.5 mm. image with the density of the photographic image. The lower curve shows the contraction of an image as a function of the diameter of the image.

We have referred to certain other factors which might affect the structure of the photographic image, namely, growth of image with exposure, contraction of image, mutual action of adjacent images, and

certain edge effects the best known of which is the Eberhardt effect. These phenomena are probably of more theoretical interest than practical importance at the present time.

The growth of the diameter of an image with exposure is, of course, a well known phenomenon, and has been used by the astronomer for years as a method to determine stellar magnitudes. A typical case of image growth is shown in Fig. 14 where the diameter of the image is plotted as a function of the logarithm of the exposure. The

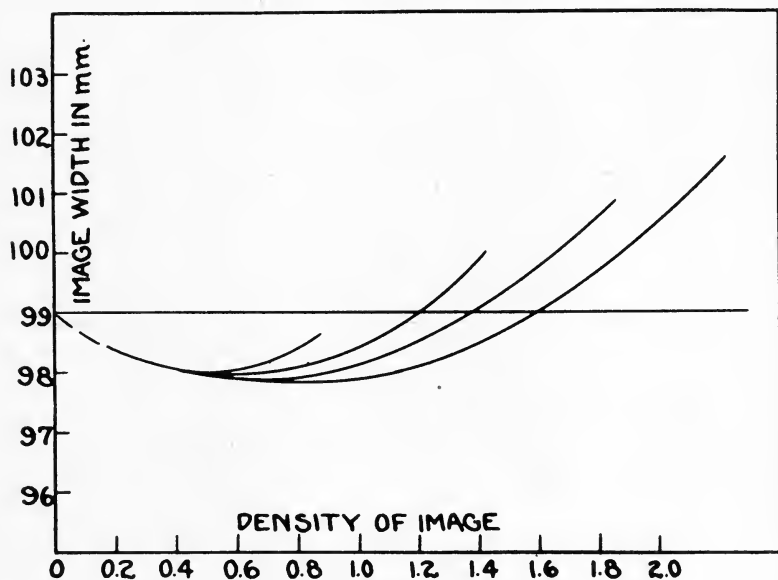

FIG. 16. Curves showing the change in the size of an image as a function of the image density. The family of curves represents 2, 4, 8, and 12 minutes' development, respectively, from left to right.

linearity between these quantities as shown is somewhat better than that in the average case.

There is also a contraction of the image due probably to a tanning action of the reaction products formed during development. The absolute value of the amount of contraction depends on the size and the density of the image as shown by the two curves in Fig. 15. The upper curve shows the contraction with density of an image 4.5 mm. in diameter, while the lower curve shows the contraction of the image with its diameter for constant density. It is apparent from the lower curve that the contraction is differential with the distance from the

edge, being largest at the edge and becoming practically constant, that is, no contraction, 5 mm. inside the edge.

In practice these two effects occur simultaneously. The actual change in the image size depends both on the size of the optical image and on the density of the photographic image. Thus for a very small optical image, that is, of the order of magnitude of the one used in obtaining the data represented by Fig. 14, the growth factor is large, whereas the contraction factor is almost negligible. For an image 10 mm. in diameter, however, the reverse would be true, except in the case of extreme overexposures. The combined effect of the two factors is shown in Fig. 16. This image was formed by a slit 0.99 mm. wide placed in contact with the emulsion. The family of curves represents 2, 4, 8, and 16 minutes' development, respectively, from left to right. It is seen from these curves that for low exposures the contraction factor predominates, whereas for higher exposures the growth factor becomes predominant. Just how important these factors are is a subject for further investigations.

DISCUSSION

MR. KELLOGG: I should like to ask whether sharpness and resolution go together.

DR. SANDVIK: Sharpness and resolution do not necessarily go together. In general, an emulsion which has high resolution also has high sharpness, but they depend on different factors. Sharpness depends on the density gradient at the edge of an image measured in the shadow. The slope of the straight line of the curve is the sharpness, whereas resolving power depends on the slope, and shape of shoulder and toe.

THE MODERN NEWS REEL

HARRY W. JONES*

Nineteen years ago the first news reel was issued. This granddaddy's children have kept pace with the balance of the motion picture industry through its many stages of progress; never behind and usually a few jumps ahead, finally becoming a national, even an international, institution. It has been and still is an important part of every well presented theater program. But little credit is allotted to it as an attraction, and yet it has a personal appeal to every theater patron young or old. Primarily, because it covers every major event in all activities and allows the eye to see those things of interest of which one reads. It also brings to those not fortunate enough to have traveled extensively, places and personages of international fame, and to those who have traveled and seen for themselves it revives many memories. To borrow the slogan of one of the oldest, it "sees all, knows all."

The original news reel was issued weekly as compared to present day activities of a reel a day. Subject matter differs but little, if any. The real comparison is in the equipment used in its making. Contrast the news cameraman of a few years ago with his camera case draped over one shoulder and his tripod across his back, with the ultra-modern equipment of the modern news reel forces. When something happened under the old system, if a cameraman was close at hand he got his story, or perhaps the free lance saved the day or else everyone lost sleep and temper trying to get someone on the spot. Today fast mobile units are scattered throughout the country, always ready for whatever may occur.

Many types of equipment have been developed for news gathering, each having its special place and usage. May I ask your indulgence at this point if I seem a little partial in my descriptions, but being a member of RCA Photophone and having devoted the major portion of the past year to its field recording equipment, I prefer to speak of that with which I am most familiar.

* RCA Photophone News Service, New York City.

The first RCA Photophone news truck was designed for a dual purpose, news reel work, and a rolling studio—mostly the studio. Trying to coax it into performing all the tricks a news cameraman could think up was no sinecure. Two Bell and Howell cameras, two variable area recorders, all four driven by synchronous motors, necessitated power equipment of an unusual size, that is, heavy duty storage batteries and a rotary converter. The necessary charging equipment to keep the batteries in condition added to the weight. Add to all this the recording amplifiers, microphones, *etc.*, a motor generator set for plate supply and you have a good idea of what we were transporting. A few days' experience taught us the motor generator set couldn't stand road shocks, so out it came in favor of "B" batteries. Next we shed one camera and one recorder in the interest of space. In this condition, a news reel a week was turned out for nearly five months—quite a record. This truck gave us our first real test of the durability of our variable area recorders. Although the recording machine was solidly mounted, to the best of my knowledge a mirror has never been shaken from the suspension strips by road shock. The optical system will stay in adjustment for months at a time and the balance of the mechanism has needed little servicing in spite of dirt, grit, and climatical changes.

A real test for an amplifier is to bounce it around a hundred miles or so on choppy roads and find tubes and connections in usable condition on arrival. And may I also add a good word here for the Bell and Howell cameras.

A news cameraman's creed is "get your story" and usually he does. At all principal events provision is made for a camera stand, but the microphone placement man is not always so fortunate and must use dexterity, skill, and, many times, real ingenuity.

The advantages in two-machine recording systems for the news reel are identical to their use for studio work and far overbalance the additional equipment necessary for their operation.

For use in those places where a recording could not be made within four or five hundred feet of a truck an equipment with portable amplifier and power supply was next adapted to field work, and, within a limited scope, proved satisfactory.

Later, trucks were built after the style of the modified first truck. Then came a change; the trucks looked the same but things inside were different. A new and better recorder replaced the old, ampli-

fiers were simplified, a power take-off for battery charging was added as was also an outside pick-up amplifier and mixer panel.

The power take-off added greatly to the mobility of the outfits in that charging was done while the truck was *en route*, or on the scene if necessary, thereby insuring a constant power supply. The outside pick-up amplifier was an even greater improvement. By its use an operator could take this portable equipment away from the truck to the scenes of action and there monitor more advantageously on either or all of the three microphone circuits available. By an intercommunicating system the operator was in contact with both cameraman and machine operator in the truck, and was often able to get worthwhile shots that might otherwise be missed where operation is solely from within the truck.

The demand again came for lighter and more portable equipment and this time the RCA Photophone laboratories produced a Mitchell camera equipped with a variable area recorder built as an integral part. A light amplifier accompanied the Mitchell and with only 6 volts for power supply the whole made a real portable outfit. The equipment fits nicely in the new business body sedan of a light and fast car, so the operators now tour in style. There are several improvements on this outfit worthy of mention. A dry galvanometer replaces the oil damped model in general use. For portability the advantage of this absence of oil is very apparent, and the current needed to drive it is considerably less than the oil damped type. An optical system requiring much less space and using a focused filament image in place of a mechanical slit is among the newest additions.

Sound on this Mitchell portable equipment is recorded at projector spacing, or the standard 14.5 inches ahead of the picture. As recording is done by the variable area method, development and printing can be done in virtually any laboratory on the road even though not equipped with sound printer, so rushes or quick news releases may be made almost anywhere. Quality compares favorably with the two-machine method and the total equipment weighs less than four hundred pounds.

DISCUSSION

MR. HAMMOND: May I ask why more even sound level is not maintained in making the positive?

Subjects are cut off very abruptly, in the middle of a word often, and instantly it goes into music accompanying the title.

MR. JONES: We regulate sound level to the best of our ability, but the record is made under such varying conditions that it is very difficult to get an even level.

There is bound to be some variation although we are doing our best to overcome it.

An explanation of abrupt cut-offs is the fact that the news reel is 10,000 feet long and only 500 feet are shown.

MR. RICHARDSON: This puts the projectionist in an embarrassing position. When level changes occur, the audience instantly blames the projectionist. Audiences have no means of knowing such faults are out of the projectionist's control.

MR. JONES: You must remember that news reels are taken every day, and we haven't the time to cut or record sound as it is done in the studio. We get a story at noon, it may be something very "hot" and it's on the screen that night. We are getting better and not worse, however.

MR. C. L. GREENE: The rapid improvement in sound film is certain evidence that the men in the production field are doing the best they can to eliminate faults. The projectionist who has passed through the hectic time of conversion from silent to sound basis can well appreciate what the news-reel man is facing. We know we cannot expect perfect recording, but perhaps those in production work don't realize the seriousness of some of these faults when the film gets into the theater. No recording can be good recording if it cannot be well reproduced. The audience, remember, doesn't know or care what the source of the disturbance is, but is prone to blame everything on the projection staff.

We run Photophone recorded news reels on Photophone equipment, and I make a detailed volume cue sheet for each reel. It is not unusual to have this sheet call for amplifier gain control settings ranging all the way from 6 to 30 T.U., but this condition is not serious provided we have time to rehearse the reel and have a second or two of silence between the portions requiring greatly different amplification.

The other day, however, we had a typical case that was serious. Essential dialog was recorded at such a low level that the maximum double amplitude of the sound track was only 0.005 in. Following within 0.05 in. or less than 0.003 second came the cheering of a large crowd recorded with a double amplitude of 0.065 in. The gain control had to be held at over 30 T.U. to render the dialog intelligible, whereas 10 was ample for the cheering. The result when the cheering started was that for one- or two-tenths of a second the amplifier probably delivered in excess of 150 watts to the speakers, and they in turn sent forth a volume of sound which was extremely unpleasant all over the house. In the case of the patrons in the first few rows it was quite possibly painful. This was not a news reel, but a studio production. Run through one type of very high grade reproducing equipment it would probably have wrecked the speaker units.

One speaker questioned the possibility of an amplifier delivering enough power to "blow people out of their seats." Scientifically speaking, of course, he is right, but when immediately following such a disturbance patrons leave the theater and are not seen in the theater again, it perhaps is not far wrong to say that they have been "blown out of their seats."

MR. CRABTREE: I notice that one large manufacturer of radio receivers has an automatic control device so that the volume output is constant. I think the solution of the problem would be to install a similar apparatus in the projection booth.

MR. RICHARDSON: I am doubtful whether that could be done owing to varying conditions in theater auditoriums. What is right now is not so in fifteen minutes from now in the house when the audience has changed.

MR. CRABTREE: It could be set, and once set at a certain level, it will continue to give you the sound at that level. Of course, the level could be changed occasionally to take care of the varying audience.

MR. JONES: In recording, the volume level control is comparatively simple. We have accumulated trucks more rapidly than we can train the personnel needed, and men went out on the jobs who have not had sufficient training. They accumulate knowledge as they go along and iron out the troubles.

MR. RICHARDSON: Let us assume this condition: Fifteen minutes after eight, when the audience is in, you must have a certain volume setting, and then fifteen minutes later you have more audience and must take care of that.

MR. CUTHBERTSON: An automatic control device would be out of the question on the news reel system. It is not needed, in fact. One of the greatest users puts out a news reel with no cue sheet. It is run at one fader setting, and the operator should not change it; it runs through without variations in level.

FILM PERFORATION AND ITS MEASUREMENT

WALTER H. CARSON*

The advent of sound in the motion picture field and the growing popularity of color productions, as well as the imminent changes in the size of motion picture film, have raised many new problems throughout the industry from the standpoint of the producer, the laboratory, and the manufacturer.

Not least among these questions is that of the perforation. This is not a new question, for it has been the subject of much discussion for a number of years past, but, through the coöperation of the various factors, there has been a gradual standardization. Besides the perfection of the perforators themselves, there has been a continuous effort to improve the sprockets and claws in cameras, printers, and projectors. Also, the inevitable shrinkage of film has been reduced to a minimum.

In the 35 mm. field a very definite basis of standardization has been reached, which has been fully accepted by both the manufacturer of raw film and the manufacturer of mechanical equipment, so that damages to the film resulting from lack of uniformity between the perforations and the devices for the transportation of the film through the various mechanical units have to a large degree been eliminated. It still happens, however, that the film user encounters some difficulty in his camera, developing machine, or projector which can only be explained by a fault in the perforations, which, in turn, might be traced to excessive shrinkage of the film.

Heretofore, the means of convincing himself of the correctness of this conclusion have usually been either crude and inadequate or unavailable on account of the intricacy of such equipment. Mechanical engineers developing film equipment of any kind are still inclined to demand a very close conformity to the figures of standardization on newly perforated film and to condemn each minute variation from these figures as an insurmountable difficulty. They disregard entirely the fact that mechanical equipment must be so made as to

* Agfa Ansco Corporation, Binghamton, N. Y.

allow a tolerance in the film due to the factor of shrinkage. The old empiric method of placing a piece of negative on a new piece of raw stock to prove that the pitch of the perforation hole is incorrect, is obviously not a safe method on which to form a judgment, since it is always practically impossible for the mechanical man to know the age of the film which he is using as a gauge.

It is hardly to be expected that newcomers in the industry, such as cameramen, operators in the printing rooms, and projectionists, will be entirely familiar with the long discussions which have taken place in the past and are still going on in some foreign countries to establish an international standardization. Neither can we expect them to know that the best results are secured from films which do not have an exact pitch in perforation or measurement between centers of perforation holes of 4.75 mm., but that there is a maximum tolerance between 4.68 and 4.76 mm. which will allow of free movement of the film on all of the conveying equipment without risk. By far the larger proportion of persons handling films, who have little interest in these mechanical and theoretical problems, merely ask, when difficulty is encountered: "What is the matter? Is the film or the equipment at fault?" In such cases it is very essential, when trouble is encountered, to be able to convince oneself whether the film perforation is correct or not, but, before attempting an examination or measurement of any kind, it is desirable to know definitely what is right and wrong. Theoretically, the answer to this is contained in the terms of standardization which indicate how the film must be manufactured or perforated to avoid trouble on standardized equipment through which the film must be transported.

In order to refresh your memory, we will state that the standard establishes the following measurements:

First: That the distance of perforations, or pitch, immediately after perforation, must be between 4.75 and 4.76 mm. for positive film, and between 4.75 and 4.77 mm. for negative film.

Second: That the shrinkage under unfavorable conditions, such as 720 hours in air of approximately 140°F. and of a 70 per cent relative humidity, should not exceed 37.5 inches in 400 feet, or 0.78 per cent.

In the matter of the first clause of standardization, the film user must, of necessity, take the manufacturer's word for the correctness of the measurement at the time of perforation, because it is very seldom that the film reaches the consumer immediately after being

perforated, and, in all makes of film the shrinkage starts even before the can is opened. It is, therefore, necessary to standardize the sprockets and claws to compensate for the shrinkage which has already taken place before the film is put through the camera or the printing machine. Under the present methods, it is only possible to check the second items of standardization by means of elaborate laboratory tests for which the film user has no facilities. It is also essential for the operator to know how much variation or tolerance is allowable in film at its various stages of handling before it will cause trouble in any kind of equipment.

In order to clear up the first question regarding the actual measurement of raw film before it is put to use in the camera or printer, an average of a great number of tests was taken. This proved that perforation measurement of film at the time it reaches the consumer is usually between 4.75 and 4.73 mm. It may be remembered that variations of pitch must still go much further, in fact, below 4.68 mm. before they will cause difficulty in well built equipment.

In the case of the claw movement on such equipment, it is easy to understand why difficulty is not encountered because the diameter of the claw is normally several tenths of a mm. less than the actual size of the perforation hole; therefore, the difference in distance between the first and fifth perforation holes, which are the ones used in the claw movement, can be reduced from 19 to 18.7 mm. without noticeable trouble.

The question of sprocket transportation is a different one, but here again, numerous experiments have proven that a shrinkage of less than 37.5 inches in 400 feet will not cause difficulty in either negative or positive film.

For obvious reasons, after development and drying, the distance between the perforation holes is still less. If the film is dried in the laboratory only enough to give the proper or original hardness of the emulsion, there will be a very small difference between its measurement at that time and in the raw state. In most of the drying boxes used at the present time, however, there is a shrinkage during drying after development of from 0.1 to 0.2 mm., so we find that on the average, the processed film after it leaves the laboratory measures between 4.74 and 4.72 mm., and, in some special cases, as low as 4.69 mm.

The shrinkage of film, both negative and positive, continues to go on as small quantities of solvent contained in the nitrocellulose base are driven off. This cannot be entirely stopped, but the older the

negative or print gets the more this shrinkage is retarded until a final point of shrinkage is reached. This continued shrinkage is rather slow in the case of negative because of the fact that negative is usually more carefully stored in sealed tin cans and under favorable atmospheric conditions. In the case of positive film, which is put through the projection machine many times and subjected to the intense heat of the projection lamps, the process of shrinkage will be comparatively rapid.

It is interesting to note the experience gained from 100 pieces of positive stock of various ages as they came into the exchanges. These were carefully measured, and it was found that the measurement between the perforations varied from 4.74 mm. to 4.69 mm., showing an average of 4.71 mm. which, of course, is still usable.

Let us compare these figures with the measurements established by the French standardization, which call for 16 teeth engaging on the transport sprockets. The diameter of the rolls at the base of the teeth is 23.85 mm. Adding to this diameter the thickness of normal film, which is approximately 0.15 mm., we obtain a total diameter of 24 mm. which, in turn, gives us a circumference of 75.3 mm. Dividing this by 16 because of the 16 tooth engagement, we find that the distance between the centers of the teeth on the circumference of the sprockets at the base of the teeth is 4.71 mm., or exactly the figure which we secured by the empiric experiment mentioned above.

It is very unusual to encounter shrinkage greater than this, but, in the case of very old film—which, in some instances, had been perforated prior to the setting of the present standard—we encounter shrinkage down to 4.68. Usually when film has reached this point it would be necessary to discard it in any case because of its excessive curl and brittleness.

From the foregoing it will be seen that it is possible with microscopically accurate instruments to determine the shrinkage of the film by measurement of the distance between corresponding edges of the perforation holes or by placing two pieces of film together, one of which is as new as possible, and thus test visually whether the old film has shrunk or not, and, if so, how much.

The difference of one perforation width in one-half meter would indicate, by the above test, that the difference in shrinkage between the two pieces of film amounted to 2 mm. in 500 cm.

There are three methods with which we are familiar by which the difference between perforations can be established.

The first is to count 100 holes on the film and make a measurement with the ordinary ruler between the corresponding edges of the first and one-hundredth perforations. This gives a measurement of between 476 and 468, which is great enough in length to be easily recognized when compared with the standard. It will tell just how much in millimeters the film has shrunk between the individual perforation holes.

The second method gives a similar measurement by comparison with the standard but consists of taking the piece of film the length of 40 perforations and stretching it between brass slides. The distance between the corresponding edges of the first and forty-first holes is measured with micrometers and is approximately 190 millimeters. If this space is divided by 40, you again have the difference between the individual perforations. This is merely a modification of the first method mentioned, only using a shorter piece of film.

The third method is to measure the perforation space or pitch with a calibrated microscope. It is essential in using this method to make several measurements before striking an average. There is always the possibility of a minute variation between the individual perforation holes which could be detected by the microscope but which would not be an accurate measurement of the shrinkage of the film, nor be great enough to cause any difficulty with it.

In this connection we might mention that under the old system of one-hole perforation it was essential to determine the exact distance between each pair of holes, as a consistent variation would give an unsteady picture and a noticeable change in the frame line on the screen. At the present time, to the best of our knowledge, all of the manufacturers are using the four-hole system of perforation, which punches four holes on each side of the film at one time with a gang of eight punches. The film is then drawn forward by a shuttle and eight pilots, engaging and filling exactly the previous eight holes punched, thereby very accurately placing the film into position before the next eight holes are punched. With this system it is practically unnecessary to check the distance between the individual holes unless a marked recurrent unsteadiness is noted on the screen. We might also mention another interesting point in this connection—that tests have proven that film having a uniform thickness shrinks uniformly throughout its length, so that the relationship of the perforation holes one to the other is not changed.

We do not believe that any of these three methods described above

are particularly popular for practical use. The first one is not commonly known, and the other two require instruments of a type not usually available to the film laboratory or exchange. It was these facts which led to the introduction of a perforation pitch measure by Agfa, which, by its size and convenience of use, makes it

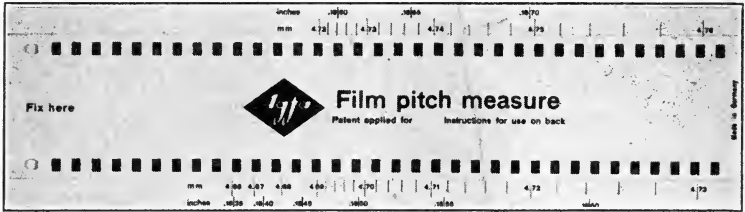

FIG. 1. Perforation pitch measuring rule.

possible for the cameraman, laboratory operator, or inspector in the film exchange to check the condition of a film as regards perforation, accuracy, and shrinkage without intricate, optical, and mechanical equipment, and the incidental loss of time and money.

This rule (Fig. 1) consists of a light metal bar having two pins at the left end and a groove 35 mm. in width for its entire length. The film to be measured is fastened over the pins, depressed into the groove and pulled tightly against the pins to the right over the end of the rule, as shown in Fig. 2. Underneath, where the film perforations rest, are square black marks, 2×3 mm., printed on the ruler.

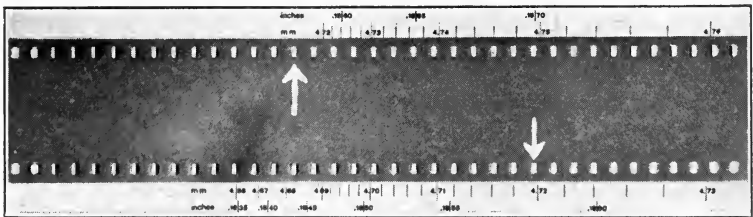

FIG. 2. The rule with film to be measured.

The distance between these squares is slightly greater than the standard distance between perforation holes on new film. For this reason, these marks shift as regards the area seen through the perforation holes until the difference finally amounts to the width of one perforation, or 2 mm. It is easy to recognize the point at which the

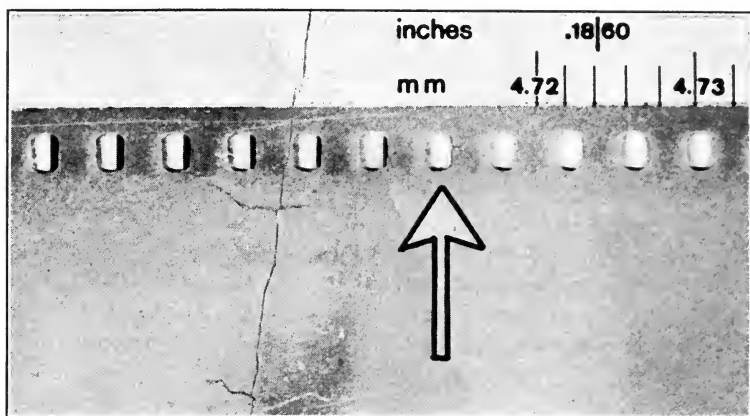

FIG. 3. Use of the upper scale.

right edge of the perforation hole will coincide exactly with the left edge of the black mark underneath. By means of a scale, which is given in both millimeters and inches outside the edge of the film, it is possible to read, at the point at which this coincidence takes place, the distance or pitch between the centers of the perforation holes on the piece of film being measured.

As indicated by Fig. 3, in order to secure as much accuracy as possible, the distance between the upper set of marks and the lower

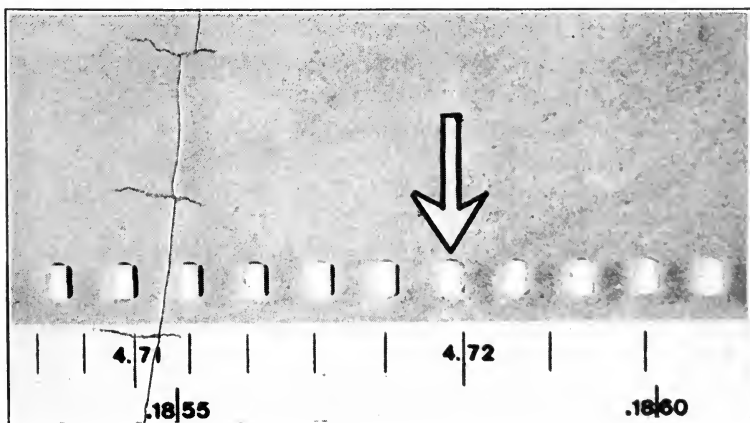

FIG. 4. Use of the lower scale.

set of marks has been made different, so that in case of film having little shrinkage the upper set is used. Where the shrinkage is below 4.72 mm. the lower scale is used, as you will see indicated in Fig. 4. Greater accuracy is given in the reading of the lower scale. The reading in the illustrated instance would be, actually, 4.719 mm. You will see by comparison of the figures which we have quoted in the foregoing that, with a scale 175 mm. in length, it is possible to measure accurately a shrinkage below the usual point of film shrinkage.

The principle of this measurement is very simple and surprisingly accurate, since it is possible to determine very quickly a variation down to $1/100$ part of a millimeter which is accurate enough for all practical uses.

A development of the idea which led to this principle of measurement and a critical examination of its accuracy may be of interest to some. We have, therefore, incorporated into this paper the basis upon which the various measurements on the rule have been established, together with the basic equation for working it out.

Let us take two pieces of film, one being as new as possible, placing the oldest one on top of the other in such a way that, at a given place which we will call A , the left hole-edge of the upper film coincides exactly with the left hole-edge of the lower film. Since the upper film has shrunk more than the lower one, there will be a certain distance to the right, which we will call S , where we will find that the right perforation edge of the upper film lies on the left perforation edge of the lower. A simple equation gives as a result the relation between the perforation space of the lower film, A , and the perforation space of the upper film, X , the distance, S , between the beginning and the reading point, and the width, B , indicating the width of the perforation in the upper film. We, therefore, have the following equations:

$$S = NA = NX + B$$

$$\frac{S}{A} = \frac{S - B}{X}$$

$$X = \frac{A(S - B)}{S} \dots\dots\dots(1)$$

$$S = \frac{AB}{A - X} \dots\dots\dots(2)$$

Now let us replace the lower film with a metal bar, bearing the perforation holes as black marks, and, to facilitate the registration

of the first pair of holes exactly, we fix two pins accurately at that point. Now we must decide about the length of the metal bar and what degree of accuracy is desirable. On the bar, the distance between the black marks will be determined by the two foregoing factors. Let us, therefore, glance at Table I, which will give the distance of the reading point from the pins, S , for various values of X , and A , figuring the value of B in this equation as 2 mm., since that is the standard width of a positive perforation hole:

TABLE I
Distances of Reading Points from Rule Pins

	$a = 4.76$	Marking Distance on the Ruler			
		4.77	4.78	4.79	4.80
Perforation distance of the film.					
$x = 4.68$	119.0	106.0	95.6	87.1	80.0
4.69	136.0	119.3	106.2	95.8	87.3
4.70	158.7	136.3	111.5	106.4	96.0
4.71	190.4	159.0	136.7	119.8	106.7
4.72	238.0	190.8	159.3	136.9	120.0
4.73	317.3	238.5	191.2	159.7	137.1
4.74	476.0	318.0	239.0	191.6	160.0
4.75	952.0	477.0	318.7	239.5	192.0
4.76		954.0	478.0	319.3	240.0

It will be noted that it is possible to measure perforation distances between 4.68 and 4.76 mm. with a ruler 175 mm. in length, provided the distance between the marks is 4.79 mm. A greater distance between the marks will reduce the length of the scale. A smaller distance will increase the accuracy, but also lengthen the ruler.

By establishing the distance between the black markings on the upper row as 4.79 mm. it is possible to read a variation between 4.76 and 4.73 mm., and, similarly, by establishing the distance on the lower row at 4.76 mm. it is possible to measure between 4.73 and 4.68 mm.

We have assumed, up to the present, that the pins have been placed in a position which will coincide exactly with the correct position of the first pair of holes on the strip of film to be measured; however, if they are placed a little to the left, we can facilitate the reading of slight variations, or, if these pins are moved to the left 1 mm., the original equation will be changed as follows:

$$S = \frac{AB - X}{A - X}$$

Table II shows the advantage of using the above equation.

TABLE II
Comparison of Two Pin Settings

Pins	Distance between Marks	$x = 4.71$ Mm.	4.72 Mm.	4.73 Mm.
On the marks	4.79	$S = 119.8$	136.9	159.7
1 mm. to the left	4.76	$S = 96.2$	120.0	159.7

You will note that these figures show that we gain greater accuracy with the same length of rule.

In all of our calculations up to this point we have assumed the perforation width as exactly 2 mm. For this reason this ruler would be, strictly speaking, correct only on positive film, as negative film has a perforation width of 1.854 mm. The discrepancy caused by this variation, however, is so small as to disappear almost completely in calculating the ruler from the beginning with a perforation measurement of 1.92 mm., which is the figure actually used in establishing the measurements as shown on this scale.

DISCUSSION

MR. EDWARDS: Is there lateral as well as longitudinal shrinkage of film?

MR. CARSON: This matter was first brought to my attention today. I was told that there was a shrinkage of $\frac{1}{8}$ inch in film of 70 mm. width.

MR. EDWARDS: I recently ran a film that was shrunken pretty badly. On one side it rode perfectly and on the other it was terrible. The effect on the screen was like a ship at sea.

MR. CARSON: If I may digress for a moment, I should like to tell you that in the manufacture of film base two things count: One is the bead, which is a thick part in the base itself. The second is that as you approach the edge of the sheet, which under normal conditions is 42 inches wide, there is a gradual thinning. Neither has anything to do with the normal shrinking in the roll. In my paper I have spoken of a film having an equal thickness on both sides. If the film is thinner on one side than on the other, the shrinkage will be different.

THE HUMAN EQUATION IN SOUND PICTURE PRODUCTION

TERRY RAMSAYE*

A great deal of the equipment now used in the recording of sound pictures is highly unreliable and full of trouble.

The equipment and the machines are, in the main, a great deal more reliable and cause less trouble than the men who run them.

Manpower is frequently the major problem in industry, and it is now acutely the most difficult problem in our industry of the talking motion picture.

This problem is going to be solved, of course. One of the answers is education of personnel through the endeavors of such organizations as the Society of Motion Picture Engineers. Another answer is the selective action on personnel which always operates most conspicuously through the early periods of any industry involving a new technic. The turnover in studio and sound truck employment is likely to be rather rapid in the next year for this reason.

It is time to "debunk" the sound recording business and take the mystery out of its processes. This Society of Motion Picture Engineers can help importantly in that direction.

In its present status of development, sound recording devices appear to need rather frequent attention and a considerable array of routine tests, but it is not unfair to say that its operation requires hardly more attention from the recordist than is necessary for the intelligent tuning of a fairly sensitive radio set. Yet, there is observable, a continual effort to camouflage the work with a great atmosphere of complexity and strange obscurities.

Recently one of the companies with whose activities I am sometimes concerned had a simple task in re-recording a dramatic sound strip for the elimination of some minor faults of the negative.

It is hardly necessary for me to interpose the statement that the best sound re-recording is now done by direct connection of the recorder with the amplifier serving the sound head, making the operation entirely an electrical operation without audible sound.

* Pathé Exchange, Inc., New York City.

Now the alleged technicians on this job insisted on delaying the work for two days and transporting and installing a ponderous belt driven film phonograph, despite the fact that two perfect sound projecting machines were already available in the plant. I had the boldness to protest against the unnecessary delay and expense.

"But," the experts screamed at me, "we have to keep away from the noise of the projector gears when we re-record." They were so unutterably dense that they did not realize that it takes a microphone to electrically listen to a noise.

Every executive concerned with the making of sound pictures can tell you plenty of stories as bad as that one, and some a great deal worse.

The situation is, however, no more serious in the field of sound than it once was in simple motion picture photography. As late as 1916, I found laboratory experts running around with mysterious little black books in their pockets, with secret formulas for making various tones on film. These secrets they so carefully guarded as their capital of skill had been published to the world for years by George Eastman. They were well known to any interested person who could read. I have always thought that an introduction to the art of reading would be a great help to the movie industry anyway.

I am inclined to have a little more patience with the present problems on the sound recording operations in the field when I recall experiences with an endeavor to put panchromatic film into studio and newsreel operations about fifteen years ago. Some of the best cameramen in the business assured me that they could get the same or better results with ordinary ortho stock and some trick filter of their own devising. When I started to talk to them about absorption bands, they walked away tapping their heads. The status of panchromatic stock today is ample answer.

We can anticipate that some day sound recording mechanisms will be about as foolproof as the cameras are now. But that will not come soon enough to save the necks of the alleged recordists who refuse to qualify.

It seems fairly clear that we may hope for a great simplification of sound recording equipment. In one of my annoyed hours the other day, I found that in producing Pathé Sound News with the excellent but ponderous camions made by the General Electric Company, we used 44.63 ton-miles per second of edited screen time. Operating a big fleet of these big trucks makes newsreel production closely re-

semble the railroad business in terms of mileage and tonnage. We may recall that Mr. Thomas A. Edison's first motion picture camera was larger than a doghouse, and weighed about half a ton. It has less capacity for the same work than a five pound automatic camera of today.

Some of our troubles in the sound recording business bearing on personnel have their smiling aspects. In a sound track made by one of a fleet of camions assigned to an event in Washington, we found surprising sound resembling thunder and the sharp crash of lightning coming from a very clear sky, and disagreeably accompanying an otherwise pleasant bit of music. The resulting investigation revealed that the microphone man had been standing alongside his instrument, cracking peanuts while the event went on. That nickel's worth of peanuts was expensive for both the company and the employee.

One of the major problems of personnel reposes in the difficulty of convincing both engineers and recordists that they are engaged in an enterprise which is an art quite as much as it is an industry. While mechanical and electrical perfection are necessary they are not in themselves enough. There is no substitute for thinking and for that general assortment of common knowledge that the diverse problems of the work require.

A trivial case in point developed not long ago when we were engaged in making a sound interview with Chief Justice Taft. The microphone man had been cautioned to make notes for the subject report on each scene as it was shot. At the conclusion of the talking on this assignment, the young man dashed up and demanded, "Mr. Taft, now what is your first name and how do you spell it?"

PROGRESS IN THE MOTION PICTURE INDUSTRY*

The most important items of progress during the past six months have been the extensive use of all-color sound pictures, or pictures with extensive color inserts, and several demonstrations of enlarged projected pictures by the use of film wider than 35 mm.

Only two-color subtractive processes are at present in vogue and in one process extensively employed, two dye images are produced in a single layer film by imbibition. Although some three color imbibition films have been prepared, they have not been publicly displayed

To date only one type of wide film has been put on the market, this being 70 mm. wide. Comment of the trade has been most enthusiastic with regard to its suitability for scenics and news events, but it is apparent that a new photographic technic is required to secure more pleasing perspective in the case of photoplays. Difficulties involved in the more universal adoption of the wide film are the present lack of standardization of size, the necessity for greater illumination at the projector aperture, and the prevention of film buckle.

Studios in Hollywood are now producing only about 5 per cent of silent pictures. When it is considered that only one year ago the first dramatic sound pictures were shown before the Society, notably *The Singing Fool*, the remarkable progress made since that time is apparent. There has been a steady improvement in the quality of sound reproduction, notably in the theater, but in many cases the quality in the theater falls far short of that which the film is capable of producing when it leaves the studio. Much still remains to be done in the way of improvement even with the best of recording. With the high quality music given by the modern radio receivers the public is realizing that the average theater music is not equal in quality to that emanating from their radios at home.

Notable advances in studio technic have been (a) the tendency to use a minimum number of microphones and eliminate mixing, (b) the silencing of cameras by means of insulating coverings thus permitting greater freedom of camera location, (c) the tendency to use

* October, 1929—Report of the Progress Committee.

more live studios so as to simulate more closely natural sounds, and (d) the non-simultaneous recording of scene and sound.

A noteworthy advance in reproducers has been the introduction of the condenser or electrostatic reproducer consisting of a rubber diaphragm coated with aluminum foil stretched across a metal grid. Apart from the high quality resulting, the reproducer occupies no more space than the average screen and can be raised and lowered just as easily.

No fundamental advances have been made in the field of stereoscopic motion pictures and although some of the sponsors claim that their wide film processes give stereoscopic effects, they are at the most pseudo-stereoscopic. A much higher order of relief is noticeable in many of the pictures in color.

Although color pictures have been televised during the past six months, the probability of television usurping the present motion picture appears to be very remote.

Respectfully submitted,

J. A. BALL

J. W. COFFMAN

F. A. BENFORD

R. E. FARNHAM

L. J. BUTTOLPH

G. E. MATHER

G. L. CHANIER

R. ROGERS

J. I. CRABTREE, *Chairman*

SUBJECT CLASSIFICATION

I. PRODUCTION

A. *Films and Emulsions*

1. New Materials
2. Manufacture
 - (a) Nitrate Film
 - (b) Acetate Film
3. Miscellaneous

B. *Studio and Location*

1. General
2. Studio Construction
3. Lenses and Shutters
4. Cameras and Accessories
5. Light Sources
6. Make-up
7. Exposure and Exposure Meters
8. Trick Work and Special Process Photography
9. Technic of Direction
10. Methods of Recording Sound
11. Actors, Scenarios, Sets, etc.

C. *Laboratory Practice*

1. Equipment
2. Photographic Chemicals and Solutions
3. Printing Machines and Methods
4. Editing and Splicing
5. Titles
6. After Treatment, Cleaning, Reclaiming, and Storage

II. DISTRIBUTION

III. EXHIBITION

A. *General Projection Equipment*

1. Projectors and Projection
2. Fire Protection
3. Lenses, Shutters, and Light Sources

B. *Special Projection Methods*

1. Sound Picture Projection
2. Stereoscopic Projection
3. Continuous or Non-intermittent Projection
4. Portable Projectors

C. *Miscellaneous*

1. Screens
2. Theater Construction and Illumination

IV. APPLICATIONS OF MOTION PICTURES

A. *Education*B. *Medical Films, Radiography, and Photomicrography*C. *Telephotography and Television*D. *General Recording*

V. COLOR PHOTOGRAPHY

A. *General*B. *Additive Processes*C. *Subtractive Processes*

VI. AMATEUR CINEMATOGRAPHY

A. *General*

1. Cameras
2. Projectors and Accessories
3. Editing, Scenarios, and Libraries

B. *Color Processes*

VII. MISCELLANEOUS USES, STATISTICS, AND NEW BOOKS

I. PRODUCTION

A. *Films and Emulsions.*

Some of the special negative emulsions for making sound motion pictures announced in the spring report have found extensive use

during the summer of 1929 as the bulk of pictures made were all-sound pictures or contained sound sequences. Tinted films for sound positives were described by Jones at our spring meeting.¹ These films have the base tinted with dyes which transmit light capable of exciting uniformly the photo-electric cell thus avoiding a fluctuation in the volume level during a change of tint which occurred with some of the older tinted bases. A patent has been granted on a film base suitable for sound motion pictures having a substance in the base rendering it translucent.²

A marked increase in the use of film emulsions for color motion pictures has occurred during the past six months. Many entire features in color and sound have been announced, a number of which have been released, notably, *On With the Show* which required about 350,000 feet of negative film in the making.³

The most radical advance since the advent of sound is the impending adoption of wider film. This has apparently been a result of (a) the introduction of processes designed to give pseudo-stereoscopic effects, and (b) the need for a larger picture when screening large musical stage settings. Three processes have been announced, namely, the Spoor Natural Vision process⁴ which uses films 63.5 mm. wide, Magnafilm,⁵ which uses a film 56 mm. wide, and Grandeur which employs a film 70 mm. wide. The Spoor system is capable of projecting a picture 70 feet wide although a screen 52 feet wide by 30 feet high was used in the demonstration. Magnafilm for which stereoscopic effects are also claimed was demonstrated in New York at the Rivoli Theater on July 25th, the screen used being 40 feet wide by 20 feet high.

A sound newsreel (sound-on-film) and a feature picture made on Grandeur film opened at the Gaiety Theater, New York, September 17th and was favorably received.⁶ A screen of 40 feet overall width was used which fills the proscenium arch.

Another method of securing larger pictures which has many commendable features is the Fear process.⁷ This uses standard 35 mm. film and photographs the picture lengthwise instead of across the film by means of a special optical system which rotates the image through 90 degrees, a similar rotation also being necessary on projection. A longer sound track per picture frame is a feature of this process.

Westerberg⁸ has analyzed several of the suggestions for wider film and warns against the confusion which may result if several film sizes

should be adopted. He suggests a picture size of 36 mm. by 22 $\frac{1}{2}$ mm. leaving 4 mm. for the sound track and 11 mm. for the sprockets giving a film 51 mm. wide. In the positive print, the sound record is printed outside the perforations and with sound-on-disk methods a narrower film (47 mm.) is suggested.

To avoid difficulties resulting from damage to the sound track because of its narrowness and proximity to the picture area and perforations, the German Tri-Ergon process uses a 42 mm. film and prints the sound track in the center of the extra 7 mm. width.^{8a}

In the more direct field of manufacture, Dideé⁹ has given information on the manufacture of film base and preparation of emulsions. Details of the preparation of Ozaphane film have been published by Pouchon¹⁰ and two patents have been granted relating to films coated with a diazo compound and phenol.¹¹ Only a few patents have been granted on improvements in the manufacture of nitrate base¹² whereas the continued large number of patent applications related to acetate bases¹³ give evidence of the efforts being made to standardize this product. Two patents have been granted on the design of a machine for making transparent film of viscose or cellulose acetate.¹⁴ A few patents have appeared on special base compositions¹⁵ such as cellulose sulfate and carboxylate.

Improvements in methods of increasing the sensitiveness of photographic emulsions have been protected by patents, particularly the addition of certain substances to gelatin,¹⁶ or bathing the emulsioned material or treating the emulsion before coating in a solution of a double salt of silver and an alkali with boron in the negative radical.¹⁷

B. Studio and Location.

The nearness of New York to the center of sound equipment manufacture and stage talent has caused a revival of work in the studios located in the vicinity.¹⁸ Several new studios have been built and all of these are reported to be in operation. The production increase in New York has not affected Hollywood apparently because in that city additional sound stages have been built¹⁹ and other silent ones remodeled. There has been considerable emigration of acting talent to Hollywood and it is reported that voice teachers have been busily engaged assisting the "silent" actors to acquire voices.

Most of the sound pictures produced abroad have thus far been "shorts" and news weeklies. British International Pictures in England and Ufa in Germany have completed sound stages and pro-

duction is in progress. Patent difficulties have held up construction plans generally in Europe but these are reported to have been cleared up recently. Descriptions of several sound studios have been published.²⁰

In filming *Trader Horn* in the Belgian Congo, complete sound recording equipment and laboratory processing apparatus were used so that each day's negatives could be processed and inspected before changing to a new location.^{20a}

Lenses and Shutters.—Lee²¹ has reviewed the functions of modern high aperture lenses and predicts that progress may be looked for in improved color correction for use with panchromatic films. A new lens of $f/1.5$ aperture has been described adaptable to most modern professional and amateur cine cameras.²² This aperture is claimed by Sonnefeld²³ to represent very nearly the limit of wide aperture lens design. A novel lens for multi-image photography contains several reflecting prisms between the front and back components.²⁴ Gifford²⁵ has given details for constructing rapid rectilinear lenses of fluorite and quartz and of calcite and quartz for ultra-violet photography. . . A lens for use in a non-intermittent motion picture camera has been patented.²⁶

Patents on shutters for cine cameras are related to shutters adaptable for either cameras or projectors, regulators for controlling rotational speed of the shutter with changes in cranking speed, shutter blades designed as spherical sections, *etc.*²⁷

Cameras and Accessories.—Descriptions of new cameras or reconstructed cameras are somewhat meager although several of these are known to be in daily use in connection with sound recording, natural color photography, and the four types of wide pictures mentioned previously in this report. Useful data by Reinecke²⁸ on the theory of movement in relation to cine apparatus should prove of assistance to designers of cameras and other equipment. Effective illumination in making good lap dissolves has been discussed by Köfinger.²⁹ Brackets attached to the tripod top have been described for holding the camera view finder away from the camera and allowing the director to view the action conveniently.³⁰ At the last meeting of the Society, Struss³¹ described the method of arranging a battery of several cameras for simultaneous photography of action in dialog pictures. Six cameras were used in one scene in photographing *Coquette*, and about 1000 feet of film were used in each camera. It was possible to complete the scene "shooting" in two days originally scheduled for five days.

A small combined camera and projector exposes pictures on one-half of one side of a film, then reverses and exposes the other half. The pictures may be projected either on a screen or in a small album-like box in daylight.³² A compact, quickly adjustable tripod with an extension from 85 cm. to 170 cm. has been marketed by the Askania-Werke in Berlin.³³ This same firm has produced a tripod head by which the camera may be moved through a 180 degrees vertical tilt, slid forward or backward and rotated for panoraming.³⁴

The Mitchell camera has been equipped interchangeably for variable area or variable density sound recording.³⁵ Stull³⁶ has described several of the sound proof housings devised by various cameramen and technical staffs to avoid the use of large sound booths. These new housings are known by rather picturesque names such as "Bungalow," "Blimp," "Baby Booth," etc.

Patents³⁷ have been granted on a large number of improvements in camera design relating to pressure plates, friction clutches, magazine holders, cameras for making stereoscopic pairs of images, etc.

A camera and projector having optically compensating movements of comparatively simple design have been described by Hatschek.³⁸

Time-Lapse and Ultra-Speed Cameras.—A historical review³⁹ of the various types of rapid cameras has been published and it is claimed with one type that exposures up to 100,000 per second are possible for certain subjects. Thun's ultra-rapid camera employs continuously moving film and a rotating lens wheel and is capable of 4000 pictures per second.⁴⁰ Another camera invented by Craz of Berlin will take 5000 pictures per second.⁴¹ Beck⁴² has described a time-lapse camera which may be set for automatic exposures at intervals of from 15 seconds to 10 minutes. Patent protection has been granted on an automatic electrical device for actuating motion picture cameras which operate at timed intervals.⁴³

Studio Light Sources.—Incandescent lighting continues to be employed extensively in the production of many sound pictures, although arc lighting has by no means been discontinued as Sebring has shown in a recent article.⁴⁴ The problem with arcs has been to reduce motor noises and this has been accomplished by using choke coils and toggle switches to cut out the motors during actual shooting. The use of tungsten powder inside lamp bulbs is claimed to increase their life about 30 per cent as the efficiency may be kept at a maximum during an entire run.⁴⁵ Lamp manufacturers continue to improve

the efficiency of the higher wattage lamps,⁴⁶ as well as that of the smaller lamps used in conjunction with sound recording and reproducing equipment. Several new models of Klieglights designed for sound recording work have been described.^{46a}

Silvered glass has been shown to be superior to aluminum as a reflector.⁴⁷ A large spotlight of German design contains three rows of reflectors around the side and to the front of the housing which reflect the light to a series of mirrors set at slight angles immediately behind the source.⁴⁸ Light which would otherwise be lost is thus used to increase the brightness of the spot.

In photographing the color sequences of *Rio Rita* 386 lamps were required having a total wattage of nearly a million.⁴⁹ For the picture, *Sally*, it is reported that over 5 million watts were required and for *Broadway*, nearly 4 million watts.

Incandescent illumination is being used rather extensively in Europe. Lighting methods in the English studios are reported to be very similar to those used in this country except that there is a marked tendency to avoid strong highlights and backlighting. French studios are making tests on the use of incandescent lighting but are hampered by lack of the best lighting equipment. German studios are reported to be using incandescent lamps to a considerable extent. Data have been published on several new types of incandescent lamps developed in Germany,⁵⁰ including semiportable lamps rated as high as 5000 watts using either faceted or polished parabolic reflectors.

Make-up.—Actors have found an orange make-up without eye-shading most successful for use in an all-color motion picture.⁵¹ Two leading professional actresses have described their methods for using make-up in some detail for the benefit of cine amateurs.⁵²

Exposure Meters.—Naumann⁵³ has described a photo-electric cell which has been mounted in a housing on a motion picture camera so that an image of the object may fall on the cell, and an illumination reading be taken on a meter. Neutral gray filters are finding considerable use on cameras to enable a full aperture to be used in order to secure preferential focusing.⁵⁴ Patent protection has been given on an exposure meter of the fade-out type wherewith the shutter is automatically set when the indicator on the meter is just discernible.⁵⁵

Trick Work and Special Process Photography.—Dunning⁵⁶ has pointed out that the original patents will shortly expire controlling trick printing and composite negative making and that future inventors can therefore claim only improvements on basic principles.

The largest stage entirely devoted to special process work is in a studio at Burbank, California, where a room 150 by 300 feet was used recently.⁵⁷ In the sound picture, *Masquerade*, an actor played a dual roll and double printing on the sound track was accomplished successfully.⁵⁸ Methods of making "matte shots" have been described by Sersen.⁵⁹ These consist in double printing a painted section of a scene onto photographed action. Several improvements in special process photography⁶⁰ have been patented one of which utilizes lenticulated film for making stereo and trick pictures and another employs variously colored backgrounds and lights to secure composite effects.

Direction Technic.—A great deal more care in rehearsal has been found necessary in directing talking pictures as retakes are expensive.⁶¹ Absolute silence is imperative whereas with silent pictures, a working studio was usually a very noisy place. In a recent sound picture, *Lummo*, one set of a concert hall took up the entire space in the largest sound studio (225 feet long by 132 feet wide by 73 feet high). The action was directed entirely from a glass enclosed cupola that surveyed the whole scene, connection being made by telephone with cameramen, directorial assistants, and sound engineers. Playbacks enabled the orchestra and the players to hear at any time the record of the previous action.⁶²

A director at the Paramount Studios in New York used a traveling camera in photographing over 85 per cent of a recent sound picture.⁶³ Every scene was rehearsed with such great care that no cutting of the negative was required.

Sound Recording.—Public interest in sound pictures has speeded up the activities of producers and extensive programs have been announced this past summer with production schedules well under way. Recent mergers between large producers may help to centralize the production activities and insure better distribution. New recording units are being installed almost monthly and sound studios have been constructed in Hollywood and New York in the United States, Elstree in England, Berlin in Germany, and plans are in progress in France, Belgium, Russia, and other countries. In England, it is reported that more capital has been made available than ever before with a resulting increase in facilities for making British pictures. In Germany, 75 sound films composed chiefly of "shorts"⁶⁴ were produced between July, 1928, and July, 1929.

Physioc⁶⁵ has analyzed some of the problems in sound picture pro-

duction and believes that acting will show improvement under the supervision of sound recording.

The Gaumont method of sound recording using a sound record which is transparent to visible light but absorbs the ultra-violet, as mentioned in the last report, has been described more completely and protected by an additional patent.⁶⁶

Schinzel⁶⁷ has reviewed various methods of producing sound records on films which transmit visible radiation but absorb ultra-violet.

Another variable area method of sound recording has been described by Miller.⁶⁸ It is known as the Vitavox which utilizes a light valve, an image of which is focussed directly on the film. The methods of recording used by Tobis (Ton Bild Syndicate) have been dealt with by Bohm.⁶⁹ The position of the sound record which was originally outside the perforation area has been changed to make it conform with common practice. The Selenophon is still another variable area method of sound recording which appears to have promise. Hatschek⁷⁰ states that a torsion galvanometer is used, the image of an illuminated slit on the vibrating band being magnified 100 times for recording on the film. For reproduction a "condenser-less" type of selenium cell is used. The lag of the cell is stated to be compensated for largely by the suitable use of amplifiers.

The technic of electromagnetic recording has been studied by a German pioneer in this field, Curt Stille,⁷¹ who claims that besides having most of the advantages of optical recording the method avoids all difficulties inherent to film such as resolving power, development troubles, and printing errors. Play-back can be made immediately and the record is not subject to scratches. Records 15 years old were found to be as good as when first made.

The British Acoustic film system utilizes separate films for the picture and the sound record which latter is of the saw-tooth type.⁷² A selenium cell is employed in the reproducer, the lag being offset by using a filter circuit which attenuates the lower frequencies in correct proportion.

There has been further progress in voice doubling so that it can on occasion be done to a very high grade of perfection, but a public reaction against it has developed in those cases where it has become known. The practice is, therefore, being very rapidly discontinued.

At the same time, a somewhat related method is very promising which involves recording the sound and scene with the same actors, but at different times. This method is not open to the objection

previously mentioned, but does make it possible to do the recording in acoustically proper rooms without confusion of lights and camera, and in the photography makes it possible to proceed in the usual way as regards lights, angles, cameras, spoken instructions from director, *etc.* The method in brief, is to do the sound recording first and then to do the photography interlocking the cameras with the play-back device. There promises to be an expanding use of this method particularly in musical numbers.

In the more usual methods of sound recording, advances have been made in obtaining acoustical perspective exactly analogous to methods of lighting which avoid flatness and suggest visual perspective. The methods which give this desirable result, also give some simplification in the necessary mixer control (only one microphone is considered necessary in a set as large as 15 feet by 30 feet) and allow the set designers to use a greater range of materials since it is no longer necessary to make all sets of sound absorbing materials.

Hemardinger⁷³ has treated the subject of manufacturing and registering of phonograph disks. Improvements in methods of rotating the wax disks have been effected according to Elmer.⁷⁴

Hatschek⁷⁵ has discussed the characteristics of photo-electric cells and with Lihotzky⁷⁶ has treated the subject of the optics of sound film processes.

Theory underlying the physical basis of sound films has been treated in a series of papers by Klages⁷⁷ and others, covering such subjects as electrons and their properties, the action of electrons in a high vacuum, *etc.*

A review of the acoustical problems in conjunction with sound recording and reproduction has been made by Hatschek.⁷⁸ Paris⁷⁹ has deduced a formula for calculating the reverberation coefficient of absorption of a material if the coefficient of plane waves is known for all angles between 0 and 90 degrees. In general, the reverberation coefficient differs from the coefficient at normal incidence. Data of this nature are valuable in determining the construction materials for "live" sets according to Maxfield,⁸⁰ thus giving the actors greater freedom of action.

A ten weeks' course giving instructions on sound, the theory of sound recording and reproduction with explanations of recent developments is being offered this fall to 250 students by the Academy of Motion Picture Arts and Sciences.⁸¹

Humphrey⁸² treated the subject of sound studio recording installa-

tions at the last meeting of the Society, discussing not only the arrangements of stages, monitor rooms, cutting and review rooms, but also the construction materials for foundations and walls. Re-recording has been done successfully up to ten times according to Morgan⁸³ who described the method at the May 1929 meeting of the Society.

There have been a considerable number of patents taken out in relation to methods of sound recording which describe⁸⁴ among others a method of recording on a plastic surface by the use of X-rays; a means of distorting the vibrations of large amplitude during recording and correcting the distortion when reproducing the sound; a process for impressing a high-speed sound record consisting of two parallel records on a film by moving the film in one direction and simultaneously moving sound recorders in the opposite direction, permitting but one recorder to function at a time; a method of binaural recording and reproducing, comprising a plurality of superimposed films each of which has a distinct sound record thereon and is of different color, red and blue.

Actors, Scenarios, Sets.—Problems in connection with scenario writing for dialog films have been treated briefly by Jackson.⁸⁵

It is reported that the Paramount Hollywood studios have found a mono-rail system advantageous to facilitate the rapid transportation of sets from place to place within the buildings. A turret 14 feet high mounted on a 6 wheeled truck was used in several recent pictures to pivot a steel girder 31 feet long. At the end of the girder was mounted a platform for the camera and cameraman. This equipment permitted rapid movement of the camera for photography from several angles.⁸⁶

Bangs⁸⁷ has dealt with methods of estimating the cost of a production based on story and scenario; location expenses, unit personnel, laboratory, studio, and overhead. Problems confronting the location manager are reviewed by Witham.⁸⁸ Detailed descriptions have been published of nearly all of the British motion picture studios.⁸⁹

C. *Laboratory Practice.*

A special laboratory building to be devoted entirely to problems in connection with sound pictures has been built by the Bell Telephone Company in New York City.⁹⁰ The Kodak Company has opened a laboratory in Hollywood which contains developing and printing

rooms as well as a library and a completely equipped little theater and projection room.⁹¹

Equipment.—A general article has been written on the design of automatic processing machines with suggestions on their use.⁹² A compact tube developing machine known as the "Rovo" has been marketed.⁹³

Photographic Chemicals and Solutions.—Methods of obtaining fine grain images have been reviewed⁹⁴ and developers described that give images finer than can be obtained with the Kodak borax developer but all formulas are open to the objection that the development time required is excessively long (45 minutes to one hour). Abnormal graininess may occasionally be due to atmospheric conditions rather than to the solution used according to Barsity⁹⁵ who also describes tests on several developers and strongly recommends the Kodak borax formula.

Two reports were presented before the Society at the last meeting on further studies on the borax developer, one by Moyse and White⁹⁶ and another by Carlton and Crabtree.⁹⁷ The former recommend a new formula with the hydroquinone omitted as giving satisfactory results with negative film. The latter find the present formula satisfactory for general negative development and specify methods of revival of the solution to keep the working capacity at a maximum throughout the useful life. A considerable portion of the paper is devoted to a study of methods of improving graininess of images produced by this developer as well as ways of varying the rate of development of the solution.

A series of comprehensive papers are being published by Chibisoff and his collaborators⁹⁸ reviewing and correlating the available data on the chemistry of developers and development. As a result of an investigation on the fogging properties of developers stored in contact with various metals and alloys, Ross and Crabtree⁹⁹ conclude that zinc, copper, and tin tend to give trouble from aerial fog or produce chemical fogging effects. In a developer containing bisulfite, zinc forms sodium hydrosulfite which is a strong fogging agent.

An informative study of the properties of fixing baths was described by Crabtree and Hartt¹⁰⁰ at the May, 1929, meeting of the Society. Criteria for comparing various fixing baths are established and data are presented for compounding solutions having specific properties. The formation of a precipitate on the addition of potassium iodide solution to a fixing bath has been suggested by Gar-

riga¹⁰¹ as a test to determine the exhaustion point of the bath. Clerc¹⁰² has shown that unless fixation is prolonged for an abnormally long time at normal temperatures, the usual solution will not materially reduce the image density.

I. G. Farbenindustrie Akt.-Ges. have patented the use of a 1.3 or 2.4 or 2.6 diaminophenylazonium silver compound as a desensitizer either as a preliminary bath or in the developer solution.¹⁰³ A modification of the usual development treatment of films containing diazo compounds consists in adding only the diazo compound to the film coating and using a developer containing an azo coupling agent and a weak alkali.¹⁰⁴

Printing Machines and Methods.—A printer for simultaneous printing of sound and picture negatives was described by Depue¹⁰⁵ at the spring meeting in 1929. This development is an indication of the problems which have been introduced by sound-on-film pictures as greater care is required in printing than heretofore. A photo-electric exposure meter has been designed for use with printers.¹⁰⁶ An idea of the capacity of the large printing laboratories can be had from a recent report that a Hollywood laboratory is now equipped to process 2700 feet of negative film and 11,000 feet of positive film per hour and to handle sound film in 1000 foot rolls.¹⁰⁷ A number of patents¹⁰⁸ on printer improvements have been taken out. Some of the more novel patents may be mentioned: (a) the use of ultra-violet light for printing; (b) deflection of the light beam in a printer by the use of a rotating magnetic field; (c) multiple printing devices; and (d) an apparatus for determining the contrast and density of a photographic image.

A table for use in making animated drawings has been described by Adam¹⁰⁹ which incorporates an automatic focussing device similar to that described by Norling before the Society a year ago.

Editing and Splicing.—Loeffler¹¹⁰ has described the problems encountered in editing variable density sound films and states that with experience certain noises can be identified visually and the synchronization tested by counting the intervening frames. An ingenious device for rewinding is a spool with a collapsible center which allows the sides to collapse and free the film.¹¹¹ Patent protection has been granted on a film winding apparatus which draws the film from the inside of a roll.¹¹² Another device for holding endless bands of film has been patented by Harzer.¹¹³ A shrinkage measuring device mentioned in the previous report has been protected by a U. S. Patent.¹¹⁴

Titles.—No outstanding articles on titling have appeared but two patents are of interest. The first comprises a device for forming a title on greased paper and exposing the film through the paper.¹¹⁵ The second describes a projection printer having a rotating table for holding the titles interposed between the light source and the film.¹¹⁶

After-Treatment, Cleaning, Reclaiming, and Storage.—Jasienski¹¹⁷ has studied the effect of various intensifiers on the graininess of the image and found that chlorochromic acid and a commercial product called Nosublim gave least increase in graininess.

A finishing laboratory has developed a process for increasing the life of positive prints.¹¹⁸ It consists in treating the emulsion side with a chemical compound immediately after processing which protects the film from scratches, oil, and dust. A cleaning device marketed under the trade name, "Imp-Impregnator" cleans, "impregnates," and dries the film at the rate of 6000 feet an hour.¹¹⁹

A novel device announced recently is a film inspection machine which is constructed without sprockets and, as the film is rewound, the machine detects any breaks, tears, or defective splices.¹²⁰ A film clip which can be slipped on a roll of film without scratching it has been invented to replace the commonly used rubber band.¹²¹

A few patents have appeared on processes of lubricating and conditioning motion picture film.¹²²

II. DISTRIBUTION

The introduction of sound pictures particularly those having the sound on disks has increased the problem of the distributors. The sensitiveness of the sound records and the extraneous noise resulting from careless handling make the problem of inspection in film exchanges more difficult. Footage numbers have been found of great value in connection with the inspection of sound film.¹²³

III. EXHIBITION

A. General Projection Equipment.

Projectors and Projection.—Comparatively few changes have been noted recently in projectors equipped for ordinary motion pictures but many improvements have appeared in connection with projectors for sound films and the newer wide films.

A projector of Italian manufacture has, as a novel feature, an automatically adjusted shutter which permits as few as 14 pictures

to be projected per second without flicker.¹²⁴ A German projector is equipped with spools containing loose centers automatically regulating the film tension, also a shutter which rotates in a ball shaped housing between the lamp and the gate.¹²⁵

As a change-over signal it has been suggested that a spring hinged arm be folded over the first few convolutions of the film during re-winding. When the arm is released during projection, it closes the circuit of an electric bell.¹²⁶ Another device makes the change-over automatically and also stops the projector and cuts off the light in case of a break.¹²⁷

Types of projectors have been classified into three groups by a committee appointed by the German government. The classes are (1) dangerous and for use in booths only, (2) dangerous only in unusual circumstances, and (3) safe.¹²⁸ An advisory council has been established recently which is working in conjunction with the American Projection Society, studying projection conditions in theaters.¹²⁹

Patents related to projectors deal with a great many devices such as pull-down mechanisms, electromagnetically operated clutches, air-cooled lamphouses, etc.¹³⁰

Errors in architectural design affecting location of the projection booth are cited to show that greater care should be given by architects in the location and design of this important element in a motion picture theater.¹³¹

Fire Protection.—Lehmann has written a general article dealing with motion picture film and projectors with relation to fire hazards and predicts that nitrate film will continue in use for some time to come.¹³² Detailed specifications of construction materials for projection rooms in Germany have been published.¹³³ Joachim¹³⁴ has published a comprehensive article dealing with shutter design, fire hazards in projection booths, and other related subjects. A number of patents deal with various improvements in methods of stopping the projector mechanism in case of fire, closing port holes, the use of heat resisting screens in the path of the light, etc.¹³⁵

Projector Lenses, Shutters, and Light Sources.—Patents on optical projection systems¹³⁶ disclose methods of obtaining maximum illumination with concentrated filament lamps, and a means for projecting a small beam of light upon a douser shutter to permit the projectionist to determine previous to projection the alignment and focus for homogeneous screen illumination.

Patzelt¹³⁷ has discussed the theory and practice of projection light sources, particularly mirror arcs.

B. *Special Projection Equipment.*

Sound Picture Projection.—The industry is rapidly adapting itself to sound film projection and it is predicted that over 9000 houses will be equipped for handling one or more types of sound films by January, 1930, about 5200 theaters having been equipped by the middle of August.¹³⁸

For the projection of Fox Grandeur Pictures at the Gaiety Theater which opened during September, 1929, a new projector was used built especially to accommodate the 70 mm. film. It incorporated a high intensity arc consuming 150 amperes for a 70 foot throw onto the 17 foot by 35 foot screen. Special lenses were necessary to accommodate the large screen and a new type of carbon arc was used which will take an amperage as high as 250, considered to be necessary for larger houses.¹³⁹

Sound pictures (all "talkies") had their first showing in several European countries in August and were enthusiastically received although many pictures had to be shown only with English dialog. The first Russian made sound film was ready for showing the latter part of August on Russian reproducing equipment, import of foreign equipment being prohibited. Reviews of the first all British "talkie," *Blackmail*, made at Elstree are favorable. It is predicted that over 500 British houses will be wired for sound pictures by January, 1930.¹⁴⁰

Interchangeability is a feature of several new projectors equipped for sound projection. One projector is designed in three models, sound-on-film, sound-on-disks, or both and if one of the first two types are purchased, the other may be added later.¹⁴¹ Several firms are manufacturing sound equipment for attachment to standard projectors. Features of the Royal Amplitone are a high pedestal for the disk assembly permitting easier handling of this type of equipment, freedom from turn-table flutter, and a locked optical device for the sound-on-film assembly.¹⁴² A curved sound gate is used by Tobis Klangfilm to prevent film buckling.¹⁴³

New apparatus for playing disk records continues to be announced. The Filmophone¹⁴⁴ is stated to permit interruption of the sound at any predetermined point and the Electrocord¹⁴⁵ consists merely of a well balanced turn-table for use in small halls. RCA Photophone has

announced a dual system unit selling at \$3000.00 for use in theaters seating 500 or less.¹⁴⁶

A California exhibitor has installed a few sets of ear phones in his theater for the use of deaf patrons; each set being adjustable for volume by means of a small choke coil.¹⁴⁷ Descriptions have been published of several types of amplifiers.¹⁴⁸ A small vacuum cleaner device is available for removing dust accumulation in delicate electrical parts of sound apparatus.¹⁴⁹

A reproducer employing the condenser principle has been described.¹⁵⁰ It consists of a slotted aluminum grid which acts as one plate and a thin layer of gold or aluminum leaf glued to a rubber diaphragm serves as the other condenser plate. Several of these grids are attached to the rear of the projection screen. A hydraulic lift is now used for the stage mounting of loud speaker horns.¹⁵¹

A segmented cardboard disk has been announced which can be used to synchronize the picture with a disk record.¹⁵² Fader control from the auditorium is possible with an installation used by Metro-Goldwyn-Mayer for road shows in the larger neighborhood theaters.

A committee of technicians has undertaken an investigation to draw up a set of standards for camera and projector apertures according to a report from the Academy.¹⁵³ A preliminary survey indicates that the majority of theaters showing sound-on-film pictures are using a screen picture that is nearly square. Sliding masks are sometimes used alone or in conjunction with a horizontally movable lens mount. Sometimes a lens of lower focal length is used and an undersized aperture plate thus restoring the 3 by 4 proportion but at a loss of some of the picture. A recent report^{153a} states that all the large producers on the Pacific coast have agreed to adopt at once the recommendations of the joint committee of this Society and the Academy of Motion Picture Arts and Sciences providing for the use of a standard aperture of one size in all cameras.

Numerous patents have been granted on improvements in sound projection apparatus and accessories.¹⁵⁴

Stereoscopic Motion Pictures.—Since the public showing of the Televue in New York City in 1922, there have been no further developments of commercial interest in stereoscopic pictures until the past summer when wide pictures were introduced. Both Fox Grandeur and the Spoor-Bergren systems are claimed to give the illusion of depth but those who have seen them state it is only a fair illusion. Special lens systems are used in the recording cameras.

A compressed air control is used in the Spoor-Bergren projector to hold the 56 mm. film flat.¹⁵⁵ Ritterath¹⁵⁶ is inclined to believe the secret of stereoscopic motion pictures lies in the use of a composite screen rather than special cameras or projectors. A relatively complicated method of stereo-motion pictures having severe practical limitations has been described in a paper by Ives¹⁵⁷ before the Optical Society of America. A few patents related to stereoscopic motion pictures have been granted.¹⁵⁸

Non-intermittent Projection.—Efforts continue to perfect non-intermittent projectors, most of the published results coming from Germany. The most successful of the commercial models, the Mechau projector has been further improved in Model 4, a description of which appeared in an issue of *Kinotechnik* early this year.¹⁵⁹ Burmester and Mechau¹⁶⁰ have prepared a very complete treatise on the mechanical and optical principles underlying this projector. Several German theaters are reported to be using them and an earlier model was installed for a short time at the Capitol Theater in New York a few years ago. Thun¹⁶¹ has published a paper on projection with optical compensation and Hatschek¹⁶² has described a non-intermittent projector of comparatively simple construction which utilizes a spiral concave mirror with an inner hollow face which rotates on a vertical axis once per picture. The first paper of a series written on various non-intermittent projector systems has appeared recently.¹⁶³ It describes the projector invented by Nilson in which one pair of oscillating mirrors are used to project the image in place of the usual large number of mirrors and prisms. Several patents¹⁶⁴ have been taken out on optically compensated projectors which describe among others the use of a rotating disk (set at 45 degrees to the film plane) in the periphery of which mirrors are placed; the employment of a rotating polygon of refractors having plane parallel surfaces; and the use of mirrors carried by two rotors and arranged prismatically thereon, the number of mirrors being different on the two rotors.

Portable Projectors.—A sound-on-film portable projector has been marketed by Western Electric. A mechanical governor controls the continuous movement of the film past the photo-electric cell and sound lamp.¹⁶⁵ Various devices¹⁶⁶ have been patented for handling endless film bands in projectors, coin-in-slot operated projectors, and translucent screens. One patent describes a music roll on which are printed a series of pictures which show as motion pictures when the roll is rewound rapidly.¹⁶⁷

C. Miscellaneous.

Screens.—The porous nature of many materials used for “talkie” screen construction has resulted in a serious lowering of screen reflection values and is a regrettable feature of sound pictures.¹⁶⁸ One new sound screen uses staggered perforations and it is claimed that better picture definition is obtained accompanied by clear sound emission.¹⁶⁹ The use of grid condensers mounted directly on a screen, referred to previously,¹⁷⁰ makes available a sound motion picture screen which takes up little more space than a regular screen, overall thickness being about 16 inches.

Parallel steel bands, 7 mm. wide and 0.1 mm. thick are placed in front of a screen to permit daylight projection. To avoid a direct black border on a screen, Keith-Albee hang a black velour curtain 10 feet behind the screen (which is exactly picture size) and use a black ground cloth on the floor.¹⁷¹ Patents¹⁷² issued include the use of an endless luminescent moving band viewed as a screen, several types of translucent screen materials, and the use of tiny glass pyramids embedded in a lead paint base.

Theater Construction and Illumination.—The largest theater on the Pacific coast was opened June 28, 1929. It seats 5000 persons and is designed in French architecture. The projection throw is 212 feet.^{172a} Meshrabponi-Film and several other Russian organizations are building a “Swimming Theater” or showboat to seat 600 persons.¹⁷³ It will be equipped for showing pictures and will have a special landing stage to allow it to stop at any desired place. Sylvester¹⁷⁴ has discussed the essentials in floodlighting for theater stages and points out that prismatic lenses in front of the projector are used to control beam spread instead of reflector contours. The improved Clavilux invented by Wilfred, known as a Luminar has been installed in the Paramount Theater. It is described and illustrated quite fully in an article by Fox.¹⁷⁵ Applebee¹⁷⁶ has written on modern stage lighting. Henly¹⁷⁷ has written several articles on heating and ventilating the theater. He describes panel systems of heating whereby ceilings, walls, and floors are heated by means of jointless steel coils embedded in the structure. His paper deals also with various methods of filtering the air. A marked reduction in reverberation and echo in public halls is claimed by Berliner to be obtained when the side walls are covered with wire cloth cement covered diaphragms.¹⁷⁸ An audience filling one-quarter of the floor space is sufficient to prevent disturbances from the floor.

IV. APPLICATIONS OF MOTION PICTURES

A. *Education.*

Further details on the experiment in the use of specially prepared classroom films were presented to the Society by Finegan last spring at the New York meeting.¹⁷⁹ The Mountain States Telephone and Telegraph Company is using a portable sound motion picture unit for educational instruction of their personnel.¹⁸⁰ Talking films are expected to be particularly valuable in vocational guidance courses according to Kitson who discussed their application at a symposium held at Columbia University in July, 1929.¹⁸¹

Motion pictures of the moon have been made at the Princeton University using a lens 24 inches in diameter.¹⁸² The picture shows the sunrise on the Copernic Cirque at a speed one hundred times faster than normal, the pictures having been taken at the rate of 10 frames per minute.

Although sound pictures offer an inviting medium for promotion of business sales and for aiding industrial relations, the present cost of installation of the equipment prevents their extensive use. As time advances, industrial firms, large hotels, and educational institutions will no doubt install apparatus and the problem will be simplified.

A British Grammar School has used motion picture films for three years for instructional purposes and they are considered a useful adjunct, especially in connection with a technical education. Only two British firms make films for teaching purposes and reliance had to be placed on private enterprises for the source of most film material. No assistance is given by the Board of Education.¹⁸³

The University of Southern California and the Academy of Motion Picture Arts and Sciences have amplified their plans for courses related to motion picture technic and are offering work in several subjects for the year 1929-30.¹⁸⁴

The first issue of the *International Review of Educational Cinematography* appeared in July, 1929. This is a monthly publication of the International Educational Cinematographic Institute of the League of Nations. Each month's issue is in five editions, English, French, Italian, German, and Spanish.

A ballet master utilizes motion pictures for teaching intricate steps and for preservation of the technic of his more famous students.¹⁸⁵ Thun¹⁸⁶ has dealt with the accuracy with which the construction and

operation of a machine can be shown by appropriate motion pictures and the ease with which such information can be imparted to a large number of people. Various types of electric furnaces have been filmed in action and their working principles illustrated with the aid of animated diagrams.¹⁸⁷

Motion pictures are projected in an underground amphitheater 500 feet below the surface of a Missouri mine.¹⁸⁸ During the latter part of 1928, aviation comprised more than 16 per cent of newsreel views and the popularity and interest in aviation has been aided materially by the motion picture.¹⁸⁹ A motion picture, *The Rise of Woman*, has been produced by the New York State Federation of Women's Clubs and the Motion Picture Producers and Distributors of America.¹⁹⁰

Fokert¹⁹¹ has reported on film and art in Russia. There is a museum and research department for motion pictures in Moscow. State cinema schools have been organized and there are two high schools of cinematography for directors, actors, etc.

B. *Medical Films, Radiography, and Photomicrography.*

Stutzin¹⁹² has described the use of a lamp and optical system called the *Cystoskop* for photographing internal body cavities, such as the bladder. Cine-photomicrographic studies of the human capillaries have been made by Hauser.¹⁹³

Gottheiner and Jacobsohn¹⁹⁴ have described their methods of making X-ray motion pictures. They used an indirect method whereby an X-ray image on a fluorescent screen was photographed on hypersensitized film using a lens aperture of $f/1.4$ and a camera having a 300 degree sector opening.

Cine-photomicrographs of cell stresses during the seasoning of wood have been produced at the U. S. Forest Products Laboratory in Madison, Wisconsin.¹⁹⁵ An oral description of the activity on a microscopic slide has been made on wax disks to accompany a motion picture, a beam splitter being employed to permit viewing during the camera exposure.¹⁹⁶ The Leica camera has been equipped with a micro-objective thus permitting photomicrography with comparatively simple equipment.¹⁹⁷

C. *Telephotography and Television.*

Work is in progress in several laboratories throughout the world on problems of telephotography and television but no developments of

commercial interest have occurred recently. Friedel has described Von Mihaly's system in some detail and it is claimed that synchronization has been simplified further.¹⁹⁸

Public demonstrations of television have been made in South Africa by the Baird Television Development, Ltd. The apparatus used is similar to that recently placed in operation in Germany with which sound and vision are broadcast simultaneously on two wavelengths.¹⁹⁹ The Australian Broadcasting Company expected to commence broadcasting pictures from station 2FC in Sydney by the latter part of August, 1929, using the Fultograph process.²⁰⁰

In a television long distance test, the voice and face of D. W. Griffith were transmitted from Schenectady, N. Y. to Los Angeles, Calif.²⁰¹ The voice of Gloria Swanson was recorded on an RCA Photophone equipment after having been broadcast by short wave over 3000 miles from London to New York.^{201a}

A Luxemburg scientist living near Paris has recently completed an intricate, but apparently practical, device for the transmission of moving pictures by wireless.²⁰² Kuchenmeister²⁰³ has patented the use of the discharge from a crystal oscillator as a light source in a television apparatus.

D. General Recording.

Time-lapse cameras have been used by the U. S. Coast Survey for recording readings on a number of instruments measuring the velocity of water currents in Chesapeake Bay.²⁰⁴ Mather has produced a series of geology films for use at Harvard University.²⁰⁵ The U. S. Department of Agriculture has made a film study of an abandoned concrete bridge until cracks formed.²⁰⁶

A high speed camera capable of making 8000 to 16,000 pictures per second has been described by Beck.²⁰⁷ The film is wrapped around the periphery of a motor driven drum and is exposed with the aid of a lens and 45 degree mirror. It is recommended for studying the movement of electric discharges. The same author has described a camera for photographing the interior of tubes, rifle barrels, and similar surfaces, a linear record being obtained.²⁰⁸ The use of the motion picture camera for studying the duration and brightness of ignited flash powders is discussed by Maiser and Umbehr.²⁰⁹ Electric welding has also been studied by means of a cine camera designed to make four narrow pictures across each average frame of 35 mm. film.²¹⁰ The Imperial College of Science (London) is making a

photographic study of gaseous explosions, using an ultra-rapid chronophotographic apparatus which exposes 200 meters of film per second.²¹¹

A camera equipped with a lens which refracts the light rays into a cone of about 90 degrees has been devised for taking pictures of lightning. A wide angle lens system is placed behind the front or "fish eye" lens to project the rays on the film.²¹²

V. COLOR CINEMATOGRAPHY

The most extensive production program of color motion pictures during the history of cinematography was launched during the summer of 1929. The bulk of the pictures made thus far and planned for are by the Technicolor process and most of them are to be all-sound pictures. Expansion plans are announced by this company which will give them eight times their present capacity early next year.²¹³ Two producing units are to be built in New York and their Boston and Hollywood laboratories are to be expanded so the former will be fitted with five units and the latter with three units. The announcement also states that the present two-color subtractive process is to be displaced by a three-color process of similar basic principles. It is reported that Technicolor has developed a method whereby the sound track can be a black and white silver image whereas the picture area is composed of dyes.

Brown²¹⁴ has described some of the problems encountered in making the all-color (Technicolor), all-sound picture, *Under a Texas Moon* during the summer of 1929. The difficulty of making exterior shots by a two-color process is well known and great care was used in choosing the location so that the rock formations and vegetation would be of suitable color for good reproduction. To overcome the color changes resulting from light variations, portable incandescent lamps were used. These were focussed on cloth reflectors to minimize the heat. Special booths had to be utilized for the color cameras as they make more noise than black and white cameras.

Tietze²¹⁵ has written on the use of the Busch two-color additive process for photographing surgical operations. This process uses a twin lens camera and projector with filters over the lenses. The two images of the positive are superposed on the screen. Patents²¹⁶ dealing with three-color additive processes are related to the preparation and use of various types of multi-color screens, a three filament lamp with a condensing system, and a method of reducing the image size so that three pictures may occupy one frame.

No further commercial developments have been noted in the use of lenticulated films for theater use but numerous patents have been taken out protecting various improvements in their preparation and use.²¹⁷ Several of these patents are concerned with methods of printing lenticulated films.

Thornton²¹⁸ has protected the use of double width film for a two-color process carrying line or dot screens side by side with a panchromatic emulsion coated on the screens.

The two-color subtractive process known as "Multicolor" has been described by Crespinnell.²¹⁹ Two negatives with emulsion surfaces adjacent are run through a standard camera at one time, the front negative is orthochromatic with the surface layer dyed orange-red to act as a filter for the image recorded on the rear panchromatic emulsion. Double coated yellow dyed film is used for printing the pair of images in register on opposite sides of the film. The images are colored by a combined dye toning and chemical toning method, and are varnished before projection to protect them from scratching.

The Zoetrochrom process demonstrated in London during the spring of 1929 is a three-color subtractive process with a fourth or key image in black and white included. In taking the picture, every alternate frame on the film is exposed as usual for ordinary cinematography and the remaining frames are filled with three reduced images taken through filters cutting out the red, blue, and green, respectively. The standard size image is printed first, then each of the others, by varnishing, recoating with emulsion, enlarging the image, developing, and dye toning in succession.²²⁰

In another process known as Splendicolor²²¹ being exploited in England, three negatives bearing the respective color corrected monochromatic images are printed onto a positive film carrying a gelatin-bromide layer on one side and a coating of pure gelatin on the other. The blue image is printed on the silver emulsion and the yellow and red are formed by the Pinatype process in bichromated gelatin on the opposite side of the film.

A great many patents have been taken out on improvements in subtractive color processes.²²²

VI. AMATEUR CINEMATOGRAPHY

A. *General Equipment and Uses.*

A useful illustrated description has been published of nearly every

available type of camera, projector, and accessory recommended for amateur use with 9.5 mm., 16 mm., and 35 mm. films.²²³

Amateur Cameras.—Interest in amateur movies continues to grow as improved equipment and film become available. The large list of finishing stations for regular and Kodacolor films recently published by the Kodak Company reads like the itinerary of a round-the-world tour.²²⁴ This Company has announced a 50 foot spring driven two speed camera which may be obtained with either an $f/3.5$ or $f/1.9$ lens which are interchangeable with a long focus $f/4.5$ lens. The $f/1.9$ outfit may be equipped for Kodacolor.²²⁵ A British made amateur cine camera is fitted with an $f/2.6$ lens, a direct vision finder, and is designed to work at three speeds.²²⁶ An improved model of the Pathé "Baby-Cine" has been announced called the "Motocamera." The motor drive will run through an entire charge of film and the shutter and pull-down have been modified.²²⁷ Zeiss Ikon A.-G. has marketed a 16 mm. camera with an $f/2.7$ lens. Film is supplied in magazines holding 33 feet.²²⁸ A combined amateur camera and projector has been announced.²²⁹ For projection the back of the camera is removed and the mechanism mounted on a stand with a motor, illuminating system, and shafts for 120 meter reels. The shutter is rotated at double speed to avoid flicker during projection.

Zeiss has introduced a Biotar $f/1.4$ lens of 17 and 25 mm. focal length for use on amateur cine cameras.²³⁰ Announcement has been made of a 4 inch Tele-Xenar $f/3.8$ telephoto lens. It is an unsymmetrical half-cemented anastigmat lens of five elements.²³¹ Although not yet on the market, a lens of the extreme aperture of $f/0.99$ is reported to have been constructed for use on amateur standard cameras.²³²

A remote control for starting and stopping the Filmo 70 has been developed.²³³ McKay²³⁴ suggests that the camera for the advanced amateur should have a dissolving shutter, a method of rewinding the film in the camera, and a means for visual focusing. A few developments have been noted in the use of equipment for synchronizing sound with pictures for the amateur. McKay describes three ways of recording: (1) the use of wax disks with a portable phonograph, (2) the use of a microphone in conjunction with a loud speaker and a dictating machine, and (3) the second method with the addition of single switch control of the motors on the camera and dictating machine.²³⁵

Projectors.—The Victor 16 mm. projector claims as features a

straight line optical system, power rewind, and an automatic stop to prevent film breaks.²³⁶ An inexpensive hand cranked projector has been added to the equipment in the amateur cine field.²³⁷ A self-contained projecting unit in a walnut cabinet has been announced which uses a small translucent screen that is extended 2 feet in front of the projector.²³⁸ The Ensign Kinecam projector uses a 60 volt, 100 watt lamp with a variable resistance control.²³⁹ Bell & Howell have modified their Filmo projector to adapt it to classroom use.²⁴⁰

The supply and take-up reels on the new Zeiss-Ikon projector are located side by side on a common shaft under the gate and lens system. Film must be removed for rewinding.²⁴¹ A 100 watt lamp, operating from either 110 or 220 volt circuits is incorporated in the new Agfa projector for 16 mm. film. The lamp house is fan cooled.²⁴²

A device for reproducing sound, adaptable for home movies has been described briefly. Four variable area records are printed side by side on an opaque paper positive, 6 mm. wide. The sound is reproduced by suitable electrical sound reproducers connected to a loud speaker.²⁴³ A projector using 9.5 mm. film can be equipped with a speaker unit called the "Radioscope" synchronized with the picture.²⁴⁴ The unit can also be used to permit sound accompaniment of a master sound film from a central studio when a duplicate print is shown in the home.

An interesting historical description of an animated family album developed in 1902-3 was published recently in Germany.²⁴⁵ Five concentric rows of pictures on a disk were animated by rotating the disk and viewing the changing picture through a peep hole in a cover fitting over the box holding the disk.

Two patents have been granted on improvements in amateur projectors.²⁴⁶

Enlargements from 16 mm. pictures may be made up to $2\frac{1}{4}$ by $3\frac{1}{4}$ inches by using a cone like box which fits on a Filmo projector.²⁴⁷

A new 16 mm. reversal film has been placed on the market²⁴⁸ as well as an additional negative film.²⁴⁹ The leader on the former is green and the trailer red on the processed film for convenience of the projectionist.

Editing, Scenarios, Libraries.—Magnetized steel letters and a steel background have been announced as titling equipment for the cine amateur.²⁵⁰ For use with the Ensign Auto-Kinecam, a titling box is provided wherein the camera is pointed downward at a copyboard with movable letters fitted into the base.²⁵¹

Library prints on 16 mm. film are available of pictures made with Jenkins' speed camera which operate at 3200 pictures per second.²⁵² Bird studies have been made with an amateur camera which operates quietly enough so that the birds become accustomed to the motor noise.²⁵³ Motion pictures taken by an amateur of an auto accident were introduced as evidence in an Australian court at the request of the justice.²⁵⁴ A correspondence school in electricity is being taught wholly by the use of 16 mm. pictures.²⁵⁵

B. Color Processes.

A new projector for Kodacolor films has been issued by Bell & Howell.²⁵⁶ The lamp operates at 5 amperes and is fitted with a variable resistance. Two patents²⁵⁷ have appeared on the use of lenticulated films. One is related to the use of a five banded filter which comprises one green, two red, and two blue areas. The other patent covers the use of an optical system for lenticulated films which is designed for use with curved gates, compensating lenses usually required in projection being avoided.

A projector²⁵⁸ for projecting natural color pictures has been patented. The film passes between condensing and projecting lenses. A shutter and a rotatable color screen, (having several different color areas) are positioned between the film and the condensing lens.

VII. MISCELLANEOUS USES, STATISTICS, NEW BOOKS

A psychologist at Columbia University has reported on a two year investigation made on the influence of motion pictures on crime.²⁵⁹ The results indicated that most children remembered very little detail of the picture and were unsympathetic with the wrongdoers. Only 5.2 per cent of the 150,000 patrons were under 21 years old.

Over 250 million persons see motion pictures weekly throughout the world according to W. H. Hay's annual report.²⁶⁰ Over 23,000 controversies were arbitrated by film boards during 1928, only 28 claims requiring the services of a seventh arbitrator.

Export of positive and negative film from the United States fell off 10 million feet in 1928 when 222 million feet were shipped out compared to 232 million feet in 1927. Latin America continues to be the largest consumer; Europe is next.²⁶¹ A more recent report by Golden²⁶² indicates an increase in total film exports for the first six months of 1929 which is accounted for largely by the demand for positive prints in Europe. The totals are 121,810,453 linear feet for

1929 compared with 112,752,169 feet for 1928. Imports of raw film for the first six months of 1929 amounted to 251 million linear feet compared with 117 million linear feet during the same period of 1928. Imports of finished film ran about the same as in 1928, $1\frac{3}{4}$ million feet of negative and $2\frac{3}{4}$ million feet of positive films.

Nearly three thousand more American made projectors (both 35 mm. and 16 mm.) were exported in 1928 than in 1929.²⁶³ Six thousand were shipped out to 71 countries.

A comprehensive series of statistical data has been published giving information on most all phases of the motion picture industry.²⁶⁴ Some of the more outstanding items are as follows: News reel companies use about ten million feet of raw film annually, only five hundred thousand feet of which reaches the theaters. American films return about \$1.00 worth of extra trade to U. S. manufacturers for every foot exported. The exhibition branch of the motion picture industry uses nearly half of all the man power employed in motion pictures, or 110,000 of the 235,000 persons engaged in all branches. Production employs 75,000, distribution 20,000, other branches 30,000.

The world's 52,000 picture theaters have a combined seating capacity of 21,150,000 for the 1,793,000,000 people. Laboratories process 1,500,000,000 feet of film yearly. Amateur movie makers use upward of 20,000 miles of 16 mm. film yearly and have purchased more than 175,000 amateur cameras and projectors in the United States alone. Of the 11,000 extras registered at the Hollywood Central Casting office, only 4000 receive work regularly and less than 400 can speak in foreign tongues, or with foreign accent necessary for the foreign parts in talking pictures.

Sovkino now owns 10,000 square meters of space near Moscow and 1929 production schedules call for 86 long feature pictures.²⁶⁵ About 85,000 persons are engaged in film production. Building programs for 1932 call for the erection of 2000 new theaters and 8000 transportable projection outfits for use in villages. Neither cameras nor film were manufactured in Russia previous to September, 1928, but about 2000 stationary and 8000 portable projectors are made annually.²⁶⁶ Everyone of the 400 workers clubs in Moscow is stated to be equipped with projection facilities.²⁶⁷ Leningrad boasts a theater seating 3000 and plans are under way for the construction of several others of similar capacity. Theaters devoted to special presentation of scientific films are popular.

NEW BOOKS

1. *Practical Television*, by E. T. Larner, D. Van Nostrand Co., Inc., New York, N. Y. (1928).
2. *Ripening of Silver Bromide-Gelatin Emulsions with Ammonia and Ammonium Carbonate* (Reifung von Bromsilber-gelatin mit Ammoniak und Ammoniumkarbonat) Encyclopedia for Photography and Motion Pictures No. 113, O. Papesch, W. Knapp, Halle, Germany (1928).
3. *The Motion Picture Almanac*, Quigley Publishing Co., Chicago, Illinois (1929).
4. *Heracitus or The Future of Films*, by Ernest Belts, Dutton & Co., New York (1928).
5. *Sound Motion Pictures*, by H. B. Franklin, Doubleday, Doran & Co., Inc., New York (1929).
6. *Handbook of Projection, Vol. III*, by F. H. Richardson, Chalmers Publishing Co., New York (1929).
7. *Kinematograph Year Book*, Kinematograph Publications, Ltd., London, England (1929).
8. *Amateur Cinematography*, by Owen Wheeler, Pitman & Sons, Ltd., New York (1929).
9. *Small Film Cinematography* (Die Schmalfilm Kinematographie), by O. P. Herrnkind, Hartleben's Verlag., Leipzig (1929).
10. *Scenario Writing*, by Marion N. Gleason, American Photographic Publishing Co., Boston, Mass. (1929).
11. *Motion Pictures in the Classroom*, by B. D. Wood and F. N. Freeman, Houghton, Mifflin Co., New York (1929).
12. *Applied Aerial Photography*, by A. C. McKinley, Wiley & Sons, Inc., New York (1929).
13. *Proceedings of the Seventh International Congress of Photography*, edited by W. Clark, T. Slater Price, and B. V. Storr, Heffer & Sons, Ltd., London (1929).
14. *Photographic Sensitometry and Its Applications* (La Sensitometrie Photographique et ses Applications), by Geo. Moreau, Gauthier-Villars, Paris (1928).
15. *Manual of Sensitometry* (Manuel de Sensitometrie), by L. Lobel and M. Dubois, P. Montel, Paris.
16. *Photochemistry and Photographic Chemistry* (Photochemie und Photographische Chemie), by W. Noddack and E. Lehmann, Union Deutsche Verlags, Berlin.
17. *Handbook of Scientific and Applied Photography* (Handbuch der Wissenschaftliche und Angewandten Photographie), 9 Vols. (in progress), Springer, Berlin. *Color Photography* (Farbenphotographie), Vol. 8 has been published. Authors are L. Grebe, A. Hübl, E. J. Wall.

REFERENCES

- ¹ *Trans. Soc. Mot. Pict. Eng.*, XIII, No. 37 (1929), p. 199.
- ² *Ger. Pat.*, 469,415.
- ³ *Ex. Herald-World*, 94 (July 6, 1929), p. 130.
- ⁴ *Ex. Daily Review & Mot. Pict. Today*, 25 (June 1, 1929), p. 11.
- ⁵ *Ex. Herald-World*, 95 (July 27, 1929), p. 19.

⁶ *New York Times* (Sept. 22, 1929), p. X7; also *Film Daily*, 49 (Sept. 18, 1929), p. 1.

⁷ C. L. WILLIAMSON: *Internat. Phot.*, 1 (Aug., 1929), p. 4; also *Ex. Daily Review & Mot. Pict. Today*, 26 (Sept. 21, 1929), p. 3.

⁸ *Internat. Phot.*, 1 (Aug., 1929), p. 12.

^{8a} *Licht Bild Bühne*, 21 (Nov. 10, 1928), p. 22.

⁹ *Revue Scientifique*, 67, No. 10 (May 25, 1929), pp. 294-307.

¹⁰ *La Nature*, No. 2814 (Aug. 1, 1929), pp. 100-102.

¹¹ *Fr. Pat.* 645,357; *Brit. Pat.* 301,879.

¹² *Brit. Pats.* 301,878 and 302,961; *U. S. Pat.* 1,703,470; *Fr. Pat.* 645,358.

¹³ *U. S. Pats.* 1,697,907; 1,698,048; 1,699,049; 1,701,229; 1,704,282; 1,704,283; 1,704,304; 1,704,306; 1,711,110; 1,711,111; 1,711,314; 1,711,940; 1,711,941; 1,716,419; 1,716,420; 1,716,422; *Brit. Pats.* 300,477; 301,655; 301,755; 302,280; 302,390; 302,615; 302,667; 303,006; 303,099; 303,134; 303,135; 303,136; 303,485; 303,491; 304,278; 304,279; 305,096; 305,601; 305,946; 305,947; 306,125; 306,531; 306,911; 307,392; 307,431; 308,323; 308,395; 308,657; 309,201; 309,203; 309,913; *Fr. Pat.* 645,110; *Can. Pat.* 289,854.

¹⁴ *Brit. Pat.* 304,374; *Fr. Pat.* 640,066.

¹⁵ *Brit. Pats.* 303,493; 303,752; 303,794; 305,674; 306,132; 308,798.

¹⁶ *Ger. Pat.* 463,879; 464,450; 467,179; 468,171; 468,604.

¹⁷ *Brit. Pat.* 301,962.

¹⁸ DOUGLAS FOX: *Ex. Herald-World*, 94 (Mar. 16, 1929), p. 31.

¹⁹ *Ex. Daily Rev. & Mot. Pict. Today*, 26 (July 6, 1929), p. 16.

²⁰ L. C. MOEN: *Kine. Weekly*, 145 (Mar. 28, 1929), p. 25; also *Bioscope*, 79 (Apr. 10, 1929), p. 25; and *Mot. Pict.*, 5, No. 2 (1929), p. 7.

^{20a} *Ex. Herald-World*, 96 (Sept. 21, 1929), p. 33.

²¹ *Kine. Weekly*, 145 (Mar. 21, 1929), p. 63.

²² *Phot. J.*, 69 (Mar. 1929), p. 125.

²³ *Phot. Korr.*, 64 (Dec. 1, 1928), p. 376.

²⁴ *Amer. Cinemat.*, 9 (Mar., 1929), p. 10.

²⁵ *Trans. Opt. Soc.*, 30, No. 1 (1928-29), p. 34.

²⁶ *Ger. Pat.* 468,838.

²⁷ *Brit. Pat.* 307,683; *Fr. Pat.* 640,833; *U. S. Pats.* 1,700,513; 1,716,512.

²⁸ *Kinotechnik*, 11 (Feb. 20, 1929), p. 87.

²⁹ *Kinotechnik*, 11 (Apr. 5, 1929), p. 174.

³⁰ *Ex. Herald-World*, 94, Sect. 2 (Mar. 16, 1928), p. 85; also *Internat. Phot.*, 1 (July, 1929), p. 14.

³¹ *Internat. Phot.*, 1 (July, 1929), p. 17; also *Trans. Soc. M. P. Eng.*, XIII, No. 38 (1929), p. 477.

³² *Ex. Herald-World*, 94, Sect. 2 (Mar. 16, 1929), p. 85.

³³ *Kinotechnik*, 11 (Feb. 20, 1929), p. 107.

³⁴ *Kinotechnik*, 11 (Mar. 20, 1929), p. 147.

³⁵ *Trans. Soc. Mot. Pict. Eng.*, XIII, No. 37 (1929), p. 312.

³⁶ WM. STULL: *Amer. Cinemat.*, 10 (Sept., 1929), p. 7.

³⁷ *Ger. Pat.* 470,779; *Fr. Pats.* 32,865 (Addition to 633,405); 640,261; 640,866; 641,211; 642,986; 644,325; 645,744; 645,798; 646,621; 647,059; 648,016; 648,782; *Brit. Pats.* 303,354; 303,869; 305,215; 305,550; 306,424; 307,270;

308,784; 308,839; 308,840; *U. S. Pats.* 1,698,106; 1,704,189; 1,707,625; 1,707,767; 1,708,087; 1,714,862; 1,716,463; 1,716,990.

- ³⁸ P. HATSCHKE: *Kinotechnik*, 11 (July 20, 1929), p. 367.
- ³⁹ *Licht Bild Bühne*, 21 (Nov. 3, 1928), p. 16.
- ⁴⁰ *Kinotechnik*, 11 (Mar. 20, 1929), p. 145.
- ⁴¹ *Ed. Screen*, 8 (Apr., 1929), p. 105.
- ⁴² *Kinotechnik*, 11 (Apr. 20, 1929), p. 202.
- ⁴³ *Ger. Pat.* 470,566.
- ⁴⁴ E. M. W. SEBRING: *Internat. Phot.*, 1 (July, 1929), p. 12.
- ⁴⁵ R. E. FARNHAM: *Amer. Cinemat.*, 10 (May, 1929), p. 16; also WRIGHT and EGELER: *Trans. Soc. Mot. Pict. Eng.*, XIII, No. 38 (1929), p. 346.
- ⁴⁶ O. K. OLSON: *Amer. Cinemat.*, 10 (June, 1929), p. 14; also R. E. FARNHAM: *Ibid.*, 10 (July, 1929), p. 7, and *Trans. Il. Eng. Soc.*, 23 (Dec., 1928), p. 1241.
- ^{46a} *Amer. Cinemat.*, 10 (Aug., 1929), p. 21.
- ⁴⁷ *Amer. Cinemat.*, 10 (Apr., 1929), p. 13.
- ⁴⁸ *Kinotechnik*, 11 (Apr. 20, 1929), p. 216.
- ⁴⁹ *Internat. Phot.*, 1 (Sept., 1929), p. 12.
- ⁵⁰ *Licht Bild Bühne*, 22 (Jan. 19, 1929), p. 20; *Ibid.*, 22 (Feb. 2, 1929), p. 19.
- ⁵¹ *Ex. Daily Rev. & Mot. Pict. Today*, 25 (June 1, 1929), p. 6.
- ⁵² J. M. FIDLER: *Amer. Cinemat.*, 10 (Sept., 1929), p. 33.
- ⁵³ R. E. NORMAN: *Amer. Cinemat.*, 10 (May, 1929), p. 19.
- ⁵⁴ J. DUBRAY: *Amer. Cinemat.*, 9 (Sept., 1928), p. 11.
- ⁵⁵ *Ger. Pat.* 466,607.
- ⁵⁶ C. H. DUNNING: *Amer. Cinemat.*, 10 (Apr., 1929), p. 18.
- ⁵⁷ *Amer. Cinemat.*, 10 (Apr., 1929), p. 20.
- ⁵⁸ *Amer. Cinemat.*, 10 (July, 1929), p. 37.
- ⁵⁹ F. W. SÆRSEN: *Amer. Cinemat.*, 10 (July, 1929), p. 31.
- ⁶⁰ *Ger. Pat.* 466,347; *U. S. Pats.* 1,698,178; 1,703,818; 1,715,127; 1,715,510.
- ⁶¹ H. CROISE: *Bioscope* (Brit. Film No.) (1928), p. 267.
- ⁶² *Internat. Phot.*, 1 (Aug., 1929), p. 16.
- ⁶³ *Mot. Pict. News*, 40 (Sept. 7, 1929), p. 908; also *Ex. Herald-World*, 96 (Aug. 24, 1929), p. 39.
- ⁶⁴ *Mot. Pict. Div. U. S. Dept. Com. Report* (Aug. 21, 1929).
- ⁶⁵ L. W. PHYSIOC: *Internat. Phot.*, 1 (Sept., 1929), p. 7.
- ⁶⁶ *B. J.*, 76 (Mar. 15, 1929), p. 149; *Can. Pat.* 289,343.
- ⁶⁷ *Kinotechnik*, 11 (Apr. 20, 1929), p. 208.
- ⁶⁸ T. A. MILLER: *Internat. Phot.*, 1 (Aug., 1929), p. 32.
- ⁶⁹ H. BÖHM: *Kinotechnik*, 11 (Feb. 20, 1929), p. 90; also *Wireless World* (Apr. 10, 1929), and *Bioscope* (Supp.), 78 (Feb. 27, 1929), p. VII.
- ⁷⁰ P. HATSCHKE: *Kinotechnik*, 11 (Aug. 20, 1929), p. 436.
- ⁷¹ *Amer. Cinemat.*, 10 (Sept., 1929), p. 16; also *Filmtechnik*, 5 (Apr. 27, 1929), p. 191.
- ⁷² *Wireless World*, 23 (Dec. 26, 1928), p. 842.
- ⁷³ P. HEMARDINGUER: *La Nature*, No. 2814 (July 1, 1929), p. 107.
- ⁷⁴ L. A. ELMER: *Bell Lab. Record*, 7 (July, 1929), p. 445.
- ⁷⁵ P. HATSCHKE, *Kinotechnik*, 11 (July 5, 1929), p. 343.
- ⁷⁶ P. HATSCHKE and E. LIHOTZKY: *Kinotechnik*, 11 (Mar. 20, 1929), p. 149.
- ⁷⁷ A. KLAGES: *Kinotechnik*, 11 (July 20, 1929), p. 376; *et seq.*

- ⁷⁸ P. HATSCHKE: *Kinotechnik*, **11** (May 5, 1929), p. 235.
- ⁷⁹ E. T. PARIS: *Phil. Mag.*, **5** (Mar., 1928), p. 489.
- ⁸⁰ *Prog. Report. Supp. Acad. Mot. Pict. Arts & Sciences* (Aug. 20, 1929), p. 7.
- ⁸¹ *Bull. Acad. Mot. Pict. Arts and Sciences*, No. 25 (Sept. 25, 1929), p. 1.
- ⁸² H. C. HUMPHREY: *Trans. Soc. Mot. Pict. Eng.*, **XIII**, No. 37 (1929), p. 158.
- ⁸³ K. F. MORGAN: *Trans. Soc. Mot. Pict. Eng.*, **XIII**, No. 38 (1929), p. 268.
- ⁸⁴ *Can. Pats.* 288,442; 288,817; 288,818; *Fr. Pats.* 641,854; 645,010; 645,648; 646,625; *Brit. Pats.* 301,391; 301,730; 304,672; 305,245; 305,466; 306,438; 306,565; 307,078; 307,348; 309,676; *U. S. Pats.* 1,698,536; 1,700,833; 1,707,243; 1,708,523; 1,710,677; 1,713,726; *Australian Pat.* 10,585 of 1927.
- ⁸⁵ A. JACKSON: *Bioscope* (Brit. Film No.) (1928), p. 221.
- ⁸⁶ *Amer. Cinemat.*, **10** (May, 1929), p. 14; also F. O. GRAVES: *Trans. Soc. Mot. Pict. Eng.*, **XIII**, No. 38 (1929), p. 303.
- ⁸⁷ F. G. BANGS: *Bioscope* (Brit. Film No.) (1928), p. 70.
- ⁸⁸ Witham, W. J.: *Bioscope* (Brit. Film No.) (1928), p. 72.
- ⁸⁹ *Bioscope*, (Brit. Film No.) (1928), pp. 99-117.
- ⁹⁰ *Ex. Herald-World*, **96** (Sept. 14, 1929), p. 35.
- ⁹¹ *Amer. Cinemat.*, **10** (May, 1929), p. 23.
- ⁹² W. VINTEN: *Bioscope Supp.*, **77** (Dec. 12, 1928), p. vi.
- ⁹³ *Kinotechnik*, **11** (Aug. 20, 1929), p. 442.
- ⁹⁴ A. and L. LUMIÈRE and A. SEYEWETZ: *Sci. Ind. Phot.*, **8A** (Dec., 1928), p. 126.
- ⁹⁵ VON BARSY, A.: *Kinotechnik*, **11** (Jan. 20, 1929), p. 40.
- ⁹⁶ H. W. MOYSE and D. R. WHITE: *Internat. Phot.*, **1** (July, 1929), p. 20.
- ⁹⁷ H. C. CARLTON and J. I. CRABTREE: *Amer. Cinemat.*, **10** (July, 1929), p. 17, *et seq.*; also *Trans. Soc. Mot. Pict. Eng.*, **XIII**, No. 38 (1929), p. 406.
- ⁹⁸ K. CHIBISSOFF: *Kinotechnik*, **11** (May 5, 1929), p. 227, *et seq.*
- ⁹⁹ J. F. ROSS and J. I. CRABTREE: *Amer. Phot.*, **23** (May, 1929), p. 254.
- ¹⁰⁰ J. I. CRABTREE and H. A. HART: *Amer. Cinemat.*, **10** (Sept., 1929), p. 3; *Trans. Soc. Mot. Pict. Eng.*, **XIII**, No. 38 (1929), p. 364.
- ¹⁰¹ R. GARRIGA: *El. prog. fot.*, **10** (Mar., 1929), p. 61.
- ¹⁰² L. P. CLERC: *B. J.*, **76** (May 24, 1929), p. 300.
- ¹⁰³ *Ger. Pat.* 472,096.
- ¹⁰⁴ *Br. Pat.* 308,653.
- ¹⁰⁵ O. DEPUE: *Trans. Soc. Mot. Pict. Eng.*, **XIII**, No. 37 (1929), p. 150.
- ¹⁰⁶ R. E. NAUMAN: *Amer. Cinemat.*, **10** (June, 1929), p. 32.
- ¹⁰⁷ *Amer. Cinemat.*, **10** (Aug., 1929), p. 23.
- ¹⁰⁸ *Ger. Pats.* 473,070; 474,599; *Brit. Pats.* 308,360; 308,361; 308,693; *U. S. Pats.* 1,704,785; 1,714,203; 1,716,033; 1,716,417; *Fr. Pats.* 32,679 (Addition to 620,977); 640,921.
- ¹⁰⁹ M. ADAM: *Kinotechnik*, **11** (Feb. 5, 1929), p. 68.
- ¹¹⁰ L. R. LOEFFLER: *Amer. Cinemat.*, **10** (June, 1929), p. 19.
- ¹¹¹ *Bioscope (Supp.)*, **78** (Mar. 20, 1929), p. xii.
- ¹¹² *Brit. Pat.* 301,676.
- ¹¹³ *Fr. Pat.* 648,015.
- ¹¹⁴ *U. S. Pat.* 1,701,048.
- ¹¹⁵ *Fr. Pat.* 647,113.
- ¹¹⁶ *Ger. Pat.* 469,538.
- ¹¹⁷ S. JASIENSKI: *Phot. Ind.*, **27** (Jan. 16, 1929), p. 73.

- ¹¹⁸ *Ex. Herald-World*, **95**, Sect. 1 (May 11, 1929), p. 26.
- ¹¹⁹ *Amer. Cinemat.*, **10** (May, 1929), p. 40.
- ¹²⁰ *Film Daily* (Aug. 11, 1929), p. 11.
- ¹²¹ *Amer. Cinemat.*, **10** (Aug., 1929), p. 17.
- ¹²² *U. S. Pat.* 1,697,858; *Brit. Pats.* 305,681; 305,726.
- ¹²³ *Amer. Projectionist*, **7** (Feb., 1929), p. 17.
- ¹²⁴ *Kinotechnik*, **10** (Dec. 20, 1928), p. 650.
- ¹²⁵ *Bioscope (Supp.)*, **79** (May 15, 1929), p. xiii.
- ¹²⁶ *Mot. Pict. Projectionist*, **2** (Dec., 1928), p. 33.
- ¹²⁷ *Amer. Cinemat.*, **10** (Aug., 1928), p. 40.
- ¹²⁸ *Sci. et Ind. Phot.*, **9A** (Apr., 1929), p. 41.
- ¹²⁹ *Amer. Cinemat.*, **9** (Feb., 1929), p. 28.
- ¹³⁰ *Fr. Pat.* 641,260; *Brit. Pats.* 305,130; 306,126; 309,869; *U. S. Pats.* 1,702,302; 1,708,521; 1,711,977; 1,713,663; 1,713,939; 1,714,461; 1,714,461; 1,716,322.
- ¹³¹ *Mot. Pict. News*, **39** (Feb. 2, 1929), p. 316.
- ¹³² E. LEHMANN: *Kinotechnik*, **10** (Dec. 20, 1928), p. 635.
- ¹³³ *Licht. Bild Bühne*, **22** (Jan. 5, 1929), p. 22.
- ¹³⁴ H. JOACHIM: *Kinotechnik*, **11** (Jan. 20, Feb. 5, 1929), pp. 33 and 59.
- ¹³⁵ *Ger. Pat.* 473,443; *Fr. Pats.* 640,706; 643,959; 647,101; *U. S. Pats.* 1,700,656; 1,717,234; *Brit. Pats.* 304,425; 306,719.
- ¹³⁶ *U. S. Pats.* 1,709,017; 1,716,361; 1,716,756.
- ¹³⁷ FR. PATZELT: *Kinotechnik*, **11** (Aug. 20, 1929), p. 423.
- ¹³⁸ *Mot. Pict. News*, **40** (Aug. 17, 1929), p. 655.
- ¹³⁹ *Ex. Daily Review & Mot. Pict. Today*, **26** (Sept. 21, 1929), p. 6.
- ¹⁴⁰ *Kinemat. Weekly*, **147** (May 9, 1929), p. 21.
- ¹⁴¹ *Ex. Herald-World*, **96** (Sept. 21, 1929), p. 32.
- ¹⁴² *Ex. Daily Review & Mot. Pict. Today*, **26** (July 6, 1929), p. 14.
- ¹⁴³ R. H. CRICKS: *Kinemat. Weekly*, **148** (June 6, 1929), p. 72.
- ¹⁴⁴ *Kinemat. Weekly*, **142** (Dec. 20, 1928), p. 55.
- ¹⁴⁵ R. H. CRICKS: *Kinemat. Weekly*, **148** (June 13, 1929), p. 60.
- ¹⁴⁶ *Mot. Pict. News*, **40** (Aug. 17, 1929), p. 652.
- ¹⁴⁷ *Mot. Pict. News*, **39** (May 18, 1929), p. 1699.
- ¹⁴⁸ *Bioscope (Supp.)*, **79** (Apr. 10, 1929), p. ix; also *Ibid.*, **79** (May 1, 1929), p. vi.
- ¹⁴⁹ *Kinemat. Weekly*, **147** (May 2, 1929), p. 59.
- ¹⁵⁰ G. SCHUTZ: *Ex. Herald-World*, **94**, Sect. 2 (Mar. 16, 1929), p. 37; see also *Mot. Pict. News*, **40** (Sept. 7, 1929), p. 878.
- ¹⁵¹ *Ex. Herald-World*, **94**, Sect. 2 (Mar. 16, 1929), p. 50.
- ¹⁵² *Ex. Herald-World*, **94**, Sect. 1 (Feb. 16, 1929), p. 44.
- ¹⁵³ *Prog. Report, Acad. Mot. Pict. Arts & Sciences*, Aug. 20 (1929), pp. 2 and 4.
- ^{153^a} *Mot. Pict. News*, **40** (Oct. 5, 1929), p. 1195.
- ¹⁵⁴ *Fr. Pat.* 647,253; *Ger. Pat.* 456,872; *Can. Pats.* 288,816; 289,022; *U. S. Pats.* 1,695,048; 1,706,731; 1,708,410; 1,708,533; 1,713,503; *Brit. Pats.* 301,872; 304,705; 305,617; 306,404; 306,426; 307,514; 309,183; 309,208.
- ¹⁵⁵ *Mot. Pict. News*, **40** (Sept. 7, 1929), p. 894.
- ¹⁵⁶ M. RITTERATH: *Amer. Cinemat.* **10** (Apr., 1929), p. 10.
- ¹⁵⁷ H. E. IVES, *J. Opt. Soc. Amer.*, **18** (Feb., 1929), p. 118.

- ¹⁵⁸ *Fr. Pat.* 640,273; *Brit. Pats.* 303,067; 308,596; *U. S. Pats.* 1,705,760; 1,714,849.
- ¹⁵⁹ R. HOCK: *Kinotechnik*, 11 (Feb. 5, 1929), p. 66.
- ¹⁶⁰ L. BURMESTER and E. MECHAU: *Kinotechnik*, 10 (Aug. 5, 20; Sept. 5, 1928), pp. 395, 423, 447.
- ¹⁶¹ R. THUN: *Kinotechnik*, 11 (May 20, 1929), p. 255.
- ¹⁶² P. HATSCHKE: *Amer. Cinemat.*, 9 (Sept., 1928), p. 18.
- ¹⁶³ H. IVARSON: *Kinotechnik*, 11 (Aug. 20, 1929), p. 425.
- ¹⁶⁴ *Fr. Pats.* 641,109; 643,818; *Brit. Pats.* 308,945; 309,448; 309,655; *U. S. Pats.* 1,699,169; 1,699,833; 1,707,498.
- ¹⁶⁵ *Ex. Herald-World*, 95, Sect. 2 (May 11, 1929), p. 41.
- ¹⁶⁶ *Brit. Pat.* 309,801; *Fr. Pats.* 642,604; 647,437; 648,109; *U. S. Pats.* 1,701,564; 1,703,891; 1,713,921; 1,717,063.
- ¹⁶⁷ *U. S. Pat.* 1,715,158.
- ¹⁶⁸ *Film Daily*, 48 (June 30, 1929), p. 15.
- ¹⁶⁹ *Bioscope (Supp.)*, 79 (June 12, 1929), p. viii.
- ¹⁷⁰ *Kinotechnik*, 11 (Jan. 5, 20, 1929), pp. 20, 48.
- ¹⁷¹ *Kinemat. Weekly*, 145 (Mar. 14, 1929), p. 93.
- ¹⁷² *Fr. Pats.* 640,612; 641,597; *Brit. Pats.* 302,452; 304,656; 304,913; 304,975; 305,888; *U. S. Pats.* 1,701,590; 1,714,550.
- ^{172^a} *Film Daily*, 48 (June 28, 1929), p. 1.
- ¹⁷³ *Report from Mot. Pict. Div. U. S. Dept. Com.* (Sept. 4, 1929), p. 2.
- ¹⁷⁴ C. SYLVESTER: *Kinemat. Weekly*, 146 (Apr. 4, 1929), p. 63.
- ¹⁷⁵ D. FOX: *Ex. Herald-World*, 95, Sect. 2 (Apr. 13, 1929), p. 20.
- ¹⁷⁶ L. G. APPLEBEE: *Kinemat. Weekly*, 147 (May 2, 1929), p. 37.
- ¹⁷⁷ A. T. HENLY: *Kinemat. Weekly*, 144 (Feb. 14, 1929), p. 89.
- ¹⁷⁸ E. BERLINER: *J. Frank. Inst.*, 208 (July, 1929), p. 13, *et seq.*
- ¹⁷⁹ T. E. FINEGAN: *Trans. Soc. Mot. Pict. Eng.*, XIII, No. 38 (1929), p. 324.
- ¹⁸⁰ R. B. BONNEY: *Mountain States Monitor*, 23 (April, 1929), p. 26.
- ¹⁸¹ *New York Times*, Sect 2 (July 28, 1929).
- ¹⁸² *Rev. franc. Phot.*, 10 (July 15, 1929), p. 223.
- ¹⁸³ *B. J.*, 76 (June 14, 1929), p. 354.
- ¹⁸⁴ W. STULL: *Amer. Cinemat.*, 10 (June, 1929), p. 16.
- ¹⁸⁵ L. M. BAILEY: *Movie Makers*, 4 (Apr., 1929), p. 223.
- ¹⁸⁶ R. THUN: *Kinotechnik*, 11 (Jan. 20, 1929), p. 42.
- ¹⁸⁷ *Brass World*, 25 (May, 1929), p. 111.
- ¹⁸⁸ *Ed. Screen*, 8 (May, 1929), p. 139.
- ¹⁸⁹ *Ed. Screen*, 7 (Nov., 1928), p. 228.
- ¹⁹⁰ *Ed. Screen*, 8 (Jan., 1929), p. 9.
- ¹⁹¹ O. M. FOKERT, *Ed. Screen*, 8 (Mar., 1929), p. 76.
- ¹⁹² J. J. STUTZIN: *Kinotechnik*, 11 (July 5, 1929), p. 350.
- ¹⁹³ E. HAUSER: *Kinotechnik*, 11 (Aug. 20, 1929), p. 427.
- ¹⁹⁴ V. GOTTHEINER and K. JACOBSON: *Phot. Ind.*, 27 (June 5, 1929), p. 627.
- ¹⁹⁵ *Photo-Era*, 62 (May, 1929), p. 274.
- ¹⁹⁶ H. C. MCKAY: *Photo-Era*, 62 (May, 1929), p. 284.
- ¹⁹⁷ *Kinotechnik*, 11 (Apr. 20, 1929), p. 216.
- ¹⁹⁸ FRIEDEL: *Kinotechnik*, 11 (Mar. 5, 1929), p. 115.
- ¹⁹⁹ *Report Mot. Pict. Div. U. S. Dept. Com.* (Sept. 11, 1929), p. 1.

- 200 *Report Mot. Pict. Div. U. S Dept. Com.* (Aug. 28, 1929), p. 2.
- 201 *Ex. Herald-World*, **94** (Feb. 9, 1929), p. 35.
- 201^a *Ex. Herald-World*, **96** (Sept. 14, 1929), p. 32.
- 202 *Electrical Review*, **103** (Dec. 21, 1928), p. 1075.
- 203 *Fr. Pat.* 646,420.
- 204 *Photo-Era*, **62** (March, 1928), p. 161.
- 205 K. F. MATHER, *Ed. Screen*, **8** (Feb., 1929), p. 36.
- 206 L. M. BAILEY, *Movie Makers*, **4** (Mar., 1929), p. 178.
- 207 F. BECK, *Kinotechnik*, **11** (Mar. 5, 1929), p. 124.
- 208 F. BECK, *Kinotechnik*, **11** (Apr. 5, 1929), p. 179.
- 209 G. MAISER and H. UMBEHR: *Kinotechnik*, **11** (July 20, 1929), p. 379.
- 210 R. THUN: *Kinotechnik*, **11** (July 20, 1929), p. 383.
- 211 *Sci. Ind. Phot.* **10** (March, 1929), p. 35.
- 212 *Sci. Amer.*, **141** (July, 1929), p. 27.
- 213 *Barrons' Weekly* (Sept. 16, 1929), p. 18; also *Ex. Herald-World*, **96** (July 6, 1929), p. 70.
- 214 G. B. BROWN: *Internat. Phot.*, **1** (Sept., 1929), p. 34.
- 215 P. TIETZE: *Kinotechnik*, **11** (Feb. 20, 1929), p. 99.
- 216 *Brit. Pats.* 304,632; 308,973; 309,113; 309,504; *Ger. Pats.* 469,502; 467,711.
- 217 *Fr. Pats.* 640,118; 640,133; 640,139; *Brit. Pats.* 301,732; 303,170; 303,356; 303,357; 304,643; 304,669; 307,351; 308,320; *U. S. Pat.* 1,707,157.
- 218 *U. S. Pats.* 1,700,617; 1,700,618.
- 219 W. T. CRESPINELL: *Internat. Phot.*, **1** (Aug., 1929), p. 30.
- 220 *Kinemat. Weekly*, **145** (Mar. 21, 1929), p. 69.
- 221 *Fr. Pat.* 644,803; and *Kinemat. Weekly*, **144** (Feb. 21, 1929), p. 58.
- 222 *Can. Pat.* 290,031; *Fr. Pat.* 646,693; *Ger. Pats.* 465,458; 466,327; 469,416; *Brit. Pats.* 303,262; 306,328; 306,329; 307,659; *U. S. Pats.* 1,697,194; 1,699,226; 1,700,252; 1,700,616; 1,707,699; 1,707,709; 1,707,710; 1,707,825; 1,712,439; 1,716,989.
- 223 *Film für Alle*, No. 14 (Dec., 1928).
- 224 *Cine Kodak News*, **6** (Aug., 1929), p. 6.
- 225 *Movie Makers*, **4** (May, 1929), p. 332.
- 226 *Amat. Phot.*, **67** (Jan. 9, 1929), p. 28.
- 227 *B. J.*, **76** (Aug. 16, 1929), p. 488.
- 228 *Phot. Dealer*, **43** (Jan., 1929), p. 34.
- 229 *Film für Alle*, **3** (Apr., 1929), p. 108.
- 230 *Amat. Phot.*, **67** (Apr. 24, 1929), p. 342.
- 231 *Photo-Era*, **62** (Mar., 1929), p. 167.
- 232 *Amat. Phot.*, **67** (June 12, 1929), p. 506.
- 233 *Filmo Topics*, **5** (June, 1929), p. 5.
- 234 H. C. MCKAY: *Amer. Phot.*, **23** (Jan., 1929), p. 16.
- 235 H. C. MCKAY: *Movie Makers*, **4** (Mar., 1929), p. 151.
- 236 H. C. MCKAY: *Photo-Era*, **62** (Mar., 1929), p. 172.
- 237 *Movie Makers*, **4** (Mar., 1929), p. 195.
- 238 *Movie Makers*, **4** (June, 1929), p. 408.
- 239 E. S. GODDARD: *Phot. J.*, **69** (Feb., 1929), p. 80.
- 240 *Ed. Screen*, **8** (Mar., 1929), p. 94.
- 241 *Film für Alle*, **3** (May, 1929), p. 141.

- ²⁴² *Film für Alle*, **3** (May, 1929), p. 139.
- ²⁴³ P. HATSCHKE, *Kinotechnik*, **11** (Aug. 20, 1929), p. 192.
- ²⁴⁴ *Amat. Films*, **1** (June, 1929), p. 223.
- ²⁴⁵ *Kinotechnik*, **11** (Apr. 5, 1929), p. 192.
- ²⁴⁶ *Brit. Pat.* 304,366; *U. S. Pat.* 1,708,372.
- ²⁴⁷ *Filmo Topics*, **5** (Feb., 1929), p. 5.
- ²⁴⁸ *Photo-Era*, **62** (Feb., 1929), p. 114.
- ²⁴⁹ *B. J.*, **76** (June 7, 1929), p. 337.
- ²⁵⁰ *Movie Makers*, **4** (May, 1929), p. 337.
- ²⁵¹ *Phot. Dealers*, **43** (Apr., 1929), p. 196.
- ²⁵² *Amer. Cinemat.*, **10** (Aug., 1929), p. 37.
- ²⁵³ H. E. C. FURSIER: *Amat. Phot.*, **67** (May, 1929), p. 381.
- ²⁵⁴ *Austral. Photo-Review*, **36** (Apr., 1929), p. 181.
- ²⁵⁵ *Amer. Phot.*, **23** (Jan., 1929), p. 46.
- ²⁵⁶ *Amer. Cinemat.*, **10** (June, 1929), p. 39.
- ²⁵⁷ *U. S. Pat.* 1,708,370; 1,708,371.
- ²⁵⁸ *U. S. Pat.* 1,709,341.
- ²⁵⁹ *Mot. Pict.*, **5** (June, 1929), p. 3.
- ²⁶⁰ *Mot. Pict.*, **5** (May, 1929), p. 3.
- ²⁶¹ *Ex. Herald-World*, **94** (Feb. 16, 1929), p. 28.
- ²⁶² N. D. GOLDEN: *Report Mot. Pict. Div. U. S. Dept. Com.* (Aug. 5, 1929).
- ²⁶³ N. D. GOLDEN: *Ex. Herald-World*, **95**, Sect. 2 (May 11, 1929), p. 71; also *Ed. Screen*, **8** (March, 1929), p. 75.
- ²⁶⁴ *Film Daily*, **49** (July 29, 1929), p. 7, *et seq.*
- ²⁶⁵ H. FRAINKEL: *Bioscope*, **78** (Feb., 20, 1929), p. 28.
- ²⁶⁶ *Phot. Ind.*, **26** (Sept. 12, 1929), p. 952.
- ²⁶⁷ *Kinemat. (Supp.)*, **143** (Jan. 31, 1929), p. 7.

ABSTRACTS

Selenophone: A Variable Area Sound Film Device. P. HATSCHEK. *Kino-technik*, 11, Aug. 20, 1929, pp. 436-8. A description of the general principles of the Selenophone sound film system. The torsion galvanometer employed consists of a transverse vibrating metal band in a strong magnetic field. The motion of an illuminated slit attached to the vibrating band is optically magnified 100 times and recorded on the film. For reproduction the "condenser" type of selenium cell is used. The change of resistance of selenium cells upon illumination is known to be accompanied by considerable lag, the greatest lag occurring when the light is decreased. This undesirable property of the selenium cell can be compensated largely by the use of an amplifier vacuum tube operated during the lag period. With the rapid light fluctuations and such an arrangement, the fatigue of the selenium cell is also minimized. The exact details of the compensation method employed in the Selenophone have not been made public.

Talkies Have a Past! J. F. RIDER. *Mot. Pict. News*, 39, Mar. 2, 1929, p. 627. A brief description of the outstanding discoveries which made sound motion pictures possible. In 1857, M. Leon Scott made the first record of sound vibrations. Sound was first recorded and reproduced by Edison in 1877 in a tin-foil record; the process was improved by Bell and Tainter in 1887 who used wax records. In 1889 Emil Berliner patented the disk record which, with improvements, is now in use. The change in resistance of selenium with change of light intensity was first observed in the 19th century by May, the operator of the Ireland terminal of the transatlantic cable. Interest in the sensitivity of selenium and an effort to overcome the lag in its response caused much investigation which ultimately produced the photo-electric cell. This cell was improved by deForest in 1907 who produced the vacuum amplifying tube.

Running the Talkies. XXII. Naturetone. R. H. CRICKS. *Kinemat. Weekly*, 150, Aug. 15, 1929, p. 69. Comments on the Naturetone equipment for the reproduction of disk-recorded sound. Separate turntables must be used for low speed and high speed records. The speed control is described and stated to be satisfactory. The sound is to be recorded on cylinders in place of the usual disks.

Sound-proof Studios. *Kinemat. Weekly*, 150, Aug. 22, 1929, p. 54. The construction of the new sound-proof studio of the British Talking Pictures is described. To exclude exterior noises and prevent internal reverberation, air-spaced concrete walls are used, with an inner shell of sound absorbing material. The floor is laid on thick felt runners, with a layer of plastic material [bitumen—*Abstr.*] adhering to the underside of the boards. There is a tank 33 by 32 ft. sunk in the studio floor, arranged for underwater shots. The studio is 120 by 90 ft. in size, stated to be the largest of its kind in Europe. Production lighting is incandescent. [The wiring of the lighting system is arranged in a false ceiling, and all leads and lamps will be dropped from galleries above the studio so leaving the floor clear.—*Abstr.*]

Acoustical Control of Theater Design. H. L. COOKE. *J. Frank. Inst.*, 208,

September, 1929, pp. 319-24. By proper adaptation of ceiling design to the design of the rest of the auditorium it is possible to provide all members of the audience seated beyond $\frac{2}{5}$ the distance from front to back with equally clear reception. In general the longitudinal vertical median section of the computed ceiling shows increasing curvature toward the back of the hall. The visual and acoustical advantages of having the vertical sections of the auditorium surfaces through the stage conform to the equation $r = e^{a\theta}$ are pointed out.

Mazdas Make Good in Severe Studio Test. *Mot. Pict. News*, 39, April 6, 1929, p. 1055. In the lighting of a large set in the sound picture, *Broadway*, three 163 units were used which had a connected load of 33,000 amperes. The main set was 170 ft. long and 125 ft. wide and with 4 auxiliary sets made a total length of 220 ft. For the color sequences, a maximum of 22,000 amp. was required; for black and white work, 17,000 amp. A large electrical crane was used for many of the camera shots. The boom of the crane was 25 ft. long and it was mounted on a steel column 12 ft. high. Rapid upward or circular movements were possible with the equipment, which had a circular platform, 5 ft. in diameter at the end, for the camera equipment and operators.

Properties and Use of Hypersensitized and Panchromatic Negative Film. K. JACOBSON. *Kinotechnik*, 10, April 5, 1928, pp. 175-83. A summary of previous work, giving the literature references, on hypersensitizing with ammonia, ammoniacal silver chloride solutions; color sensitizing with pinaflavol-pinacyanol and pinachrome-pinachrome violet. Other subjects treated are the use of infrared sensitized film; the development of night exposures on hypersensitized film in a special pyro developer to avoid glaring high-light contrast; and tone rendering with panchromatic materials. References to the literature are given.

Method for the Measurement of the Effective Transparency of Photographic Objectives. J. HRDLICKA. *Compt. rend.*, 189, July 22, 1929, pp. 153-5. The author advocates photographic photometry for determining the effective transparency of a photographic objective and quotes an instance in which this value does not check with the maker's $f/$ value within a reasonable amount.

Maximum Light Flux Obtainable in Kine Projection. H. NAUMANN. *Kinotechnik*, 10, 1928, p. 523. The theoretical maximum of illumination obtainable with the mirror-arc system, taking into account the effects of size of source, type, and aberrations of mirror and projection lens aperture, has been closely approached in practice. Owing to the smaller surface intensity and the presence of the glass bulb, tungsten filament lamp-mirror systems cannot be made to give more than about one-sixth of the light flux of arc systems.

Muybridge's Motion Pictures. L. F. RONDINELLA. *J. Frank. Inst.*, 208, September, 1929, pp. 417-20. The author, who was an assistant of Muybridge, defends the latter's claim as inventor of motion pictures. He takes exception to some statements made by Leffmann. Leffmann appends a reply stating that Heyl exhibited motion pictures in 1870.

Kinematography in the Service of Medicine. E. DEGNER. *Phot. Korr.*, 64, 1928, p. 347, p. 378. In addition to an enumeration of various medical subjects in which motion picture photography has been of value, there is a description of von Rothe's apparatus and that of Brusten. The former is constructed as far as possible in a room above the operating theater. The camera is mounted on an arm suspended vertically through the ceiling. The main disadvantages are cost

and limitation to normal speeds. Brusten's apparatus is mounted on a counter-balanced lever on a movable stand. Pictures can be made from almost any angle and speeds up to 100 per second are possible.

Goal of Photographic Optics. A. SONNEFELD. *Phot. Korr.* **64**, 1928, p. 376. Because of light losses due to reflection and absorption, the useful limit of aperture has been reached with lenses of ordinary types of $f/2$ to $f/1.5$. Such lenses, however, have the defect of not being perfectly zonally corrected. Nonspherical refracting surfaces (Abbé surfaces) might remove the defect and result in fewer components and less light absorption.

New Actinometer. Luminous Source of Constant Spectral Composition. R. LANDAU. *S. & J. P. Inf. Ciné.*, **8**, 1928, p. 131; **9**, 1929, p. 5. An image of the subject is formed on a phosphorescent screen. A mirror placed clear of the objective axis is inclined so that light received from the surface is reflected in a direction parallel to that of the light from the objective. This light consists of polychromatic reflected light and monochromatic light due to phosphorescence. A shutter is so placed that it will allow the light from the objective to reach the screen but will intercept the reflected image light from the mirror. The shutter will allow the phosphorescent light to pass intermittently. The phosphorescent light is of constant spectral composition and is proportional to the actinic light in the image. The phosphorescent image light may be inspected with a photo-cell.

BOOK REVIEWS

Proceedings of the Seventh International Congress of Photography. Edited by W. CLARK, T. SLATER PRICE, AND B. V. STORR. Illustrated papers. *W. Heffer and Sons, Ltd.*, Cambridge, England, 1929. XII + 571 pp. On July 9-14, 1928, the Seventh International Congress of Photography met in London and this volume is a record of the proceedings. The material is presented under three section heads the first of which contains the majority of papers. In this section scientific applications, theory, and motion picture photography are included. The other two sections contain excellent material in their subject classifications, pictorial photography, history, bibliography, and legal questions. The Proceedings may be regarded, in spite of the lack of a complete index as a valuable reference book in general photography. The material of special interest to motion picture photographers, however, makes up only a small portion of the book. In this section matters of standardization which are of importance to the industry as a whole are discussed. Some of the recommendations arising out of these discussions are as follows: Maximum thickness for negative should be 0.175 mm. Maximum displacement of perforations on opposite edges of film should be 0.05 mm. Positive perforation should be Kodak standard and negative Bell and Howell standard. Light change marks for printing are specified to be 38 mm. long and 1.4 mm. deep starting at the splice. They are to be placed on the right hand side of the negative as it is held with the picture inverted and emulsion side toward the observer. Negative film should be supplied wound emulsion outward on metal centers of specified dimensions. It is impractical to attempt a comprehensive review of the many valuable papers of general interest in photographic theory. Some features may be mentioned however. Toy and Weigert have given valuable contributions to the theory of the latent image. Jones and Hall have presented an empirical relation which represents the failure of the reciprocity law with great accuracy. Jones and Russell have suggested a new method of expressing plate speeds.

Motion Picture Photography. C. L. GREGORY. *Falk Publishing Co., Inc.*, New York City, 1927, \$6.00. 435 p. Second edition. Few changes have been made in this new edition of this textbook of the New York Institute of Photography although there has been considerable progress noted in the industry since the publication of the first edition in 1920. New material has been added in a chapter on color motion pictures, with a very brief description of progress in stereoscopic and sound pictures. A useful section is the added chapter on "Some Typical Motion Picture Cameras," which gives specifications of the leading standard cameras of American manufacture. Descriptions of British, French, and German cameras would have increased the value of this chapter. A glossary of common cinematographic terms has been included. Examination of the bibliography shows that several new books have been omitted. The illustrations are interesting although with the wealth of beautiful "stills" available it would seem that some of the old pictures might well have been left out of this edition.

These faults are minor, however, compared to the wealth of material contained in the work.

Motion Picture Work on Substandard Film. (Die Schmalfilm-Kinematographie.) O. P. HERRNKIND. A. Hartleben, Vienna, 1929, \$2.00. 175 p. A general review of the whole subject. The various substandard films on the market, and the apparatus used for exposure and projection are described. A considerable amount of attention is paid to the methods by which an amateur can finish his own pictures. There is a chapter on trick film work. The whole book is a compilation, and does not contain much original material derived from personal experience.

SOCIETY OF MOTION PICTURE ENGINEERS

OFFICERS

President

J. I. CRABTREE, Eastman Kodak Co., Rochester, N. Y.

Past President

L. C. PORTER, Edison Lamp Works, Harrison, N. J.

Vice-Presidents

H. P. GAGE, Corning Glass Works, Corning, N. Y.

K. C. HICKMAN, Eastman Kodak Co., Rochester, N. Y.

Secretary

R. S. BURNAP, Edison Lamp Works, Harrison, N. J.

Treasurer

W. C. HUBBARD, Cooper-Hewitt Electric Co., Hoboken, N. J.

Board of Governors

R. S. BURNAP, Edison Lamp Works, Harrison, N. J.

H. T. COWLING, Eastman Teaching Films, Inc., 343 State St., Rochester, N. Y.

J. I. CRABTREE, Research Laboratory, Eastman Kodak Co., Rochester, N. Y.

H. P. GAGE, Corning Glass Works, Corning, N. Y.

K. C. HICKMAN, Research Laboratory, Eastman Kodak Co., Rochester, N. Y.

W. C. HUBBARD, Cooper-Hewitt Electric Co., Hoboken, N. J.

W. C. KUNZMANN, National Carbon Company, Cleveland, Ohio.

D. MACKENZIE, Bell Telephone Labs., 463 West St., New York, N. Y.

P. MOLE, Mole-Richardson, Inc., 941 N. Sycamore Ave., Hollywood, Calif.

L. C. PORTER, Edison Lamp Works, Harrison, N. J.

S. ROWSON, Ideal Films, Ltd., 76 Wardour St., London, W. 1, England.

E. I. SPONABLE, Fox-Hearst Corp., 460 West 54th St., New York, N. Y.

COMMITTEES

1929-1930

Convention

W. C. KUNZMANN, *Chairman*

J. W. COFFMAN

W. C. HUBBARD

M. W. PALMER

Journal

L. A. JONES, *Chairman*

R. S. BURNAP

J. W. COFFMAN

W. C. HUBBARD

H. T. COWLING

Membership and Subscription

H. T. COWLING, *Chairman*

C. BARRELL

L. W. DAVEE

I. ROSEMAN

J. W. BOYLE

J. DEFRENES

E. C. SCHMITZ

W. H. CARSON

E. R. GEIB

J. L. SPENCE

W. CLARK

J. KLENKE

F. ZUCKER

M. L. MISTRY

B. E. NORRISH

Papers

J. W. COFFMAN, *Chairman*

M. C. BATSEL

C. R. HANNA

G. E. MATHER

F. J. CADENAS

K. C. HICKMAN

R. F. NICHOLSON

J. A. DUBRAY

E. HUSE

J. B. TAYLOR

O. M. GLUNT

D. HYNDMAN

Progress

G. E. MATTHEWS, *Chairman*

J. A. BALL

R. E. FARNHAM

R. C. HUBBARD

W. CLARK

H. B. FRANKLIN

G. F. RACKETT

A. W. DANESHEW

K. GEYER

S. K. WOLF

J. B. ENGL

A. C. HARDY

Projection

N. M. LAPORTE, *Chairman*

H. W. DREYER

H. GRIFFIN

W. B. RAYTON

G. C. EDWARDS

R. H. McCULLOUGH

H. B. SANTEE

T. FAULKNER

W. A. McNAIR

L. M. TOWNSEND

C. GREENE

R. MIEHLING

D. F. WHITING

Publicity

W. WHITMORE, *Chairman*

F. C. BADGLEY

B. W. DEPUE

O. A. ROSS

G. E. MATTHEWS

G. F. RACKETT

SolicitationE. P. CURTIS, *Chairman*

J. W. COFFMAN

E. A. WILLIFORD

Standards and NomenclatureA. C. HARDY, *Chairman*

M. C. BATSEL

P. H. EVANS

W. B. RAYTON

W. H. CARSON

H. GRIFFIN

V. B. SEASE

A. DEBRIE

R. C. HUBBARD

T. E. SHEA

L. DEFOREST

L. A. JONES

J. P. SPENCE

J. A. DUBRAY

N. M. LAPORTE

E. I. SPONABLE

E. W. ENGSTROM

W. P. POWERS

L. T. TROLAND

G. F. RACKETT

Studio LightingA. C. DOWNES, *Chairman*

L. J. BUTTOLPH

R. E. FARNHAM

M. W. PALMER

K. C. HICKMAN

Theater LightingC. E. EGELER, *Chairman*

F. A. BENFORD

F. FALGE

E. HUSE

A. C. DOWNES

R. E. FARNHAM

L. A. JONES

C. GREENE

LONDON SECTIONSIMON ROWSON, *Chairman*A. NEWMAN, *Vice-Chairman*PAUL KIMBERLEY, *Manager*L. EVELEIGH, *Secretary*ALAN WILLIAMSON, *Manager*H. WOOD, *Treasurer*WILLIAM VINTEN, *Manager***PACIFIC COAST SECTION**P. MOLE, *Chairman*C. DUNNING, *Manager*G. F. RACKETT, *Sec.-Treas.*E. HUSE, *Manager***Membership Committee**J. COURCIER, *Chairman*

E. JEWELL

Papers and ProgramsE. HUSE, *Chairman*

LIST OF NEW MEMBERS AND TRANSFERS

- BERTRAM J. BACH (*Transfer to Active*)
Prov. of Ontario Pictures, Toronto,
Ont., Canada
- DONALD P. BENNETT (*A*)
Home Talkie Machine Corp., 220
West 42nd St., New York, N. Y.
- ROBERT CARULLA (*A*)
Fox-Hearst Corp., 460 West 54th
St., New York, N. Y.
- CHARLES W. GLOVER (*A*)
Abbey House, Westminster, London,
S. W. 1, England
- JAMES K. HALL (*A*)
Kodak, Ltd., Wealdstone, Middle-
sex, England
- NOTIS A. KOMNENOS (*A*)
Stanley Co. of America, 11th &
Market Sts., Philadelphia, Pa.
- HENRY V. LAWLEY (*M*)
The Lawley Apparatus Co., Ltd.,
26 Church St., Charing X Road,
London, W. 1, England
- GEORGE S. C. LUCAS (*A*)
British Thomson-Houston Co., Ltd.,
Rugby, England
- ALLEYNE W. MANCHEE (*M*)
Audio-Cinema, Inc., 161 Harris
Ave., Long Island City, N. Y.
- WALTER A. MACNAIR (*M*)
Bell Telephone Labs., Inc., 463 West
St., New York, N. Y.
- CARL HUBERT NIEPMANN (*A*)
Korting & Mathieson Electrical,
Ltd., 711 Fulham Road, London,
S. W. 6, England
- CLAUDE F. PARKINS (*A*)
Studio Film Labs., Ltd., 80 Wardour
St., London, W. 1, England
- GEORGE E. PATTON (*Transfer to
Active*)
Ontario Govt. Motion Picture Bu-
reau, Toronto, Ont., Canada
- ARTHUR J. SANIAL (*M*)
Fox-Hearst Corp., 460 W. 54th St.,
New York, N. Y.
- LAURENS A. TAYLOR (*M*)
General Electric Company, Schenec-
tady, New York
- CECIL V. THORNTON (*A*)
British International Pictures, Els-
tree, Herts, England
- JOHN A. TRANTHAM (*M*)
Standard Kine Labs., Inc., Rythe
Works, Thames-Ditton, England
- SYDNEY WAKE (*M*)
Standard Kine Labs., Ltd., 49
Greek St., London, W. 1, England
- ARTHUR J. WHITEHEAD (*A*)
Filmophone, Ltd., 101 Wardour St.,
London, W. 1, England
- WILL WHITMORE (*A*)
Western Electric Co., 50 Church St.,
New York, N. Y.

SOCIETY NOTES

The Bulletin.—The happenings of the Society to date have been published in the Society's *Bulletin* which has been issued at infrequent intervals. With the appearance of the new *Journal*, the publication of the *Bulletin* will be discontinued and the doings of the Society will be reported in these columns.

The Journal.—It is apparently not clear to several members that with the issuing of the new *Journal* the publication of the *Transactions*

will be discontinued. The Society members, of course, will receive twelve copies of the Journal instead of four issues of the *Transactions*. The domestic and foreign price of the Journal is \$12.00 per year to non-members and \$1.50 per copy to members or non-members.

Board of Governors Meeting.—At the last Board of Governors meeting held on November 8th in New York City, a large number of business matters were transacted including the following.

1. A final revision of the By-Laws was made which will be printed and circulated to the Active members previous to the spring convention when they will be voted upon for final approval.

2. It was resolved that for the time being no advertising material shall appear in the JOURNAL. Whether such a policy will be continued indefinitely will depend upon whether sufficient sustaining memberships can be obtained to take care of the financial necessities of the Society.

3. The duties of the Chairman of the Papers Committee were defined as follows. (a) To secure papers for regular meetings. (b) To approve papers prior to their presentation at meetings. (c) To supply abstracts in length not exceeding 10 per cent of the entire article for distribution by the Chairman of the Publicity Committee.

4. It was resolved that material approved by the Chairman of the Papers Committee and presented at a regular meeting cannot afterward be withheld from publication in the Society's Journal without the approval of the Board of Governors.

5. A motion was made and passed that papers presented at regular meetings shall not be published or circulated but shall be considered as the confidential property of the Society prior to their appearance in the JOURNAL.

6. It was resolved that the Board of Editors and Chairman of the Papers Committee shall prepare an instruction booklet for authors of manuscripts and that the Chairman of the Standards and Nomenclature Committee shall prepare and print in the JOURNAL a list of the complete standards adopted, with recommended practices and other material prepared by the Standards and Nomenclature Committee to date, and that 200 reprints of this booklet be prepared for distribution by the Secretary.

Solicitations Committee.—This committee under the chairmanship of Mr. E. P. Curtis, is endeavoring to secure sustaining memberships of \$100, \$500, or \$1000 which it is hoped the various concerns will take up in order to provide the Society with the funds necessary for conducting its business. The annual dues and entrance fees barely take care of the present expenses of the Society. It will be necessary to appoint a permanent editor to replace the temporary editor, Mr. L. A. Jones, but before this can be done a sufficient income must be secured to provide for a first class editor and manager who will

take over a large part of the routine work now done by the Secretary and Treasurer.

An Omission.—In the leaflet distributed with the ballot for a location for the spring meeting, the Convention Committee inadvertently omitted to acknowledge the assistance rendered by the Academy of Motion Picture Arts and Sciences during the Hollywood convention two years ago. The Academy not only placed their rooms at our disposal throughout the entire convention but Mr. Frank Woods and his assistants gave unstintingly of their time, while the banquet tendered by the Academy was unquestionably the finest formal function ever arranged in honor of our Society.

The Pacific Coast Section.—Under the capable and enthusiastic leadership of Mr. Peter Mole, the Pacific Coast Section is planning a series of important meetings for the coming year. The first meeting was held in the Norman Bridge Laboratory of Physics at the Pasadena Institute of Technology, when Dr. W. T. Whitney gave a talk on "The Nature of Light and Color." Although Pasadena is a considerable distance from Hollywood, an attendance of 65 was recorded. Lectures dealing with wide film, laboratory practice, stereoscopy, and television are planned for the future.

The London Section.—Our fellow members in London have been holding and plan to continue fortnightly meetings during the coming year. In the meeting rooms of the Royal Photographic Society on October 28th, Mr. Fetter gave a talk on "Some Aspects of the Western Electric Recording System." Thirty-seven were present.

On January 18th, Mr. Hodgson described a method of kaleidoscopic cinematography and this was followed by an open discussion on sound recording problems.

The London section is assisting the Historical Committee of the parent Society in securing data on the accomplishments of Mr. Eugene Lauste. Some of the members of the London section assisted in making some of Mr. Lauste's early apparatus.

Suggestions.—Although the business of the Society is conducted by the Board of Governors, they do not have a monopoly of ideas. Your president would greatly appreciate any suggestions from Society members. Suggestions on subjects for papers, the manner of conducting conventions, and material for publication in the JOURNAL are vitally necessary for the welfare of the Society and the Industry.

NOTICE TO MEMBERS

Please make sure that your name and address as they appear on our records are correct. Inspect the address label of the JOURNAL folder or the published membership list.

Names of those who were members prior to November 1, 1929, are published in the *Transactions*, Vol. XII, No. 37 (1929) p. 7.

Names of new members appear in this issue of the Journal.

In case of error kindly write at once to the secretary, Mr. R. S. Burnap, 5th and Sussex Streets, Harrison, N. J.

Membership Badge in white and gold—given each member upon payment of dues.



Replacements may be obtained from William C. Hubbard, *Treasurer*, at a charge of \$1.00.



This is to certify that

*is an member of the
Society of Motion Picture Engineers
organized for the advancement of engineering, scientific
and professional standards and for the standardization
of the mechanisms and processes in the production and
exhibition of Motion Pictures*

Secretary
New York, _____ 19__

Certificate of Membership in the Society of Motion Picture Engineers. Obtainable by Members from R. S. Burnap, *Secretary*, at a charge of \$1.00.

Membership

in the

Society of Motion Picture Engineers

is open to all who are engaged in any branch of the motion picture industry or allied work. The society is international in character and its convention papers with complete discussions are furnished free to members.

REASONS WHY

YOU

SHOULD JOIN

The Society of Motion Picture Engineers

- 1—The S. M. P. E. is an internationally recognized organization of Motion Picture Engineers.
- 2—The S. M. P. E. is becoming an ever more important factor in developing, stabilizing, and standardizing the motion picture industry.
- 3—At two conventions each year reliable data concerning a wide range of subjects are presented long before they become available elsewhere.
- 4—Papers read at conventions are printed with full discussions in a monthly Journal and distributed free to all members.
- 5—The S. M. P. E. affords unique opportunities for personal contact with leaders in the industry.
- 6—S. M. P. E. publications are recognized standard authority on Motion Picture Engineering.
- 7—The S. M. P. E. will help you in many ways. Join now.

COUPON

HERFORD TYNES COWLING, *Chairman*
Membership Committee, Society of Motion Picture Engineers
343 State Street, Rochester, N. Y.

Dear Sir—

Please mail application blank and requirements for membership in the S. M. P. E. to—

Name..... (Please print)

Position..... (Company or other Affiliation)

Street and City Address.....

Name.....

Position.....

Street and City Address.....



JOURNAL

OF THE SOCIETY OF

MOTION PICTURE ENGINEERS

LOYD A. JONES, EDITOR *pro tem.*

Associate Editors

G. L. CHANIER
O. M. GLUNT
A. C. HARDY

P. MOLE
W. B. RAYTON
P. E. SABINE

S. E. SHEPPARD
J. L. SPENCE
L. T. TROLAND

Volume XIV

MARCH, 1930

Number 3

CONTENTS

	Page
The Surface Treatment of Sound Film.....	
J. I. CRABTREE, OTTO SANDVIK, AND C. E. IVES	275
Characteristics of High Intensity Arcs.....	
D. B. JOY AND A. C. DOWNES	291
A Year of Sound.....	
HAROLD B. FRANKLIN	302
The Optics of Motion Picture Projectors....	
ARTHUR C. HARDY	309
Multiple Exposure Cinematography in Sound Pictures.....	
WILLIAM STULL	318
The Illusion of Sound and Picture.....	
JOHN L. CASS	323
Film Numbering Device for Cameras and Recorders.....	
M. W. PALMER	327
Water Cooling of Incandescent Lamps.....	
N. T. GORDON	332
The Development of Television and Radiomovies to Date....	
C. FRANCIS JENKINS	344
A New Method of Blocking Out Splices in Sound Film.....	
J. I. CRABTREE AND C. E. IVES	349
A Light Intensity Meter.....	
J. L. MCCOY	357
A New Synchronizing Apparatus for 16 Mm. Films with Disk Records.....	
WM. H. BRISTOL	361
Abstracts.....	366
Book Reviews.....	370
Officers.....	371
Committees.....	372
Resignations.....	374
Change of Address.....	374

Published Monthly by the
SOCIETY OF MOTION PICTURE ENGINEERS
20th & Northampton Sts., Easton, Pa.
Editorial Office: 343 State St., Rochester, N. Y.

Subscription to non-members \$12.00 per year, single copies \$1.50. Order from the Secretary of the Society of Motion Picture Engineers, 5th & Sussex Streets, Harrison, N. J.

Copyright
BY THE SOCIETY OF
MOTION PICTURE ENGINEERS

PERMANENT MAILING ADDRESS OF THE SOCIETY

Engineering Societies Building
29 West 39th Street
New York, N. Y.

Papers or abstracts may be reprinted if credit is given to the Journal of the Society of Motion Picture Engineers.

The Society is not responsible for statements made by authors.

Application pending for entry as second-class matter at the Post Office at Easton, Pa.

THE SURFACE TREATMENT OF SOUND FILM*

J. I. CRABTREE, OTTO SANDVIK, AND C. E. IVES

Practical experience has shown that with newly processed motion picture positive prints it is necessary to apply some form of lubricant to the film surface in order to facilitate the passage of the film through the projector. Sound record prints require similar lubrication in which case it is very necessary that the applied lubricant should not be the cause of extraneous noise in the projector-reproducer mechanism.

In an earlier communication¹ it has been shown that the so-called ground noise is due to scratches, dirt, dust, and finger marks on the film. It is therefore desirable to protect the sound record in such a manner that it is not damaged by the accumulation of those factors which are responsible for excessive ground noise. The problem of a suitable surface treatment therefore resolved itself into the devising of:

1. A suitable method of lubricating sound film which would not increase ground noise.
2. A method of treating either the entire film surface or the surface of the sound record area so as to reduce to a minimum its tendency to become scratched and accumulate dirt during projection and thereby retard the accumulation of ground noise on repeated projection.
3. If possible, a method of treatment combining methods 1 and 2.

I. THE LUBRICATION OF SOUND FILMS

Effects of Lack of Lubrication.—As stated in a previous communication² the gelatin emulsion of a newly developed positive print is very adherent to hot metal surfaces, and the adhesion of the film to the hot gate or pressure shoes in the projector causes small particles of gelatin to be rubbed off the film. Some of these particles become pressed together to form a crust which increases greatly the resistance to travel of the film through the gate. After these crusts form, the

* Communication No. 413 from the Kodak Research Laboratories.

¹ SANDVIK, OTTO: "A Study of Ground Noise," *Trans. Soc. Mot. Pict. Eng.*, **12**, No. 35 (1928), p. 790.

² CRABTREE, J. I., AND IVES, C. E.: "The Lubrication of Motion Picture Film," *Trans. Soc. Mot. Pict. Eng.*, **11**, No. 31 (1927), p. 522.

film is no longer held flat but oscillates in and out of the focal plane with the well-known "in and out" of focus effects. Also, since the film is in a condition of varying strain between the intermittent sprocket and the projection aperture, the projected picture is unsteady. A similar action at the sound aperture causes a flutter in the volume and frequency of the sound.

Effects of Wrong Lubrication.—A large quantity of paraffin or other wax applied to the edges of the film prevents adhesion between the film and gate surfaces but the wax falls off in flakes when the roll is rewound after being wound up in a warm condition. Particles of wax then lodge on the sound track with deleterious effects and accumulate in the reproducer slit or aperture, diminishing the volume of reproduced sound and in some cases cutting off the sound completely. Some treatments to which film is subjected for the supposed purpose of lubricating it have still worse effects and actually introduce noise and shorten the useful running life of the film.

A Satisfactory Method of Lubrication.—Previous work on the lubrication of motion picture film has shown that a suitable application of paraffin wax gives the best lubrication. In an earlier communication² on this subject a process of application of wax over the entire emulsion surface was described which required the use of a combined wax applicator and buffing machine. A mixture of paraffin and carnauba wax dissolved in a non-inflammable solvent was applied to the film surface which was then buffed, for otherwise the waxed surface remained dull and diffusing. This treatment was found to give a satisfactory degree of lubrication together with protection of the whole surface against abrasions and oil markings.

This treatment is not ideal for sound prints, because, in order to obtain a high degree of lubrication, it is necessary to use a large proportion of paraffin and this produces a surface which is rather susceptible to finger markings and which collects dust particles readily. It resists scratching, however, and dirt and scratches are largely confined to the wax layer which can be removed by a cleaning solvent.

The present method of applying a thin line of molten wax along the edge of motion picture film is open to the following objections:

1. The quantity of wax applied is not readily capable of control.
2. The wax is applied in a narrow, but thick ridge, which must be spread out by the pressure pads in the projector.
3. The method is subject to certain accidents in operation which render its use less dependable than could be desired. If the waxer is used before the wax is sufficiently warm or if a draft of cold air strikes

the applicator, the viscosity of the wax is increased by virtue of being cooled and too much wax is applied.

It was found that paraffin wax could be applied to the perforation area of motion picture film in the form of a solution of the wax in a non-inflammable solvent such as carbon tetrachloride. It is not necessary to buff the waxed film in this area after evaporation of the solvent because the optical condition of the edge is of little importance.

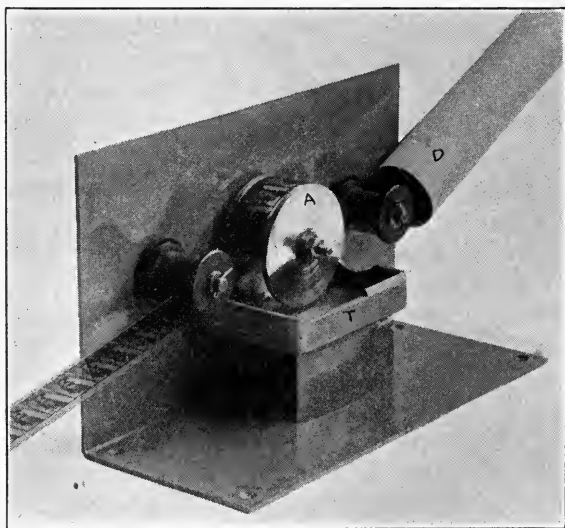

FIG. 1. The wax solution applicator.

The thickness of the applied film can be controlled readily by changing the concentration of the solution.

In order to test the suitability of this method, various concentrations of the paraffin solution were applied to sound record prints and these were tested by running through a projector-reproducer machine and noting whether wax flaked off or accumulated in the machine. Similarly treated samples were run on projection machines until complete breakdown of the film in order to determine their comparative resistance to wear.

Equipment for Application of Wax Solution.—The first device used for application of the wax solution to the edges of motion picture film consisted of two smooth, steel disks which dipped partly in the wax solution contained in a small tank. The film was led over these disks

with the emulsion side down and then carried through the air for a sufficient distance to permit the carbon tetrachloride to evaporate completely before the wind-up was reached. The applicator rollers were driven by the film passing over them. No other roller was permitted to touch the edges of the film, where the paraffin had been coated, until the solvent was completely evaporated. A photograph of this equipment is shown in Fig. 1. The film is held by the idler rollers against the applicator disks (*A*) which dip into the solution in tank (*T*). The film travels from left to right and passes directly into the drying tube (*D*) through which a stream of warm air is passed in the direction opposite to the film travel. In this tube the carbon tetrachloride is evaporated rapidly. The film next enters a similar tube through which cold air is forced, in order to solidify the paraffin which is soft when it leaves the hot tube. Disks of various widths were tried and a width of 0.15 inch was finally chosen. It was considered advisable to apply the lubricant to as much of the area requiring lubrication as is possible without encroaching on the sound track. If the applicator roller extends 0.15 inch inward from the edge of the film these conditions are satisfactorily fulfilled.

When this equipment was first tried the disks were so mounted as to turn freely on the shaft and were driven by the film, which was drawn through the device by a drive roller located after the drying tubes. With this method of driving some difficulty was experienced as a result of the application of too much solution. Experiments were made with other applicator surfaces and means for driving the applicator disks. The preferred method of application was by means of the above steel disks so driven that their peripheral speed was one-half to one-quarter of the film speed.

Satisfactory disks were also constructed by clamping a disk of leather or other porous fibrous material between two thin metal disks of slightly smaller diameter.

Quantity of Paraffin Applied.—Concentrations of paraffin in carbon tetrachloride varying from 10 to 0.5 per cent were applied to developed positive motion picture film. If the solution was applied in considerable quantity, concentrations of one per cent or greater dried very slowly. If the concentration was less than one per cent drying was not difficult, a few feet of drying tube being sufficient.

Table I shows the results of wear and tear tests made on film lubricated by the method described above in comparison with an untreated sample and two samples lubricated with molten paraffin.

No method of lubrication has been found which gives longer projection life before complete breakdown of the film than the molten paraffin treatment used for comparison in these tests but the projection life is as great with the paraffin solution treatment as with the molten wax method.

A small amount of wax accumulated in the projector gate when a film treated with a solution which applied 0.3 gram of paraffin per 1000 feet of film was projected. This amount was therefore considered somewhat excessive even though no evidence was given that any interference with sound reproduction might come from it. There-

TABLE I
Results of Wear and Tear Tests

Method of Lubrication	Wearing Properties
None	100%
Molten paraffin test No. 1	408%
Molten paraffin test No. 2	380%
Paraffin solution	
0.15 gram wax per 1000 ft. film	407%
0.30 gram wax per 1000 ft. film	423%

fore, the safe limit was considered to be 0.15 gram per 1000 feet of film. It will be seen from the table that the degree of lubrication given by this quantity of paraffin is equal to that given by 0.3 gram within the error of measurement.

Control of the Rate of Application of Wax.—The concentration of the wax solution to be used depends largely upon the quantity to be applied, although there are definite practical limits to the useful concentration. When using the applicator as first built, that is, with the disks running at the same peripheral speed as the film, a rather large volume of liquid was applied so that it was necessary to use a dilute solution (0.25 per cent). This method was discarded because the liquid accumulated in drops which dried slowly and showed some tendency to run out of the perforation area. When the apparatus was so modified that the peripheral speed of the disks was less than the speed of travel of the film, less liquid was applied and it was necessary to use a stronger solution (one per cent). With the more even distribution of the liquid produced by the rubbing effect where slippage occurred between the film and disks, the coating dried very easily. With the hot air tube three feet long and the cold air tube

about four feet, and with five feet of travel in the open air, the machine could be operated at a speed of fifty feet of film per minute.

With the applicator blades traveling at one-third this speed, the quantity of solid wax applied amounts to only about 0.10 gram per 1000 feet of film. Projection tests with such lubricated films showed that the wax did not encroach on the sound track nor did it tend to accumulate in the aperture of the reproducer mechanism, thus fulfilling requirement No. 1 outlined on page 275.

II. SURFACE TREATMENT TO RETARD ACCUMULATION OF GROUND NOISE

In order to determine the type of material that appeared most promising from the standpoint of surface protection, several groups of materials were selected differing widely in their physical properties. These can be classified as materials which when applied in thin layers to the film emulsion formed a hard surface, such as various types of lacquers, or a smooth and more or less plastic surface such as is given

TABLE II
Treatment Accorded Film Samples

Sample	Treatment
91 92 93 102	Surface waxed with 1.0% cantol wax in carbon tetrachloride, buffed, and edge-waxed with a solution of paraffin in carbon tetrachloride
94 95	Buffed and edge-waxed with 1.0% solution of paraffin in carbon tetrachloride
96 97	Edge-waxed in 1.0% solution of paraffin in carbon tetrachloride
100 101	Cantol surface waxed with 0.25% cantol wax in carbon tetrachloride
103	Plain film
106 107	Oiled with a 2.0% solution of light motor oil in carbon tetrachloride and buffed
110 111 112	Treated with special lubricant containing 0.9% paraffin wax and 0.5% light motor oil dissolved in carbon tetrachloride

by various types of waxes and oils. Experiments were also made on hardening the surface by treating it with formalin solutions. The ground noise of these samples was then measured in a manner similar to that described in an earlier communication.¹ After measurement, the samples were cinched by winding the film into a loose roll and

pulling it up tight on the core or by pushing the roll out from the center into a cone. These procedures, called longitudinal and conical cinching, respectively, provide a quick and fairly dependable method for determining the wearing quality of the film. The noise level of the samples was again measured after cinching.

Ground noise increased only slightly after cinching the plain buffed film, thus showing that this treatment renders the film surface less susceptible to scratches and abrasions. Hardening the gelatin by bathing in a solution of formalin did not reduce the rate of accumulation of ground noise. Three different lacquers were also tested but were not found beneficial. Solution edge-waxing showed a slight protective effect but treatment of the whole emulsion surface with oils and waxes gave the best results.

From these preliminary experiments the processes showing most promise from the standpoint of retarding the rate of accumulation of ground noise were selected for a more extensive investigation. For this purpose, a number of samples of motion picture positive film two hundred feet long were processed in the regular manner and treated as indicated in Table II.

The Waxing and Buffing Operation.—The combined operation of applying a solution of wax in a volatile solvent to the emulsion surface of the film and then buffing the waxed surface to produce a high gloss has been described and illustrated in a previous paper.² The operation is briefly as follows. The film is passed over a revolving roller which is continuously wetted with a dilute solution of the wax in carbon tetrachloride. This solution dries on the film immediately and the emulsion surface is then polished to a high gloss by the action of four cloth buffers. Film is treated in this process at the rate of about 30 feet per minute.

The Buffing Operation.—In the buffing operation the wax application is omitted. A noticeable gloss is imparted to the film surface under these conditions.

The Edge Lubrication.—In the tests tabulated above, application of a 1.0 per cent paraffin solution to the edge of the film was carried out as described in Part I. This treatment applied about 0.3 gram of paraffin per 1000 linear feet of film.

Noise Level Tests with Projected Films.—The noise level of each of these samples was measured in the customary manner.¹ Each sample was projected ten times and rewound after each projection with a constant speed rewind. The projector was rechecked at frequent

intervals to insure that it was working properly and that the pressure shoes and other parts were in correct adjustment. After ten projections each sample was remeasured. After ten runs, the samples were divided into groups for further treatment, as indicated in Table III.

TABLE III
Treatment of Various Samples after Ten Runs

Sample	Treatment
91	Wiped with clean plush
92	Cleaned on the cleaning machine with carbon tetrachloride
94	
96	
98	
100	
106	
110	
112	Cleaned on the cleaning machine with carbon tetrachloride and the original treatment repeated with each sample
93	
95	
97	
99	
101*	No treatment
107	
111	
102	No treatment
103	

* This sample was not cleaned but merely bathed with the original treating solution.

The Cleaning Operation.—Cleaning of the test samples was carried out with a slightly modified cleaning machine described previously.³ The modification consists in the use of two tanks of cleaning solution instead of one. The film passes from the feed reel with the emulsion face downward into the first tank *A*, Fig. 2, under an idler roller and over the plush covered roller *P*, then under a second idler, and then out of this tank. The plush covered roller is driven by the film and is partially immersed in the cleaning liquid. As it revolves at a very high speed it throws a shower of solvent against the film. Also the pressure between the film and the roller wrings the liquid out of the cloth and forces it along the film surface. In this way a very gentle

³ CRABTREE, J. I., AND CARLTON, H. C.: "Cleaning Liquids for Motion Picture Film," *Trans. Soc. Mot. Pict. Eng.*, **11**, No. 30 (1927), p. 277.

but thorough scouring is given to the emulsion surface. At the point where the film leaves the first tank a single squeegee is located to prevent the more or less dirty liquid being carried in a large quantity into the tank *B*. New cleaning liquid is introduced in tank *B* and then transferred to tank *A* so that the film is finally rinsed in clean liquid.

Each sample, except Nos. 102 and 103, was again measured and the procedure repeated after projecting for 20, 30, 40, 50, 82, and 130 times, respectively.

The results of these measurements are shown in Table IV where the time level of a 2000 cycle constant frequency as 100. When the film

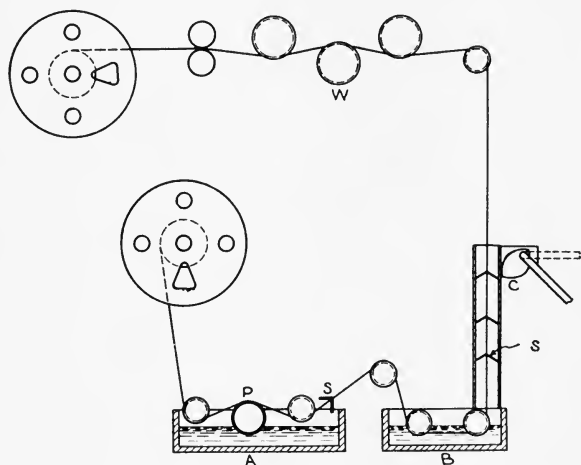

FIG. 2. Diagram of the cleaning machine.

relative ground noise volume levels are expressed in terms of the vol-samples were being measured, this constant frequency was measured at frequent intervals, as a check on the constancy of the photo-cell and the amplifier.

The excellence of the different treatments included in Table IV is shown in Table V in the order of their decreasing merit.

The values in Table IV are expressed graphically in Fig. 3. From the curves and Table IV it is seen that samples Nos. 91, 93, 102, 107, and 111 were very satisfactory and much better than any of the others. Sample No. 102 (cantal wax, buffed, and solution edge-waxed) shows the very permanent protective effect found in the preliminary study. It is noteworthy that this sample was neither cleaned nor re-treated. Also, a clean dry plush can be used repeatedly for cleaning this surface

without harm as shown by test No. 91. Excellent results were also obtained by cleaning and re-treating a film originally treated with cantol wax, buffed, and solution edge-waxed although, if a film is not given abusive treatment during use, this repeated treatment should not be necessary.

The results shown by tests Nos. 107 (oil treated and buffed) and 111, in which a solution of oil and paraffin wax was used instead

TABLE IV
Relative Ground Noise Intensity
Number of Runs

Sample	0	10	20	30	40	50	82	130
CF	100	100	100	100	100	100	100	100
91	0.30	0.45	0.70	0.78	0.90	0.92	1.03	1.20
92	0.37	0.50	0.63	0.75	1.10	2.20	3.60	5.13
93	0.45	0.77	0.90	0.98	1.05	1.10	1.25	1.45
94	0.27	0.60	1.45	3.65	4.77	5.50	6.80	7.75
95	0.30	0.80	1.12	1.35	1.56	1.75	2.25	2.83
96	0.20	1.75	2.65	3.30	3.82	4.35	5.85	7.90
97	0.30	1.48	2.45	3.20	3.85	4.40	5.86	7.45
100	0.45	0.95	1.65	2.45	3.22	3.93	6.01	8.90
101	0.28	2.02	2.60	2.83	2.94	3.03	3.20	3.33
102	0.30	0.48	0.61	0.75	0.85	0.93	1.10	1.25
103	0.50	3.45	4.67	5.47	6.02	6.43	7.30	8.05
106	0.50	0.90	2.35	3.45	4.28	4.85	5.81	6.33
107	0.32	0.88	1.05	1.14	1.20	1.25	1.30	1.37
110	0.50	1.35	3.35	4.63	5.45	6.07	7.45	8.87
111	0.43	0.92	1.00	1.00	1.00	1.00	1.00	1.00
112	0.65	1.40	2.85	4.03	4.93	5.55	6.72	7.53

of the oil solution, were very satisfactory. Such processes, however, involving frequent re-treatments are objectionably complicated.

Preliminary study has shown that oily coatings tend to accumulate dirt somewhat rapidly and this is shown by a study of sample No. 107 before and after treatment.

Sample No. 92 is a rather interesting case in that a sufficient quantity of wax and paraffin remained on the film to offer protection until the fourth cleaning after which the ground noise increased to such an extent that a repetition of the original treatment was considered imperative after three cleanings.

It was concluded that the best treatment consisted in the application of a solution of cantol wax to the entire emulsion surface, buffing

to a high gloss, and then coating a solution of paraffin on the edges for lubrication.

Sample No. 95 which was simply buffed and then edge-waxed with a paraffin solution is the next in order of choice. This sample was cleaned and re-treated after every ten runs.

As a third choice, No. 101, which was merely bathed on the cleaning machine in a solution of carbon tetrachloride containing 0.25 per

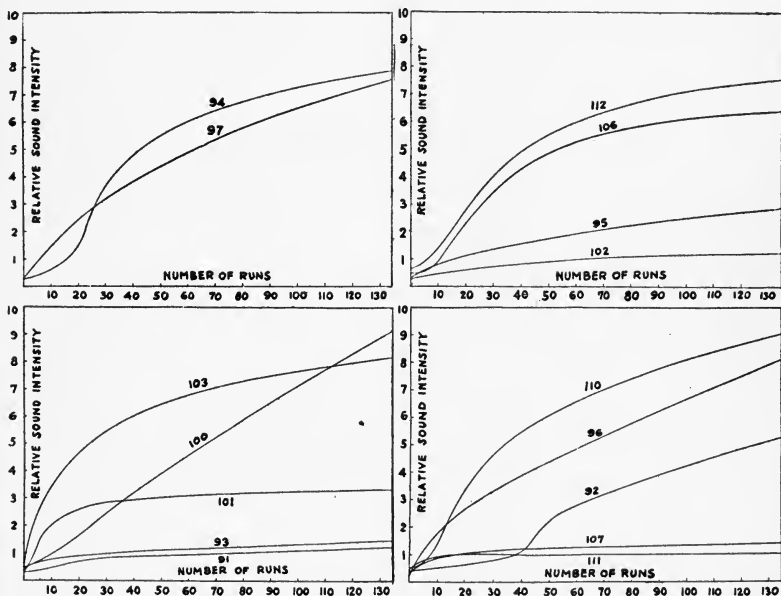

FIG. 3. Curves showing change in relative ground noise volume level with continued projection.

cent of cantol wax when new and cleaned in the same solution after every ten projector runs, offers a moderate degree of protection without requiring the use of a polishing machine in the first treatment or in the after treatments.

A slight degree of protection was effected by the treatments indicated in Table VI.

It is noteworthy that with the edge lubrication treatment (Nos. 96 and 97) there was a definitely lower rate of ground noise accumulation than with an untreated film (No. 103).

No protection whatever could be noticed in the case of sample

TABLE V
Comparative Value of Various Treatments

Sample	Treatment
102	Cantol buffed-Sol—No after treatment
91	Cantol buffed-Sol—Wiped with plush
111	Special lubricant—Re-treatment*
93	Cantol buffed-Sol—Re-treatment*
107	2.0% oil buffed—Re-treatment*
92	Cantol buffed-Sol—Clean
95	Plain buffed-Sol—Re-treatment*
101	0.25% cantol—no buff—Re-treatment**
106	2.0% oil buffed—Clean only
96	Sol—Clean
97	Sol—Clean and Re-treatment*
100	0.25% cantol—no buff—Clean
94	Buffed-Sol—Clean only
112	Special lubricant—not buffed—Cleaned every 10 runs
103	Plain film

* Re-treatment signifies that the sample was cleaned as described and then given the original treatment after every ten projection runs.

** Re-treatment consisted only of cleaning in a bath having the same formula as the original treating solution.

Sol indicates edge-waxing with solution of paraffin wax in carbon tetrachloride.

No. 112 after the first ten runs. This is undoubtedly because the oily protective surface was removed in the subsequent cleaning operations.

The results shown in the case of sample No. 94 would not favor the use of plain buffing with solution edge-waxing if the film was cleaned with carbon tetrachloride after every ten runs without re-waxing.

The ground noise of sample No. 103 which received no treatment increased very rapidly in comparison with that of the tested samples.

TABLE VI
Treatments Giving Slight Protection

Sample	Description
96	Solution edge-waxed—Cleaned after every 10 runs
97	Solution edge-waxed—Cleaned and re-treated after every ten runs
100	Bathed in 0.25% solution of cantol wax—Cleaned after every 10 runs
106	Oil buffed—Cleaned after every 10 runs

In Table VII the relative noise levels in decibels of each sample is expressed in the terms of the volume level of the constant frequency. This table shows for each case how much additional amplification is required for the sound volume to equal that of the constant frequency record. The constant frequency record was of variable area type and of about 80 per cent modulation which of course is higher than the *average modulation* in a record of music or speech. On the other hand,

TABLE VII
Volume Level in Decibels
Number of Runs

Sample	0	10	20	30	40	50	82	130
91	-25.2	-23.5	-21.5	-21.1	-20.5	-20.4	-19.9	-19.2
92	-24.3	-23.0	-22.0	-21.2	-19.6	-16.6	-14.4	-12.9
93	-23.5	-21.1	-20.5	-20.1	-19.8	-19.6	-19.0	-18.4
94	-25.7	-22.2	-18.4	-14.4	-13.2	-12.5	-11.7	-11.1
95	-25.2	-21.0	-19.5	-18.7	-18.1	-17.6	-16.5	-15.5
96	-27.0	-17.6	-15.8	-14.8	-14.2	-13.6	-12.3	-11.0
97	-25.2	-18.3	-16.1	-14.9	-14.1	-13.6	-12.3	-11.3
100	-23.5	-20.2	-17.8	-16.1	-14.9	-14.0	-12.2	-10.5
101	-25.5	-16.9	-15.9	-15.5	-15.3	-15.2	-15.0	-14.8
102	-25.2	-23.2	-22.1	-21.2	-20.7	-20.3	-19.6	-19.0
103	-23.0	-14.6	-13.3	-12.6	-12.2	-11.9	-11.4	-10.9
106	-23.0	-20.4	-16.3	-14.6	-13.7	-13.1	-12.4	-12.0
107	-24.9	-20.6	-19.8	-19.4	-19.2	-19.0	-18.9	-18.6
110	-23.0	-18.7	-14.8	-13.3	-12.6	-12.2	-11.3	-10.5
111	-23.7	-20.4	-20.0	-20.0	-20.0	-20.0	-20.0	-20.0
112	-21.9	-18.5	-15.5	-13.9	-13.1	-12.6	-11.7	-11.2
CF	0.0	0.0	0.0	0.0	0.0	0.0	0.0	0.0

the noise level of the best samples is twenty-one decibels down after eighty runs leaving a good margin between signal level and noise level. The noise level of the untreated film, however, is only ten decibels down after eighty runs, in which case the noise would be very objectionable. The values of Table VII are shown graphically in Fig. 4. It is well to emphasize at this point that in actual practice the ratio of signal level to noise level would be considerably greater than that shown in this table. The measuring system used responds to a much greater range of frequencies than any actual sound reproducing system. These measurements therefore include a large amount of noise which would not be reproduced. Also, since these measurements were made on clear film, the noise level is somewhat enhanced.

SUMMARY AND PRACTICAL RECOMMENDATIONS

Sound record prints can be satisfactorily lubricated by applying a thin coating of a solution of paraffin wax in carbon tetrachloride along the edges of the film in the perforation area and drying. This treatment is superior to the application of solid or molten wax inasmuch as the wax does not flake off or encroach on the sound track during re-winding or projection, which would produce ground noise.

The application of the wax is accomplished by means of two steel disks which dip into the wax solution. The disks should be about 0.15

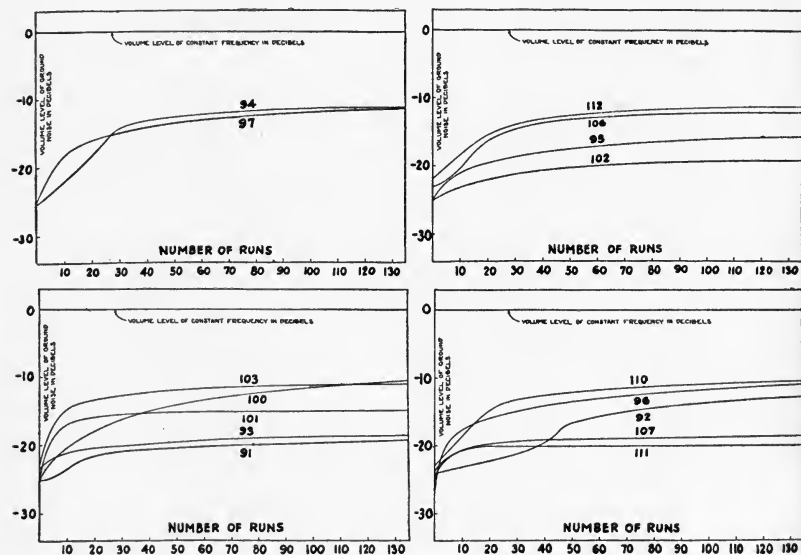

FIG. 4. Curves showing change in relative ground noise volume level in decibels.

inch wide and so spaced that they are in contact with the film from the edge inward 0.15 inch so that the area lubricated will correspond closely with that under the tension shoes in the projector gate. The quantity of wax applied is varied by changing the rate of rotation of the disks in relation to the speed of the film. For a film speed of 50 feet per minute, a disk 3 inches in diameter should so rotate that its peripheral speed is about one-third this value when immersed one-half inch in a 1.0 per cent solution of the wax. The quantity of wax thus applied is about 0.30 to 0.35 gram per 1000 linear feet of film. For higher speeds, the wax solution should be applied to the disks in a suitable manner, such as by means of an application roller dipping into the wax solution. After application the solvent is quickly evapo-

rated by passing the film through a short narrow tube through which a current of air at 120° F. is blown.

An alternative method of lubrication is to apply a 1.0 per cent solution of light motor oil in carbon tetrachloride to the entire film surface and then buff in a manner as described previously.²

In addition to providing satisfactory lubrication, it is desirable to treat sound record prints in such a manner that the film will have during handling a minimum tendency to accumulate scratches, dirt, dust, and finger marks which in turn cause ground noise. Several suitable methods of treatment have been evolved, the most satisfactory of which consists in applying a one per cent solution of cantol wax to the entire emulsion surface of the film, buffing, and edge-waxing as described above. The cantol wax provides a hard smooth surface which in itself has poor lubricating properties but the edge-waxing supplies the necessary lubrication. A film treated in this manner eventually becomes scratched but the scratches are usually confined to the wax coating and do not reach down to the silver image so that by removing the wax coating at intervals by cleaning with carbon tetrachloride and re-waxing, the image is maintained clean and free from scratches.

Three machines are necessary for the above treatment, namely: (a) the waxing and buffing machine, (b) the edge-waxing machine, and (c) the cleaning machine. Machine (b) can be attached to the end of machine (a) but it would be inefficient to attach machine (c) to machine (a) plus (b) because the former can be run at a speed of 200 feet per minute while it would not be desirable to run machine (a) at a speed greater than 30 feet per minute unless more buffing wheels were attached.

Although in some of the experiments outlined the treated film was cleaned and re-treated after projecting 10 times, in practice this routine is usually not necessary, the treated film requiring cleaning only when indicated by the presence of visible dirt, oil spots, or excessive ground noise. In the case of the tests with the cantol buffed and edge-waxed sample, after projecting 130 times without further treatment of any kind the magnitude of the ground noise was only slightly greater than at the start. The projectors were kept in a very clean condition throughout the tests. This test demonstrates that it is possible to keep the projector sufficiently clean and the rewinder free from dust so that with film treated in the manner outlined no excessive ground noise is produced after 130 runs.

In the absence of the surface waxing treatment with newly processed prints it is imperative either to edge-wax as recommended or to pass the film through a cleaning machine using a 0.5 per cent solution of light motor oil in carbon tetrachloride in the second tank, the first tank being by-passed. This treatment will apply a thin film of lubricating oil to the entire film surface which will assist in preventing the accumulation of ground noise although, in view of the slightly tacky nature of the oiled surface, the film will accumulate dust and dirt more rapidly than cantol waxed film and will require cleaning and retreating frequently.

The authors are indebted to Mr. D. E. Hyndman for assistance in the experimental work.

Note.—Since the above experiments were completed it has been found that sound record film may be satisfactorily edge-waxed by using a 10 per cent solution of paraffin in carbon tetrachloride and rotating the application disks so that the peripheral speed is about one-twelfth the speed of the film. With this procedure no auxiliary drying apparatus is necessary.

DISCUSSION

MR. DICKSON: Did you run samples of film through the carbon tetrachloride forty or fifty times in these tests?

DR. SANDVIK: No, we cleaned some of the samples as many as seven times.

MR. DICKSON: Does treatment with carbon tetrachloride make the film brittle?

MR. CRABTREE: If carbon tetrachloride is pure, and reputable commercial samples are pure and free from sulphur, the film is not affected. If sulphur compounds are contained in it, the image is eventually toned brown.

MR. RICHARDSON: Recently I received a complaint from a New York City exhibitor that his projectors were continually damaging film. I found that the aperture tension was abnormally high—so high that 145 feet of film per minute could be projected with no over-shooting. High tension is the primary cause of excessive film wear and of the deposition of emulsion on the tension shoes. This difficulty could be remedied by the projector manufacturer. If he would provide a tension adjustment, theaters requiring a ninety foot per minute projection speed would not abuse the film to the extent they now do.

MR. CRABTREE: I don't know whether Mr. Richardson heard the first part of the paper. The object of the treatment is to enable you to get "green" film through the projector, and this method ensures that you cannot get too much wax on it. Molten wax is all right if it is put on correctly but usually it is not. The second object is to prevent the accumulation of ground noise, which you notice could be produced by conically cinching the film. The matter of the tension of the shoes has nothing to do with this.

CHARACTERISTICS OF HIGH INTENSITY ARCS

D. B. JOY AND A. C. DOWNES*

INTRODUCTION

The amount of light used at the aperture plate of the motion picture projector has steadily increased until at the present time only the high intensity arc can furnish the light concentration necessary to satisfy the demands of the larger theaters. Recent changes which have been made and rumors of others about to occur in the motion picture industry have again emphasized the constant demand for more light on the screen of the theater. It therefore seems desirable to call attention to certain characteristics of high intensity arcs which may help in the solution of the ever present problem of increasing the useful light.

The light from a high intensity arc emanates from two distinct sources, the crater and the tail flame. The tail flame produces about thirty per cent of the total light from this type of arc but is of no value for projection because it cannot be focused on account of its large size, shape, and position. Therefore, in a consideration of the characteristics of the high intensity arc only the crater light should be studied. The characteristics should include candle power both directly in front of the arc and at various angles, the area of crater opening, intrinsic brilliancy, and spectral energy distribution for the various carbon sizes and operating currents.

The literature^{1 to 8, inc.} contains angular distributions of candle power, spectral energy curves, and values of intrinsic brilliancy, but in many cases the conditions under which they were obtained and the identification of the carbons are not clear. The spectral energy distribution curves for high intensity arcs given in the *Bureau of Standards Scientific Paper No. 539* were obtained at the given currents and voltages but include the tail flame light. These curves are therefore only of value as a means of comparison, for practically none of the tail flame is picked up by the optical system of the high intensity equipment used for the projecting or taking of motion pictures.

* Research Laboratories of National Carbon Co., Inc., Cleveland, Ohio.

EXPERIMENTAL PROCEDURE

An arrangement for measuring the candle power and intrinsic brilliancy of the high intensity arcs is shown in Fig. 1. The arc is placed directly facing the comparison plate *D*. Between the arc and comparison plate are the shields *A* and *B*. *C* is a black box which contains the comparison plate.

The light from the crater passes through the holes in screens *A* and *B*, and is reflected from the comparison plate *D* to the Macbeth illuminometer *E*. The function of screen *A* is to cut out the light from the tail flame, negative carbon, and negative arc stream. The hole in this screen is approximately 1 to 2 millimeters larger in diameter than the crater. This allows clearance enough to take care of any

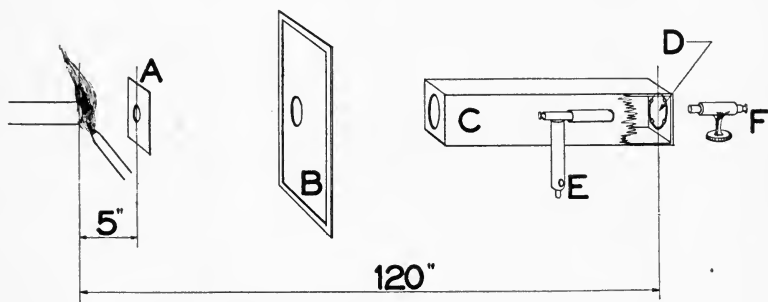

FIG. 1. Apparatus for measuring crater light.

slight change in position of the positive carbon while rotating, and gives a clear field approximately 1.5 inches in diameter on the comparison plate. The light from the small part of the tail flame which is included by this clearance is negligible. This was demonstrated by tests with larger and smaller openings in screen *A*. Screen *B* shields the operator of the illuminometer from the crater light. The hollow tube projecting from the side of the box furnishes the necessary opening for the illuminometer. The correct position of the crater with respect to screen *A* and the comparison plate is checked by means of the substitution of a false back with an opening slightly larger than the field of view of the comparison plate, and a telescope *F* placed at the back of the opening, as shown in the figure. The angular distribution in a horizontal plane was obtained by rotating the lamp about the crater as the axis. The size of the crater opening was obtained by measuring the craters of carbons which had been

burned at the various currents. The intrinsic brilliancy was calculated from the above data by the usual method.

The spectral energy distribution curves were made with practically the same set-up for excluding light other than that from the crater. They were made with a quartz spectroradiometer used in connection with a thermopile with calibrated transmission screens,

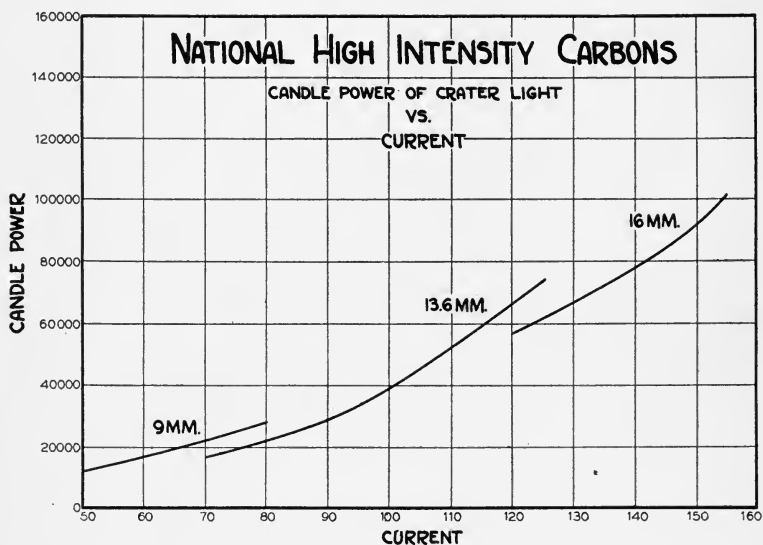

FIG. 2. Candle power of crater light vs. current.

according to the procedure described by Coblenz⁶ and Greider and Downes.⁹

DISCUSSION OF RESULTS

The candle power of the crater light directly in front of the arc is shown in Fig. 2. As would be expected the candle power increases with the current. When the same current is used on two different size carbons of the same composition, the smaller size carbon, that is, the one with the higher current concentration, gives the greater candle power.

The crater light is only approximately 68 per cent of the total light from the high intensity arc as measured directly in front of the crater. The additional light comes almost entirely from the tail flame which streams out of the positive crater.

The candle power as well as the steadiness of operation is affected

by the angle and relative position of the negative carbon with respect to the positive crater and by the voltage maintained across the arc. The angle is usually fixed by the construction of the lamp. The best results were obtained when the relative positions of the negative carbon and positive crater were such that the negative flame just brushed the lower edge of the positive crater as shown in Fig. 3-A. If the negative flame bathed the lower outside of the positive crater appreciably, as shown in Fig. 3-B, the candle power decreased probably because some of the current was taken on the outside of the positive crater thus lowering the current and energy concentration on the inside of the crater. If the edge of the negative flame were considerably ahead of the lower edge of the positive crater as shown in Fig. 3-C, it would not have as much tendency to keep the hot gases in the

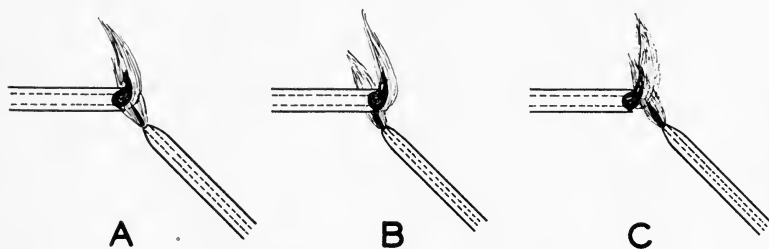

FIG. 3. Effect of position of negative.

crater and would result in a lower candle power. It was found in the case of the 16 mm. carbons in the current range of 140–150 amperes, which is ordinarily used, that the best arc voltage was 73–83 volts. Below this voltage the negative was so close to the positive that the negative flame appeared to impinge on the hot gases in the positive crater with such force as to actually drive them out with a consequent unsteadiness and loss of light. Above this voltage the negative was so far away from the positive that the negative flame apparently lacked the necessary force to confine the gases in the positive crater and caused a loss of light from the crater area. With lower currents, lower voltages can be used.

The 13.6 mm. carbons in the current range of 110–125 amperes operated best at approximately 67–73 volts and the 9 mm. carbons in the current range of 60–70 amperes operated best at 48–55 volts. In general, if lower currents are used, the voltage should be correspondingly decreased. The effect of lower and higher voltages with the

9 mm. and 13.6 mm. carbons is the same as with the 16 mm. carbons although to a somewhat smaller degree.

The angular distributions of candle power from the positive craters of 9, 13.6, and 16 mm. carbons in the horizontal plane in a total angle of 80° are given in Fig. 4 for a number of different currents. The

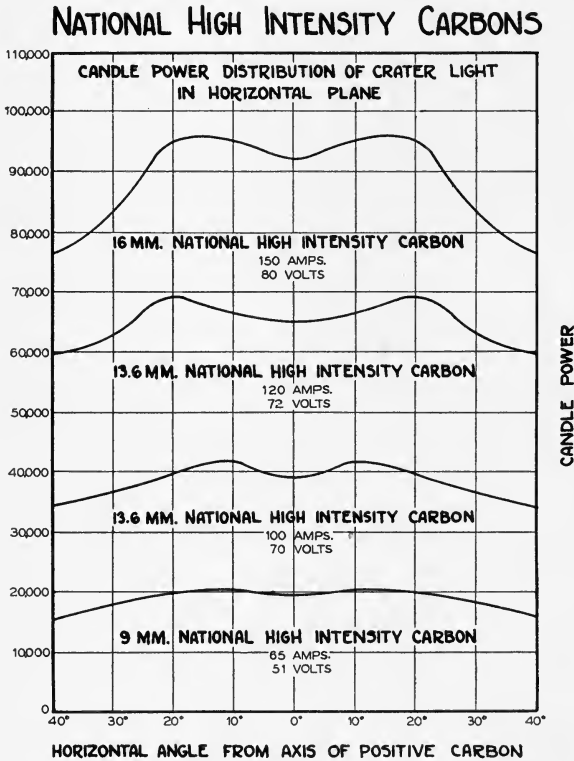

FIG. 4. Angular distribution of candle power from positive craters of various carbons.

candle power is slightly lower directly in front of the crater than at 10° to 20° on either side. The candle power holds up remarkably well to the 40° limit measured and is only 10 to 17 per cent lower at 40° than at the center. This accounts for the decided increase in the useful light from the high intensity arc when a mirror or condensers of large effective angle¹⁰ are substituted for the old style condensing lenses of small effective angle.

The light distribution is approximately the same for the different

sizes of carbons and the different current values investigated as is clearly shown in Fig. 4.

The areas of the crater openings of the different size carbons at the various currents are given in Fig. 5. The cross-sectional areas of the 9 mm., 13.6 mm., and 16 mm. high intensity carbons are 64 sq. mm., 145 sq. mm., and 201 sq. mm., respectively. It is obvious from the curves that the crater openings for even the higher currents are much less than the original carbon cross-section.

The decrease in crater opening for the lower current densities is

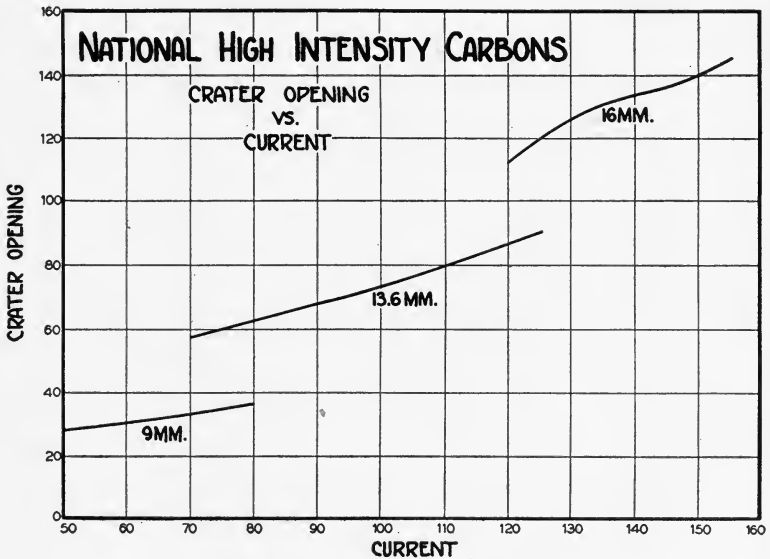

FIG. 5. Crater opening vs. current.

due in part to the increased spindle or tapering of the portion of the carbon projecting from the positive holder. This increased tapering is due to the enormous decrease in the length of carbon consumed per unit of time for a small decrease in current which allows a longer time for the hot surface of the carbon close to the crater to burn away.

The size of the crater opening or light source of the high intensity carbons is important in considering the application of any optical system for it has long been recognized and clearly demonstrated before this Society^{11,12} that the light efficiency for motion picture projection decreases rapidly as the area of the light source increases.

The intrinsic brilliancies in candle power per square millimeter of

crater opening have been calculated from the above values of candle power and crater opening and are plotted in Fig. 6. As in the case of the candle power, the intrinsic brilliancy increases very rapidly as the current is increased on any given size carbon. The values come within the range of those given in the literature.^{1,7} It is believed, however, that this is the first time that data showing the change in intrinsic brilliancy for the currents and sizes of high intensity carbons have been compiled. It is interesting to note that practically the same intrinsic brilliancies are obtained with the various

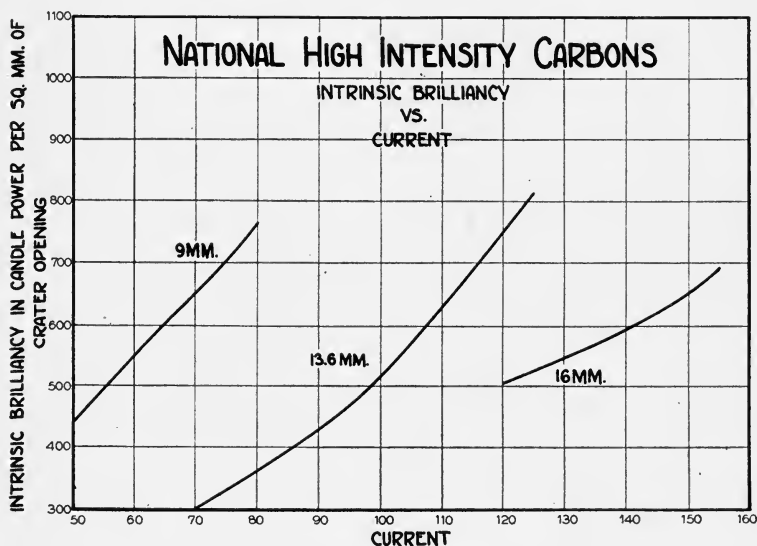

FIG. 6. Intrinsic brilliancy vs. current.

sizes of carbons at the currents ordinarily used. These values, ranging from 500 to 750 candle power per square millimeter, illustrate quite forcibly the advantage that the high intensity arc has for projection purposes over the plain carbon arc with an intrinsic brilliancy of 130 candle power per square millimeter and the incandescent tungsten filament projector lamp run at overvoltage with an intrinsic brilliancy of 27 candle power per square millimeter.¹³

Typical curves of the spectral energy distribution of the light from the craters of high intensity arcs are given in Fig. 7. The distribution closely approximates that of sunlight.⁹ The curves show that there is approximately the same amount of energy in the blue region as in

the red region for the lower currents on the carbons. As these currents are increased as evidenced by the curves for the 13.6 mm. carbons, the red end of the curve increases faster than the blue so that at the high currents there is actually an appreciable preponderance of red as compared with blue. This is contrary to the distribution curves given in the *Bureau of Standards Scientific Paper No. 539*, but, as stated previously, the measurements tabulated in that paper were

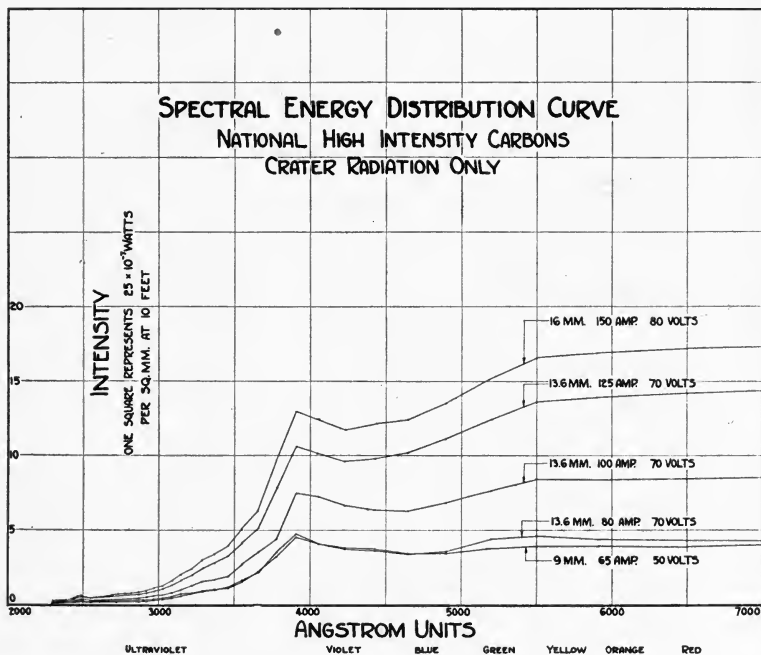

FIG. 7. Spectral energy distribution curves.

made on the unscreened arc and included the light from the negative arc stream and tail flame which amounts to approximately 32 per cent of the total light and which is known to give a decided peak of energy in the blue and near ultra-violet end of the spectrum. This tail flame and negative arc stream light is not picked up by the optical system commonly used in either the Sun Arc or projection lamps and is not therefore a factor. It would seem from these energy distribution curves in Fig. 7 that the high intensity arc, particularly at the higher currents, is a very desirable light source for use in motion picture photography.

An example of the use that can be made of data of this nature is furnished by comparing the relative light which can be obtained on the screen when 13.6 and 16 millimeter carbons are used with the ordinary plano-convex lens combination. If the 13.6 millimeter carbons were to be burned at 120 amperes and the 16 millimeter carbons at 145 amperes, the crater areas (Fig. 5) are 90 and 137 square millimeters and the intrinsic brilliancies are 737 and 620 candle power per square millimeter, respectively. It has been shown in the *Transactions*¹² that for crater areas of 137 square millimeters the relative screen illumination with arc and lenses set properly is approximately 27 per cent more than for a crater area of 90 square millimeters with two sources of the same intrinsic brilliancy. After correcting for the difference in intrinsic brilliancy, it is found that only 7 per cent more light can be expected from the 16 millimeter carbons at 145 amperes than from the 13.6 millimeter carbons at 120 amperes. Such calculations as these, which are made possible in part by the data given above, should be of some assistance in the more efficient use of this very fine source of light for projection of all kinds.

REFERENCES

- ¹ BASSETT: "The High Power Arc in Motion Pictures," *Trans. Soc. Mot. Pict. Eng.*, No. 11 (1920).
- ² PRIEST: *Tech. Papers Bur. Stand.*, No. 168 (1920).
- ³ BASSETT: "Electrochemistry of the High Intensity Arc," *Trans. Amer. Electrochem. Soc.*, **44** (1923).
- ⁴ LICHTENBERG: "Military Searchlights," *Trans. Ill. Eng. Soc.*, **15** (1920).
- ⁵ GILLETT: "Modern Searchlights," *J. Amer. Soc. Naval Eng.* (1922).
- ⁶ COBLENTZ, DORCAS, AND HUGHES: *Sci. Papers Bur. Stand.*, No. 539 (1926).
- ⁷ BENFORD: "High Intensity Arc," *Trans. Soc. Mot. Pict. Eng.*, No. 24 (1925).
- ⁸ BASSETT: "Sources of Light," *Trans. Soc. Mot. Pict. Eng.*, **10**, No. 27 (1926).
- ⁹ GREIDER AND DOWNES: "Sunlight—Natural and Synthetic." A paper presented before the 23rd annual convention of the Illuminating Engineering Society, Philadelphia (Sept., 1929).
- ¹⁰ TOWNSEND: "An Improved Condenser System for Motion Picture Projection," *Trans. Soc. Mot. Pict. Eng.*, **11**, No. 31 (1927).
- ¹¹ STORY: "Preliminary Measurements of Illumination in Motion Picture Projection," *Trans. Soc. Mot. Pict. Eng.*, No. 9 (1919).
- ¹² STORY: "Further Measurements of Illumination in Motion Picture Projection," *Trans. Soc. Mot. Pict. Eng.*, No. 10 (1920).
- ¹³ CADY AND DATES: *Illuminating Engineering*, Second Edition, John Wiley and Sons, Inc., New York (1928), pp. 38 and 76.

DISCUSSION

MR. STOLLER: I should like to ask Mr. Downes what prospects there are for increasing the amount of illumination available. With the advent of color

pictures and the wider film we are going to need about double the light flux through the optical system that we are now obtaining.

MR. DOWNES: We have made and sold some quantities of carbons for use in a 250 ampere searchlight but as we unfortunately had no machine in which we could burn them, our data are not complete. Calculations from the very meager information available indicate that the light from this arc is at least fifty per cent greater than that from the regular 150 ampere searchlight. This is confirmed by certain tests made by the United States Army.

MR. GRIFFIN: I should like to ask what size the carbons were.

MR. DOWNES: 16 mm.; the same size as the 150 ampere carbons.

MR. MOLE: Some experiments were carried on about eight years ago on the 16 mm. carbon with increased current, and some 25 samples were made, and of these about three had some promise in direct operation. At that time, we found we had an increase of about 50 per cent in illumination at 175 amperes.

MR. BENFORD: With regard to the arrangement shown in Fig. 1, were lenses not used in making this separation? If you used two apertures to get a pinhole image, the image would be very poor. There would not be a clear division between crater and flame light. This shows up too in the curves in the manner in which the scattered light is shown to increase with current. As the current is increased, there is a tendency for the gas from the crater to boil over the sides, and the region surrounding the crater is full of gas. If a sharp image of the crater had been made, it would have been found there is not much increase in the useful flux from the electrode.

MR. DOWNES: Replying to Mr. Benford, we roughly checked the amount of flame light, which was included with what we have called crater light in this set-up, by using both larger and smaller sized openings in screen *A* and found that with the particular size adopted only a negligible amount of flame light entered the box *C* in Fig. 1.

In making these measurements no readings were attempted beyond the rating of the carbon, that is, the highest current which would give quiet, steady burning. This seems to me to be the best way to arrive at a rating for a high intensity carbon.

MR. GREENE: Can Mr. Downes tell us at what angle the negative carbon was set?

MR. DOWNES: I think it was 35°.

MR. GRIFFIN: Can Mr. Benford tell us, from the research laboratory check, what the maximum rating is for the 16 mm. carbon?

MR. BENFORD: At 165, it is about right.

MR. GRIFFIN: Did I understand Mr. Downes to say that the 250 ampere carbon was of different construction from the regular 16 mm.?

MR. DOWNES: Entirely different.

MR. GRIFFIN: And you have not arrived at a definite rating?

MR. DOWNES: Yes, sir.

MR. GRIFFIN: Are the carbons available?

MR. GEIB: I think Mr. Benford and Mr. Griffin are referring to different types.

MR. GREENE: Would it be possible or practical to build a 13.6 mm. carbon of the 250 ampere type to burn at more than 125 amperes?

MR. DOWNES: Yes, it is possible to produce a 13.6 mm. carbon of the same type as the 16 mm. 250 ampere carbon. It should be remembered, however, that a considerably higher current is required with a super-high intensity carbon to equal the illumination given by the regular carbon of the same size at its point of maximum light production. In other words, considerably more than 150 amperes on the 16 mm. 250 ampere carbon is required to give a light value equal to that of the regular 16 mm. carbon at 150 amperes.

MR. GRIFFIN: I am interested in this and should like to ask if Mr. Downes can tell us about the quality of the light he is able to get from the carbon at 200 amperes. My impression is that it is yellow; is that so?

MR. DOWNES: I do not know that I can answer that definitely. I doubt if it would be yellow at 200 amperes. I should hesitate to say what the color would be.

MR. MOLE: Do you happen to know definitely the burning rate of the carbon compared with the normal 16 mm.?

MR. DOWNES: It has varied from 22 inches an hour up to 31 inches an hour; the average is about 28 inches an hour.

MR. FARNHAM: With regard to the question of more light for color picture projection; was any work done with high efficiency condensing lenses, so that a larger angle of light from the carbons could be intercepted?

MR. DOWNES: Work has and is being done, but we are not concerned primarily with the production of lenses. We have nothing whatever to do with them.

MR. GRIFFIN: Might I ask Mr. Downes in what way a super-high intensity and the regular high intensity 16 mm. carbons differ in construction?

MR. DOWNES: The shell of the regular 150 ampere 16 mm. carbon is basically lampblack and if burned at 250 amperes will be consumed at a rate of 48 inches to 60 inches per hour which is very fast. The 250 ampere 16 mm. carbon is primarily coke and burns much more slowly than the lampblack.

The cores of the two carbons are also different using different compounds of the rare earths. The compounds used in the 150 ampere carbons begin to cause bad unsteadiness at a little over 160 amperes.

A YEAR OF SOUND

HAROLD B. FRANKLIN*

In the operation of a vast chain of theaters catering to almost seven hundred thousand patrons daily, with over ninety per cent of our theaters equipped with sound installations; our organization is in a position to study the requirements and reaction of the general public in the acceptance of the sound motion picture. I am glad to have this opportunity to make a few observations on this absorbing subject.

That sound is here to stay is a foregone conclusion. It has brought to the motion picture the added advantage of speech and song and has enhanced the scope of screen entertainment, making possible perfect musical interpretation and bringing greater realism through the intelligent use of effects. Sound of every description is a part of our lives and it is natural, in a faithful representation of life, that speech and song interpret our moods. The public wants sound motion pictures—but those that are either poorly recorded or reproduced are endangering the future of sound.

The sound picture has made it possible to combine the best qualities of the silent screen with the best traditions of the theater. This has made it possible for the sound motion picture to meet the legitimate theater not alone on financial but on artistic grounds as well. A great advantage which sound pictures hold is their ability to present every word so clearly and distinctly that no one need strain to hear what is being said, at least when recording and reproducing is properly conducted. A whisper is clearly audible from the front row in the orchestra to the last row in the balcony. Let me offer my own opinion that when dialog pictures reach the degree of technical perfection now enjoyed by stage productions the latter are going to suffer by comparison.

The manufacture of sound motion pictures has passed the stage of mystery. Those engaged in the business of making sound pictures are now familiar with the medium. Many technical words coined because of sound have already become a regular part of cinema vocabu-

* Fox West Coast Theaters, Los Angeles.

lary. There is now a feeling of confidence around the studios that was lacking in the beginning. Technicians and players are available in sufficiency. They have a full realization of sound possibilities and are equipped to use their knowledge to advantage. Moreover, practically every important producer is now active in the new medium. We have learned that the entertainment and artistic value of the silent technic need not be sacrificed in the adaptation of sound. What is more, each new sound motion picture has shown improvement, which is reflected by an ever increasing patronage. Notwithstanding the general acceptance of sound, certain stories or subjects that do not lend themselves to dialog will in all likelihood continue to be made in silent form, for the public have shown themselves to be hospitable to silent motion pictures provided they are of good quality. This has been demonstrated recently by huge grosses of such pictures as Greta Garbo in *Single Standard*, Joan Crawford in *Modern Maidens*, *Four Feathers*, and others.

Under the new conditions it is likely that fewer productions will be made than in the past. It is a far more simple problem to turn out a number of silent motion pictures that require only titles to hold a story together. But when a story depends on intelligent and continuous dialog, the richest capabilities of authors and directors are taxed. Where the silent motion picture left something to the imagination of the audience, a dialog picture, to be acceptable, must absorb the full attention of the auditor. Good writers will become more important than in the past; and though it is likely that those who have been writing titles for the silent motion picture will be in demand as writers of dialog pictures, their dialog will probably be part of their own stories, for the new art will demand an author's creation. The industry would do well to foster a school for playwrights and otherwise encourage writers of talent. Good story material will be the most important requisite in time to come for the dialog motion picture, because a picture is never better than the story it tells.

A new musical interest has been added because of the sound motion picture. Scores adroitly arranged, that interpret each situation, together with cleverly written theme songs, have increased the entertainment value of the screen. The music, as synchronized, is in closer unity with the situation pictured than was the case in former times. There is not, moreover, the distraction caused by the close proximity of musicians to the screen. The art of scoring motion pictures under the new order of synchronization has scarcely begun,

and important strides may be expected in this connection within the next few years. Where inadequate orchestras used to render their ineffectual accompaniments, motion pictures are now reaping the special benefits of musical synchronization. Music of the best caliber becomes available to every type of theater. Legitimate theaters may now install reproduction apparatus to be used not only for the showing of special sound motion pictures but also for furnishing *entr'acte* music.

Standardization would be of advantage in considering the sound-on-film and disk method of recording and reproducing. The present condition where studios and exhibitors have the choice of sound-on-film and disk methods is one that has resulted in duplication. Standardization will eventually eliminate one or the other, and in the interest of greater efficiency it would appear that the system of recording sound on film will ultimately be the standard adopted by most producers. The advantages of the sound-on-film method are many; economically, it is the safer and surer method. When the sound is recorded as part of the film itself we eliminate the possibility of mistakes in shipment or in handling—a possibility that actually does arise in connection with the disks. Furthermore, the sound-on-film system is handled much more easily in the projection booth, and our experience would indicate that fewer surface noises result when this method is used. The gradual but sure loss of film due to breaks and careless patching frequently throws the disk method out of synchronization.

The sound motion picture has met with greater success in theaters of medium seating capacity and this fact may have a marked effect upon the design of newer theaters; for, while satisfactory reproduction has been attained in theaters of huge seating capacity, yet the problem in such houses is so formidable as to require constant and minute supervision. Auditoriums will be specially designed with the greatest regard to acoustical conditions. We may well expect—except in theaters located in the very largest communities, where stage entertainment may be expected at some time to be a part of the program—to see the elimination of the present size stage with its lofty gridiron. Projection booths have already become the subjects of special study by theater architects and engineers. In the newer Fox West Coast Theaters, for example, a special observer's box is provided as part of the booth, so that projectionists may see and hear everything just as it comes to the audience. Experiments are now being made looking to the substitution of remote controls for the present methods of booth

operation. In our Grauman's Chinese and Carthay Circle Theaters in Los Angeles such controls are mounted on a small panel in a seat on the orchestra floor where the volume and tonal quality of sound is controlled from the vantage point of a place in the audience. Speech must be audible. Many theater patrons have been lost because of speech not being audible. Others have condemned sound because it was too loud. It is very essential that an observer be placed in the audience, at all times, so that the sound may be governed accordingly.

No one can doubt that with the development of sound synchronization electrical science has entered the entertainment field. It is to be expected that the great electrical organizations will take an ever increasing interest in the future of the industry. Organizations such as the American Telephone & Telegraph Company through its subsidiary, the Western Electric Company, the General Electric Company, the Westinghouse Electric Company, and the Radio Corporation will further encourage the development of sound and will make available to the public the resources of their laboratories.

In view of this interest the possibilities of motion picture entertainment may be said to have scarcely been scratched. Newer methods and revolutionary improvements will come in direct ratio to the scientific facilities applied to them. This will probably bring to a practical solution such problems as stereoscopies as well as the further development of natural color. The possible future of the motion picture screen, with animation, sound, color, third dimension, and screen magnification, gives unbounded play to the imagination. Eventually there could be such perfection along these lines that one entering a theater and seeing such an exhibition for the first time will get the impression that he is actually seeing and hearing living people in action.

Already we have sound, color photography, and the double width screen. The double width film is now being developed by different organizations. It is hoped that standardization will guide them in their final development, if the double width motion picture is to be accepted by the industry under the most favorable auspices. By this means an image of wider vista may be extended through the proscenium opening. To bring the innovation to the public will require important changes, involving new cameras and projectors, as well as new screens. In production, the optical and photographic principles involve a new technic in set construction, as well as lighting.

Pessimistic forecasts concerning the sound motion picture have been

made on the basis of novelty or of difficulty in foreign distribution; but more recently others have arisen in connection with what seems to be the next development—television. It has been held by some that before sound pictures can reach their potential audience television will snatch it away.

That there will be some sort of problem no one can deny. That one phase of the problem, moreover, will somehow involve competition is likewise easy to foresee. A new amusement feature is almost bound to distract people away from the old, simply because newness affects us that way. Then, too, each diversion builds up its own following. In consequence, the film industry must look forward to a day when a rival attraction will call for the tactics of rivalry. There is at this moment a need of clear vision and close thinking on the part of constructive minds, for the highest resourcefulness, the readiest initiative will be required to offset the opposition that looms ahead in the distance. All this, mind you, without panic or pessimism; for although it is the opinion of some observers that the cinema may be seriously affected by the perfection of television, there are not lacking others who insist that television will be an adjunct to the picture trade.

They base their prediction on the saving thought that television may develop new audiences for us; nor need this reasoning seem utterly paradoxical. In the beginning radio broadcasting was considered a serious competitor of motion pictures and in the beginning its introduction did affect the box office receipts. Eventually, however, as the novelty of radio wore off and it became part of everyday life, it helped the motion picture by cultivating a taste for entertainment in many who had not been entertainment minded before. In a like manner it is conceivable that motion pictures sent through television may act as a stimulant to cultivate a taste for the theater in people who now visit us only on rare occasions. It is really not to be expected, after all, that the American family will be content to sit at the fireside at home and be entirely satisfied with the entertainment that may be sent through the air by means of television. Without arguing the point further, let me say merely that this fact is recognized by even so important an organization as the Radio Corporation of America, which is conducting laboratory experiments with television. Only recently the corporation has become interested in a theatrical enterprise involving many millions. It is thus only fair to deduce that those who are closest to television apparently feel that the motion picture theater is here to stay.

Why not! People like to be seen by others and enjoy being in public places. Here is a refined instance of "mob psychology"—one which perhaps accounts for the universal preference to go where the crowds go. In every city, most people congregate in the most popular place, whether it be a theater, a dance hall, or a restaurant. There may be plenty of room in similar places away from the main stem, yet the public will put up with disadvantages, congested traffic, and other discomforts to be with the crowd. It is the entertainment that is presented that interests the public, and not the fact that it is a motion picture and part of public entertainment is the pleasure of congregation. Producers who continue to present good entertainment need not be concerned with the inroads that the perfection of any device may eventually bring.

Experience has always indicated that in order to get the greatest enjoyment from the motion picture or other entertainment it is essential to be one of an audience. It is questionable whether drama or comedy, even though it be sent through television successfully, can register properly without the presence of a large number of people. Laughter is contagious; dramatic moments require a socialized reception to register properly. This statement may be illustrated by the fact that frequently we find it difficult to laugh at comedy renditions over the radio. The reason is not hard to find, for even motion picture producers are not able to judge a finished product until it has been previewed at a theater. Many scenes register differently from the way anticipated and changes are made after the audience reaction has been determined.

The sound motion picture, however, should be prepared to face a readjustment period when television becomes practical. Most assuredly, in the beginning, the novelty will evoke wide interest. But after the newness wears off television will find its usefulness and its proper groove and become just another comfort to modern life, as has radio.

Television has a brilliant future but not one which will come in weeks or months. In the years directly ahead sound has no obstacle to its solid intrenchment with the public. Given such a start, it should devote itself to the kind of product that will hold fast the affections of theatergoers.

Sound pictures require great skill in presentation. The public has been educated as to quality of recording and sound reproduction. Sound technicians are responsible for further development which will

eliminate the difficulties and will standardize the operation and presentation. It is remarkable how theater patrons question the two sizes of pictures used in many theaters when presenting Movietone and Vitaphone subjects. Many theaters have restored the Movietone picture to normal size, at the projector, while others are using the Movietone flipper to cover the space omitted on the screen, because of masking the sound track at the theater.

It is the opinion of many in both production and exhibition circles that the aperture size must be standardized in Movietone picture cameras and projectors, and this is now receiving serious consideration by different official bodies.

The potentialities of sound have opened a greater field for the motion picture than ever before. The future of the screen is brighter from every artistic and economic point of view. The industry is just entering its greatest era of development and more than ever will justify the fact that it wields the world's greatest medium of expression. The future, with its greater plans, greater now than in any previous period of the business, brings to us the vision of the greater responsibility that is ours.

THE OPTICS OF MOTION PICTURE PROJECTORS

ARTHUR C. HARDY*

INTRODUCTION

The usual method employed in designing an optical system seems to consist in assembling a collection of lenses and trying them in various combinations and positions until either the patience of the experimenter is exhausted or an optimum condition seems to be reached. This criticism does not apply, of course, to the optical systems of telescopes or microscopes, but rather to systems like that of the motion picture projector where it is relatively easy to obtain satisfactory definition in the image but difficult to secure enough illumination on the screen. Curiously enough, this unsystematic method of design procedure seems to be peculiar to optics, and is certainly due in part to a lack of knowledge concerning the performance that could be expected of an ideal optical system. In other branches of physics, such as heat, for example, there is the well-known and widely employed concept of thermal efficiency. Every heat engine or other piece of thermal equipment is rated by the closeness of its approach to the performance of an ideal apparatus which is assumed to operate without losses. In a previous paper,¹ the present author has attempted to establish a similar basis of comparison for optical systems based on the conservation of energy principle. The purpose of the present paper is to apply the results to motion picture projectors.

SCREEN ILLUMINATION WITH AN IDEAL OPTICAL SYSTEM

It will simplify the present treatment to consider first only those elements in the system which are fixed by the assigned conditions. These are quite evidently the gate, the projection lens, and the screen, as shown in Fig. 1. The size of the gate is fixed by convention and the size of the screen is largely determined by the size of the theater. This fixes the magnification of the film on the screen which in turn determines the focal length of the projection lens. Thus, if γ is the

* Massachusetts Institute of Technology, Cambridge, Mass.

¹ HARDY, ARTHUR C.: "Distribution of Light in Optical Systems," *Jour. Franklin Inst.*, 208 (Dec., 1929), p. 773.

distance from the focal point of the projection lens to the screen, the focal length (f) of the projection lens is determined by equation (1), where m is the linear magnification of the film on the screen.

$$f = \frac{y}{m} \dots\dots\dots(1)$$

Let us first consider these elements in Fig. 1 independently of the customary source of illumination. To do this, we may imagine a ground glass or diffusing glass placed just to the left of the gate and we may ignore for the present the method by which this receives its illumination. If the diffusion is perfect, this source will appear equally bright from every direction of observation. Assuming its brightness

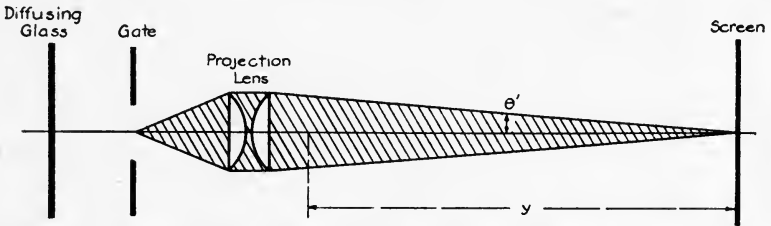

FIG. 1. Elements of an optical system which determine magnification and intensity of illumination.

to be B candles per square foot, it has been shown¹ that the illumination at the center of the screen is given by equation (2),

$$E = \pi B \sin^2 \theta' \dots\dots\dots(2)$$

where E is the illumination in lumens per square foot, and θ' is the half-angle of the cone whose base is the effective area of the projection lens and whose apex is the center of the screen. Equation (2) is rigorously correct when the source is perfectly diffusing, when the losses by reflection or absorption within the projection lens are negligible,² and when the projection lens obeys the sine condition. The latter condition can be derived from the conservation of energy principle and applies only to a perfect image-forming system. No actual lens can be constructed to fulfill this condition completely nor can the losses caused by absorption and reflection be eliminated. Consequently, equation (2) gives the illumination at the center of the screen

² The transmission of the usual projection lens is between 60% and 80%, depending principally upon the number of air-glass surfaces it contains. The loss by reflection usually amounts to 5% for each air-glass surface in the system.

that could be expected of an ideal optical system and a source of intrinsic brightness B . It is as futile to attempt to produce more illumination than is indicated by equation (2) as it is to attempt to build a perpetual motion machine, and for the same reason. Obviously, it makes no difference how far the diffusing glass is placed behind the gate, provided the gate appears filled with light from every point of the projection lens.

When θ' is small, as it is in this case, equation (3) below gives substantially the same result.

$$E = \frac{\text{Brightness of Source} \times \text{Effective Area of Projection Lens}}{\text{Square of Distance from Lens to Screen}} \dots (3)$$

The units of E will be lumens per square foot (or foot-candles) when the brightness of the source is expressed in candles per square foot and the area of the projection lens and its distance from the screen are measured in square feet and feet, respectively. Equations (2) and (3) apply only to the center of the screen or better to the point where the optical axis intersects the screen. It has been shown¹ that the illumination decreases toward the edge of the screen as the fourth power of the distance from the projection lens. For example, the illumination at the edge of the screen can be determined by multiplying the illumination at the center by the fourth power of the ratio of the respective distances of the two points in question from the projection lens. As the screen is usually small, this decrease in illumination toward the edge of the screen is not serious. As a practical matter, a slight reduction in illumination toward the edge is desirable because of the contrast between the edge of the screen and the black border surrounding it. In fact, it has been found experimentally that an absolutely uniform illumination of the screen makes it appear too bright at the edges due to this contrast effect.

THE EFFECT OF APERTURES

Before attempting to include the light source and condenser, let us consider briefly the effect of apertures on the performance of the optical system. Fig. 1 shows two apertures, one being the gate and the other the rim or effective stop of the projection lens. Since the gate is imaged on the screen, it is known in optical theory as a *field stop* and limits only the area of the picture without having any effect on the screen illumination. If a metal mask containing a small hole were inserted at the gate, the size of the picture would be reduced

but the illumination of the remaining portion would be unaltered. In other words, placing this mask at the gate would have exactly the same effect as moving in the black border surrounding the screen, a result to be expected from the fact that the two planes are conjugate to each other. On the other hand, if the same mask were placed at the projection lens, the illumination of the entire screen would be reduced as shown by equation (3), but the illumination would still be nearly uniform over the entire picture area. The hole in the mask is then said to operate as an *aperture stop* as opposed to a field stop. Although the insertion of such a mask or aperture can serve no useful purpose in practice, we shall see later that the source of light or the condenser may produce substantially the same result, and a consideration of the effect of apertures is consequently in order.

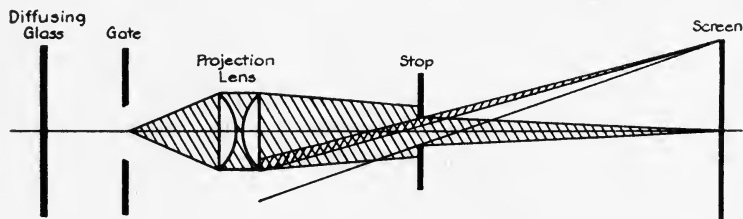

FIG. 2. Effect of the stop position.

Let us consider the effect of placing a small stop or aperture at some point on the axis of the optical system between the projection lens and the screen, as shown in Fig. 2. As this figure is drawn, this stop is the aperture stop of the system. Although this is obvious from the figure, it is easily proven in any case by substituting the effective area of the stop for the area of the projection lens in equation (3), and the distance of the stop from the screen for the corresponding distance of the projection lens from the screen. If the resulting illumination is less than without the stop, the latter is the aperture stop of the system. We should normally expect the illumination to decrease toward the edge of the screen as the fourth power of the distance from the center of the stop. In this case, however, the presence of the projection lens in the system causes the illumination to decrease at an even greater rate because the effective area of the stop is reduced. Thus, as Fig. 2 has been drawn, light is received at the edge of the screen from only that portion of the stop through which the projection lens can be seen. If no portion of the projection lens can be seen through

the stop from a given point, the illumination is zero at that point. In other words, when the stop is at the projection lens, it limits only the aperture of the system while, if it is placed at the screen, it limits only the field. For intermediate points, it may limit either the field or the aperture or both, depending upon its size and position and on the rest of the optical system. For such intermediate positions, the field is not sharply limited but is gradually vignetted.

The effect of a stop in the system at the left of the projection lens can be determined by using the method due to Abbé. This consists in determining the size and position of the image of the stop formed by the projection lens and treating it as a real stop in the system. Since every ray through a given point in the real stop goes through the corresponding or conjugate point in the image, the image is just as effective in limiting the rays as a real aperture at that point would be. For example, if the diameter of the diffusing glass in Fig. 2 were too small, its effect could be calculated by determining the size and position of its image formed by the projection lens, using the familiar lens equations. Suppose that the image of the diffusing glass lies in the plane of the real stop shown in Fig. 2 and that its size is the same as the free aperture of the latter. The diffusing glass would then behave in every way like the real stop. In fact, the stop could then be removed and both the field and aperture of the system would be the same as though it were still in position. This is a very useful method of analyzing the effect of any element in an optical system.

DESIGN OF THE ILLUMINATING SYSTEM

Let us apply this method of analysis to the illuminating system of the motion picture projector. As we have already seen, the size of the gate is fixed by convention, while the size of the screen and the projection distance are fixed by local theater conditions. This determines the focal length of the projection lens, and its minimum diameter is determined by equation (3) in terms of the intrinsic brightness of the source and the amount of illumination desired on the screen. Since the maximum intrinsic brightness in the case of either carbon arcs or tungsten filaments is a fairly definite quantity for a given source, all the elements in the system at the right of the gate in Fig. 1 are known and this portion of the projection system may be laid out on the drafting table. We come then to the design of the illuminating system which must obviously satisfy the following requirements:

(1) The projection lens must remain the aperture stop of the entire system.

(2) The gate must remain the field stop of the entire system.

These conditions do not determine the best design of the illuminating system. However, since the cost of operation of either a tungsten

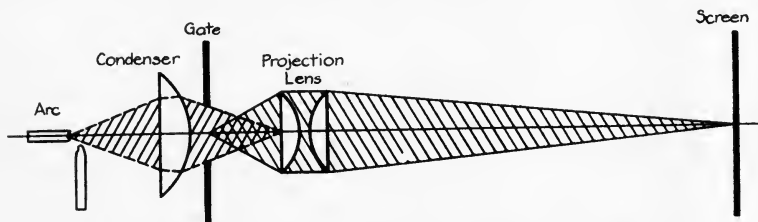

FIG. 3. A system in which the arc crater is focussed on the projection lens.

lamp or an arc is approximately proportional to its size, it is more economical to satisfy the above conditions with as small a source as possible.

There are two illuminating systems that possess more than ordinary interest. These are shown in Figs. 3 and 4, but we will consider the system of Fig. 3 first. The arc is here focussed on the projection lens by a condenser located at or very near the gate. It is obviously impossible with this arrangement for the arc to limit the field or for the

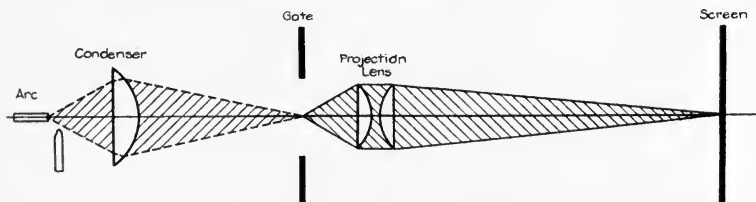

FIG. 4. A system in which the arc crater is focussed on the gate.

condenser to limit the aperture. The condenser will not be the field stop of the system if it is larger than the gate and the arc will not be the aperture stop if its image fills the entire area of the projection lens. The magnification of the image of the arc should be as high as possible so that a small source can be used. This means that the condenser should have a short focal length, which requires that the source be placed very close to the condenser. The limit of efficiency is reached with this system when the focal length of the condenser is as

short as possible with due consideration for lens aberrations on the one hand, and over-heating or pitting of the surface of the condenser on the other.

Let us now examine the system shown in Fig. 4, in which the arc is focussed directly on the gate. With this arrangement, it is impossible for the arc to be the aperture stop of the system, but it may be the field stop unless the magnification of the image formed by the condenser more than covers the gate. As before, the size of the arc will be a minimum when the magnification of its image is a maximum. The condenser, in this case, may limit both the field and the aperture if it is too small. Its minimum diameter may be quickly determined by applying the method outlined in the preceding section. This consists in determining the image of the condenser formed by the projection lens, and treating this image in the same manner as the stop shown in Fig. 2.

If the two major conditions are satisfied, the screen illumination in both systems that we have just considered will be substantially the same. However, one system or the other will satisfy these conditions with a smaller source, depending upon the relative sizes of the gate and the projection lens. Since the gate is ordinarily smaller than the projection lens in projecting motion pictures, it is somewhat easier to fill the gate with the image of the source than to fill the projection lens. In other words, if we assume the same magnification in the image of the arc by the condenser, the two major conditions can be satisfied with a smaller source with the system shown in Fig. 4. On the other hand, in the projection of lantern slides, or the wide motion picture film that is now being discussed, the gate may be larger than the projection lens, and it is then more economical to image the arc on the latter. In comparing the two systems in this way, we are tacitly assuming that the surface of the arc crater is sufficiently uniform in brightness to focus directly on the gate. This assumption is seldom completely justified and is never possible with incandescent lamp sources. Consequently, when the maximum efficiency would result from imaging the source on the gate, a compromise is usually made by moving the image of the source toward the projection lens until the illumination of the screen is sufficiently uniform. The proper size of the arc can be determined by finding the size and position of its image by the condenser, and then determining the image of this image formed by the projection lens. The second image is then treated as a real stop in the manner described with reference to Fig. 2

in the preceding section. In a similar way, the proper diameter for the condenser is determined by finding the position and size of its image formed by the projection lens. It may be worth while to remark that the adjustment of the arc is less critical if the diameter of the projection lens is slightly larger than required to produce the desired screen illumination.

PRACTICAL CONSIDERATIONS

The foregoing treatment of this subject has been kept as free as possible from practical details in order that the attention might be focussed exclusively on the underlying principles. No mention has been made of the pull-down mechanism or the arc control mechanism, which may prevent the condenser from being placed in the most favorable location. Also, it was not thought desirable to distinguish between condensing systems employing lenses and those using a mirror. Both types are characterized by the common property of forming an image somewhere in space and of a certain size. Also, both mirrors and lenses have rims in common which may restrict the light beam unless the diameter is properly chosen. As the fundamental requirements are the same in both systems, the design procedure is identical in the two cases and is greatly facilitated by the concept of an ideal system, which for our purpose is assumed to operate without losses.

By way of conclusion it is interesting to return again to equations (2) and (3) and to reconsider the assumptions upon which they depend. It will be recalled that the source was assumed to be uniform and of constant brightness from every direction of observation. In other words, the source was assumed to obey Lambert's law of emission, which states that the intensity varies as the cosine of the angle from the normal. An examination of the intensity distribution curves of some of the sources in common use for motion picture projection shows a decided tendency for them to obey Lambert's law of emission except for shadows cast by the negative carbon or the arc control mechanism. Although this decreases the available illumination, it does not otherwise vitiate any of the conclusions reached in this paper. It will also be recalled that the lenses in the system were assumed to obey the so-called sine condition. Unless the projection lens obeys this condition, the definition at the margin of the screen will suffer. Since aberrations in the condensing system do not affect the definition on the screen, the lenses employed in that part of the system need not fulfill the sine condition to the same degree. In view of the well-known

phenomena of spherical and chromatic aberration, it is apparent that the position and size of the image of the arc formed by the condenser will depend somewhat upon the zone of the condenser used and the color of the light. Consequently, our two fundamental conditions must be extended to include every zone of the lens and every color in the light. The magnitude of the losses within the system due to absorption and reflection have already been considered.

It should be stated again that the results obtained on the basis of these assumptions apply only to an ideal system and that no actual system can quite equal its performance. This difference between the two cases may be used as a measure of the efficiency of any actual system. Since the underlying principles in the case of an ideal system are more or less obvious, much of the uncoordinated experimentation, which often accompanies the design of projection systems, can thereby be avoided.

MULTIPLE EXPOSURE CINEMATOGRAPHY IN SOUND PICTURES

WILLIAM STULL*

It is hardly more than a year since sound pictures took their place as the major part of studio production programs. In that year an enormous amount of progress has been made, alike in the artistic utilization of the new form, and in the technic of its operation. Studio personnel has grown increasingly familiar with the sound device, and this familiarity has resulted in the overcoming of many of the obstacles which the coming of sound was thought to have placed in the path of true screen technic.

An instance of this is the reappearance of such truly cinematographic effects as lap-dissolves and multiple exposure work. A year ago they were regretfully dropped from the cinematic vocabulary due to the added complication of sound photography. Now they are reappearing, as cinematographers and recorders gain more assured mastery of the new medium.

Probably the first to reappear were the fade-out and fade-in. Screen technic demanded them. As a rule, they have been made chemically; but to cinematographers, chemical fades are rarely satisfactory substitutes for those made directly in the camera. Similarly, recording engineers greatly prefer to control the fades on their sound tracks themselves. Therefore, in practically all studios, fades are now made directly in the camera and recorder. When recording with the variable density process, by means of a glow-lamp, the most satisfactory method has been found to be the gradual removal of the lamp to a distance from the film at which its light is no longer strong enough to affect the emulsion. While this could of course be done mechanically, it is at present done manually, very little practice being required to attain proficiency. When using the light-valve method, two courses are possible. One may either gradually stop down the lens of the recorder, or reduce the amplification from the mixing-panel. Both of these methods are also applicable to the variable area processes, while of course the only control possible for the disk systems is through the amplifier

* American Society of Cinematographers, Los Angeles, Calif.

Having mastered the technic of fading in and out in sound, it is not such a great step to combining and overlapping the fades, making a lap-dissolve. Still, it has proven quite an undertaking, as it offers rather more than double the complication and hazard that silent laps entail. None the less, it is a vitally important part of dramatic cinematography, and could not be overlooked; consequently, the majority of the studios are in one way or another accomplishing sight and sound laps with increasing frequency. Probably the easiest way of getting the desired effect is through the use of the optical printer and the making of duplicate negatives. This is, indeed, the general practice in the studios using disk recording exclusively. But "dupes," unless made with a skill and care almost never found in the rush of commercial production, seriously detract from the quality of both picture and sound, and are naturally avoided wherever possible. A second method is to allow the picture to lap quite as though it were a silent film, while the sound merely fades in and out with unusual rapidity: for instance, if the complete lap were to run, say, eight feet, the sound would fade out in four, being immediately faded in on the next scene, also in four feet.

But this is so slightly removed from true lap-dissolving that the added trouble is negligible. Therefore, in most cases, true lap-dissolves are returning to favor in preference to other makeshift methods.

When using the variable density systems with glow-lamp apparatus, the procedure, as is the case in fades, is to withdraw the lamp from the recorder. Then the several films are wound back to the marked starting point of the scene, and run forward, with shutters closed and glow-lamp withdrawn, to the point at which the dissolve was started, and the fade-in is made in the usual manner. As a matter of actual practice, however, it has been found necessary to rewind only to the start of the fade-out, plus the footage necessary to regain speed—usually twenty feet. The writer recently spoke with a cinematographer who had on the same day made by this method a sequence involving four such lap-dissolves, without a single failure in the course of a half-dozen takes. He had found it necessary, however, to recognize the human element in his problem to the extent of allowing for the inevitable lag in the recorder's response: for instance, if the fade were to come at the 40-foot mark, he would signal the recorder when the indicator read 38 feet, and then start his own fade.

When recording with the light-valve, the same general technic is followed, save that the sound is faded in or out by either the optical

or electrical methods earlier mentioned. In the variable area systems, the same general procedure may be followed, but there is an additional possibility, as well. The entire optical assembly may be gradually de-centered with respect to the film, gradually reducing the magnitude of the serrated edges of the sound track to their mean level. If this be done, moving the assembly to the left, for instance, and at the same time shielding the right-hand side of the track from exposure, the other half of the dissolve may be effected by similarly moving the assembly in from the right, and stopping it when centered. So far as is known, this latter possibility has not as yet been tried in actual production, though it is considered quite feasible from the theoretical standpoint.

For the disk systems, lap-dissolves still present a serious problem. Maintaining proper synchronism is difficult, and it is highly improbable that the two scenes could be recorded directly over each other successfully. Therefore, the general practice of organizations using disk recording exclusively is to make all lap-dissolves and fades with the optical printer. However, where the equipment permits, the most likely way to secure these effects without the use of "dupes" is through the use of a film-recording process, and subsequent re-recording onto the disk. Another possibility is the use of two separate disks. The first is used until the fade-out is complete—the volume being reduced electrically. The second is used with the second scene of the pair; the photographic film having been rewound to the original starting point of the first scene, after which it is run, with the shutter closed, synchronously with the new record, to the point at which the second half of the lap begins, whereupon both picture and sound are faded in, and the scene continued as usual. The two partial records can then be processed, and re-recorded onto a third and final one. A third possible method is quite similar as regards the making of the first record. This is then processed, and played through a loud-speaker on the set, while the camera runs, with shutter closed, synchronously with the record, which is being re-recorded by properly placed microphones. At the proper place, the camera shutter may be opened, and the other microphones about the set gradually energized to record the action of the second scene.

A variant of this method has been used in the recording of large scenes, especially those representing theatrical performances. The vocal part of the scene is first recorded, under acoustically perfect conditions. The film or disk of this record is then processed, and

thereafter played through a loudspeaker and re-recorded while the photographic part of the scene is made, the actors "mouthing" their lines and songs inaudibly. This combination enables these somewhat difficult scenes to be photographed and recorded much more satisfactorily than could otherwise be the case.

Similarly, in a recent film wherein the star was required to play a dual role, this arrangement enabled him to time his actions perfectly, and to give himself his own cues. Photographically, the scene was made by the familiar "split-screen" methods, whereby the picture-area is divided in two, first one-half being photographed, and then the other. Strangely enough, the addition of dialog simplified the procedure, instead of complicating it. Formerly, the action had to be timed by counts, which, for any degree of precision, was rather involved and exacting—and at times highly disconcerting to temperamental players. In this case, however, the actor was able to time and cue himself. The first half of the action was photographed and recorded quite normally. Then the sound record—in this instance a disk—was quickly processed, and the photographic film turned back to the original starting point. When the record was ready, it was played through a loudspeaker on the set, before which a microphone was hung. Both the camera and recorders were synchronized with the phonograph, and the remaining half of the scene was made with the phonograph not only supplying the cues to the actor, but also making the dialog complete on one record for both halves of the scene.

Similar double-exposure work has been done in at least two instances in the variable density process, using both light-valve and glow-lamp recording. In the first case, the scene was comparatively simple, requiring one character to converse with another, played by the same actor, without a great deal of action. Photographically, of course, it was easy, the more so since one character remained practically motionless throughout the scene, presenting his profile to the camera. The sound was not difficult, either. Between the speeches of the first character, the sound track was left blank, by closing the lens of the recording light. This first record was then processed, and played back to the actor as a cue for his speeches in his second character. However, instead of using a loudspeaker and re-recording, the actor wore a radio-earphone on the side away from the camera, and the two partial records were combined later, in the printing.

In the other case, where the glow-lamp method was used, the two halves of the scene were made in quick succession, with a single sound

track. To avoid exposing the film between each character's speeches, the lamp was withdrawn, and replaced at the proper time. As there was no partial record to play back to cue the actor, and as counts were obviously impossible, the cinematographer memorized the entire scene, and devised an elaborate system of lights by which he could signal both actor and recorder their respective cues. In this case again, he had to take into account the lag in their response. Aside from this, his task was of particular interest because of the nature of one of the doubled scenes, in which the actor, having beaten himself in a fight, knelt over his own prostrate form, and talked with himself! The effect was achieved by exact and skillful photographic matching of the actor's head onto a double's body. The scene was photographed and recorded three times—and each "take" was perfect!

So far as is known, while such double-exposure work is equally feasible with the variable area systems, none has so far been attempted, as no need for it has happened to arise in the course of the regular work of the studios using that system.

Thus, however, it will be seen that, even in the brief space of a year, studio technicians have so far mastered the sound device that they can successfully attempt most of the cinematic effects and tricks of yesteryear in today's vocal films. Had they achieved this under the perfect conditions of laboratory research, they would be deserving of the highest praise, but that they have done so instead under the hurried and nerve-wracking conditions of scheduled commercial production adds incalculably to the glory of their achievement.

THE ILLUSION OF SOUND AND PICTURE

JOHN L. CASS*

The word "illusion" is one of the most patient and long-suffering in common usage. It is a favorite with the official propagandists of the film industry, sharing honors with the appellations, "box-office appeal" and "sure-fire smash." We have many "illusions" in our industry, but the one for which we all strive is the "illusion of reality," which is also the ultimate goal of all other forms of synthetic entertainment. Motion pictures, with or without sound, constitute a medium of expression, and accordingly must be governed by certain fundamental rules.

If a medium of expression is to be powerful, the medium itself must be so utilized that it retires into oblivion as it does its work. This is true in the case of the printed word, the spoken drama, pantomime, the silent motion picture, and the talking picture. Each one of us has had the experience of reading an excellent piece of literature which had been printed rather poorly, but legibly, on cheap paper. As we opened the book, we noticed the lack of quality, but as the worthy contents disclosed themselves, the quality of the medium faded in importance, and eventually we became so engrossed that the consciousness of reading disappeared. The illusion thus created depended upon the fact that legibility was the one requirement of that particular medium. Graceful type, or fine paper, would have added nothing to our enjoyment. On the other hand, graceful type which was more difficult to decipher would have detracted from our pleasure, as it would have made the act of reading more difficult, thus thrusting the medium upon our consciousness, when that consciousness desired to be alone with the meaning of the printed words.

Parallel cases might be drawn for all other media of entertainment, to illustrate that the prime necessity is to create the illusion. The problem of the motion picture is to create the illusion of reality, using gray shadows as the medium of expression. The effort of many years in silent pictures has created a technic of skilled photography

* Gramercy Studio, RCA Photophone, Inc.

combined with ingenious cutting which has proven many times that a perfect illusion may thus be created. Sound was added to increase the scope and flexibility of the motion picture as a form of dramatic expression, and to combine with the picture the ability to cater to the musical appetites of the public. This musical appetite was demonstrated by the popularity of the phonograph, followed by the overwhelming success of radio broadcasting.

Several of the great electrical companies, recognizing the possibilities of the talking picture, developed equipment which made possible the creation of a new medium of expression, meaning a new form of illusion. Sounds may be recorded with sufficient fidelity and strength, and with such accurate directional effect, that the theater audience of today may forget the medium used, and may lose itself in absorbing the meaning of the images and accompanying sounds without being conscious of the medium itself. The popularity of talking pictures is due to the success of the illusion.

A number of requirements must be met to maintain the illusion. As in the case of the printed word, the pictures must be easily discernible, and the sounds easily understood. Intelligibility, and musical quality, may now be guaranteed, and will be further improved as the fruits of research come from the laboratories. However, the greatest strides will come from the development of recording technic.

Now that equipment is approaching perfection, the time has arrived for concentration on the psychological phases of recording, to the end that inconsistencies may be minimized. Referring to silent picture methods for a moment, let us consider photographic technic. Changing of camera angle or camera lens means that the eye of the observer is being shifted, either in angle or in distance, from the action. It has been found that the eye of the audience may be moved and by this means actually enhance the illusion of reality, provided the movement is accomplished judiciously and with definite purpose. It is quite possible to induce dizziness and nausea in an observer by such means as photography from the rolling deck of a vessel. Similarly, cutting from a very long shot to a close-up at the wrong time would very probably induce an effect of sudden acceleration. There is a similar situation in the handling of sound records.

Present practice in sound studios involves the use of a number of cameras, each using a lens of focal length which places the observer at a very definite point with respect to the action. The extreme positions would be the long shot, covering the entire set, and the big

close-up of the principal performer. Contrasted to this, it is common practice to use a single microphone system, in which a number of microphones are mixed in the monitor room to attain intelligibility of speech and good quality of speech and music. When a number of microphones are used, the resultant blend of sound may not be said to represent any given point of audition, but is the sound which would be heard by a man with five or six very long ears, said ears extending in various directions. This blend of sound may be recorded on several machines, film or wax, or both film and wax, but the sound record is the same on all machines. Eventually the cutter will take this sound record, and will cut from one camera to the other in order to get the proper picture results. When this scene is projected, the eye will jump from a distant position to an intermediate position, and from there to close-up positions on important business. The sound will run throughout as though heard from the indefinite position described above. Since it is customary among humans to attempt to maintain constant the distance between the eye and the ear, these organs should move together from one point to another in order to maintain our much mentioned illusion.

My observation has been that this lack of coördination of eye and ear is the most flagrant fault in sound recording at the present time. It is particularly noticeable in short subjects of orchestras, where the close-up camera moves from one instrument to another while the microphone is recording a balanced blend of the combined instruments. If one were standing close to the saxophone, its tones would predominate, and shifting to the violin would have obvious consequences. Similarly, in dialog sequences, quality and volume remain constant while the cutter jumps from across the room to a big close-up. At such times one becomes conscious that he is witnessing a talking picture, this condition indicating that the illusion has been partially destroyed at that point.

Here it may be asked, "What can be done about it?" It is possible technically to make sound tracks which will match the camera takes so that the eyes and ears of the audience may retain their normal positions. This can be done by using parallel recording channels, with the microphone on each so placed that the resultant sound tracks will approximate the effective camera positions desired. This procedure would require more predetermination of camera angles than is usual at the present time, and coördination of the camera positions with the microphone placing. The desired result could be obtained in most

cases by one or two microphones in each channel. In many instances where volume changes alone will suffice, one recording channel may be used, with subsequent treatment after the picture has been edited.

Progress along these lines will demand better understanding of photography by sound engineers, and better understanding of sound by camera men. Artistic results without the present distractions will require the following:

1. More accurate and detailed scripts, for technical planning.
2. Complete understanding of plans between director, camera man, sound engineer, and set designer.
3. Elimination, in so far as is possible, of "*ad libbing*" by the director.

If the foregoing conditions are met, the work expended in intelligent planning will remove much of the present load of responsibility from the shoulders of the cutter, and should react to lower the cost of production by the minimizing of delays on the set. Sound has already forced forethought on the makers of motion pictures to the end that the savings have practically cancelled the cost of recording. This tendency will continue, and should serve to materially reduce cost of production as compared to the old silent picture methods of prodigal extravagance. The talking picture of the future will be engineered by a team of highly intelligent and coöperative technicians, cinematographer, and sound engineer, who must have broad vision, and who must drop, in so far as possible, the prejudices of the past. Rapid strides are being made in this direction, which augurs well for the future of the film industry.

FILM NUMBERING DEVICE FOR CAMERAS AND RECORDERS

M. W. PALMER*

Footage numbering has been used on the edge of motion picture film for some time, and has proven to be a great aid in cutting and assembling silent pictures. With the introduction of sound, a sepa-

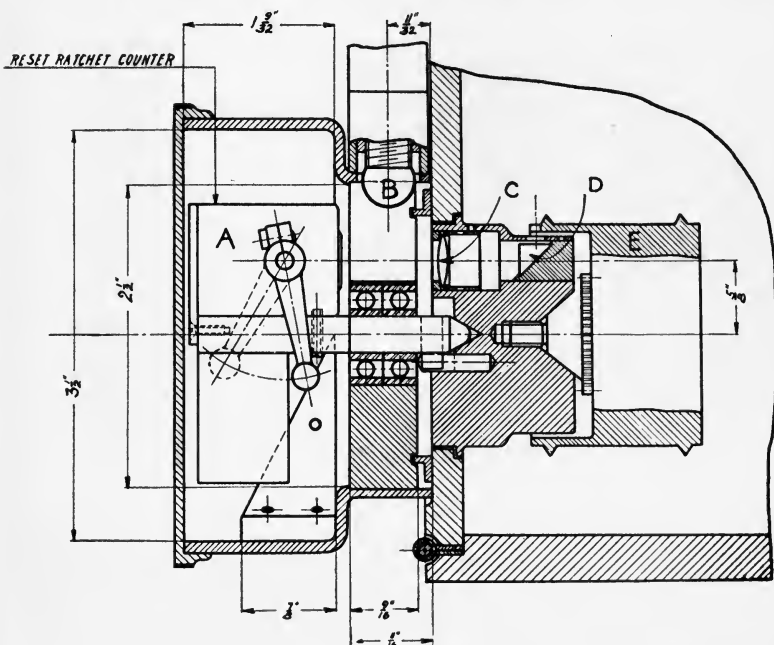

FIG. 1. Diagram of mechanism of the footage numbering device.

rate film is used for the sound track, and it is very desirable for cutting and matching that the sound track bear the same numbers along its edge as does the picture negative. The device, which I am about to describe, numbers both films in the camera while the picture is being made, thus substituting for the present numbering system a different one better adapted to sound pictures.

* Paramount-Famous-Lasky Corp., Long Island City, N. Y.

This device consists essentially of an illuminated counter, mounted in a box on the outside of the camera, a lens, and a prism inside the camera to carry the image of the counter face to the edge of the film. The counter, lens, prism, and film all move in synchronism about the same axis, thus making it possible to put the number on while the film is moving.

Fig. 1 is a diagram of the mechanism. *A* is the re-set counter, *B* is a small lamp to illuminate the face of the counter, *C* is a lens

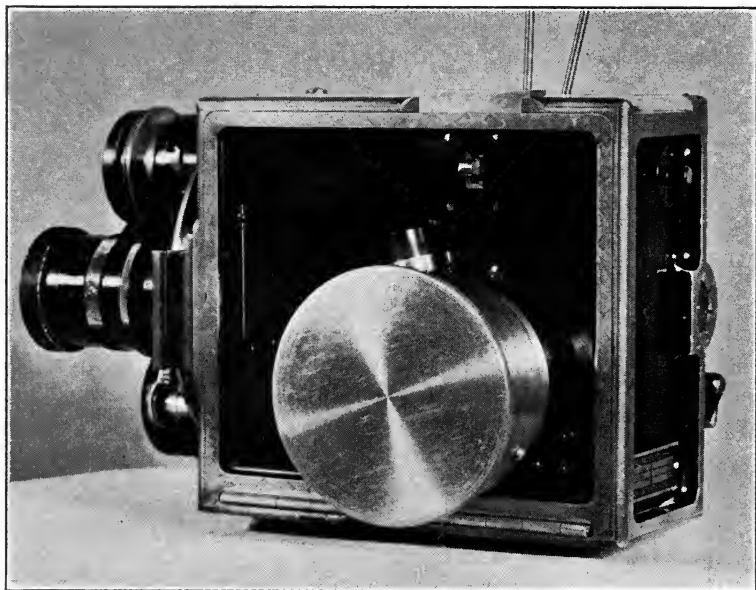

FIG. 2. Numbering device attached to camera.

focussed on the face of the counter, and *D* is a prism which diverts the light rays so that the image falls on the edge of the film which is riding on the sprocket *E*. All these elements are revolving about the same axis, thus producing an image which is moving at the same angular velocity as the film which is receiving it.

Fig. 2 shows the device attached to a motion picture camera. The cover is removable, so that the counter can be reset to any particular reading desired.

Fig. 3 shows the camera door open. The member containing the lens and the prism is screwed on to the end of the sprocket shaft and

the image is projected upon the film through a small notch cut in the sprocket. A simple catch is provided which drives the part containing the counter when the door is closed.

For recording systems where the camera and the sound recorder are run by separate synchronous motors, a slightly different type of mechanism is used which does not start to number until both machines have come up to synchronous speed.

The operation of this device in connection with motion picture pro-

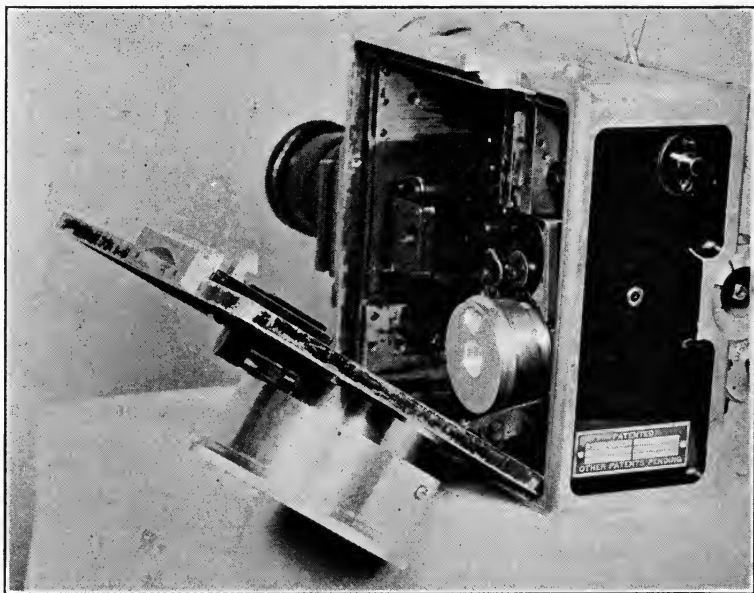

FIG. 3. Rotating member of numbering device in position on sprocket.

duction would be as follows. Before starting any particular scene, the camera men on the set receive their starting number from the recording room, the same as is done at present. Instead of punching this number on the film, each man sets his counter dial at the starting number, and when the cameras start each film will be numbered with the same series of consecutive numbers. After the film has been developed in the laboratory all that is necessary to do to locate the sound track belonging to any particular frame of the negative, is to look for the same number. If desirable, the various cameras and recorders

can use a small symbol ahead of the numbers which will also identify the film coming from a particular camera.

It is also possible with this device to put the production number on the edge of each piece of film by providing another small lens and

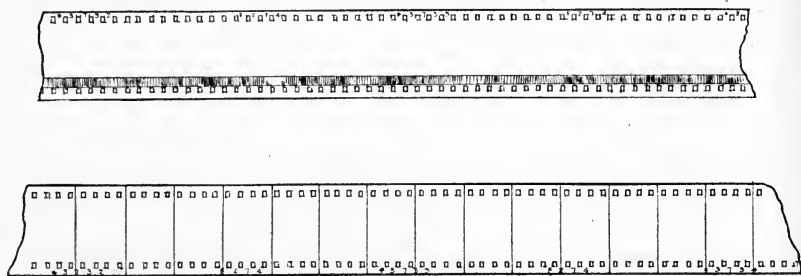

FIG. 4. Example of numbering on picture and sound track.

a changeable "slate" in the mechanism itself. This would serve to completely identify each foot of film as to production, camera, and corresponding sound track, thus relieving the film editor of unnecessary detail, and allowing him to concentrate on the more important features of his work.

DISCUSSION

MR. COFFMAN: I would like to emphasize as strongly as I can the merits of this little device of Mr. Palmer's. It is small as far as complication and size go, but nevertheless it can save a tremendous amount of money for the industry if adopted. I have done enough editing of sound film to know the difficulty of handling separate pieces of film from the triple or double rewinders and going to a great deal of pains to maintain synchronism. The general use of this device would make it unnecessary to provide starting marks; it would mean that in addition to footage numbering the camera slate or code representing it could be recorded so it would be unnecessary to take up film footage by photographing the slate. Sound track and picture film could be cut into pieces a foot long without difficulty in identifying them.

MR. OFFENHAUSER: There is only one little remark I should like to make and that is that a recorder takes longer to start up than the camera. How does Mr. Palmer arrange for the proper starting? Where does he locate the mark?

Here is another point: The camera magazines are not loaded when the sound magazines are loaded. How about the mark in case film is left in one and not in the other? Can they stop the feed counter at the end of a shot?

MR. PALMER: As far as the two machines coming up to speed at the same time, I had that in my paper but skipped it. I have an arrangement whereby the counter which is on the picture camera and that on the sound camera are held out of engagement by a magnetic clutch and, when both are up to speed,

the clutches are released simultaneously and the numbering begins with the same number on both.

As for one camera running out of film and the other having film in it, I am afraid I didn't make that quite clear in my paper, but regardless of what film is in the camera, each operator of the picture camera and the operator of the sound camera have the counter set at the same number before taking is started, and this number goes on each film and numbering starts from that point. Each film starts at the same number, and all have the same number along the edge when they come out of the laboratory.

24 100
25 100
26 100
27 100
28 100
29 100
30 100
31 100
32 100
33 100
34 100
35 100
36 100
37 100
38 100
39 100
40 100
41 100
42 100
43 100
44 100
45 100
46 100
47 100
48 100
49 100
50 100
51 100
52 100
53 100
54 100
55 100
56 100
57 100
58 100
59 100
60 100
61 100
62 100
63 100
64 100
65 100
66 100
67 100
68 100
69 100
70 100
71 100
72 100
73 100
74 100
75 100
76 100
77 100
78 100
79 100
80 100
81 100
82 100
83 100
84 100
85 100
86 100
87 100
88 100
89 100
90 100
91 100
92 100
93 100
94 100
95 100
96 100
97 100
98 100
99 100
100 100

WATER COOLING OF INCANDESCENT LAMPS

N. T. GORDON*

INTRODUCTION

The ordinary applications of incandescent lamps in lighting our homes, offices, and cities seldom bring to our attention or consideration the quantity of heat which is produced as a necessary consequence to the light emitted by incandescent tungsten. However, in certain special applications of high intensity illumination, such as the lighting in motion picture studios and the projection of motion picture films, the intense heat not only is brought to our attention, but is impressed on our minds through physical discomfort.

The tendency is toward higher and higher intensity of illumination, and along with the light we get more and more heat which is evidenced by spoiled make-up and dispositions. Talking and color motion pictures are placing added responsibility upon the incandescent lamp, and it is the desire to remove, so far as possible, any features which are objectionable even in special applications. With this aim in mind, the problem of reducing the heat from incandescent lamps has received careful consideration in the research and engineering laboratories of lamp manufacturers, and it is our purpose to present a report of progress on one line of experimentation. It must be emphasized that the work has not reached a commercial stage, but we are intensely interested in solving the problem, and criticism and discussion of the present experimental work will be of great value in future development, should it progress beyond the laboratory.

ENERGY DISTRIBUTIONS FOR A BLACK BODY AND TUNGSTEN

In order to obtain a clearer conception of the proportion of the total energy radiated by an incandescent body in the different spectral regions, let us refer to some diagrams and tables taken from the literature on that subject. Fig. 1 shows energy distribution curves for a black body at three temperatures. Relative energy is plotted as abscissas and wave-length as ordinates. The visible spectrum is

* General Electric Co. Research Laboratory, Schenectady, N. Y.

included between the dotted lines and extends from 0.4 micron¹ to 0.76 micron; the infra-red, from 0.76 micron to infinity; the ultra-violet, from 0.18 micron to 0.4 micron.

It will be noted that the largest part of the energy, as indicated by the areas under the curves, lies in the infra-red. It is this infra-red or heat area that we are interested in reducing. As the temperature

TABLE I
Proportion of Total Radiant Energy for Various Lamps (Holladay)

Lamp	Lumens Emitted per Watt l_1	Maximum Temperature in Deg. K.	Average Color Temp. T_c in Deg. K.	Maximum Brightness of Filament Candles / (cm.) ² b_1	Probable Value of Factor G for the Visible Spectrum G	Proportion of Total Radiant Energy Emitted in the Visible Spectrum	
						By a Black Body at Temp. T_c ϕv	By a Non-Black Body Radiator $G\phi v$
(Regular gas-filled tungsten lamps):							
50 watt tungsten	10.0	2685	2670	469	1.25	0.07165	0.090
75 watt	11.8	2735	2705	563	1.24	0.07592	0.094
100 watt	12.9	2760	2740	605	1.23	0.08020	0.099
200 watt	15.2	2840	2810	781	1.22	0.08897	0.109
300 watt	16.3	2870	2840	862	1.21	0.09314	0.113
500 watt	18.1	2930	2920	1015	1.20	0.1003	0.120
1000 watt	20.0	2990	2980	1225	1.19	0.1122	0.133
2000 watt	21.2	3020	3000	1350	1.18	0.1151	0.136
(Special tungsten lamps):							
1000 watt stereoptican	24.2	3185	3175	2065	1.16	0.1407	0.163
900 watt movie	27.3	3290	3220	2660	1.15	0.1476	0.170
10 kw.	31.0	3350	3300	3050	1.14	0.1595	0.182
30 kw.	31.0	3350	3300	3050	1.14	0.1595	0.182

of the radiator is raised, the maximum of the energy curve shifts toward the shorter wave-lengths, and the proportion of energy radiated in the visible region increases. But even at 3000°K. the proportion of the total energy radiated by a black body in the visible spectrum is only about 11.5 per cent. Fig. 2 is an energy distribution curve for a black body at 3500°K. In this case, the curve bounding the black area is obtained by multiplying the energy radiated in the vis-

¹ Micron (μ) = 1000 millimicrons ($m\mu$) = 10,000 Ångstroms (Å).

ible spectrum by the visibility curve. The proportion of effective visible light to total radiation is thus still further reduced.

An incandescent tungsten filament has an advantage over a black body due to its selective radiation, and affords a more efficient source of visible light, but the proportion of energy radiated as heat to that radiated as light is still large. The proportions of total radiant energy emitted in the visible spectrum by tungsten lamps are shown in Table I taken from calculations published by Holladay.² These figures

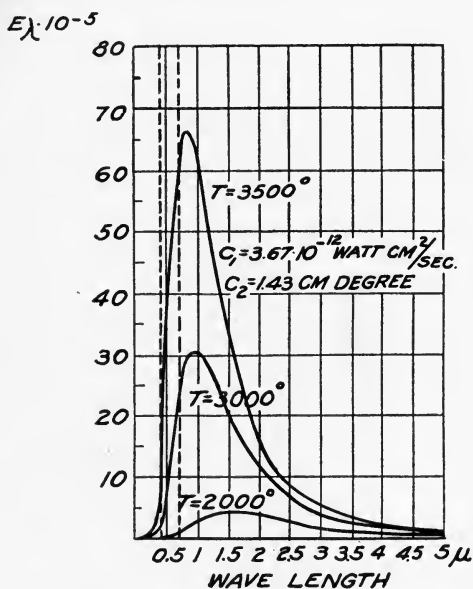

FIG. 1. Energy distribution curve of a black body for different temperatures.

show 9 per cent of the total energy radiated by a 50 watt lamp in the visible spectrum, and 18 per cent for a 10 or 30 kw. lamp. Reference will be made later, in connection with water cooling, to a 1500 watt lamp, and it should be noted here that less than 1.0 per cent of its radiant energy is in the ultra-violet, 13.5 per cent in the visible, and about 85 per cent in the infra-red spectra.

In round numbers, 85 per cent of the energy radiated by a 1500 watt tungsten lamp is in the infra-red region, and constitutes the heat which we desire to eliminate.

² HOLLADAY, L. L.: "Proportion of Energy Radiated by Incandescent Solids in Various Spectral Regions," *J. O. S. A.*, 17 (1928), p. 329.

TRANSMISSION CURVE FOR WATER

In any consideration of the elimination of heat from a beam of light, one thinks immediately of the water cell. The *International Critical Tables* (Vol. 5, p. 269) provide data for the transmission of water, and Fig. 3 is plotted for a layer of water 1 cm. thick. As is shown by the curve, the transmission of 1 cm. of water is high for the ultra-violet, and 99 per cent or more through the visible spectrum. At 1μ it falls to 66 per cent. Beyond 1μ there is one slight rise, but the transmission

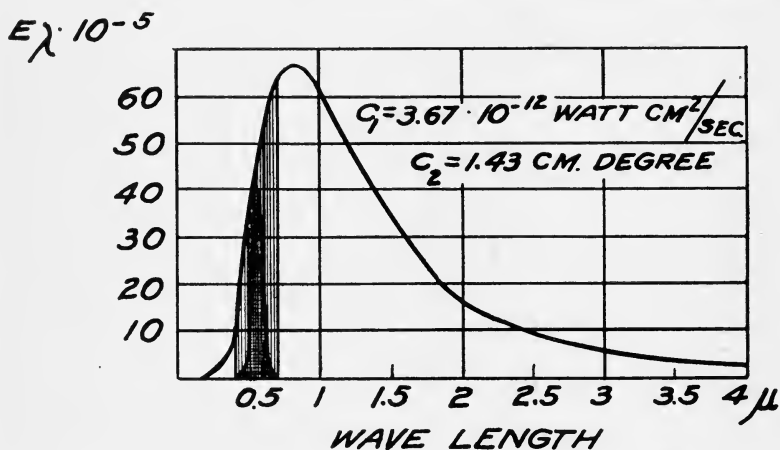

FIG. 2. Energy distribution curve for a black body at 3500°K.

then falls rapidly to 30 per cent at 1.24μ and at 1.4μ is only 3 per cent. At 1.5μ the transmission is practically zero. In other words, water is a very suitable absorbent for heat and has an excellent transmission for visible radiation.

EXPERIMENTS ON RELATIVE ABSORPTION OF LIGHT AND HEAT

The preceding paragraphs have indicated that it should be possible to remove much of the heat from an incandescent lamp by means of a water cell a centimeter or two thick with the loss of but very little light. Data will now be presented showing the relative transmission of light and heat in experiments made in the laboratory with not only water, but also copper chloride solutions as the absorbing media. The first experiment measured the per cent of light and heat from a 400 watt projection lamp transmitted through a water cell one centimeter thick between parallel glass plates. The second experiment involved measurements on a 150 watt lamp operating in air within a double

walled cylindrical glass jacket. The space of 1.7 cm. between the double walls was filled in turn with water, 0.5 per cent CuCl_2 solution, and 1 per cent CuCl_2 solution. The visible light was measured with a photometer, and the radiant energy by means of a thermopile and sensitive galvanometer.

Table II contains the results of these experiments, the data for the 400 watt lamp being kindly furnished by Dr. G. R. Fonda, and by Mr. F. A. Benford and Dr. S. Dushman for the 150 watt lamp. There appears to be some discrepancy for the values obtained with water,

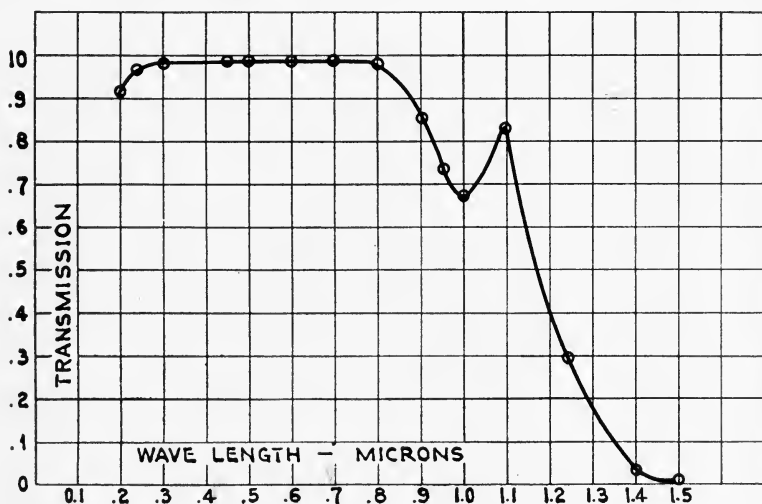

FIG. 3. Transmission of 1.0 cm. of water (*International Critical Tables*).

but I think these may be explained as being due to different experimental conditions. The fact which is most striking, however, is the advantage of a copper chloride solution over water for the relatively high ratio of absorption of heat to light. A layer of CuCl_2 1.7 cm. thick transmits only 8 per cent of the radiant energy for constant light intensity, and this 8 per cent must lie almost entirely in the visible spectrum. However, as is so often the case, certain difficulties must be overcome before copper chloride may be used satisfactorily. These difficulties include hydrolysis of the salt, corrosion of metal parts, and the formation of deposits when slight evaporation occurs. It seemed expedient, therefore, to proceed experimentally with a unit using water as the absorbing medium.

AN EXPERIMENTAL WATER COOLED UNIT

The unit at present in the process of development consists of a lamp immersed directly in the absorbing liquid which is confined by an outer glass jacket. A cooling coil through which tap water is circulated is also immersed in the absorbing liquid. Convection currents set up within the liquid are sufficient to maintain a circulation, and no mechanical stirring is necessary. The lamp, cooling coil, and outer jacket are all supported from a base plate on which the lamp socket is mounted. Two gaskets, one between the base plate and the jacket, and the other between the base plate and the lamp at a point just

TABLE II

Results of Experiments on the Absorption of Heat

Light Source	Absorbing Cell	Light Transmitted	Radiant Energy Transmitted	Radiant Energy for Constant Light
400 w. or 150 w. lamp	None	100%	100%	100%
400 w. proj. lamp	1 cm. H ₂ O; parallel plates	89%	23%	26%
150 watt lamp	1.7 cm. H ₂ O; cylindrical	87%	29%	33%
150 watt lamp	1/2% CuCl ₂ ; cylindrical	85%	10%	12%
150 watt lamp	1% CuCl ₂ ; cylindrical	78%	6%	8%

below the base, make the unit water tight. Fig. 4 is a photograph of a unit for a 1500 watt lamp. The base plate is five inches in diameter, the outer jacket four inches in diameter, and the over-all length fifteen inches. Nine turns of 0.25 inch copper tubing serve as the cooling coil.

This type of arrangement has several advantages. The absorbing layer of water practically surrounds the light source so that almost no radiation reaches the atmosphere of the room except through the absorbing medium. Cooling water is circulated in and confined by the coil so that either distilled water or some heat absorbing solution may be kept permanently in the jacket. The jacket and lamp surfaces are thus kept clean and free from the deposits of ordinary tap water, although tap water is the cooling agent. Another advantage is the possible use of smaller bulb sizes. The temperature of the bulb is not a limiting factor in this case.

In one experiment, a 1500 watt, 115 volt filament was mounted in a special 2.5 inch tubular bulb, and this lamp placed in a unit as shown in the photograph. Measurements were made of watts input into

the lamp, energy dissipated in the circulating water, and light output. The energy dissipated in the circulating water was determined by carefully measuring the rate of flow and the temperature of the incoming and outgoing water. Conversion from the calories so obtained to watts showed that 75 per cent of the watts input was dissipated in the circulating water. Candle power measurements were made on the horizontal photometer, and also in the spherical photometer.

Readings were taken both with and without the water jacket attached to the unit to determine the amount of light absorbed by the

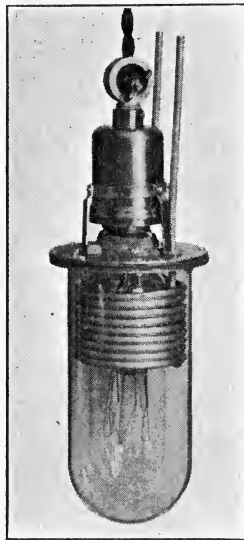

FIG. 4. A 1500 watt water cooled lamp unit.

combined water and jacket. These figures are presented in Table III and show 93 to 95 per cent light transmitted. Seventy-five per cent of the total energy is dissipated by the cooling system. The lumen output from the complete unit with water cell, base plate, coil, and base is 80 per cent of that from the bare lamp without a fixture. This figure is subject to a revision of a few per cent because an oxidized fixture was employed in the spherical candle power measurements.

In order to maintain an illumination from the water cooled lamp equal to that from the 1500 watt lamp without the water jacket it would be necessary to increase the watts in the water cooled lamp about

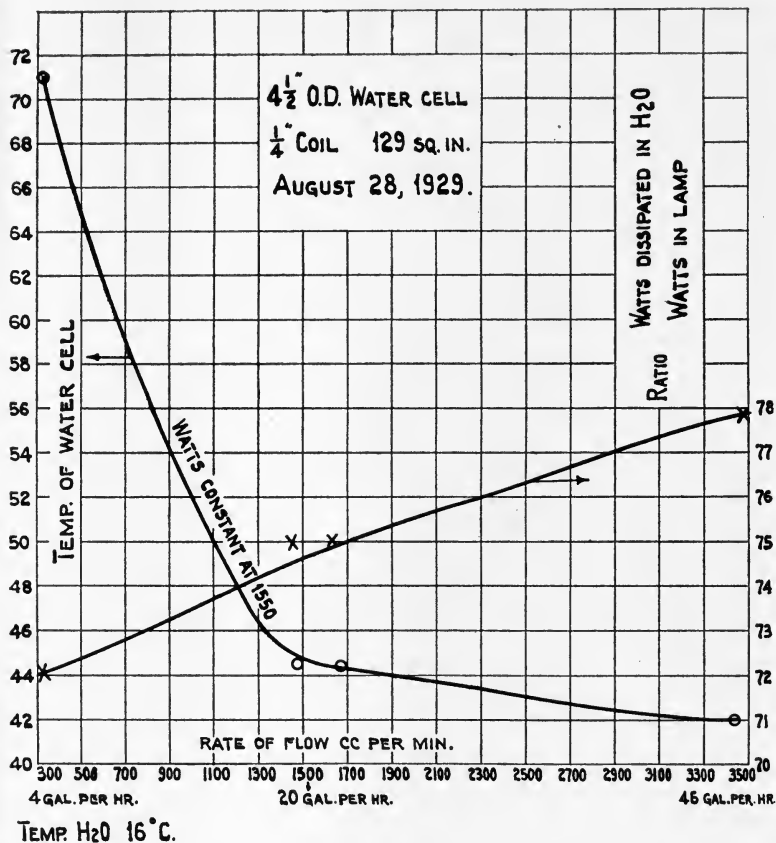

FIG. 5. Effects of rate of water flow on cell temperature and on ratio of energy dissipation to energy input.

TABLE III
Results of Experiments on the Absorption of Heat

Light Source	Absorbing Cell	Light Transmitted	Per Cent Watts Dissipated in Circulating Water	Radiant Energy for Constant Light
1500 watt special	None	100%	..	100%
1500 watt "	2.2 cm. H ₂ O; lamp in H ₂ O	93 (H.C.P.)	75%	27%
1500 watt "	2.2 cm. H ₂ O; lamp in H ₂ O	95 (S.C.P.)	75%	26%

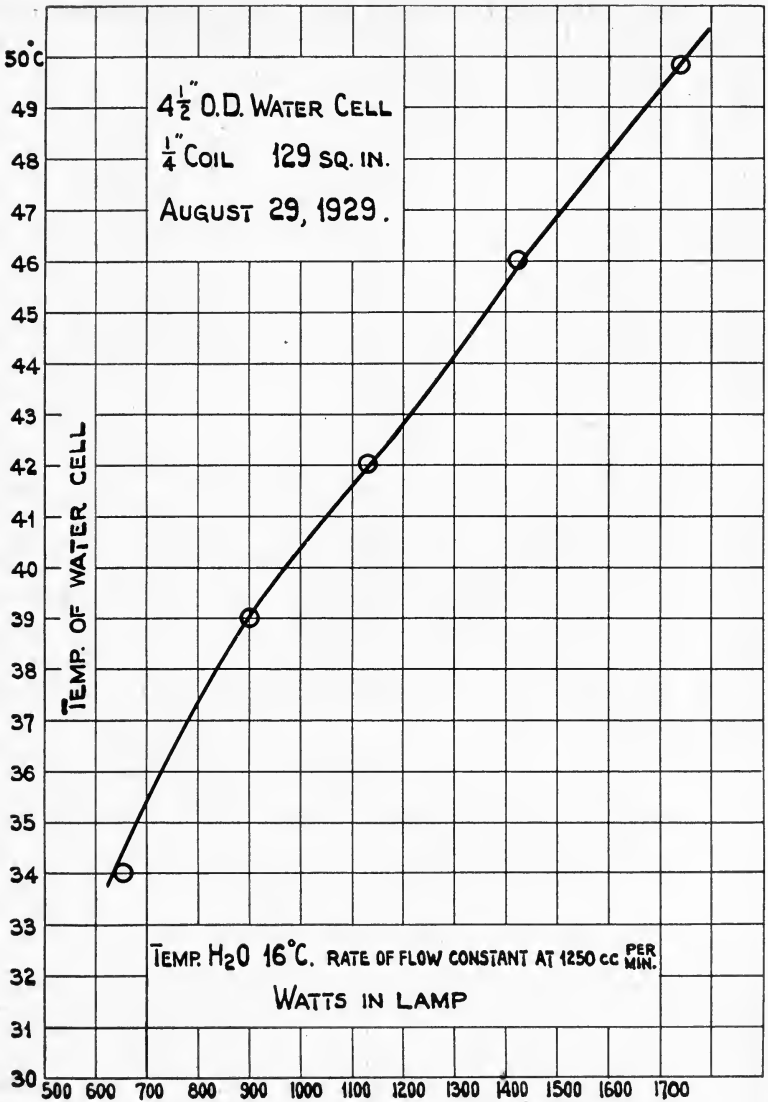

Fig. 6. Effect of wattage input on temperature of water cell.

2.5 to 3.5 per cent. The total radiant energy from this water cooled lamp would then be 26 to 27 per cent of that from the bare lamp as indicated in the last column of Table III.

Fig. 5 shows the effect of rate of flow of the cooling water on the temperature of the water cell, and also on the ratio of watts dissipated in the circulating water to watts input into the lamp.

It will be noticed that it is of little utility to increase the flow of water above 1500 cc. per minute. At this point, 75 per cent of the watts are dissipated in the circulating water and the temperature of the water cell is 44°C. At a flow of 3500 cc. per minute, the watts dissipated increase only 3 per cent and the temperature of the cell falls only 2 degrees.

The effect of change of wattage in the same lamp on the temperature of the water cell is plotted in Fig. 6. This curve indicates that it may be possible to operate a lamp of 1700 watts in a 2.5 inch tubular bulb.

SUMMARY

An experimental device is described for absorbing and removing heat from incandescent lamps by means of a water cell surrounding the lamp. Ordinary tap water flows through a cooling coil immersed in the cell and dissipates 75 per cent of the total watts input for a 1500 watt, 115 volt lamp. The loss of light due to the water cell is 5 to 7 per cent. These figures give some idea of the result obtained by water cooling incandescent lamps, but an actual personal exposure to both the regular and experimental lamps affords the only satisfactory means of comparison.

DISCUSSION

MR. EGELER: The problem of taking care of the heat from the light source is not one which has given concern with the ordinary lighting intensities, but in motion picture projection it has been a subject of discussion previously. A number of years ago some publicity was given to the removal of heat from the light beam in connection with motion pictures of medical work where the effect of this non-luminous radiation was destructive to the specimens. For many years, of course, we have used water cells in slide projectors, and in motion picture photography the problem has come up with the changes in operating practice. With the coming of sound pictures most of the old studios, modified to sound practice, had inadequate ventilation; in the new studio design conditions are made much better by providing adequate ventilation without the noise of ventilating fans. There are several methods of attacking this problem: First, the scheme referred to, taking out the heat with adequate circulation of air. The second way would be to take the heat out of the light beam by putting an absorbing medium, such as glass, on the front of the lighting units, so that the radiation directed toward the actors could be filtered and the heat of the unit removed. The remainder of the radiation would be taken care of by

the ventilation. A third method would be to absorb all of the heat in some medium and remove it from the studio; that is what Dr. Gordon's development does. It actually filters most of the heat radiated by the lamp and by means of circulated water conducts it away from the set. There are present several limitations from the standpoint of operating practice which our studio friends know more about than I do; I had best let them talk on these phases.

MR. MOLE: While the heat coming from the incandescent lamp, when a considerable number are used in a poorly ventilated stage, has been a source of inconvenience to the production studios, I doubt very much whether the studios would be willing to relieve this situation by bringing in additional equipment necessary with a water cooled lamp, as outlined in Dr. Gordon's paper. However, such a lamp would find many applications where the placements are of a permanent or semi-permanent nature; such as operating rooms in hospitals, still and portrait studios, and for close-ups in connection with regular motion picture productions. Many mediums such as clear glass, Florentine glass, and silks are now being used in front of the lamp, which have the effect of absorbing some portion of the heat as well as diffusing the light. I believe that the development work along lines which Dr. Gordon is doing is of very great value and should be carried on, and no doubt in future studio design, provision could be made to accommodate a water cooled incandescent lamp.

We have many members present who are engaged in the operation of the electrical departments of the various studios, and I believe we should hear from them on this particular problem.

MR. PALMER: It seems to me that two very serious objections to this water cooling proposition are, first of all, the element of danger, with so many lamps operating on a set and the necessity for having water flowing through each one in order to keep it from exploding. If the water in the lamp started to boil, the condition would become very serious; it is not always possible to keep water flowing in two or three hundred lamps on the same set. Another objection would be the additional expense for hose and other auxiliary equipment going along with this arrangement. One of the reasons for using incandescent lamps is that they make studio operation more flexible. We can dress a set more quickly and strike it more quickly with incandescent lamps. Mr. Buck has told us of a system to eliminate the use of choke coils on lamps. The tendency in studio operation in the last two years has been toward simpler and more economical methods, and anything which will tend to work in the other direction would not be desirable.

MR. FARNHAM: I should like to call attention to one variation of the water cell and that is the possibility of cooling the water in the vicinity of the apparatus by some means such as a radiator and depending on natural circulation of the water caused by difference in temperature between the cell and radiator. There is a great deal of good circulating air in the more modern sound studios, and such an arrangement would do away with the need for hose connections. All that is necessary is to keep the water below the boiling point. The use of solid filters, such as glass, has been considered. One of the difficulties with some of the glasses is that they alter the color quality of the light, and any glass absorbing heat becomes hot itself, and there is the problem of dissipating heat from the glass, which may be done with air. The glass

is put in, in strips, so that inequalities in temperature causing unequal expansion do not crack it.

MR. EDWARDS: I think that some years ago some experiments were made on artificial cooling with the same general ideas that we have seen this morning. At that time, a modification of a thermo-syphon system was used, and I wonder if anybody has ever tried the idea of a modified form of refrigeration, such as that used in a gas operated refrigerator, for the purpose of keeping a lamp cool. That might be actuated by the natural heat of the lamp itself. I think it is a line on which research might be done.

DR. GORDON: I should like to make a few remarks on some of the objections that have been raised to the water cooling of incandescent lamps. We cannot expect to eliminate the heat by means of water without encountering some difficulty. The question to be answered will be: "Can the water cooling be made so convenient that the objections to it will be more than compensated for by the reduction in radiant heat?" It is thought that the water leads can be combined with the electric leads so that only one cable will be necessary.

When a medium, such as silk, is used before the lamp a loss of more than 50 per cent of the light has been observed so that heat is eliminated only at the expense of a very considerable amount of light. It is thought that a water cell cannot be used in the beam satisfactorily unless the cell is water cooled. Otherwise trouble would be experienced due to leakage caused by excessive expansion and contraction of the cell. Since we have to use water connections to cool a cell placed in the beam, it would seem better to surround the entire lamp with the water cell and take care of all the radiation.

The installation of ventilation systems has been mentioned. In this case, it might be the cost of the ventilation systems against the cost of water cooled lamps, and in some instances ventilation systems might not be required. A ventilation system does not remove the heat from the beam of radiation. Certain lamps which are not movable afford a very convenient place for water cooling since the water leads would not have to be carried around.

In regard to the risk of explosion, we have let lamps operate without circulating, the water. The water heats up, starts to boil, steam escapes through the gaskets, and if you let this continue the lamp bulb will crack when the water is about half evaporated. So far we have had no outside jacket break and have experienced no trouble from explosion.

THE DEVELOPMENT OF TELEVISION AND RADIOMOVIES TO DATE

C. FRANCIS JENKINS*

Radiomovies for entertainment in the home have progressed rather satisfactorily during the year. Our audience on 46 meters has grown in a year to some 18,000 or 20,000. To distinguish them from the radio fan with a set which covers only the entertainment band from 200 to 550 meters most of this audience are known as amateurs.

This limitation of visual radio to short wave channels comes about because the Federal Radio Commission does not at present permit visual broadcast in the audible entertainment band. That is the reason we cannot encourage the purchase of a television attachment for your present set.

The surprising quickness with which our radiomovie audience has been built up is largely accounted for by the fact that the amateur already had his radio set for code communication on 40 meters, and all he had to do was to attach a radiovisor to his receiver, tune 6 meters farther along on his dials, and pick up our radiomovies, broadcast from W3XK, Washington. Because we published a broadcast schedule on which he could depend, he rigged up his visual radio receiver with confidence.

Our broadcasts were well received rather widely over the United States, very dependably as far west as Denver; occasionally we got reports from California, Canada, Cuba, and Porto Rico of reception on the 46 meter channel. But as 46 meters gave double images in local territory, we also simultaneously broadcast on 186 meters for Washington, Baltimore, and other nearby receivers. As with audible radio there are locations in which reception is better than in other places.

An amateur in Cold Springs, Iowa, explained that he happened to tune in on our initial radiomovies broadcast, July 2, 1928, and that he had missed very few of our broadcasts since, and then only because of absence from home at our broadcast hour. We believe his reports authentic for we have checked him up; which we easily do by

* Jenkins Laboratories, Washington, D. C.

comparing reports from amateurs with the order of picture sequence in the broadcast on that particular evening.

All the broadcasts have been in photographic silhouette, or in black and white cartoon drawings. But those cartoonists we have patronized don't seem to be able to grasp the requirements of radiomovies, and so, after spending considerable money with them, we abandoned the cartoonist as an undependable source of picture story for us.

I had, however, designed a silhouette studio equipment which was already working excellently, and with which we can produce radiomovie stories in silhouette as fast and as satisfactorily as is usual with regular movie negative in regular movie studios, and at small cost.

When I first designed this equipment and worked out the operation methods, I really did not think of it as new; but it seems on search of available motion picture references that this is a new attainment.

We also discovered scenario writer talent in our laboratory staff, and so we are a self-sufficient institution, from story concept to the reproduction of this movie story in your house, delivered there over radio channels.

All of these broadcasts were on ten kilocycle channels. Some months ago the Federal Radio Commission, on the showing of what we had already accomplished, and the explanation that radio transmission of the halftones of television and regular theater movie film required a broader channel than the ten kilocycle width employed in audible radio, set aside eight channels, each one hundred kilocycles wide for visual radio.

We then immediately proceeded with the erection and equipment of a powerful station in the country about five miles north of Washington. The broadcast frequencies were 2850 to 2950 kilocycles and 2000 to 2100 kilocycles, for distant and for local reception, respectively. This station's broadcasts are well received by those who have rebuilt their radio receivers for the new frequencies, but I am doubtful that we shall build up as large an audience on these frequencies as quickly as we did on the old frequencies.

Of the little kit set receivers we sold many thousands at \$2.50 each. They cost \$3.10, but I made money because I sold so many of them.

That is literally true, for we built up a demand for a better receiver, and a public confidence that television and radiomovies was a practical thing, possible of wide usefulness as development progresses.

To date, the quartz or glass rod drum scanner continues to represent the best type of receiver. It makes a larger and brighter picture with

simpler mechanism, and less amplification, than any other form yet produced.

How long it will remain the best form of receiver no one knows, for thousands of engineers, my own staff included, are feverishly at work on the problem.

A different type of receiver is used on occasions, namely, the lens scanning disk (U. S. patent No. 1,679,086) used in the General Electric television demonstration at the New York Radio Show last winter. This receiver with a high intensity neon light source projects a rather creditable size and brightness of picture, as those of you who saw it will remember.

But all the different mechanisms demonstrated to this time have a common limitation, fatal to extended development, in this art, namely: they all depend upon persistence of vision for success. While interesting results have been attained with the old scanning disk, there is not much opportunity for extended practical development.

It is quite surprising to figure out the efficiency of the light source on the eye of the observer, and find that it is only about one-fifty thousandth ($1/50,000$) of one per cent, which probably accounts for the slow development of this art.

This extremely low efficiency comes about because of two basic errors of concept of the problem involved, namely: (1) that each elementary area light-source should be at least as large as the whole area of the picture itself; and (2) that persistence of vision of the eye should be depended upon for an assembly of the elementary areas of the picture.

Theoretically, (a) no more light-current is actually required than that needed to illuminate a single elementary area at any moment considered; and (b) a real picture should exist in the receiver whether there is a human eye to see it or not, that is, it should be possible to photograph the received picture with a snapshot camera. This cannot be done with the disk scanner method.

Plate Receiver.—The plate receiver, however, is designed and built to embody both these essentials and consists of a picture plate divided into 2304 elementary areas, that is, 48 lines with 48 picture elements in each line.

In the construction described the picture area consists of 48 horizontal rows of flash-light lamps, with 48 lamps in each row. These lamps are inserted in a corresponding number of holes in a plate sup-

ported, preferably, in a vertical position, each lamp being an element of the picture.

The lamps are divided, electrically, into four banks. Each lamp is individually wired to its particular contact of the switching gear. All the lamps in each bank have a common return connection, and the lamp face is, for certain uses, covered with ground glass or the like, for soft diffusion in the finished picture.

The switching gear is a four-part device, each of the parts being connected to its particular bank of lights. Such a division permits the construction of a commutator but one-fourth as large as if it were a single commutator structure. A 3600 rpm., $\frac{1}{2}$ hp. synchronous motor is quite suitable for driving the commutator brush in city service.

In operation, the motor being started, the incoming amplified radio signals are distributed to the several lamps in succession, fully lighting some of them, lighting others to partial brilliancy, and leaving others unlighted. The result is a picture built up in lights and halftones and shadow on the face of the plate, or the glass diffusion cover.

The picture on the plate is made up of glowing lamp elements, which persist in light value for an appreciable time, say, a tenth of a second. But as the exciting impulse is applied every fifteenth of a second, the lamp is aglow for the whole time the corresponding elementary area of the scene at the transmitting station is alight.

That is, in this scheme, persistence of light is substituted for persistence of vision, and the whole of the received picture is on the plate all the time instead of only a fractional part ($\frac{1}{2304}$ th)—an elementary area time of the picture.

The amount of light available is the average light of a single lamp multiplied by the number of lamps. The average light of a single lamp can be approximately the normal lumens of the lamp because it can be flashed with a very much higher voltage than if the voltage were applied continuously.

Assuming a $\frac{1}{2}$ inch diameter lamp, the multiple lamp plate would be 2 X 2 feet square, as we built it. In front of this light source a lens is mounted for projecting it onto a theater screen. As the light source is the picture itself, the only loss of light in the projection is the reduction in foot-candles which results from the magnification. And fortunately the light is the usual color, that is, white light, not the pink light characteristic of neon.

Such a receiver-projector will ultimately enable the producer to distribute motion pictures to the theaters by radio instead of film, doing away with the present profit-consuming film exchange.

A transmitter is also made on this same principle, in which light sensitive elements are substituted for the lamp elements in the receiver.

I am confident this principle, broadly illustrated and first described by me in *The Electric Engineer*, of July 25, 1894, will ultimately be universally adopted. I am encouraged in this belief because the Patent Office has officially declared eleven other inventors to be in interference with my application.

A NEW METHOD OF BLOCKING OUT SPLICES IN SOUND FILM*

J. I. CRABTREE AND C. E. IVES

A splice in motion picture film which bears a sound record usually introduces extraneous noise in the reproduced sounds unless some means is taken to obscure it. Rapid variations in light transmission of the sound record area are productive of sound and the reproducing equipment is, of course, unable to distinguish between the record proper and such extraneous variations.

It is not difficult to see that a badly aligned splice surrounded by cement smears, finger prints, abrasions, and dirt spots could produce noise. Even though the splice is made with the greatest care and precision, however, a very objectionable noise might be introduced as a result of the passage of a splice joining parts of the sound record between which there is an abrupt change in transmission. This condition is liable to be encountered even if the method of joining were capable of eliminating all other mechanical imperfections such as roughness of the cut edge and light loss produced by refraction at the edge. Therefore, noise will be produced if the change in transmission between the contiguous areas is large and abrupt enough to come within the range of the reproducer.

If the transmission of the area illuminated by the slit in the reproducer is reduced gradually until it is insignificant at the time when the splice passes, then no noise will be made by the splice in passing. The rate of decrease of transmission must be less than that corresponding to the minimum frequency attainable in the reproducer system.

Remedy for Splice Noise.—It has been found possible to eliminate the splice noise by applying an opaque coating to the sound track (Fig. 1) in such a way that as the film travels past the slit the effective transmission is gradually reduced to a very small value and then increased in the same manner.¹ It is much easier to apply an opaque coating in the shape of a wedge than to vary the thickness of the coat-

* Communication No. 411 from the Kodak Research Laboratories.

¹ *Movitone Bulletin*, 1, No. 31 (Aug. 4, 1928).

ing, so the overlay usually is made to resemble a ten to forty cycle variable area signal.

When a splice is "inked out" or "painted-out" in this way in the negative, it leaves an area of high transmission in the positive which is very easily scarred so that it might cause ground noise. In the positive, the "paint-out" does its work very well. India ink has been used in this way but becomes brittle and develops very noisy cracks. An opaque lacquer has proven more satisfactory.

Improvement in the Method of Masking Out.—In a processing laboratory it is quite possible to make good "paint-outs" by applying a black lacquer with a fine brush either with or without the assistance of a stencil. In the hands of a skilled worker making many hundreds

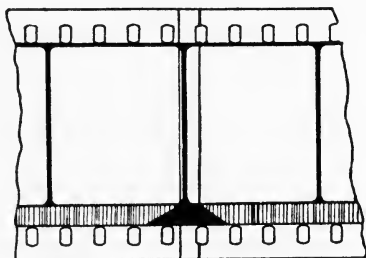

FIG. 1. A typical "paint-out."

in a day, this method has proven satisfactory, but in the projection room of a theater different conditions exist. It is often necessary for the projectionist to make a number of splices in a few minutes when a new picture is received, and since he is not doing the brush work frequently, it is difficult for him to make a satisfactory "paint-out" quickly with the result that more noise is liable to be introduced by a poor "paint-out" than would have resulted from the splice in the first place. It was obvious that the solution of this problem lay not alone in the use of a quick drying lacquer, but in devising a rapid method of applying it.

Various types of stencils constructed of the following materials were tried: cardboard, rubber, inking roller gelatin, steel and rubber plated metal and steel. A slow drying lacquer or ink could be used with any of the above devices, but in the case of rapidly drying lacquers, if the brush contained sufficient liquid to make the film opaque with one or two applications, the more mobile, rapidly drying inks were sucked in under the edge of the stencil by capillary attraction,

and a very irregular edge was produced. This effect did not occur when a thick lacquer was used, or when very small quantities of the thin lacquer were applied repeatedly, but this procedure was so slow as to be of no advantage. It was then considered that an opaque sticker or patch of suitable material and design could be applied rapidly enough for this purpose. A gummed paper patch was first tried. This could be applied readily and eliminated the splice noise, but became brittle and sometimes peeled off after the film had been projected a few times.

Decalomania transfers were also tried but found unsuitable. These transfers as purchased consist of a sheet of material, 0.001 inch thick, attached to a thick paper. They are soaked in water and the transfer then floated off onto the gelatin coated side of the film. This type of patch dries too slowly and does not become intimately attached to the film in the region of the splice, because there is no fusing together as with a cemented patch.

An opaque film was then made by incorporating dye and pigment in motion picture film base, but when the cement was applied to patches made from such film they curled excessively. A critical thickness of four-thousandths of an inch was necessary in order to prevent curling. This thickness was considered excessive. If the film base was coated with a gelatin layer, this materially reduced the curling tendency.

The film patch material finally adopted consisted of clear film base, emulsion-coated, and rendered opaque by exposure and development. A film of minimum thickness (0.003 inch) was chosen so as to conform readily to the irregular surface of the splice and prevent the splice from becoming too thick and stiff.

This type of splice (Fig. 2) was very successful. The patches were tested by applying them over splices in a positive film which was then run through a projection machine until the film broke down completely. The patches were intact up to the time when the perforations commenced to fracture at the corners.

The Splicing Operation.—The patch is applied with the aid of a registration block shown in Fig. 3. This consists of a bed plate fitted with registration pins and a pressure platen fitted with a rubber pressure plate. The platen is hinged to the bed and the rubber pressure surface is cut out so that it fits closely around the pins.

The motion picture film is placed on the registration block with the support side up and that side of the strip which bears the sound record

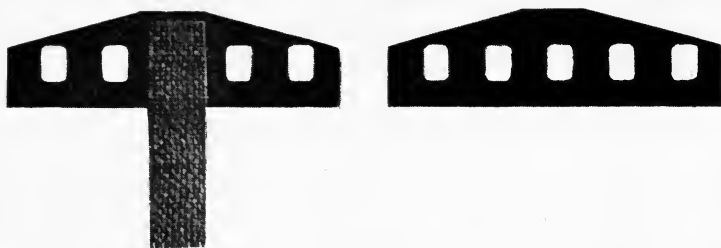

FIG. 2. The patch with and without finger tab.

in engagement with the four pins. The splice is placed at or near the center of the block. The pins fit the perforations so closely that pressure clips for holding the film in place are unnecessary. When the film is in position on the block the patch is picked up and held at one end by means of tweezers or an attached tab while cement is applied to the side which is to come in contact with the film strip. The cement application is accomplished by a single stroke of a soft cementing brush of medium size. The patch is placed immediately on the registration pins, the pressure plate brought down, and held in position for about five seconds.

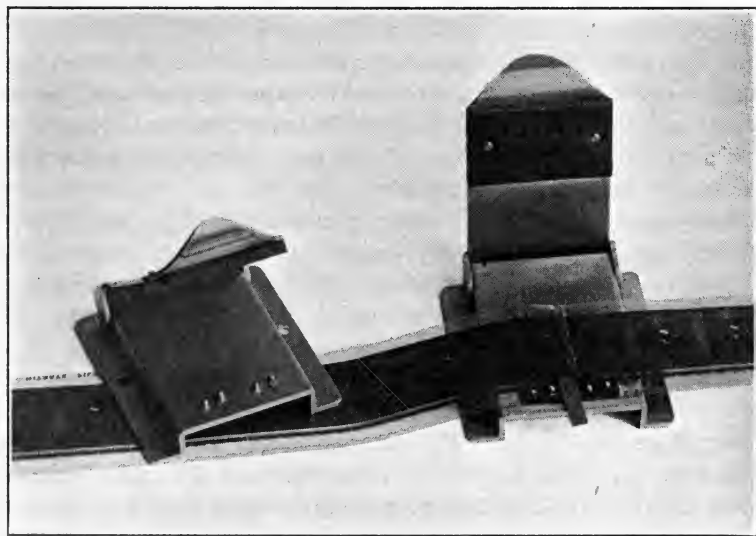

FIG. 3. Registration block showing film and patch in position on pins.

The patch which proved most successful was so made that it covered the entire width of the sound track completely and extended as far as possible toward the center of the film strip without entering the picture area. Some of the factors which entered into consideration of the best design for the patch are discussed below.

Design of Patch.—As mentioned above, the patch or a "paint-out" performs its function by masking off an area of sound track of varying width so as to reduce the total transmission of the area illuminated by the slit in the reproducer at a rate which is insufficiently rapid to cause the recorder to generate an audible sound, and then, when the splice is past, uncovering the track in a like manner.

The reproducers now in use are capable of generating sounds of a frequency not less than 20 to 50 cycles per second. Therefore, if the splice is to be designed so that it will cause no noise of itself, it should vary the transmission as it would be varied by a signal whose frequency is not more than 20 cycles. Such a signal would be represented by a patch whose contour would be described by a sine curve of an amplitude corresponding to full modulation. Its length for 20 cycles would be

$$\frac{18 \text{ inches}}{20} = 0.9 \text{ inch.}$$

Now it might be argued that this length causes a noticeable discontinuity in the sound. This is not so serious as might seem. A patch having straight instead of curved sides has been considered because it is much more easily made, especially if it is to be cut by hand. If the patch is shorter (about one-half this length, as has been recommended), the harmonics introduced by using a straight edge for the cut-off as an approximation for an edge of curved contour, are of a higher frequency and therefore more prominent. Also, the fundamental is well within the range of the reproducer.

The following tests were made with a view to arriving at a design which would be a compromise between one which would be audible and one which would obscure too much of the sound record.

A number of patches having dimensions indicated in Fig. 4 as shown in Table I were made and applied to (1) an oscillator record of low modulation (frequency 540 cycles); (2) a strip of clear film of density about 0.1; and (3) a strip of film flashed and developed to produce a uniform density of about 0.7. In each of these films two splices were made with 5 feet of film between them and then 17 feet

were skipped before another splice was made. The first splice was left bare, the second was covered with the patch, and then 5 feet beyond the second splice a patch was mounted at a point where there was no splice. In this way each of the patches in the table was prepared for test. In order not to have any bad corners it is desirable to avoid cutting across perforations so that the choice of lengths is limited.

TABLE I
Experimental Patch Dimensions (See Fig. 4)

Patch No.	A	B	C
1	0.09 in.	0.29 in.	0.10-0.12 in.
2	0.1875 in.	0.65 in.	0.10-0.12 in.
3	0.1875 in.	1.00 in.	0.10-0.12 in.
4	0.1875 in.	1.40 in.	0.10-0.12 in.

The tests were made by running these strips through a standard type of reproducer operated at a normal gain setting. The modulation of the oscillator record was such as to produce at this gain setting a volume corresponding to normal speech. The noise from a well made splice, made with a widely used mechanical splicing machine, was plainly audible.

In general, the noise produced by a plain splice was least noticeable in the oscillator records, more noticeable in the 0.7 density, and most in the 0.1 density film. The patch number 1 produced a plainly

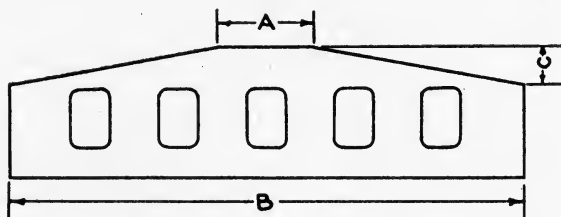

FIG. 4. Dimensioned sketch of patch.

audible sound, number 2 was somewhat less loud, and numbers 3 and 4 were only just audible on the 0.1 density film and apparently about equally effective.

Numbers 3 and 4 were noticeable because of their obscuring the oscillator record for a perceptible duration of time. Number 2 did

not cause a noticeable interruption. The best length of patch is therefore indicated by number 2 or 3, number 1 being noisy of itself and number 4 interfering with the record for an unnecessarily long period of time. With reproducing systems which are capable of reaching 20 to 30 cycles it is necessary to use the number 3 size, because the smaller patches make an offensively loud sound.

The patch should cover the splice at the widest point. This con-

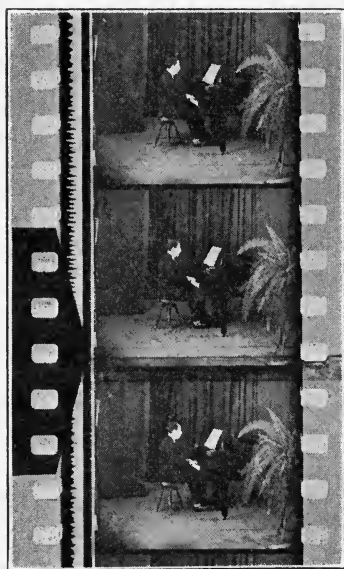

FIG. 5. Spliced film with patch.

dition is satisfactorily fulfilled when the sound track is completely obscured for a distance equal to 0.098 inch each way of the center line of the central perforation (Fig. 4 at *A*). This allows for the standard "full-hole" splice. It is advisable to have the patch extend inward almost to the picture frame. Then there is no danger of leaving part of the splice uncovered through an inaccuracy in mounting the patch.

A total length of 1.00 inch was found best because of these considerations. A spliced sound record film fitted with the patch is shown in Fig. 5. The sloping sides have a length along the sound track of, in this case, $1.00 - 0.1875 = 0.8125$ inch, or 0.4102 inch

each. This is slightly shorter than that for the one-half wave length at 20 cycles (0.45) and corresponds to a frequency of about 22 cycles.

The patch is very much easier to handle if it is supplied with a finger tab, consisting of a strip of stiff cloth attached with a non-permanent adhesive. (See Fig. 2 at left.) The tab is readily removed in the same manner as ordinary surgical adhesive tape.

A LIGHT INTENSITY METER

J. L. McCOY*

Ever since the beginning of photography, the judging of light value has been one of the great problems, to the photographer or camera man. In many cases in the past as now, the person responsible for taking of pictures is required to judge light values using his naked eye as an indicating means. His accuracy or ability to do this is the product of his appreciation and his experience as received through this natural indicator. The unassisted eye at its best is considered unstable with a possible error of 100 percent or more from day to day when used as a light intensity measuring instrument. It is unreasonable to expect that two or more men would come very close in a simultaneous check. In order to assist the eye in measuring light and to obtain consistent results, several types of photometers have been developed. In most cases, these instruments are rather awkward to use because they require a comparatively slow process of matching of light intensities, to obtain a reading. Therefore, they might be classed as laboratory equipment, from a studio standpoint, rather than practical and portable direct reading indicators.

As a natural result, there has been a need for a studio type of photometer that could be worked, set up, and read quickly without making adjustments. For this reason, the Westinghouse Lamp Company and the Westinghouse Elec. and Mfg. Company have designed this new tool, to place in the hands of the photographer or camera man to assist him in his work.

This new indicating electrical eye should have the same value to the camera man as the slide rule to the engineer. It is a quick reading light yardstick as simple as a voltmeter to read. As this is a very new development, we are not sure just what the possibilities or limitations of this device might be, but it is felt that it has a wide application in the motion picture and other photographic industries.

This meter is self-contained and carried as a complete unit in one case. The light sensitive pickup is a photo-electric cell covered

* Westinghouse Lamp Co., Bloomfield, N. J.

with a shield. A window is cut in one side to admit the light to be measured. The photo-electric cell unit is connected to the meter by a six foot double conductor cord making it possible to move the cell unit around within that radius without moving the case. The instrument contains a commercial, portable microammeter calibrated directly in foot-candles. The smallest size "B" batteries are wired and mounted in the case. As very little energy is required, the battery life will be about its shelf life.

The photo-electric cell is generally known as a light-sensitive tube having somewhat the appearance of a radio tube. The tube has two distinct parts, an anode and cathode. The cathode is coated, light-sensitive material giving the tube its characteristics. The resistance of the cell will vary with the intensity of the light which strikes it.

Many other commercial uses have been found for the photo-cell. It is used as a smoke detector to sound an alarm in case of fire or to count the product of quantity production as the cars are counted as they pass through the Holland Tunnel by the interrupted beam of light. The cell plays an important role in several different schemes of motion picture sound reproduction.

There are a number of different types of cells and their characteristics vary materially with the elements used. They can be made of different materials to respond to different wave-lengths of light. Dr. Rentschler of our research department has constructed a photo-electric cell that will respond only to the ultra-violet region of the spectrum. This cell is now being used in an ultra-violet recording device, making it possible to obtain a quantitative reading in ultra-violet units.

The cell used in our light intensity meter is a special cell having a very broad response, covering the visible spectrum. This response is such that it will fit in very well for light measurements where the combination of Mazda light and panchromatic film is used. A spectroscopic study of the response of the panchromatic film when plotted against the light of the Mazda lamp shows that the results are somewhat near a straight line, making it possible for the meter to give an integration that will come close to the photographic results obtained with given light values. The use of this meter is suggested to be of considerable value when colored pictures are taken because of the integration of the values of different wave-lengths of light through the visible spectrum. The same cell can also be used for the measurement of north sky daylight, giving approximately the same values for the same intensity from a photographic standpoint. The photo-cell

as used is directional in its pickup making it possible to study the light from different angles. The pickup can be made non-directional if so desired.

The sensitivity is such that a range of full scale readings can be made from 100 foot-candles to 3000 foot-candles. We believe the range of 400 to 500 foot-candles, as read on a full scale of 1000 foot-candles will fit the studio requirements the best, but this is a matter to be controlled by the professional studio man.

In order to provide a simple and effective means of calibrating the meter, without returning it to the factory, we plan to mount a low voltage lamp in the meter case to check the cell for calibration. At a definite spacing a calibration check can be easily made. The lamp will be a six volt type to be supplied with energy from a six volt external battery.

Mr. M. W. Palmer of the Paramount-Famous-Lasky Corp. has been doing some work with this photometer during the past few months, to determine the light values on motion picture sets. He has informed me that while he was checking the light reflected from an actor's face, the light intensity meter picked up the change in illumination caused by this man lighting a cigarette. This incident may illustrate how sensitive this device is to change in light intensity.

We believe this device has an application in connection with film printing machines. There are a number of different settings of the printing lamp required to have the film printed without glaring or too dark results. To control this condition, the different settings must be made by the operator. In order to try the light intensity meter for this application, a special mask for the photo-cell has been made to fit into the aperture of the printer. Mr. La Grande of the Paramount-Famous-Lasky Corp. has been making tests to determine the meter's value in this field.

The meter has also been suggested as a means to analyze the light on a motion picture screen.

As we feel this is a step in the right direction and there is a commercial field for this meter, we should like very much to have the comments of the interested engineers.

DISCUSSION

MR. JONES: I should like to inquire whether the author of the paper has data available showing the spectral distribution of sensitivity for the cell, also what he considers to be the certainty with which readings can be made. Is the instrument at present commercially available?

MR. MCCOY: Data on the spectral response are not available at the present moment. The instrument is commercially available in certain full scale values. The meter has an accuracy of probably plus or minus 10 per cent.

MR. JONES: Do I understand that the cell as used gives an indication which is directly proportional to photographic intensity in the case of the panchromatic film-Mazda lamp combination and directly proportional to the intensity of north skylight? Do you propose to publish the data with the paper?

MR. MCCOY: We have not proposed to do so, but I see no reason why it should not be published.

MR. JONES: It would add to the value of the paper to have direct data on the sensitivity.

MR. MCCOY: This device is very new. We have just gotten it off the "griddle."

MR. PALMER: (Communicated.) We have found this instrument very useful around the studio for quick tests. Recently we had submitted to us several reflectors for which great claims were made as to their efficiency. We took readings with this photometer and determined their relative value immediately. We have also used it in checking the relative amount of light in various parts of a set. We are interested in relative values. We can take a light measurement with this instrument today and if we have to retake the same scene several weeks later, we can use the same light value. I believe this instrument is of great importance to the industry and new uses will be found for it from time to time.

A NEW SYNCHRONIZING APPARATUS FOR 16 MM. FILMS WITH DISK RECORDS

WM. H. BRISTOL*

In the operation of motion picture projectors, where the film is synchronized with sound recorded on a disk or on a film, the standard speed of the projector is 90 feet per minute or 24 frames per second.

It will be understood that the sound record, whether on a disk or on a film, must be reproduced at the same speed it was originally recorded, and in order to use the standard theatrical, synchronized film, whether of original width or whether reduced to 16 mm. width, it will be necessary to project the pictures at this standard speed of 24 frames per second.

Professional projectors are always operated in booths for fire protection, which at the same time prevents the audience from being disturbed by the noise of the machine. All projectors, whether made for 35 mm. or for 16 mm. films, when operated in the open without a booth at the standard 24 frames per second, make so much noise that it is practically impossible to reproduce synchronized sound pictures satisfactorily. Projectors for amateur use are designed primarily to be operated at 16 frames per second. At this speed, it would usually be impossible to synchronize theatrical records, as they would only be running at two-thirds of the normal speed at which they were recorded.

To avoid the difficulties of operating these projectors at the abnormally high speed that would be necessary to maintain synchronism and give correct reproduction of the sound, we have found, by experiment, that we can remove every third frame from the synchronized film, thus reducing it to two-thirds of its original number of frames and when projected at two-thirds the speed at which it was originally recorded, perfect synchronism will be maintained between the shortened film and the original sound record. Although by this plan we have eliminated every third picture, we have found that, due to persistency of vision, it does not detract from the natural action of the picture.

* Bristol Studios, Waterbury, Conn.

By a specially designed printing machine, we are able to make prints from the original theatrical negatives, either of the standard width or the 16 mm. width, with every third frame eliminated. Such prints can then be used in either 35 mm. projectors or 16 mm. projectors at the reduced speed of 16 frames per second, still producing results equally as good as though the pictures had been originally taken at 16 frames per second. When projecting these shortened films, it is

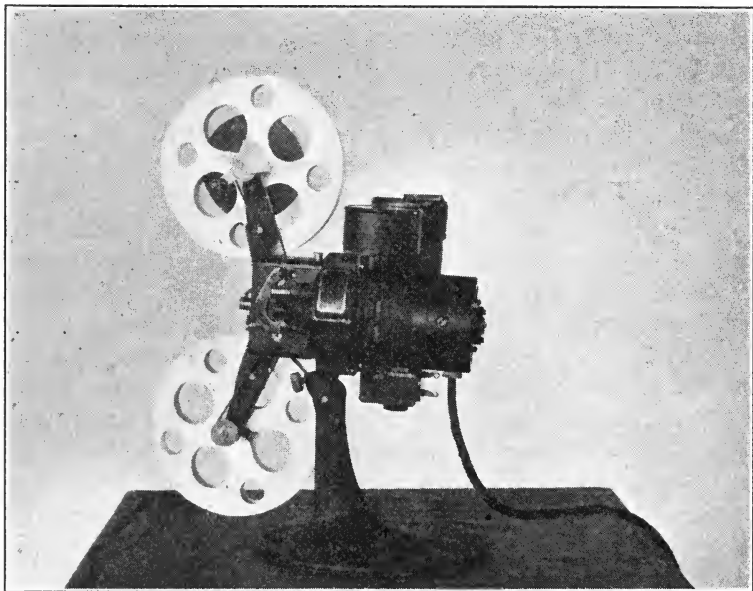

FIG. 1. Bell and Howell projector with synchronizing motor attached.

necessary to use a shutter designed for the projection of 16 pictures per second in order to reduce flicker to a minimum.

The complete outfit for reproducing these special synchronized 16 mm. or any other 16 mm. films, consists of a turntable unit connected electrically by a small cable of any convenient length to the 16 mm. projector, using the special synchronizers described in a paper presented at the meeting of the Society of Motion Picture Engineers, September, 1928.

We have developed a method of using the same type of synchronizing motors which were previously described, but now made up into smaller models, especially for non-theatrical, industrial, and educa-

tional uses, so that the synchronizers can be used to replace the motors that are usually employed in 16 mm. projectors. For illustration, in the 16 mm. Bell & Howell projector, we have been able to substitute for the motor which is usually supplied, one of these synchronizers. Fig. 1 is an illustration of the Bell & Howell projector with

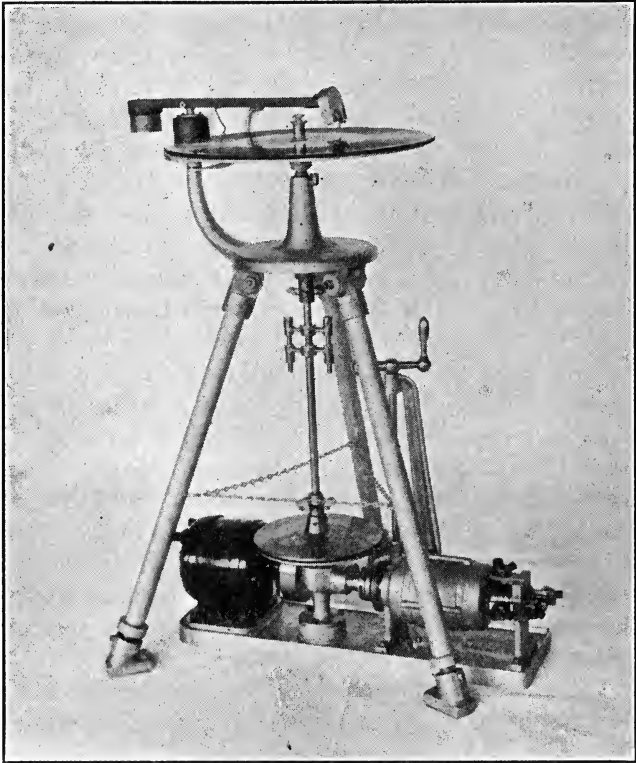

FIG. 2. Turntable mechanism and its support.

this synchronizing motor applied. There is no other change in the projector, since the gearing at the turntable is made to give the correct speed ratios. The cord shown is a cable leading to a companion synchronizing motor, which is shown at the right-hand end on the base of the turntable (Fig. 2).

The electric motor which is shown on the left-hand side of the base,

through a worm and gear located in the center of the base, rotates the turntable by means of a vertical shaft at $33\frac{1}{3}$ revolutions per minute. The motor, in addition to driving the turntable, also turns the rotor of the synchronizing motor on the base, which generates the current to drive the synchronizing motor shown as a part of the projector in Fig. 1.

In order to make the synchronizing motor small enough to replace the original motor in the Bell & Howell projector, it is necessary that this motor should run at high speed, but such a high speed is undesirable at the turntable, as it may make noise and cause vibration, interfering with the perfect reproduction of the sound.

We have always made the synchronizers so that one drives the other at the same speed as has been previously described, but in this case the turntable synchronizer is made to drive the projector synchronizer at twice its own speed. This is accomplished by making a four-pole synchronizer at the turntable and a two-pole synchronizer for the projector. The field of the turntable synchronizer is mounted on trunnion bearings, so that it may be rotated independently of the rotor of the turntable synchronizer. The rotation of this field on its trunnion bearings in a direction the same as the rotor is turning will cause a decrease in the speed of the projector, while the rotation of this field in the opposite direction to that of the rotor will increase the speed of the projector without in any way affecting the speed of the turntable or quality of the reproduction. The handle shown in the illustration (Fig. 2) may be used for revolving the field of the synchronizing motor in its trunnion bearings through a pair of gears. By means of this, perfect synchronism may always be maintained without in any way disturbing the projection of the picture on the screen.

It is of the utmost importance that the turntable be absolutely free of vibration in order to obtain perfect reproduction, especially of music. To accomplish this, we have developed a mechanical filter system which has proven very simple and efficient. The turntable is mounted on a tripod, which stands on the floor, independent of the base carrying the motors. A vertical shaft connecting the motor base with the turntable is provided with several flexible metal disk joints, designed particularly to filter out the vibration that would otherwise be transmitted to the turntable from the motor base.

In addition to these flexible disks, there is also a double sliding joint which is clearly shown in Fig. 2. This double sliding joint, working in conjunction with the flexible filter disks, has proven to be a most

practical way of eliminating vibration, which would ordinarily be transmitted from the motor.

In conclusion, I would like to call your attention to some of the advantages the author considers are to be gained by the use of these shortened synchronized films. First, the noise of the projector is kept down to a satisfactory level without using a sound proof cover, thus not interfering with the accompanying sound reproduction; second, the wear and tear is reduced on both the projectors and films which means longer life for both; third, by using the film of reduced length, there will be an appreciable saving in the cost of the prints, handling, storage, and transportation; fourth, this slow speed allows for increased length of the running time; fifth, the small space occupied by the equipment and the simplicity of its construction makes it easy to operate and desirable for homes, class-rooms, churches, clubs, lodges, *etc.*; sixth, the ease with which the outfit can be packed, transported, and set up makes it portable and practical for demonstration and commercial purposes.

DISCUSSION

MR. TAYLOR: When every third frame is cut out isn't there a jiggling movement where something moves uniformly across the screen?

MR. BRISTOL: We have found, as already explained due to persistency of vision, there is no flickering and the picture appears to be the same on the screen as if every third frame had not been eliminated.

ABSTRACTS

Sound Film Processes. W. STULL. *Photo-Era*, 63, August, 1929, pp. 70-5. Wax disk and sound-on-film, both variable area and variable density methods of sound film processes, are described. Two processes, the Paramount and the Gaumont-Petersen-Poulsen, record the sound on a separate film and later print it on the picture positive. Recording practice as well as reproduction are described.

Sound Film as Adjunct in Medicine, Law, and Criminal Practice. H. ROOM. *Kinotechnik*, 11, Aug. 20, 1929, pp. 430-1. The author stresses the value of sound pictures in fields outside of the amusement field, such as in medicine, law, and criminal practice. Actual voice recording of wills, testimony at trials, property sales, and other uses would make records of greater value and accuracy than written records.

Interchangeability of Sound Equipment. R. H. CRICKS. *Kinemat. Weekly*, 151, Sept. 12, 1929, p. 176. Original standards in sound equipment were set by the Western Electric Co., the sound track being 0.1 inch in width and situated at the right-hand side of the projector gate; it is separated from its corresponding picture by 19 frames. There is a possibility that a 56 mm. or even a 63 mm. film will make its appearance. The existing standard is not claimed to be the best theoretically, but inventors should bear in mind that it is the most expedient. The most suitable ratio for disk synchronization would appear to be a record speed of 80 rpm. with a film speed of 90 ft. per minute, or 18 pictures to the revolution of the record. The prime essential for disk synchronization is a good start; this could be effected more easily by widening the first groove to $\frac{1}{16}$ inch so that the needle could be merely dropped into it, without the necessity for a minute examination of the disk.

Rational Film. L. GAUMONT. *Bull. soc. franç. phot.*, 16, March, 1929, pp. 59-61. The author suggests leaving room between the picture and the perforations on both sides for two sound records as might be required if right and left side microphones and reproducers were employed for simulating normal binaural hearing. Alternating these, two sound tracks could be reserved for non-synchronized speech in various languages. Also a method of superimposing the sound and picture records is suggested. The sound record would consist of variations in ultra-violet or infra-red transmission which would not interfere with the picture projection and the picture image would not interfere with the sound reproduction owing to a "special" treatment. The area between the perforations and the edge of the film could be used for operating noise effect machines.

Photographic Problems of the Variable Density Sound Films. R. SCHMIDT. *Filmtechnik*, 5, Apr. 27, Aug. 3, 1929, pp. 194-7, 334-6; *Sci. Ind. Phot.*, 9, August, 1929, pp. 86-8. A theoretical discussion of the photographic relations of density, transparency, and contrast of negative and positive films and the conditions for obtaining correct sound rendering with variable density systems.

Explanation of "Dubbing." *Bull. Acad. Mot. Pict. Arts and Sci.*, No. 26, Oct. 30, 1929, p. 3. A review of a picture given before the Academy on Oct. 23rd by C. W. Spain. The term "dubbing" was invented in the early years of the phonograph and is derived from the word "doubling." Dubbing is resorted to in connection with wax records (1) to even up the volume; (2) to make a new master record; (3) to eliminate defects in a record; and (4) to give uniform quality to an uncut negative. Synchronization is also necessary when sound is added to a previously recorded sound track or when a film record is transferred to a disk record.

Director Fits German Dialog to Lip Action of American Cast. *Ex. Herald World*, 97, Nov. 2, 1929, p. 36. By studying each spoken word of the English version of the picture *Lummo*, a German director has so directed a German speaking cast that their voices are adapted to the lip action of the production. When expressions could not be made to fit a particular lip movement, the voices were made to appear to come off the screen, the film portraying only the facial action of the person addressed.

Sound Film Studios—The Problem of Ventilation. A. T. HENLEY. *Kinemat. Weekly*, 152, Oct. 3, 1929, p. 61. Essential points in connection with the construction of a talking picture studio foundation system are summarized. For the ventilation of sound studios refrigeration plants are necessary owing to the large amount of heat radiated from the lighting units.

Modern Studios at Joinville-le-Pont. G. M. COISSAC. *Cinéopse*, 10, July, 1928, pp. 581-6. The motion picture studio of the Soc. Cinéromans-Films de France, under the direction of Jean Sapène, is described. There are four stages with a total area of 3275 square meters, two tanks for submarine photography, and an available current supply of 40,000 amperes. A detailed account of the lighting and laboratory equipment is included.

Cameraman's Experiences in the Tropics. *Filmtechnik*, 5, May 11, 1929, pp. 214-5. Cameraman Berliet relates several interesting details of work in the tropics. During the ocean trip he found the most satisfactory lighting conditions between Spain and the Canary Islands. In the equatorial belt the contrasts were excessive and yellow filters were employed. The best time for exposing was between 7 and 11 A.M. The general results obtained with panchromatic negative were superior to those on orthochromatic negative material. Temperatures of 104°F. were encountered. The rainy season extended from May to October.

Motion Pictures of the Embryonic Development of the Sea-Urchin. L. FRANÇOIS-FRANCK AND M. F. VLÈS. *Bull. soc. franç. phot.*, 16, February, 1929, pp. 39-41. Motion pictures were made through a microscope of the processes taking place between fertilization and full development of the larva of the egg of the sea-urchin. Pictures were made every 4 sec. for a period of 8 hrs. Between exposures the specimen was protected from the radiation of the illuminator by a shutter operated electrically from the camera driving mechanism. The camera and microscope were supported independently.

Motion Picture Study of the Coanoleucocytes and Their Movements. L. FRANÇOIS-FRANCK AND M. FAURÉ-FRÉMIET. *Bull. soc. franç. phot.*, 16, February, 1929, pp. 41-2. Motion photomicrographs were made of white blood cells *in vitro*. In one case transmitted light was used in making exposures; in a second, reflected light (showing interference patterns); and in a third, ultra-microscopic

technic. The microscope objectives and oculars are mentioned. The taking speeds varied from 14 to 30 pictures a minute.

Development of Cancer Cells Photographed. *Photo-Era*, 63, September, 1929, p. 163. Editorial comment. Photomicrographs were made of growing cancer cells. By making the exposures at varying intervals from three to sixty seconds it was discovered that their behavior was very different from that of any other type of cell.

Motion Pictures of the Interior of the Living Human Bladder. J. J. STUTZIN. *Kinotechnik*, 11, July 5, 1929, pp. 350-1. Ten years after the conception of the idea, Stutzin (Urological Division of the Kaiserin Auguste Victoria Hospital, Berlin) has succeeded in making motion pictures of the interior of the human bladder. The exposures were made by the use of the cystoscope attached to the camera apparatus, and controlled by a lateral view finder to prevent penetration of the mucous membrane by the lamp end of the cystoscope. An arrangement was also designed which permitted the cystoscope to turn with the camera apparatus to permit panoramic exposures. To obtain sufficient light was a difficulty. An illustrative film of this subject was shown at the 78th meeting of the Deut. kinotech. Gesellsch., June 24, 1929. The author plans to use a similar set-up to photograph the interior of the stomach, etc.

Lighting Equipment for Photographing Surgical Operations. H. NAUMANN. *Filmtechnik*, 5, Jan. 19, 1929, pp. 27-9. The outfit comprises a steel and angle-iron framework which is supported high above the operating table, on four legs. Six reflector lamps are mounted at one end of the frame and shine horizontally to 6 respective plane mirrors which are adjustable by cords or levers to throw the light where it is needed. The camera which exposes at the rate of 24 frames a second is located in the battery of mirrors. The 6 lamps comprise three of 500 watt capacity and three of 250 watt capacity. The illumination is equal to approximately 60,000 lux and the lamps are of a type intended for long service (400-500 hrs.). The lighting has been used successfully to make both ordinary and color films. The use of panchromatic and hypersensitized panchromatic film is advocated.

Modern Scientific Uses of Photography. H. J. GRAMARSKI. *Filmtechnik*, 5, May 25, 1929, pp. 232-6. A popular article setting forth some of the present day uses of photography in science. The following are among the uses mentioned: (1) photography of electron and atom tracks (work of C. T. R. Wilson); (2) ultra-microscopic photography (Brownian movement); (3) X-ray cinematography (work of Gottheiner and Jacobsohn); (4) developments in stereo-cinematography; (5) studies of the motion of terrestrial bodies (recent film of Jupiter and its moons by Prof. Wright).

Motion Picture of Electric Arcs. R. THUN. *Kinotechnik*, 11, July 20, 1929, pp. 283-4. This paper deals with the use of motion pictures in an investigation of conduction in arcs. Photographs of the arc taken through a suitable filter show the conduction process. Relations between current, voltage, and conduction process are given in *Z. deut. Ing.*, 73, June 8, 1929, p. 798.

Non-Intermittent Projector. *Cinéopse*, 9, June, 1927, pp. 513-20. The Continsouza-Combes non-intermittent projector is described in some detail. Eight similar objectives, mounted on levers and controlled by cams, move in synchronism with the film so that each objective projects a stationary image of

one frame during its entire passage before the gate. No shutter is used, the images fading one into the other. A rate of projection as low as eight frames per second gives the illusion of continuity. Photographs and diagrams are included.

New Projectors with Optical Compensation. I.—The System of Gummax Nilsen Vig. H. IVARSON. *Kinotechnik*, 11, Aug. 20, 1929, pp. 425-6. The Norwegian, Gummax Nilsen Vig., has constructed a projector with optical compensation similar to the Mechau projector. In Nilsen Vig.'s projector one oscillating mirror is placed between the objective and the screen, whereby the curved gate needed for the Mechau and the necessary correction for the curve through a torus lens is obviated. Another oscillating mirror is placed between the film gate and the condenser. Thus the number of mirrors has been reduced from eight to two. The mechanism, which causes the oscillation of the mirrors and also makes the pictures intermittent, is entirely different from that used in the Mechau projector.

Askania High Speed Camera. *Kinotechnik*, 11, Mar. 5, 1929, pp. 124-6; *Lichtbildbühne*, 22, Apr. 13, 1929, pp. 18-9. An ultra rapid camera known as the "trommelapparat" employs a high frequency 30,000 volt arc for illumination. The arc current is supplied by a series battery of nine Leyden jars and the light is intermittently flashed on the subject by means of a rotating sector. The film (perforated or unperforated) is wound on the inside of a specially constructed cylinder which accommodates 100 turns of 40 normal frames each. The film is held in absolute contact in the local plane by centrifugal force. With this type of camera 4000 normal frames per second are possible. Exposure frequencies of 8000 and 16,000 per second with frames of one-half and one-quarter normal heights are possible by increasing the intensity and frequency of the light pulses.

Color Film Using Embossed Prisms. P. HATSCHKE. *Filmtechnik*, 5, Apr. 13, 1929, pp. 154-6. The description of the working principles of a color film system (U. S. pat. 747,961, Dec. 29, 1903, by Paul Georg and Lena Rosa Frauenfelder). (See *B. J.*, Jan. 6, 1911.) The film support is embossed with prisms and the exposure is made from the embossed side. Each prism produces on the film a tiny spectrum of the light which it receives. After reversal the original colors are reproduced by projecting the tiny monochrome spectral images through the original prisms to the screen. No filters are used in either the camera or projector.

Illumination by Mercury Vapor Lamps. L. P. CLERC. *Sci. Ind. Phot.*, 9, Sect. A, July, 1929, pp. 75-7. Reflectors dyed with rhodamine and emitting fluorescent red light proved inadequate and too unstable as a practical means for supplying the red rays deficient in mercury vapor lamps. A mixture of tungsten lamps (at normal voltage) and of mercury vapor lamps in the ratio of 1125 watts of tungsten to 400 watts of mercury, and also in the ratio of 750 watts of tungsten to 400 watts of mercury, both gave satisfactory rendering on Eastman panchromatic film without a filter.

On the Use of Motion Pictures in Schools. *Il prog. fot.*, 36, September, 1929, pp. 303-10. Report of a paper by G. Luzzatto at the motion picture congress in Padua, June, 1929. The Pathé Baby film is recommended for use in schools on the ground of its extreme economy. It is stated that with this film a screen of nearly 60 in. diameter can be filled with sufficient light and that this is ample for classrooms.

BOOK REVIEWS

Kinematograph Yearbook, 1929. *Kinematograph Pub., Ltd.*, London, 1929, \$1.50. 536 p. This is the sixteenth yearly issue of this valuable review of progress in the British cinema trade. The editor's foreword mentions the inroads made by sound pictures and their effect on the industry; the encouraging improvement noted in quality of 90 British features produced in 1928; and the continued increase in theater building. The usual summaries of events in the trade are presented, such as lists of films, producing artists, theater owners, trade organizations, etc. From a legal standpoint the digest of acts and regulations and the court actions held should be of value to those interested. The review of the technical section by A. C. Carter is replete with useful material presented in orderly fashion. More data, especially on photographic solutions, might have been given in the section devoted to *Data for Kinematograph Technicians*.

Yearbook for Photography, Cinematography, and Reproduction Processes for the Years 1921-27. (*Jahrbuch für Photographie, Kinematographie, und Reproduktionsverfahren für die Jahre 1921-27.*) J. M. EDER, Editor. *W. Knapp*, Halle-an-der-Saale, 1928, vol. 30, \$3.25. 1356 p. This number covers the developments, between 1921 and 1927, in the following fields: Developers; developing-out papers; intensifiers; reducers; toning bromide and chloride prints; fixing; lantern slides; processes for direct positives; reversal processes; printing-out papers; defects in negative and positive processes; recovering silver, etc.; finishing photographs; printing from tracings; pigment processes; photographs on wood, cloth, and other materials; relief photography; photomechanical processes; etc. Many formulas and directions are given, and there are abundant references to the original literature. The author and subject indexes for vol. 30 are contained in this number.

Sound Motion Pictures. H. B. FRANKLIN. *Doubleday, Doran & Co.*, Garden City, L. I., N. Y., 1929, \$3.00. 401 p. A well prepared compilation in five chapters dealing with an historical survey, the theater, the studio, advertising, music, and the outlook for the future. Some of the technical sections consist of almost verbatim quotations from technical papers previously published but without acknowledgment to the authors.

SOCIETY OF MOTION PICTURE ENGINEERS

OFFICERS

President

J. I. CRABTREE, Eastman Kodak Co., Rochester, N. Y.

Past President

L. C. PORTER, Edison Lamp Works, Harrison, N. J.

Vice-Presidents

H. P. GAGE, Corning Glass Works, Corning, N. Y.

K. C. HICKMAN, Eastman Kodak Co., Rochester, N. Y.

Secretary

R. S. BURNAP, Edison Lamp Works, Harrison, N. J.

Treasurer

W. C. HUBBARD, Cooper-Hewitt Electric Co., Hoboken, N. J.

Board of Governors

R. S. BURNAP, Edison Lamp Works, Harrison, N. J.

H. T. COWLING, Eastman Teaching Films, Inc., 343 State St., Rochester, N. Y.

J. I. CRABTREE, Research Laboratory, Eastman Kodak Co., Rochester, N. Y.

H. P. GAGE, Corning Glass Works, Corning, N. Y.

K. C. HICKMAN, Research Laboratory, Eastman Kodak Co., Rochester, N. Y.

W. C. HUBBARD, Cooper-Hewitt Electric Co., Hoboken, N. J.

W. C. KUNZMANN, National Carbon Company, Cleveland, Ohio.

D. MACKENZIE, Bell Telephone Labs., 463 West St., New York, N. Y.

P. MOLE, Mole-Richardson, Inc., 941 N. Sycamore Ave., Hollywood, Calif.

L. C. PORTER, Edison Lamp Works, Harrison, N. J.

S. ROWSON, Ideal Films, Ltd., 76 Wardour St., London, W. 1, England.

E. I. SPONABLE, Fox-Hearst Corp., 460 West 54th St., New York, N. Y.

COMMITTEES

1929-1930

Convention

W. C. KUNZMANN, *Chairman*
 J. W. COFFMAN W. C. HUBBARD M. W. PALMER

Historical Committee

F. J. WILSTACH, *Chairman*
 M. CRAWFORD C. L. GREGORY T. RAMSAYE
 C. F. JENKINS
 O. NELSON

Journal

L. A. JONES, *Chairman*
 R. S. BURNAP J. W. COFFMAN W. C. HUBBARD
 H. T. COWLING

Membership and Subscription

H. T. COWLING, *Chairman*
 C. BARRELL L. W. DAVEE I. ROSEMAN
 J. W. BOYLE J. DEFRENES E. C. SCHMITZ
 W. H. CARSON E. R. GEIB J. L. SPENCE
 W. CLARK J. KLENKE F. ZUCKER
 M. L. MISTRY
 B. E. NORRISH

Papers

J. W. COFFMAN, *Chairman*
 M. C. BATSEL C. R. HANNA G. E. MATHER
 F. J. CADENAS K. C. HICKMAN R. F. NICHOLSON
 J. A. DUBRAY E. HUSE J. B. TAYLOR
 O. M. GLUNT D. HYNDMAN

Progress

G. E. MATTHEWS, *Chairman*
 J. A. BALL J. B. ENGL A. C. HARDY
 J. BOOLSKY R. E. FARNHAM R. C. HUBBARD
 W. CLARK H. B. FRANKLIN G. F. RACKETT
 A. W. DANESHEW K. GEYER S. K. WOLF

Projection

N. M. LAPORTE, *Chairman*
 H. W. DREYER H. GRIFFIN W. B. RAYTON
 G. C. EDWARDS R. H. MCCULLOUGH H. B. SANTEE
 T. FAULKNER W. A. MCNAIR L. M. TOWNSEND
 C. GREENE R. MIEHLING D. F. WHITING

Publicity

W. WHITMORE, *Chairman*
 F. C. BADGLEY B. W. DEPUE O. A. ROSS
 G. E. MATTHEWS
 G. F. RACKETT

Solicitation

E. P. CURTIS, *Chairman*
 J. W. COFFMAN E. A. WILLIFORD

Standards and Nomenclature

A. C. HARDY, *Chairman*
 M. C. BATSEL R. E. FARNHAM G. F. RACKETT
 W. H. CARSON H. GRIFFIN W. B. RAYTON
 A. DEBRIE R. C. HUBBARD V. B. SEASE
 L. DEFOREST L. A. JONES T. E. SHEA
 J. A. DUBRAY N. M. LAPORTE J. P. SPENCE
 E. W. ENGSTROM W. P. POWERS E. I. SPONABLE
 P. H. EVANS L. T. TROLAND

Studio Lighting

A. C. DOWNES, *Chairman*
 L. J. BUTTOLPH R. E. FARNHAM M. W. PALMER
 K. C. HICKMAN

Theater Lighting

C. E. EGELER, *Chairman*
 F. A. BENFORD F. FALGE E. HUSE
 A. C. DOWNES R. E. FARNHAM L. A. JONES
 C. GREENE

LONDON SECTION

SIMON ROWSON, *Chairman*
 A. NEWMAN, *Vice-Chairman* PAUL KIMBERLEY, *Manager*
 L. EVELEIGH, *Secretary* ALAN WILLIAMSON, *Manager*
 H. WOOD, *Treasurer* WILLIAM VINTEN, *Manager*

PACIFIC COAST SECTION

P. MOLE, *Chairman* C. DUNNING, *Manager*
 G. F. RACKETT, *Sec.-Treas.* E. HUSE, *Manager*

Membership Committee

J. COURCIER, *Chairman*
 E. JEWELL

Papers and Programs

E. HUSE, *Chairman*

RESIGNATIONS

A. C. BROMHEAD

Gaumont British Picture Corp., Ltd.,
6 Denman St., W. 1., London,
England

HARRY LACHMAN

British International Pictures,
Elstree, Herts, England

CHANGE OF ADDRESS

JAMES MATTHEWS

P. O. Box 1629, Manila, P. I.

BERNARD J. KNOWLES

"St. Raphaels" Hillrise, Gerrards
Cross, Bucks, England

GARE SCHWARTZ

9, Deacon Hill, Elstree,
Herts, England

L. A. CHUBB

RCA Victor Co., Inc.,
Camden, N. J.

JOURNAL

OF THE SOCIETY OF

MOTION PICTURE ENGINEERS

LOYD A. JONES, EDITOR *pro tem.*

Associate Editors

G. L. CHANIER
O. M. GLUNT
A. C. HARDY

P. MOLE
W. B. RAYTON
P. E. SABINE

S. E. SHEPPARD
J. L. SPENCE
L. T. TROLAND

Volume XIV

APRIL, 1930

Number 4

CONTENTS

	Page
Dimensional Analysis as an Aid to Miniature Cinematography.....	
G. F. HUTCHINS	377
Flexible Drive Shafts—Their Application to Sound Pictures.. J. C. SMACK	384
A Quick Test for Determining the Degree of Exhaustion of Developers....	
MERLE L. DUNDON, G. H. BROWN, AND J. G. CAPSTAFF	389
Elimination of Commutator Ripple from Direct Current Generators....	
O. K. BUCK AND J. C. ALBERT	399
Radiation Characteristics of Two Mercury Arcs..... FRANK BENFORD	404
A Method of Testing for the Presence of Sodium Thiosulfate in Motion	
Picture Films..... J. I. CRABTREE AND J. F. ROSS	419
A New Sixteen Millimeter Motion Picture Camera.. JOSEPH A. DUBRAY	427
The Academy of Motion Picture Arts and Sciences and Its Service as a	
Forum for the Industry..... FRANK WOODS	436
Theater Lighting.....	441
Report of Projection Committee.....	444
Abstracts.....	450
Officers.....	453
Committees.....	454
Committee Chairmen.....	457
New Members.....	459
Change of Address.....	459
Society Notes.....	460
Pacific Coast Section.....	464
Report of the Secretary.....	466
Spring Meeting of the Society, Washington, D. C.....	468
Information for Authors concerning Publication in the JOURNAL.....	471

Published Monthly by the
SOCIETY OF MOTION PICTURE ENGINEERS
20th & Northampton Sts., Easton, Pa.
Editorial Office: 343 State St., Rochester, N. Y.

Subscription to non-members \$12.00 per year, single copies \$1.50. Order from the Secretary of the Society of Motion Picture Engineers, 2 Clearfield Ave., Bloomfield, N. J.

Copyright
BY THE SOCIETY OF
MOTION PICTURE ENGINEERS

PERMANENT MAILING ADDRESS OF THE SOCIETY

Engineering Societies Building
29 West 39th Street
New York, N. Y.

Papers or abstracts may be reprinted if credit is given to the Journal of the Society of Motion Picture Engineers.

The Society is not responsible for statements made by authors.

Application pending for entry as second-class matter at the Post Office at Easton, Pa.

DIMENSIONAL ANALYSIS AS AN AID TO MINIATURE CINEMATOGRAPHY

G. F. HUTCHINS*

At the May, 1924, convention of the Society, a paper was presented by Mr. J. A. Ball on the subject "Theory of Mechanical Miniatures in Cinematography."¹ This dealt with the relation of length and time as seen from the motion picture standpoint. It is the purpose of this paper to revive this subject with the hope of making clear some points which may have been vague to many at the time.

Mr. Ball chose four fundamental quantities on which to base his discussion—force, f , mass, m , length, l , and time, t . I prefer, since these quantities are not mutually independent, to accept only three as being fundamental, namely, m , l , and t , and to regard force as a composition of the three. This may simplify the things which we must keep in mind.

Sir Isaac Newton has stated a series of laws, which, while having been recently modified by the relativity theory, may be accepted for our purposes as governing the motion of bodies in our known universe. These laws may be briefly summarized by the one equation:

$$f = ma,$$

where a is the acceleration of the body, or its rate of change of velocity in feet per second per second. It is immediately seen that the dimensional expression for acceleration is:

$$a = \frac{l}{t^2}.$$

We are now able to tie force in, if we choose, with our fundamental quantities of mass, length, and time, that is,

$$f = \frac{ml}{t^2}.$$

* General Electric Company.

¹ BALL, J. A.: "Theory of Mechanical Miniatures in Cinematography," *Trans. Soc. Mot. Pict. Eng.*, No. 18 (May, 1924), p. 119.

For the purpose of preserving one system of nomenclature, I shall adopt the notation of the paper mentioned above; small letters will designate dimensions of the model, small prime letters dimensions in the imaginary scene or world, and capital letters the ratios of the former to the latter.

It is a well-known fact that all falling bodies are subjected to the same nearly constant acceleration on our earth, very slight changes being observed at different points on the surface. Without realizing this fact in many cases we are all conscious of it, and any attempt to show us any other behavior of falling bodies will immediately destroy our illusion as to the "earthly" qualities of the scene which we are witnessing. The acceleration must, of course, be the same as our earthly acceleration in order to establish the illusion.

Now with these facts in mind, let us write the expression, in dimensional form, for the acceleration with which we are working, calling this nearly constant acceleration which we experience on the earth g .

$$g = \frac{l}{t^2}$$

and let us remember that

$$\begin{aligned} l &= Ll' \\ m &= mm' \\ t &= Tt'. \end{aligned}$$

Suppose for example that we wish to show a scene of a large building toppling. Let us assume that the building which we have in mind is actually 200 feet in height. Perhaps it is most convenient to build a miniature of this building ten feet in height. We have now established the ratio

$$L = \frac{l}{l'} = \frac{10}{200} = 0.05.$$

In order that we may film this miniature action here on the earth we must content ourselves with the fact that the bricks in the miniature will still fall with an acceleration g , hence,

$$g = \frac{l}{t^2}$$

but

$$g = \frac{l'}{t'^2}$$

and

$$l = Ll' \quad \text{and} \quad t = Tt',$$

so that

$$\frac{Ll'}{T^2t'^2} = \frac{l'}{t'^2} \text{ or } T^2 = L.$$

Applying this result to our problem we find that

$$T = \sqrt{L} = \sqrt{0.05} = 0.224.$$

This is the relative size of an interval of time in the miniature system, and is the ratio of projector to camera speed. The reciprocal, or 4.5, is the speed at which the camera should be run with respect to the projector.

Now let us study the illusion that we have created. It is important to note that length and time mutually control one another, that is, had we run the camera just a trifle slower we would have created the illusion that the building was only 160 feet tall instead of 200. Had we run it at 5 times normal, the building would have grown in the imagination of the audience to a height of 250 feet. The illusion, then, is made perfect by two facts: first, that the building is made to represent something with which the audience is familiar here on earth, and secondly, because the audience is unthinkingly conscious of the fact that bodies on the earth fall naturally with a very definite acceleration which is practically constant for all bodies.

Having gone this far without saying very much about the forces involved, it will be well to attack the forces in our model at this point. In the case of falling bodies, which we have been considering up to this point, weight has been the active force. If we may assume that the densities of the materials in our model are the same as the densities of the real objects which we are depicting, it is clear that our mass reduction factor, M , will be equal to L^3 or the volume dimension. The force causing a body to fall is then $m'g$, and will be mg in the model, or L^3 times as great. In order to be consistent then, it will be necessary to cause all forces to be reduced in proportion to L^3 . In the case of gravitational force, we are not greatly concerned with the exact value of mass, for it cancels on both sides of our equation of motion, and the motion is independent of mass as first pointed out.

We may now consider some special types of forces. A very interesting illustration is that of resilience forces, such as are produced by springs, bending beams (with certain limitations), and torsional

mechanisms. In general this type of force is proportional to a deflection or deformation, and we may call the constant of proportionality k_s ; then in the large scene

$$f'_s = k'_s l'$$

where k'_s is measured in pounds per foot displacement. In the miniature we have

$$f_s = k_s l$$

and since we wish to be consistent with our forces,

$$F_s = \frac{f_s}{f'_s} = \frac{K_s k'_s L l'}{k'_s l'} = K_s L = L^3$$

so that

$$K_s = L^2.$$

This means that in order for our stressed member to behave correctly when shown on the screen at normal speed, its resilience constant must be reduced in proportion to the square of the length scale. It should be noted that this treatment applies to any sort of member where the deformation is proportional to the applied force and *vice versa*.

Another very interesting type of force which may be encountered in miniature work is the damping force, that is, any force which is proportional to and usually caused by the velocity of a moving body. Such forces would be very important in such a scene as a falling parachute, sinking ship (beneath the waves), or any other case in which relatively high velocities would be encountered in dense mediums. This phenomenon is even apparent in the case of our freely falling bodies, but is so small that we neglect it there.

The resisting force to our motion will be designated by the term, f'_d , and the factor of proportionality, measured in pounds per foot per second, will be called k'_d . Our equations are then

$$f'_d = \frac{k'_d l'}{t'}$$

$$f_d = \frac{k_d l}{t}$$

Again the force must conform to other forces in the system, so that

$$F_d = \frac{f_d}{f'_d} = \frac{\frac{K_d k'_d l L l'}{T' t}}{\frac{k'_d l'}{t'}} = \frac{K_d L}{T} = L^3,$$

so that

$$K_d = L^2 T = L^{5/2}.$$

It may be expected, then, that a body moving through a dense medium will be affected in a natural way on the screen only when the damping constant of the system is reduced in proportion to the five-halves power of the length reduction factor. It should be noted, however, that in reducing the length dimension by L , we have reduced the area of the model by L^2 and hence the liquid itself need have its damping constant with respect to any moving system reduced by only $L^{1/2}$, for the damping constant of any system in general is proportional to the area of the moving member.

I would like to indicate at this point that the placing of waves in the same category as falling bodies, as was done in the paper by Mr. Ball, is not justified. So far as spray and other falling particles of water are concerned, the parabolic relation of length and time is probably justified, but in the case of the waves themselves, the theory of falling bodies no longer holds. In this case the velocity of the waves is constant, and the length-time relation is a linear one. I will illustrate by an example. Suppose we have a pool of water 100 feet in length, and suppose we drop a pebble in at one end. It will take t seconds for the ripples, or waves, to reach the other end. Now suppose it is desired to make a picture of such an action in miniature and choose a pool only ten feet long. It will now actually take one tenth of t seconds for the waves to traverse the pool, so in order that it appear as though they traversed it in t seconds, it will be necessary to crank ten times as fast, so that the time ratio is the same as the length ratio. A failure to realize this fact probably accounts for some unconvincing ocean scenes which we have seen done in miniature.

The problem which now presents itself is, how are we to picture in miniature a ship blowing up in a rough sea. If we scale our time intervals to accommodate the falling debris, we have not timed properly for a good illusion in the case of the waves. It may, however, be shown that the depth of the water used is a factor in the determination of the velocity of propagation of waves, and since our model ship is probably floating on a model ocean it is not improbable that we may so design the tank as to give the desired effect. The problem of surface wave motion is not readily adaptable to simple and direct mathematics, and will not be treated here. This

subject is ably discussed in detail in Horace Lamb's well-known work on Hydrodynamics (Cambridge Press).

A very interesting example of the type of problem to be encountered in cases where stresses in structures accompany motion is to be had in the cantilever beam. The expression for the end deflection of a cantilever beam with concentrated load of f' pounds and length s' is

$$d' = \frac{f's'^3}{3e'i'}$$

where e' is the modulus of elasticity of the material and i' is the moment of inertia of the beam with respect to the axis of bending. Dimensionally this expression may be written:

$$l' = \frac{f'l'^3}{e'i'}$$

and in the miniature

$$l = \frac{fl^3}{ei} \text{ or } Ll' = \frac{Ff'L^3l'^3}{Ee'Ii'}$$

If the densities are kept constant, $F = L^3$ and a combination of equations gives:

$$EI = L^5.$$

If we use the same material in our miniature beam that we would use in the large beam, the modulus of elasticity factor, E , is unity, and we must reduce our moment of inertia in proportion to L^5 . If we merely reduce the linear dimensions of the beam by L and keep its structure the same, its moment of inertia will be reduced by only L^4 , so that it will be necessary to change the structure of the beam in the miniature to secure good results. A properly designed hollow beam would give the desired effect. The same end might also be obtained by designing the beam with a reduction in moment of inertia of L^4 (reproduction of the structure in the large beam) and a reduction in the modulus of elasticity of L . This calls for a beam of different material, however, and it would therefore be necessary to also see that the density of the new material was right, and would probably not be as good a solution of the problem in most cases as the first alternative.

It may be noted that this problem is merely a special application of the resilience force case already covered. In our present problem

$$k_s = \frac{3ei}{s^3}$$

Most of the important cases to be met in designing miniature sets have now been covered in a general way. It must be remembered, however, that the specific problems present themselves in an infinite number of combinations, and each one must be solved in a slightly different way. Fortunately we do not usually have to have everything perfect, but need concentrate only on those phases of the structure which lend themselves to enhancing the illusion or spoiling it, as the case may be. There is no set of equations by the use of which any one may design convincing models, but one who has a sound foundation in physics and mathematics combined with a clear understanding of dimensional relations may use this knowledge to see at a glance the important considerations of the problem, and apply his ingenuity to a solution that will give an excellent impression on the screen.

The difficult conception for the layman to grasp is the idea of a connection between time magnification and linear magnification, for he is thinking in terms of optics, and knows that the actual optical process is geometrically the same in taking pictures at high speed as when taking them at normal speed. To fully grasp the idea it must be remembered that the linear magnification which we are discussing is not an optical one but a psychological one, and is just as true to physical law in the case of a perfect mind as the optical magnification which might be accomplished with lenses. The untrained mind is easier to satisfy than the trained mind, but the trained mind, for the same reason, is more appreciative of an illusion sufficiently good to be outside his power of detection. It is pleasing to know that it is within our power, by using simple physical laws, to produce illusions which cannot be detected by the hypothetically perfect mind.

FLEXIBLE DRIVE SHAFTS—THEIR APPLICATION TO SOUND PICTURES

J. C. SMACK*

Before describing the actual applications of flexible drive shafts to motion picture equipment, it might be well to give you as briefly as possible a general description of flexible shafts and their characteristics. Although there are over thirty million feet of flexible shafting used yearly in practically every type of industry in this country, engineers as a whole are not generally familiar with the technical characteristics of this product.

Flexible shafts are manufactured in all sizes from 0.041 inch to 0.750 inch in diameter and larger. They are built up of wires usually in strands of four, wound in superimposed layers. The direction of the lead or pitch of the successive windings alternates and the wires are of graduated sizes, increasing with the layers. The material itself is a special grade of steel music wire of high tensile strength and may be wound in any number of layers from two to nine, according to the type and size of flexible shaft desired. Shafts of widely varying characteristics may be produced by different combinations of wires, by differences in number of layers, and subsequent heat treatment.

Irrespective of diameter, flexible shafts are regularly made in two general types, classified as grade "H" and grade "S." The grade "H" flexible shaft has high torsional strength, or resistance to twisting strain, and is adaptable to the majority of uses. Grade "S" shafting has greater flexibility than grade "H" and is usually used where extreme flexibility is the deciding factor. Various other grades are also supplied for special applications.

Flexible shafts are wound for maximum efficiency when rotating in one direction. The pitch direction of the outer layer of wires determines the direction of rotation in which the shaft will give the best results. A shaft should be rotated so that the tendency is to

* S. S. White Dental Mfg. Co., N. Y. City.

tighten up the outer layer. A shaft to be operated in a right hand direction should have its outer layer wound oppositely or left hand.

Therefore, for right hand driving a left hand or left lay shaft should be used and for left hand driving a right hand or right lay shaft. All sizes of shafting are manufactured either right or left lay and although either type can be used in either direction, greater efficiency is obtained by using the proper lay of winding.

Manufactured in long lengths, flexible shafts are cut to desired lengths while the wires are under tension. This is accomplished by brazing or swaging the wires solidly together where the cuts are to be made. Thus a flexible shaft presents solid ends which may be soldered or swaged into metal end connections. As this work requires special equipment and considerable skill, it is advisable that it be done at the factory of manufacture. Otherwise the structure of the shaft is sure to be weakened.

The characteristics of torsional stiffness, torsional strength, the safe working minimum diameter of curvature in which the shaft may be used, transverse stiffness, internal friction, *etc.*, are very definitely affected by the construction and method of manufacturing the shaft. Certain characteristics of a shaft can be modified to advantage generally at a sacrifice of certain other characteristics. Therefore, by changing certain factors in the construction or method of manufacture, shafts most suitable for a particular set of conditions can be obtained.

Under these special conditions, the engineer will recognize that it is a difficult matter to predict in advance the proper shaft to use in any given installation without an exact knowledge of all the circumstances under which the shaft will operate. It is therefore advisable, if a flexible shaft is desired for a particular application, to consult your flexible shaft manufacturer as to the proper size and type of shaft to use, supplying him with as full information as possible. Factors which should be considered are: power to be transmitted, whether continuous or intermittent; speed of rotation of the flexible shaft; distance between the source of power and object to be driven; and the radius of the curve or arc about which the shaft must operate.

Most flexible shaft drives require a casing, both as a protection against injury and as a guide for them to run in. In some cases where a short shaft is used no casing is necessary. Casings are manufactured in all sizes to fit the various sizes of shafting. The

four principal types of casing generally used are the fabric, the two-wire metallic, the interlocking metallic, and the rubber covered. These casings all have special uses and will be taken up later.

For those interested in more detailed information on flexible shafting the S. S. White Dental Co. about two years ago published the *Handbook on Flexible Shafts*. This book has been so widely accepted and praised by engineers that a more elaborate handbook has been compiled giving complete engineering data on all sizes of flexible shafting, and in addition descriptions and photographs of actual applications in various industries. This handbook will be invaluable to all designing engineers and will be distributed *gratis* to those interested.

CAMERA DRIVES

Let us investigate the characteristics of those shafts most widely used in the motion picture industry, that is, the $\frac{1}{4}$ in. and $\frac{5}{16}$ in. diameters. A flexible shaft, to be satisfactory for synchronized sound motion picture equipment, must be flexible transversely—must be torsionally as stiff as practical, and still not be too heavy or cumbersome for general use. To this end the $\frac{1}{4}$ in. diameter grade "H" left lay shaft was selected for driving the Bell & Howell-Western Electric cameras. This shaft has sufficient flexibility to allow the motor to be placed under the camera, to one side, or in whatever position is the most convenient for the operator. The safe allowable torque on this shaft at 1450 rpm., the speed of the camera drive shaft, is 13 inch-pounds—considerably more than the actual torque of the camera at any time. Extensive experimentation with this shaft indicated its altogether satisfactory performance, and it was adopted by the Western Electric Co. as standard equipment for their cameras. In the selection of a casing for this application, the $\frac{1}{2}$ in. diameter fabric type was used, due to its lightness in weight and flexibility.

Further experimentation on various types of camera drives indicated that there were cameras which exerted a greater torque on the flexible shaft than others. Investigation showed that some cameras, in particular the new sound cameras, were considerably stiffer in operation than others. Some were so stiff that at times a wobble or fluctuation was experienced in the camera drive. A larger shaft, the $\frac{5}{16}$ in. diameter, was substituted for the $\frac{1}{4}$ in. and no further trouble was experienced on these cameras. With this shaft a $\frac{5}{8}$ in. diameter two-wire, black japanned metallic casing is used, or a $\frac{5}{8}$ in.

diameter rubber covered casing. For cameras used without a sound-proof booth, the rubber covered casing is the best as it will deaden any slight noise caused by the rotation of the flexible shaft. Somewhat the same effect can be obtained with the metallic casing, by covering it with a light, flexible rubber tubing. It is also advisable to grease the flexible shaft occasionally with a good grade of light grease.

Attachment of the flexible shaft assembly to the motor is usually made with a special ball bearing motor coupling manufactured for this purpose and designed to fit the standard end fittings furnished on stock $\frac{1}{4}$ in., $\frac{5}{16}$ in., and $\frac{3}{8}$ in. diameter flexible shaft combinations and their respective casings. These couplings are also supplied in various sizes to fit standard size motor shafts.

Due to the many types of cameras, there is no standard adapter made for attaching the flexible shaft drive to the camera. It is, however, a simple matter to have one made to fit both the camera drive shaft and the standard end fittings provided on the flexible shaft and casing. Flexible shaft camera drives are usually used in lengths from 3 ft. to 6 ft. and in special cases up to 10 ft., the length being governed of course by the position of the motor.

TURNTABLE DRIVES

Our next problem is the turntable for synchronized sound disk records. It is customary to connect the turntable direct to the projecting machine by any one of a number of methods. Those most widely used are: (1) the direct shaft drive where the turntable is usually mounted directly on the projection machine; (2) the solid shaft drive with one or two universal couplings; (3) the short flexible solid rubber coupling drive; (4) the flexible shaft drive.

A perfect turntable drive should be all of three things. It should be vibrationless, provide a positive drive, and allow for flexibility in installation. Of the four drives listed above, the flexible shaft drive is the only one which fulfills all three requirements. Vibration is experienced with solid shafts if they are not properly installed; also there is no flexibility in installation as the position of the turntable cannot be changed. Vibration is the main disadvantage of universal joints and here also we have little opportunity to change the location of the turntable. The flexible rubber coupling is partially satisfactory but is subject to deterioration and cannot be used in lengths over 6 in. However, when we consider the flexible shaft drive we

find a vibrationless and positive drive with extreme flexibility and ease of installation. In long narrow booths, the turntable can be placed at the rear of the projection machine or for wider booths on either side, providing a means by which the space available can be used in the most economical and convenient way.

As for the camera drives, a $\frac{1}{4}$ in. diameter grade "H" shaft has been found to be the most satisfactory shaft although for long drives it is usually advisable to use the $\frac{5}{16}$ in. diameter shaft. Any of the three types of casings mentioned can be used with these shafts and for short lengths under 12 in. the casing can be eliminated. However, a turntable to be satisfactorily driven by a flexible shaft must be designed to provide a uniform load for the shaft, sufficient to hold it at its average angle of torsional deflection. If the turntable has a tendency to fluctuate, producing a wavering sound reproduction, a friction brake of some type should be attached to the periphery of the turntable or to the internal shaft. Only a slight braking force will be necessary to eliminate this trouble. Also the addition of a fair size fly wheel or proper gearing will eliminate this fluctuation.

Flexible drive shafts for turntables are now being adopted as regular equipment by many manufacturers of sound picture equipment.

OTHER FLEXIBLE SHAFT APPLICATIONS

In addition to driving cameras and turntables, the flexible shaft is also being used for driving optical printers for trick cinematography as developed by the Lang Film Co., specialists in this type of work. A $\frac{5}{16}$ in. diameter grade "H" shaft drives this printer in perfect synchronization, fulfilling in every way the rigid requirements of this application. On other printers it has sometimes been found advisable to use a $\frac{3}{8}$ in. diameter grade "H" shaft with $\frac{3}{4}$ in. diameter casing, due to the larger torque applied to the shaft.

Small diameter flexible shafts are being used on film speed indicators for projecting machines. In most cases this is the 0.130 in. diameter shaft. Attachment is made with a special coupling to the shutter shaft and the instrument is mounted in a convenient position nearby.

For a small home talking motion picture outfit a $\frac{3}{16}$ in. diameter grade "H" shaft with 0.445 in. diameter interlocked, black japanned metallic casing is used with great success for driving the turntable in perfect synchronism direct from any 16 mm. motor driven projector.

A QUICK TEST FOR DETERMINING THE DEGREE OF EXHAUSTION OF DEVELOPERS*

MERLE L. DUNDON, G. H. BROWN, AND J. G. CAPSTAFF

INTRODUCTION

The fine grain borax developer formula,¹ originated by J. G. Capstaff and R. A. Purdy, was presented to the trade in the *Eastman Duplicating Film* booklet issued in January, 1927,² and has since been widely adopted.

The end of the useful life of the borax developer is reached when its degree of exhaustion is such that it causes an apparent loss of exposure on the film, although the desired contrast can still be obtained by longer development.³ With ordinary developers, this condition does not become serious, and they can be used until the required time of development becomes too long. The loss of available image peculiar to exhausted borax developer cannot be detected by examining a developed film of unknown exposure, but if two pieces of film having identical exposures are developed to the same gamma in fresh borax and in exhausted borax, the film developed in the latter will appear to have had less exposure. For this reason, it is obviously important that borax developer should not be exhausted too far when used for negative film.

In this communication, a quick test is described which gives a reliable indication of the degree of exhaustion of the developer, and the application of this test to borax developer is discussed in detail.

* Communication No. 405 from the Kodak Research Laboratories.

¹ Elon	2.0 grams
Sodium sulfite (anhydrous)	100.0 grams
Hydroquinone	5.0 grams
Borax	2.0 grams
Water to	1.0 liter

² *Eastman Duplicating Film*, Eastman Kodak Company, Rochester, N. Y. (1927).

³ CARLTON, H. C., AND CRABTREE, J. I.: "Some Properties of Fine-Grain Developers for Motion Picture Film," *Trans. Soc. Mot. Pict. Eng.*, **XIII** (May, 1929), No. 38, p. 406.

It is believed that under certain conditions such a control test can be very useful.

CONDITIONS CAUSING LOSS OF EXPOSURE

When a silver bromide solvent is present in low concentration in a developer of reasonably strong reduction potential, most of the dissolved silver bromide is reduced as fast as it is dissolved and the silver is redeposited very near to its original location on the developing nuclei already present. When the solvent is too strong or the reducing action too weak, the soluble complex formed with the silver halide escapes into the developer and is slowly reduced, causing a sludge of the reduced silver. In this case, some of the available density for a given exposure is lost.

It is a well-known fact that increasing the bromide content of a developer delays the first stages of development. When an image is being rapidly formed by development, it is obvious that so much bromide is released within the film that the influence of ordinary bromide concentrations in the developer is negligible. Therefore, the effect of bromide in the developer is limited largely to the first stages of development.

In the borax developer with a fresh solution containing no bromide, development starts very quickly. When bromide is introduced either directly or by developing film, the appearance of the image is greatly delayed. With 2.0 grams per liter of potassium bromide, 3 or 4 minutes elapse before the shadow detail becomes visible. Meanwhile, the sulfite is exerting its solvent action with the resulting loss of developable image density. This is in agreement with the known fact that bromide in a borax developer causes an effective loss of exposure in film when developed to the customary gamma between 0.6 and 0.8.

To test this idea further, strips of film exposed through a step tablet were bathed for five minutes at 70°F. in a solution of sodium sulfite containing 100 grams per liter, and then developed for differing times in a fresh borax developer at the same temperature. Comparison strips were soaked in water instead of the sulfite solution and developed for the same times. When a gamma of approximately 0.7 was obtained in each case, the film bathed in the sulfite solution showed such a loss of image that it appeared to have an exposure of only about one-third that of the strip bathed in water.

If the solvent action during the induction period before the de-

velopment starts is responsible for the loss of image density, then, if development is started in a fresh developer and completed in an exhausted developer, no shadow detail should be lost. This possibility was tested carefully using a fresh borax developer and a badly exhausted one. The latter had been used in a large tank for developing motion picture negative film, and it had been revived after 80 feet per gallon. When the tank was finally discarded after a total of 160 feet per gallon, a small sample was exhausted further. When Eastman motion picture panchromatic negative film was developed for eight minutes in the fresh and ten and one-half minutes in the revived and exhausted developer a gamma of 0.7 was obtained in both developers. The film developed in the exhausted developer, however, *appeared to have* only half the exposure of that developed in the fresh developer although actually the strips had been exposed exactly alike.

Tests were then made by starting strips for differing lengths of time in the fresh developer and completing development to the same gamma in the old developer. These tests showed that, if the film were developed for 2 minutes in the fresh developer followed by 6½ minutes in the old developer, the same gamma of 0.7 could be obtained with no loss in exposure, although both fog and image density were slightly less than with the fresh developer. With 4 minutes in the fresh and 4 minutes in the old, the total density also was the same as with 8 minutes in the fresh. The exact times stated above applied to the particular developers, and emulsion used in these tests would vary under different conditions.

In a developing machine where fresh developer is put in continuously at one end and the exhausted developer is allowed to overflow at the other, always maintaining constant development conditions, it is obvious from the above data that the fresh borax developer should be introduced where the film enters and moved through the machine in the same direction as the film. This is opposite to what would be done with most developers as development would ordinarily be started in the seasoned portion of the developer in order to prevent fog.

THE DEVELOPER TEST

The developer test described herein is of a photographic nature and is based on the well-known principle of the Watkins factor. Instead of determining time of appearance of an image, however, it

has been found much simpler and more accurate to develop a standard exposure for a definite time, stop development instantly, and compare the image so obtained with a previously prepared standard. Such a strip can be examined easily by reflected light, either in white light or with a bright safelight. If the time of development for the test strip is so selected that the last available exposure step (shadow detail) just fails to become visible in the fresh developer, then a very great difference will become evident with any less active developer. With some developers, this time may be 30 seconds or less but with borax developer a time of 1 or 2 minutes is best.

Motion picture positive film is advised for the test strips because it can be handled with less danger of light fog than negative film. The test can be made directly in the tank or a sample of the developer can be tested in a graduate or other suitable vessel if care be taken to see that the temperature is correct.

Technic Advised.—A strip of motion picture positive film containing a standard exposure, preferably a print from a uniform density step tablet, is used. The strip of film is quickly dipped into the developer, noting the time accurately to the second. During immersion, it should be agitated gently. Three or four seconds before the required time is up, the strip should be lifted from the developer and so held that it can be plunged into the stop bath without delay when the time is up. In other words, the time of the test is measured from the moment the strip enters the developer to the moment it enters the stop bath. The strip should be agitated when first put into the stop bath. After 10 seconds it can be examined satisfactorily, but if it is to be made permanent for keeping, it should be kept in the stop bath for 2 minutes and then washed for about 10 minutes. In handling the strip, it can merely be dipped by hand with a clip on the lower end for weight, or a special holder can be devised by attaching clips to a monel wire frame. Contamination from fingers or dirty clips should, of course, be avoided. The stop bath can be used most conveniently in a graduate or tube deep enough to permit the entire strip to be suspended in it.

Composition of the Stop Bath.—The formula for the stop bath is as follows:

Potassium iodide	20 grams
Glacial acetic acid	20 cc.
Potassium alum	40 grams
Sodium sulfite	1 gram
Water to	1 liter

The acetic acid instantly stops the action of the developer and the iodide converts the undeveloped silver bromide to silver iodide which is not darkened by light. The alum serves to harden the film and the sulfite prevents the solution from becoming colored because of the action of light on the potassium iodide. The bath can be used repeatedly as long as it remains acid.

Stability of the Test Strips.—If the test strips are to be kept as a record or as a standard for comparison, they must be permanent. It has been found that motion picture positive film after 2 minutes in a stop bath is sufficiently iodized so that it is not darkened by several days' exposure to sunlight. To prevent the image from fading, the film must be washed thoroughly to remove free iodide and acid. The acid can also be removed by giving a final rinse in water containing a few drops of ammonia. Potassium iodide in an acid medium is readily decomposed by light forming free iodine which converts the fine silver grains back to silver iodide, causing the strip to fade. This explains the need for thorough washing.

It should also be noted that test strips should not be used more than a month after they are printed since the latent image on motion picture positive film is liable to show some fading in that time.

TYPICAL EXHAUSTION TESTS

In the photographs are shown test strips dipped for 1, 2, and 3 minutes at 65°F., 70°F., and 75°F., in borax developer at different stages of exhaustion and with different quantities of bromide added to the unused developer. In Fig. 1 are shown tests made at certain stages of exhaustion life of a 120 gallon tank of borax developer used for rack development of panchromatic motion picture film.⁴ After 80 feet per gallon had been developed in the tank, the film showed an apparent exposure about 70 per cent of that obtained with the fresh developer. This developer was used for a series of tests marked "before revival." The tank was revived by adding half the original quantity of developing agents and borax dissolved in as little water as possible with sufficient sulfite to equal 10 per cent of the solution added. This revived solution was used for the test marked "after revival." The tank of developer was then further exhausted to a total footage of 160 feet per gallon when the apparent

⁴ The authors are indebted to Dr. H. C. Carlton of these Laboratories for the history of these developer samples.

exposure on the film was about 60 per cent of that shown by the fresh developer. At this point, its use for commercial purposes was discontinued. A sample was further exhausted, however, to a

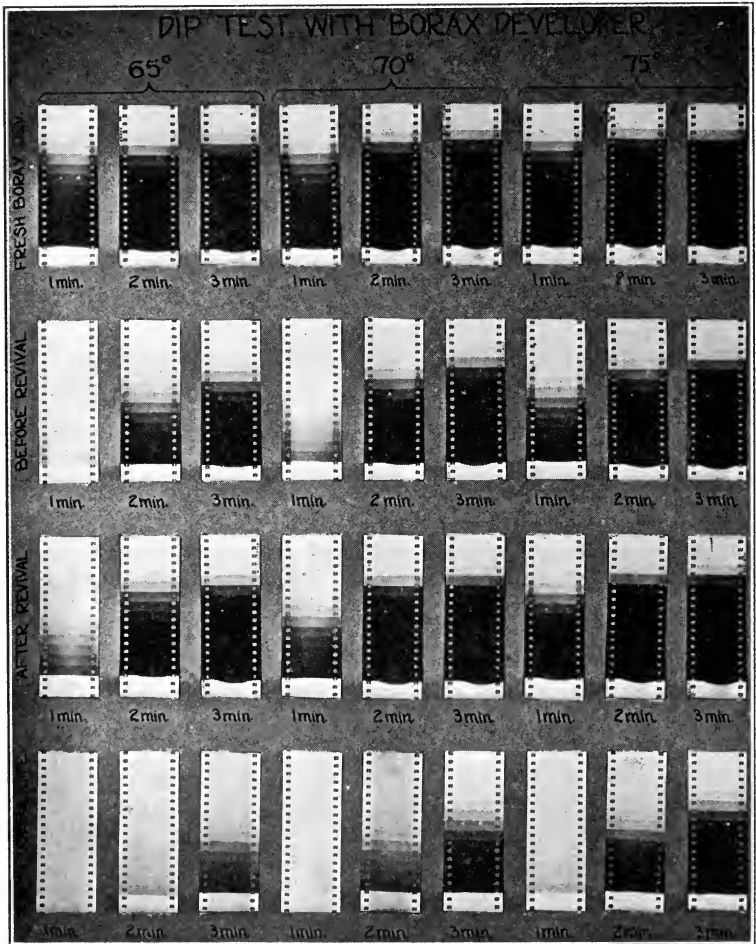

FIG. 1. Tests at various stages of developer exhaustion.

total of 240 feet per gallon when it showed an exposure only half that obtained with fresh developer. This was used for the final series marked "end of useful life." On this chart, looking down each column from top to bottom, one can observe the changed appearance

of the test strips as the developer was exhausted for any given temperature and time of testing.

It is obvious from this chart that a one-minute test at 65°F. is

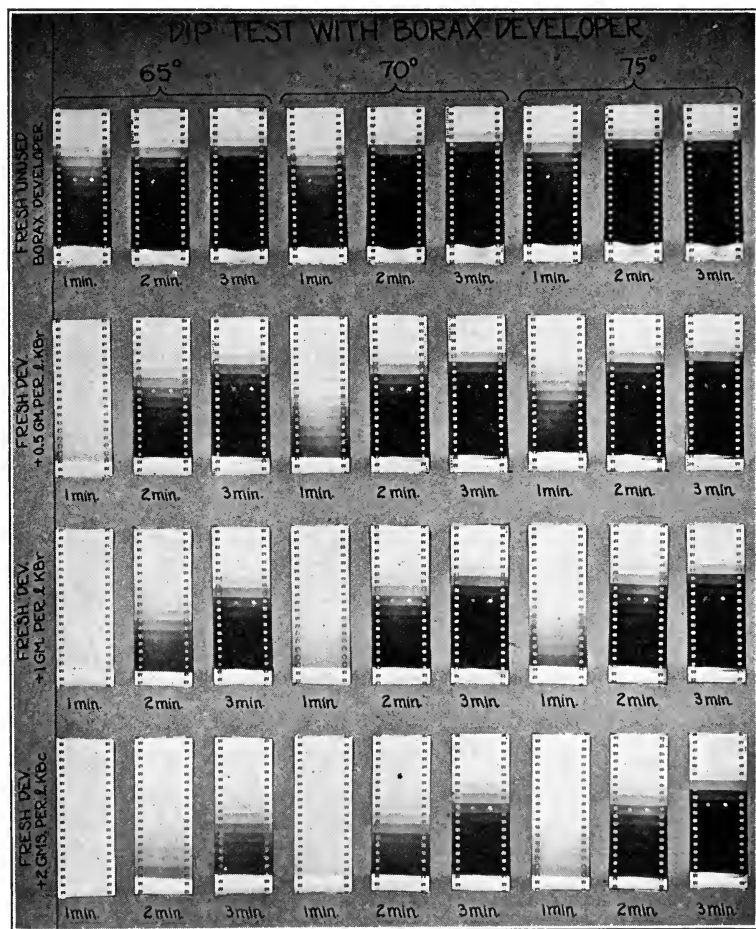

FIG. 2. Tests at various bromide concentrations.

too short to give the desired information. Likewise, 3 minutes at 75°F. does not show suitable differences. With 2 minutes at 65°F. and 1 or 2 minutes at 70°F., however, there are very striking differences in the appearance of the test strips at different stages of exhaustion.

In Fig. 2 is shown a similar series of test strips for a fresh, unused borax developer to which varying amounts of bromide were added. The effect of the bromide in delaying the appearance of the image is striking. Further, it can be seen that differences in this chart are quite similar to those obtained by exhaustion, showing that a

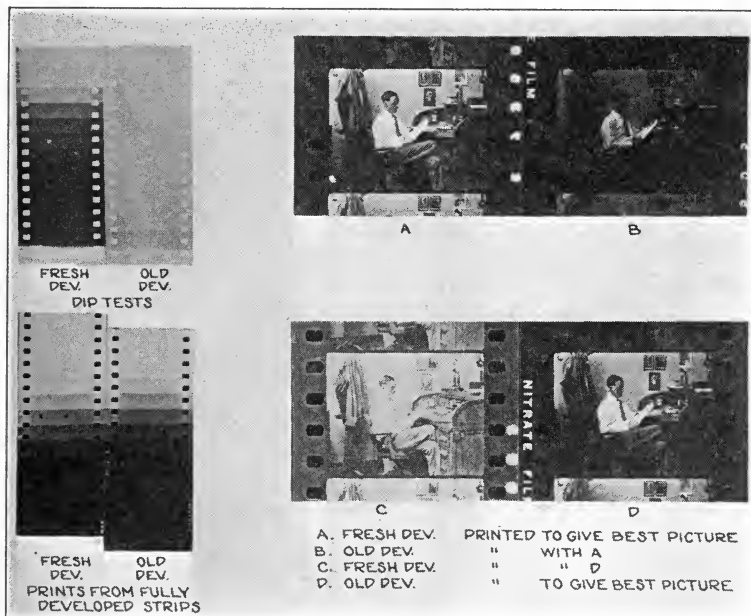

FIG. 3. Exposure loss in exhausted borax developer.

large part of the exhaustion effect with borax developer can be attributed to accumulated bromide.

In Fig. 3 are shown the two-minute dip tests at 65°F . for a fresh and a badly exhausted developer as described above. Corresponding to these are prints from two strips both having the same exposure and each developed to a gamma of 0.7, one in the fresh and one in the old developer. The strips were printed from a 0.3 density step tablet and therefore each step had just twice the exposure of the preceding one. It can be seen that one step on the shadow end is missing from the strip developed in the exhausted developer since that strip has to be moved along one step in order to make the densities the same as in the other strip. In other words, the exhausted developer would

require twice as much exposure as the fresh developer to give a negative of the same range and density. Picture negatives from the same strip also were developed to the same gamma in the same two developers, and prints which are reproduced show the loss in shadow detail on the film developed in exhausted developer. From this figure, therefore, it can be seen that the dip test gives a greatly exaggerated measure of the degree of exhaustion, compared to the effect on the fully developed film. This makes it a very sensitive test and when properly interpreted adds to its usefulness.

Advantages of the Dip Test.—The dip test when applied to borax developer as described above measures the delayed appearance of the image which has been found to correspond with the tendency of the developer to show a loss of exposure on the film. The test can be performed in 3 or 4 minutes except for the complete washing required to make the strip permanent; and for immediate information the strips can be examined without washing. The differences are so great as to be very easily noticed and the weaker images have a brown tone which is also significant. Examination of a fully developed and fixed film is much more difficult when detecting the same differences in developers. It seems, therefore, that such a test should be very useful whenever it is desired to learn quickly the degree of exhaustion and comparative safety of a used borax developer. With a little experience, and when using a standard exposure, a mere glance at the finished test strip is usually sufficient, but for exactness, comparison should be made with a previously prepared standard strip.

SUMMARY

It is suggested that the loss of exposure on motion picture negative film developed in badly exhausted borax developer is caused by the solvent action of the sulfite while the start of development is being delayed by the bromide.

A quick photographic test is described by means of which one can measure the retarded start of development which corresponds to the loss in exposure obtained with exhausted borax developer.

The same test can be applied to ordinary developers to measure their degree of exhaustion, provided it is standardized for the given developer as used.

DISCUSSION

MR. TAYLOR: Your usage of the term "exposure" might in some cases be open to criticism. To speak of the "loss of exposure" is misleading. Would not "loss of latent image" be more accurate?

DR. DUNDON: It may be that the term "exposure" is not technically correct. In measuring this effect, we took the speed reading on the H & D curves as is customary, and when this H & D curve shifted one step on the 0.3 density tablet, we said that it showed one-half the exposure or speed. In some discussions of this matter it has been called a loss of speed. Actually, it is loss of latent image. If we use the old developer all the latent image does not come up and, measuring it in the ordinary way, the film has only half the speed that it had originally.

MR. TAYLOR: Some one else at another time may use "loss of speed." I noticed also that once or twice you said "apparent loss of exposure" or "effective loss of exposure," which might be the better term.

DR. DUNDON: Perhaps this nomenclature might be used more uniformly. However, when the camera man sets his exposure from a test film developed in a fresh developer and then shoots his picture and has it developed to the same gamma in an exhausted developer, it is under-exposed. This is due to the characteristics of the exhausted developer.

ELIMINATION OF COMMUTATOR RIPPLE FROM DIRECT CURRENT GENERATORS

O. K. BUCK AND J. C. ALBERT*

The large electric utilities of today are interested not only in the kilowatt hour sales, but also in the most efficient use of that energy by its consumers. The Department of Water and Power of Los Angeles endeavors to identify itself with the industries it serves by coöperation with its consumers to the fullest extent. This department has established very low rates for energy and also has assisted in solving technical problems which arise in the utilization of that energy.

One of these problems which we have been able to render assistance in solving is undoubtedly of considerable interest to this group. This is the elimination of the commutator ripple from the direct current generator in order that high intensity arcs may be used in the production of talking pictures.

When the studios first started making talking pictures it was, of course, necessary to eliminate all outside noises from the sets. In using the high intensity arc it was found that a high pitched squeal was emitted therefrom, a pitch near the middle of the audible range and therefore very objectionable. It was found upon investigation that this noise was caused by an alternating current wave superimposed upon the direct current. This was readily traced to the generator and determined as a function of commutation. It has been termed "commutator ripple." The frequency is directly proportional to the speed of the generator times the number of commutator bars. We therefore have to deal with frequencies ranging from 900 to 1800 cycles.

Several of the studios have been more or less successful in cutting the noise down to a minimum. The first method employed was the use of impedance choke coils, either on the lamp, on the feeder, or, perhaps, upon the generator itself. The small "whistle boxes" installed

* Dept. of Water and Power, Los Angeles, Calif.

at the lamp are most commonly used. They consist of from 50 to 130 lbs. of copper and iron. They are moved around with the lamps and thus increase the cost of rigging and striking sets. It then developed that there were different characteristics of distribution system or generator design that produced different results at different studios.

One particular lot has a large distribution system of lead covered cable and a low frequency ripple. For this reason the choke coils

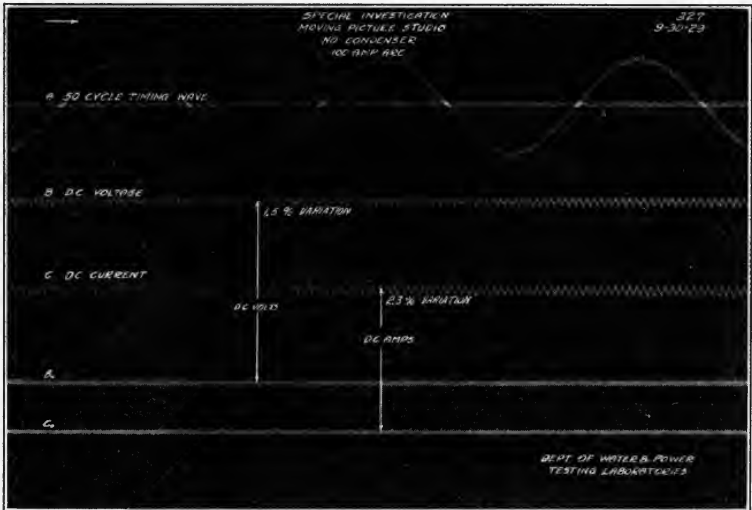

FIG. 1. Alternating current wave of 1800 cycles superimposed upon the direct current.

on the lamp are very successful. The ripple is not as readily picked up by the microphone on account of this lower frequency and the large amount of capacity in the lead covered cable furnishes a by-pass for the alternating current. The same method on other lots would not work with the same degree of satisfaction.

The Test and Research Section of the Department of Water and Power of Los Angeles was then called in and has endeavored to analyze the problem in a scientific way. An oscillograph record shows that upon the particular generator studied, there was an alternating current wave of 1.5 per cent variation superimposed upon the direct current. Fig. 1 shows this wave. It can be readily seen

that this is an even wave form of 1800 cycles frequency. After considering the practical features of the situation it was decided that the proper place to damp out the ripple was at the generator. The two principal reasons were: first, the cost of rigging sets would be thus reduced; second, the possibility of inductive pickup on microphone cable would be eliminated.

As I have mentioned, the methods employed up to this time had consisted of the addition of impedance only to the line. The alternating current was thus left to seek its own path across the line or across the generator. Our plan was to establish a well-defined path directly across the generator. An harmonic filter of both impedance and capacity was designed and tuned to absorb a frequency of 1800 cycles. Connected across the line it was effective to a slight extent but the resistance of the device was altogether too high. When a load of 5000 amperes is thrown across the line the resistance of the circuit is extremely low and therefore the ripple would take the path of least resistance going around through the arcs rather than across the filter.

Experimentation with paper condensers necessarily limited us to small amounts of capacity and high resistance. We found that on account of the much higher capacity provided by means of electrolytic condensers the results were much more satisfactory. Even with these higher capacities it was necessary to use a large impedance coil to choke back the alternating current and force it through the condenser by-pass.

We tried several designs of impedance coils. An air core coil would, of course, be independent of load in its effectiveness but, on account of the large size and the large amount of copper necessary, it was impracticable. An iron core coil could be built for the same impedance value and consume much less space. This type of coil was effective up to the point of saturation of the iron core. On account of the very heavy direct current loads carried by the studio, a simple coil with an iron core was necessarily unsatisfactory.

We then tried a coil consisting of two windings upon a common core, each winding to be on opposite sides of the direct current line and so connected that the direct current field of one line would buck that of the other line. This, after several refinements, produced rather satisfactory results.

The experimentation continued and we then decided by using more capacity and connecting the condenser to the generator in such a

fashion as to use the generator itself as the impedance that we could secure the same results. The final outcome was a condenser of 2100 microfarads installed on each side of the generator. Fig. 2 shows the direct current voltage and current as a straight line; the ripple has been reduced to the point where it is not measurable by means of our oscillograph.

Our method in arriving at this solution of the problem has been one of experimentation, or cut and try plus a certain amount of

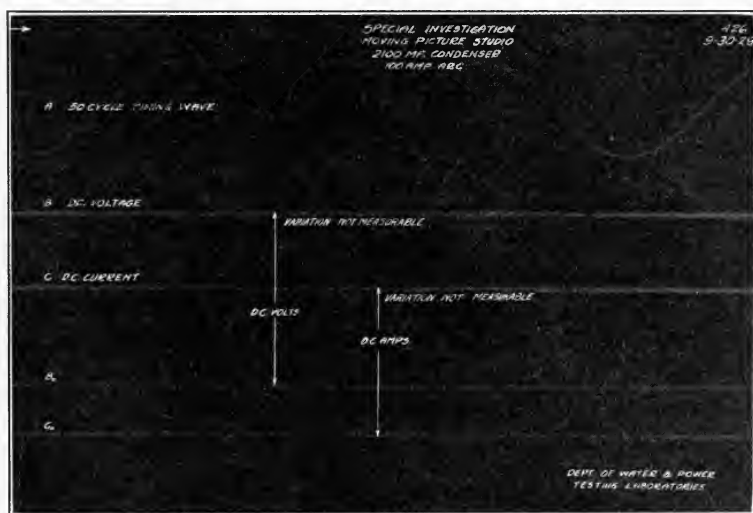

FIG. 2. Oscillograph record of current and voltage with filter.

theoretical calculation. I do not believe that there is available any precedent by which we could govern our work and predetermine the results that would be secured. We are continuing the experimentation and hope to have available within a very short while ways and means of calculating the amount of condenser capacity necessary and method of connection for the various types and makes of generators. The condenser was built by the use of lightning arrester cones, of which we had a large supply in our warehouse. These were convenient for determining the proper values. The ultimate design of this electrolytic condenser will undoubtedly be worked out by the manufacturers. The main characteristics will be large capacity, low resistance, and compactness.

In conclusion I might mention that the Department of Water and Power is not interested in promoting the use of either incandescent or arc lighting. It is our desire to assist the studios in securing the best results from the consumption of the energy we sell them. If the producers desire to use arcs for production we feel that the way has been cleared for them in a satisfactory manner. For the various types of photography they can now use the various types of lighting equipment, without fear of microphone interference.

DISCUSSION

MR. PALMER: I am very much interested in what Mr. Buck has to say because we have had the same trouble in our studio in running arcs on d. c. generators. We get a whistle from them, and I should like to know what the extra equipment costs for a 500 kw. generator.

MR. BUCK: We have not worked out the design of the filter. We wanted to take it up with the manufacturers, for we feel it is a manufacturing problem. We have decided for ourselves, if necessary, we can construct the filters for this 326 KDA generator and install them for less than \$500.

MR. STOLLER: I might mention that this problem of filtering the a. c. ripple out of a d. c. generator is an old telephone problem in connection with the charging of the central office storage batteries. There is in the *Bell System Technical Journal* considerable literature on the subject of choke coils and electrolytic condensers.

RADIATION CHARACTERISTICS OF TWO MERCURY ARCS

FRANK BENFORD*

INTRODUCTION

The lighting industry from its earliest beginnings to the present time has been under a peculiar handicap because man's best efforts in the production of light have always yielded results different from the light of nature under which mankind has developed. It is no mere accident that the human eye is most sensitive to those rays of the sun that are received most abundantly at the earth's surface. This condition may be looked upon as a natural result of evolution and, if the facts were otherwise, it would be a matter for profound speculation. But while the eye has adapted itself to the light of the sun, there are other natural and artificial factors to be considered.

The beneficial effects of natural light, and of sunlight in particular, have long been known, but it is only recently that definite data have been obtained on the so-called therapeutic rays, and these rays are found to lie entirely outside of the visible spectrum. The rays that tan the skin and promote the growth of the bones lie at the extreme boundary of sunlight as received at the surface of the earth. In this case, our logic of connecting each function of the body to such a part of the spectrum where it will lie under optimum conditions is rather weak, and perhaps in abler hands it might be shown that the presumably older function of the bone growth having a maximum sensitivity to radiation at 2967 \AA ., as contrasted with the newer sensation of vision with its peak at 5550 \AA ., indicates that in previous geologic ages the composition of sunlight was decidedly stronger in the far ultra-violet regions.

A third factor, and the one in which this Society is particularly interested, is the region between the therapeutic range and the visible range, that is, from 3200 \AA . to 4000 \AA .. Here the ordinary photographic emulsion is most affected, and therefore to people who are interested in health, photography, and vision there may be

* Research Laboratory, General Electric Co., Schenectady, N. Y.

points of interest in the following data on the radiation of two mercury arcs that cover the range of radiation over the three regions mentioned.

It is no part of the purpose of this paper to present these lamps as cures for any disease. The purpose is to present data showing that these lamps will help maintain our good health, leaving the cure of disease where it rightly belongs, in the competent hands of the physician.

NATURAL LIGHT

It is rather a sad commentary on the state of present day science

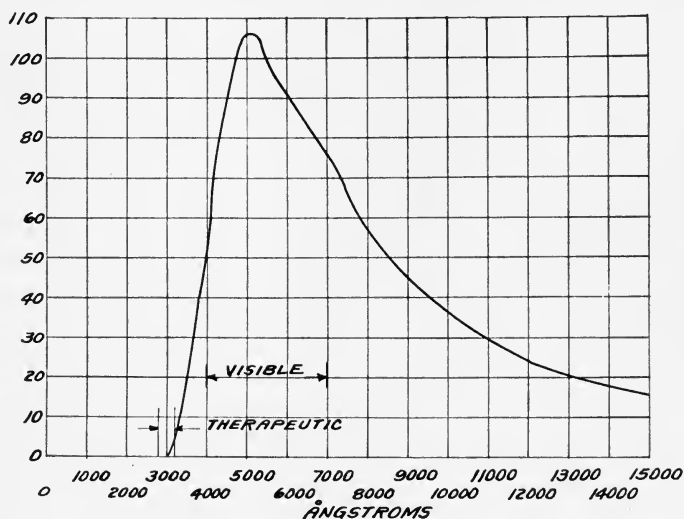

FIG. 1. Sunlight at sea level.

to admit that we have but little precise knowledge of the composition of the very sunlight that seems to be the foundation stone upon which all visible life forms are built. Besides being cheap, and therefore uninteresting, it is extremely difficult to measure, but progress is being made and we can hope for much more definite data in the immediate future. The temperature of the sun is high enough to furnish generous quantities of energy in the therapeutic region between 2800 Å. and 3200 Å. but the earth's atmosphere absorbs all radiation shorter than 2900 Å. and weakens the longer wavelengths so that the physical measurement of their strength is a matter of some difficulty.

There is only one disease, rickets, for which ultra-violet radiation is an accepted specific, but there is good evidence that the same radiations that produce sunburn and tan are of material aid in the cure of several diseases. It has long been accepted that sunlight has great curvative properties, and the recent development has been the identification of the rays that are active in certain cases. The purpose of this paper is to give some physical facts about the radiation characteristics of two mercury lamps, leaving the precise effects

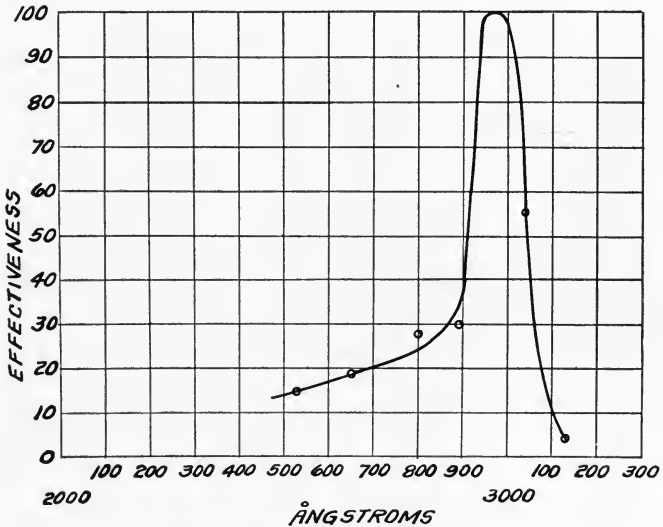

FIG. 2. Effectiveness of radiation in producing erythema or reddening of the skin.

and effectiveness of the various wave-lengths to be determined by the medical profession.

Glass is almost perfectly opaque to the therapeutic rays and hence sunlight received through a window is non-therapeutic, and the glass of the ordinary incandescent lamp renders it equally ineffective. As a result, we who spend a great part of our lives indoors are completely cut off from a vital factor in our well-being. This is a condition that has been the subject of considerable thought and discussion on the part of medical men for years past, but they have been unable to supply the missing ray, and have been forced to wait for the physician and lamp engineers to bring artificial light up to the standard set by nature. Two new units are now available for dupli-

cation of nature's therapeutic effects. One of these is a C. H. Uviarc Sunlamp with an optical filter for absorbing the far ultra-violet beyond the therapeutic range.

C. H. UVIARC SUNLAMP

This lamp is a mercury arc in a fused quartz bulb. Quartz is highly transparent to radiation as short as 1500 \AA . and moreover it is capable of operating at temperatures far beyond the limits of glass. The lamp is therefore useful as a radiant of wide spectral

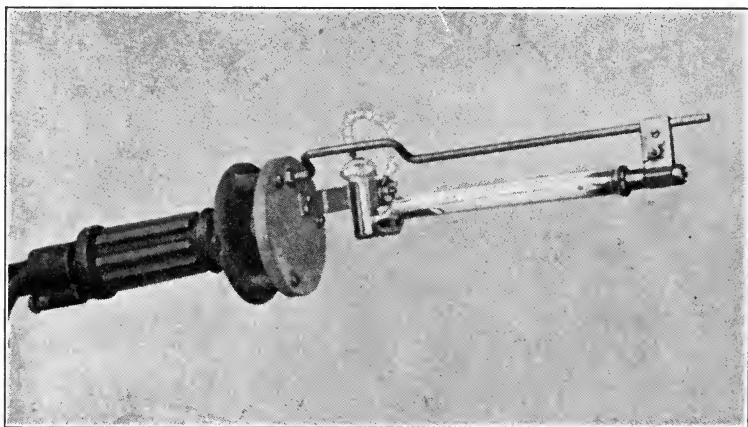

FIG. 3. Horizontal type burner for Cooper Hewitt Uviarc Sunlamp.

range and high specific intensity, and it is a powerful tool for both the physicist and the physician.

This type of arc has an operating characteristic that is often puzzling to an operator not well versed in arcs. If the arc is set to run at 3.75 amperes and 74 volts, it will be found upon closing the switch that the current starts at about 9 amperes with a drop across the lamp of 15 volts. The current drops and the voltage rises until stability is attained when the lamp has reached its operating temperature. The introduction of lamp temperature as a controlling factor must be constantly kept in mind if any accurate control of the radiation is desired. The resistance of the arc depends upon the pressure of mercury vapor in the lamp, and the pressure depends upon the temperature of the pool of liquid mercury. Therefore by attaining control of the temperature of the mercury pool by proper

cooling, the electrical and radiating properties are brought under control.

An analysis of the spectrum of the quartz mercury arc, without filter, in bands 200 Å. wide has been made from 2300 Å. to

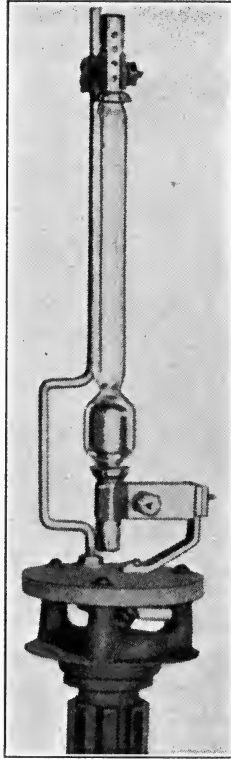

FIG. 4. Vertical type burner for Cooper Hewitt Uviarc Sunlamp.

7000 Å. The energy within this range is radiated in a number of spectrum lines with region of zero energy between. The lines in some regions are so numerous as to make their individual measurement a thankless task, and the zone or group method of measurement is best for the purpose in view. The energy analysis shows a grouping of energy about 3000 Å., the center of the known therapeutic region, a second grouping about 4000 Å., the center of the old photographic

region, and a third grouping about 5500 Å., the center of the visible region. This coincidence of energy with three regions where man's interest is concentrated makes the mercury arc one of the most interesting of lamps.

The lower limit of the therapeutic action is at about 2800 Å. and it is sometimes desirable to eliminate shorter wave-lengths. This is done by an optical filter, as is illustrated in Fig. 6, for the therapeutic group of lines, where the filter passes those lines of most value in

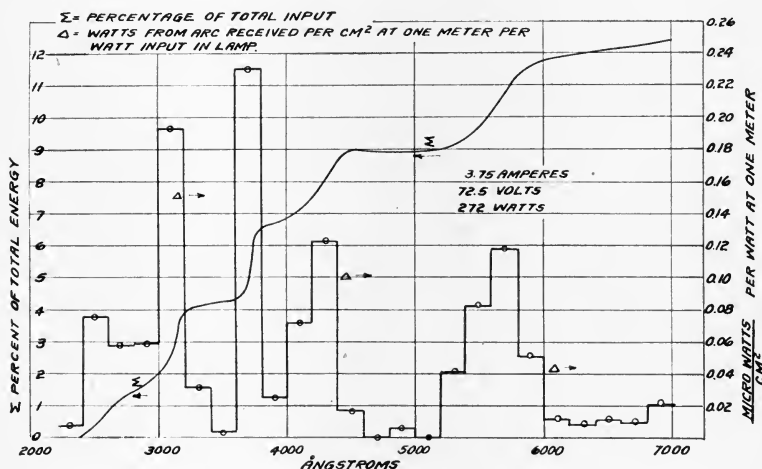

FIG. 5. Energy in spectrum of C. H. Uviarc burner.

therapeutic effect and eliminates much of the valueless short wave energy.

In order to attain the maximum intensity in the 2800 Å. to 3200 Å. region, the current and voltage must be held within certain limits. The radiation was found to show a pronounced maximum at 3.75 amperes when the voltage was held at 72.5 volts, and with a fixed current of 3.75 amperes a practical maximum was found at 72.5 volts. These figures are practically the specified operating figures, and attempts to force the output by overloading the lamp will result in a decrease in the output of the desired therapeutic energy.

The depreciation rate of the quartz mercury arc is always slow, and in this respect it is similar to the low pressure arc in having a long life with radiation that is not rapidly changed by the blackening of the tube. Thus tests have shown a 24 per cent depreciation in

the ultra-violet below 3000 Å. in 1000 hours, but the total ultra-violet from 4000 Å. down dropped only 15 per cent.

G. E. SUNLAMP

This lamp is of a new and unique type, and the present description

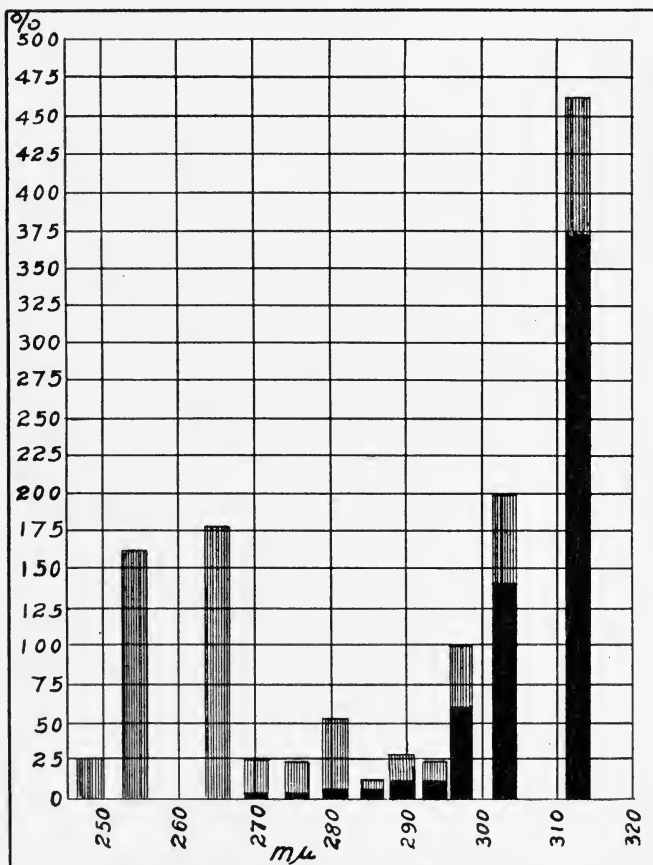

FIG. 6. Uviarc spectrum, with and without Uviarc filter.

is perhaps the first presented to an engineering society. The Research Laboratories of the General Electric Company at Cleveland, Lynn, and Schenectady have collaborated in the development, and the writer's connection has been that of analyst as the lamp has passed through various stages of growth. Essentially the lamp

consists of a mercury arc operating between tungsten electrodes and in parallel with a tungsten filament. A small pool of mercury close

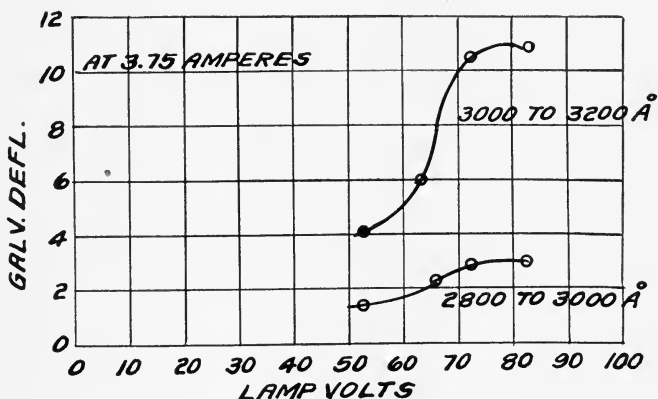

FIG. 7. Volt-energy characteristic of Uviarc at constant current.

under the filament insures a mercury-vapor saturated arc enclosure or the forming and maintenance of the arc. The fact that this arc unctions without moving or auxiliary parts makes it stand apart

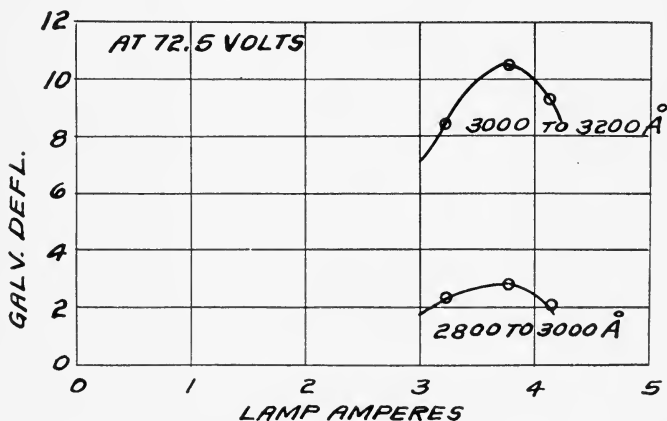

FIG. 8. Current-energy characteristic of Uviarc at constant voltage.

from all other arcs, and challenges the old saying that there is nothing new under the sun.

The bulb of the lamp is made of one of the glasses that absorb the energy below 2800 Å. and at the same time has a high transparency

in the visible region. The operating temperature of the glass is high, but necessarily less than quartz, and therefore the vapor pressure is lower and the brilliancy of the arc is less than in the case of the quartz lamp.

The starting and operating characteristics of this lamp are different from other lamps that are either plane arcs or plane incandescent and not a combination of the two. The lamp is best operated on a transformer with a magnetically saturated core. Upon closing the circuit the filament carries the entire current, which rises to between 7 and 10 amperes before the arc forms, which occurs about a second

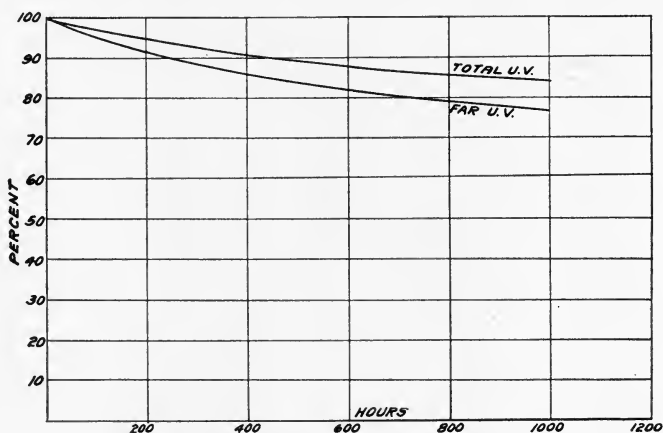

FIG. 9. Typical depreciation curves of Uviarc.

after the current starts to flow. In the case of the particular lamp of Fig. 10, the maximum current was 7.5 amperes at the moment of arc formation. The voltage was 18 volts, but this quickly fell to 10.5 volts when the combined arc and incandescent currents mounted to 30 amperes, which is the normal operating current. In Fig. 11 the solid lines were obtained by reading indicating instruments as the voltage was slowly changed and hence the record probably differs in details from an oscillograph of the normal starting characteristic. The dotted lines represent changes that took place too rapidly for instrument readings, but the real starting characteristic probably does not greatly differ from curves *A*, *B*, and *C*.

At 30 amperes total current the division is about 25 amperes arc and 5 amperes incandescent, the latter being slightly reduced by the conducted heat from the electrodes raising the temperature and

resistance of the top coils. If the line voltage is reduced, the lamp current will gradually fall to 19 amperes at 13 volts, and at about this point the arc will break and then reform with the ends of the arc making contact with both the electrodes and the top coils of the filament. Dotted curves, *E* and *F*, represent the relations existing



FIG. 10. General Electric Sunlamp,
Type S-1.

when the arc is breaking and reforming. A further reduction of line voltage will give the stable characteristic, *G*, but this is not a desirable condition on account of the arc overheating the coils where it makes contact. A further reduction of current to below 10 amperes will cause permanent breaking of the arc and equilibrium will be attained at some point on the filament curve, *A*.

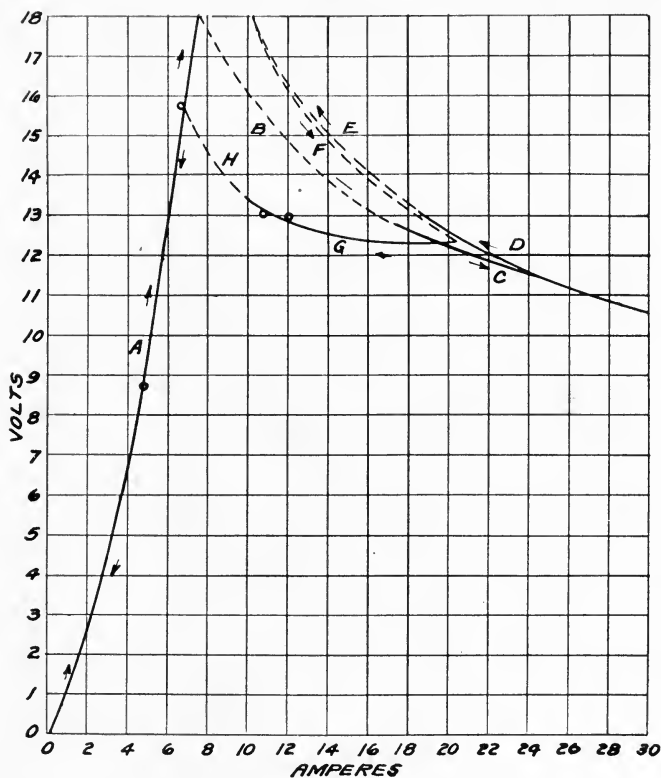

FIG. 11. Volt-ampere characteristic of Type S-1.

From an operating point of view the lamp should be kept above a certain dangerous minimum current (in this particular lamp, 20 amperes) and below a maximum fixed by the rating of the lamp.

The arc spectrum is similar to the quartz-mercury arc for wavelengths greater than 3700 Å. but below this limit the radiation is

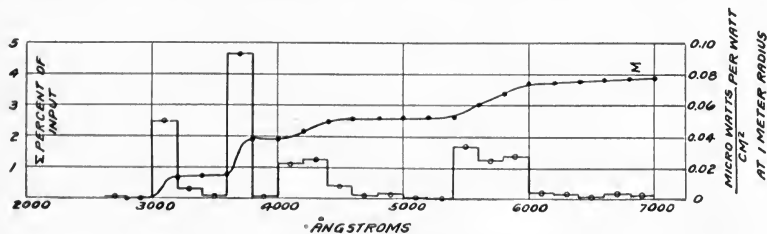

FIG. 12. Arc radiation from Type S-1.

amperes the arc drop changes by a smaller amount and the filament current is not changed by as large a percentage as before. The electrodes radiate greatly increased quantities of energy and the net gain in incandescent light is now much greater.

Perhaps a better picture of the relations between input and radiation is gained by examining the watt-lumen characteristics. In

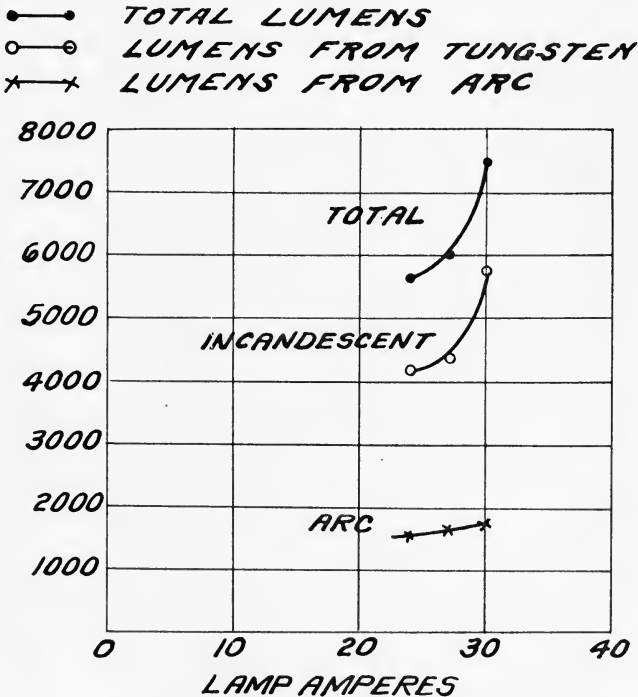

FIG. 14. Ampere-lumen characteristic of Type S-1.

Fig. 15 the arc output of visible radiation is seen to approach a maximum between 300 and 350 watts, while the tungsten radiation increases in more nearly the customary manner of an incandescent lamp. The arc has its maximum efficiency at slightly over 300 watts while the tungsten efficiency increases steadily with the current. The presence of well-marked engineering optima will appeal to the engineer and they seem a guide to good engineering practice.

In Table I a summary is made of some of the therapeutic and luminous properties of the sun and two therapeutics arcs. It will be

seen that in the production of light we have a long way to go before we can hope to rival the sun, but in the production of therapeutic radiation we have taken a long lead over nature. An extended series of tests are being conducted on the production of erythema by these and other lights. So far the results conform fairly well to the purely physical relations here given, and if proper allowance be

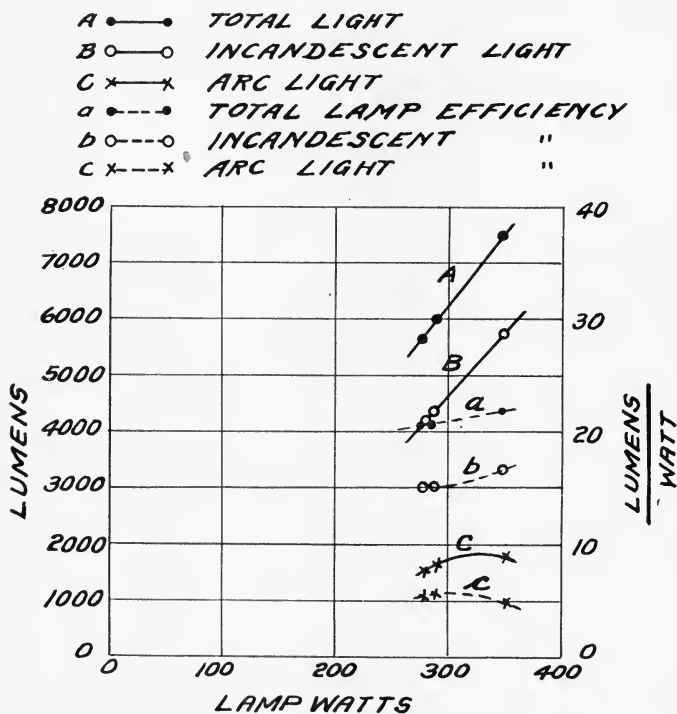

FIG. 15. Watt-lumen characteristic of Type S-1.

made for the finer details of relationship between these radiants and the erythema curve the computed and experimental degrees of erythema are in excellent agreement.

For equal illuminations the C. H. Uviarc Sunlamp with filter is 300 times as strong in the therapeutic region as the sun, while the G. E. Sunlamp is 65 times as strong.

The illumination in mid-summer is often 10,000 foot-candles in direct sunlight, and with present lighting equipment this illumination by artificial means would be unbearable. But the vastly increased

TABLE I

Some Properties of the Sun and the Two Arcs
Energy Analysis in Percentages

Zone	Source		
	Sea Level Sun	Cooper Hewitt Uviarc Sunlamp	G. E. Sunlamp
0-2800 Å.	0.00	0.00	0.00
2800-3200 Å.	0.05	1.60	0.80
3200-4000 Å.	3.75	2.90	1.40
4000-7000 Å.	45.00	5.60	9.40
7000-inf.	51.20	89.90	88.40

ratio of therapeutic rays in these mercury arcs makes it possible to give sunlight therapeutic values at comfortable illumination, and the benefits of sunlight are now obtainable for use in the home.

A METHOD OF TESTING FOR THE PRESENCE OF SODIUM THIOSULFATE IN MOTION PICTURE FILMS*

J. I. CRABTREE AND J. F. ROSS

It is necessary that photographic films be thoroughly washed after fixing; otherwise, if any appreciable quantity of sodium thiosulfate or other sulfur-containing compounds remain in the film, sooner or later they react with the silver image to form silver sulfide with the result that the image becomes brown, and it is said to have faded.

Three common methods are used to detect the presence of sodium thiosulfate in photographic materials and roughly determine the thoroughness of washing:

(1) When the film is thought to be washed, it is lifted from the washing tray or tank and the surface water allowed to drain into 10 or 20 cc. of the following alkaline potassium permanganate solution:

	<i>Metric</i>	<i>Avoirdupois</i>
Potassium permanganate	0.5 gram	7.5 grains
Sodium hydroxide (caustic soda)	1.0 gram	15.0 grains
Water (distilled) to make	1.0 liter	32.0 ounces

For use take stock solution 1 part, water 20 parts. If a small percentage of hypo is present, the violet color will turn orange in about 30 seconds, and with larger concentrations of hypo the orange color will change to yellow.

Oxidizable organic matter, if present in the water, reacts with the permanganate solution and changes the color in the same manner as hypo. The water should, therefore, be tested as follows:

Add a quantity of water equal in volume to that of the wash water drained from the film to a second test solution prepared as above from pure water. If the sample to which tap water has been added remains a violet color, this indicates the absence of organic matter and it will be unnecessary to repeat the test. If the color is changed slightly by the tap water, the presence of hypo in the film will be shown by the relative color change of the two samples. For

* Communication No. 412 from the Kodak Research Laboratories.

example, if the tap water sample turned orange, and the wash water sample became yellow, it would indicate the presence of hypo; but if both samples remained the same shade, this would indicate the absence of hypo.

This method is subject to error inasmuch as the quantity of hypo in the water drained from the film constitutes only a small proportion of the quantity absorbed by the film, so that a negative result with the above permanganate test does not necessarily indicate the absence of hypo.

(2) A drop of a dilute potassium permanganate solution (0.5 gram per liter) is placed on the dry film. Any rapid change in the color from brown to yellow indicates an unsafe degree of washing, but since permanganate is likewise reduced by silver and gelatin, a slow discoloration occurs even in the absence of hypo. By carefully comparing the rates of discoloration of the permanganate, however, a satisfactory estimate of the relative quantities of hypo present can be made.

(3) Strips of the film being tested are soaked for several hours in a small volume of distilled water. A few drops of starch solution are added to this solution and then a drop of dilute iodine solution (1 gram of solid iodine dissolved in 20 cc. of water containing 2 grams of potassium iodide, and after the iodine is dissolved the solution is diluted to 100 cc.). If the solution turns blue immediately because of the formation of a starch iodide complex, the material is free from residual sodium thiosulfate. If, however, several drops of the iodine solution are required to produce a permanent blue coloration, the material is poorly washed. By using a standard iodine solution it is possible to determine quantitatively the sodium thiosulfate per unit area of film.

(4) The new method of determining the thiosulfate content of films consists in placing strips of these materials in a solution of mercuric chloride, preferably one which also contains potassium bromide, and observing any turbidity which may develop in the solution. If sodium thiosulfate is present, it reacts with the mercuric chloride to form mercurous chloride which is relatively insoluble and causes a turbidity to appear in the solution; while in the presence of potassium bromide, the precipitate consists of mercurous bromide. If no sodium thiosulfate or other reducing agent is present, the solution remains clear although the silver image is bleached white. This method is also subject to error inasmuch as it

indicates the presence of any reducing agent whether it be sodium thiosulfate or not, but this error is also common to the three above-mentioned methods.

The use of mercuric chloride, however, has several distinct advantages as follows: (1) Only a relatively small quantity of the film or print is required for testing; (2) the test can be made very quickly; (3) it probably indicates the presence of a reducing agent more satisfactorily than the other methods inasmuch as mercuric chloride causes the silver image to be bleached and thus liberates any adsorbed insoluble thiosulfate compounds which might be associated with the silver; and (4) it is extremely delicate and capable of detecting the presence of 0.05 milligram of sodium thiosulfate (crystals).

The Test Solution.—Although a plain solution of mercuric chloride gave good results, the following formula containing potassium bromide was more sensitive:

	<i>Metric</i>	<i>Avoirdupois</i>
Mercuric chloride	25 grams	365 grains
Potassium bromide	25 grams	365 grains
Water to make	1 liter	32 ounces

Method of Testing.—Two methods of testing the thoroughness of washing of photographic materials are possible, as follows:

(a) By determination of the absolute quantity of hypo in the film.

Data on the hypo content of photographic films are of little value unless they are accompanied by data giving the quantity of hypo necessary to cause fading or otherwise impair the image. Such data are outlined below.

The absolute hypo content of the film may be determined as follows: Place 10 cc. of the mercuric chloride solutions in each of a series of small, glass cylinders. Place a single frame of motion picture film cut into small pieces in one of the cylinders, and then add increasing quantities of a 1:1000 solution of hypo to each of the remaining cylinders containing the test solution. Allow them to stand for 15 minutes, stirring the film occasionally with a glass rod, and compare the opalescence of the solutions. The quantity of hypo in the cylinder whose opalescence corresponds with that containing the film is equal to the quantity of hypo in the film strip.

(b) By comparison of the test film with films which have been washed for known safe periods.

The actual quantity of sodium thiosulfate contained in a photographic film or paper is of less practical interest than the relative degree of thoroughness of washing of the material. Common practice has more or less established washing times for various materials which are known to give stable images upon keeping as indicated below, so that by comparing the hypo content of the test film with that of films washed for increasing times, a measure of the thoroughness of washing is obtained.

The test is conducted as outlined above, namely, 10 cc. of the test solution are placed in a small glass cylinder and a single frame of the motion picture film is placed in the solution, taking care to use a glass rod or other non-metallic material to push the film under the solution. Standard films which have been washed under known conditions for 10, 20, 30, 45, and 60 minutes are used for comparison. Allow the solutions to stand for 15 minutes and compare the degree of opalescence by looking down the tube from the top.

The mercuric chloride test has been used to determine the relative washing times, in comparison with standards, of motion picture negative and positive films and the test was found satisfactory in all cases.

The quantity of material and the volume of solution used in making the test can be varied depending upon the quantity of material available for the test. One frame of standard motion picture negative film in 10 cc. of solution was found sufficient for a satisfactory test, while at least twice this area of film was required for the positive film test because the emulsion thickness of positive film is less than that of negative.

THE FADING OF SILVER IMAGES

In the presence of extremely small quantities of hypo or other sulfur-containing compounds, the rate at which the silver image is converted to silver sulfide is extremely slow at normal temperatures so that it was necessary to devise an accelerated test in order to hasten the rate of fading. The most satisfactory test consisted in suspending the test samples of film in a glass fruit jar, containing carbon dioxide gas, over a small quantity of water (Fig. 1) and storing at a temperature of 110°F. The strips of film to be tested were first arranged around the edge of the jar, an excess of carbon dioxide gas passed into the jar from a gas cylinder, and the jar then rapidly sealed. Careful tests indicated that the carbon dioxide did not attack the image but merely accelerated the fading reaction.

From an exhaustive series of tests it has been found that the rate of fading of a silver image in air free from sulfur compounds depends upon the following factors:

- (a) The size of the grains which comprise the image.
- (b) The temperature and humidity of the air during storage.
- (c) The quantity of hypo or other sulfur-containing compounds retained in the image.
- (d) The relative acidity or alkalinity of the gelatin film containing the image.

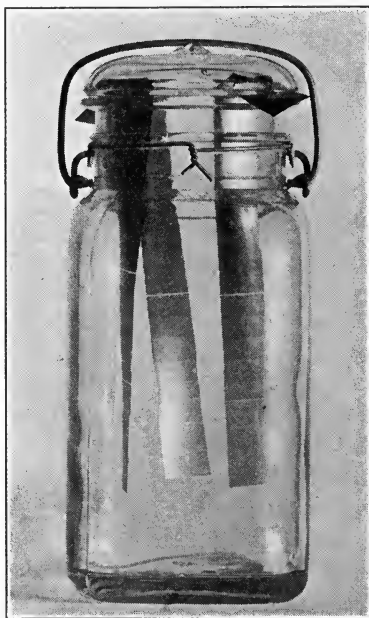

FIG. 1. Illustration of method of conducting fading tests.

The size of the image grains is, perhaps, the most important factor involved. With images such as exist on motion picture film, it is somewhat difficult to produce fading even in the presence of appreciable quantities of hypo, whereas with extremely fine-grained images fading may take place in a few hours' time under the above test conditions, even in the presence of relatively small quantities of hypo. A maximum degree of immunity to fading exists, therefore, with well-washed images which are stored in a dry atmosphere at a temperature which does not exceed 70°F. to 75°F.

THE TIME OF WASHING REQUIRED TO INSURE STABILITY

The washing time required in order to insure stability of motion picture film images depends, of course, upon the method of washing and particularly the rate of removal of the water at the surface of the film.¹ In the present experiments samples of motion picture film were washed in flat trays with an excess of running water at 60°F. After washing for increasing times, the samples were then subjected to the carbon dioxide fading test described above.

Table I indicates the critical times of washing required before no fading was obtained on storing for one week at a temperature of 110°F. in an atmosphere of carbon dioxide.

TABLE I
Critical Washing Time

Nature of Material	Time of Washing Required to Give Negative Result in Fading Test
Eastman Motion Picture Panchromatic Negative Film (Type 2)	2 Minutes
Eastman Motion Picture Positive Film	5 Minutes

The fact that motion picture negative film washed for 2 minutes did not fade in the above test does not mean that this time of washing is sufficient for practical purposes, because the relationship between the time to produce equal degrees of fading under normal storage conditions and conditions existing with the accelerated test is not known. It is desirable in all cases to eliminate the hypo entirely and Table II indicates that it is necessary to wash negative film for 30 minutes in order to do this.

The above result, however, is significant in showing that the image on motion picture negative film is very resistant to fading, and in the experience of the authors very few cases of the fading of negative images which could be attributed to imperfect washing have been encountered during a period of 15 years.

In view of the fact that the image on motion picture positive film is composed of finer grains than a negative film image, it is more susceptible to the presence of traces of residual hypo. By washing for five minutes, the image is practically immune from fading but a

¹ HICKMAN, K. C. D.: "Washing Motion Picture Film," *Trans. Soc. Mot. Pict. Eng.*, No. 23 (1925), p. 62.

washing time of 20 minutes is required under ideal washing conditions to eliminate the hypo thoroughly.

THE HYPO CONTENT OF WELL-WASHED IMAGES

The hypo content of various materials washed for increasing times under the following conditions are given in Table II. Strips four inches long of the developed and thoroughly fixed films were placed in shallow trays 4 by 6 cm. and a stream of water allowed to flow into the trays at the rate of one gallon per minute, the water being completely emptied from each tray at two minute intervals.

TABLE II
Time for Elimination of Hypo

Material	Time of Washing	Hypo Content
Eastman Motion Picture Panchromatic Negative (Type 2)	2 Minutes	12 Mg. per foot
	5 Minutes	8 Mg. per foot
	10 Minutes	4 Mg. per foot
	20 Minutes	1 Mg. per foot
	30 Minutes	No test
Eastman Motion Picture Positive Film	2 Minutes	8 Mg. per foot
	5 Minutes	2 Mg. per foot
	10 Minutes	1/2 Mg. per foot
	20 Minutes	No test

A number of strips of motion picture negative film secured at random from a number of Hollywood laboratories showed a maximum content of 1 mg. of hypo per foot. A test of a number of strips of positive films from different laboratories indicated the almost complete absence of hypo. These tests would indicate, therefore, that present day laboratories are washing their films satisfactorily.

Practical Recommendations.—The times of washing required to insure the stability of motion picture film as indicated above are given merely as an indication of what is required under ideal conditions. In practice, the conditions of washing vary so greatly that it is absolutely impossible to recommend specific washing times, which is the reason for determining the hypo content of films or prints washed for increasing times under any given conditions, and selecting the time which will give the necessary stability.

SUMMARY

A method of testing for the presence of sodium thiosulfate in motion picture film has been worked out which consists of placing strips of

the processed films in a mercuric chloride-potassium bromide solution. If the film contains an appreciable quantity of sodium thiosulfate, the solution becomes opalescent, the turbidity being roughly proportional to the quantity of hypo present. It is possible to detect the presence of 0.05 milligram of sodium thiosulfate (crystals) in motion picture film by this test.

Some of the factors which determine the rate of fading of silver images have been outlined, and the critical hypo content and degree of washing necessary with negative and positive motion picture film to insure stability have been indicated.

Under ideal conditions it is necessary to wash thoroughly fixed motion picture negative film for 30 minutes and motion picture positive film for 20 minutes in order to eliminate the hypo. Under practical conditions the times are greater according as the conditions differ from the ideal.

The authors wish to express their appreciation to Mr. L. E. Muehler for assistance in the experimental work.

DISCUSSION

DR. HICKMAN: The way in which hypo diffuses out of the film and washes away has been guessed at for a number of years but has been understood well only lately. After two or three minutes, the whole of the hypo that can come away from the gelatin has done so, but there is left in the film a quantity of hypo which comes out more slowly because it is probably stuck on to the silver grain itself. I should like to ask whether any of the tests have been made by differentiating between blank film and that having a fairly heavy deposit.

MR. CRABTREE: No, we have not made such tests. We took samples at random from commercial productions. It would be well to repeat the tests with images of low and high density and I think that such information will be very valuable.

MR. RICHARDSON: We now have samples of motion picture film that are at least twenty years old which show no appreciable fading effect. Would that not indicate that the hypo had been removed?

MR. CRABTREE: It indicates that the films were very well washed when processed.

A NEW SIXTEEN MILLIMETER MOTION PICTURE CAMERA

JOSEPH A. DUBRAY*

The Bell & Howell Company has recently brought out a new model 16 mm. camera, which is known as the Filmo Model 70-D. It presents such a departure from the Design 70 models, that it is not expected to supplant them but is considered as an entirely new member of the Filmo family.

Some of the engineering developments achieved in this apparatus will be described.

It is well known that the Filmo camera is of the spring motor type, that it has a total capacity of 100 feet of 16 mm. film, and that each complete winding of the spring motor permits, if desired, an uninterrupted run of 25 feet of film.

The camera, as shown in Fig. 1, is equipped with a turret, *T*, capable of holding three photographic objectives and also with a spring motor winding key, *W*, of new design.

It is also equipped with three dials, one shown at *F* indicates the footage run through the camera, the second at *S* serves to set a governor to run the camera at any desired speed from 8 to 64 pictures per second, and the third at *E* serves as a guide and instructor in regard to exposures in relation to the speed at which the camera is operated.

The camera turret can be revolved in either direction to bring the desired lens into its proper photographic position.

The lens seats shown at *L* are ground during the assembly of the apparatus, insuring the standard 0.690 in. distance from the lens seat to the film plane.

An audible click, caused by the spring-controlled roller, *A*, falling into a notch provided in the camera frame, assures the operator that the lens is properly set and the camera ready for operation. This position is also controlled by two supplementary rollers and

* Bell & Howell Company, Chicago, Ill.

spring assemblies, equally spaced, as shown in Fig. 2, which insure stability and perfection of registration.

When the turret is so set that the rollers, *A*, fall into the locking notches, a plunger controlled by the supplementary notches, *N*, is forced into a groove of the operating button and positive locking is insured. The locking device is so designed that the operating button cannot be released unless one of the three lenses is in its exact photographing position. Index marks and captions are conveniently engraved on the camera frame to assist the operator in the setting of

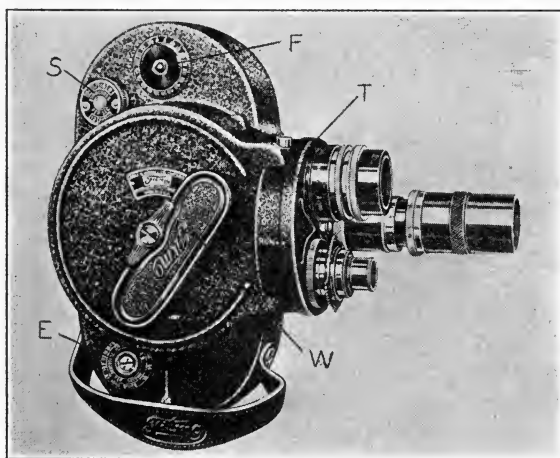

FIG. 1. The Filmo Model 70-D camera.

the turret. The camera door, which gives access to the loading chamber, is located at the opposite side of the winding key and control dials.

As shown in Fig. 3, the door, *D*, fits into the frame of the camera so as to make it light-proof. It is securely fastened to it by means of two simultaneously operating cams, controlled by the latches, *L*, which serve also as indicators for the "Open" and "Closed" markings engraved on the camera door.

The viewfinder, *F*, is an integral part of the camera door, and has been especially designed for its rapid setting at an aperture inclosing the field of view covered by any of six lenses of different focal length.

These openings have been calculated for lenses of focal lengths of 20 mm., 1 in., 2 in., 3 in., 4 in., and 6 in., which quite completely

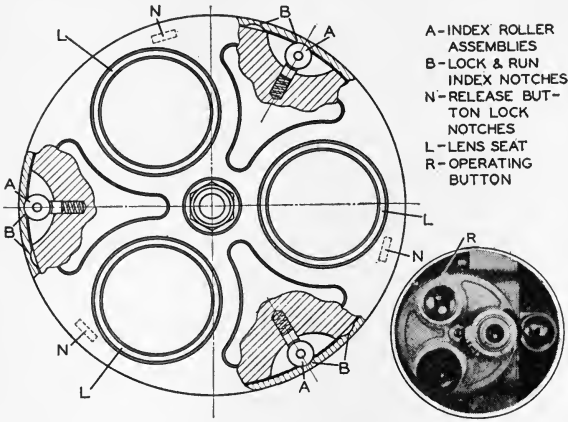

FIG. 2. The multiple-lens turret of the Filmo 70-D camera.

cover the range of focal lengths most generally used by the amateur cinematographer.

Fig. 4 shows a sectional drawing of the viewfinder. As seen in the figure, the image formed by the objective, *L*, and viewed as an erect image of the subject through the eye-piece, *E*, is limited in its area by the opening, *O*, which is set the nearest to the objective.

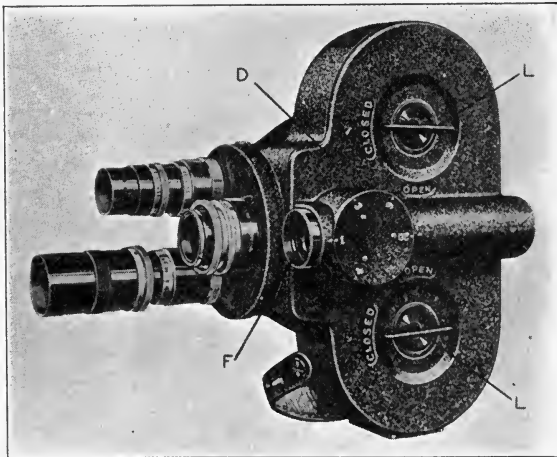

FIG. 3. View of the door and finder side of the Filmo 70-D camera.

A revolving drum controlled by an outside dial is pierced with six apertures rectangular in shape and of convenient size. The diameter of the drum and the position of these apertures have been so calcu-

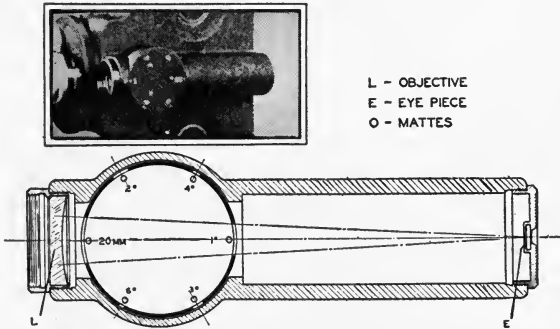

FIG. 4. Viewfinder of the Filmo 70-D camera.

lated that no one of the openings interferes with the one cut in the position diametrically opposite to it. The path of the light rays, as traced in the figure, clearly demonstrates this characteristic. The

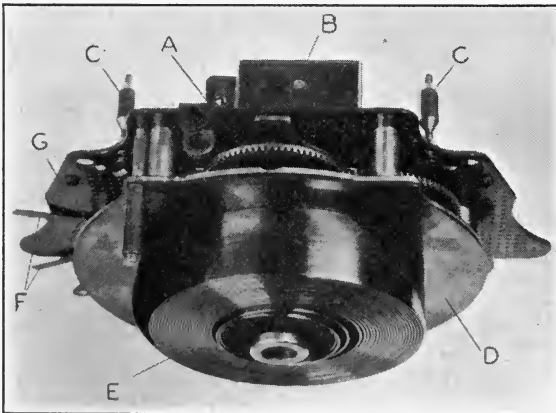

FIG. 5. Mechanism and spring motor assembly of the Filmo 70-D camera.

diagram has been drawn so as to show the aperture corresponding to a 20 mm. lens in the proper position to permit the viewer to examine the whole field of view of a lens of such focal length.

The aperture corresponding to a 1 in. lens, which is cut into the drum in a position diametrically opposite to the first, does not, as shown in the picture, intercept any of the rays of light which are limited by the larger aperture.

It is quite obvious that by reversing the position of these two apertures so that the 1 in. aperture is in the correct viewing position, the greater 20 mm. aperture could not possibly interfere with its

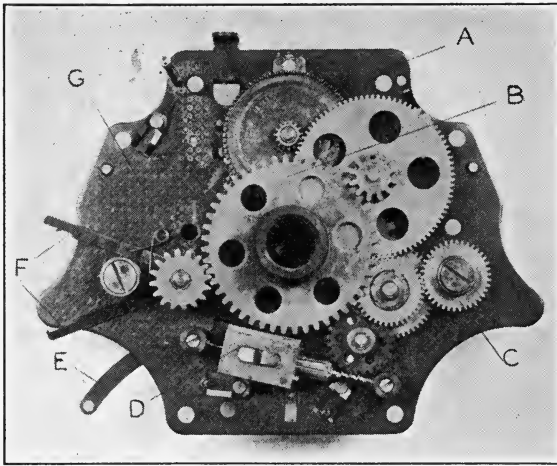

FIG. 6. The mechanism of the Filmo 70-D camera with driving spring and middle plate removed.

field of view. The same condition is fulfilled for all of the remaining four apertures.

The objective lens can be easily replaced with one of lesser power, thereby permitting the use of photographic lenses of other focal lengths. The change of the objective lens would demand the use of a different eye-piece than the standard with which the finder is equipped.

If we remove the camera mechanism from its casing, we will be in a position to see what we would call the "heart" of the apparatus, which is shown in Fig. 5.

At *A*, are shown the shutter and cam driving gear; at *B*, the film back plate, which is of hardened and highly polished stainless steel; at *C*, two of the four film guard spindles; at *E*, the main driving spring and hub, which we may mention in passing is kept free from

grease or oil and is lubricated by dry graphite; at *D*, the graphite retaining plate; at *F*, the two footage dial operating levers; and finally, at *G*, the front motor plate assembly.

If we further remove the driving spring and the middle plate, we will make it possible to see the mechanism proper, as shown in Fig. 6.

At *G*, is shown what we would call the back-bone of the camera, the front motor plate assembly; at *A*, the shutter and cam driving gear; at *B*, the spring-hub and main driving gear; at *C*, the take-up

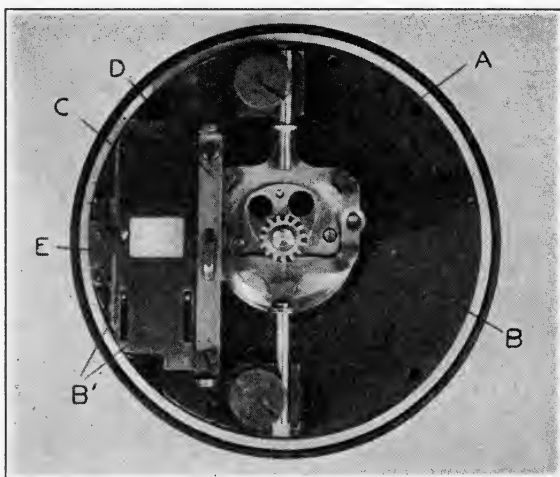

FIG. 7. Head assembly of the Filmo 70-D camera.

spindle gear; at *D*, the governor assembly and driving mechanism, of which we will say a few words later; at *E*, the speed-control lever; and at *F*, the footage dial operating levers.

We shall pass next to the head of the camera, which is illustrated in Fig. 7.

Just as the front motor plate can be called the "back-bone" of the camera, no more appropriate name could have been found for this part of the apparatus than the "head," because it encloses the mechanical brains of the whole instrument.

At *A*, we see the shutter of the camera as being an integral part of the cam assembly, which imparts to the film shuttle, *B*, the composite motion permitting the film feeding fingers, *B'*, to lead the

film, after each exposure, in its proper position in front of the aperture. The maximum possible angular opening of the shutter is 216° , which represents an exposure of $\frac{1}{26}$ th of a second for each picture frame. The aperture plate, *C*, is of hardened, highly polished, stainless steel, and is easily accessible for cleaning purposes. The film tension is of the side-tension Bell & Howell type, controlled by a stationary film-guide rail, *D*, and a spring controlled film side-tension rail, *E*. This all-important feature of the camera distributes

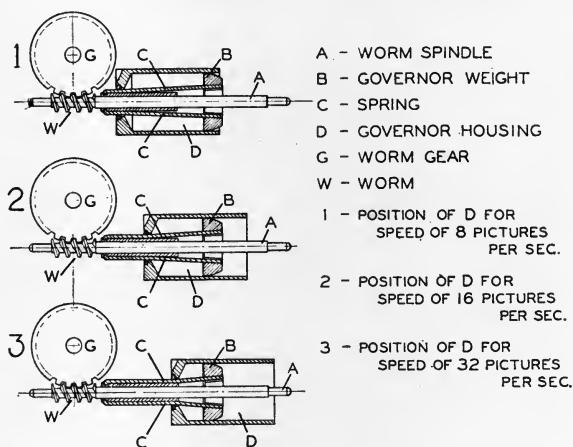

FIG. 8. The governor of the Filmo 70-D camera.

the film tension over a large film area, completely eliminating the necessity of pressure upon the back surface of the film.

The space between the aperture plate and the back plate is fixed to permit a free passage of the film with provision, through a spring arrangement, for allowing the passage of the splices attaching the paper or film leader to the light sensitive material.

We wish to emphasize here the importance of the elimination of back pressure, since it reduces to a minimum the danger of scratching either one of the two film surfaces, especially for those processes such as Kodacolor, in which both surfaces of the film play an essential part. This type of film tension permits an equal degree of accuracy of registration for both forward and backward running of the film, which accounts for the steadiness of the picture during the process of projection.

The speed of the camera is controlled by a governor of entirely

new design, which permits accurate variations of speed from 8 to 64 picture frames per second, and at any of the intermediate speeds.

A worm, *W*, of hardened and polished steel, which is an integral part of a shaft, *A*, has its teeth angularly cut so as to properly engage into the teeth of the driving gear, *G*. The shaft is mounted in an adjustable hardened steel bearing with a ball thrust. Four weights, *B*, each mounted on a spring, *C*, are permanently fastened to the worm shaft.

The speed of rotation is controlled by the sliding outer housing, *D*,

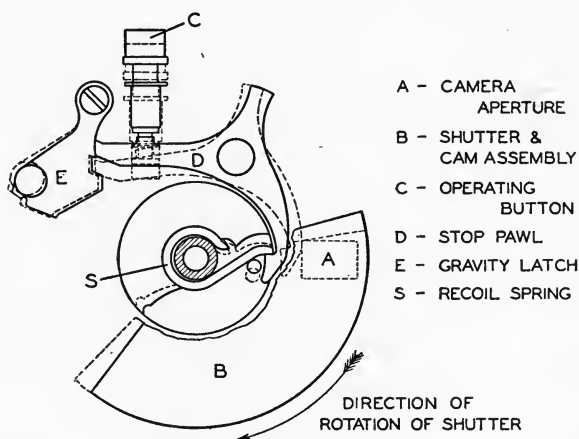

FIG. 9. Stop control of the Filmo 70-D camera.

which regulates the tension of the springs, *C*, by means of the flexure control collar, which is rotatably mounted in the housing, *D*, and is controlled by the speed control dial on the outside of the camera case.

In the figure, position 1 of the case, *D*, corresponds to a speed of 8 picture frames per second; position 2, to a speed of 16 frames per second; and position 3, to a speed of 32 frames per second. If the sliding case, *D*, is set at the end of its allotted path, the camera mechanism will feed the film at the maximum speed of 64 picture frames per second. The action of the governor is instantaneous. This extremely important characteristic permits the use of high speeds without sacrificing the feature of securing a positive stopping of the camera while the shutter is in its position of occultation.

While the governor can be set for any desired speed within the range of from 8 to 64 pictures per second, the setting and indicator

dial on the outside of the camera case is, for the sake of simplicity, graduated only for the speeds of 8, 12, 16, 24, 32, 48, and 64 picture frames per second. The constancy of the camera speed has been obtained through exacting calculations of the length, weight, and tension of the driving spring and through the above-mentioned instantaneous action of the governor.

An oiling system is provided so that all moving parts are automatically lubricated while in operation. Oil holes are conveniently placed and are easily accessible. The governor oiling system consists of an especially designed oil reservoir with felt filling, which is in constant contact with the worm gear and which supplies a continuous flow of fresh lubricant on the governor worm. The capacity of the oil reservoir is calculated so as to insure proper lubrication for a considerable length of time.

It is quite obvious that in a camera operating at as high a speed as 64 picture frames per second, the problem of securing a positive start and stop of the mechanism, in order to avoid differences in exposures during these periods, and the total loss of picture frames, would present some serious difficulties. These problems were solved by devising a unique system of stop pawl and recoil spring, controlled by the camera operating button, which insures a positive start of the mechanism at the desired speed and an equally positive stop at all speeds.

At the moment that the camera release button, *C*, is pressed down, the stop pawl, *D*, disengages from the recoil springs, *S*, allowing the mechanism to function at the speed controlled by the governor. The instant the operating button is released, the stop pawl engages the recoil spring, the weight and tension of which are so calculated as to minimize the shock of sudden arrest. The action of this stop control, added to the instantaneous action of the governor, eliminates the possibility of even the slightest appearance of either acceleration or deceleration.

In presenting this new camera to the public, the Bell & Howell Company feels confident that it will stimulate a further interest in amateur cinematography the world over.

THE ACADEMY OF MOTION PICTURE ARTS AND SCIENCES AND ITS SERVICE AS A FORUM FOR THE INDUSTRY

FRANK WOODS*

A leading figure in the industry was addressing a meeting of the Academy of Motion Picture Arts and Sciences. "I agree with the previous speakers," he said. "The first rush of talking picture production is settling into a longer and steadier stride. We have revolutionized a great creative art and business to the end that it shall be a more expressive art and a better business. New methods to use new machines to secure new effects were thrust upon us hardly more than a year ago. It was the work of a good many days and nights as well to get on friendly terms of acquaintanceship with them.

"Now it is time for an inventory. We need to be sure that we are on a broad foundation. That foundation can only be the widest possible interest and information in the whole motion picture industry so that wherever each person makes his individual contribution it will be intelligently efficient.

"The addition of recorded sound to motion pictures ushered in a new art form with infinitely greater possibilities as a medium than the silent motion picture. In this new form the microphone has taken place alongside the camera as a vital instrument to be skilfully manipulated, to hear as keenly as the camera sees the idea of the artist.

"More and more the public demands better quality as the novelty of sound wears away. The acquirement of this improved technic involves as a basis an accurate understanding of the principles and features, the possibilities and limitations of the new tools.

"Nor should this understanding be confined to a few experts. The production of a motion picture involves a collaboration of a number of specialized crafts whose functions are interdependent. It is as necessary for studio employees generally to have an understanding of the fundamentals of sound recording as it is desirable for the sound

* Academy of Motion Picture Arts and Sciences, Los Angeles, Calif.

expert to have an appreciation of screen drama. A mutual understanding facilitates communication and the coöperation that is so vital."

It was with this idea as a keynote that the Academy of Motion Picture Arts and Sciences undertook a unique, new activity recently which will continue this year over a period of about three months. I refer to the first coöperative all-industry school in the fundamentals of sound recording and reproduction, about which I will give more details in a moment. The school is designed to intensify one phase of the Academy's many sided work as the forum of the motion picture industry on the West Coast.

The Academy is an experiment in organization engineering. It represents the increasingly successful attempt to combine in one unified body the members of the several associated but diversified creative arts on the basis of friendly coöperation for the common good. Its present membership of 388 includes nearly all of the principal actors, directors, producers, technicians, and writers in Hollywood.

One of the most profitable of the Academy activities bearing on the technical side of the industry has been a long continued series of joint meetings among the different branches. On one night, for instance, directors will tell how they suffer between the eccentricities of the producers on the one hand and those of the microphone crew on the other. A subsequent meeting gives the sound men their inning and arc lights have seldom been needed to warm up the debate between sound men and directors or actors. At present in a number of general Academy meetings the recording experts are holding forth for the benefit of the non-technical branches. "Artistic Possibilities of Acoustic Control," was discussed recently, and "Dubbing" (or re-recording) will be taken up this month.

Getting nearer the laboratory itself, a joint committee of three producers and three technicians is now engaged in studying the possibility of a program of research along non-competitive lines for the benefit of the whole production industry. This will supplement the Technical Bureau of the Producer's Association and concern itself with problems of a somewhat different nature. Pending the first report of the committee no more specific announcement can be made.

The present liaison work of the Academy on problems affecting theaters and studios arose from the occurrence of a semi-emergency,

which is discussed further in another paper.¹ On the basis of a survey of conditions a practice for camera and projector apertures has been recommended by the Academy Technicians' Branch in conjunction with the Pacific Coast Section of the S. M. P. E., the American Society of Cinematographers, and the California Chapter of the American Projection Society. A committee is now studying recommendations to correlate practice on release print leaders. Another has for its subject the complex problem of measuring and equalizing screen illumination as between studios, laboratories, and theaters. Both of these will work in advisement with the S. M. P. E. Standards Committee.

The technical school for studio employees which began September 17th developed in a way that it should be admitted, frankly, was a surprise. A meeting of producers and technicians passed a resolution asking the Academy Board to consider sponsoring a class with studio employees as students and recording experts as teachers. The idea was to provide, for the first time in the industry, a systematic résumé of the fundamentals of sound recording and reproduction in language that it wouldn't take a slide rule to understand.

The executives of the sixteen principal studios heartily arranged coöperation, as did the heads of the sound departments. The class was planned for 100 students but a check-up soon showed that nearly 500 had paid the nominal fee of \$10 in advance and secured the signature of both their department heads and an Academy member to their applications. Quotas had to be allotted and the studio executives personally selected the 250 students who now make up the first class, divided into two sections, of 125 each, and meeting one evening a week for the two-hour lecture demonstrations. At the time this paper was written it seemed probable that the Academy Board would authorize organization of a second class of 250 and others to follow from time to time.

The students make up a cross section of the studio personnel although a majority are from the sound departments.

The first four lectures, following an introductory talk by William C. de Mille, vice-president of the Academy, have been given by professors of two universities neighboring Hollywood. Professor A. W. Nye, head of the Physics Department of the University of Southern California, discussed the nature of sound in two lectures.

¹ COWAN, LESTER: "Camera and Projector Apertures in Relation to Sound-on-Film Pictures," *J. Soc. MOT. PICT. ENG.*, XIV (Jan., 1930), No. 1, p. 108.

He was followed by Dr. Vern O. Knudsen, associate professor of physics at the University of California at Los Angeles, and vice-president of the Acoustical Society of America, who discussed the nature of speech and hearing and architectural acoustics.

Three men are taking part in a lecture devoted to recording sound for motion pictures, covering briefly the various methods of recording. Dr. Donald MacKenzie, technical service engineer for Electrical Research Products, Inc., will give the general principles of the Western Electric System. This will be amplified in so far as the Fox-Case method is concerned by E. H. Hansen, who was an expert with the Fox-Case Company previous to his present association as operating head of the Fox Studios sound department. The features of the RCA Photophone System will be explained by Ralph Townsend, supervising engineer for RCA Photophone studios on the west coast.

Reproduction in the theater will be discussed by S. K. Wolf, theater acoustics engineer for Electrical Research Products, Inc., of New York, and by John O. Aalberg, engineer in charge of reproduction in RCA Photophone studios.

The possibilities of acoustical control in recording and reproduction will be outlined by J. P. Maxfield, recording engineer for Electrical Research Products, Inc.

The subject of re-recording will be taken up by Kenneth F. Morgan, supervising engineer of the recording department of Electrical Research Products. This talk will precede a comparative discussion of film and disk recording by Nugent H. Slaughter, chief engineer in charge of recording for Warner Brothers Vitaphone productions, and Albert W. De Sart, technical director for Paramount-Famous-Lasky Studios.

The two final meetings will be devoted to practical problems in recording and reproduction, including demonstrations in the different studios. In these lectures four men will take part: Douglas Shearer, recording engineer in charge of the sound department at Metro-Goldwyn-Mayer Studios; John K. Hilliard, sound director at United Artists Studios; C. Roy Hunter, sound director at Universal Studios; and L. E. Clark, technical director of sound at Pathé Studios.

Roy J. Pomeroy, a pioneer sound director who is credited with installing the first sound-on-film equipment in Hollywood, will discuss the future of sound in motion pictures.

For the benefit of the students the Academy library is being supplemented to include all the standard books on sound and allied subjects as well as the various journals. The S. M. P. E. *Transactions* have an important place here, of course.

In response to a widely expressed demand that the authoritative material included in the lectures before the school be made available in more permanent form, the edited texts of the lectures are being printed as papers for the members of the class. A limited number will also be printed for general distribution.

EDITOR'S NOTE: This paper was presented to the Society in October, 1929. Since that time many of the things described by Mr. Woods as part of the future program of the Academy have become accomplishments.

THEATER LIGHTING*

In a previous report, the Theater Lighting committee's preliminary survey of lighting conditions in theaters was described and the plans for a more extensive survey discussed. It was first thought that it would be desirable to obtain data in a relatively large number of theaters, getting as complete information as possible, including phases not embraced in the preliminary survey, and a complete test outline was worked up.

Since the last meeting of the Society, the committee has been able to study the problem from a broader viewpoint, from which it appears that the more advisable procedure is the obtaining of illumination intensity and brightness measurements in a relatively small number of theaters, especially selected by the committee because of certain desirable and undesirable characteristics. On the occasion of a committee meeting held during the summer, several theaters in Rochester were visited and the lighting at each criticized. At these theaters a number of unsatisfactory conditions were noted, such as too abrupt changes in lighting intensity, excess of extraneous light on the screen, distracting light sources near the line of vision, screen surroundings, and front of theater too dark, *etc.*

Particular study has been made of the relation of screen brightness, screen surroundings, and front wall brightnesses to vision. Using values actually obtained in theaters, Holladay's data were employed to check two principal factors: first, whether the brightness contrasts obtained were satisfactory from the standpoint of comfort, and second, whether they interfered appreciably with visibility.

From the standpoint of visual comfort, the worst conditions obtained when a very light film, say, an animated cartoon with a light transmission of 80 per cent, is viewed from a close distance with the screen surroundings very dark, such as black velvet with a brightness of 0.0002 millilambert. Using the arbitrary scale developed by Holladay, the contrasts produced with a screen brightness of 24 millilamberts gave a condition which can be designated as uncomfortable.

* Report of Theater Lighting Committee, Nov., 1929.

The same film reviewed at about three times the distance (approximately 72 feet) causes less visual shock and could be classified as almost perceptibly uncomfortable with dark surroundings, and with screen surroundings ten times as bright could be classified as almost comfortable.

Table Showing the Visual Comfort Scale (Holladay)

Scale Value	Sensation Classification
0.3	Scarcely noticeable
0.6	Most pleasant
0.9	Still pleasant
1.2	Limit of pleasure
1.5	Very comfortable
1.7	Still comfortable
1.8	Less comfortable
1.9	Boundary between comfort and discomfort
2.2	Perceptibly uncomfortable
2.4	Uncomfortable
2.6	Boundary between objectionable and intolerable
2.8	Irritating

Somewhat different conditions exist when film more nearly average in character is projected. Using in this case a screen brightness only one-eighth that for the light film and a viewing distance of 25 feet, the sensation could be classified as comfortable for dark screen surroundings; and the sensation would be at the limit of pleasure, that is, the higher limit of that brightness which is pleasant to view, when the screen surroundings were increased to ten times the brightness or approximately that which would obtain in a theater which had a buff front wall illuminated to about 0.004 foot-candle and surfaces surrounding the screen of about the same illumination and brightness.

From the standpoint of visibility, conditions are best when the screen surroundings are darkest. This condition, however, is the least pleasant from the standpoint of visual comfort. Calculations from data furnished by the same authority indicated, however, that the changes in visibility are very small, within the range of change in screen brightness referred to previously, that is, from black velvet surroundings to materials reflecting about ten times as much light, so that it would appear that visual comfort is the more important factor and that the screen surroundings may be made as bright as is practical from the standpoint of lessened contrasts due to extraneous light reaching the screen.

Since conventional methods of obtaining of brightness measurements in the theater become a very laborious job, the possibility of obtaining measurements photographically was discussed. An investigation of possibilities indicates, however, that for the present at least this method would not be practicable. It appears necessary, therefore, to use portable photometers to obtain the brightness measurements still required by the committee. It is the plan to confine further measurements to a very few theaters in which limiting or good conditions obtain and at the same time combine with them data on comfort and acuity observations made by at least two committee members working together and, if possible, others making observations at the same time.

The recommendations of the Japanese National Committee on Cinema Lighting, presented at the last meeting of the International Commission on Illumination, specified an average intensity of screen illumination of about 2.3 foot-candles. This value is considerably below that obtained in most theaters in this country. Other interesting features of the report are the recommendations that for long pictures the sessions be arranged so that the duration for a continuous viewing shall not exceed two hours, and the inclusion of recommendations on ordinary lighting to the effect that there shall be enough light to distinguish the spectators' countenances, gradual diminution in the lighting of the lamps, and the gradation of intensity between the main auditorium and the exterior of the theater.

Respectfully submitted,

F. BENFORD

F. M. FALGE

L. A. JONES

A. C. DOWNES

R. E. FARNHAM

I. L. NIXON

CARL E. EGELER, *Chairman*

REPORT OF PROJECTION COMMITTEE*

VENTILATION OF LAMPHOUSE AND RHEOSTAT ROOMS

In its initial report to the Society last Spring the Projection Committee stated that the ventilation section of the report was far from complete, but promised to go more thoroughly into the matter in the succeeding six months.

Some progress has been made, but the section is still incomplete. No definite data has been secured regarding the volume of smoke and gas that may be expected in the case of a film fire. Until this is done all recommendations as to the ventilation necessary to remove these fumes would be purely guesswork.

With regard to the ventilation of the lamphouses and rheostat room, however, the problem is much more simple. Starting with the reasonable assumption that the vent flue temperature should not exceed 300°F., it becomes merely a problem of calculating the air volume necessary to carry away the wattage dissipated at the temperature rise of 230°F.

Considering the case of the large de luxe theater, it is not unreasonable to assume that within a few years the connected load will be about as follows:

4 H. I. Arcs, each 150 amps. and 80 volts	48,000 watts
2 Stereo Arcs, each 50 amps. and 50 volts	5,000 watts
2 Effect Arcs, each 100 amps. and 60 volts	12,000 watts
2 Spot Arcs, each 100 amps. and 60 volts	12,000 watts
	<hr/>
Total	77,000 watts

It is, of course, not likely that all of this load will be connected at any one time, but the draft adjustment for best results is quite critical; consequently, it is impractical to install a system having capacity less than sufficient to care for all equipment simultaneously. Such a system then should be capable of removing 77,000 watts continuously with a temperature rise of 230°F. This 77,000 watts is equivalent to 4380 Btu. per minute and, assuming a temperature rise of 230°F. and a specific heat of 0.25 for the flue gas, we find the

* October, 1929.

system should exhaust 76.2 lb. of gas or 1456 cu. ft. per minute. This is in the ratio of one cu. ft. per minute for each 53 watts of total connected load, and this ratio might be used to calculate the ventilation requirements for smaller installations.

At this point it should be mentioned that to draw this relatively large quantity of air through a lamphouse without affecting the stability of the arc will require very careful lamphouse design. Vent-pipes should be as large as possible near the lamphouse (pipes eleven inches in diameter have been used on 100 ampere arcs with decidedly beneficial results) but the system as a whole should have sufficient "ventilation resistance," so that atmospheric conditions will have but a negligible effect. The ventilation characteristics of some high intensity lamphouses have been improved by moving the vent-pipe forward from the center of the top to a position directly over the positive flame.

In the case of the rheostat room the problem is slightly different. Here, due to the need for accessibility, the use of tightly fitting flues is not practical, and lower temperatures must prevail, but only the maximum wattage to be dissipated for an extended period of time need be considered. For the large installation before mentioned, assuming a line voltage of 115, this will be about as follows:

2 Spots each	100 amps. and 55 volts	11,000 watts
1 Flood	150 amps. and 35 volts	5,250 watts
2 Effects each	100 amps. and 55 volts	11,000 watts
1 Projector	150 amps. and 35 volts	5,250 watts
Total		32,500 watts

This is equivalent to 1850 Btu. per minute and, assuming a temperature rise of 30°F., the system should have a capacity of 3475 cu. ft. per minute, or one cubic foot per minute for each 9.3 watts. This ratio would, of course, apply for any type of converting or controlling equipment merely by applying it to the total watts lost over a period of time.

The constants used in the foregoing calculations were taken from Babcock & Wilcox' *Steam*, and are as follows:

Approximate specific heat of flue gas at 300°F.	= 0.25
1 pound air at 100°F.	= 14.1 cu. ft.
1 pound air at 300°F.	= 19.1 cu. ft.
1 kilowatt hour	= 3413 Btu.

PROBLEMS OF THE PROJECTIONIST

The Chairman of your committee was obliged to devote two of the past six months to some special work. This caused the piling up of so much regular work that it has been impossible to give the work of the Projection Committee that attention it should have had.

However, what we shall lay before the Society is perhaps even of greater importance than would be some one of the other many things your committee has under consideration. In fact, your committee feels that what we shall set before you is deserving of your very serious attention, and such action as you may see fit to take along the lines we shall suggest.

Gentlemen, we would direct your attention to the fact that the chief thing now needed to improve the excellence of screen images in our many thousands of theaters, is that projectionists be helped and encouraged to make every possible effort to get from the really splendidly efficient equipment now available its full possible excellence in performance.

In the years now past the procedure has been, save in a relatively few isolated cases, almost exactly the opposite. It is but a statement of plain, known fact to say that in the past a very large percentage of the men engaged in projection have met with what has amounted to a literally astounding amount of discouragement. Many have been forced to work with equipment which had entirely outlived its day of usefulness, and in addition was in a literally terrible state of disrepair.

There has been a decided tendency to belittle the work of projection and to make light of it. There has even been a tendency, in not a small number of our theaters, to impress upon the mind of the projectionist the idea that the study of technical matters relating to projection is of very little importance and that all such matters are being and would be attended to by others; that projection is purely a mechanical and electrical operation which can be performed acceptably by almost any one after a bit of coaching.

This attitude toward projection and the projectionist has been taken by a large number of theater managers apparently under the impression that such a course would tend to induce projectionists to accept less money than would be the case were they encouraged to respect their profession and to regard its work as of high importance.

These men have overlooked or ignored the fact that the discouragement set up by such a course might well react in such a way that

there would be far greater loss at the box-office by failure to place the product of the motion picture industry before the public at its highest entertainment and amusement value, and by excessive machinery deterioration caused by the indifference thus generated in the mind of the projectionist, than any rise in wages could possibly amount to.

Gentlemen, the excellence of everything this great industry has for sale to the public is in considerable measure directly dependent upon the excellence with which it is displayed upon the theater screen. As has been many times pointed out to you, if a production be poorly or indifferently projected on the screen, then its entertainment value is automatically lowered as against what it would have been had it been projected in the best possible manner. You know that; we all know it.

We also know that men engaged in any line of human endeavor will do far better, more perfect work if they are encouraged to believe the work they are engaged in is of real importance, and is therefore a work in which they may and should feel pride.

This being true, and we believe you must all agree that it is true, would it not have beneficial effect did this Society take such steps as may seem practicable to encourage rather than discourage high class work in projection, to the end that the finished product of this great industry be placed before its buyers at its highest possible value?

In line with this proposal your committee respectfully suggests: (a) that the President of the organization controlling motion picture projectionists, the I. A. T. S. E. and M. P. M. O., be invited to join this Society; (b) that this Society, either through its officers or through a committee to be appointed by our President, confer with the President of the before-named organization with the idea of inducing him to favor the establishment of a suitable apprenticeship system by means of which candidates for membership in his organization may approach with a good basis of both practical experience in the work of projection and technical knowledge relating to it; (c) that he also be urged to use every possible means for inducing the local units of his organization to encourage the production of the best possible work by their members.

Admitting that what we propose cannot be expected to work any immediate large benefits, we direct your attention to the fact that we ask nothing which is difficult of accomplishment and that

in any event no possible harm can be done by acquiescence to our proposal. On the other hand, it will indicate that this Society recognizes the high importance of excellence in the work of projection and proposes to put its weight behind the movement for its betterment. It also will be visual evidence to the projectionist that at last a really authoritative body other than his own organization is giving direct, official recognition to both him and his work.

Respectfully submitted,

A. H. GRAY

HARRY RUBIN

C. L. GREENE

J. H. KURLANDER

HERBERT GRIFFIN

M. S. SWAAB

LESTER ISAACS

F. H. RICHARDSON, *Chairman*

DISCUSSION

MR. C. L. GREENE: I wish to state, in the event that the Society sees fit to accept and approve the ventilation section of the report, I have a request to make particularly of the members of the Society who are now connected with developments in wide films. When I wrote the supplement, I thought I was being far-sighted when I assumed an average of 150 amperes for the projection arc for wide film, but before the first session had been on two hours I heard discussion of 200 and 250 ampere arcs. As work progresses, if the men who are in a position to know what requirements are going to be placed on ventilation would keep the Projection Committee advised along that line it would greatly facilitate our work.

MR. EDWARDS: If the Chairman spoke of the lack of appreciation of projection by the SOCIETY OF MOTION PICTURE ENGINEERS I think it was a slip. I don't think that is quite what was in his mind. I believe that suggestion with regard to the President of the International Alliance becoming a member of the Society is something of value. We happened to have the gentleman in here this morning. I think it is the first time he has sat in on even a portion of our proceedings, and I can assure you he was very much impressed by the type of paper being presented. He was frank to tell me, "I don't understand very much about that, but it engenders new thought, and that is what the industry needs in all branches."

MR. RICHARDSON: I didn't say the Society lacks appreciation; I said everybody.

You have the whole official staff of the organization I mentioned in this building, and it has been suggested that you appoint a committee to cooperate. It should have consideration by the Society.

PRESIDENT PORTER: The body is considering it.

MR. RICHARDSON: You will never have another opportunity like the present one. I move that a committee be appointed to confer with the Board of International Alliance and find what their attitude would be and if official results can be obtained.

PRESIDENT PORTER: Do I hear a second to the motion?

MR. TAYLOR: It seems to me that the lack of action results from general unfamiliarity with the suggestion. I don't know enough about it to be for it or against it. I think the Board of Governors is better able to handle it than the Society is.

MR. COFFMAN: I move that the report be referred to the Board of Governors for action.

(Motion duly seconded and passed.)

ABSTRACTS

The Editorial Office will welcome contributions of abstracts and book reviews from members and subscribers. The customary practice of initialing abstracts will be followed.

Contributors to the abstract section of this issue are as follows: G. L. Chanier, Clifton Tuttle, and the Monthly Abstract Bulletin of the Kodak Research Laboratories.

Solving the "Ice Box" Problem. W. STULL. *Amer. Cinemat.*, 10, September, 1929, p. 7. An account of the various methods which have been used to silence the motion picture camera. Present-day practice attempts to stop the noise as near the camera as possible. Various types of sound absorbing casings for the camera are replacing the old type of sound booth. C. M. T.

New Portable Model RCA Photophone. H. L. DANSON. *Ex. Herald World*, 97, Sect. 2, Oct. 26, 1929, p. 58. The entire projector and sound reproducer system is housed in an all metal cabinet 24 inches square and 12 inches wide, mounted on four adjustable telescopic legs. The amplifier is housed in a separate metal cabinet of similar size. Volume control permits adjustment in graded steps from zero to maximum volume. Accommodation is made in the amplifier for a second projector to permit smooth change-over. The speaker is an electrodynamic moving coil cone type. Film speed is standardized at 90 feet per minute and the projector operates from a power source of 110 volts, 60 cycles a. c. Recording facilities are offered by the RCA Photophone at its Grammercy Studios in New York.—*Kodak Abstr. Bull.*

Sound on a Wire. Stille Electromagnetic System Reviewed. *Bioscope (Mod. Cinema Technique)*, 81, Oct. 16, 1929, p. vii. A steel wire or band is run between the poles of an electro-magnet, which is connected in the ordinary way to a microphone. The variations in the current density produced in the microphone are impressed electromagnetically on the traveling ribbon or wire. By passing the magnetized wire at a correct constant speed between the poles of the solenoid again, variations are produced in the magnetic field corresponding to those which were impressed on the wire. These variations may be amplified to give sound reproduction. The record is permanent under ordinary conditions, but may be completely removed by passing the wire or tape through an electromagnetic field of constant intensity. C. M. T.

Acoustimeter. R. F. NORRIS. *Projection Eng.*, 1, September, 1929, p. 43. The output from a four stage transformer coupled amplifier is measured with a thermo-junction meter calibrated to read sound intensity. A Baldwin type magnetophone is used as the pickup. C. M. T.

Burt Reproducer for Talking Motion Pictures. *Projection Eng.*, 1, September, 1929, p. 50. This reproducer, manufactured by the R. C. Burt Scientific Laboratories, is stated to have several advantages over other types. A synchronous motor drive without flexible drive shafts or universal joints is used. The cell has

a high output therefore less amplification is required than is usual. Two cells are mounted so that a replacement can be readily made in case one cell ceases to function.

C. M. T.

Light Sensitive Cells. JOHN P. ARNOLD. *Projection Eng.*, 1, September, 1929, p. 44. The properties of photo-conductive, photo-electric, and photo-voltaic cells are briefly described.

C. M. T.

Ufa Sound Studios. An Original Lay-Out. *Kinemat. Weekly*, 152, Oct. 24, 1929, p. 30. Four Ufa studios at Neubabelsberg were completed a few weeks ago. These studios are built about a central portion where all the recording apparatus and monitors are placed.

C. M. T.

New Findings in Sound Theater Acoustics. *Ex. Herald World*, 97, Sect. 2, Nov. 23, 1929, p. 30. A summary of observations made in about five hundred theaters is given. Conclusions reached are: that the previously accepted reverberation time value should be corrected, that square theaters are better acoustically than narrow theaters, and that seats should be made to absorb the same amount of sound whether occupied or not.

C. M. T.

New Sound Film Process. G. SEEBER. *Phot. Ind.*, 27, April 3, 1929, p. 389. In this modification of the Poulsen magnetized wire memograph, the film base itself is made magnetic by the incorporation of colloidal particles of a magnetic alloy—cobalt, nickel, and iron.

C. M. T.

Amplifiers and Hookups to Minimize Distortion. P. HATSCHER. *Film-technik*, 5, Aug. 3, 1929, pp. 353-9. The principles of vacuum tube amplification, distortion, general characteristics of resistance coupled and transformer hookups, and explanation of push-pull amplification are given.—*Kodak Abstr. Bull.*

Make-Up Tests by the American Society of Cinematographers. *Amer. Cinemat.*, 10, November, 1929, p. 13. Tests to determine the best make-up for panchromatic film and for color photography have been conducted at the Tec-Art studios under the auspices of the American Society of Cinematographers. It is reported that a new series of paints and greases have been found which photograph as they appear to the eye. The results will be embodied in a quick reference make-up chart.

C. M. T.

Lighting "Rio Rita." *Internat. Phot.*, September, 1929, p. 12. A total incandescent wattage of 976,000 was used during the eight days of filming the color sequences of "Rio Rita."

C. M. T.

The Schufftan Process of Model Photography. HANS NIETER. *Phot. J.*, January, 1930, p. 16. A method of combining actual photography and model photography to create the illusion of immense settings upon the screen. This method uses a mirror of special silvered glass set at an angle to, and near the lens of the camera. A model of the set is constructed. The necessary parts of this set are built upon the studio floor. The mirror is scratched away to allow this portion to be seen by the lens through the clear glass, the rest of the mirror reflecting to the lens the image of the model which matches perfectly with the parts of the set built on the stage.

G. L. C.

Pan Film. *Camera Craft*, 36, November, 1929, p. 526. The use of panchromatic film has made it necessary for the lens designer to correct his objectives for all colors.

C. M. T.

New Depth Process for Motion Pictures. *Mot. Pict. Projectionist*, 2, September, 1929, p. 37. The appearance of depth in a picture is obtained by photo-

graphing the object through a screen of very narrow transparent vertical lines while the camera is moved in an arc around the object, at the same time moving the plate horizontally the width of the lines. When the picture is shown a line screen is placed in front and the two views give an appearance of depth.—*Kodak Abstr. Bull.*

Measure of the Effective Luminosity of Objectives. J. HRDLICKA. *Photo-Revue*, 41, Sept. 1, 1929, p. 267. A simple method is described for finding the effective relative aperture of photographic objectives, by taking into consideration the loss of illumination through reflection and absorption in the lens. An objective rated at $f/4.5$ is found to have an effective aperture of only $f/5.54$.—*Kodak Abstr. Bull.*

Lens Viewing Angles. J. DUBRAY. *Internat. Phot.*, 1, September, 1929, p. 14. Formulas are given which enable the cinematographer to make a rapid calculation of the width of object space embraced by lenses of different focal lengths for both sound and silent apertures. C. M. T.

Distribution of Light Flux from a Mirror Arc. H. NAUMANN. *Filmtechnik*, 5, Aug. 31, 1929, p. 389. The author uses a photographic method to examine the intensity distribution from a mirror arc. The effects of changing arc current or its position with respect to the mirror and of altering the size of the projection objective are illustrated by silhouette photographs. Serious disturbance of the illumination of the film aperture may result from poor adjustment of the arc and reflector. C. M. T.

Color and Its Measurement. J. GUILD. *Phot. J.*, January, 1930, p. 22. The paper deals with the question of applying a standard system of measurement to the color of objective things. Though we can apply physical measurements to the properties of the stimulus of vision, we cannot evaluate the sensation of brightness or that of color. The author discusses Young's trichromatic theory, then studies the effects of visual conditions on color measurement, explaining why the National Physical Laboratory recommends the use in all color measuring apparatus of a field subtending an angle of 2 degrees. With an angle of this size measurement is not affected by the brightness of the field or the adaptation and fatigue of the eye. Standardization of color measurements is more easily effected in the case of additive colorimeters, several of which are described. For standardization of measurement, it is recommended that color measurements be expressed on the trichromatic system. The standardization of the illuminant and the method of illumination are then discussed, as well as the question of the "normal eye" and the problem of correcting the observer's eye by means of auxiliary filters. G. L. C.

Dental Profession Uses Motion Pictures. *Intern. Phot. Bull.*, February, 1930. No less than ten reports made at the 66th Meeting and Clinic of the Chicago Dental Society were illustrated with 16 mm. motion pictures, one of them showing the physiology of mastication made entirely by Dr. Hugh McMillan. G. L. C.

SOCIETY OF MOTION PICTURE ENGINEERS

OFFICERS

President

J. I. CRABTREE, Eastman Kodak Co., Rochester, New York

Past President

L. C. PORTER, General Electric Co., Nela Park, Cleveland, Ohio

Vice-Presidents

H. P. GAGE, Corning Glass Works, Corning, N. Y.

K. C. D. HICKMAN, Eastman Kodak Co., Rochester, N. Y.

Secretary

J. H. KURLANDER, Westinghouse Lamp Co., Bloomfield, N. J.

Treasurer

W. C. HUBBARD, General Electric Vaporlamp Co., Hoboken, N. J.

Board of Governors

H. T. COWLING, Eastman Teaching Films, Inc., 343 State St., Rochester, N. Y.

J. I. CRABTREE, Research Laboratory, Eastman Kodak Co., Rochester, N. Y.

H. P. GAGE, Corning Glass Works, Corning, N. Y.

K. C. D. HICKMAN, Research Laboratory, Eastman Kodak Co., Rochester, N. Y.

W. C. HUBBARD, General Electric Vaporlamp Co., Hoboken, N. J.

J. H. KURLANDER, Westinghouse Lamp Co., Bloomfield, N. J.

W. C. KUNZMANN, National Carbon Co., Cleveland, Ohio

D. MACKENZIE, Electrical Research Products, Inc., 7046 Hollywood Blvd., Los Angeles, Calif.

P. MOLE, Mole-Richardson, Inc., 941 N. Sycamore Ave., Hollywood, Calif.

M. W. PALMER, Paramount-Famous-Lasky, Inc., 6th & Pierce Aves., Long Island City, N. Y.

L. C. PORTER, General Electric Co., Nela Park, Cleveland, Ohio

S. ROWSON, Ideal Films, Ltd., 76 Wardour St., London, W. 1, England.

E. I. SPONABLE, 277 Park Avenue, New York, N. Y.

COMMITTEES

1929-1930

Color

W. V. D. KELLEY, *Chairman*
 J. G. CAPSTAFF W. T. CRESPIEL F. E. IVES

Convention

W. C. KUNZMANN, *Chairman*
 J. W. COFFMAN W. C. HUBBARD M. W. PALMER

Historical Committee

F. J. WILSTACH, *Chairman*
 M. CRAWFORD C. L. GREGORY T. RAMSAYE
 C. F. JENKINS
 O. NELSON

Journal

L. A. JONES, *Chairman*
 J. W. COFFMAN H. T. COWLING W. C. HUBBARD
 J. H. KURLANDER

Membership and Subscription

H. T. COWLING, *Chairman*
 C. BARRELL L. W. DAVEE I. ROSEMAN
 J. W. BOYLE J. DEFRENES E. C. SCHMITZ
 W. H. CARSON E. R. GEIB J. L. SPENCE
 W. CLARK J. KLENKE F. ZUCKER
 M. L. MISTRY
 B. E. NORRISH

Papers

J. W. COFFMAN, *Chairman*
 M. C. BATSEL C. R. HANNA G. E. MATHER
 F. J. CADENAS K. C. HICKMAN R. F. NICHOLSON
 J. A. DUBRAY F. HUSE J. B. TAYLOR
 O. M. GLUNT D. HYNDMAN

ProgressG. E. MATTHEWS, *Chairman*

J. A. BALL	J. B. ENGL	A. C. HARDY
J. BOOLSKY	R. E. FARNHAM	R. C. HUBBARD
W. CLARK	H. B. FRANKLIN	G. F. RACKETT
A. W. DANESHEW	K. GEYER	S. K. WOLF

ProjectionL. M. TOWNSEND, *Chairman*

H. W. DREYER	C. GREENE	W. B. RAYTON
G. C. EDWARDS	H. GRIFFIN	H. B. SANTEE
P. H. EVANS	R. H. MCCULLOUGH	L. M. TOWNSEND
T. FAULKNER	W. A. MCNAIR	D. F. WHITING
	R. MIEHLING	

PublicityW. WHITMORE, *Chairman*

F. C. BADGLEY	B. W. DEPUE	O. A. ROSS
	G. E. MATTHEWS	
	G. F. RACKETT	

SolicitationE. P. CURTIS, *Chairman*

J. W. COFFMAN	E. A. WILLIFORD
---------------	-----------------

Standards and NomenclatureA. C. HARDY, *Chairman*

M. C. BATSEL	P. H. EVANS	G. F. RACKETT
W. H. CARSON	R. E. FARNHAM	W. B. RAYTON
L. W. DAVEE	H. GRIFFIN	V. B. SEASE
A. DEBRIE	R. C. HUBBARD	T. E. SHEA
L. DEFORREST	L. A. JONES	J. P. SPENCE
J. A. DUBRAY	N. M. LAPORTE	E. I. SPONABLE
E. W. ENGSTROM	G. MITCHELL	L. T. TROLAND
	W. P. POWERS	

Studio LightingA. C. DOWNES, *Chairman*

L. J. BUTTOLPH	R. E. FARNHAM	M. W. PALMER
	K. C. HICKMAN	

Theater LightingC. E. EGELER, *Chairman*

J. C. AALBERG
 F. A. BENFORD
 A. C. DOWNES

F. FALGE
 R. E. FARNHAM

C. GREENE
 E. HUSE
 L. A. JONES

LONDON SECTIONSIMON ROWSON, *Chairman*

A. NEWMAN, *Vice-Chairman*
 L. EVELEIGH, *Secretary*
 H. WOOD, *Treasurer*

PAUL KIMBERLEY, *Manager*
 ALAN WILLIAMSON, *Manager*
 WILLIAM VINTEN, *Manager*

NEW YORK SECTION

M. W. PALMER, *Chairman*
 D. F. HYNDMAN, *Sec.-Treas.*

M. C. BATSEL, *Manager*
 T. E. SHEA, *Manager*

PACIFIC COAST SECTION

P. MOLE, *Chairman*
 G. F. RACKETT, *Sec.-Treas.*

C. DUNNING, *Manager*
 E. HUSE, *Manager*

Membership Committee

J. COURCIER, *Chairman*
 E. JEWELL

Papers and Programs

E. HUSE, *Chairman*



W. V. D. KELLEY
Color



W. C. KUNZMANN
Convention



F. J. WILSTACH
Historical



L. A. JONES
Journal

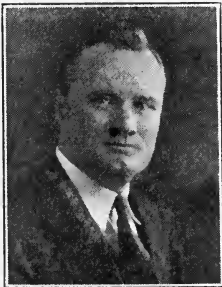

H. T. COWLING
Membership and
Subscription



J. W. COFFMAN
Papers



G. E. MATTHEWS
Progress



L. M. TOWNSEND
Projection



W. WHITMORE
Publicity



E. P. CURTIS
Solicitation

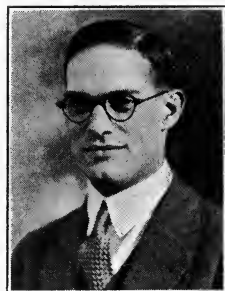

A. C. HARDY
Standards and
Nomenclature



A. C. DOWNES
Studio Lighting



C. E. EGELER
Theater Lighting

NEW MEMBERS

- LEROY O. ANDREWS
New England Theaters Operating
Corp., 19 Milk Street, Boston,
Mass.
- JUDD O. BAKER
RCA Photophone, Inc., 411 Fifth
Avenue, New York, N. Y.
- WILLIAM P. BIELICKE
5462 Marathon Street, Los Angeles,
Calif.
- GORDON A. CHAMBERS
Eastman Kodak Company, 6706
Santa Monica Blvd., Hollywood,
Calif.
- MERRITT CRAWFORD
Bell Telephone Laboratories, Inc.,
463 West Street, New York, N. Y.
- P. H. EVANS
Warners Bros. Vitaphone Corp., 1277
East 14th Street, Brooklyn, New
York
- WILMORE C. HARCUS
Paramount-Famous-Lasky-Corp.,
5451 Marathon Street, Hollywood,
Calif.
- ARTHUR HIGGINS
119 Darley Road, Randwick, Syd-
ney, Australia
- FREDERICK L. G. KOLLMORGEN
Kollmorgen Optical Corp., 767
Wythe Avenue, Brooklyn, New
York
- CHARLES L. LOOTENS
RCA Photophone, Inc., 411 Fifth
Avenue, New York, N. Y.
- DONALD MCNICOL
Projection Engineering, 52 Vander-
bilt Avenue, New York, N. Y.
- HERBERT MEYER
Agfa Ansco Corp., Binghamton,
N. Y.
- LLOYD P. MORRIS
606 West Elm Street, Urbana, Ill.
- JOHN P. MULLER
2629 Calhoun Street, New Orleans,
La.
- HANS M. NIETER
British Schufftan Process, Ltd.,
Elstree, Herts, England
- JOSEPH P. O'DONNELL
Cinema Studios Supply Corp., 1438
N. Beachwood Drive, Hollywood,
Calif.
- JAMES OLSON
National Theater Supply Co., 2310
Cass Avenue, Detroit, Mich.
- LOUIS I. PAGE
RKO Studios, 780 Gower Street,
Hollywood, Calif.
- EUGENE A. PFEIL
71 Root Building, Buffalo, New York
- A. SHAPIRO
Universal Stamping and Mfg. Co.,
2839 North Western Avenue,
Chicago, Ill.
- JOHN H. A. WHITEHOUSE
The Gramophone Co., Ltd., Ruislip,
Middlesex, England
- FRANK J. WILSTACH
Motion Picture Producers & Dis-
tributors of America, Inc., 469
Fifth Avenue, New York, N. Y.

CHANGE OF ADDRESS

- J. C. AALBERG
RKO Studios, 78 Gower Street,
Los Angeles, Calif.
- J. BURGI CONTNER
c/o President Hotel, West 48th
Street, New York, N. Y.

SOCIETY NOTES

The Spring Meeting.—Mr. W. C. Kunzmann, chairman of the Convention Committee, reports that arrangements for the Spring Meeting, which is to be held at the Wardman Park Hotel, Washington, D. C., May 5th to 8th, inclusive, are almost complete and a preliminary program will be circulated to the members very shortly.

The Acoustical Society.—The Acoustical Society will hold its convention on May 9th and 10th in the auditorium of the Westinghouse Lighting Institute in Grand Central Palace, New York, N. Y. The technical sessions will be devoted to symposiums on "noises" and loud speakers. This convention was previously scheduled for May 8th and 9th but President Fletcher made arrangements to delay the convention in order to permit our members to proceed from Washington to attend this convention.

The Secretaryship.—After almost two years of efficient and faithful service, Secretary R. S. Burnap has resigned. The Society hereby extends its appreciation and thanks to Mr. Burnap for his valuable services and expresses its deep regret that his associations with the Society have been severed.

The Society has been extremely fortunate, however, in that Mr. J. H. Kurlander of the Westinghouse Lamp Company has accepted the appointment of temporary secretary to conclude the fiscal year. Mr. Kurlander is well known to many of the older members of the Society and has been active in the motion picture field for many years.

Board of Governors Meeting.—At the Board of Governors meeting held on February 4th at Rochester, New York, a large number of business matters were transacted including the following.

1. *Resolved*, that papers presented at the regular meeting shall not be published or circulated and shall be considered the confidential property of the Society prior to their appearance in the JOURNAL, except that in case a paper is not published in the JOURNAL within six months after its presentation, the author is free to use it in whatever manner he sees fit.

2. The President was instructed to write to the Secretary of the Academy of Motion Picture Arts and Sciences expressing a desire and willingness on the part of the Society of Motion Picture Engineers to collaborate with them on technical matters and especially those dealing with standardization and the preparation of nomenclature lists.

3. Sections of the proposed revision of the By-Laws of the Society were modified further as follows:

BY-LAW 7, Section 3, was revised to read as follows: The annual dues

shall be \$20.00 for Active Members, and \$10.00 for Associate Members, payable on or before October 1st of each year. Current or first year's dues for new members dating from notification of acceptance into the Society shall be pro-rated on a quarterly basis, said quarters beginning October 1st, January 1st, April 1st, and July 1st. Ten dollars of these dues shall apply for annual subscription for the monthly publication.

The change in this section has been made necessary in order to obtain second class mailing privileges for the JOURNAL.

BY-LAW 10, Section 5, was revised to read as follows: The Board of Governors shall consist of a Section Chairman, the Section Past Chairman, the Section Secretary-Treasurer, and two Active Members, one of which last named shall be elected for a two-year term, and one for one year, and then one for two years each year thereafter. At the discretion of the Board of Governors, and with their written approval, this list of officers may be extended.

This revision was made necessary by the need in the case of large sections for a larger staff to carry on the work of the Section.

4. The chairman of the JOURNAL Committee was informed that the order of publication of papers in the JOURNAL is placed within the discretion of the editor. In case early and special publication is desired, papers will preferably be published in order of receipt of the complete manuscript for printing by the editorial office.

5. A petition was received, signed in proper form by ten Active Members of the Society in good standing, requesting authorization to organize a New York Section of the Society. A motion was made and passed that this petition be granted.

The New York Section.—An organization meeting was held on March 6th at the Engineering Societies Building, New York, N. Y. About 150 members were present. President Crabtree acted as temporary chairman and introduced the speaker, Dr. Walter Pitkin of the School of Journalism, Columbia University, New York, N. Y., who spoke on "The Psychology of the Sound Picture." He drew attention to the many shortcomings of the reproduced sounds in the theater, particularly with respect to noises. The election of officers resulted as follows: M. W. Palmer, *Chairman*; T. E. Shea (*Long Term*), M. C. Batsel (*Short Term*), *Managers*; D. E. Hyndman, *Secy.-Treas.*

The geographical boundaries of the New York Section have been defined by the Board of Governors as an area enclosed within a circle having a radius of 50 miles from Times Square. At this meeting, however, a motion was made that the Board of Governors reconsider this matter and recommend the boundaries as those of the Metropolitan area as defined by the authoritative body.

The Pacific Coast Section.—The second meeting of the season was held in the factory of the Mitchell Camera Company on February 27th. Mr. R. E. Farnham of the General Electric Company reviewed

the character of the emission of luminous bodies in general and of the tungsten filament in particular. He also demonstrated a tungsten spot lamp equipped with a heat absorbing water filter. This was followed by a general discussion on wide film problems together with a demonstration of the various parts of the Grandeur 70 mm. camera.

The London Section.—Our fellow members in London have been continuing their bi-weekly meetings with systematic regularity. Many of the papers read at the Toronto convention have been again presented at these sessions. The program for the remainder of the year is as follows:

March 10th at Mayfair Hotel First Annual Dinner

March 24th at R. P. S. "Lenses with Special Reference to Color Correction," by Mr. Warmisham.

April 14th at R. P. S. "Acoustics of Buildings," by Mr. Fleming of the National Physical Laboratory.

Sustaining Memberships.—To date, the following firms have agreed to take up sustaining memberships for the amounts indicated.

\$1000 Memberships

Bell Telephone Laboratories, Inc.
Eastman Kodak Company
Paramount-Famous-Lasky Corp.
RCA Photophone, Inc.

\$500 Memberships

Bell & Howell Company
Consolidated Film Industries
Du Pont-Pathé Film Mfg. Corp.
Technicolor Motion Picture Corp.

\$100 Memberships

Audio-Cinema, Inc.
Case Research Laboratory

As explained previously, sustaining memberships have been established in order to provide a fund of from \$9000 to \$10,000 annually for the purpose of acquiring a permanent editor-manager for the JOURNAL who will also act as assistant secretary-treasurer and also to enable the Society to establish permanent headquarters in the Engineering Societies Building, New York, N. Y. All members are urged to make every effort to persuade their firms to take up sustaining memberships in one of the classes indicated.

New Committees.—Two new committees have been appointed.

The *Historical Committee* under the chairmanship of Mr. F. J. Wilstach will undertake the collection of old films and motion picture

apparatus of historical interest and place these in a suitable depository, such as the National Museum at Washington, D. C. The committee is also preparing a report on the accomplishments of Messrs. Lauste and LeRoy in order to assist the Board of Governors in deciding upon a petition recently submitted to the effect that these men be granted honorary membership in the Society.

The *Color Committee* under the chairmanship of Mr. W. V. D. Kelley will undertake the compilation of reports on progress in color motion picture work.

The Wide Film Situation.—Professor A. C. Hardy, chairman of the Standards and Nomenclature Committee, has appointed a sub-committee under the chairmanship of Mr. M. C. Batsel of the RCA Photophone, Inc., which has under consideration the recommendation of dimensional standards for wide film. The sub-committee is composed as follows: L. W. Davee, L. DeForest, P. H. Evans, H. Griffin, N. M. LaPorte, J. L. Spence, E. I. Sponable.

The committee has met weekly during the past month and the prospects of their being in a position to make definite recommendations in time for the spring meeting are very promising.

The Committee Chairmen.—The following notes have been prepared with a view to better acquainting the members with the various committee chairmen whose photographs appear on pages 457 and 458.

W. V. D. Kelley (Color). President of the Du Chrome Color Corporation, Hollywood, California, and formerly Vice-President of Prisma, Inc., and Kelley-Color, Inc. Mr. Kelley was formerly a member of the Board of Governors and has contributed articles on color photography to the *Transactions*.

W. C. Kunzmann (Convention). Member of Sales Division of the National Carbon Company and a member of the Board of Governors. Mr. Kunzmann has been in charge of the arrangements for the Society's conventions for many years.

F. J. Wilstach (Historical). Chief of Publicity Department of the Motion Picture Producers and Distributors of America, Inc. Has been connected with theater activities for many years and was formerly press agent for Messrs. Schubert, and general manager for Sothern & Marlowe, and DeWolf Hopper.

L. A. Jones (Journal). Past-President of our Society and has held the chairmanship of the Papers, Publications, and Standards Committees. He is president of the Optical Society of America. Mr. Jones has contributed many scientific papers to our *Transactions* and those of other scientific societies.

H. T. Cowling (Membership and Subscription). Technical director of the Eastman Teaching Films, Inc., and a member of the Board of Governors. Mr. Cowling was previously engaged in the filming of travelogs.

J. W. Coffman (Papers). President of the Audio-Cinema, Inc., and formerly Vice-President of the Carpenter-Goldman Laboratories, Inc., engaged in the production of educational films.

G. E. Matthews (Progress). Member of the Kodak Research Laboratories and has assisted largely in the preparation of Progress Reports for the past two years.

L. M. Townsend (Projection). Member of Sound Division of the Paramount-Famous-Lasky Corporation and formerly supervisor of projection at the Eastman Theater, Rochester, N. Y. Mr. Townsend has been a frequent contributor to the *Transactions*.

W. Whitmore (Publicity). Member of Advertising and Publishing Departments of the Western Electric Company and formerly on the editorial staff of the *Exhibitors' Herald-World*.

E. P. Curtis (Solicitations). General Sales Manager of the Motion Picture Film Department, Eastman Kodak Company, Major of Air Corps, Reserve Section, and Ace of the World War.

A. C. Hardy (Standards and Nomenclature). Assistant Professor of Physics, Massachusetts Institute of Technology. A former staff member of the Kodak Research Laboratories and a contributor of many articles to the *Transactions* and JOURNAL.

A. C. Downes (Studio Lighting). A member of the Research Laboratory of the National Carbon Company, in charge of carbon electrode and lamp research. Mr. Downes has contributed many articles to the *Transactions*.

C. A. Egeler (Theater Lighting). Illuminating engineer of the National Lamp Works, Cleveland, Ohio. Mr. Egeler has served previously as chairman of the Progress Committee.

PACIFIC COAST SECTION, SOCIETY OF MOTION PICTURE ENGINEERS

MINUTES OF MEETING

February 27, 1930

The second meeting of this season, held in the new factory of the Mitchell Camera Corporation on Thursday, February 27, 1930, was called to order by Mr. Peter Mole, *Chairman* of The Pacific Coast Section, at 8:30 P.M.

In calling the meeting to order Mr. Mole outlined briefly the broad aims and policies of the Society, in which it was not only nationally but internationally functioning, and pointed out the program of activity and work undertaken by the Pacific Coast Section for the current year. The increasing importance to the motion picture industry, of reliable engineering with a background of scientific research was explained with its particular importance to the Hollywood center of production. The substantial growth of the Pacific Coast Section with its membership of approximately eighty and an attendance at this meeting of more than a hundred representative engineers and technicians was the occasion for requesting an informal

report from Mr. J. L. Courcier, *Chairman* of the local membership committee.

Mr. Courcier stated that it was not the policy of his committee to solicit membership or conduct a sales campaign but that all those qualified for membership were cordially invited to make application. Mr. Courcier brought out the fact that a widespread distribution of application forms was but a waste and expense to the Society and that applications would be given to those who indicated a desire for membership.

At the conclusion of Mr. Courcier's remarks, Chairman Mole handed the meeting over to Mr. Emery Huse, *Chairman* of the Papers and Programs Committee.

Mr. Huse explained that the schedule of the Society, which outlined color as the subject for the first three meetings, had been changed to permit this special meeting on the timely subject of *Wide Film*. The subject was particularly pertinent because of the opening on February 25th at the Circle Theater of the first production on Grandeur Film to be shown on the Pacific Coast.

Mr. Huse also announced that due to the presence of a representative of the General Electric Company they were to be given a review of the recent developments in means for cooling the beams of large wattage incandescent lamps. It was pointed out by Mr. Huse that one of the important functions of the Society was the contact it afforded between the industry and the many research organizations whose work so materially affected the progress of the motion picture industry. Mr. Huse introduced Mr. Ralph Farnham of the General Electric Company.

Mr. Farnham reviewed the character of the emission of luminous bodies in general and of the tungsten filament in particular. The various zones in which the energy was of photographic value or heat value were explained with curves and diagrams. From this Mr. Farnham discussed the various methods of screening out the heat zone and reviewed the materials best suited for this purpose. It was shown that a layer of distilled water in the path of the beam removed most of the heat. This was accompanied by a demonstration with two eighteen inch spot lamps equipped with five-thousand watt bulbs. One of the lamps was equipped with a water filter while one was open. Beams from the two lamps were projected on the audience. Mr. Farnham concluded his talk with a brief period of questions from the floor that elicited many interesting points of view.

Mr. Huse then made some brief comments on the feature subject of the evening, *Wide Film*, followed by statements of the manufacturing problems involved in producing wider film. These comments were followed by brief remarks from Mr. Rhody, covering some of the optical problems that had been raised by the use of wide film. Mr. Huse then introduced Mr. George Mitchell, Chief Engineer of the Mitchell Camera Corporation.

Mr. Mitchell had prepared an excellent group of exhibits of the various parts of the Grandeur camera together with completely assembled units. These he reviewed, pointing out the differences between these and the better known thirty-five millimeter cameras. His discussion was quite complete as well as interesting and was followed by an open forum of questions that elicited discussions from the floor on photography, projection, illumination, optics, picture proportion, *etc.*

At the conclusion of the open forum the speakers were thanked and the meeting was invited to inspect the plant which represents one of the most complete examples of modern engineering in the motion picture industry.

G. F. RACKETT, *Secretary*

REPORT OF THE SECRETARY*

This report summarizes briefly some of the items which will be of interest to the membership regarding the conduct of the office of Secretary for 1928 to 1929.

The past year has been a record year for the Society. It saw the formation of the London Section and witnessed a decided increase in our German and French membership, with a substantial growth of American membership. Our growth in membership is indicative of the increased new work carried on by the Society in every field. In order to meet these new conditions, the Board of Governors appointed early last year an Assistant to the Secretary and Treasurer, who was to cooperate with other officers and committee chairmen as much as possible. Miss Renwick took this position the first week in January and has done much to keep the work of the Secretary's office up to date. Since the Secretary's office is a clearing house for a great many of the Society's matters, there is necessarily considerable detail work required. No further mention will be made of this par-

* October 1, 1928, to October 1, 1929.

ticular phase of the work, but attention will now be given to items more pertinent to the membership.

MEMBERSHIP

Mr. Cowling, the very active Chairman of the Membership Committee, has added many new names to the Society rolls. The present roll of the Society is 611 members, which represents an increase of 313 new members for the year! The total enrollment is divided as follows: 5 Honorary members, 326 Active members, and 280 Associate members. Seven members have resigned from the Society during the past year, and 18 have been dropped from the rolls. Six Associate members have been transferred to Active membership. Twenty-five applications are now pending action. Of these, 11 await approval by the Board, and 14 are held up for entrance fee.

The Pacific Coast Section, which includes Los Angeles, Hollywood, San Francisco, and Washington, shows a total of 74 members. The London Section which was organized last year has increased during the year to 90 members, and is very active, holding meetings regularly once a month during the winter season.

The total Society membership as distributed over the United States or in foreign countries is as follows:

New York and East	303
Chicago and Mid-West	82
Pacific Coast	74
British Isles	90
Canada	15
France	14
Germany	15
India	6
Italy	3
Russia	2
Australia	2
Japan	2
Switzerland	1
Sweden	1
Holland	1
Total	611

TRANSACTIONS

One thousand, three hundred and thirty-one (1331) *Transactions* since October 1, 1928, have been mailed out by the Secretary. Over \$3000 has been received in payment for these *Transactions*.

Our *Transactions* went to many foreign countries; approximately one-fourth of the *Transactions* distributed from this office have gone to non-members in foreign countries.

PRINTING AND STATIONERY

In order to insure that stationery of uniform quality is used, and that printed matter is handled through a central source, practically all requirements along this line have been taken care of by the Secretary. On the whole, this scheme has worked out well. The Secretary has taken care of all printed matter circularized to the members during the past six months. In addition, the publication of the *Bulletin* was taken over for this six-months' period. Two issues, one in June and one in September, have been prepared and mailed to the membership.

Assistance has been given to other officers and committee chairmen in preparing mailing material and in the furnishing of addressed envelopes.

CONCLUSION

As a result of my year's experience as Secretary, it is evident to me that there are many opportunities for further centralization of the Society's activities and coördination of effort through the Secretary's office. However, in view of the fact that the publishing of a journal is under immediate consideration, it does not seem advisable to make recommendations at the present time. Undoubtedly much routine work now handled by the Secretary will be taken care of by the office conducting this JOURNAL. Details of coördination and centralization under these new conditions will require careful consideration and will have to be worked out by the manager conducting the JOURNAL.

Respectfully submitted,
R. S. BURNAP, *Secretary*

SPRING MEETING OF THE SOCIETY, WASHINGTON, D. C.

(May 5th to 8th, inclusive)

Arrangements for the Spring meeting of the Society to be held at the Wardman Park Hotel, Washington, D. C., have been announced by the Chairman of the Convention Committee, Mr. W. C. Kunzmann.

The Committee has the following tentative program under consideration.

Monday, May 5th

Convention Registration, 8:30 to 10:00 A.M.

Convention called to order, 10:00 A.M., Little Theater, Wardman Park Hotel

Address of Welcome

Response by President J. I. Crabtree

Report of the Convention Committee, W. C. Kunzmann

Report of the Secretary, J. H. Kurlander

Report of the Treasurer, William C. Hubbard

Committee Reports and Papers Presentation

12:30 to 1:30 P.M. Luncheon

2:00 P.M. Little Theater, Wardman Park Hotel

Presentation of Papers

Monday Evening, May 5th, 7:30 P. M.

Get together party, and exhibition of a selected film program

Tuesday, May 6th

8:30 to 9:30 A.M. Registration

9:30 A.M. Presentation of Papers, Little Theater, Wardman Park Hotel

12:30 to 1:30 P.M. Luncheon

2:00 P.M. Presentation of Papers, Little Theater, Wardman Park Hotel

Tuesday Evening

Entertainment under consideration

Wednesday, May 7th

9:30 A.M. Presentation of Papers, Little Theater, Wardman Park Hotel

12:30 to 1:30 P.M. Luncheon

2:00 P.M. Contemplated bus ride and sightseeing trip to Mt. Vernon, Va., and visit to the White House

Wednesday Evening, 7:00 P. M.

Semi-annual banquet in the Gold Room of the Wardman Park Hotel

Speakers for the evening to be announced later

Dancing and elaborate program of entertainment

Thursday, May 8th

9:30 A.M. Presentation of Papers, Little Theater, Wardman Park Hotel

12:30 to 1:30 P.M. Luncheon

2:00 P.M. Presentation of Papers, Little Theater, Wardman Park Hotel

Open Forum

Convention Committee report and discussion of place and plans for the Fall Convention

Adjournment

The following committees and individuals will officiate during the convention:

Reception Committee

W. C. HUBBARD	C. FRANCIS JENKINS	W. C. KUNZMANN
J. W. COFFMAN	H. T. COWLING	M. W. PALMER
N. D. GOLDEN	RAYMOND EVANS	C. J. NORTH
W. WHITMORE	LT.-COL. WALTER E. PROSSER	

Convention Registrars

W. C. KUNZMANN	C. RENWICK
K. C. D. HICKMANN	E. R. GEIB

Hostess to Convention

MRS. WALTER E. PROSSER, assisted by

MRS. C. FRANCIS JENKINS MRS. N. D. GOLDEN MRS. C. J. NORTH

Banquet Arrangements

W. C. HUBBARD

Banquet Master of Ceremonies

HON. CONGRESSMAN W. B. CONNERY, JR., 7th District, Massachusetts

Floor Show Entertainment

HARDIE MEAKIN, Washington Representative "Variety"

Supervision Projection Equipment

Installation and Operation

H. B. SANTEE	M. C. BATSEL	H. GRIFFIN
F. J. STORTY	PAUL R. HEYL	

Entertainment and Amusements

C. FRANCIS JENKINS

N. D. GOLDEN

NAT GLASSER

RAYMOND EVANS

K. C. D. HICKMANN

F. J. STORTY

LT.-COL. WALTER E. PROSSER

Press and Publicity

W. WHITMORE

G. E. MATTHEWS

F. C. BADGLEY

Transportation, Bulletins, and Reservations

P. A. MCGUIRE

N. D. GOLDEN

Convention Official Photographers

J. T. FLANAGAN

RAYMOND EVANS

Convention Announcements

MEMBERS RECEPTION COMMITTEE

**INFORMATION FOR AUTHORS CONCERNING
PUBLICATION IN THE JOURNAL****JOURNAL ADMINISTRATION**

Certain rules and regulations pertaining to the publication of the JOURNAL OF THE SOCIETY OF MOTION PICTURE ENGINEERS have been adopted. It is desirable that members of the Society and contributors to the convention programs and to the JOURNAL should be familiar with these regulations. We shall attempt therefore at this time to explain certain phases of the JOURNAL administration. It is hoped that all contributors will strive to cooperate with the editorial office to the end that the affairs of the JOURNAL shall run smoothly and that a publication of maximum usefulness and highest quality shall be created.

PRIOR RIGHT TO PUBLICATION OF CONVENTION PAPERS

There has been some uncertainty and misunderstanding in the past, relative to the Society's attitude toward the publication of papers which are read at our semi-annual conventions. At a recent meeting of the Board of Governors a definite action designed to clarify this was taken. The motion passed at that time is as follows: "Papers presented at regular meetings shall not be published or circulated, and shall be considered as the confidential property of the Society, prior to their appearance in the JOURNAL, except that in case

such paper is not published in the JOURNAL within six months after its presentation, the author is free to use it in whatever manner he sees fit." This action definitely establishes the prior claim of the Society to any paper which a contributor may present at the Society's semi-annual meetings. This position which has been adopted by the Society of Motion Picture Engineers is the same as that taken by many other similar technical organizations. It seems only reasonable that, if the Society grants the privilege of the floor to any contributor for the presentation of a paper on the program of its meeting, it is only fair that the Society shall have a prior right to the publication of that material. It is recognized, of course, that in asking this privilege the Society should assure the contributor reasonably prompt publication. While we were publishing our convention programs in the form of transactions it was not possible to assure prompt publication, but now that the JOURNAL is operating successfully we should have little difficulty in meeting reasonable demands of contributors for promptness of publication.

ORDER OF PUBLICATION

The material presented at one of our semi-annual conventions is obviously much more voluminous than can be published in one of the monthly issues of the JOURNAL. In fact, the material from one convention, assuming an average number of papers, should be adequate to fill at least four monthly issues. We are faced, therefore, with the problem of order of publication and it is obvious that some papers will appear at a materially earlier date than others. A consideration of the general types of papers which are read at conventions indicates that there are some which should be published very promptly, while others may reasonably be held up for two or three months without any serious depreciation in value. Of the latter type are those which may be referred to as tutorial and those which aim to summarize the status of some particular phase of technology. Papers dealing with new developments and things of vital interest, of course, should be published as promptly as possible. Authors desiring immediate publication should notify the editor of the JOURNAL to this effect. Such requests will be given every possible consideration. It is possible, of course, that the attempt to take care of this order of publication by granting requests of authors may lead the editorial office into difficulty. For instance, all authors may request prompt publication. Obviously under such conditions some mechanism

must be adopted for determining the order in which papers presented at our semi-annual conventions shall be published. The authority to decide upon order of publication must, of course, reside in some particular individual or committee. At the recent meeting of the Board of Governors the following instructions were given to the editor of the JOURNAL: "The order of publication of papers in the JOURNAL is placed within the discretion of the editor. In case special and early publication is desired, papers will preferably be published in the order of receipt by the editorial office, of a complete manuscript for printing."

In view of these instructions from the Board of Governors, the editorial office proposes to determine in general the order in which papers are published by the chronological order in which manuscripts are received at the editorial office. We wish to emphasize that any author desiring early publication of his article should submit a manuscript complete with all drawings, diagrams, *etc.*, at the earliest possible moment. Upon receipt at the editorial office these will be date stamped. The course which an author should follow in order to obtain early publication is therefore clearly defined and we feel that little dissatisfaction can possibly result from delay in the publication of papers depending for their greatest value upon immediate publication. This regulation, it is hoped, will stimulate contributors to exercise the utmost care in the preparation of manuscripts which are submitted, and the editorial office will consider that the necessity of returning a manuscript to the author for revision or correction or the provision of more satisfactory drawings will be sufficient reason to invalidate his precedence date and the date which will be effective in determining the order of publication will be that upon which the corrected manuscript is received again at the editorial office.

In dealing with those papers for which no particular request for promptness is made the editor will use his best judgment in arranging them so as to give JOURNAL issues of maximum interest to a maximum number of readers. The present editorial management does not feel particularly disposed to allotting some particular JOURNAL to a definite group of papers dealing with a specific subject. We feel that in general this does not serve to keep alive the interest of the maximum number of readers in all of the JOURNAL issues. In our opinion a JOURNAL carrying papers of a diversified type, all, of course, bearing on the motion picture industry, is more desirable.

DATE OF RECEIPT OF MATERIAL RELATIVE TO THE PUBLICATION DATE

Material for the technical section of the JOURNAL must be in the hands of the editor not later than the 20th of the second month preceding the date of issue. This deadline date applies also to any other material for which the author desires to see galley proof. For example, any material of a technical nature which is to appear in the July issue of the JOURNAL must be mailed early enough to be received by the editor by the 20th of May.

Abstracts, reviews, and material of a strictly news nature must be received by the editor not later than the 7th of the month preceding the date of issue. No proof will be submitted to authors for material of this class. For example, all material in this class to be included in the July issue must be received by the editor by the 7th of June.

STANDARDIZATION OF USAGE FOR THE JOURNAL

It seems desirable to establish a style as to typography, form, and spelling which will be consistent from issue to issue. The vocabulary and forms of expression of the motion picture engineer are specialized to such an extent that there is no inclusive published compendium of terms to which one can refer. We believe one of the services which the JOURNAL can render to the industry is in the standardization of verbal usage.

Authors of papers can assist the editorial office to a great extent by conforming to the suggestions which follow. We wish it understood, however, that this office will welcome criticism of any of the items presented. We shall be glad to have brought to our attention additional matters of verbal usage which seem to demand standardization through the pages of the JOURNAL.

MECHANICAL FORM OF THE MANUSCRIPT

Text.—Papers should always be typewritten on only one side of the paper. It is desirable to send for publication the original (ribbon copy)—a carbon copy is easily erased and may become illegible. Double spacing should be used so as to provide space for interlined editorial correction.

Illustrations.—Each drawing or photograph should occupy a separate sheet and must be of a type which will reproduce well. Blueprints, photostats, or sepia prints cannot be accepted. Tracings or line drawings should be made with black india ink on white paper or tracing cloth. Closely spaced coördinate lines on curves should be avoided.

The minimum amount of reading matter should be included on the illustrations. Necessary information can better be set in type in a caption accompanying the illustration.

The maximum width of a JOURNAL cut is 4 inches and the maximum length is $6\frac{1}{4}$ inches. It is important to make sure that the necessary reduction in magnification of an illustration will not make the height of letters contained in reading matter on the illustration less than $\frac{1}{32}$ inch.

Listing of Captions.—Captions for all figures and tables should be listed on separate sheets accompanying the manuscript.

Address.—It is important that the author's mailing address shall be written on the first page of the manuscript. His business affiliation should also be mentioned. The editorial office should be kept informed of changes in the author's address in order that proof may reach him promptly.

PRINTING STYLE (HEADINGS)

Although the general make-up of the JOURNAL is still in the state of evolution, certain points of typographic style are rather definitely established. In the setting of this style, it was attempted to provide a flexible form. It is suggested that the author make extensive use of the possibilities of this established form.

It undoubtedly increases the value and clarity of a paper for it to be definitely divided into sections. It would assist the editorial office for the author to specify which type of heading or subheading is desired in each instance. The headings conforming to JOURNAL style, in descending order of importance are as follows:

CENTERHEAD

Italic Centerhead

Italic Sidehead.—These sideheads are run in to the text of the paragraph.

BIBLIOGRAPHY AND FOOTNOTES

References to literature should be accurate and complete. A mere listing of titles uncritically made is worse than no bibliography at all. For the author to save himself a few minutes by omitting any item of the reference appears almost criminal when one considers the total amount of time needlessly wasted by the many readers.

References to periodical literature should contain the following items in the given order:

1. The reference number which corresponds to the number in the text,

2. The author of the paper correctly spelled and with initials.
3. The name of the article enclosed in quotation marks.
4. The name of the periodical (unless the periodical is a common one its title should not be abbreviated).
5. The volume number.
6. The date—month and year enclosed in parentheses.
7. The serial number preceded by the abbreviation "No."
8. The page number preceded by the letter "p."

Example. ¹ McCoy, J. L.: "A Light Intensity Meter." *J. Soc. Mot. Pict. Eng.*, XIV (March, 1930), No. 3, p. 357.

References to books should be made as follows:

1. Author's name.
2. Name of book enclosed in quotation marks.
3. Edition.
4. Publisher.
5. Place of publication.
6. Date of publication enclosed in parentheses.
7. Page preceded by letter "p."

Example. FRANKLIN, H. B.: "Sound Motion Pictures." 1st ed. *Doubleday, Doran & Co.*, Garden City, L. I., N. Y. (1929), p. 101.

SPELLING

Usages and preferred spelling forms as given in the *Standard Dictionary* will be followed in general. The appended list of spelling forms contains some exceptions which have been tentatively adopted as JOURNAL style.

It is very desirable that authors follow these forms of spelling and usage in the drawing of figures.

all-sound	diaphragm
all-talking	disk
aluminum	<i>etc.</i>
astrogamma	<i>f</i> /1.9 (referring to aperture)
abscissas (not <i>æ</i>)	formulas (not <i>æ</i>)
"B" battery	fade-in
back-focus	fade-out
cut-back (noun)	feedback
cut-in (noun)	indexes (not indices)
change-over	infra-red
close-up	mediums (not <i>a</i>)

microns (not a)	technic
pickup	time-lapse
pull-down (noun)	through
photo-electric	though
photo-cell	theater
play-backs (noun)	two-color
sound-on-disk (adjective)	three-color
sound-on-film (adjective)	ultra-violet
sound-proof	ultra-speed
sulfur	X-ray
super-speed	

ABBREVIATIONS

alternating current	a.c.
ampere	amp.
British thermal unit	Btu.
candle power	cp.
centimeter	cm.
centigrade	C.
cosine	cos
cubic centimeter	cc.
decibel	db.
diameter	spell out
direct current	d.c.
electromotive force	emf.
Fahrenheit	F.
feet	ft.
gram	spell out
inch or inches	in.
kilocycles	spell out
kilowatts	kw.
Kelvin	K.
lambert	L.
lumen	l.
lumens per watt	lpw.
megohm	spell out
meter	m.
millimeter	mm.
microfarad	μ f.
millivolt	mv.
ounce	oz.

per	write out
revolutions per minute	rpm.
secant	sec
second	sec.
sine	sin
square root of mean square	rms.
tangent	tan
watts per candle	wpc.

MISCELLANEOUS ITEMS CONCERNING JOURNAL STYLE

Papers should preferably be written from the impersonal point of view. For example, it is preferable to write:

“The amplitude is varied by the use of the potentiometer—” rather than “you vary the amplitude—” or “I vary the amplitude—.”

The indefinite use of “we” except in papers by joint authors should be avoided.

Long introductions not dealing specifically with the subject of the paper should be avoided.

Capitalize significant parts in the names of a manufactured product, i. e., Ivory soap.

Verify the spelling of all proper nouns.

In using numbers, spell out the following:

1. Numbers at the beginning of a sentence.
2. Numbers indicating length of time (i. e., for thirty minutes).
3. Ordinal numbers (i. e., eighth foot, tenth day).
4. Common fractions (three-fourths, half, etc.) if easily expressed in words.
5. Numbers in reading matter of less than three digits.

Use figures for:

1. Numbers of three or more digits except at the beginning of a sentence.
2. Temperatures, weights, lengths, areas, capacities, percentages, ratios, *etc.*
3. Dates either in ordinal or cardinal style (i. e., July 15, 1920) or (on the 15th of July).
4. Cardinal numbers indicating serial position (i. e., page 321, Fig. 5, *etc.*).
5. Sums of money.

Membership

in the

Society of Motion Picture Engineers

is open to all who are engaged in any branch of the motion picture industry or allied work. The society is international in character and its convention papers with complete discussions are furnished free to members.

REASONS WHY

YOU

SHOULD JOIN

The Society of Motion Picture Engineers

- 1—The S. M. P. E. is an internationally recognized organization of Motion Picture Engineers.
- 2—The S. M. P. E. is becoming an ever more important factor in developing, stabilizing, and standardizing the motion picture industry.
- 3—At two conventions each year reliable data concerning a wide range of subjects are presented long before they become available elsewhere.
- 4—Papers read at conventions are printed with full discussions in a monthly Journal and distributed free to all members.
- 5—The S. M. P. E. affords unique opportunities for personal contact with leaders in the industry.
- 6—S. M. P. E. publications are recognized standard authority on Motion Picture Engineering.
- 7—The S. M. P. E. will help you in many ways. Join now.

COUPON

HERFORD TYNES COWLING, *Chairman*
Membership Committee, Society of Motion Picture Engineers
343 State Street, Rochester, N. Y.

Dear Sir—

Please mail application blank and requirements for membership in the S. M. P. E. to—

Name.....
(Please print)

Position.....
(Company or other Affiliation)

Street and City Address.....

Name.....

Position.....

Street and City Address.....

JOURNAL

OF THE SOCIETY OF

MOTION PICTURE ENGINEERS

LOYD A. JONES, EDITOR *pro tem.*

Volume XIV

MAY, 1930

Number 5

CONTENTS

	Page
Some Properties of Chrome Alum Stop Baths and Fixing Baths (Part I).....J. I. CRABTREE AND H. D. RUSSELL	483
Sound Films for Surgical Instruction.....P. E. TRUESDALE	513
Some Aspects of a Western Electric Sound Recording System. S. S. A. WATKINS AND C. H. FETTER	520
Measuring the Effective Illumination of Photographic Objec- tives.....J. HRDLICKA	531
Camera Mechanism, Ancient and Modern..... ARTHUR S. NEWMAN	534
Standards Adopted by the Society of Motion Picture Engineers	545
Abstracts.....	567
Book Reviews.....	571
Officers.....	572
Committees.....	573
Annual Report of the Treasurer.....	578
London Section.....	579
New York Section.....	580
News Note from the National Society for the Prevention of Blindness.....	581
Society Notes.....	582
List of Membership.....	585

JOURNAL OF THE SOCIETY OF MOTION PICTURE ENGINEERS

LOYD A. JONES, EDITOR *pro tem.*

Associate Editors

G. L. CHANIER
O. M. GLUNT
A. C. HARDY

P. MOLE
W. B. RAYTON
P. E. SABINE

S. E. SHEPPARD
J. L. SPENCE
L. T. TROLAND

Publication Office, 20th & Northampton Sts., Easton, Pa.
Editorial Office, 343 State St., Rochester, N. Y.

Published Monthly

Copyrighted, 1930, by the Society of Motion Picture Engineers

Subscription to non-members \$12.00 per year; single copies \$1.50. Order from the Secretary of the Society of Motion Picture Engineers, 20th and Northampton Sts., Easton, Pa., or 2 Clearfield Ave., Bloomfield, N. J.

Papers or abstracts may be reprinted if credit is given to the Journal of the Society of Motion Picture Engineers.

The Society is not responsible for statements made by authors.

Application pending for second-class entry at the Post Office at Easton, Pa.

SOME PROPERTIES OF CHROME ALUM STOP BATHS AND FIXING BATHS (PART I)*

J. I. CRABTREE AND H. D. RUSSELL

INTRODUCTION

In a previous paper, the results of an extended investigation of the properties of fixing baths compounded with potassium alum were given.¹ In the present paper, the results of a similar study of stop baths and fixing baths containing chrome alum will be outlined.

Chrome alum or chromium potassium sulfate, $K_2SO_4 \cdot Cr_2(SO_4)_3 \cdot 24H_2O$, was one of the first hardening agents used for tanning gelatin and was referred to in practically all of the early literature on the insolubilization of gelatin solutions by inorganic hardening agents. Little or no reference was made to aluminum alum until the time of Lainer² whose investigations made possible the addition of acids to a solution of hypo without the precipitation of sulfur by utilizing the protective action of alkaline sulfites. The first hardening baths contained chrome alum together with sodium bisulfite and hypo, while later Namias³ used sodium acetate as an anti-sulfur protective in place of the sodium bisulfite. Chrome alum in acid-sodium sulfite-hypo fixing baths does not readily precipitate a sludge on the addition of developer as is the case with a similar combination with aluminum alum in the absence of suitable revival with acid and this is undoubtedly the reason why aluminum alum was not more generally used by the early workers. At the present time, chrome alum baths are less extensively used than potassium alum baths for normal temperature processing of motion picture film for the following reasons:

(a) Chrome alum fixing baths tend to lose their hardening properties whether or not they are used, especially when stored at high temperatures.

(b) The sludge which tends to form on the addition of an excess of developer to most chrome alum hardening baths is very difficult to remove from the film when it is precipitated thereon.

(c) At high temperatures chrome alum baths have a tendency to stain the

* Communication No. 432 from the Kodak Research Laboratories.

gelatin film green, but at normal temperatures no staining occurs unless the bath contains a high concentration of alum.

On the other hand, chrome alum baths possess the following advantages:

(a) Under suitable conditions, chrome alum has the property of rendering gelatin insoluble in boiling water while in all of the cases investigated in which aluminum alum was the hardening agent, it was impossible to obtain a gelatin film which would not melt at 212°F. with prolonged treatment. Chrome alum baths are therefore particularly suitable for processing at high temperatures.

(b) Chrome alum is more efficient with regard to the quantity of alum required to produce a given degree of hardening. Lumière and Seyewetz⁴ found that 0.5 per cent of chrome alum in a 15 per cent solution of hypo produced the same degree of hardening as 1.5 per cent of aluminum alum in a similar solution.

In order to determine more precisely the relative merits of chrome alum as compared with aluminum alum as a hardening agent for use with motion picture film, an extended investigation of the properties of chrome alum stop bath and fixing bath formulas seemed justified.

PART I—CHROME ALUM STOP BATHS

The Function of a Stop Bath.—During the development of photographic emulsions the gelatin is rendered alkaline by the carbonate or alkali in the developer. Part of this alkali may be removed from the film by rinsing in water between development and fixation but the gelatin still contains an appreciable quantity of alkali when the film is placed in the fixing bath, depending on the duration of the rinse. As previously shown,¹ an excess of alkali destroys the hardening properties of a potassium alum fixing bath and tends to cause the formation of a precipitate of aluminum sulfite, thus rendering the bath unsatisfactory for further use. It is possible to prevent entirely the carrying over of alkali into the fixing bath by immersing the film in an acid solution termed a "short stop" or "acid stop" bath after developing and before fixing. If the stop bath contains hardening ingredients it is then possible to dispense with a hardening fixing bath and use a plain acid hypo solution for fixing purposes.

Stop baths are very necessary with certain types of motion picture film processing machines where the film is exposed to the air for several seconds in passing from the developer to the fixing bath. The stop bath not only arrests development immediately and prevents the possible formation of aerial fog and developer stain but likewise prevents sludging of the fixing bath.

When considering the advisability of using an acid hardening stop bath, the efficiency of the processing must be considered in terms of the total time required to develop, harden, and fix a given film, that is, in the case of a hardening fixing bath, the film is hardened and fixed simultaneously, while in the case of a hardening stop bath used in conjunction with a non-hardening fixing bath, hardening and fixing are independent. It is therefore evident that the use of a hardening stop bath increases the time required for processing a given film and for this reason the hardening fixing bath is most desirable under normal conditions because of the time saved.

Desirable Properties of Stop Baths.—(a) The bath must be distinctly acid and to be efficient should remain acid during the life of the fixing bath. Although the stop bath should be sufficiently acid to insure long life, when the film leaves the bath it is more or less acid and will therefore increase the free acid content of the fixing bath which in turn will increase the tendency of the latter to sulfurize. The choice of acids therefore depends on the propensity of the acid to precipitate sulfur in a hypo solution.

(b) A stop bath should not be sufficiently acid to cause blisters, and the limit of acidity in this case is much less than in the case of a fixing bath because the alkalinity of the film is much greater when removed from the developer than after a slight rinse and previous to immersion in the fixing bath.

(c) A hardening stop bath should have properties similar to those of a plain acid stop bath and in addition should produce satisfactory hardening throughout its life. Since the hardening produced by alum mixtures varies with the quantity of developer or alkali added, it is apparent that an acid hardening stop bath will not produce uniform hardening except for a limited time unless it is suitably revived.

Choice of Acids and Hardening Agents for Use in Stop Baths.—Since the acid contained in the stop bath is carried into the fixing bath, it is important that the acid should have properties similar to those of the acid used in the fixing bath, that is, it should have the least possible tendency to precipitate sulfur with hypo and should not produce blisters readily. Solid organic acids, such as citric, tartaric, malic, and maleic, are not suitable because they decrease the hardening properties of a fixing bath by virtue of the formation of non-hardening complexes. At the present time, acetic

acid appears to be the most suitable available acid for non-hardening baths because it does not materially affect the hardening properties of a potassium alum fixing bath and has a minimum tendency to precipitate sulfur therein. Of the common acid salts which can be used for this purpose, sodium bisulfite is perhaps the most suitable since it does not impair the properties of the fixing bath and, so far as is known, will not blister the film under normal conditions.

Of the available hardening agents for use in acid hardening stop baths, chrome alum was considered the most promising because it is capable of producing a greater degree of hardening than potassium alum and is therefore suitable for use at high temperatures, under which conditions the use of a hardening stop bath is usually desirable. Both acetic and sulfuric acids were tested to determine their suitability for use in acid hardening baths.

Hardening Action of Chrome Alum Solutions.—In the preliminary experiments, the hardening action of chrome alum solutions on both neutral and alkaline film was investigated. The most alkaline film met with in actual practice was that placed directly from the developer into the stop bath without rinsing. The neutral film was rinsed for fifteen minutes after development and before placing in the chrome alum bath, which rendered it less alkaline than any met with in actual practice. In making the hardening tests, strips of motion picture positive film were developed for five minutes in D-16* at 70°F., rinsed for fifteen minutes (neutral film) and then agitated in the chrome alum bath every thirty seconds for three minutes. For the alkaline film tests the rinse was omitted. On leaving the bath, the film was again rinsed for fifteen minutes, fixed in a plain 30 per cent hypo solution for five minutes, washed for twenty minutes, and the hardening determined as in the case of fixing baths.¹ The acidity of the solution was determined in the following manner:

* *Formula D-16*

	<i>Metric</i>	<i>Avoirdupois</i>
Elon	0.3 gram	2 ounces
Sodium sulfite (desiccated)	40.0 grams	16 $\frac{1}{2}$ pounds
Hydroquinone	6.0 grams	2 $\frac{1}{2}$ pounds
Sodium carbonate (desiccated)	19.0 grams	7 $\frac{3}{4}$ pounds
Potassium bromide	0.9 gram	5 $\frac{3}{4}$ ounces
Citric acid	0.7 gram	4 $\frac{1}{2}$ ounces
Potassium metabisulfite	1.5 grams	10 ounces
Water to make	1 liter	50 gallons

Average time of development: 5 to 10 minutes at 65°F. (18°C.).

Acidity Measurements.—The acidic properties of an acid solution are attributable to the presence of free hydrogen ions. In a strongly acid solution there are many more of these ions than in a weakly acid solution so that the hydrogen ion concentration may be considered as a measure of the acidity of the solution. Acidity is usually expressed by the symbol "pH" which is equal to the logarithm of the reciprocal of the hydrogen ion concentration or $\text{pH} = \log \frac{1}{\text{H ion conc.}}$. An alkaline solution has therefore a relatively high pH value as compared with an acid solution.

In the present investigation, the pH or the acidity of the various chrome alum solutions was determined by the colorimetric method which depends upon the fact that the color or light absorbing properties of solutions of certain organic compounds (indicators) vary with their degree of acidity or alkalinity (hydrogen ion concentration). For instance, methyl orange is yellow at pH values lower than 4 but the dye changes color to orange at a pH of 4.0. The indicator, brom phenol blue, is yellow at a pH of 3.0 and purple at 4.6. At intermediate pH values the dye has definite intermediate shades. Therefore, by comparing the color of any solution with a set of standards having known pH values, the pH value of the test solution is obtained.

The indicator solution used in the present investigation was made by dissolving 0.4 gram of brom phenol blue in 75 cc. of a 0.05 per cent solution of potassium hydroxide and adding enough water to make one liter of solution.

Preliminary pH measurements were made with plain 2 per cent chrome alum solutions containing increasing quantities of developer.

TABLE I. *Effect of Acidity on Color of Indicator*

Nature of Solution	Color	pH
2% Chrome alum	Reddish yellow	3.2
2% Chrome alum + 4% D-16	Bluish red	4.0*
2% Chrome alum + 7% D-16	Purple	4.6*

Two cc. of each solution were added to 5 cc. of distilled water containing 10 drops of the indicator solution. These solutions were placed in test tubes of equal diameter and then arranged in a single line in a rack before an illuminator containing a tungsten bulb

screened to the color of noonday sun with a No. 79 Wratten filter. A comparison between the color of each solution gave a relative measure of the acidity of the solutions. The color change observed with brom phenol blue under these conditions is indicated in Table I.

The pH values bearing asterisks were checked with other indicators such as methyl orange (pH range 2.9–4.0), methyl red (pH range 4.2–6.4), and brom cresol purple (pH range 5.2–6.8). The pH values between these points were estimated by judgment.

This colorimetric method gives relative pH values which are sufficiently accurate for practical purposes. Electrometric methods were not used because they did not give satisfactory results in the presence of sodium sulfite.

Effect of Acidity on the Hardening Action of Chrome Alum Solutions.—Using the above procedure, the effect of concentration and the acidity on the hardening properties of plain chrome alum stop baths was determined. The results are indicated in Fig. 1 from which it is seen (curve *A*) that for neutral film the hardening increases to a maximum at a concentration of 0.2 per cent and then decreases rapidly as the concentration of chrome alum increases. For alkaline film the hardening does not reach a maximum until a concentration of 0.4 per cent is reached and then it remains at a maximum throughout the range of concentrations tested. In view of the fact that melting points above 212°F. were not determined, it cannot truthfully be said that the hardening reaches a maximum if the film does not melt at 212°F. For the purpose of this investigation, however, it was considered unnecessary to make melting points in water under pressure.

The acidity of the solutions indicated in curve *B* by pH values was measured in the manner outlined above. Curve *B* shows that for maximum hardening the acidity of the bath for neutral film should be about a pH of 4.0 and that for alkaline film between 3.8 and 3.0. The degree of hardening observed in curve *C* was obtained after the acidity of the baths had been so adjusted by adding either sulfuric acid or caustic soda. For neutral film the pH was 4.0 and for alkaline film, 3.2. It is seen that when the acidity is adjusted to these values, the hardening properties of the baths are constant, irrespective of the concentration of the chrome alum. The inaccuracy of judging the acidity of the solutions with pH indicators and the extreme change in hardening properties resulting from slight changes in the acidity of the solutions accounts for the

slight variations in the hardening properties of these adjusted solutions.

A comparison of curves *A* and *C* (Fig. 1) indicates that the hardening effect of a plain chrome alum solution depends largely upon its acidity and for a constant acidity is independent of the concentration. A. and L. Lumière and Seyewetz,⁴ Namias,⁵ and a large number of workers on the chrome tanning of leather have also observed this fact.

The difference between the hardening of neutral and alkaline

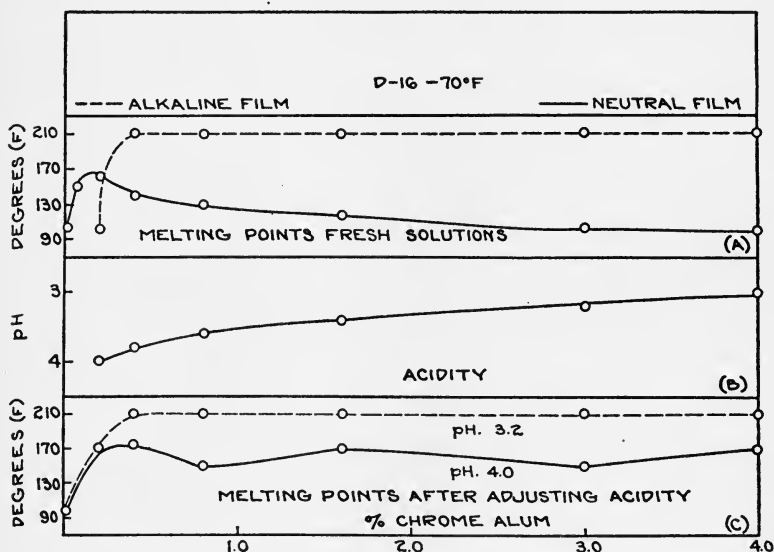

FIG. 1. Effect of concentration of a chrome alum solution on its hardening properties.

film produced by a chrome alum stop bath may be readily explained from a consideration of the effect of the addition of developer on the hardening properties of an alum solution as discussed in a previous paper.¹ It was shown that an excess of acid decreased the hardening properties of a fixing bath while the addition of developer to a fixing bath containing an excess of acid increased the hardening properties to a maximum and with the addition of an excess quantity of developer the hardening was destroyed.

In a 1 per cent chrome alum stop bath, for example, which contains no sodium sulfite or other acid buffering material we have a

similar case in which the acid content is distinctly above the normal limits permissible for satisfactory hardening of neutral gelatin. If a developed film containing appreciable quantities of developer is plunged immediately into the stop bath, the above conditions are reproduced *in situ* within the film and the solution immediately adjacent to it, that is, the developer locally neutralizes the excess acidity of the stop bath so that the chrome alum is then rendered capable of hardening the gelatin. In other words, the alkali held in the gelatin and on the surface of the film creates a local condition

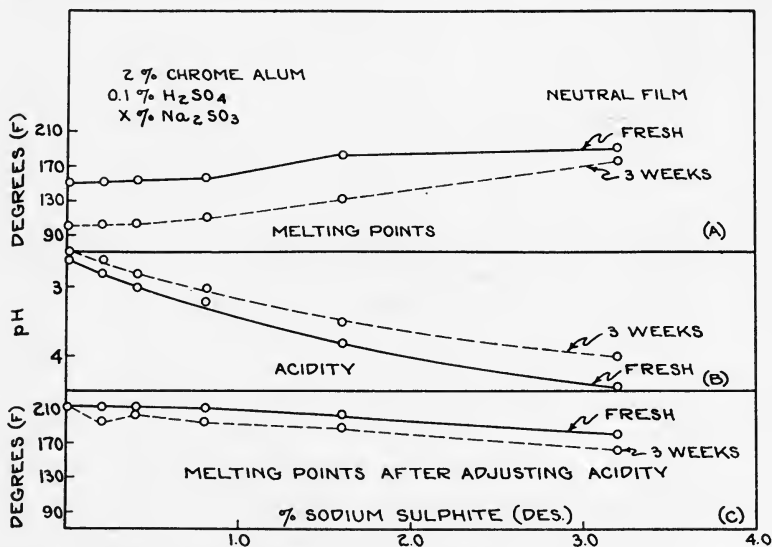

FIG. 2. Effect of the addition of sodium sulfite on the hardening properties of a 2 per cent chrome alum stop bath containing 1 cc. of sulfuric acid per liter.

in the stop bath as represented by the addition of a sufficient quantity of developer to the stop bath to produce maximum hardening as in the case of adding developer to a hardening fixing bath. Once the film is hardened and the alkali is neutralized by the acid, the excess free acid in the stop bath does not destroy the hardening already produced, because the acid content is relatively low and the chrome alum hardening is not readily affected by weakly acid solutions.

Effect of the Addition of Sodium Sulfite on the Hardening Properties of a Chrome Alum Stop Bath.—The effect of varying the concentration of sodium sulfite on the hardening properties of a stop bath con-

taining 0.1 per cent sulfuric acid and 2 per cent chrome alum was determined, using the same procedure as above for neutral film.

From Fig. 2 it is seen that as the concentration of sodium sulfite increases, the acidity decreases and the hardening effect increases. On standing for three weeks, a decrease in hardening occurred due to an increase in acidity of the solution. From curves *A* and *B* it is seen that maximum hardening is obtained when the solution has a pH of 4.0 on ageing. Curve *C* was obtained by adjusting the acidity of the solutions to a pH of 4.0 each time before measuring the hardening. The results indicate that the hardening action is largely dependent upon the acidity or pH value of the solution.

It was also noticed that on the addition of sodium sulfite to the chrome alum solution the original violet color changed to a deep green by transmitted light and it was considered that this color change was correlated in some way to the decrease in the hardening properties of the bath which resulted. From extensive tests, however, it was concluded that the hardening properties were determined largely by the degree of acidity or pH of the solution. This matter will be discussed more fully in Part II of this paper.

Effect of Addition of MQ-25 Developer on the Hardening Properties of Chrome Alum Stop Baths.—To test further the factors favoring the hardening action of chrome alum solutions, increasing quantities of MQ-25 developer* were added to several stop bath formulas and the hardening properties tested in the same manner as above with neutral and alkaline film over a period of several days.

In the case of a plain 2 per cent chrome alum stop bath (Fig. 3) the hardening properties with alkaline film and the acidity of the solution decreased as the quantity of developer added increased. A minimum degree of hardening was obtained with neutral film in the plain solution but the hardening increased on the addition of a small quantity of developer and then decreased as the proportion

*MQ-25 Developer

	<i>Metric</i>	<i>Avoirdupois</i>
Elon	1.25 grams	18 grains
Sodium sulfite (desiccated)	75.0 grams	2 ¹ / ₂ ounces
Hydroquinone	3.75 grams	54 grains
Sodium carbonate (desiccated)	25.0 grams	365 grains
Potassium bromide	1.5 grams	22 grains
Water to make	1.0 liter	32 ounces

of developer increased. After the acidity was adjusted to a pH of 3.2 for alkaline film and 4.0 for neutral film, the hardening properties were satisfactory. Age had little effect on the hardening proper-

2% CHROME ALUM
X 7% MQ. 25

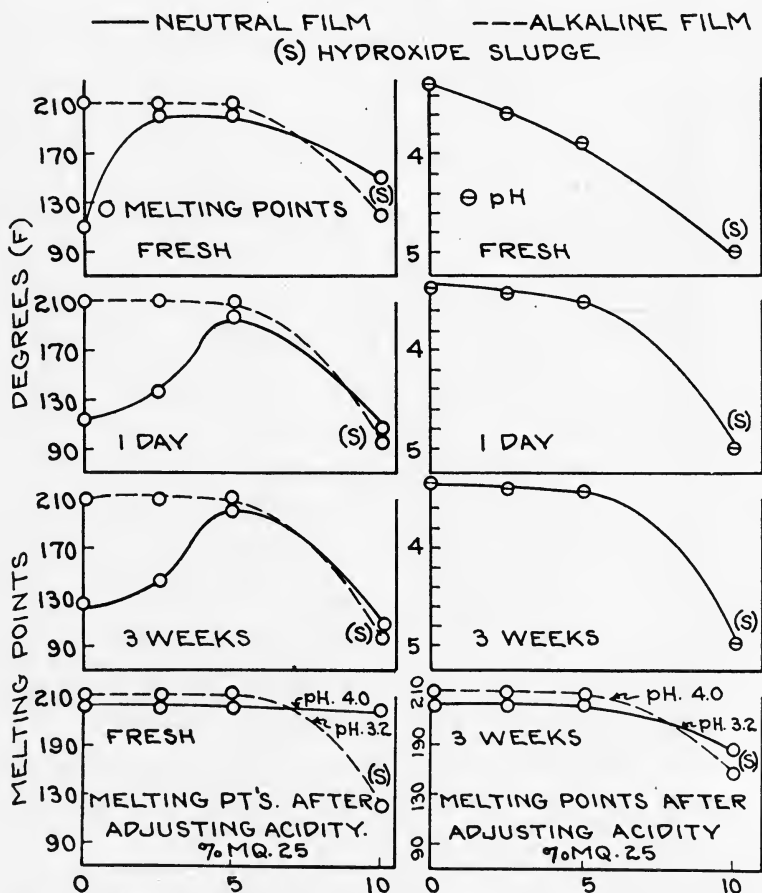

FIG. 3. Effect of the addition of MQ-25 developer on the hardening properties of a plain 2 per cent chrome alum stop bath.

ties of the solution in relation to alkaline film. The increase in acidity on ageing of the solutions containing a small percentage of developer accounts for the decrease in the hardening properties of the solutions with neutral film.

Effect of Addition of Acids to Hardening Stop Baths.—It was considered that it might be possible to prolong the life of a plain 2 per

2.0% CHROME ALUM
0.5% ACETIC ACID
X % MQ. 25

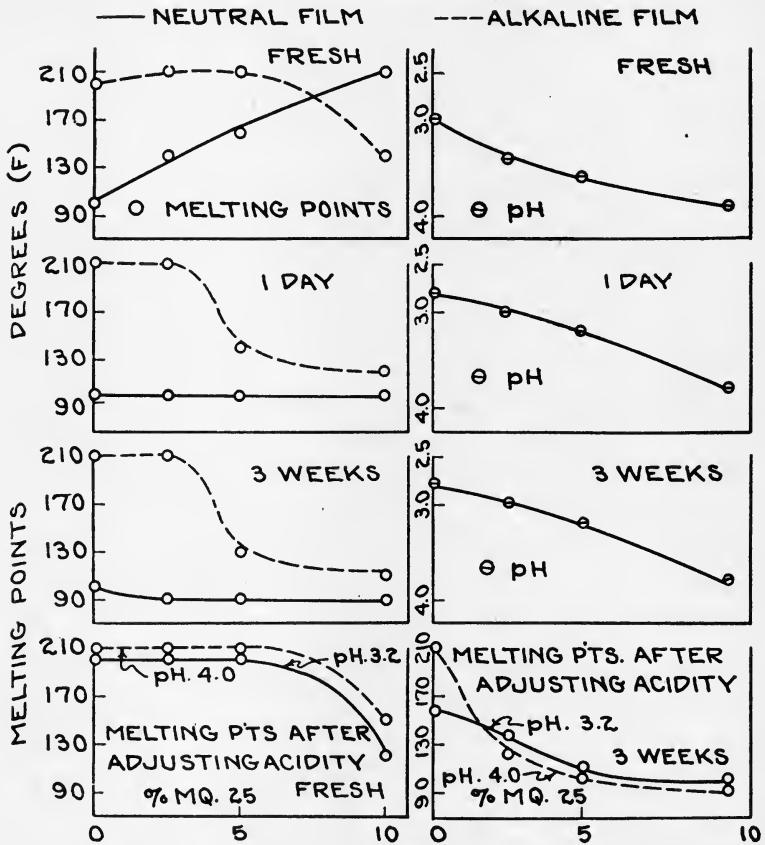

FIG. 4. Effect of the addition of MQ-25 developer on the hardening properties of a 2 per cent chrome alum stop bath containing 5 cc. of acetic acid per liter.

cent solution of chrome alum, particularly with respect to retarding the formation of hydroxide sludge, by the addition of acids.

To date, sulfuric acid has been more commonly used than acetic acid in chrome alum baths. From a consideration of the chemical

properties of the two acids with respect to the photographic properties desired, acetic acid would appear more suitable because it is less

2.0 % CHROME ALUM
0.1 % SULPHURIC ACID
X % MQ. 25

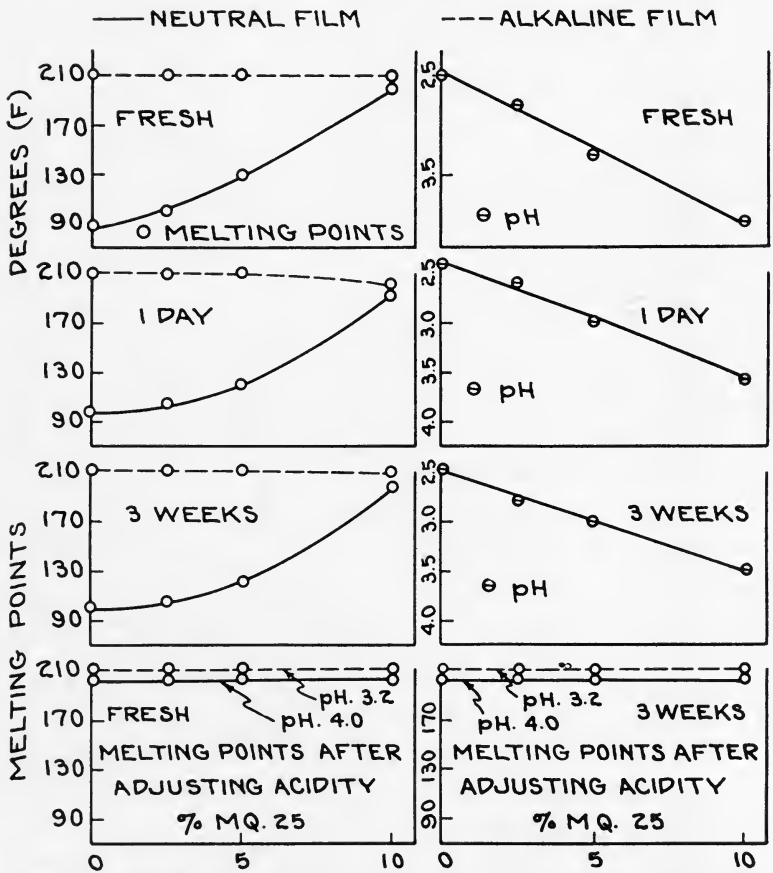

FIG. 5. Effect of the addition of MQ-25 developer on the hardening properties of a 2 per cent chrome alum stop bath containing 1 cc. of sulfuric acid per liter.

dissociated and does not tend to precipitate sulfur from hypo as readily as sulfuric acid. However, because of the prevailing preference for sulfuric acid in chrome alum baths, the effect of both of the above acids was determined.

The effect of varying concentrations of MQ-25 developer on the hardening properties of a stop bath containing (1) acetic acid and

2 % CHROME ALUM
0.5 % SULPHURIC ACID
x % MQ. 25

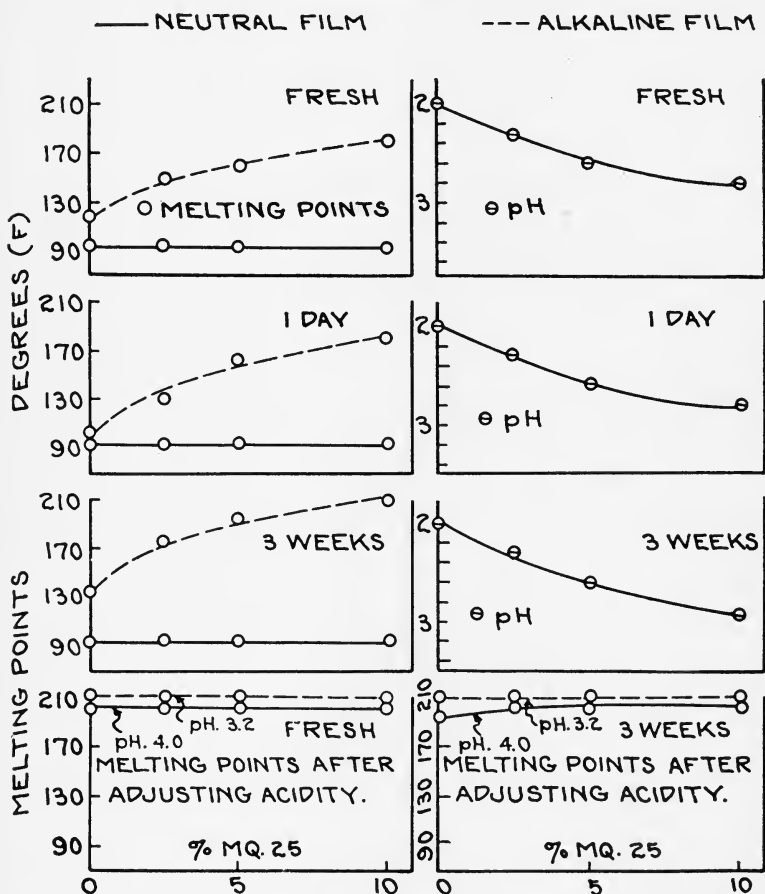

FIG. 6. Effect of the addition of MQ-25 developer on the hardening properties of a 2 per cent chrome alum stop bath containing 5 cc. of sulfuric acid per liter.

(2) sulfuric acid was therefore determined. The results are given in Figs. 4, 5, and 6. From Fig. 4 it is seen that in the fresh bath the hardening action produced with neutral film increased as the

quantity of developer added increased, while the hardening with alkaline film decreased. The hardening properties, after standing one day, were almost completely destroyed and were not revived by an adjustment of the acidity with acetic acid. In view of these facts, it was concluded that acetic acid was not satisfactory for use in chrome alum stop baths.

The effect of the addition of sulfuric acid on the hardening properties of a 2 per cent chrome alum stop bath is shown in Figs. 5 and 6. The hardening action produced with neutral film in a bath containing 0.1 per cent sulfuric acid (Fig. 5) increased and the acidity decreased on the addition of developer. A maximum degree of hardening, however, was produced with neutral film after the acidity of the solution was adjusted to a pH of 4.0. The age of the bath had no effect on the hardening properties. Alkaline film was hardened to a maximum degree, irrespective of the quantity of developer added up to 10 per cent. In the case of the 0.5 per cent sulfuric acid stop bath, the hardening action with alkaline film increased as the original acidity decreased. After the bath was three weeks old, the hardening behavior with alkaline film increased slightly. No appreciable hardening was obtained with neutral film until the acidity was adjusted to a pH of 4.0. A maximum degree of hardening was produced with both neutral and alkaline film after the acidity of the bath had been adjusted in this way.

From the results of these preliminary experiments recorded in Figs. 1 to 6, it was concluded that: (1) the hardening properties of a chrome alum stop bath are impaired by the presence of acetic acid, developer, and sodium sulfite; (2) the addition of developer and sodium sulfite decreases the acidity of the bath which usually decreases the hardening action; (3) the hardening properties of an acetic acid-chrome alum bath containing developer are almost completely destroyed after standing for one day, while baths containing an equivalent quantity of sulfuric acid produce satisfactory hardening on keeping; (4) the hardening properties of a plain 2 per cent chrome alum bath with the addition of developer over a period of several days are better than those of a 2 per cent chrome alum bath containing acetic acid; (5) sulfuric acid appears to be the most suitable acid for use in chrome alum stop baths; (6) the degree of hardening produced in a plain chrome alum bath or in a sulfuric acid-chrome alum bath depends upon the acidity of the bath in relation to that of the gelatin film, which is determined by the

quantity of developer retained by the film, the concentration of alkali in the developer, and the hydrogen ion concentration of the bath; (8) the hydrogen ion concentration of the bath must be maintained between certain limits in order to obtain satisfactory hardening properties; (9) a maximum degree of hardening is produced with neutral film when the acidity of the bath is maintained between a pH of 3.8 and 4.2 and with alkaline film (as defined) when the acidity lies between a pH of 3.0 and 4.0; (10) the concentration of chrome alum and the age of a plain chrome alum bath containing developer has but little effect on the hardening properties if the acidity of the bath is maintained between the above limits by the addition of sulfuric acid or caustic soda.

For practical purposes it was concluded that a 2 per cent chrome alum solution is the best stop bath. In cases where dilute developer is used and the alkalinity of the film is sufficiently low to reduce to a minimum the tendency of the bath to blister, the addition of 0.1 per cent sulfuric acid is an advantage in increasing the developer life of the bath, but it is not considered advisable to increase the quantity of acid above this amount because of the accompanying propensity of the bath to blister and to fail to harden weakly alkaline film.

Fixing Baths for Use with Acid Stop Baths.—Gelatin which has been hardened in a suitable chrome alum stop bath is sufficiently hardened to withstand wash water at relatively high temperatures and therefore further hardening of the film in the fixing bath is not necessary. However, a non-hardening fixing bath suitable for use in conjunction with a chrome alum hardening stop bath should not precipitate sulfur in the presence of an appreciable quantity (50 per cent) of stop bath since a relatively large quantity of acid is continually being carried into the fixing bath. Therefore, the fixing bath must contain an appreciable quantity of an anti-sulfur protective so as to prevent the precipitation of sulfur as the fixing bath becomes exhausted and at the same time the chrome alum must not precipitate as a sludge in the fixing bath.

Since sodium sulfite is the most efficient anti-sulfur protective, experiments were made to determine the quantity of sodium sulfite necessary to prevent the precipitation of sulfur from a 30 per cent hypo solution containing 50 per cent of stop bath (a quantity of stop bath which would normally be carried into the fixing bath). At normal temperatures, sodium sulfite was found to be satisfactory

but on incubation a distinct gray-green precipitate occurred similar to that formed in an aluminum alum fixing bath.

In further experiments it was found that 1 per cent sodium sulfite together with 0.5 per cent sodium bisulfite prevented the precipitation of both sulfur and the hardening agent from a 30 per cent hypo solution containing 50 per cent of a 2 per cent solution of chrome alum. Comparative experiments were made with a 2 per cent chrome alum stop bath containing 0.1 per cent sulfuric acid and it was found that the increased acidity was not sufficient to cause any material difference in the sulfurization life of the fixing bath.

PRACTICAL TESTS WITH CHROME ALUM STOP BATHS

At the outset, practical tests were made with the following formula:

	<i>Metric</i>	<i>Avoirdupois</i>
Potassium chrome alum	20 grams	8½ lbs.
Water to make	1 liter	50 gallons

Effect of Addition of Developer on Hardening Properties.—In order to gain a preliminary idea of the behavior of the stop bath on exhaustion with film, increasing quantities of the developers D-16 and D-76* were added to a definite volume of the bath and samples stored at 70°F. and 110°F. Hardening tests were then made at regular intervals after storing the mixtures for increasing periods of time.

The tests with the D-16 developer were made according to the procedure described on page 486 for alkaline film. With the D-76 developer a similar procedure was followed, except that strips of Eastman motion picture panchromatic negative film were developed in D-76 for ten minutes. The fixing bath for these tests contained 30 per cent hypo and 1.0 per cent sodium bisulfite.

The *hardening tests* were made by determining both the reticulation and melting points of the film. Since a hardening stop bath is used mostly for high temperature work, the reticulation point is of the

* Formula D-76

	<i>Metric</i>	<i>Avoirdupois</i>
Elon	2 grams	13 ounces
Hydroquinone	5 grams	2 pounds
Sodium sulfite (anhydrous E. K. Co.)	100 grams	42 pounds
Borax	2 grams	13 ounces
Water to make	1 liter	50 gallons

greatest importance because, although a film is insoluble in boiling water, it may reticulate readily and a reticulated film is usually worthless.

In practice when processing at high temperatures it is important that the film should not swell and at the same time it should have a fairly high melting point. In many cases, the thickness of the film was measured before determining the reticulation and melting points and it was found that a fairly close relation existed between the degree of swelling and the reticulation point as is shown by Table II.

TABLE II. *Relation between Hardness and Degree of Swelling of Film*

Footage Processed per Gallon	Thickness	Reticulation Point	Melting Point
0	0.010 in.	Nil	210°F.
125	0.011 in.	Nil	210°F.
190 (before revival with acid)	0.013 in.	105°F.	170°F.
190 (after revival with acid)	0.013 in.	105°F.	170°F.
250	0.013 in.	100°F.	130°F.
315 (before revival with acid)	0.013 in.	95°F.	120°F.
315 (after revival with acid)	0.013 in.	95°F.	120°F.
375	0.013 in.	95°F.	110°F.

It is seen that the unswollen film did not reticulate but, after swelling from 0.010 to 0.013 inch, the reticulation point dropped to 105°F., although the film melted at a temperature as high as 170°F.

The effect of adding D-16 developer to a 2 per cent chrome alum stop bath is shown in Fig. 7. The results indicate that a quantity of developer equal to 10 per cent of the volume of the bath may be added before an immediate drop in the melting point occurs. This corresponds to a footage of 200 feet per gallon. After storage for three weeks at 70°F. and 110°F., the life of the bath was reduced to 150 feet per gallon. The hardening action of a similar stop bath containing D-76 developer fell off more rapidly with the addition of increasing quantities of developer. This was to be expected as formula D-76 contains more sodium sulfite than formula D-16. The life of the bath with D-76 developer was reduced to 115 feet per gallon in the fresh bath and to 85 feet per gallon after the bath had stood for three weeks.

From the results in Fig. 7 it is seen that: (1) a change in the storage temperature from 70°F. to 110°F. has very little effect on the loss in hardening properties on the addition of developer;

(2) the hardening properties of solutions having a pH greater than 4.0 fell off rapidly on ageing; (3) the acidity of the solutions containing developer increased on ageing except in the case of solutions con-

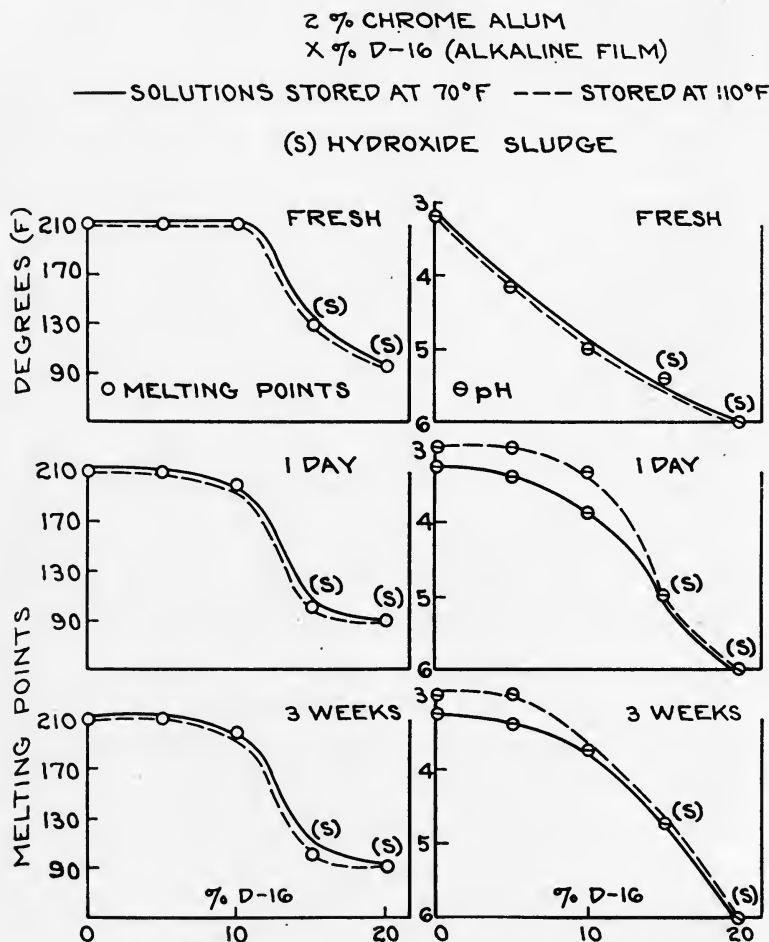

FIG. 7. Effect of the addition of D-16 developer on the hardening properties of a plain 2 per cent chrome alum stop bath.

taining sludges; (4) the hardening decreased most within the first 24 hours after adding developer.

Effect of Exhaustion of Stop Baths without Revival.—For the practical exhaustion tests, 50 foot lengths of Eastman motion picture

positive film were developed in D-16 at 70°F. and processed in a manner similar to that described on page 486 for alkaline film.

The effect of exhaustion on the hardening properties of 2 per cent and 3 per cent plain chrome alum stop baths is shown in Fig. 8. The hardening properties of the 2 per cent bath decreased rapidly after 200 feet of film per gallon had been processed, which may be considered as the life of the fresh bath. After storing for two weeks, the hardening life of the bath decreased to 100 feet per gallon. The

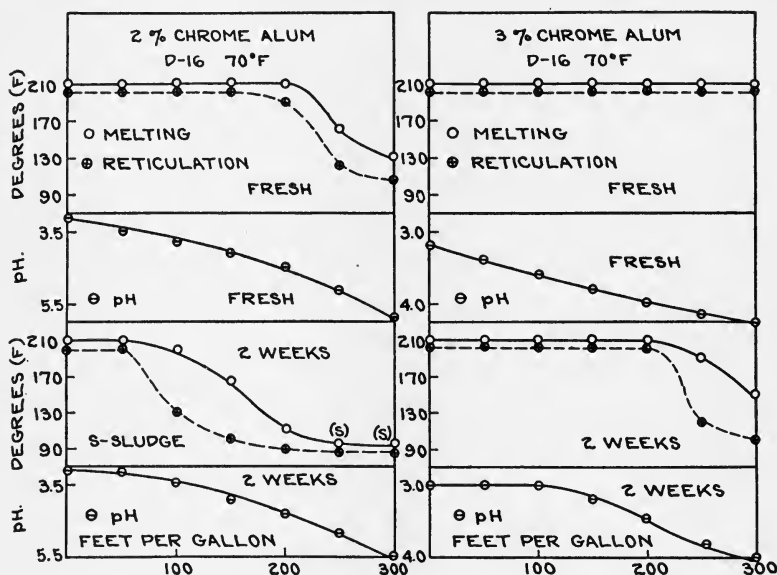

FIG. 8. Effect of the exhaustion without acid revival on the hardening properties of 2 per cent and 3 per cent chrome alum stop baths (D-16 developer, 70°F.).

change in acidity during the processing of 250 feet of film per gallon was from a pH of 3.2 to a pH of 5.0 at which point a chromium sludge precipitated on standing.

A maximum degree of hardening was obtained in the fresh 3 per cent bath throughout the entire period of processing 300 feet of film but after storing for two weeks the life of the bath decreased to 200 feet of film per gallon. The acidity changed from a pH of 3.2 to a pH of 4.2 during the exhaustion with 300 feet per gallon, which was not as great as the acidity change in the 2 per cent bath under similar conditions. No sludges were formed in the 3 per cent bath even after standing for two weeks at 70°F.

A comparison between the hardening properties of the 2 per cent and 3 per cent chrome alum stop baths indicated that the hardening life of the 3 per cent bath is about twice as great as that of the 2 per cent bath. It also seems plausible that a further increase in hardening properties might be obtained with higher concentrations of chrome alum, but concentrated solutions of chrome alum tend to stain the film, especially at high temperatures. For this reason, it was not considered desirable to increase the concentration of chrome alum beyond 3 per cent for use as a stop bath.

Effect of Exhaustion and Revival with Acid on the Hardening Properties of Stop Baths.—Practical exhaustion tests during which the stop baths were suitably revived were made with 2 per cent and 3 per cent chrome alum solutions as follows. Lengths of Eastman positive motion picture film were processed in D-16 at 70°F. and 85°F. in a manner similar to that outlined previously. Ten per cent of sodium sulfate (desiccated) was added to the D-16 developer at 85°F. to prevent excessive swelling. One hundred cc. samples of the solution were taken after every 50 feet of film had been processed and after revival with acid. They were then stored at 70°F. and their hardening properties measured at regular intervals. Lengths of Eastman panchromatic negative motion picture film were developed in D-76 for 10 minutes and subsequently given a treatment similar to the positive film in D-16 above.

The acidity of the baths was revived at regular intervals by adding a quantity of acid so as to restore the acidity of the bath to a pH of 3.0, at which point previous experiments had indicated that maximum hardening was obtained. The condition of the bath was determined by titrating a 25 cc. sample (in 50 cc. of distilled water containing 5 cc. of brom phenol blue indicator) with a 2.5 per cent sulfuric acid solution until the solution was just acid to the indicator. From these results the quantity of concentrated acid necessary to add to the bath was calculated. The pH of the bath was always measured after the concentrated acid had been added so as to be sure that it was correct. The average quantity of concentrated acid which it was necessary to add at each revival point with the D-16 developer was 1 cc. per liter or 0.13 ounce per gallon and with film developed in D-76 the quantity was 1.5 cc. per liter or 0.19 ounce per gallon. The results of the exhaustion tests are given in Figs. 9, 10, 11, 12, and 13.

With D-16 at 70°F. (Fig. 9), the 2 per cent bath, revived with

acid after processing 150 feet of film per gallon, was capable of treating 250 feet of film per gallon before a decrease in the hardening properties occurred. The hardening action was restored by the addition of acid but decreased on further exhaustion up to 380 feet per gallon. The original degree of hardening was again obtained after the addition of acid and the hardening action again decreased after processing 500 feet of film per gallon. After revival with acid the hardening properties increased but decreased rapidly on further exhaustion

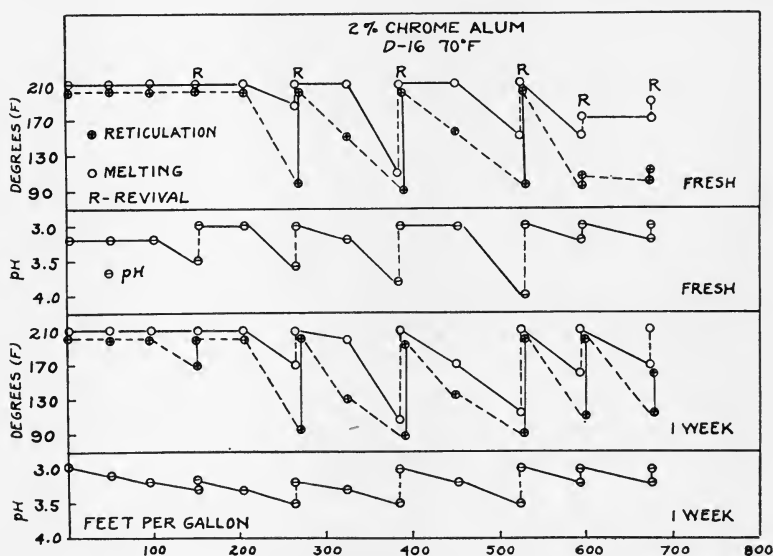

FIG. 9. Effect of exhaustion with acid revival on the hardening properties of a plain 2 per cent chrome alum stop bath (D-16 developer, 70°F.).

when they were not satisfactorily revived by the addition of acid. The hardening action of the samples was again determined after storing for one week. With the samples taken before revival a minimum degree of hardening was obtained except in the case of the sample taken at 150 feet when the hardening action was satisfactory. This indicates that the bath should be revived more frequently if uniform hardening properties are desired.

With D-16 at 70°F., the 3 per cent bath, when exhausted and revived in a manner similar to that employed for the 2 per cent bath, showed more uniform hardening properties (Fig. 10). A maximum degree of hardening was maintained throughout the ex-

haustion with 750 feet of motion picture positive film per gallon. A slight decrease in the hardening properties was obtained with the samples one week old which were taken before revival after processing 450 feet of film.

The hardening properties of the 3 per cent chrome alum bath decreased more rapidly on exhaustion with D-76 at 70°F. (Fig. 11) than those of the 3 per cent bath exhausted with D-16 at 70°F. The hardening properties were maintained until 300 feet of film

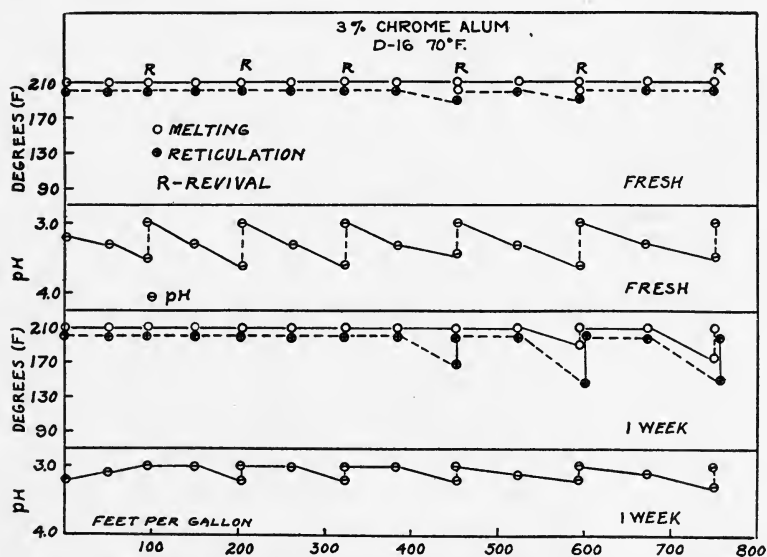

FIG. 10. Effect of exhaustion with acid revival on the hardening properties of a plain 3 per cent chrome alum stop bath (D-16 developer, 70°F.).

per gallon had been processed by reviving with acid every 100 feet, but on further exhaustion the hardening action decreased rapidly and the baths could not be satisfactorily revived by the addition of acid.

With D-16 at 85°F., the hardening properties of the 2 per cent bath during exhaustion with revival were more uniform than when the bath was exhausted at 70°F. (Fig. 12). A maximum degree of hardening was maintained until 600 feet of film per gallon had been treated. The film processed in the samples one week old taken after the second revival reticulated at a temperature of 90°F., indicating that too much acid had been added during revival.

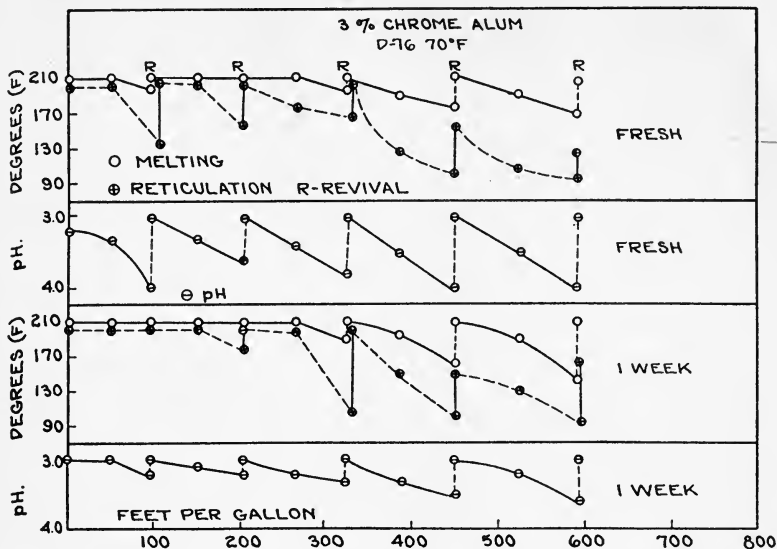

FIG. 11. Effect of exhaustion with acid revival on the hardening properties of a plain 3 per cent chrome alum stop bath (D-76 developer, 70°F.).

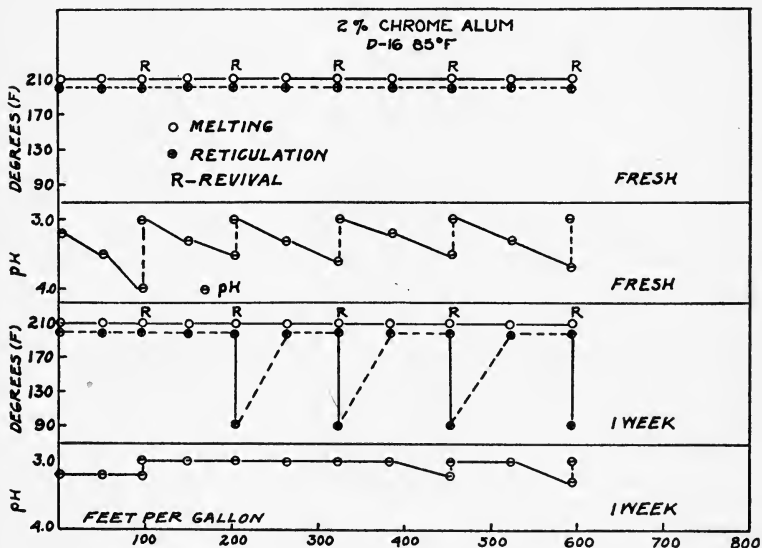

FIG. 12. Effect of exhaustion with acid revival on the hardening properties of a plain 2 per cent chrome alum stop bath (D-16 developer, 85°F.).

With the 2 per cent bath, the hardening properties on exhaustion with D-76 at 85°F. were inferior to those of the other baths investigated (Fig. 13). Revival with acid every 100 feet per gallon increased the hardening action at these points but the hardening decreased rapidly on further exhaustion. After 300 feet of film per gallon had been processed, satisfactory hardening properties were not maintained.

The low temperature at which the film reticulated before each

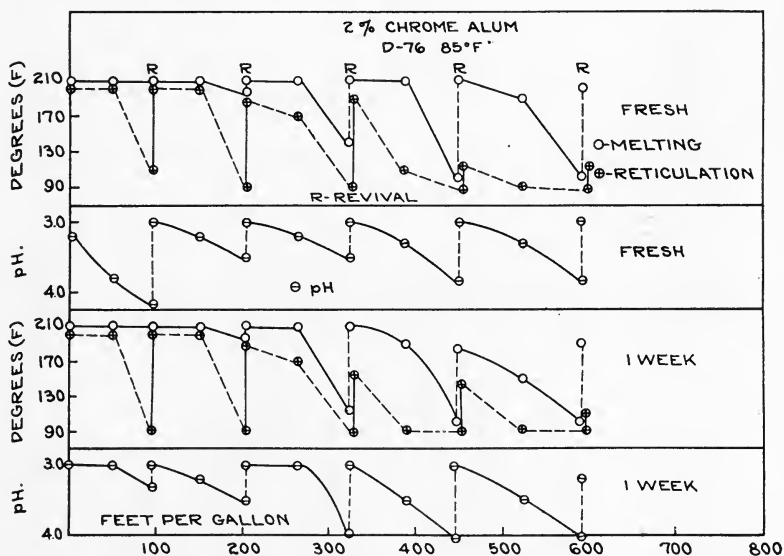

FIG. 13. Effect of exhaustion with acid revival on the hardening properties of a plain 2 per cent chrome alum stop bath (D-76 developer, 85°F.).

revival indicates that the bath should have been revived more frequently. The age of the stored samples had little effect on the hardening properties.

SUMMARY

The function of a chrome alum stop bath is to arrest development and harden the emulsion before fixing. It also prolongs the life of an alum fixing bath by virtue of preventing the addition of alkali. This, in turn, serves to maintain the hardening properties of the fixing bath and prevent sludging.

At normal temperatures it is not necessary to harden the gelatin coating of motion picture film to the extent produced by chrome

alum baths but the use of chrome alum as a hardening agent is desirable when processing at high temperatures or when rapid drying at high temperatures is necessary.

As it is somewhat difficult to maintain a uniform degree of hardening with most chrome alum fixing baths and since their hardening properties frequently fall off before the fixing powers of the hypo are exhausted even with suitable revival, it is more economical to use a chrome alum stop bath because this is cheaper and can be renewed more frequently. Also, a stop bath hardens the gelatin more rapidly than a fixing bath so that at high temperatures the gelatin is hardened before it has a chance to swell excessively.

The purpose of this investigation has been to determine the more important factors which influence the hardening properties of chrome alum solutions and to recommend suitable stop bath formulas.

It has been found that: (1) plain chrome alum solutions are more suitable for hardening motion picture film than those containing acid; (2) the addition of developer decreases the acidity and the hardening properties; (3) the acidity or pH value of a chrome alum solution must be maintained at a value of 4.0 for neutral film and between 3.8 and 3.0 for alkaline film if the maximum degree of hardening is to be obtained; the hardening properties are constant, irrespective of the concentration of chrome alum above 0.5 per cent when the pH is adjusted to these values; (4) sulfuric acid is the most suitable acid for maintaining this acidity; and (5) the hardening properties of a bath containing an excess of developer decrease with age.

Practical exhaustion tests with and without revival with acid made with 2 per cent and 3 per cent chrome alum baths have shown that: (1) as the degree of exhaustion increases, the acidity and hardening properties decrease; (2) the addition of sulfuric acid at regular intervals increases the hardening properties and prolongs the life of the bath; (3) with a 3 per cent chrome alum bath more uniform hardening properties are obtained with use than with a 2 per cent bath; (4) more uniform hardening properties are also obtained at 85°F. than at 70°F.; and (5) the D-76 developer has a greater effect on decreasing the hardening properties than D-16.

PRACTICAL RECOMMENDATIONS

The following formula is satisfactory for use as a stop bath during the processing of motion picture film.

Chrome Alum Hardening Bath (Formula SB-3)

	<i>Metric</i>	<i>Avoirdupois</i>
Chrome alum	30 grams	13 pounds
Water to make	1 liter	50 gallons

The chrome alum should be dissolved in water at a temperature lower than 150°F., otherwise the solution will tend to become more acid due to hydrolysis and its hardening properties will be affected.

After development, immerse for three minutes in the above hardening solution, taking care to agitate the film for thirty to forty-five seconds. This will tend to prevent blisters, streaks, and chrome alum stains.

If the film is not agitated as above, the alkali in the developer is apt to precipitate a sludge of chromium hydroxide on the film although with developers which do not contain more than 2 per cent of sodium carbonate no trouble is usually experienced.

A less expensive bath may be compounded using a 2 per cent solution of chrome alum in place of the 3 per cent solution (Formula SB-3) above. This has less tendency to give blisters or green stains at high temperatures, but its life is much shorter than that of the 3 per cent bath.

The baths will keep indefinitely without use but with use the hardening properties fall off as a result of the addition of developer carried over by the films and in the case of any bath containing a given quantity of developer the hardening properties continue to decrease as the bath ages. In most cases, however, the hardening properties of fresh or old baths which have been impaired by the addition of developer can be restored by the addition of a quantity of sulfuric acid necessary to bring the pH value (degree of acidity) to 4.0 for neutral film and between 3.0 and 3.8 for alkaline film.

Blisters may tend to form if the film is swollen on immersing in the bath, as a result of decomposition of the carbonate in the developer by the chrome alum which is normally acid, but agitation will tend to prevent their formation.

The hardening properties of the bath depend upon (a) the acidity of the bath and alkalinity of the film, (b) the age of the bath and quantity of developer carried over to it by the film, and (c) the time of immersion. The time of immersion in the hardening bath should never be less than three minutes which is usually sufficient to give maximum hardening. Films which have been treated with a chrome alum hardening bath should always be wiped carefully or squeegeed after washing and previous to drying, otherwise any chromium scum

which exists will leave a stain and after drying this is very difficult to remove.

Any hardening or non-hardening fixing bath may be used in conjunction with the stop bath. A 30 per cent solution of hypo containing 1.0 to 2.5 per cent of sodium bisulfite or a regular potassium alum-acid or a chrome alum fixing bath may be used, although a hardening fixing bath is not necessary.

Hardening Life of Baths without Revival.—The life of a 2 per cent bath without revival with the D-16 developer is about 200 feet of motion picture positive film per gallon, that is, the bath will continue to harden the film so that it does not melt at a temperature below 212°F. up to this point. The life is only 100 feet per gallon over a period of use of two weeks.

If revival with acid is not possible or desirable, a 3 per cent bath is to be preferred in view of its longer life which, with the D-16 developer, is equal to 300 feet per gallon in a fresh bath and 200 feet per gallon during a period of use of two weeks.

Since the gelatin coating of negative motion picture film absorbs about twice as much developer as that of positive film the life of the stop baths when using negative film is proportionally less. The lives of the baths can, of course, be prolonged by rinsing in water previous to immersion in the stop bath but usually this is impractical.

With the D-76 developer the life of the baths is about one-half of that with D-16 when fresh and the hardening properties fall off more rapidly on keeping.

Hardening Life of the Baths with Revival.—If 2 per cent or 3 per cent baths are revived with sulfuric acid after processing each 100 feet of positive film or each 50 feet of negative film in either D-16 or D-76, the life of the bath is considerably prolonged as is indicated by Table III.

TABLE III. *Life of Stop Baths with Exhaustion*

Per Cent of Chrome Alum	Developer	Nature of Film Used	Life of Bath (70°F.) (Feet per Gallon)	
			Without Revival	With Revival
2	D-16	M. P. Positive	200	500
2	D-76	M. P. Pan. Negative	100	300
3	D-16	M. P. Positive	300	700
3	D-76	M. P. Pan. Negative	...	400

The life of baths exhausted with other developers containing equivalent quantities of sodium carbonate and sodium sulfite would be analogous to those given above. The quantity of acid to be added at each revival point can be readily determined by the method described and enough acid should be added to the exhausted bath to bring the acidity to a pH value of 3.0, at which point maximum hardening is obtained with unrinsed film when using developers containing an average quantity of alkali.

Sludging Life.—The addition of excess alkali or developer to a chrome alum solution may cause the precipitation of a chromium sludge although its precipitation is greatly retarded if an excess of sodium sulfite is present. The composition of the precipitate varies with the quantity of sulfite present. No test for sulfite was found with the precipitate obtained with the D-16 developer but a stop bath precipitated with D-76 gave evidence of sulfite even in the well washed precipitate. No sludges were obtained providing the solutions had a pH less than 4.0.

After adding 15 per cent of D-76 developer (without revival) to a 2 per cent chrome alum bath a sludge was obtained after storing for two months at 110°F. No precipitate was formed at 70°F. With the 3 per cent bath, no precipitate was obtained under any conditions up to a concentration of 20 per cent of D-76. With the addition of 15 per cent of D-16 (without revival) to a 2 per cent or 3 per cent chrome alum bath a sludge was obtained after storing for 1 day at 70°F.

The film should be agitated when first immersed in the bath, otherwise in view of the high concentration of alkali in the vicinity of the film a sludge of chromium hydroxide is apt to deposit on the film surface. Its formation can be entirely prevented by reviving the bath with acid at intervals.

When to Discard the Bath.—The stop bath should be discarded either when (1) a sludge forms in the bath or on the film, or (2) the bath ceases to harden after revival with acid. The addition of further quantities of chrome alum to a bath which has lost its hardening properties will revive it more or less in proportion to the quantity added but this procedure is not to be recommended.

Effect of Temperature and Time on Hardening.—If the film is agitated when immersed in the fresh 2 per cent stop bath, maximum hardening with positive film is secured in thirty seconds at 70°F. and

85°F. and with negative film in one and a half to two minutes at 70°F. and one minute at 85°F. With the 3 per cent bath, the times for maximum hardening were somewhat less. With most of the partially exhausted baths tested, maximum hardening was secured in three minutes so that in practice an immersion of three minutes in the stop bath was considered adequate.

Troubles.—The chief difficulty encountered with stop baths is in the nature of stains as follows:

(1) *Green Stain.*—This is perhaps the most common stain and imparts to the gelatin an appearance as if it had been colored with a green dye. The intensity of the stain is influenced by the relative proportions of carbonate and sulfite in the developer, an excess of carbonate increasing the intensity of the stain, while an excess of sulfite decreases the intensity. The intensity of the stain is also materially increased at high temperatures (80°F. to 90°F.).

The green stain can usually be removed by treating the film with a 5 per cent solution of potassium citrate or a 50 per cent solution of potassium hydroxide although by virtue of this treatment the hardening of the gelatin is destroyed. Ordinarily, the green stain is not objectionable from a photographic standpoint, providing it is uniform over the entire film.

(2) *Greenish White Scum.*—This consists of chromium hydroxide or basic chromium sulfite and is usually precipitated on the film surface in the manner previously described. It is readily removed from the wet film by swabbing with moist absorbent cotton but is very difficult to remove after the film is dry. Its formation may be prevented by (a) agitating the film thoroughly when first immersed in the stop bath, and (b) using a developer containing as little alkali as possible and by reviving the bath with acid at intervals.

ACKNOWLEDGMENT

The authors are indebted to J. F. Ross, L. E. Muehler, and H. A. Hartt who assisted with the experimental work.

REFERENCES

¹ CRABTREE, J. I., AND HARTT, H. A.: "Some Properties of Fixing Baths." *Trans. Soc. Mot. Pict. Eng.*, XIII (1929), No. 38, p. 364.

² LAINER, A.: "A Non-Turbid Fixing Bath Containing Alum." *Phot. Korr.*, 26 (1889), p. 311.

³ NAMIAS, R.: "Chimica Fotografica." *Il Progresso Fotografico*, Milan, Italy. (1912), p. 431.

⁴ LUMIÈRE, A. AND L., AND SEYEWETZ, A.: "On the Acid Reaction of Alums and the Effect of Their Acidity on the Insolubility of Gelatin." *Bull. soc. franc. phot.* II, 18 (1902), p. 502.

⁵ NAMIAS, R.: "The Effect of Chromium Compounds on Gelatin." *Phot. Korr.*, 39 (1902), p. 446.

⁶ CRABTREE, J. I.: "High Temperature Development of Roll Film, Film Packs, Plates, and Paper," *Brit. J. Phot.*, 64 (1917), p. 555.

EDITOR'S NOTE: "Part II—Chrome Alum Fixing Baths" will appear in the June issue of the JOURNAL.

SOUND FILMS FOR SURGICAL INSTRUCTION

P. E. TRUESDALE*

In order to establish harmonious and profitable relationships with a new element of individuals among students of science, it is essential to know something of their origin, their habits, ambitions, and ideals. At this particular crossroads in the progress of your industry I make your acquaintance as a member of a profession which, by the assistance of the modern allied sciences, has been able to merge out of an age of mysticism, sorcery, and ignorance.

The earliest institutions for the teaching of medicine were situated in temples and groves dedicated to the worship of gods who were supposed to preside over the health of the population. Thus, in Egypt the god, Osiris, and his wife, Isis, were the tutelary deities of the medical arts, and in Greece the god of health was Aesculapius. The temples were situated in the neighborhood of streams and springs which were supposed to possess healing qualities. One of the most famous of these ancient temples was that located on the Island of Cos; its most celebrated disciple was Hippocrates who flourished early in the 4th century B.C. and whose teachings ruled medical science even to the close of the eighteenth century. Throughout Italy the same methods prevailed, the Romans deriving most of their medical knowledge from the Greek teachers. Galen, the greatest of all anatomists, was a native of Perganum where there was a famous medical school in which he was educated. Greek teachers were also responsible for the rise of the Arabian school of medicine.

Not until the 6th century was the teacher of medicine divorced from his religious functions although even down to the medieval period much of the medical learning of the world appertained to the priesthood. During this early period anatomy was the basic subject taught in the medical schools. Since it was considered a desecration of the human body to examine it after death, progress was greatly encumbered. Nevertheless, taking a look into the work

* Truesdale Hospital, Fall River, Mass.

of the masters of this early period and viewing in particular the contributions of Galen, especially his volumes, *On Anatomical Achievement*, one is amazed at the extent of his teachings on a background of pictorial illustrations. Anatomical pictures form the bulk of his material for instruction. The great teachers of the middle ages used the pictorial art to an even greater extent. Thus throughout antiquity from the original medical hieroglyphics on stone as early as 16,000 B.C. medical knowledge has been handed down on papyrus, metal, limestone, soapstone, talc, clay, bone, and copper plates. The advent of motion portrayal marked a new epoch in the progress of science and in the history of photography. While its field of utility has been limited largely to aesthetic purposes, business men have been alert to its great value in placing commodities before the public.

In spite of the fact that life is synonymous with motion and that every part of the human body is in a state of growth or degeneration, motion picture illustrations in medicine with few exceptions have been limited to demonstrations of deformities of the extremities. The medical profession, therefore, is only beginning to make use of motion photography as a scientific means of conveying impressions of living processes with greater accuracy and effect. The reasons for this delay are obvious. The preparation of a medical subject for motion picture recording is a time-consuming experience. Often, it requires actual tests to determine the adaptability of the subject in mind. These are frequently disappointing and more than likely to entail considerable expense. While the doctor in the preparation of his picture has contributed time, labor, and money, he has not been able to find reimbursement to help in the production of the next picture. The medical author is remunerated to some slight extent for his contribution in medical books, but single articles for medical periodicals are prepared and published without any expectation of monetary return. These manuscripts and illustrations, however, are comparatively inexpensive to produce. The doctor gives as much of his time to his article as he can reasonably afford. Preparation and publication are carried out in line with tradition. The advent of sound pictures bids fair to alter relationships in the methods of transmitting medical knowledge. Just as it has greatly embarrassed a theatrical industry, thought to be established for some time to come, so it is likely to make inroads upon the orthodox methods of teaching medicine.

However, at the outset it is essential that an intimate relationship be established between the medical author and the producer, and between both of these agencies and the electrical research arm of the service. There is a type of motion picture producer who waxes enthusiastic over a medical subject, promises much and accomplishes nothing. Then there is his antithesis, the intelligent, dependable, and courteous producer whose purpose is serious and whose aims are constructive. I have had experience with both. In search of a producer with personnel and equipment for animation of illustrations, I was tossed about from pillar to post for a period of four months and disappointed at every turn until recommended by the Eastman Kodak Company to consult the Carpenter-Goldman Laboratories, Incorporated, now the Audio-Cinema, Incorporated, of Long Island City, New York. There, much to my surprise, I found an educational interest in the atmosphere, a keen desire to fulfill the object which I had aimed to achieve, and a determination to do justice to an anatomical, physiological, and surgical subject in a manner which had never before been witnessed. The members of this firm impressed one as understanding the language of the physician. When a humble doctor of very limited financial resources can excite the attention, coöperation, discriminating mind, and assistance of a sound picture expert to evaluate his manuscript for production, there is hope for progress.

Not every subject in medicine lends itself to illustration by motion picture photography or by the introduction of animated drawings. Many that are now thought to be unsuitable will, however, by future study and experience, prove to greatly enhance the body of the teachers' thoughts and ideas. The Canti films by Dr. Ronald G. Canti of St. Bartholomew's Hospital, London, on the growth of cancer, now being shown under the auspices of the American Society for the Control of Cancer, are an example of such an achievement by the use of photomicrography. *The Great Peril* and its trailer of cartoons entitled *By the Way* are to be distributed by this same organization to the public in the near future. These films are without voice reproduction.

The Harvard University Film Foundation, which two years ago was an idea, is now a definite plan for "the establishment of a center for the production and collection of scientific and educational films in collaboration with the Harvard Faculty." They have released twenty reels of films of the highest standard in the fields of geography,

biology, anthropology, and the fine arts. These films they have produced, or collected and edited, and on them they have exclusive distribution rights. They have also made a large collection of industrial films from over one hundred industries. These are used several times weekly in the Harvard Graduate School of Business Administration and also in other departments of the University. Although established as an educational institution, the Foundation is designed to be a self-supporting organization, deriving its income from the sale and distribution of its material to educational and cultural institutions. The films and photographs of the Foundation are available to colleges, schools, museums, churches, clubs, and similar organizations on a purchase or rental basis.

The value of these films in education may be summed up in the words of Dean Holmes of the Harvard Graduate School of Education. He says: "The film is the modern supplement to the book and has certain advantages as a form of expression which the book lacks. There is every reason to believe that the film may be developed by sincere and intelligent effort into a very powerful force for the dissemination of knowledge, and even for the increase of knowledge." President Eliot said, "The moving picture is a valuable means of instruction, and all our school systems ought to seize upon it." In so far as I can learn the adaptation of the voice to the motion picture film has not yet been employed by the University Film Foundation. This step no doubt will be taken in the near future.

The quality of memory possessed by the student of medicine is a large factor in obtaining his education and later in utilizing the lessons learned by experience. If the text in Gray's *Anatomy*, which is expected to be committed to memory, were to be placed word after word in a straight line, it would cover a distance of approximately forty-eight miles. In many of the medical schools this feat of memory is expected to be accomplished in three months. It is made particularly difficult and evanescent by fading of the memory idea and decay of the surface impression made upon the nervous system. Without pictures, charts, and dissections the student would find the task impossible. Add motion and sound to the illustrations now provided and the knowledge will be more easily acquired and the impression much more likely to be retained. The concept of physical memory has been extended to cover all changes in organic matter which outlast the operation of their causes. It is thus made synonymous with physiological habit. While

there have been systematic attempts to improve the efficiency of memory, some of which originated with the Greek poet, Simonides, and while many forms of apparatus have been devised for the presentation of the material to be learned, no sufficiently impressionistic technic has appeared until the introduction of the sound motion picture.

While many inventors have made machines and devices for connecting moving picture projectors with talking machines, several of which have been extensively exhibited, it has been found difficult to make the combination a satisfactory one. Edison's kinetophone first put before the public in 1912 proved defective in the quality of voice reproduction and sometimes lacked in synchronism. Gaumont developed a type of apparatus for electric control of one machine by the other. The result was a uniform operation of the two by means of a current obtained from the armature of a motor generator attached to the operating shaft of the phonograph. Such mechanical connections for voice reproduction, however, have been practically abandoned.

The medical cinema of today arrives to take its place on a stage already set, replete with a background of an art immortalized by Michelangelo, Leonardo da Vinci, and Rembrandt. The talking motion picture as a means of imparting and disseminating medical knowledge may be considered the flower of an age when culture and artistic expression have flourished.

The motion picture which illustrates this paper, in all probability foreshadows the introduction of a new personality in education, the sound picture teacher in medicine. Making due allowance for the infirmities of the author of this picture as an apprentice, one cannot expect it to be considered more than primitive in the light of developments which already suggest themselves. In the hands of teachers of experience and gifted expression rapid progress may be expected. As it is today, the structure rests upon a tripod, one leg of which is represented by the investigations, observations, experience, and association of ideas of the author; the second leg affords support by animated reproduction of pictorial and plastic illustration, while the third maintains a footing by means of the talking picture evolved through a synthesis of visual motion and vocal description.

I realize fully that in order to give it precedence to or even rank with present methods of teaching, there is need of much patient

study, coöperation, and endurance. For example, an anatomical still picture without color is not as intelligible as one with color differentiation. When the subject is in motion, it is less clear. Blood is black; muscles, vessels, and nerves are seldom distinct. The slightest shadow produced by the hand or instrument dims the operative field on the film. Therefore, problems of posture and light require strict attention to detail. We have pictured four thigh amputations, and although the last is better than the first, we have not produced one film worthy of presentation.

Moreover, it may be necessary to modify the atmosphere of the studio. The doctor is essentially a teacher, not an actor. While there are certain qualities peculiar to and essential for both, the doctor is primarily a school man and the actor a dramatic artist. The doctor's position is that of a messenger from a scientific body. He seeks to present clinical and experimental evidence in support of his observations. His attitude, personality, and power of expression are essential for convincing argument, but a make-up which gives him a school boy complexion and the mien of the happy warrior makes the doctor a product of decorative art, not a disciple of Galen.

A much desired effect of the talking motion picture in presenting a medical subject will be the economy of words; since every syllable represents a monetary tax upon the speaker, for the first time in history there will be this very tangible controlling factor in favor of brevity without loss of substance. With every unnecessary word deleted from the text, the recital of the teacher by phonetic and artistic description converges upon the point at issue in such a manner as to engrave a lasting impression upon the memory of the student.

Furthermore, the general practitioner in his struggle to keep informed upon recent advances in medical knowledge and their practical application finds a problem difficult to solve. By the monetary cost of travel in pursuit of post-graduate study, and that intangible, but nevertheless very appreciable loss in clientele entailed by absence from his community, the doctor's continuation schooling is reduced to medical books and journals. In the light of such developments of modern science, it is likely that certain relationships between teacher and students of medicine will be modified. Lectures and demonstrations recorded on films will be made available to doctors wherever located, in city, town, or backwoods. Instead of the student appearing before the teacher in the

amphitheater or the laboratory, the teacher, in his amphitheater, or in his laboratory, appears on the film before the doctor at a society meeting, a hospital staff conference, or, it may be, in the doctor's own library. Indeed, a look into the future cannot fail to excite inspiration over the inherent possibilities of this new relationship of science, art, and electricity in the field of medical education.

DISCUSSION

MR. SAMUELS: A short time ago I noticed an interesting human reaction which might interest Dr. Truesdale. We recently took pictures in the operating room of a double congenital dislocation of the hip, and during the operation a large incision was necessary. The camera man took all the pictures in the course of six or eight hours almost continuously and felt no effects. However, when the film was shown on the screen in the theater he paled, became ill, and was forced to retire. Contradictory as it may seem, the screen image of the operation had a greater physical effect upon the observer than the operation itself.

SOME ASPECTS OF A WESTERN ELECTRIC SOUND RECORDING SYSTEM*

S. S. A. WATKINS AND C. H. FETTER

This is intended to give a general picture of the part played by the Western Electric sound recording system in connection with the production of talking motion pictures. It is not proposed to introduce any new material but an attempt is made to trace the sound, with particular emphasis on sound recorded on films, from the time it originates in the studio until it is finally ready for theater projection. Some of the many details which are necessary and which must be properly correlated in order to produce a satisfactory product are discussed.

With this in mind we will take up in order sound studios, their construction and treatment, their use, monitoring and playback facilities, the amplification and recording of sound, and the processing necessary to convert these recordings into commercial prints or records ready to be shown in a theater in conjunction with a picture.

Studio Construction.—There are two major requirements which must be met in order to make a sound studio satisfactory. The studio must be thoroughly sound-proofed and it must be properly treated acoustically.

Generally speaking in order to make a studio sound-proof two things must be taken into consideration; outside noise must be excluded and mechanical vibration due to outside disturbances must not be transmitted to the studio. Outside noise can usually be kept out by building a double wall of substantial construction with an air space between the walls. To eliminate mechanical vibration it is desirable to keep the inside walls and floor of the studio separated from the foundation of the outside walls.

The matter of acoustic treatment of studios for satisfactory recording is a matter of some debate. It is generally believed, however, that acoustic conditions in the studio should be as near as possible to acoustic conditions in the open air. This means that a

* Communicated by the London Section.

studio should have a very low reverberation time. It is practically impossible to meet open air conditions but by treating the floor and the walls of the studio properly a sufficient approach to the ideal condition may be obtained. The floor should be solid, preferably consisting of several inches of solid concrete covered by some vibration absorbing material such as felt upon which may be laid a wooden floor. The walls and ceiling should be treated with sound absorbing material but it is extremely important that a proper choice be made of this material in that it should have, as far as possible, uniform sound absorbing qualities over a frequency range of from 50 to 7000 cycles. Almost every studio is an individual problem which must be engineered to meet the necessary requirements. In such a studio it is, of course, possible to modify the acoustic conditions as desired in the design of sets.

The Studio in Use.—The sounds incidental to the motion picture are picked up in the studio, amplified, and transmitted to film and wax machines. These recording machines are operated in exact time relation with the camera motors and certain identification marks are provided for purposes of synchronization.

In recording sound, air vibrations in the studio are first translated into electrical variations which in the case of film recording are converted into light variations and in the case of wax recording are converted into mechanical variations. In order to operate either a film or a wax recording machine it is necessary to amplify the sound energy picked up in the studio in some cases several billion times before sufficient power is available. This must all be done without introducing extraneous noise or without impairing the frequency characteristic of the system used in recording sounds. The frequency characteristic of the recording system from the output of the condenser microphone in the studio to the input of the electrical recorders is substantially uniform between 50 and 7000 cycles.

The proper design and control of the apparatus necessary to provide all of this amplification without introducing serious defects has been a problem of no mean magnitude. The best engineering solution at the present time indicates the desirability of associating an amplifier with the condenser transmitter which picks up the sound. In the monitoring room, which will be discussed later, the output of several of these condenser transmitter amplifiers are coupled together, each having an individual volume control. A booster amplifier is provided at this point, the output of which goes to the

main volume control. After leaving the main volume control further amplification is provided in the main amplifier room before the electrical energy is delivered to the recording machines.

In making a sound picture it is necessary to provide means to control the amplification between the microphones and the recording machines. This is done by means of a properly designed monitoring system. A monitoring room adjoins the studio and is isolated acoustically from it. Large windows are provided through which the monitor man may observe the action on the set and at the same time control the sound recording. The monitor man has means of properly combining the outputs of as many as nine microphones and has arrangements to control the volume of each one to get a good acoustic balance. The main volume control is located on the output of the booster amplifier where the volume level is sufficient to reduce the hazard of noise introduction in its manipulation. The volume of sound which goes into the electrical recorders is measured by means of an instrument called a volume indicator. A meter associated with this instrument is in front of the monitor man and the volume is regulated in accordance with deflections of the needle of this instrument.

The volume indicator is an electrical measuring device and when properly used it is the best known method of quantitatively gauging recording level. In order to measure results quantitatively the monitor man must actually listen to the sound. The conditions under which he listens should represent as near as possible average theater conditions. For this reason the monitor room is designed to have acoustics which might represent an average theater. Standard types of theater loud speakers are installed which are operated through a special monitoring amplifier from the output of the main amplifier which feeds the recording machines. The monitor man by throwing a key can also monitor the actual sound recorded on the film by means of a special amplifying system connected to a photo-electric cell located in the film recording machine. In this way the sound may actually be monitored as it is being recorded and any defect which might occur in the film recording system can be instantly detected.

After a sound record has been made on both film and wax it is possible to reproduce the sound at once by means of a playback from the wax recording machine. The sound energy delivered to the wax machine is identical in every respect to the sound delivered

to the film recording machine. The sound may be played back either in the monitor room or it can be reproduced by means of a loud speaker on the stage. The main purpose of the playback is not to gauge the quality of the recording from a frequency characteristic standpoint inasmuch as the playback from the wax is inferior because of the wax itself, but to give the director and the artists an opportunity to gauge the results of their efforts. If a line has been spoken incorrectly, or if there is a break in the sound which is unnatural, or if there has been some disturbance which has been inadvertently recorded, the playback will provide instantly information upon which may depend whether or not a retake is necessary. Thus the playback is an extremely important feature of a properly designed sound recording system, not so much because of the technical aspects, but because of the economical value in time and labour saving.

Film Recording Machine.—Sounds are recorded on film by exposing film running at a speed of 90 feet per minute to light variations which are linear with respect to sounds originating in the studio. The electrical energy is delivered from the main amplifier to a device in the film recording machine known as the light valve. This light valve consists of two duraluminum ribbons spaced 2 mils apart which lie in a powerful magnetic field. When current flows through these ribbons they open and close in accordance with the current flowing through them. A source of illumination is provided and the image of the aperture of the ribbon is focused on the film through an optical system having a two-to-one reduction. The normal slit image on the film will therefore be 1 mil in width.

Exposure is a product of intensity multiplied by time. In light valve recording the intensity is constant and time is the variable. With the film running at its normal speed the time of the average exposure is $\frac{1}{18,000}$ second. This exposure with the intensity of light used is satisfactory for recording on positive stock. The tension of the ribbons in the light valve is so adjusted that they will vibrate naturally at about 7500 cycles per second. Due to their extremely low mass the deflections of the ribbons are substantially linear with the current flowing through them over the recording frequency range. The light valve despite the dimensions of the ribbon used is in reality a very rugged device, is not sensitive to jars or vibrations and when properly used does not require fussy adjusting. Light valves have frequently been used for days and weeks without

having the ribbons broken. A valve can be strung, spaced, and tuned ready for use in less than ten minutes and of course there are always sufficient spares available so that a defective one may be replaced in fifteen or twenty seconds.

Film Technic.—For the recording of sound on film we use positive stock. Positive stock is slower than negative stock but inasmuch as our intensity is well within economical limits the use of positive stock has two distinct advantages; it is cheaper and it has a finer grain. In the recording machine the film receives exposures which are in linear relation with the sound by means of the operation of the light valve. In order to obtain satisfactory reproduction in a projection machine this film must be developed and printed in such a way that the transmission of light through the positive will have the same variations as the original exposures of the negative. The photo-electric cell in the reproducing machine will then reproduce electrically the same variations which were used in the film recording machine to operate the light valve.

Ordinarily in photographic work, particularly for screen presentation, light values on the screen are quite different from those in the original picture. Due to limitations in the camera, the emulsion, and in the projection apparatus it is usually necessary for pleasing effects to obtain in screen pictures far greater contrasts than actually exist in the original object photographed.

In the variable density system of sound film recording it is necessary to develop the negative and positive in such a way that the light transmitted through the positive contains the exact relations of the original light to which the negative has been exposed. Here the contrast must be such that a true picture of the recorded light is viewed by the photo-electric cell in the projection machine.

Some means is necessary therefore by which the contrast in development of both negative and positive sound track may be measured. The gauge used is fundamentally a curve first derived by Hurter and Driffield, commonly called an H and D curve. This is a graph which shows for a particular emulsion and development the relation between various exposures and the respective densities. It is characterized by a toe, a linear portion, and a knee corresponding, respectively, to under, correct, and overexposures of the film. When this curve is plotted between density and the logarithm of exposure its slope is our familiar and sometimes much criticized friend gamma. For a given emulsion the slope of this curve will

increase with an increase of development time up to a certain point sometimes called gamma infinity, where further development causes no increase in density. Practically speaking, where the emulsion and the developer are constant, gamma is almost another name for development time.

It is probably not desirable at this time to go into the theory involved but it is sufficient to say that in order to produce satisfactory sound prints the gamma of the negative development should be the reciprocal of the positive development gamma. In other words, the product of negative and positive gamma, sometimes called overall gamma, should be unity. However, gamma determination is not critical; the overall gamma may vary from 0.8 to 1.2 without producing noticeable distortion. Incidentally the effect of improper development results in sound distortion similar to amplifier overloading, that is, it will cause the sound to be muffled or raspy or full of harmonics which were not present in the original.

The measurement of gamma is really a very simple operation. The film is placed in a sensitometer which is nothing more than a suitably diffused light source with a strip of known densities placed between this source and the film to be measured. After exposure and development the densities on the film are measured and properly plotted against the exposure values derived from the known densities in the sensitometer strip. The slope of this curve gives us gamma.

Densities are measured by means of a densitometer and any type giving diffused measurements may be used. A densitometer is simply an instrument which measures the density of a film by measuring the amount of light transmitted through it compared with the light transmitted through air or clear film. If a bath shows too high a gamma the time of development is decreased until the correct gamma is obtained.

As was said before we must treat sound development in a somewhat different manner from picture development but in doing so we do not want to change what is considered the best practice from a picture standpoint. We record sound and picture on different films, but print both sound and picture on the same film. We must, therefore, make our positive sound development conform to present standard picture development practice. All that is necessary therefore is to measure the gamma of a positive developed pictorially and then develop the sound negative to a gamma which is reciprocal. This usually means that the development time for a negative sound

track is somewhat shorter than for a picture negative if the same bath is used. Dependent upon the type of system, developer, and method of control, a different negative bath formula may or may not be required for sound work.

It is of course necessary to have the proper exposure values both for the negative and positive. The exposure of the negative is controlled in the film recording machine while the exposure of the positive is controlled in the printer. It is desirable at all times to work on the linear or straight line portion of the H and D curve. If we have incorrect exposures and operate on the curved portion of this curve, deterioration in quality is likely to result evidenced again in the resultant picture by sounds which appear overloaded and full of harmonics.

However, it is a simple matter to determine the proper exposure values. In the recording machine the negative average exposure is half the maximum since the light valve has a normal opening of 2 mils and, limited by closing, has a maximum opening of 4 mils.

The density corresponding to one-half maximum exposure taken from the linear portion of the H and D curve is the proper density for the unmodulated sound track of the negative and a lamp current in the recording machine which gives this exposure is the correct one to use. Here again, however, this value is not critical as, for example, with too low a lamp current while we keep below the knee of the curve we only sacrifice slightly in volume range with the result that the full use of the emulsion properties is not made.

The proper printer point to use in printing sound track depends again on the emulsion characteristic of the positive and upon its development. In the negative the lamp current was at a point to give average exposure over the straight line portion of the H and D curve. In the positive the printer light is set to give an average density corresponding to average transmission of the positive which for all practical purposes is one-half of the maximum transmission. The maximum transmission corresponds to the density at the lower end of the straight line portion of the H and D curve. If we increase the printer light we usually may continue on the straight line part of the curve before running into the curved knee portion. Hence there is considerable latitude in choosing printer point but it appears desirable from surface noise conditions and other considerations to keep the transmission of the positive somewhere around 20 per cent.

Re-recording.—One of the most important things in connection with

sound film production is that of re-recording and scoring. The apparatus required for this work is essential for the proper production of a finished product. If it is desired, for example, to introduce music or any extraneous noise which it has been economically not feasible to introduce in the original recording, these effects may be added later. To do this it is necessary to re-record from a positive print and at the same time introduce the other desired effects. This must all be done in synchronism and frequently must be accompanied by a picture run in synchronism also. Standard theater projection equipment is not suitable for reproducing the sound for this purpose because too much noise would be introduced. The frequency characteristic of the original film must be somewhat altered for proper re-recording and hence special apparatus must be provided to do a satisfactory job. Whenever effects are added of this kind it should also be done from a monitoring position in a monitoring room so that the true effect from a theater standpoint of what is going on to the film can be observed. From this standpoint the technic is identical with the original recording. As producers frequently release on disks as well as film it is also necessary to provide film to disk re-recording and also in some cases disk to disk re-recording. All of these problems are somewhat different and to produce a satisfactory result must be treated in a different manner. Equalizers are frequently necessary in order that the re-recorded sound will compare favorably with that originally picked up in the studio. Film to disk re-recording is usually made after the picture is finally cut as the sound is recorded on disks in synchronism with the finished picture.

Review Room Equipment.—In order that the producer may gauge his results as he produces a picture it is necessary that he have a suitable review room. As it somewhat simplifies the cutting problem in sound film production to make a separate track for the sound apart from the picture, it is desirable to have review room equipment consisting of a regular picture projector and a projector equipped for sound only, so arranged that they may be run in synchronism. The review room itself should represent as near as possible an average theater and should be equipped with the same type of amplifiers and loud speakers as are used in theater reproduction. The review room is frequently used as a final check on a finished production and should therefore be very carefully considered in its design and in the equipment used.

DISCUSSION

MR. ROWSON: I think you will agree that for a subject of such difficulty, the paper is marked with extraordinary lucidity.

MR. VENTIMELIER: I have heard that in America a wider sound track is used—I think about a quarter of an inch; I would like to ask what would be the effect of the wider sound track and what would be a maximum useful limit for a sound track.

MR. FETTER: As far as quality goes, the width of the sound track has very little to do with it. As for the amplification in the theater, there might be some advantage in having a wider sound track, but as far as I know there is nothing contemplated along that line.

MR. ROWSON: I think you undoubtedly get a purer note altogether on the wider track than on the normal narrow track.

MR. WILLIAMSON: Do you record on disk as well as on film, and if so, is it possible to process the wax after playing it back?

MR. FETTER: We have two wax machines; one record is played back and the other is usually stored for some time in case they want to process the wax. As far as that goes you can process the wax without serious decrease in quality after playing it back once and sometimes more. The records can be kept indefinitely.

MR. VINTEN: Has Mr. Fetter any definite experience in driving the wax record by the aid of gearing, or some such similar method, and would any difficulty be experienced as regards vibrations?

MR. FETTER: In order to eliminate any vibrations in a wax recording machine we drive the wax disks through a rather complicated mechanism comprising a mechanical filter, in such a way that at the actual point of drive on the wax disk itself no flutter is present. Incidentally the same type of drive, somewhat modified, is used in the theater for reproduction.

DR. CLARK: I would like to know whether Mr. Fetter has any experience with the fact that when you develop a patch of high density you get a line of exaggerated contrast at the edge of the image due to local exhaustion of the developer and diffusion of fresh developer into the image area and of exhausted developer away from the image edge. When you are developing your variable density negative does that affect it at all, and if so what effect does it have on the quality of reproduction? If you are using a positive film with a high maximum gamma and you stop development with a low gamma the effect might be pronounced, and I am rather interested to know what influence it has.

MR. FETTER: This is a very interesting point, but we have not analyzed what happens in regard to the effect of steepness of density variations we get in recording. I do believe that such effects may be a difficulty, particularly in recording very high frequencies.

DR. CLARK: Can you reproduce from the negative, or must you make a positive print for reproduction?

MR. FETTER: You can reproduce from the negative but the transmission of the negative results in a frequency spectrum which is quite different from that given by the positive.

DR. CLARK: One hears a lot about the extreme care required in developing the positive sound record to the gamma of one, and that you have got to be very careful in controlling the gamma. I believe there is quite a considerable latitude

in the development of the positive sound track, in fact I believe there is more latitude in the development of the positive sound track than you would tolerate in the development of a picture.

MR. FETTER: I think I said in the paper that the control of the gamma was not so critical as was popularly supposed. I believe the tolerance of 0.8 to 1.2 does introduce a 5 per cent harmonic. Of course, we always like to keep it as near unity as possible. Under practical laboratory conditions, it is difficult to realize the desired theoretical values but the closer we can keep to unity the safer we are. With regard to picture gammas and their variations I do not know enough to guess how far you can go in terms of gamma.

DR. CLARK: I would like to ask Mr. Fetter what experience he has had with other types of emulsion than cine positive.

MR. FETTER: You mean for positive or negative recording?

DR. CLARK: For negative recording.

MR. FETTER: I participated in some experiments in Hollywood in February and March of 1929, in which we made some comparisons between ordinary stock and another stock. That was while Eastman was doing development on the Reprotone stock, and probably the stock we were experimenting with had not reached the final desired stage. At that time I believe that while our measurements and experiments did not carry us to very accurate conclusions—and possibly when making the tests there were variables which we did not consider—there was not a great deal of difference between the two, but that, as I say, was before they had reached the final answer. I do not know what the best emulsions are. In the recording work here we have been sticking to something which we knew we had available and we did not want to hazard a project by introducing experimental emulsions.

MR. WHITEHOUSE: Mr. Fetter has told us that the amplification system of the light valve responds up to 7000 cycles. One thing was not mentioned: What is the net result on the positive print; is there any film transfer loss? Assuming you can get so many cycles on your negative is there any loss in high frequencies in printing, and is there any loss in projection? Do you get 7000 cycles as a commercial result in the theater?

MR. FETTER: We do know there is a film transfer loss. If we apply exposures through the light valve we know that we can record on the film equal amplitudes from the very lowest frequencies up to the neighborhood of 7000 cycles. The film is developed, printed, and projected. We do know that we experience loss only in the high end of the frequency spectrum. We do not maintain that we can put into a theater the exact equivalent of the 6000 to 7000 cycles range that we actually record. Loss may be due to limitations of the emulsion, to reflections and refractions in printing, and there may be other causes. Of course, you can take a single frequency film and actually hear 7000 cycles projected in a regular projecting machine, but that does not tell you anything about its true proportion. I should say that if you can produce in the theater a record which is absolutely flat up to 5000 cycles, in the light of the present art, it would be quite satisfactory. Of course that question is also tied up with the theater and with the position of the horns in the theater. High frequencies are very directional, low frequencies have a habit of spreading out.

MR. EVELEIGH: Mr. Fetter spoke about re-recording from gramophone

record to gramophone record. Do you have any trouble with the needle scratch? Do you use a filter, or do you just record straight away and have some means of cutting out the actual scratch from the one record to the other?

MR. FETTER: That is one disadvantage of disk to disk recording—the needle scratch effect is cumulative. If you filter it you lose the high frequencies originally recorded; if you do not filter it out the needle scratch is going to be present on the record you make. It is possible, however, to find a happy medium.

MEASURING THE EFFECTIVE ILLUMINATION OF PHOTOGRAPHIC OBJECTIVES*

J. HRDLICKA

The photo-chemical action of light on the photographic plate depends on the light intensity and on the length of exposure, other conditions being constant. The brightness of the photographic image is proportional to the square of the ratio of the radius of the entrance pupil to the focal distance, or to the square of the relative aperture, which latter may be expressed by $1/n$, where $n = f/d$ (d is the diameter of the entrance pupil). The illumination afforded by a photographic objective is determined by its relative aperture, on purely geometric considerations. In this expression of the relative aperture, there is no factor expressing the light losses in the lens which decrease the effective illumination of objectives; for example, the losses caused by reflection at the lens surfaces, by absorption in the glass, and by absorption in the cementing material. If we designate by I_0 and I the intensities of illumination before and after passing through the objective, the true, effective brightness of a photographic objective is more accurately given by the expression.

$$\frac{1}{n\sqrt{I_0/I}} \dots\dots\dots (1)$$

To determine $1/n$, the usual methods of measuring focal distance and diameter of entrance pupil may be employed. To determine the value of the correction factor, I_0/I , I have resorted to the following method:

Arrange in optical alignment on an optical bench, a point source of light, the objective to be examined, a diaphragm whose diameter is smaller than the maximum opening of the objective, and the sensitometer. A small hole, illuminated from behind by a lamp, was used as a point source of illumination. This source was placed at the focus of the objective to be examined, after the manner of a collimator. The diaphragm was placed directly in front of the

* *Photo-Revue*, 41 (Sept., 1929), p. 267. Translated from the French by William Vaughn.

first surface of the objective. On the other side, and as close as possible to the objective, was placed the sensitometer with the photographic plates.

I used a non-intermittent sensitometer of my own construction, with a rotating disk. The measurements were carried out as follows: The source being placed at the focal point (of the objective), the distance r_1 from the source to the first surface of the objective is measured. If d_1 is the diameter of the diaphragm and d_2 the diameter of the corresponding exit pupil, calculate r_2 , where

$$r_2 = r_1 \frac{d_2}{d_1} \dots \dots \dots (2)$$

This is taken as a fundamental distance. The diameter d_2 is determined photographically. The source being at the focus of the objective, a reading is taken with the sensitometer, after which the objective is removed and the source is brought to within a distance, Δ of the sensitometer, where

$$\Delta = l - (r_2 - r_1) \dots \dots \dots (3)$$

where l is the total length of the objective; i. e., the distance from the front surface of the first element to the rear surface of the last element. Take the intensity given on the photographic plate by the source in this position as unity. Proceed to take other sensitometric readings with the source nearer and farther away than the distance Δ . Measure the densities produced on the various negatives in a small region containing the optical axis. Draw a curve plotting these densities against the distances from source to sensitometer (with objective removed) and determine, by simple interpolation, the position of the source (without objective) for which the illumination produced on the photographic plate is equal to the illumination given on the plate exposed behind the objective. The value of this distance, which we shall call r , enables us to calculate this illumination by the simple equation:

$$\frac{I}{I_0} = \frac{r_2^{2*}}{r^2} \dots \dots \dots (4)$$

This experimental method has certain advantages. Use is made of a point source and of narrow sensitometric plates (4 mm.), and

*Note: For the sensitometric record made with the lens in place,

$$E = I/r_2^2 \quad \text{see (2)}$$

For the sensitometric record made with the lens removed,

$$E_0 = I_0/r^2$$

$$\text{But since } E = E_0 \quad \therefore I/I_0 = \frac{r_2^2}{r^2}$$

there is no need to take account of corrections depending on the obliquity between the central and marginal rays. The system does not contain, aside from the objective itself, any absorbing material such as a sensitometric wedge or tablet. Monochromatic light may be used, illuminating the hole by means of filtered light, a mercury lamp, *etc.*

Example.—Measurements were made using anti-halation orthochromatic plates, with white light from an incandescent lamp with an opal globe. In the case of a photographic objective of 150 mm. focal length, these results were obtained:

Relative geometrical aperture as given by the maker	$f/4.5$
Relative geometrical aperture from our measurements	$f/4.87$
Effective intensity (equivalent relative aperture)	$f/5.54$

CAMERA MECHANISM, ANCIENT AND MODERN*

ARTHUR S. NEWMAN

My task cannot be completed in the space at my disposal, nor could it properly be accomplished in six times the space. I propose therefore to confine myself to dealing with the essentials of present day cameras, i. e., the feed and take-up sprockets, the take-up tension, and the intermittent motion. To these points I shall particularly direct your attention. The present day camera, with its reversing gear, method of focussing, changing of lenses, diaphragms, fades—hand and mechanical—high speed fittings, speed indicators, air drives, *etc.*, has now become so complicated an instrument, that a book could be written on any one of its features. In the first days of the industry the progress of the moving picture was much handicapped by the want of accurately perforated film, nevertheless the pictures, unsteady and flickering, were, on their introduction, so much of a surprise to the public, that the production of pictures of *any* kind was considered of more importance than the production of good pictures. Money could be made quickly by those in the know, and much more attention was paid to the money-making side of the business than to the technical problems involved in the improvement of the product. I am sorry that after thirty years of work, in many corners here today, the taint still remains. We, in this country, have suffered badly in consequence. Neglect of the technical side was the direct cause of a great portion of the trade going away from this country. May I express the fervent hope that the establishment of this Section of the Society may be an important factor tending to remedy this defect.

I would like at this point to make a statement as to the position I am taking in writing this paper. I was one of the first workers in this country, and know something of the first efforts to produce moving pictures. What I am going to tell you is what I remember. In some of my statements I may not be quite correct, and as my memory recalls most vividly what I myself have tried, I may perhaps miss what others have done. When I express an opinion, please consider it my

* Communicated by the London Section.

own opinion merely. If the capital "I" creeps into my discourse, let me down gently and do not consider that I pretend to have invented everything. I often take up old and almost forgotten books on technical subjects, to see what our forefathers did. In many cases I have found descriptions of old processes and methods, long fallen into disuse, but which could often advantageously be combined with modern practice. A glance at obsolete ideas is, in my opinion, very often useful in starting a new train of thought and investigation.

The camera since its first days, like all other inventions, has undergone many changes in the construction and arrangement of its parts. It has been improved step by step, and still goes on improving. Finality is still a long way ahead. The standard model of today is unlikely to be the standard model ten years hence. The recent arrival of the talking picture has introduced new requirements in the camera. Quiet running and increased taking speed are new problems for the inventor. I propose first to run through the principal changes in camera construction since photographically produced moving pictures were first projected on the screen.

Moving pictures of a kind—not produced by photography—were shown many years before the introduction of film, and others produced by photography, but taken on separate plates exposed one after the other by a series of separate cameras, were shown by Muybridge. I saw these projected at St. James' Hall, Piccadilly, I do not know how many years ago. They were merely silhouettes on a small screen, badly lighted, but were sufficiently wonderful to attract considerable attention. I could tell you of other moving pictures. In the early days of the science, it was usual to employ the same or a similar mechanism, to take the negative and project the positive. After the first pictures were shown at the Empire by Trewey, who had a concession from Lumière, the camera by which they were taken was understood to be almost identical with the projector which produced them on the screen. I saw these pictures and at once set to work to devise apparatus. The details of Lumière's apparatus were kept secret for a time, but soon the particulars leaked out, and the principle became known to several. Before I saw the Lumière camera, I came across a home-made one with which pictures were taken. Mr. Pescheck, then the chief electrician at the Palace Theater, was the designer, and he and his partner, Chard, took many films and gave many shows soon after Lumière's apparatus first appeared in England. I cannot remember which camera I saw first, nor can I recall the exact

mechanism made by Pescheck, but I remember that the Pescheck movement was a modification of the Lumière system.

The next camera in my mind is that of Demény. It employed a film considerably larger than that of Lumière, and stands out in my mind because the intermittent movement was of the beater or dog form, and the mechanism was driven by pulling the film on a take-up spool, to which the driving handle was fixed. To this I will refer later. The Lumière pictures came over from France, and a certain number of films were sold to those who possessed machines or to those who had made them, but the supply was quite inadequate. Immediately the Lumière pictures were shown here, many mechanics went to work to make machines to project these pictures. All sorts of projecting machines were made and there was a rush to get Lumière films.

For some unexplained reason, however, few thought of making cameras, and those who did had difficulty in procuring film and also in perforating it. The Edison Kinetoscope which was a machine into which you looked and saw pictures moving under a magnifying glass, after a year or two of success, had fallen flat in the public mind, and large quantities of these pictures were in the second-hand market. These were eagerly bought by those who had made machines and the machines were altered to take the Edison perforation, which perforation was originally intended to run continuously on a large sprocket, and not designed to work intermittently as we now use it. The great bulk of the machines were consequently altered to the Edison gauge. When at last the demand for pictures increased, the camera makers made their instruments to deal with the perforation suitable for use in the projectors taking Edison gauge. The Edison Kinetoscope films were for the most part very dense; it was difficult to get enough light through them, and having been photographed at the rate of 30 to 40 per second, they gave a moving picture certainly, but a very slowly moving picture. So great, however, was the public interest at the time, that a show having twelve pictures, each 75 feet long, could command money, and not only money but good money.

I have seen a room not so big as this absolutely filled. You paid a shilling to go in and see half-an-hour of pictures and came out satisfied. The pictures were bad, jumping was bad due to the projectors being bad, the light was bad due to the density of the films. The usual thing was for the show to run a certain distance and then the picture would jump all over the place. The manager would come out and apologize

and would say, "If you will kindly keep your seats for a minute or two, the matter will be rectified." Robert Paul was one of the pioneers and his show at the Alhambra attained some measure of fame. He sent his operators abroad and obtained some very interesting matter. One of his pictures showed a rough sea breaking into a cave; to get this he had sent to Spain. His camera had a Maltese cross movement, and his projector had two Maltese cross-driven sprockets. About this time I was approached by Blair and Dando to make them a camera on a new patent system brought by Blair from America. Mr. Blair was, I believe, the founder of the Blair Film Camera Co. There was a suggestion among the directors of the Palace Theater at the time, that they must have moving pictures somehow or other. Paul working at the Alhambra was not available, and there was nobody else competent to deal with the matter.

The camera brought by Blair and Dando was a modified form of beater movement, and had a reciprocating shutter. It was a very inefficient idea, and I modified it and added pilot pins. I did not invent the pilot pin system; it was suggested to me by one of my workmen named Woodhead, but I believe this was the first time the pilot pin system was used to ensure registration in the camera. The film used was a large one, about the same size as that used by Demény, and the effect was good, so I am told, but I never saw it in operation. Prices were different in those days. I made a perforator, a camera, and a projector, and the price was a little over £100. Differences arose between the partners and the whole matter was allowed to drop. I should much like to find one of those machines to add to my collection.

The next machine in my list is the Biograph, the most colossal apparatus ever made, and the largest machine ever used commercially. The intermittent movement of this depended on the broken roller system. It was invented by Hermann Casler, whose name has appeared so many times since in the patent records. Pictures from this machine were a great feature in the program at the Palace Theater for some months, and people thought that at that time finality in moving pictures had been attained. The pictures were very fine and large; the screen covered the proscenium opening of the Palace stage. In addition to using the large film, the pictures were taken and shown in the neighbourhood of 40 per second, so a tremendous amount of film was used. The film was not driven by perforations, but perforations were afterward added in the camera for the purpose of print-

ing. The registration on the screen depended upon the skill of the operator, and the condition of his nerves at the time. The show, however, was usually a very fine one.

I propose to divide the evolution of the camera mechanism into three periods, and the cameras, to which I have alluded, belong to the first period. I will now run through and describe the salient points which characterize their mechanisms. The original Lumière movement was, I believe, an ordinary eccentric. This and several cameras of contemporary date were constructed to deal with lengths of film of only 75 feet; they had neither feed nor take-up sprockets. The film was pulled from the top roll direct to the intermittent movement, or, to minimize the shock, over a spring roller, and after exposure was allowed to fall loose into a light-tight bag or box. This made the apparatus unwieldy and the take-up mechanism was added, at first with no sprocket. The camera of Chard & Pescheck was the first example to come to my notice as possessing means of rerolling the film. The introduction of take-up rolls minus sprockets proved detrimental to the steadiness of the picture, because as the roll became large and the weight greater, swing and vibration caused jerks on the film which tended to accelerate its movement through the gate. Lumière showed a fairly steady picture, only deflected at times by the extra stress which was produced by the resistance of the top roll, or the taking up of a length of film which had jerked loose.

After Lumière, the pictures became very unsteady, and earned the name of "The Jumpers," which they well deserved, but public interest was still to an extent maintained. Perforation was inaccurate and the cameras were badly made and badly designed, and sprockets for the most part were absent. Quite early in this period, when projectors were first made, Messrs. Haydon and Urry of Islington introduced a movement to which I shall allude later. Moy was also at work and made films contemporary with Paul. I did not manage to see the Moy camera so I cannot say what the first movement was like.

We now come to the second period in which the claw mechanism took the lead. It is difficult to make any exact line of demarcation between these eras because the Lumière movement might be called a claw movement. There were several mechanisms that possessed features somewhat similar, and the only way I can exactly describe them is by pointing out that crank and link movements to a great extent took the place of slides and cams. I was early in the field with a claw movement, which had only pin joints in its construction.

Darling, Williamson, Prestwich, and Proszinski are some of the names associated with what I designate the claw movement.

Darling used a claw which was driven by two equal cog-wheels geared together and consequently running in opposite directions. To a crank on one of the wheels a claw was pivoted and a prolongation from the bar of the claw carried a curved slot in which a crank pin on the other wheel rotated and traversed from end to end. The combination of movements produced the **D** shaped path through which the claw pin travelled.

Williamson's movement had only one crank which was pivoted to the end of the claw rod. About the middle of the claw rod was a curved slot which slid on a fixed pin and the claw was caused to take a **D** shaped path.

In the Prestwich movement the claws themselves were fixed on separate springs, and, had the springs not been stressed at one part of the movement, the claws would have described an oval path; a flat plate was provided just above the film, against which the springs pressed when they entered the film and following the direction of the plate the under part of the oval was altered into a straight line, thus forming a **D**. These three movements were not pure pin joint movements as they all contained slides.

Proszinski about this time patented a claw movement to some extent like Williamson's but in place of the slide working at the middle of the claw bar, a rocking link caused the middle of the bar to follow a path comparable to that of Williamson's movement. The form of the **D** produced could not be made quite so perfect but was sufficiently accurate to drive the film efficiently. This was a true pin joint movement having no cams or slides.

The two sprockets and the tension take-up had now become general in cameras, and the lengths of film usually accommodated were from 100 to 200 feet. Perforation had improved to a great extent, but had not reached our present pitch of accuracy, and although the steadiness of the picture had improved considerably, the condition was not what we, at the present time, call steady. About this time the pilot pin was added to the perforator and, for the first time in the history of moving pictures, we had steadiness. Celluloid is a very unstable substance as we all know. Before the addition of the pilot pin to the perforator, considerable variation in pitch resulted. This, combined with the fact that there was no recognized standard, either of width of film, size or shape of perforation, or distance apart of perforations

measured across the film, led to continuous trouble among users and makers of film or of pictures. Then an attempt was made to bring the different ideas of users into line, with very little success. The battle of the gauges lasted many years, and is not quite settled at the present time, but so near an agreement has been arrived at that little difficulty now remains, and mechanism of the highest accuracy can now be designed with the certainty that the film is sufficiently accurate in its manufacture to work in connection with the most accurately made mechanism. This was not possible before the pilot pin became an integral item in the construction of the perforator.

We now arrive at what I call the third or accurate stage of camera construction. It was about the second part of the claw era that the pilot pin was added to the perforator; indeed, three-quarters of the way through the claw era, the pictures were not steady. All at once from Pathé came a series of steady pictures and everybody was very much surprised; this result was attained by the addition of the pilot pin to the perforator. Then came the battle of the gauges; we began to fight among ourselves as to whether we should have long gauge or short gauge, and to dispute as to the shape of the perforations and for years the industry suffered very considerably in consequence, but at last we have settled down, so that, although we are not in exact agreement, we are reasonably near to it, and can with confidence place an accurate mechanism in the camera and be sure of obtaining film sufficiently correct in gauge and dimension.

Celluloid, as I have before mentioned, is a very unstable substance. It is affected by heat, by development, by quick drying, in fact, by a thousand and one things; nevertheless we have got the film down to such a stage that it is possible to run it on a pilot pin fitted within $\frac{1}{1000}$ th of an inch limit. This third stage is characterized by the reduction in the size of the apparatus, due to the placing of the feed and take-up boxes side by side, or by the addition of magazines to a comparatively small box which contains the mechanism, or by arranging the two rolls so that the space taken up by the feed roll is to some extent utilized by the take-up roll, as the feed roll becomes smaller.

Now I am about to place before you some of my own ideas as to camera construction in the future. Perhaps the most important point concerns the pilot pin and whether one ought to have the pilot pin fixed or moving. There is no doubt in my mind that the fixed pin is the most reliable. Pins which slide become loose in their fitting and registration suffers accordingly. I am expressing here my own

opinion which I have formed after many years of consideration. The next point is the gate. In a great many cameras, the pressure of the gate has been the factor in bringing the film to rest, because in most cases the driving pins have not exactly fitted the perforations. Lately we have been getting perforations to which we can make pins exactly fit; but pins so made are liable to rapid wear. The method of moving the film is, however, the most important item. Individually I have a considerable objection to eccentrics or cams, and also to slots or slides of any kind. Pin joints in my opinion are the only rational means of converting rotation into reciprocation, and when we can design a movement having only pin joints in its construction, we shall have the ideal camera movement as far as the driving item is concerned.

It may be well to state here the reason for my objections to cams and slides. In the case of a cam which rotates against a more or less flat surface, to insure complete and continuous lubrication is somewhat difficult. The same objection applies in a lesser degree to slides. Dirt, dust, and grit, like the poor, we always have with us, and it is extremely difficult to guard against contamination of the sliding surfaces. As a cam rolls round it continually meets new parts of the surface against which it works and in many cases particles of matter become wedged and form a more or less efficient ball clutch. The same objection applies in a lesser degree to slides. When a cam becomes in the slightest degree worn, its action is necessarily characterized by back-lash and consequent noise. A slide does not suffer in exactly the same way, but as it travels *twice* over the middle positions, for each time it reaches either end position, it is liable to wear loose at the middle part and, if the wear be taken up, to wedge at the ends. This may be overcome almost completely by making it overrun its fitting position at each end of the stroke. Many camera movements depend on slides and these work very well if properly designed and fitted.

Sprocket trouble is not so prevalent as it used to be; in fact, with present day film, sprocket trouble seldom occurs. When the gauge varied, I got over sprocket trouble by a method which could be well followed now. I made the diameter of the sprocket somewhat smaller than normal, but with rather long teeth. I employed a shield instead of rollers, and placed this shield at such a distance from the sprocket as to allow the film considerable play. The effect was that when the film was short in gauge, it automatically set itself near to

the solid part of the sprocket, and, when long in gauge, it set itself to a greater distance from the center. Long, short, and medium gauge film would run equally well on such a sprocket.

Let us now look at the take-up tension. Of all the camera failures which occur in studios, I think I am correct in saying four-fifths are due to the camera refusing to take up. Spring bands are very nice for driving, but spring bands allowed to slip and so produce tension are an anathema to me. A spring band used in this manner probably works well when sent out of the workshop. In a short time, it and the reel on which it slips become polished and the tension drive, in consequence, falls to one-quarter of what it was originally. To remedy this a piece has to be taken from the band, and the tension increased, but the driving movement on the slipping wheel does not bear any definite relation to the tightness of the band, the governing factor being the condition of the slipping surfaces. In my opinion a separate tension device, easily adjustable for strength, should always be provided on any machine which has to take up a roll of film; otherwise when a tension band becomes thoroughly polished, the pressure necessary to give the required drive pulls the spindles of the two wheels so tightly against their bearings that the lubrication is frequently forced out and seizing takes place. When spring bands are used they should be run on the largest possible pulleys and not allowed to slip, and a separate adjustable tension device should be provided.

Now, finally, I will predict that the moving picture camera of the future will be one in which the film runs free during its moving period, is held by a fixed pilot pin during its stationary period, and that its intermittent movement, of whatever design, will be characterized by the fact that it contains neither cams nor slides, but is driven solely by pin joints, the bearings of which can be easily made adjustable, to compensate for wear. Gate friction will be extremely light or non-existent, and film will be guided only on its edges during its period of movement.

DISCUSSION

MR. ROWSON: Mr. Newman has shown us that he has lived through all the stages of the development of motion picture cameras. He has been intimate with all the difficulties to be overcome; he has helped very materially in overcoming them, and he is therefore a very competent person to appreciate and to criticize, and also to prophesy about the future. It is only a matter of great regret that time has prevented him expanding the subject to the lengths of which he is capable, and explaining even further to some of us his ideas about the future of the camera. It is very extraordinary, indeed, but he had discovered

that we are somewhere now where we were twenty-five or thirty years ago. Of course the difficulties which he showed us had to be overcome were not so much difficulties in mechanism but difficulties in material with which he had to deal.

MR. HODGSON: We have not yet received or had a camera which is what is known as a swing-back camera for taking tall buildings. I have often wondered why we do not at least make some attempt to put a swing-back gate in a cinematograph camera. Why it has not been done is more than I can understand.

MR. NEWMAN: As to the swing-back camera, I am of the opinion that a swing back is hardly required at all, but the rising front to the camera can be very useful. I put a rising front to the first camera I made thirty years ago, and have put rising fronts to many since then. My opinion is that the swing back would be very much more difficult, and there does not seem to be a call for it. However all these things can be produced when required. I was speaking to a man only the other day who mentioned the same thing. He said, "Cannot you possibly make something so that we can correct odd lines?" I told him we would give him a rising front and a swing of the lens and he would be able to correct anything he chose. I do not think the swing back is any advantage at all. In order to correct distortion you do not need the swing, you merely need to drop your mask or raise the lens.

MR. VINTEN: There appears to be a fair amount of mud thrown at the film stock, but I think it ought to be known that Mr. Newman has done as much as anybody in this country to correct that.

MR. NEWMAN: A question was asked concerning the merits of the single claw movement. With a single claw you could get a steady picture. Inertia and momentum are the bugbears we have had to fight against all the time, so in order to be able to reduce the weight of the reciprocating part to its lowest possible amount, I used one claw.

MR. SADLER: Mr. Newman expressed the opinion that he thought in cameras of the future there would be a rise and fall gate. In the case of talking films the camera has got to be quiet. Perhaps Mr. Newman will tell me how the future camera will get over the question of noise, because however the noise question is met, you have still got to get over the question of air displacement. My prophesy is perhaps a little advanced, perhaps not. My point of view is that Mr. Newman is certainly right in the fixed registered pilot pin. If you do not use the shutter you cannot use the registered pin. I dare say it is possible to get over the question of the shutter and the registered pin, but I think the fixed aperture in the camera will be the thing for some time to come. As for a prediction, I think the fixed aperture gate with moving registered pin and some form of pin link motion, which has no eccentric or running slide, which do pick up dirt, will be used.

MR. BUCKNALL: We have been experimenting recently with the question of the noise caused by air compression, which of course does take place when the shutter movement is used, and by suitable methods we have decreased that noise, but what noise remains is still objectionable.

MR. VINTEN: I heard a Newman camera and I think if anybody tries that out they will find it is quiet running. When I heard it, it was about four feet from the microphone and we could only just hear the running of the camera.

MR. RAYMOND: I would like to pay a tribute to Mr. Newman's memory, for he has covered the ground very well, but there are one or two things which ought to be corrected. Regarding the first show, the first place in London where Lumière's first machine was exhibited as a commercial proposition was at the Polytechnic.

Mr. Newman mentioned Chard's machine. He had seen the mechanism of Lumière and went away and instead of having one hole per picture he used four holes. He remarked that some of the old showmen made a lot of money; that is flatly wrong. There might have been one or two who did, but most of them lost money. When we got the first rotary projector, that was the first thing that was very good for the exhibitor. Then America sent us over the cowboy films and we were able to make money.

STANDARDS ADOPTED by the SOCIETY OF MOTION PICTURE ENGINEERS

DIMENSIONAL STANDARDS

1. Dimensions of Newly Cut and Perforated Film.

a. *Standard 35 mm. negative film*

The dimensions for this material are shown in Chart 1.

b. *Standard 35 mm. positive film*

The dimensions for this material are shown in Chart

2. It will be noted that two forms of perforation may be used with this material, both forms being recognized as standard by the Society.

c. *Safety standard 28 mm. positive and negative film*

The dimensions for these materials are shown in Chart

3.

d. *Standard 16 mm. positive and negative film*

The dimensions for these materials are shown in Chart

4.

2. Frame Line.

a. *Standard 35 mm. film*

The frame line shall be half way between two successive perforations on each side of the film.

b. *Safety standard 28 mm. film*

The center of the frame line shall pass through the center of a perforation on each side of the film.

3. Film Splicing Specifications.

Standard dimensional specifications for the making of film splices for laboratories and exchanges are given in Chart 5.

4. Lantern Slide Mat Opening.

3.0 inches (76.20 mm.) wide by
2.25 inches (57.15 mm.) high.

5. Motion Picture Projector Sprockets.

a. *Take-up sprocket*

The take-up sprocket, which is a hold-back sprocket on a motion picture projector, should be designed to have the same pitch as the perforations on film which has shrunk to the maximum amount occurring in films of commercially useful condition as supplied by exchanges. This value of shrinkage is taken as 1.5%, and the dimensions of the standardized take-up sprocket are computed accordingly.

The essential dimensions are: Base diameter 0.9321 inch (23.67 mm.). Tooth thickness (at base) 0.050 inch (1.26 mm.).

Other dimensions of the standard take-up sprocket are given in Chart 6.

b. *Intermittent and feed sprockets*

The intermittent and feed sprockets should be designed to have the same pitch as the perforations on newly processed film which is 0.13% less than the pitch of newly cut and perforated film (see Charts 1 and 2).

The dimensions of the standard intermittent and feed sprockets are computed to conform to these requirements.

The essential dimensions are: Base diameter 0.9452 inch (24.01 mm.). Tooth thickness (at base) 0.050 inch (1.26 mm.).

Other dimensions of the standard intermittent and feed sprockets are given in Chart 7.

6. Dimensions of Motion Picture Projection Aperture.

a. *Standard 35 mm. film*

Width 0.9060 inch (23.01 mm.).

Height 0.6795 inch (17.26 mm.).

b. *Safety standard 28 mm. film*

Width 0.748 inch (19.00 mm.).

Height 0.551 inch (14.00 mm.).

7. External Diameter of Projection Lenses.

a. *No. 1 projection lens*

External diameter of lens barrel $2\frac{1}{32}$ inches (51.59 mm.).

b. *No. 2 projection lens*

External diameter of lens barrel $2\frac{25}{32}$ inches (70.65 mm.).

8. 16 mm. Feed Sprockets.

The dimensional standards relating to this element are shown in Chart 8. It should be noted that dimensions are given relating to sprockets having 5, 6, 7, and 8 teeth, and also dimensions relating to these sprockets when designed for 2, 3, and 4 teeth in contact with the film.

9. 16 mm. Take-Up (Hold-Back) Sprockets.

The dimensions are shown in Chart 9.

10. 16 mm. Combination (Feed and Take-Up) Sprockets.

The dimensions are shown in Chart 10.

11. 16 mm. Camera and Projector Apertures.

The dimensions are shown in Chart 11.

12. 16 mm. Splices.

The dimensions are shown in Chart 12.

13. Width of Film Track in 16 mm. Cameras and Projectors.

A clearance of 0.005 inch (0.13 mm.) shall be allowed in the construction of the film track in cameras and projectors using 16 mm. film. The standard cutting width (see Chart 4) is 16.0 mm. (0.62992 inch). This dimension is the upper limit and gives

Width of film track = 16.13 mm. (0.63492 inch).

14. Taking Speed, Standard 35 mm. Sound Pictures.

This shall be 24 pictures per second.

15. Projection Speed, Standard 35 mm. Sound Pictures.

This shall be 24 pictures per second.

16. Scanning Line.*a. Position relative to picture aperture*

The scanning line (for combined sound and picture on 35 mm. film) shall be located at an average distance of 14.5 inches measured along the film below the center of the picture gate.

b. Transverse position relative to the guided edge of positive film

The position and dimensions of the scanning line shall be as shown in Chart 13.

17. Sound Track.

The location and width of the sound track on combined sound and picture positives shall be as shown in Chart 14.

ADOPTED DEFINITIONS

1. Number of Teeth in Mesh.

The number of teeth in mesh with the film (commonly referred to as "teeth in contact") shall be the number of teeth in the arc of contact of the film with the drum of the sprocket, the pulling face of one tooth being at the origin of the arc, as shown in Chart 15.

2. Safety Film.

The term "Safety Film," as applied to motion picture materials, shall refer to materials which have a burning time greater than ten (10) seconds and which fall in the following classes: (a) support coated with emulsion, (b) any other material on which or in which an image can be produced, (c) the processed products of these materials, and (d) uncoated support which is or can be used for motion picture purposes in conjunction with the aforementioned classes of materials.

The burning time is defined as the time in seconds required for the complete combustion of a sample of the material 36 inches long, the determination of burning time being carried out according to the procedure of the Underwriter's Laboratory. This definition was designed specifically to define Safety Film in terms of the burning rate of the commercial product of any thickness or width used in practice. The test of burning time, therefore, shall be made with a sample of the material in question having a thickness and width at which the particular material is used in practice.

RECOMMENDED PRACTICE

1. Aperture Size.

The existing ratio of 3 to 4 between height and width of picture should be retained when introducing any new size of film.

2. Leaders and Trailers.

These should be opaque with markings embossed on them. In a multiple reel story each trailer and the leader immediately following should be marked with the same title.

3. Thumb Mark.

The thumb mark on a lantern slide should be located in the lower left-hand corner next to the reader when the slide is held so that the slide can be read normally against the light.

4. Take-Up Pull.

This should not exceed 15 ounces at the periphery of a 10 inch reel, or 16 ounces on an 11 inch reel.

5. Projection Lens Height.

The standard height from the floor to the center of the projection lens of a motion picture projector should be 48 inches.

6. Projection Angle.

This should not exceed 12 degrees.

7. Standard Observation Port.

This should be 16 inches (40.6 cm.) square with its center 5 feet 3 inches (160 cm.) above the floor when the projection angle is zero, the center of the aperture to be lowered 1 inch (25.45 mm.) for each one degree drop in angle of projection.

8. Projector Speed.*

The standard practice should be the projection of 80 feet of standard film per minute with a maximum of 85 feet and a minimum of 75 feet.

9. Camera Cranking Speed.*

A camera taking speed of 60 feet of standard film per minute with a minimum of 55 feet and a maximum of 65 feet should be used when normal action is desired, in connection with the Society of Motion Picture Engineers' recommended practice of 80 feet per minute projection speed.

* For 35 mm. silent pictures.

10. Projector Lens Mounting.

The projector lens should be mounted in such a manner that light from all parts of the aperture shall have an uninterrupted path to the entire surface of the lens.

11. Projection Lens Focal Length.

The focal length of motion picture projection lenses should increase in $\frac{1}{4}$ inch steps up to 8 inches and in $\frac{1}{2}$ inch steps from 8 to 9 inches.

12. Projection Objectives, Focal Markings.

Projection objectives should have the equivalent focal length marked thereon in inches and quarters and halves of an inch, or in decimals, with a plus (+) or minus (-) tolerance not to exceed 1% of the designated focal length also marked by proper sign following the figure.

13. Leaders for Sound-on-Film Positive.

Manufacturers of sound film should place a leader on each roll of film on which is designated the framing of the picture and the corresponding sound.

14. Projector Apertures for Sound-on-Film Practice.

The Society approves the proposals of the joint committee of the Academy of Motion Picture Arts and Sciences, Technicians' Branch, the American Society of Cinematographers, the Pacific Coast Section of the Society of Motion Picture Engineers, and the American Projection Society relative to practice in the photography and projection of sound-on-film, which is as follows:

"WHEREAS, Investigation has revealed wide variance in theater projection practices and that there is no effective standard aperture for projection of sound-on-film talking motion pictures;

"*Be it resolved:* That as a temporary measure this committee recommends that all studios and cinematographers using sound-on-film methods make marks on the camera ground glass equally spaced from the top and bottom in addition to the mat mark for the sound track; these marks to delineate a rectangle 0.620 by 0.835 inch in size and that

all vital portions of the picture be composed within these limits;

“Be it also resolved: That the committee further recommends that theaters which make a practice of reestablishing the full screen proportions from sound-on-film pictures do so by the use of an aperture whose size would be 0.600 by 0.800 inch on the basis of projection on the level, the horizontal center of the aperture coinciding with the horizontal center of the S. M. P. E. standard aperture.”

STANDARD 35^M/M NEGATIVE FILM

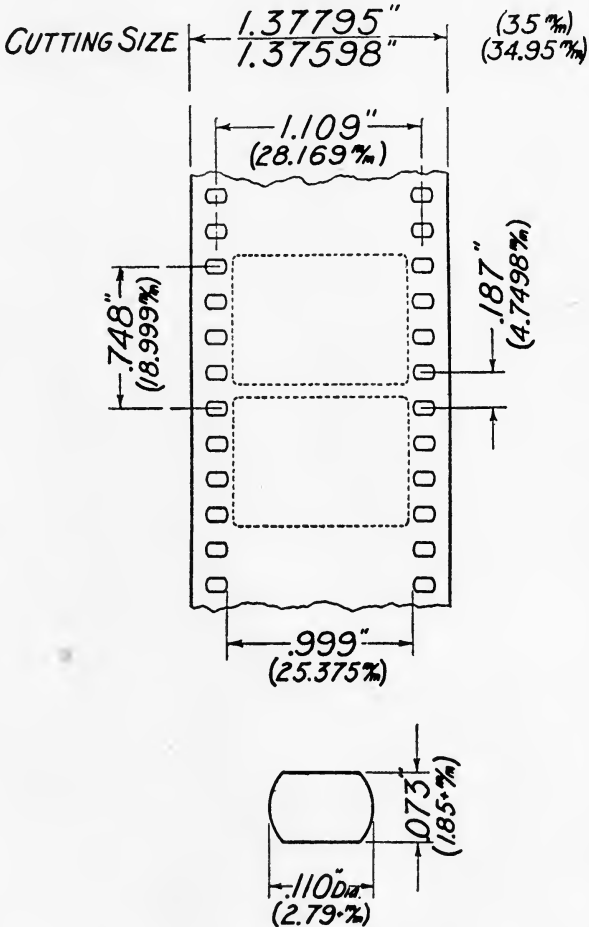

CUTTING & PERFORATING SIZE.

CHART 1

STANDARD 35^M/_M POSITIVE FILM

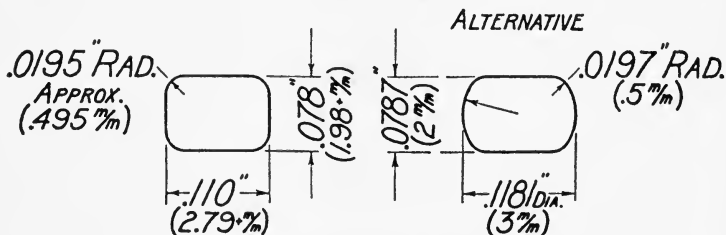
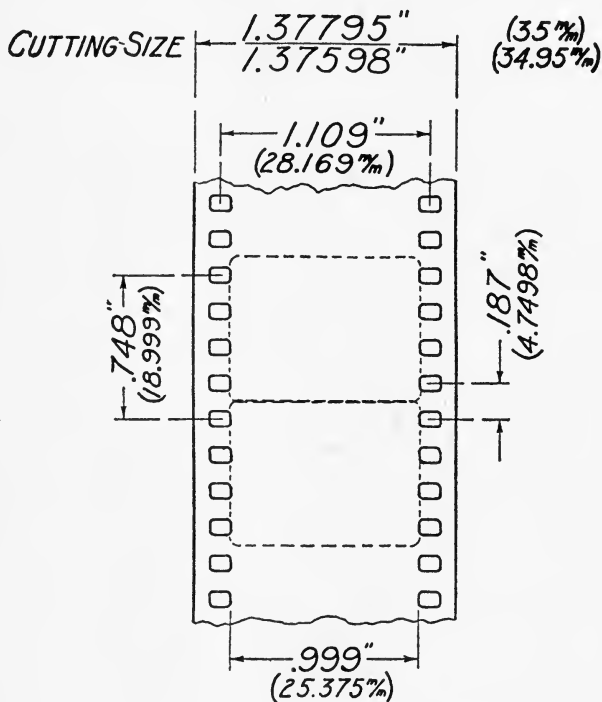

CUTTING & PERFORATING SIZE.

CHART 2

SAFETY STANDARD
28^M/M POSITIVE & NEGATIVE FILM

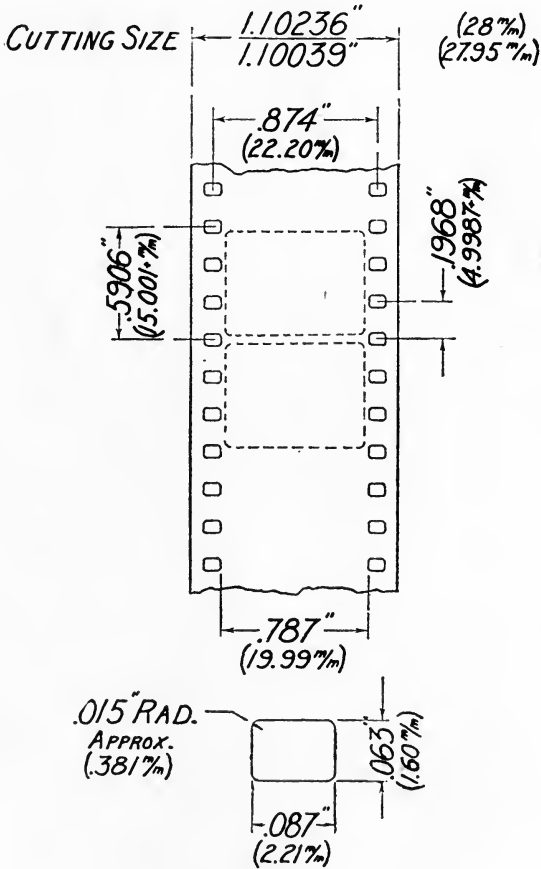

CUTTING & PERFORATING SIZE.

CHART 3

STANDARD 16^M/_M POSITIVE & NEGATIVE FILM

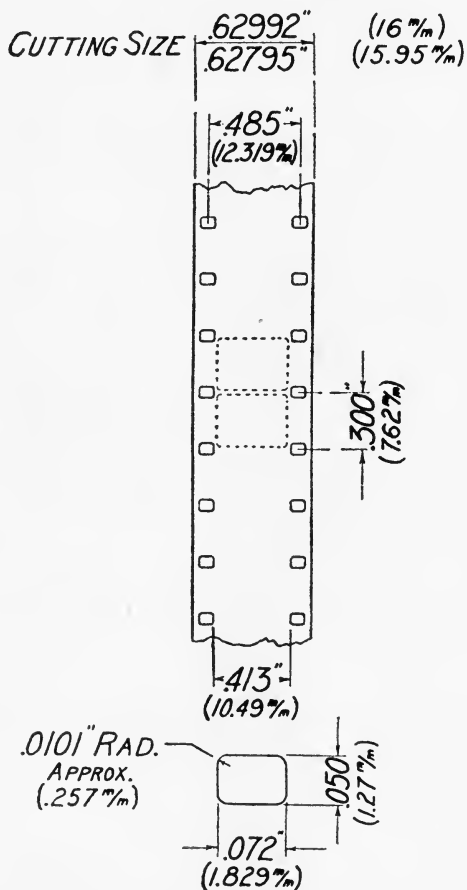

CUTTING & PERFORATING SIZE.

CHART 4

NEGATIVE & POSITIVE SPLICES

NEGATIVE SPLICE

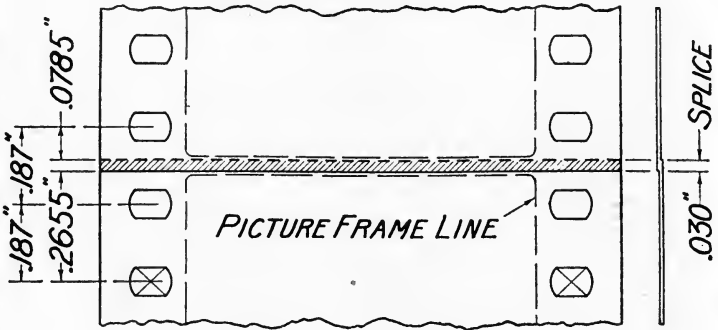

FULL HOLE POSITIVE SPLICE

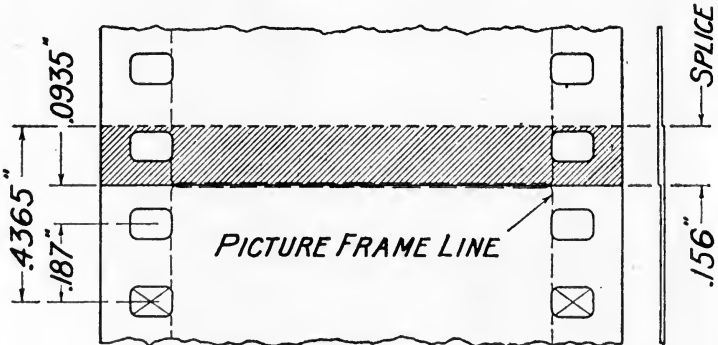

CHART 5

TAKE-UP (HOLD-BACK) SPROCKET

16 TEETH

35^m FILM

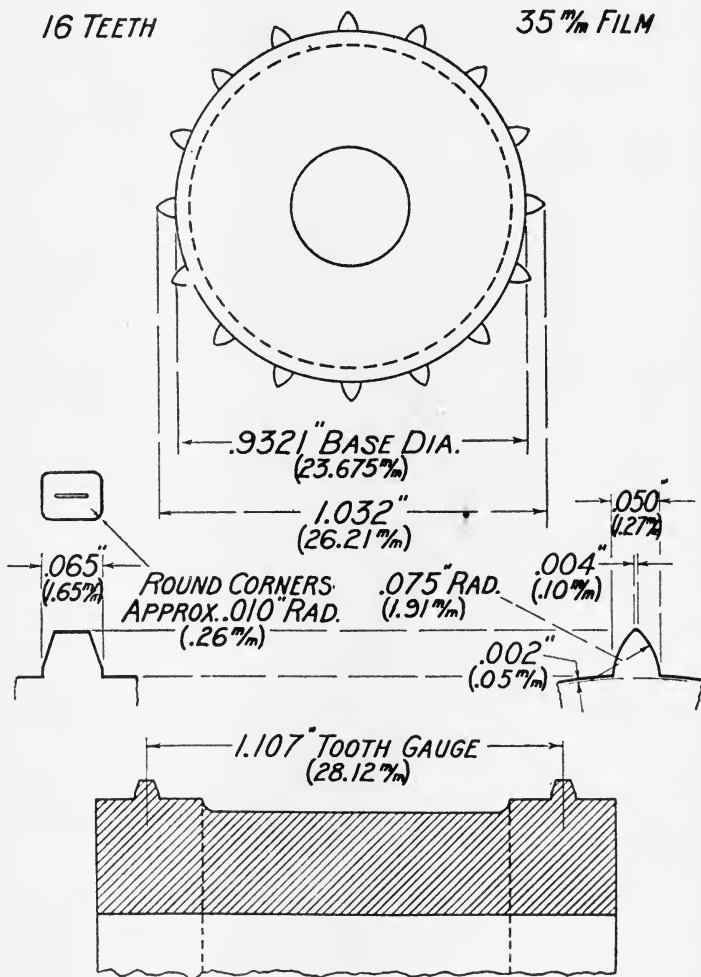

CHART 6

INTERMITTENT AND FEED SPROCKETS

16 TEETH

35^m FILM

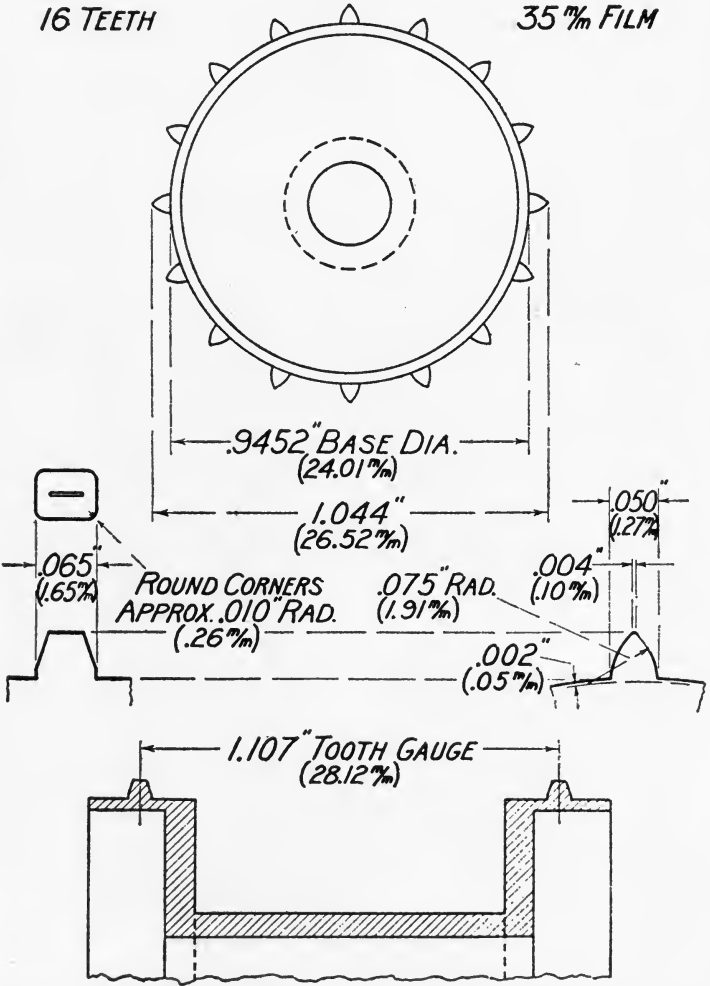
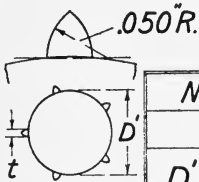

CHART 7

16^M/_M FILM
STANDARDIZED SPROCKET SIZES

FEED SPROCKETS



No. SPROCKET TEETH	NUMBER OF TEETH IN CONTACT WITH FILM.								
	2			3			4		
	D'	t	RANGE 0 TO MAX.	D'	t	RANGE 0 TO MAX.	D'	t	RANGE 0 TO MAX.
INCHES	INCHES	SHRINKAGE	INCHES	INCHES	SHRINKAGE	INCHES	INCHES	SHRINKAGE	
5	.4714	$\frac{.039}{.040}$	0 1.54%	.4714	$\frac{.034}{.035}$	0 1.57%			
6	.5669	$\frac{.039}{.040}$	0 1.54%	.5669	$\frac{.034}{.035}$	0 1.57%	.5669	$\frac{.030}{.031}$	0 1.52%
7	.6624	$\frac{.039}{.040}$	0 1.54%	.6624	$\frac{.034}{.035}$	0 1.57%	.6624	$\frac{.030}{.031}$	0 1.52%
8	.7579	$\frac{.039}{.040}$	0 1.54%	.7579	$\frac{.034}{.035}$	0 1.57%	.7579	$\frac{.030}{.031}$	0 1.52%

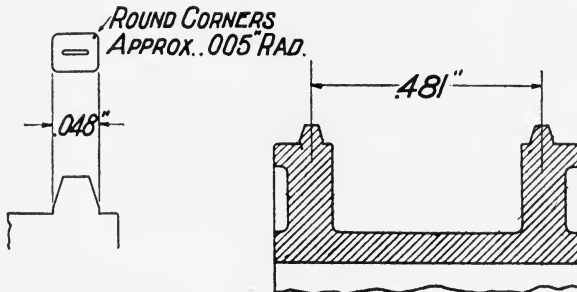
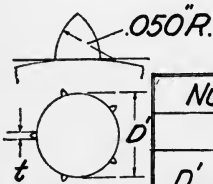

CHART 8

16^M/_M FILM STANDARDIZED SPROCKET SIZES

TAKE UP (HOLD BACK) SPROCKETS



No. SPROCKET TEETH	NUMBER OF TEETH IN CONTACT WITH FILM								
	2			3			4		
	D'	t	RANGE	D'	t	RANGE	D'	t	RANGE
	INCHES	INCHES	SHRINKAGE	INCHES	INCHES	SHRINKAGE	INCHES	INCHES	SHRINKAGE
5	4643	.037 .038	0 1.50%	4643	.031 .032	0 1.50%			
6	5584	.037 .038	0 1.50%	5584	.031 .032	0 1.50%	5584	.030 .031	0 1.50%
7	6524	.037 .038	0 1.50%	6524	.031 .032	0 1.50%	6524	.030 .031	0 1.50%
8	7464	.037 .038	0 1.50%	7464	.031 .032	0 1.50%	7464	.030 .031	0 1.50%

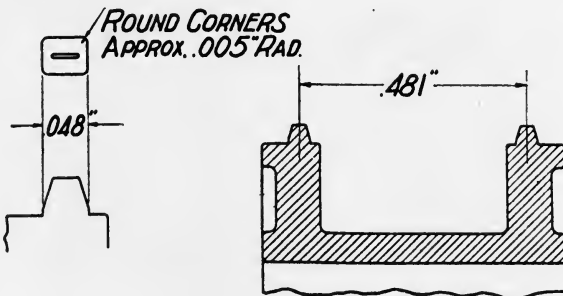
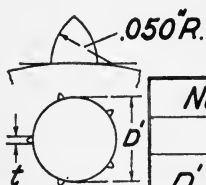

CHART 9

16^M/_M FILM STANDARDIZED SPROCKET SIZES

COMBINATION SPROCKETS



No. SPROCKET TEETH	NUMBER OF TEETH IN CONTACT WITH FILM.								
	2			3			4		
	D'	t	RANGE	D'	t	RANGE	D'	t	RANGE
INCHES	INCHES	SHRINKAGE	INCHES	INCHES	SHRINKAGE	INCHES	INCHES	SHRINKAGE	
5	469/	$\frac{.042}{.043}$	0 1.53%	469/	$\frac{.039}{.040}$	0 1.52%			
6	564/	$\frac{.042}{.043}$	0 1.53%	564/	$\frac{.039}{.040}$	0 1.52%	564/	$\frac{.036}{.037}$	0 1.52%
7	659/	$\frac{.042}{.043}$	0 1.53%	659/	$\frac{.039}{.040}$	0 1.52%	659/	$\frac{.036}{.037}$	0 1.52%
8	754/	$\frac{.042}{.043}$	0 1.53%	754/	$\frac{.039}{.040}$	0 1.52%	754/	$\frac{.036}{.037}$	0 1.52%

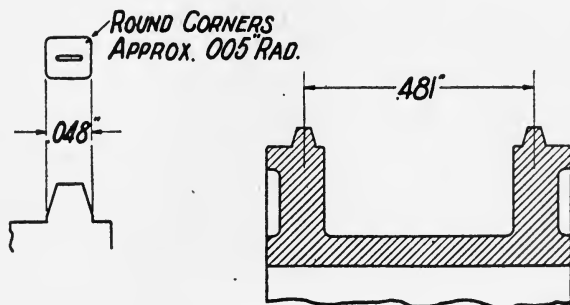
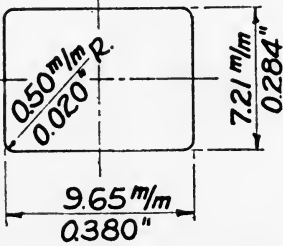

CHART 10

STANDARD 16^M/M APERTURES

PROJECTOR



CAMERA

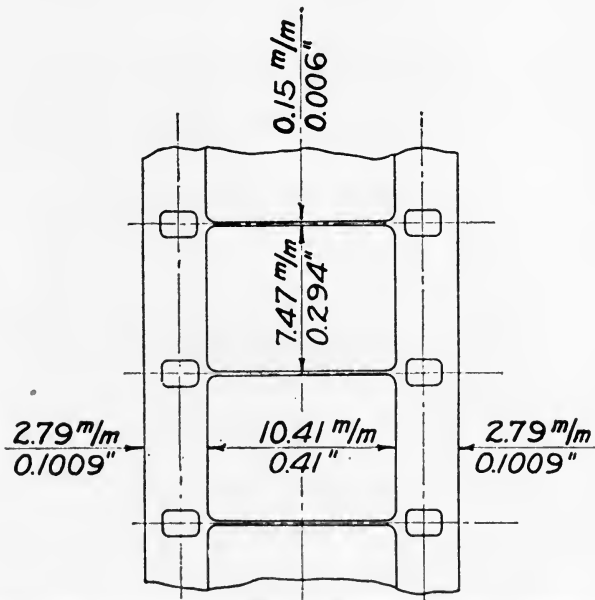
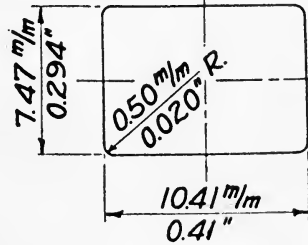
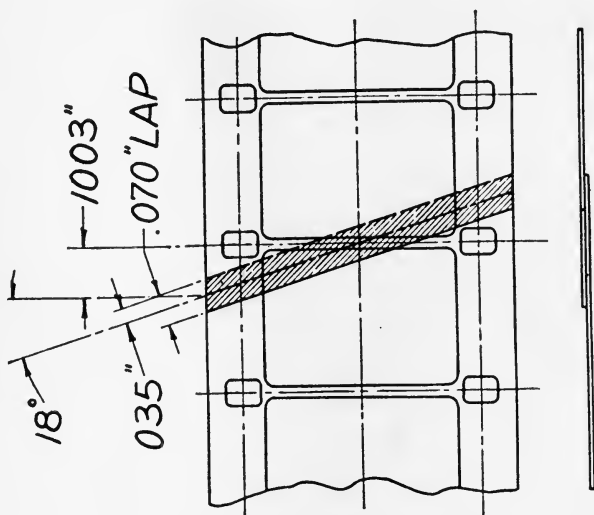

CHART 11

16^M/_M FILM SPLICES
 DIAGONAL SPLICE



STRAIGHT SPLICE

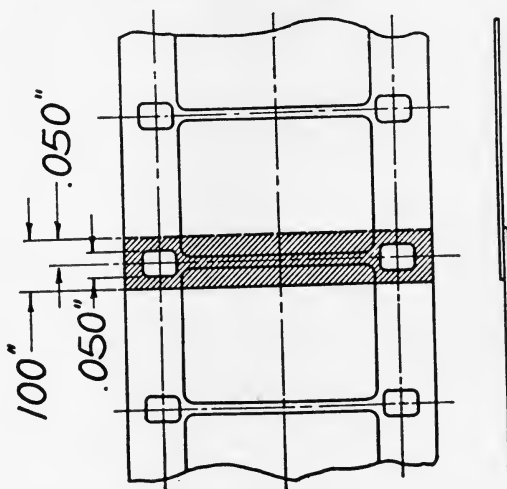

CHART 12

POSITION AND DIMENSION OF SCANNING LINE

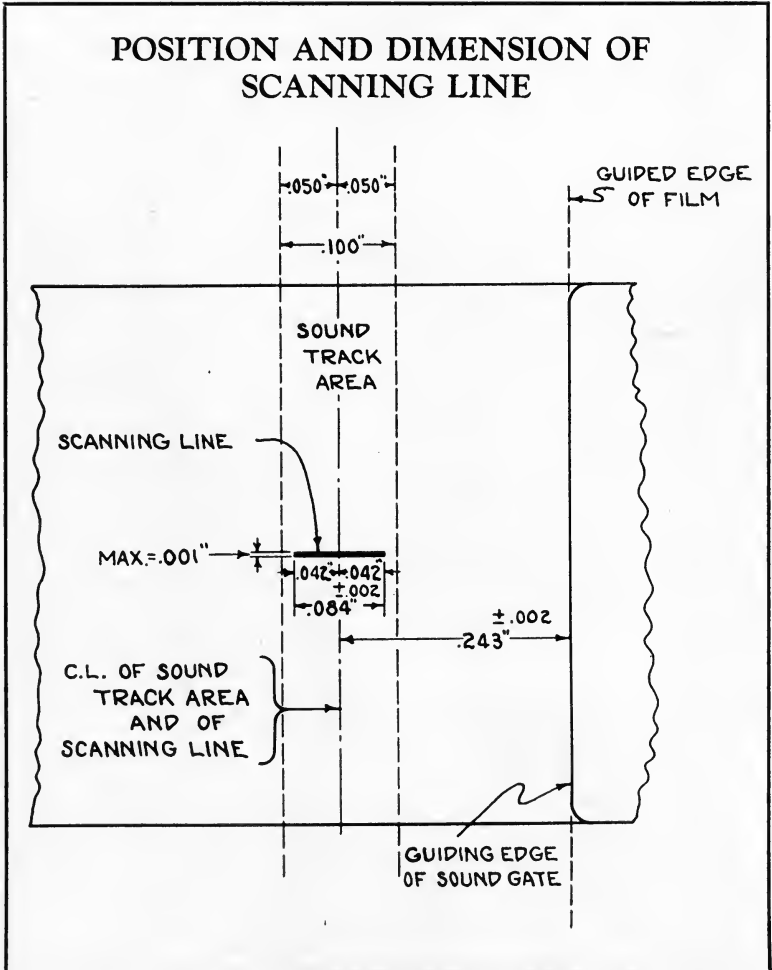

CHART 13

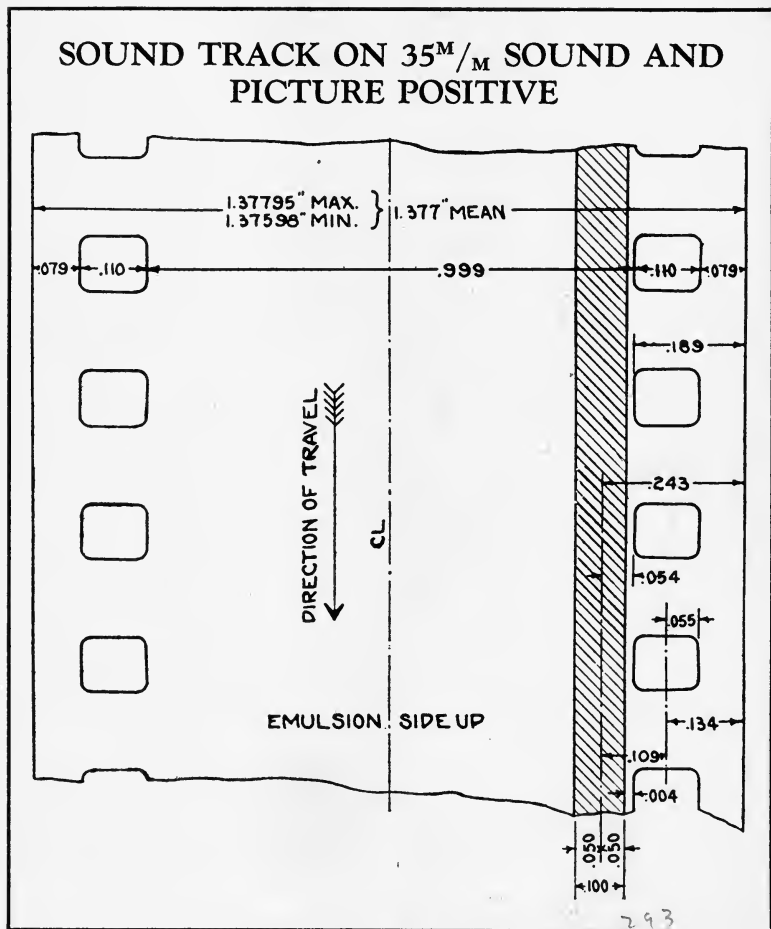

CHART 14

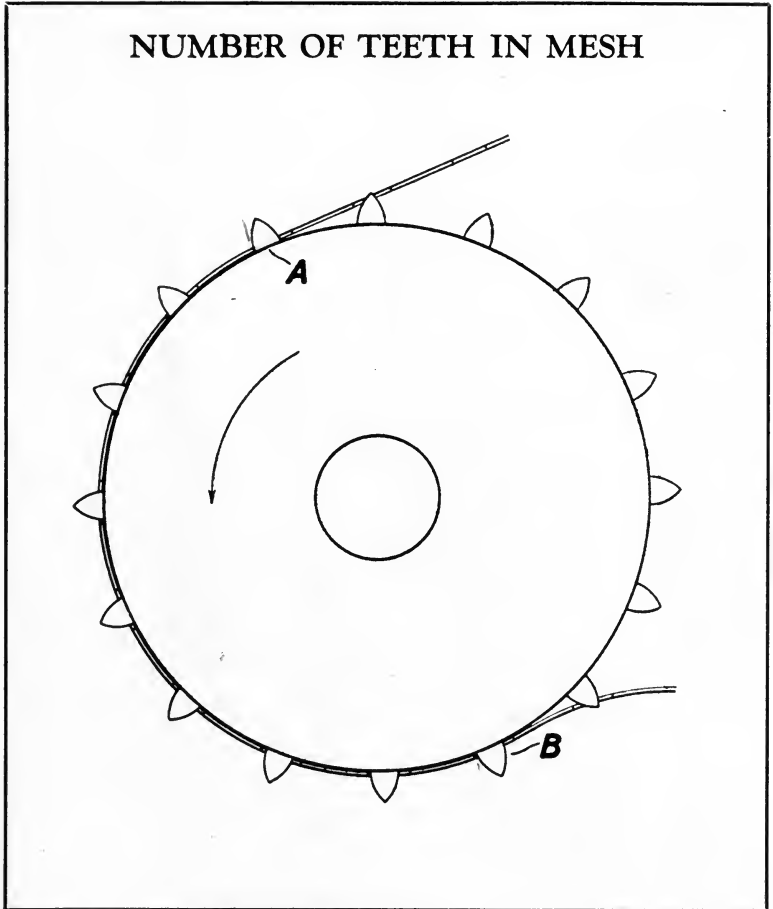

CHART 15

ABSTRACTS

The Editorial Office will welcome contributions of abstracts and book reviews from members and subscribers. Contributors to this section are urged to give correct and complete details regarding the reference. Items which should be included in abstracts are:

Title of article

Name of author as it appears on the article

Name of periodical and volume number

Date and number of issue

Page on which the reference is to be found

In book reviews, the following data should be given:

Title of book

Name of author as it appears on the title page

Name of publishing company

Date of publication

Edition

Number of pages and number of illustrations

The customary practice of initialing abstracts and reviews will be followed. Contributors to this issue are as follows: G. L. Chanier, E. E. Richardson, Clifton Tuttle, and the Monthly Abstract Bulletin of the Kodak Research Laboratories.

Sound Film Developing and Processing. *Kinemat. Weekly*, 152, Nov. 7, 1929, p. 52. Two models of the "Rovo" developing machine are briefly described. It is a glass tube machine and the film is driven through the various solutions by rollers instead of sprockets. The tubes are enclosed in a light-tight cabinet and the capacity of the larger machine is between 130 and 260 meters per hour.

C. M. T.

Incandescent Spotlight for Panchromatic Film Illumination. *Kinotechnik*, 11, June 20, 1929, p. 333. An incandescent light bulb is supported between a reflector and a ground glass plate, on an adjustable base. The ground glass plate diffuses the light from the filament through the lens so that no bright spots occur in the illumination. The spotlights are made in two sizes. The diameter of the effective illumination three meters distant for the small spotlight, using a 500-watt bulb, can be varied from 20 to 120 cm., and for the larger spotlight using a 1000- to 3000-watt bulb, the diameter can be varied from 40 to 150 cm.—*Kodak Abstr. Bull.*

Testing the Dallmeyer $f/0.99$ Cine Lens. *Amat. Films*, 2, December, 1929, p. 89. The Dallmeyer $f/0.99$ cine lens stopped to $f/11$, and used in photographing steel work against the sky, showed very little flare. It showed a distinct advance over the $f/1.9$ lenses in photographing a street scene lighted by shop windows. The definition was very good according to the author, but its depth of focus was rather small.—*Kodak Abstr. Bull.*

Frequency Ranges of the Phonograph Record. *Filmtechnik*, 5, Oct. 12, 1929, pp. 447-8. Dr. W. Hagemann, in the A. E. G. "Mitteilungen," gives the following data on phonograph record reproduction. The recording space of 100 mm. contains approximately 360 grooves (assuming $4\frac{1}{2}$ minutes per record), and 80 revolutions per minute. The pitch of the grooves is 0.28 mm., 0.15 mm. of which represents the groove width proper, and 0.13 mm. the width of the interval between the grooves. Toward the end of the record, the velocity of the record with respect to the needle is approximately 40 cm. per second. Under these conditions a sound of vibrating frequency of 4000 per second will consist of oscillations each occupying 0.1 mm. Phonographic reproduction is satisfactory for frequencies from 50 to 10,000 per second. Photomicrographs are given of phonographic records having recorded frequencies of 4000, 6000, and 10,000 per second.—*Kodak Abstr. Bull.*

Question of Large Picture Films. L. KUTZLEB. *Kinotechnik*, 11, Oct. 5, 1929, p. 507. It is the author's opinion that the installation of equipment for projection of wide films is likely to be a very gradual process in Europe. He believes that the Fear method of rotating the image through 90 degrees from the usual position on the film would be much more economical and equally satisfactory for obtaining a larger picture with a longer and wider sound track.—*Kodak Abstr. Bull.*

Expanding Core for Film Rewinding. M. ENGELMANN. *Lichtbildbühne*, 22, July 6, 1929, p. 15. A core for film rolls is constructed with a wedge center so that it is easily removable or replaceable without damaging the film. A rewinder using the new core is illustrated.
C. M. T.

Relations between Mirror, Film Gate Illumination, and Light Output in Motion Picture Projection. H. NAUMANN. *Kinotechnik*, 11, June 20, 1929, p. 311. In place of the screen there were set up a number of lenses in various areas of the picture so that a series of images of the condensing system, one for each portion of the picture area, were thrown on a screen farther back. By this means the light distribution over the face of a condensing mirror could be studied in relation to each part of the picture area. Diagrams and plates are reproduced.—*Kodak Abstr. Bull.*

Analyzing the Acoustics of Sound Motion Picture Theaters. W. KEITH FRIEND. *Projection Eng.*, 2, No. 2, February, 1930, p. 19. This article is an elaboration on a former discussion (*Projection Eng.*, December, 1929) dealing with the effect of theater seats on acoustics. Relations given by F. R. Watson and by W. C. Sabine are used.
E. E. R.

The Super Simplex. *Projection Eng.*, 2, No. 2, February, 1930, p. 29. A description of the new features which include a fan in the rotating shutter for reducing heat at the aperture plate and a semi-automatic framing and picture centering device.
E. E. R.

New 16 mm. Film System. *Projection Eng.*, December, 1929. This system uses the standard 16 mm. motion picture film, but four frames are photographed in the space now occupied by one. The film is moved horizontally as well as vertically across the front of the camera, the two movements taking place alternately. The projector can also be used to project regular 16 mm. film. A 100 ft. reel taken with this apparatus is equivalent to a 400 ft. reel of regular 16 mm. film.

G. L. C.

Euclid on the Screen. *New York Sun*, Mar. 7, 1930. U. S. Consul J. B. Osborne reports the extensive use of educational pictures for school children in Sweden. A large film producing company distributes 1000 films weekly to 1500 schools. Branches of higher education, especially in medicine and surgery, are taking advantage of motion picture instruction. G. L. C.

The Projection Osisa. *Projection Eng.*, December, 1929. A new device, known as the Projection Osisa, makes it possible for vocal and instrumental artists to see the sound waves they produce dance across the screen. The sound waves caught by a microphone are conveyed electrically to a delicately suspended mirror that is oscillated in unison with the received sound waves. A beam of light directed on this mirror is reflected by it to a system of revolving mirrors which, in turn, project it upon a screen. G. L. C.

Talkies Used by Police. *Ed. Screen*, 8, December, 1929, p. 298. A murderer's confession was recorded in Philadelphia by sound motion picture to be used later in the trial as evidence. A bureau is to be established for photographing prisoners and recording their voices, gestures, and mannerisms. All sound news cameramen, who photographed the attempted assassination in Brussels of Crown Prince Humbert of Italy, were ordered by police to turn their negatives in for inspection to be used as evidence in connection with the crime.—*Kodak Abstr. Bull.*

Motion Pictures Aid to Physicians. *Ed. Screen*, 8, November, 1929, p. 265. A motion picture of living cells of body tissues made by Dr. Alexis Carrel of the Rockefeller Institute was shown before the Thirteenth International Physiologists' Congress. Studies requiring days of microscopic observation were shown to an audience of 500 in half an hour.—*Kodak Abstr. Bull.*

Isography and Cinematography of the Heart. P. STUMPF. *Fortschr. a. d. Gebiete d. Roent.*, 40, November, 1929, pp. 798-804. Isograms or curves of equal density in the roentgenographic heart shadow give information on the volume distribution of the heart and have important diagnostic significance. Studies of heart movements may be made by roentgenographing the heart through a set of parallel slits in a lead screen upon a film moving slowly past the slits. Methods are described for viewing or projecting the resultant photograph for the purpose of visualizing the heart's action.—*Kodak Abstr. Bull.*

X-Ray Motion Pictures. *Photo-Era*, 63, November, 1929, p. 277-8. A brief description of three different attempts at X-ray motion pictures. Lommond and Commandon in 1911 and 1924 made successful motion pictures of the fluorescent screen. A special screen and a lens of Uviol glass and quartz were used. Ruggles, in 1925, developed a machine to make fifteen 8 x 10 direct X-ray photographs per second. He used Eastman Super-Speed Duplitzed X-ray film in strips 30 ft. long and 8 inches wide. Exposure time was about $1/24$ th second with intensifying screen. Pillsbury recently has developed a successful time-lapse mechanism for X-ray pictures. He has recorded the growth of a pigeon embryo, the opening of a rose, and the knitting of a bone. C. M. T.

Television with Cathode-Ray Tube for Receiver. V. ZWORYKIN. *Projection Eng.*, December, 1929, p. 18. The advantages of the cathode-ray tube are absence of moving mechanical parts, simplification of synchronization, ample amount of light, persistence of fluorescence of the screen. The transmitter and receiver are described, as well as the new type of cathode-ray tube used. For the transmission of the complete picture three sets of signals are required which it is possible to

combine into one channel. There are no moving parts, consequently no noise; the framing of the picture is automatic and it is brilliant enough to be seen in a moderately lighted room by a large number of people. The high frequency motor for synchronization is not required. The power necessary to operate the grid of the cathode-ray tube is no more than that for an ordinary vacuum tube.

G. L. C.

Glossary of Cinematic Terms. I. *Amat. Films*, 2, December, 1929, p. 100. This is a glossary of technical and general phrases used in modern motion picture work.

C. M. T.

BOOK REVIEWS

Photographic Emulsions. E. J. WALL. *American Photographic Publishing Co.*, Boston, 1929, 256 pp., \$5.00. In the preface the author states: "If any excuse is needed for the publication of this work, it may possibly be found in the fact that, since Abney's *Photography with Emulsions* (1885), and Eder's *Photographie mit Bromsilber-Gelatine und Chlorsilber-Gelatine* (1903), there has been no work available on the subject. The information given is based on many years' practical experience—no attempt has been made to withhold any information. On the other hand, no trade secrets have been disclosed nor any confidences violated, even if such be in the writer's possession." Specific directions are given for selecting equipment and materials, for making various kinds of emulsions, and for coating emulsion on plates, films, and paper. A very large number of separate formulas are given and many practical considerations are discussed. To the student of photography who wants to know how photographic emulsions are made, this book should be interesting and instructive, but it will probably contribute very little to the experienced emulsion maker.—*Kodak Abstr. Bull.*

Sound Projection. R. MIEHLING. *Mancall Publishing Corp.*, New York, 1929, 528 pp., \$6.00. This book, intended for projectionists and theater managers, gives practical instructions for preparing and projecting sound pictures as well as detailed information about the most commonly used types of apparatus. The first six chapters contain: a very brief historical treatment of sound recording and reproduction; an exposition of the nature of sound and of sound recording; some elementary matter on electricity; and a statement of the conventions used in circuit diagrams. Chapters seven to twenty-one are devoted to a description of sound reproduction equipment. Each element in the reproduction system is treated in succession rather than describing each manufacturer's complete equipment in one place. The last ten chapters contain information about theater presentation, film handling, maintenance of equipment, troubles and their remedies, and acoustical treatment of auditoriums. Acknowledgment is given for material obtained from other sources. The book is indexed and completely illustrated.—*Kodak Abstr. Bull.*

Heraclitus or the Future of Films. E. BETTS. *E. P. Dutton & Co.*, New York, 1928, 96 pp., \$1.80. The author, who is connected with the British motion picture industry, criticizes severely the low artistic standards of present-day feature films. The effects of forced production and commercializing are discussed. The increasing use of the motion picture in education and for propaganda purposes is taken as the best indication of its future.—*Kodak Abstr. Bull.*

SOCIETY OF MOTION PICTURE ENGINEERS

OFFICERS

President

J. I. CRABTREE, Eastman Kodak Co., Rochester, New York

Past President

L. C. PORTER, General Electric Co., Nela Park, Cleveland, Ohio

Vice-Presidents

H. P. GAGE, Corning Glass Works, Corning, N. Y.

K. C. D. HICKMAN, Eastman Kodak Co., Rochester, N. Y.

Secretary

J. H. KURLANDER, Westinghouse Lamp Co., Bloomfield, N. J.

Treasurer

W. C. HUBBARD, General Electric Vapor Lamp Co., Hoboken, N. J.

Board of Governors

H. T. COWLING, Eastman Teaching Films, Inc., 343 State St., Rochester, N. Y.

J. I. CRABTREE, Research Laboratory, Eastman Kodak Co., Rochester, N. Y.

H. P. GAGE, Corning Glass Works, Corning, N. Y.

K. C. D. HICKMAN, Research Laboratory, Eastman Kodak Co., Rochester, N. Y.

W. C. HUBBARD, General Electric Vapor Lamp Co., Hoboken, N. J.

J. H. KURLANDER, Westinghouse Lamp Co., Bloomfield, N. J.

W. C. KUNZMANN, National Carbon Co., Cleveland, Ohio

D. MACKENZIE, Electrical Research Products, Inc., 7046 Hollywood Blvd., Los Angeles, Calif.

P. MOLE, Mole-Richardson, Inc., 941 N. Sycamore Ave., Hollywood, Calif.

M. W. PALMER, Paramount-Famous-Lasky, Inc., 6th & Pierce Aves., Long Island City, N. Y.

L. C. PORTER, General Electric Co., Nela Park, Cleveland, Ohio

S. ROWSON, Ideal Films, Ltd., 76 Wardour St., London, W. 1, England.

E. I. SPONABLE, 277 Park Ave., New York, N. Y.

ProgressG. E. MATTHEWS, *Chairman*

M. ABRIBAT	A. W. DANASHEW	A. C. HARDY
J. A. BALL	J. B. ENGL	R. C. HUBBARD
J. BOOLSKY	R. E. FARNHAM	G. F. RACKETT
W. CLARK	H. B. FRANKLIN	S. K. WOLF
	K. GEYER	

ProjectionL. M. TOWNSEND, *Chairman*

H. W. DREYER	C. GREENE	W. B. RAYTON
G. C. EDWARDS	H. GRIFFIN	F. H. RICHARDSON
P. H. EVANS	R. H. McCULLOUGH	H. B. SANTEE
T. FAULKNER	W. A. McNAIR	L. M. TOWNSEND
J. H. GOLDBERG	R. MIEHLING	D. F. WHITING

PublicityW. WHITMORE, *Chairman*

F. C. BADGLEY	B. W. DEPUE	O. A. ROSS
	G. E. MATTHEWS	
	G. F. RACKETT	

SolicitationE. P. CURTIS, *Chairman*

J. W. COFFMAN	E. A. WILLIFORD
---------------	-----------------

Standards and NomenclatureA. C. HARDY, *Chairman*

M. C. BATSEL	P. H. EVANS	G. F. RACKETT
W. H. CARSON	R. E. FARNHAM	W. B. RAYTON
L. W. DAVEE	H. GRIFFIN	V. B. SEASE
A. DEBRIE	R. C. HUBBARD	T. E. SHEA
L. DEFOREST	L. A. JONES	J. P. SPENCE
J. A. DUBRAY	N. M. LAPORTE	E. I. SPONABLE
E. W. ENGSTROM	G. MITCHELL	L. T. TROLAND
	W. P. POWERS	

Studio LightingA. C. DOWNES, *Chairman*

L. J. BUTTOLPH	R. E. FARNHAM	M. W. PALMER
	K. C. D. HICKMAN	

Theater Lighting

C. E. EGELER, *Chairman*

J. C. AALBERG
F. A. BENFORD
A. C. DOWNES

F. FALGE
R. E. FARNHAM

C. GREENE
E. HUSE
L. A. JONES

LONDON SECTION

SIMON ROWSON, *Chairman*

A. NEWMAN, *Vice-Chairman*
L. EVELEIGH, *Secretary*
H. WOOD, *Treasurer*

PAUL KIMBERLEY, *Manager*
ALAN WILLIAMSON, *Manager*
WILLIAM VINTEN, *Manager*

NEW YORK SECTION

M. W. PALMER, *Chairman*
D. E. HYNDMAN, *Sec.-Treas.*

M. C. BATSEL, *Manager*
T. E. SHEA, *Manager*

PACIFIC COAST SECTION

P. MOLE, *Chairman*
G. F. RACKETT, *Sec.-Treas.*

C. DUNNING, *Manager*
E. HUSE, *Manager*

Membership Committee

J. COURCIER, *Chairman*
E. JEWELL

Papers and Programs

E. HUSE, *Chairman*



J. I. CRABTREE
President



H. P. GAGE
Vice-President



W. C. HUBBARD
Treasurer



K. C. D. HICKMAN
Vice-President



J. H. KURLANDER
Secretary



L. C. PORTER
Past President



H. T. COWLING



SIMON ROWSON
*Chairman, London
Section*



W. C. KUNZMANN



PETER MOLE
*Chairman, Pacific
Coast Section*



E. I. SPONABLE



DONALD MACKENZIE



M. W. PALMER
*Chairman, New York
Section*

ANNUAL REPORT OF THE TREASURER OF THE SOCIETY OF MOTION PICTURE ENGINEERS*

William C. Hubbard, *Treasurer*

In account with the Society of Motion Picture Engineers
September 20, 1928, to October 1, 1929

DR.

To balance on hand, Sept. 20, 1928:			\$7,560.98
Received from Dues, Active	\$5,049.58		
Associate	2,391.24		
Initiations & Transfers	7,728.26	15,169.08	
Sales, <i>Transactions</i>	3,522.14		
Reprints	1,258.78		
Advertisements	578.20		
Certificates	21.04	5,380.16	
Convention Receipts		2,168.37	
Overpayments of Dues by London Section		108.58	
Interest on Bank Balances		356.43	23,182.62
			30,743.60

CR.

By Printing & Stationery (<i>Bulletins, Letterheads, Supplies, etc.</i>)			2,114.27
Printing <i>Transactions, Reprints,</i> Mailing, <i>etc.</i>		6,300.86	
Convention Expenses, Reports, Programs, <i>etc.</i>		2,485.86	
General Expenses, Stenographer, Storage, Postage, Refunds on Dues, <i>etc.</i>		2,519.66	
Lapel Buttons and Certificates		92.64	13,513.29
Balance on hand, Oct. 1, 1929			17,230.31
			\$30,743.60

Respectfully submitted,

WILLIAM C. HUBBARD, *Treasurer*

* Audited and found correct, Robert G. Sparrow (Auditors & Accountants), New York City.

LONDON SECTION SOCIETY OF MOTION PICTURE ENGINEERS

Three general members' meetings and two executive meetings have been held between January 8th and February 24th. At the executive meetings arrangements for the first of a series of annual dinners was discussed and six new members, four active and two associate, were elected. Sir Oliver Lodge, world-famous scientist, will be the principal guest at the first annual dinner, April 10th.

A general members' meeting was held at the Royal Photographic Society, January 8th. The chairman of the Section, Mr. Rowson, presided. At this meeting a paper received from the Parent Society, entitled, "Some Practical Aspects of, and Recommendations on, Wide Film Standards" by A. G. Howell and J. A. Dubray, was read and elicited a lively discussion among members.

At the general members' meeting held at the Royal Photographic Society on January 27, 1930, with Mr. Arthur S. Newman, *Vice-Chairman*, presiding, two papers from the Parent Society were read: "A New Method of Blocking Out Splices in Sound Film" by J. I. Crabtree and C. E. Ives; and "Camera and Projector Apertures" by Lester Cowan. Arising out of the discussion following the first paper, it was decided to collect data from members of the Section as to the most satisfactory means for blocking out splices in use in Europe. In summing up the second paper, Mr. Newman said that the outstanding point in his mind was that this paper simply shouted the necessity for standardization which was so apparent in our particular industry.

At the general members' meeting held at the Royal Photographic Society, February 24th, with Mr. Rowson in the chair, an original paper on "Some Sound Problems" was read by Capt. A. D. G. West, late of the British Broadcasting Corporation and now of The Gramophone Company (H.M.V.). Capt. West dealt with the whole field of recording and reproducing as it affects talking motion pictures. He described several instruments which had been evolved for measuring reverberations, echoes, and harmonics, visually and photographically, and also dealt with various sound absorbent materials. A demonstration was given of how music and speech sound to the ear when the higher frequencies were cut off, and again when the higher frequencies were restored but the lower were cut off. Capt. West expressed the opinion that the artificial echo system, which he had developed while with the British Broadcasting Corporation, would be of value to the recording engineer of the talking picture.

In responding to a remark by the chairman, Capt. West signified his readiness to address the Society again next session. Among the announcements made by the chairman was an invitation from the Kine Group of the Royal Photographic Society to any member of the Society to attend their next meeting when a paper would be read by Herr Kossowsky, of U. F. A. Germany, on "Modern Methods of Sound Reproduction in Cinematography."

The members' meetings for the remainder of this season will be held on March 10th, when Mr. Villiers, of G. E. C., will read a paper on "Modern Incandescent Lighting in Cinema Studios;" March 24th, when Mr. Warmisham of Taylor, Taylor, and Hobson will read a paper on "Lenses, with Special Reference to Color Correction;" and April 14th, when Mr. Flemming of the National Physical Laboratories will read a paper on "The Acoustics of Buildings."

ORGANIZATION MEETING OF THE NEW YORK SECTION

March 6, 1930

The meeting was called to order by President J. I. Crabtree, acting in the role of temporary chairman pending the election of a permanent chairman. Chairman Crabtree briefly discussed the purpose of the meeting which was primarily the election of officers, and then introduced Professor Pitkin of Columbia University, who delivered a talk entitled "The Psychology of Sound and Its Relation to the Motion Picture." At the conclusion of this talk, Professor Pitkin briefly described his reactions on the use of color in motion picture photography, after which Chairman Crabtree allotted five minutes for the discussion of the talk. This discussion was by Messrs. Richardson, Shea, and Smack.

Chairman Crabtree appointed J. W. Coffman, G. C. Edwards, J. R. Manheimer, D. E. Hyndman, and R. C. Hubbard as a committee to make nominations for the office of chairman (term ending October, 1930). The committee reported their nomination of Messrs. Palmer and Spence. Mr. Spence, however, withdrew, and a motion was then made and carried that the secretary cast a ballot for Mr. Palmer, electing him to the chairmanship of the New York Section. This was done.

Mr. Palmer then took the chair and, after a brief message in which he expressed his appreciation and desire to devote his energies to the

service of the newly formed Section, he proceeded with the nominations for the offices of secretary-treasurer and two managers.

The committee nominations for secretary-treasurer were D. E. Hyndman and W. R. McNair, and for the offices of managers were H. Griffin, M. C. Batsel, J. R. Manheimer, T. E. Shea, and G. C. Edwards. It was moved that the manager receiving the highest number of votes be designated the long term manager, and the one receiving the next highest number of votes be designated as the short term manager.

The election of officers then proceeded on the basis of these nominations, and the subsequent count revealed that Mr. Hyndman was elected to the office of secretary-treasurer, Mr. Shea to the long term office of manager, and Mr. Batsel to the short term office of manager.

A telegram from the West Coast Section was read offering their Section's best wishes for the success of the New York Section.

A motion was then made and passed that the New York Section through its officers petition the Board of Governors to reconsider the limits of the New York Section, and to accept the definition of the metropolitan limits as those given by the leading national authority, which is assumed to be the United States Chamber of Commerce.

NEWS NOTE FROM THE NATIONAL SOCIETY FOR THE PREVENTION OF BLINDNESS

New York City, March 30.—The League of Nations is undertaking an exhaustive study of the effects that motion pictures may produce on the eyesight of children and young people, it was disclosed here today by the National Society for the Prevention of Blindness.

"The widespread use of the cinema throughout the world now, its additional possibilities for visual education with the introduction of talking pictures, and its increased use in schools and colleges has called forth the present investigation," explained Lewis H. Carris, managing director of the Society.

"Under the supervision of Dr. Lucien de Feo, director of the International Educational Cinematographic Institute of the League of Nations, the study will seek to determine whether any disturbances of sight are provoked by watching a brilliantly lighted screen in absolute darkness, the maximum time that a show can last before producing a tiring effect on sight, and similar answers which may influence the use of motion pictures for juvenile education.

“Leading scientific authorities throughout the world are being consulted. At the request of Dr. de Feo, a response to the inquiry has been made from the United States by Dr. Park Lewis of Buffalo, N. Y., who is vice-president of the International Association for the Prevention of Blindness as well as vice-president of this Society.” Concerning the opinions expressed in the report which Dr. Lewis forwarded to Geneva, Mr. Carris said that neither he nor Dr. Lewis felt at liberty to make them public until the International Educational Cinematographic Institute completes its research.

SOCIETY NOTES

The Spring Meeting.—The Convention Committee in charge of Mr. W. C. Kunzmann has arranged an interesting program of entertainment to supplement the papers program arranged by Mr. J. W. Coffman. On Monday evening, May 5th, there will be a motion picture entertainment and on Tuesday evening a visit to the Bureau of Standards has been arranged at which time Dr. P. Heyl will talk on “Sound and the Suppression of Reverberation” and Mr. I. Priest on “Color.” In addition to prominent speakers, an elaborate entertainment to follow the banquet on Wednesday evening has been arranged.

Sustaining Memberships.—In addition to those given in issue No. 4 of the JOURNAL, the following firms have taken up sustaining memberships for the amounts indicated.

\$1000 Memberships

Electrical Research Products, Inc.

General Theatres Equipment Co.

\$500 Memberships

Agfa Ansco Corporation

\$100 Memberships

Bausch & Lomb Optical Co. (2)

Mole-Richardson, Inc.

National Carbon Co.

Sustaining memberships have been established to provide a fund of from \$9000 to \$10,000 annually for the purpose of acquiring a permanent editor-manager for the JOURNAL who will also act as assistant secretary-treasurer and also to enable the Society to establish permanent headquarters in the Engineering Societies Building, New York, N. Y.

The Projection Committee.—This committee held two meetings at the Belvedere Hotel on March 18th and April 18th, respectively, and Chairman Townsend has assigned to the various committee members definite problems for research. The subject of remote volume control was discussed at great length and an interesting report from this committee at the Spring Meeting is assured.

Membership and Subscription and Publicity Committees.—A joint meeting of the above committees was held in the offices of the General Electric Company, Schenectady, N. Y., on March 24th. Mr. Cowling reviewed the results of an extensive campaign for membership in the past two years and intimated that in future emphasis would be placed on the matter of getting subscriptions rather than the solicitation of memberships. It is planned to circulate to prospective subscribers copies of a four-page folder.

Mr. W. Whitmore, chairman of the Publicity Committee, outlined detailed plans for supplying the press with reports of the Spring Convention.

Officers of the Society.—The following notes have been prepared in order to better acquaint the members with the various officers whose photographs appear on pages 576 and 577.

J. I. Crabtree (President).—In charge of departments of Photographic Chemistry and Motion Picture Film Developing, Kodak Research Laboratories, Rochester, N. Y. Served as member of Board of Governors and chairman of Papers and Publications and Progress Committees, and has contributed many articles to the Society's publications.

L. C. Porter (Past President).—Lamp development manager, General Electric Company, Nela Park, Cleveland, Ohio. Served as chairman of Standards and Nomenclature, and Papers and Publications Committees and as president during the years 1921–1923 and 1928–1929.

H. P. Gage (Vice-President).—Research Department, Corning Glass Works, Corning, N. Y. Is best known as co-author of the book, "Optic Projection."

K. C. D. Hickman (Vice-President).—Research chemist, Kodak Research Laboratories, Rochester, N. Y. Served as chairman of Membership, and Reciprocal Relations Committees and is author of several papers presented before the Society.

J. H. Kurlander (Secretary).—Projection engineer, Westinghouse

Lamp Company, Bloomfield, N. J. Formerly research engineer with the Brenkert Light Projection Co.

W. C. Hubbard (Treasurer).—Sales Department, General Electric Vapor Lamp Company, Hoboken, N. J. Formerly with the Cooper-Hewitt Electric Company. Has ably served as treasurer since 1925.

H. T. Cowling (Board of Governors).—Technical director of Eastman Teaching Films, Inc., Rochester, N. Y. Has had wide experience in exploration and the filming of travelogs.

W. C. Kunzmann (Board of Governors).—Sales Division, National Carbon Company, Cleveland, Ohio. Has been in charge of arrangements for the Society's conventions for many years.

D. MacKenzie (Board of Governors).—Sound engineer, Electrical Research Products, Inc. Formerly staff member of the Bell Telephone Laboratories and took a very active part in the practical development of the light valve method of sound recording.

P. Mole (Board of Governors).—President of Mole-Richardson, Inc., and formerly electrical engineer of the General Electric Company, Schenectady, N. Y. Was largely responsible for the development of studio tungsten lighting equipment.

M. W. Palmer (Board of Governors).—Chief electrical engineer of Paramount-Famous-Lasky Studios, Long Island City, N. Y. Served previously on the Board of Governors and contributed several technical papers to the Society's *Transactions*.

S. Rowson (Board of Governors).—Formerly director of Ideal Films, Ltd., London, England, and past chairman of the British Kinematographic Exhibitors Association. So far as is known he is the only chief of a producing concern that possesses a scientific degree (M.Sc. (Vict.)).

E. I. Sponable (Board of Governors).—Formerly chief engineer of the Fox-Case and later the Fox-Hearst Corporation. Previous to entering the motion picture field was assistant director of Case Research Laboratories, Auburn, N. Y., and was largely responsible for the development of the Aeo light used for Fox Movietone recording.

LIST OF MEMBERS*

- AALBERG, JOHN O. (*M*)
RKO Studios, 780 Gower St., Hollywood, Calif.
- ABBOTT, P. M. (*M*)
Motion Picture News, 729 Seventh Ave., New York, N. Y.
- ABRIBAT, MARCEL (*M*)
Kodak Pathé Research Laboratory, 30 Rue des Vignerons, Vincennes (Seine), France
- ADAMS, EDGAR W. (*A*)
Bell Telephone Labs., Inc., 463 West St., New York, N. Y.
- ADAMS, IRA J. (*A*)
41 Park Row, New York, N. Y.
- ALDER, VICTOR A. (*M*)
Ideal Films Studio, Boreham Wood, Herts, Eng.
- ALDERSON, RODERICK G. (*M*)
British International Pictures, Ltd., Elstree, Herts, Eng.
- ALEXANDER, DON M. (*M*)
Alexander Film Industries, Inc., Colorado Springs, Colo.
- ALLER, JOSEPH (*M*)
Consolidated Film Industries, Inc., 5515 Melrose Ave., Hollywood, Calif.
- ALTMAN, EDWARD (*M*)
Capitol Stage Lighting Co., 626 Tenth Ave., New York, N. Y.
- ANDERSON, GEORGE R. (*A*)
University of Toronto, Toronto, Ont., Can.
- ANDERSON, HOWARD A. (*M*)
4066 Duquesne Ave., Culver City, Calif.
- ANDRES, WALTER R. (*A*)
6601 Euclid Ave., Cleveland, Ohio
- ANDREWS, LEROY O. (*A*)
New England Theaters Operating Co., 19 Milk St., Boston, Mass.
- ANTOFILLI, GIOVANNI (*M*)
Akeley Camera Inc., 175 Varick St., New York, N. Y.
- ASHCRAFT, C. S. (*M*)
Ashcraft Automatic Arc Co., 4214 Santa Monica Blvd., Los Angeles, Calif.
- BACH, BERTRAM J. (*M*)
Province of Ontario Pictures, Parliament Buildings, Toronto, Ont., Can.
- BADGLEY, F. C. (*M*)
Canadian Government Motion Picture Bureau, Ottawa, Can.
- BAKER, GEORGE W. (*A*)
20 McEldowny St., Chicago Heights, Ill.
- BAKER, JUDD O. (*M*)
RCA Photophone, Inc., 411 Fifth Ave., New York, N. Y.
- BAKER, THOMAS T. (*M*)
Imperial Dry Plate Co., Ltd., Cricklewood, London, N. W. 2, Eng.
- BAKER, W. R. G. (*M*)
RCA Victor Co., Inc., Camden, N. J.
- BALKAM, HERBERT H. (*A*)
Brooklyn Edison Co., 380 Pearl St., Brooklyn, N. Y.
- BALL, J. A. (*M*)
Technicolor Motion Picture Corp., 823 N. Seward St., Hollywood, Calif.
- BALTIMORE, DAVID M. (*A*)
Moving Picture Theater Managers Institute, 315 Washington St., Elmira, N. Y.
- BAMFORD, WM. B. (*A*)
614 10th Ave., Belmar, N. J.
- BARBER, JAMES W. (*M*)
Brownie Wireless, Nelson St. Works, Mornington Crescent, London, N. W. 1, Eng.
- BARKELEW, JAMES T. (*A*)
801 Great Republic Life Bldg., Los Angeles, Calif.

* (*M*) Active member(*A*) Associate member

- BARLEBEN, KARL A., JR. (A)
N. Y. Institute of Photography,
10 West 33rd St., New York, N. Y.
- BARRELL, C. W. (M)
Western Electric Co., 120 West 41st
St., New York, N. Y.
- BARROWS, THAD C. (A)
Metropolitan Theater, Boston, Mass.
- BASS, CHARLES (A)
Bass Camera Co., 179 W. Madison
St., Chicago, Ill.
- BATSEL, MAX C. (M)
RCA Photophone, Inc., 411 Fifth
Ave., New York, N. Y.
- BAUER, CHARLES W. (M)
Colortone Pictures, Inc., 1996 Boule-
vard E., Hudson Heights, N. J.
- BECKER, ALBERT (A)
National Theater Supply Co., 372
Pearl St., Buffalo, N. Y.
- BEERS, NATHAN T. (M)
420 Clinton Ave., Brooklyn, N. Y.
- BEEYSON, FREDERICK W. (M)
5504 Hollywood Blvd., Hollywood,
Calif.
- BENDHEIM, EDMUND MCB. (A)
318 West 126th St., New York, N. Y.
- BENFORD, FRANK (M)
Research Lab., General Electric Co.,
Schenectady, N. Y.
- BENNETT, DONALD P. (A)
Home Talkie Machine Corp., 220
West 42nd St., New York, N. Y.
- BENNETT, WALTER E. (A)
Capitol Theater, Windsor, Ont., Can.
- BERNDT, ERIC M. (M)
Room 810, 1482 Broadway, New
York, N. Y.
- BERTRAM, E. A. (A)
Film Lab., Inc., 115 W. Austin Ave.,
Chicago, Ill.
- BETHELL, JAMES G. (A)
Kiddle, Margeson, & Hornidge, 511
Fifth Ave., New York, N. Y.
- BETTS, WALTER L. (M)
Bell Telephone Labs., Inc., 463 West
St., New York, N. Y.
- BIELICKE, WILLIAM F. (M)
Astro-Gesellschaft m. b. h., Lahn-
strasse 30, Berlin-Neukölln, Ger-
many
- BIELICKE, WILLIAM P. (M)
RKO Studios, Inc., 780 Gower St.,
Hollywood, Calif.
- BIGSWORTH, WM. A. (A)
British Lion Film Corp., Beacons-
field, Bucks, Eng.
- BING, JOSEPH M. (M)
Drem Products Corp., 152 W. 42nd
St., New York, N. Y.
- BLACKWELL, CLYDE B. (A)
Blackwell Film Prod. Co., 1014
Jackson St., Toledo, Ohio
- BLAIR, GEORGE A. (M)
Eastman Kodak Co., 343 State St.,
Rochester, N. Y.
- BLAKE, E. E. (M)
Kodak, Ltd., Kingsway, London,
W. C. 2, Eng.
- BLAKELEY, WALTER (M)
81 The Drive Mansions, Fulham
Road, London, S. M. 6, Eng.
- BLANEY, J. M. (M)
Colorcraft Corp., 122 W. 42nd St.,
New York, N. Y.
- BLINN, ARTHUR F. (A)
1249 Lodi Place, Hollywood, Calif.
- BLISS, GEORGE H. (A)
Q. R. S. Co., 135th St. & Walnut
Ave., New York, N. Y.
- BLYTHE, S. C. W. (A)
New Era Productions, Ltd., 26-27
D'Arblay St., London, W. 1, Eng.
- BOEHM, HANS (A)
Tonbild Syndikat A.-G., Jagerstrasse
6, Berlin W. 8, Germany
- BONN, LOUIS A. (A)
J. E. Brulatour, Inc., 1540 Broadway,
New York, N. Y.
- BOOLSKY, JACQUES (A)
Compagnie Bol S. A., Rue Du Leo-
pard, Geneve-Acacias (Suisse)
- BORNMANN, CARL (A)
Agfa Ansco Corp., Johnson City, N. Y.

- BORNMAN, CARL A. (M)
Agfa Ansco Corp., Camera Works,
Johnson City, N. Y.
- BOWEN, LESTER (A)
18 Kenmore Road, Larchmont, N. Y.
- BOXALL, H. GRANVILLE (M)
Gainsborough Pictures, Ltd., 58
Wardour St., London, W. 1, Eng.
- BOYLE, JOHN W. (A)
1207 N. Mansfield Ave., Hollywood,
Calif.
- BOYLEN, JOHN C. (A)
Parliament Bldgs., Toronto, Ont.,
Can.
- BRADSHAW, A. E. (A)
1301 Sixth Ave., Apt. B., Tacoma,
Wash.
- BRANDES, WERNER (M)
British International Pictures, Ltd.,
Elstree, Herts, Eng.
- BREWER, HARRY G. (A)
47 E. Willis Ave., Detroit, Mich.
- BREWSTER, P. D. (M)
Brewster Color Film Corp., 58
First St., Newark, N. J.
- BRIDGE, WILLARD E. (A)
1041 N. Formosa St., Hollywood, Calif.
- BRIEFER, MICHAEL (M)
Atlantic Gelatin Co., Woburn, Mass.
- BRINDLEY, WILLIAM E. (A)
Westinghouse Electric & Mfg. Co.,
E. Pittsburgh, Pa.
- BRISTOL, WILLIAM H. (M)
Bristol Studios, Waterbury, Conn.
- BROEG, W. E. (A)
The Fleischman Co., 701 Washing-
ton St., New York, N. Y.
- BROMHEAD, REGINALD C. (A)
Gaumont British Picture Corp., Ltd.,
21 Denman St., London, W., Eng.
- BROWN, FREEMAN LEE (M)
RCA Victor Co., Inc., Camden, N. J.
- BROWN, J. CALVIN (M)
704 South Spring St., Los Angeles,
Calif.
- BROWN, JOHN Y. (M)
Williamson Film Printing Co., Ltd.,
Barnet, Herts, Eng.
- BROWN, JOSEPH C. (A)
International Newsreel Corp., 416
Hearst Bldg., Washington, D. C.
- BROWNLIE, HAROLD L. (M)
RCA Photophone, Inc., Film House,
142 Wardour St., London, W. 1,
Eng.
- BUCKLES, J. O. (A)
1609 West 40th St., Oklahoma City,
Okla.
- BUCKSTONE, WALTER (M)
Kodak Ltd., Dept. 38, 63 Kingsway,
London, W. C. 2, Eng.
- BUENSOD, ALFRED G. (A)
Carrier Engineering Corp., 39 Cort-
landt St., New York, N. Y.
- BURCHETT, C. W. (A)
Theatre Lighting & Equip. Co.,
255 Golden Gate Ave., San Fran-
cisco, Calif.
- BUREL, L. H., (A)
66, Rue Lepic, Paris, France
- BURGESS, FRANCIS J. (A)
Hollywood Y. M. C. A., 1553 N.
Hudson St., Hollywood, Calif.
- BURNAP, ROBERT S. (M)
RCA Radiotron Co., 415 S. 5th St.,
Harrison, N. J.
- BURNETT, H. D., (M)
Lighting Service Dept., Canadian
General Electric Co., Ltd., 212
King St., W., Toronto, 2, Can.
- BURNETT, J. C. (M)
Burnett Timken Research Labora-
tory, Alpine, N. J.
- BURNS, ROBERT P. (A)
Granada Theater, 6247 Sheridan
Road, Chicago, Ill.
- BURNS, S. R. (M)
International Projector Corp., 90
Gold St., New York, N. Y.
- BUSCH, HERMAN (A)
1327 S. Wabash Ave., Chicago, Ill.
- BUTTOLPH, LEROY J. (M)
General Electric Vapor Lamp Co.,
Hoboken, N. J.

- CADENAS, FERNANDO J. (A)
National Lamp Works, 441 Lexington Ave., New York, N. Y.
- CAHILL, EDWARD C. (A)
RCA Photophone, Inc., 438 W. 37th St., New York, N. Y.
- CAMERON, JAMES R. (M)
Manhattan Beach, N. Y.
- CANADY, DON R. (M)
Film Sound Corp., 1825 E. 18th St., Cleveland, Ohio
- CAPSTAFF, JOHN G. (M)
Eastman Kodak Co. Research Laboratory, Rochester, N. Y.
- CARPENTER, A. W. (A)
United Research Co., 41-40 Harold Ave., Long Island City, N. Y.
- CARPENTER, ERNEST S. (A)
Escar Motion Picture Service, Inc., 10008 Carnegie Ave., Cleveland, Ohio
- CARRIER, G. RUSSELL (M)
Picture Products Dept., Seiberling Rubber Co., Akron, Ohio
- CARSON, W. H. (M)
Agfa-Ansco Corp., Binghamton, N. Y.
- CARULLA, ROBERT (A)
1254 East 31st St., Brooklyn, N. Y.
- CAUDA, ERNESTO (A)
Piazza Colonna 366, Rome, Italy
- CAUFIELD, ARTHUR E. (A)
24 East 92nd St., Los Angeles, Calif.
- CAVALIERE, NICHOLAS (A)
38 Mechanic St., New Haven, Conn.
- CHAMBERS, GORDON A. (M)
Eastman Kodak Co., 6706 Santa Monica Blvd., Hollywood, Calif.
- CHANIER, GASTON L. (M)
Old Short Hills Road, Short Hills, N. J.
- CHAPMAN, S. CULLOM (M)
Paramount-Famous-Lasky Studios, 6th and Pierce Aves., Long Island City, N. Y.
- CHAPPELL, CHARLES E. (A)
917 Edgewood Ave., Nelson, B. C.
- CHRISTIE, John (M)
Eastman Kodak Co., 190 Platt St., Rochester, N. Y.
- CHUBB, LEWIS W. (A)
RCA Victor Co., Inc., Camden, N. J.
- CIFRE, J. S. (M)
National Theater Supply Co., 211 Columbus Ave., Boston, Mass.
- CLARK, CHARLES H. (M)
60 Grand St., New York, N. Y.
- CLARK, D. B. (M)
Wm. Fox Studios, 4601 Sunset Blvd., Hollywood, Calif.
- CLARK, JOHN A. (A)
Weston Electrical Instrument Corp., 614 Frelinghuysen Ave., Newark, N. J.
- CLARK, LAURISTON E. (M)
Pathé Studios, Culver City, Calif.
- CLARK, REX S. (M)
Clark-Cine Service, 2540 Park Ave., Detroit, Mich.
- CLARK, WALTER (M)
Kodak, Ltd., Wealdstone, Middlesex, Eng.
- CLAWSON, DAL (M)
1575 Jerome Ave., Fort Lee, N. J.
- CLAYTON, JOSEPH (M)
9430 46th Ave., Elmhurst, L. I., N. Y.
- COFFMAN, J. W. (M)
Audio-Cinema, Inc., 161 Harris Ave., Long Island City, N. Y.
- COHEN, EMANUEL (M)
Paramount-Famous-Lasky Corp., 1501 Broadway, New York, N. Y.
- COHEN, JOSEPH H. (M)
Atlantic Gelatin Co., Hill St., Woburn, Mass.
- COLLISON, WILLIAM V. (M)
Kodak, Ltd., Wealdstone, Middlesex, Eng.
- CONEYBEAR, JOHN F. (M)
Fox Film Corp., 441 W. 55th St., New York, N. Y.
- CONTNER, J. BURG (A)
President Hotel, W. 48th St., New York, N. Y.
- COOK, OTTO W. (M)
Eastman Kodak Co., 343 State Street, Rochester, N. Y.

- COOK, WILLARD B. (*M*)
Kodascope Libraries, 33 West 42nd
St., New York, N. Y.
- CORBETT, LAWRENCE W. (*A*)
Technicolor Motion Picture Corp.,
120 Brookline Ave., Boston, Mass.
- COUR, EUGENE J. (*M*)
Pathé News, 1023 S. Wabash Ave.,
Chicago, Ill.
- COURCIER, J. L. (*A*)
J. E. Brulatour, Inc., 6700 Santa
Monica Blvd., Hollywood, Calif.
- COWLING, HERFORD TYNES (*M*)
Eastman Kodak Co., 343 State
Street, Rochester, N. Y.
- COX, J. J. (*M*)
British International Pictures, Ltd.,
Elstree, Herts, Eng.
- COZINE, ARTHUR (*A*)
Paramount-Famous-Lasky Studios,
6th & Pierce Aves., Long Island
City, N. Y.
- COZZENS, LOUIS S. (*M*)
DuPont Pathé Film Mfg. Co., Par-
lin, N. J.
- CRABTREE, JOHN I. (*M*)
Eastman Kodak Co. Research Lab-
oratory, Rochester, N. Y.
- CRANDALL, ROLAND D. (*A*)
Sound Beach, Conn.
- CRAWFORD, MERRITT (*M*)
605 W. 112th St., New York, N. Y.
- CRISPINEL, WILLIAM T. (*M*)
Multicolor Film, Inc., 201 N. Occi-
dental Blvd., Los Angeles, Calif.
- CUFFE, LESLIE E. (*A*)
Theater Enterprises, 601 Guaranty
Bldg., Hollywood, Calif.
- CULLEN, CEDRIC W. (*A*)
204 Chippewa St., Sandwich, Ont.,
Can.
- CULLEN, ROBERT S. (*A*)
12 Maiden Lane, New York, N. Y.
- CUMMINGS, JOHN S. (*A*)
Cummings Labs., 23 W. 60th St.,
New York, N. Y.
- CURLE, CHARLES E. (*A*)
Box 1614, Station "A," Chattanooga,
Tenn.
- CURTIS, EDWARD P. (*M*)
Eastman Kodak Co., 343 State
Street, Rochester, N. Y.
- DABKE, BALVANT S. (*A*)
Hindoostan Cinema Film Co., 144 A.
Girgaon Back Rd., Bombay, India
- DAIN, HENRY (*A*)
Société Technique d'Optique et de
Photographie, 83 Rue Boissy
l'Anglais, Paris, France
- DALOTEL, MAURICE (*A*)
Material Cinematographique, 111,
113 Rue St. Maur XIe, Paris,
France
- DANA, ALAN S. (*A*)
Kerite Insulated Wire & Cable Co.,
Seymour, Conn.
- DANASHEW, A. W. (*A*)
34 Cheestey per N6, Apt. 8, Moscow,
U. S. S. R.
- DASH, C. C. (*M*)
Hertner Electric Co., 12690 Elm-
wood Ave., Cleveland, Ohio
- DAVE, BHOGILAL K. M. (*A*)
Sharda Film Co., Tardeo Rd., Bom-
bay, India
- DAVEE, LAWRENCE W. (*M*)
Fox-Hearst Corp., 460 W. 54th St.,
New York, N. Y.
- DAVIDGE, LEROY CLIFFORD (*M*)
Roy Davidge Film Laboratories,
Hollywood, Calif.
- DAVIDSON, L. E. (*A*)
Visual Demonstration System, Inc.,
259 Delaware Ave., Buffalo, N. Y.
- DAVIES, HARRY (*A*)
Pathé of France, Ltd., 5 Lisle St.,
London, W. C. 2, Eng.
- DE BEAULIEU, LEON (*M*)
11749 Van Owen St., North Holly-
wood, Calif.
- DEBRIE, ANDRE (*A*)
Établissements Andre Debrie, 111,
113 Rue St. Maur, Paris, France

- DE FEO, LUCIANO (A)
Roma-Villa Medioevale Torlonia, Via
Lazzaro Spallanzani, a Rome, Italy
- DE FOREST, LEE (M)
General Talking Pictures Corp., 318
E. 48th St., New York, N. Y.
- DE FRENES, JOSEPH (M)
De Frenes Co., 60 N. State St.,
Wilkes-Barre, Pa.
- DEIGHTON, WM. (A)
Oliver, B. C.
- DEL RICCIO, LORENZO (M)
Paramount - Famous - Lasky Corp.,
Astoria, L. I., N. Y.
- DENISON, E. J. (M)
United Artists, 729 Seventh Ave.,
New York, N. Y.
- DENTELBECK, CHARLES A. (A)
Famous Players Canadian Corp., 61
Albert St., Toronto, Ont., Can.
- DEPUE, BURTON W. (A)
Burton Holmes Lectures, Inc., 7510
N. Ashland Ave., Chicago, Ill.
- DEPUE, O. B. (A)
DePue & Vance, 7512 N. Ashland
Ave., Chicago, Ill.
- DESART, A. W. (M)
Box 413, Hollywood Station, Holly-
wood, Calif.
- DEVARE, NARAYANRAO G. (M)
Kohinoor Film Co., Dadar, Bombay,
India
- DE VAULT, RALPH P. (M)
104 N. Princeton Ave., Villa Park, Ill.
- DEVRY, H. H. (M)
Q. R. S.-DeVry Corp., 4829 So.
Kedzie Ave., Chicago, Ill.
- DEWITT, H. N. (A)
36 Toronto St., Toronto, Ont., Can.
- DICKINSON, ARTHUR S. (A)
Motion Picture Prod. & Dist. of
America, Inc., 469 Fifth Ave.,
New York, N. Y.
- DICKSON, R. B. (A)
Pyrene Mfg. Co., 560 Belmont Ave.,
Newark, N. J.
- DICKSON, THEODORE E. (A)
Pathé Studios, Culver City, Calif.
- DIDIEE, L. J. J. (A)
Société Kodak-Pathé, 39 Ave. Mon-
tagne, Paris, France
- DIETERICH, L. M. (M)
1939 N. Kenmore Ave., Hollywood,
Calif.
- DILL, HERBERT S. (A)
National Theater Supply Co., 211
Columbus Ave., Boston, Mass.
- DOBSON, GEORGE (M)
494 Dwas Line Road, Clifton, N. J.
- DONER, FRANK M. (A)
P. O. Box 6, Toledo, Ohio
- DOUBLE, STANLEY G. (M)
British International Pictures, Ltd.,
Elstree, Herts, Eng.
- DOUGLASS, LEON F. (M)
Menlo Park, Calif.
- DOWNES, A. C. (M)
National Carbon Co., Box 400,
Cleveland, Ohio
- DOYLE, EDGAR D. (A)
Leeds & Northrup Co., 4901 Stenton
Ave., Germantown, Philadelphia,
Pa.
- DREHER, CARL (M)
RKO Studios, Inc., 780 Gower St.,
Hollywood, Calif.
- DREYER, HARRY W. (M)
RCA Photophone, Inc., 411 Fifth
Ave., New York, N. Y.
- DUBRAY, JOSEPH A. (M)
Bell & Howell Co., 1803 Larchmont
Ave., Chicago, Ill.
- DUDIAK, FRANK (A)
Fairmont Theater, Fairmont, W. Va.
- DUISBERG, WALTHER H. (A)
Patent Research, Inc., 521 Fifth
Ave., New York, N. Y.
- DUNBAUGH, GEORGE J., JR. (A)
Champion Mfg. Co., 7348 Kimbark
Ave., Chicago, Ill.
- DUNNING, CARROLL H. (M)
932 N. LaBrea Ave., Hollywood, Calif.
- DUNNING, DODGE (A)
932 N. LaBrea Ave., Hollywood, Calif.
- DURHOLZ, OTTO B. (A)
21 Martin St., Paterson, N. J.

- DYKEMAN, CHESTER L. (*A*)
Duplex Motion Picture Industries,
Inc., Sherman St. & Harris Ave.,
Long Island, N. Y.
- EASTMAN, GEORGE (*Honorary*)
Eastman Kodak Co., Rochester, N. Y.
- EDISON, THEODORE M. (*A*)
Thomas A. Edison, Inc., West
Orange, N. J.
- EDISON, THOMAS, A. (*Honorary*)
West Orange, N. J.
- EDOUART, A. F. (*M*)
Paramount-Famous-Lasky Corp.,
5451 Marathon Ave., Hollywood,
Calif.
- EDWARDS, GEORGE C. (*A*)
101-21 78th St., Ozone Park, L. I.,
N. Y.
- EGELER, CARL E. (*M*)
Engr. Dept., National Lamp Works,
Nela Park, Cleveland, Ohio
- EGROT, LUCIEN G. (*A*)
6 Raleigh Gardens, Brixton Hill,
London, S. W. 2, Eng.
- ELLISON, MICHAEL (*A*)
Peko, Inc., 2400 W. Madison St.,
Chicago, Ill.
- ELMS, CHARLES D. (*M*)
10 Westbury Ave., Staten Island, N. Y.
- ELMS, JOHN D. (*M*)
Widescope Camera & Film Corp.,
P. O. Box 182, Staten Island, N. Y.
- ELWELL, CYRIL F. (*M*)
197 Queens Gate, London, S. W. 7,
Eng.
- EMMOTT, BASIL W. G. (*A*)
4 Edith Rd., West Kensington,
London, W. 14, Eng.
- EMSLIE, EMMETT K. (*A*)
907 West Hamilton St., Flint, Mich.
- ENGEL, THEODORE J. (*M*)
Audio-Cinema, Inc., 161 Harris Ave.,
Long Island City, N. Y.
- ENGELKE, WILLIAM (*M*)
Cinema Traders, Ltd., 26 Church St.
Charing X Rd., London, W. 1,
Eng.
- ENGL, JOSEF B. (*M*)
97 Bismarkstrasse, Berlin Charlotten-
tenburg, Germany
- ENGSTROM, ELMER W. (*M*)
RCA-Victor Co., Inc., Camden,
N. J.
- EVANS, PORTER H. (*M*)
Warner Bros. Vitaphone Corp., 1277
E. 14th St., Brooklyn, N. Y.
- EVANS, RAYMOND (*M*)
Division of Motion Pictures, U. S.
Dept. of Agriculture, Washington,
D. C.
- EVELEIGH, LESLIE G. H. (*M*)
Gaisford House, Gaisford St., Ken-
tish Town, London, N. W. 5, Eng.
- FAITHFULL, GEOFFREY (*M*)
Archibald Nettlefold Productions,
The Studios, Hurst Grove, Walton-
on-Thames, Eng.
- FALGE, FRANCIS M. (*A*)
Publix Theaters Corp., Paramount
Bldg., New York, N. Y.
- FARNHAM, R. E. (*M*)
Engr. Dept., National Lamp Works,
Nela Park, Cleveland, Ohio
- FAULKNER, TREVOR (*A*)
Paramount-Famous-Lasky Corp.,
Times Square, New York, N. Y.
- FAVRE, JUAN L. (*A*)
Kodak-Pathé, Casilla de Correo
7353, Buenos Aires, Argentina
- FIFERLIK, LAWRENCE A. (*A*)
40 Seventh Ave., New York, N. Y.
- FINGERLIN, JOHN W. (*A*)
Paramount Long Island Studio,
6th & Pierce Aves., Long Island
City, N. Y.
- FITZPATRICK, JOSEPH M. S. (*A*)
Kodak, Ltd., Wealdstone, Middle-
sex, Eng.
- FLANAGAN, J. T. (*M*)
Tri-State Motion Pictures Co., 208
Film Bldg., Cleveland, Ohio
- FLANNAGAN, COKE (*M*)
Electrical Research Products, Inc.,
250 W. 57th St., New York, N. Y.

- FLICKINGER, EDWARD (A)
204 Maple St., Windsor, Ont., Can.
- FLINT, ASHER (M)
Fox Film Corp., 850 Tenth Ave.,
New York, N. Y.
- FLORY, LOUIS P. (A)
Boyce-Thompson Institute, 1086 N.
Broadway, Yonkers, N. Y.
- FLYNN, KIRTLAND (M)
Celluloid Co., 290 Ferry St., Newark,
N. J.
- FOOTE, PAUL C. (A)
Bell & Howell Co., 1801 Larchmont
Ave., Chicago, Ill.
- FORD, WILLIAM B. (A)
3 Belmont House, Candover St.,
London, W. 1, Eng.
- PRESIDENT, THE SOCIÉTÉ FRANÇAISE
DE PHOTOGRAPHIE (*Honorary*)
Rue de Clichy, 51, Paris, 9eme,
France
- FRANKLIN, HAROLD B. (A)
West Coast Theaters, Inc., Washing-
ton & Vermont Aves., Los Angeles,
Calif.
- FREEDMAN, ALAN E. (M)
Fox Film Corp., 850 Tenth Ave.,
New York, N. Y.
- FREULER, JOHN R. (M)
216 W. Water St., Milwaukee, Wis.
- FREUND, KARL (A)
6626 Franklin Ave., Hollywood, Calif.
- FRITTS, EDWIN C. (M)
Eastman Kodak Co., 343 State
Street, Rochester, N. Y.
- FULCHER, E. J. (A)
157 Albert St., East, Sault Ste. Marie,
Ont., Can.
- FULTON, C. H. (A)
E. E. Fulton Co., 1018 S. Wabash
Ave., Chicago, Ill.
- GAGE, HENRY P. (M)
Corning Glass Works, Corning, N. Y.
- GAGE, OTIS A. (A)
Corning Glass Works, Corning, N. Y.
- GARLAND, R. M. (A)
5711 13th St., N. W., Washington,
D. C.
- GAUMONT, LEON (M)
Gaumont Co., 57 Rue Saint Roch,
Paris, France
- GEIB, E. R. (M)
National Carbon Co., Box 400,
Cleveland, Ohio
- GELMAN, J. N. (M)
3439 Jay St., Cincinnati, Ohio
- GERMAN, WILLIAM J. (M)
J. E. Brulatour, Inc., 154 Crescent
St., Long Island City, N. Y.
- GERRARD, WILLIAM C. (A)
46 Jayson Ave., Great Neck, L. I.,
N. Y.
- GEYER KARL (A)
Geyer-Werke, A.-G., Harzerstrasse
39/42, Berlin So 36, Germany
- GEYER, WALTER (A)
Admiralstrasse 2/3, Zeuthen i/Mark,
Germany
- GILLETTE, CLYDE F. (M)
177 Alameda St., Rochester, N. Y.
- GILMOUR, JOHN G. T. (A)
Visual Instruction Section, General
Electric Co., Schenectady, N. Y.
- GLENN, CEDRIC L. (A)
Electrical Research Products, Inc.,
712 Union Trust Bldg., Cleveland,
Ohio
- GLOVER, CHARLES W. (A)
Abbey House, Westminster, London,
S. W. 1, Eng.
- GLUNT, OMER M. (M)
Bell Telephone Labs., Inc., 463 West
St., New York, N. Y.
- GOLDMAN, F. LYLE (A)
Audio-Cinema, Inc., 161 Harris Ave.,
Long Island City, N. Y.
- GOLDSMITH, ALFRED N. (M)
RCA Photophone, Inc., 411 Fifth
Ave., New York, N. Y.
- GORDON, IRL (A)
104 Bittman St., Akron, Ohio

- GOUDY, CARL F. (*M*)
Pacent Electric Co., 91 Seventh Ave.,
New York, N. Y.
- GRANTHAM, JOHN A. (*M*)
Standard Kine Labs., Inc., Rythe
Works, Thames-Ditton, Eng.
- GRAY, ARTHUR H. (*M*)
Lancaster Theater, Lancaster &
Causeway Sts., Boston, Mass.
- GRAY, ERIC (*M*)
Welsh Pearson Elder Films, 3 Rupert
St., London, W. C., Eng.
- GREEN, NEWTON B. (*M*)
Engr. Dept., Camera Works, East-
man Kodak Co., Rochester, N. Y.
- GREEN, W. C. (*M*)
53, Upper Tollington Park, Fins-
bury Park, London, N. 4, Eng.
- GREENE, CHAUNCEY L. (*A*)
2722 Harriet Ave., Minneapolis, Minn.
- GREENE, CLAUDE F. (*M*)
British International Pictures, Ltd.,
Elstree, Herts, Eng.
- GREENE, EDWARD J. (*M*)
7510 N. Ashland Ave., Chicago, Ill.
- GREGORY, CARL LOUIS (*M*)
76 Echo Ave., New Rochelle, N. Y.
- GRIFFIN, HERBERT (*M*)
International Projector Corp., 90
Gold St., New York, N. Y.
- GRIFFITH, LEIGH M. (*A*)
6417 W. 6th St., Los Angeles, Calif.
- GRIFFITHS, PETER H. (*A*)
1 Wirral St., Birkenhead, Eng.
- GROVER, HARRY G. (*A*)
Radio Corporation of America, 233
Broadway, New York, N. Y.
- GUERIN, A. J. (*M*)
Bennett Film Laboratories, 6363
Santa Monica Blvd., Hollywood,
Calif.
- GUISSART, RENE (*M*)
British International Pictures, Ltd.,
Elstree, Herts, Eng.
- GUNN, ALEXANDER H. (*A*)
6 Sibley Place, Rochester, N. Y.
- GUSTIN, RICHARD W. (*A*)
Bijou Theater, Bangor, Maine
- HACKEL, JOSEPH (*A*)
1540 W. 5th St., Brooklyn, N. Y.
- HALBERTSMA, N. A. (*A*)
Philips' Glow Lamp Works, Ltd.,
Eindhoven, Holland
- HALEY, GERALD A. (*A*)
British International Pictures, Ltd.,
Elstree, Herts, Eng.
- HALL, JAMES K. (*A*)
Kodak, Ltd., Wealdstone, Middle-
sex, Eng.
- HALVORSON, C. A. B. (*M*)
General Electric Co., West Lynn,
Mass.
- HAMMOND, ALBERT C. (*A*)
British International Pictures, Ltd.,
Elstree, Herts, Eng.
- HAMMOND, LOUIS E. (*A*)
Brooklyn Strand Theater, 647 Fulton
St., Brooklyn, N. Y.
- HANDLEY, CHARLES W. (*M*)
National Carbon Co., Inc., 841 E.
Fourth Place, Los Angeles, Calif.
- HANNA, CLINTON R. (*A*)
Research Dept., Westinghouse Elec-
tric & Mfg. Co., E. Pittsburgh,
Pa.
- HANSEN, EDMUND H. (*M*)
1835 N. Garfield Pl., Apt. A, Holly-
wood, Calif.
- HARCUS, WILMORE C. (*A*)
Paramount-Famous-Lasky Corp.,
5451 Marathon St., Hollywood,
Calif.
- HARDIN, RUFUS O. (*A*)
2825 Linden Ave., Knoxville, Tenn.
- HARDING, JOHN A. (*A*)
1189 Sheridan Ave., New York,
N. Y.
- HARDY, A. C. (*A*)
Mass. Institute of Technology, Cam-
bridge, Mass.
- HARLEY, JOHN B. (*A*)
Bell Telephone Labs., Inc., 463 West
St., New York, N. Y.
- HARLOW, JOHN B. (*A*)
Electrical Research Products Corp.,
250 W. 57th St., New York, N. Y.

- HARRINGTON, T. T. (*M*)
1559 Arch St., Berkeley, Calif.
- HARRIS, WM. M. (*M*)
Pathé Studios, Culver City, Calif.
- HARTLEY-DAVIS, E. C. (*M*)
36 Shaftsbury Ave., London, W. 1,
Eng.
- HAWORTH-BOOTH, MARIE (*A*)
Debrise Établissement, 23 Mortimer St., London, W. 1, Eng.
- HAYDEN, A. C. (*M*)
A. C. Hayden Co., Box 496, Brockton, Mass.
- HEDWIG, WM. K. (*M*)
Hedwig M. P. Laboratories, Inc., Park Place & Congress Ave., Flushing, L. I., N. Y.
- HEISLER, CHARLES L. (*M*)
1443 Glenwood Blvd., Schenectady, N. Y.
- HENNESSY, WM. W. (*A*)
564 S. Goodman St., Rochester, N. Y.
- HIBBARD, FRANK H. (*M*)
Duplex Motion Picture Industry, Inc., Harris Ave. & Sherman St., Long Island City, N. Y.
- HICKMAN, KENNETH (*M*)
Research Laboratory, Eastman Kodak Co., Rochester, N. Y.
- HIGGINS, ARTHUR E. (*A*)
119 Darley Rd., Randwick, Sydney, Australia
- HILL, VAN DYKE (*M*)
12 E. 44th St., New York, N. Y.
- HILLIER, HARRY R. (*A*)
Metropolitan Motion Picture Co., 2310 Cass Ave., Detroit, Mich.
- HISCOTT, LESLIE S. (*A*)
Alliance Studios, St. Margarets, Twickenham, Eng.
- HITCHCOCK, ALFRED (*M*)
British International Pictures, Ltd., Elstree, Herts, Eng.
- HITCHCOCK, WM. H. D. (*M*)
The Gaumont Co., Ltd., Lime Grove Shepherds Bush, London, W. 12, Eng.
- HOCHSTETTER, FREDERICK W. (*A*)
Hochstetter Research Lab., Benedum Trees Bldg., Pittsburgh, Pa.
- HODGSON, J. S. (*M*)
155 Oxford St., London, W. 1, Eng.
- HOEFNER, FRED (*M*)
5319 Santa Monica Blvd., Los Angeles, Calif.
- HOGAN, TOM (*M*)
Pathé Audio Review, 35 W. 45th St., New York, N. Y.
- HOGUE, JOSEPH F. D. (*M*)
Bell Telephone Labs., Inc., 463 West St., New York, N. Y.
- HOLLANDER, HARRY (*A*)
315 W. 86th St., New York, N. Y.
- HOLMAN, ARTHUR J. (*M*)
59 Auburn St., Brookline, Mass.
- HOPKINS, PHILIP S. (*A*)
Sun Bldg., Binghamton, N. Y.
- HORNIDGE, HENRY T. (*A*)
Kiddle, Margeson, & Hornidge, 511 Fifth Ave., New York, N. Y.
- HORNSTEIN, JOSEPH C. (*A*)
Warner Bros. Pictures, 321 W. 44th St., New York, N. Y.
- HOWELL, A. S. (*M*)
Bell & Howell Co., 1801 Larchmont Ave., Chicago, Ill.
- HOWELL, JOHN F. (*M*)
Akeley Camera, Inc., 175 Varick St., New York, N. Y.
- HOXIE, CHARLES A. (*M*)
General Electric Co., Schenectady, N. Y.
- HOXIE, MERRILL C. (*M*)
RCA Photophone, Inc., Film House, Wardour St., London, W. 1, Eng.
- HUBBARD, ROSCOE C. (*M*)
Consolidated Film Industries, 1776 Broadway, New York, N. Y.
- HUBBARD, WM. C. (*M*)
111 W. 5th St., Plainfield, N. J.
- HUDSON, GEORGE (*M*)
Selo, Ltd., Brantwood, Essex, Eng.

- HUGHES, CYRIL M. (*M*)
Henrion Carbons, Ltd., Kinnaird
House, Pall Mall East, London,
S. W. 1, Eng.
- HULAN, ARL G. (*M*)
RCA Photophone, Inc., 411 Fifth
Ave., New York, N. Y.
- HUMPHREY, GLENN H. (*A*)
The Adcraft Film Service, 1312
Oswego St., Utica, N. Y.
- HUNT, FRANKLIN L. (*M*)
Bell Telephone Labs., Inc., 463 West
St., New York, N. Y.
- HUSE, EMERY (*M*)
Eastman Kodak Co., 6706 Santa
Monica Blvd., Hollywood, Calif.
- HYNDMAN, DONALD E. (*M*)
Eastman Kodak Co., 350 Madison
Ave., New York, N. Y.
- ISAAC, LESTER B. (*M*)
Loew's, Inc., 1540 Broadway, New
York, N. Y.
- IVES, F. E. (*Honorary*)
1753 N. 15th St., Philadelphia, Pa.
- IVINS, CLINTON F. (*A*)
Pathéscope Co. of America, Inc.,
35 W. 42nd St., New York, N. Y.
- JACHONTOW, EUGENE G. (*A*)
The Optical Institute, Bizjevaya
Linia 12, Leningrad, U. S. S. R.
- JAMES, F. E. (*M*)
General Electric Co., 5201 Santa Fe
Ave., Los Angeles, Calif.
- JAMIESON, HUGH V. (*A*)
1801 $\frac{1}{2}$ Commerce St., Dallas, Texas
- JARRETT, GEORGE J. (*A*)
Metropolitan Motion Picture Co.,
2310 Cass Ave., Detroit, Mich.
- JEFFERY, FREDERICK A. (*A*)
9 Giles St., Toorak, Adelaide, South
Australia
- JENKINS, C. FRANCIS (*Honorary*)
5502 16th St., Washington, D. C.
- JENKINS, J. ELLIOTT (*A*)
Jenkins & Adair, Inc., 3333 Belmont
Ave., Chicago, Ill.
- JENSEN, GEORGE K. (*M*)
Jensen & Co., Ship Yard, 116 War-
dour St., London, W. 1, Eng.
- JEWELL, EDWARD (*M*)
8212 Ridge Ave., Palisades del Rey,
Venice, Calif.
- JOACHIM, HERMAN E. A. (*A*)
Zeiss-Ikon A.-G., Schandauerstrasse,
76, Dresden a 21, Germany
- JOHN, ROBERT (*M*)
West End Plaza & West End Ave.,
Long Branch, N. J.
- JOHNSTONE, W. W. (*A*)
Bausch & Lomb Optical Co., 28
Geary St., San Francisco, Calif.
- JONES, JOHN G. (*M*)
Eastman Kodak Co., Kodak Park,
Rochester, N. Y.
- JONES, JOHN M., JR. (*A*)
433 Beaumont Ave., Charlotte, N. C.
- JONES, L. A. (*M*)
Research Laboratory, Eastman Ko-
dak Co., Rochester, N. Y.
- JOY, JOHN M. (*M*)
c/o Cortland Smith, 850 Tenth Ave.,
New York, N. Y.
- KALMUS, HERBERT T. (*M*)
Technicolor, Inc., 823 No. Seward
St., Hollywood, Calif.
- KATZ, LAWRENCE J. (*A*)
P. O. Box 929, Harrisburg, Pa.
- KELLER, EDWIN A. (*M*)
Grauman's Chinese Theater, Holly-
wood, Calif.
- KELLEY, WM. V. D. (*M*)
2228 Holly Drive, Hollywood, Calif.
- KERSHAW, CECIL (*M*)
A. Kershaw & Son, 300 Harehills
Lane, Leeds, Eng.
- KERST, WALTER D. (*A*)
32 Farley Rd., Scarsdale, N. Y.
- KEUFFEL, CARL W. (*A*)
Keuffel & Esser Co., 3rd & Adams
Sts., Hoboken, N. J.
- KIENNINGER, JOHN F. (*A*)
Technicolor Motion Picture Corp.,
120 Brookline Ave., Boston, Mass.

- KILBORN, ORSON (A)
Peroff Pictures, Inc., 67 W. 44th St.,
New York, N. Y.
- KIMBERLEY, PAUL (M)
National Screen Service, Ltd., 25
Denmark St., London, W. C. 2,
Eng.
- KING, FRANK (M)
1740 Winona Blvd., Hollywood,
Calif.
- KINSMAN, EDWARD G. (M)
R. G. Strange & Co., Ltd., 12 Little
Denmark St., London, W. C. 2,
Eng.
- KLEERUP, BERTEL J. (A)
Society for Visual Education, 327
LaSalle St., Chicago, Ill.
- KLENKE, JOHN JR. (M)
Visual Instruction Section, General
Electric Co., Schenectady, N. Y.
- KNOWLES, BERNARD J. (M)
"St. Raphaels" Hillrise, Gerrards
Cross, Bucks, Eng.
- KNOWLTON, JOHN J. (A)
Dept. 873-2, Western Electric Co.,
Kearney, N. J.
- KOLLMORGEN, FREDERICK L. G. (M)
The Kollmorgen Optical Corp., 767
Wythe Ave., Brooklyn, N. Y.
- KOMNENOS, NOTIS A. (A)
Stanley Co. of America, 11th & Mar-
ket Sts., Philadelphia, Pa.
- KRAEMER, GERARD I. (M)
16 Rue de Chateaudun, Asnieres
(Seine), France
- KRANZ, FRED W. (A)
Riverbank Laboratories, Geneva, Ill.
- KRASNA-KRAUS, ANDOR (A)
Friedrichstrasse 46, Berlin, S. W. 68,
Germany
- KROESEN, J. C. (M)
406 Belleville Ave., Belleville, N. J.
- KUHN, JOHN J. (M)
Bell Telephone Labs., Inc., 463 West
St., New York, N. Y.
- KUNZMAN, W. C. (M)
P. O. Box 400, Cleveland, Ohio
- KURLANDER, J. H. (M)
Westinghouse Lamp Co., Bloomfield,
N. J.
- LABAR, KEITH (A)
1915 N. Highland Place, Hollywood,
Calif.
- LACEY, R. MERRITT (M)
Duplex M. P. Industries, Long Island
City, N. Y.
- LAIR, C. (M)
Kodak-Pathé, 30 Rue des Vignerons,
Vincennes, France
- LALLY, WILLIAM J. (A)
7007 Hayes Ave., Jackson Heights,
L. I., N. Y.
- LAMB, ELGIE E. (M)
Bell & Howell Co., Ltd., 320 Regent
St., London, W. 1, Eng.
- LAMBERT, KENNETH B. (M)
Metro - Goldwyn - Mayer Studios,
127th St. & Second Ave., New
York, N. Y.
- LANE, A. LINDSLEY (M)
2334 Crenshaw Blvd., Los Angeles,
Calif.
- LANE, GEORGE (M)
Audio-Cinema Inc., 161 Harris Ave.,
Long Island City, N. Y.
- LANG, C. J. (M)
Lang Mfg. Works, Olean, N. Y.
- LANGFORD, LEROY P. (M)
National Theater Supply Co., 624 S.
Michigan Ave., Chicago, Ill.
- LAPORTE, NORBERT M. (M)
Paramount - Famous - Lasky Corp.,
1501 Broadway, New York, N. Y.
- LARUE, MERVIN W. (A)
5255 N. Hoyne Ave., Chicago, Ill.
- LASKY, MAX (M)
245 W. 55th St., New York, N. Y.
- LAUSTE, EMILE L. (M)
Cine Dept., Kodak, Ltd., Kingsway,
London, W. C. 2, Eng.
- LAVOY, MERL (A)
Pathé Exchange, 1926 S. Vermont
Ave., Los Angeles, Calif.

- LAWLEY, HENRY V. (*M*)
Lawley Apparatus Co., Ltd., 26
Church St., Charing X Road,
London, W. 1, Eng.
- LAWTON, FRANCIS, JR. (*A*)
Fisk Bldg., 250 W. 57th St., New
York, N. Y.
- LEISEN, JAMES M. (*M*)
1355 N. Laurel Ave., Hollywood,
Calif.
- LESHING, MICHAEL S. (*A*)
Fox West Coast Studios, Fox Films,
Los Angeles, Calif.
- LEVENTHAL, J. F. (*M*)
175 Varick St., New York, N. Y.
- LEWIS, WILLIAM W. (*A*)
543 Guerrero St., San Francisco,
Calif.
- LICHTE, H. (*M*)
Forschungsinstitut der A. E. G.,
Berlin, Germany
- LITTLE, ALEXANDER J. (*A*)
Celluloid Corp., 36 Aldermanbury,
London, E. C. 2, Eng.
- LITTLE, RICHARD S. (*A*)
S. Guiterman Co., Ltd., 35 Alder-
manbury, London, E. C. 2, Eng.
- LINS, PERCY A. (*A*)
Herbert & Huesgen Co., 18 E. 42nd
St., New York, N. Y.
- LITTLE, W. F. (*M*)
Electrical Testing Lab., 80th St. &
East End Ave., New York, N. Y.
- LOOTENS, CHARLES L. (*M*)
RCA Photophone, Inc., 411 Fifth
Ave., New York, N. Y.
- LOVELAND, ROGER P. (*M*)
Research Laboratory, Eastman Ko-
dak Co., Rochester, N. Y.
- LUCAS, GEORGE S. C. (*A*)
British Thomson Houston Co., Ltd.,
Rugby, Eng.
- LUFF, ALFRED H. (*A*)
Alliance Studios, St. Margarets-on-
Thames, Twickenham, Eng.
- LUHAR, CHIMANLAL M. (*A*)
Suresh Film Co., Ltd., Dadar Main
Road, Dadar, Bombay, 14, India.
- LUMMERZHEIM, HERMANN J. (*A*)
Filmfabrik, Wolfen (Kreis Bitter-
feld), Germany
- LUNDAHL, TORE (*M*)
Pacent Reproducer Corp., Film Cen-
tre Bldg., New York, N. Y.
- LYNG, JOHN J. (*M*)
Electrical Research Products, Inc.,
250 W. 57th St., New York, N. Y.
- MAAS, ARTHUR R. (*A*)
A. R. Maas Chemical Co., 308 E.
Eighth St., Los Angeles, Calif.
- MACKENZIE, DONALD (*M*)
Electrical Research Products, Inc.,
7046 Hollywood Blvd., Los
Angeles, Calif.
- MACLEOD, J. S. (*M*)
Metro-Goldwyn-Mayer Pictures,
1540 Broadway, New York, N. Y.
- MACNAIR, WALTER A. (*M*)
Bell Telephone Labs., Inc., 463 West
St., New York, N. Y.
- MAIRE, HENRY J. (*A*)
5646 Kingsessing Ave., Philadelphia,
Pa.
- MALITZ, FELIX (*A*)
UFA Films, Inc., 1540 Broadway,
New York, N. Y.
- MALKAMES, DON (*M*)
133 Westminster St., Wilkes-Barre,
Pa.
- MALOFF, LOURY (*A*)
Box 105, Rochester, N. Y.
- MANCHEE, ALLEYNE W. (*M*)
Audio-Cinema, Inc., 161 Harris Ave.,
Long Island City, N. Y.
- MANHEIMER, J. R., (*M*)
E. J. Electrical Installation Co.,
155 E. 44th St., New York, N. Y.
- MARCUS, G. KEVA (*A*)
Seiden Films, Inc., 729 Seventh Ave.,
New York, N. Y.
- MARETTE, JACQUES (*M*)
Pathé Cinema, 117 Blvd. Hauss-
man, Paris, 8^{eme}, France

- MARINER, A. R. (*M*)
Visugraphic Pictures, Inc., 247 Park Ave., New York, N. Y.
- MARLEY, JOHN PEVERELL (*M*)
Metro-Goldwyn-Mayer Studios, Culver City, Calif.
- MARSH, HENRY N. (*A*)
Technical Division, Hercules Powder Co., Wilmington, Del.
- MARSHALL, J. G. (*M*)
1752 Atlantic Ave., Brooklyn, N. Y.
- MARVIN, HARRY B. (*M*)
General Electric Co., Schenectady, N. Y.
- MATHER, GEORGE E. (*M*)
Electrical Research Products, Inc., 250 W. 57th St., New York, N. Y.
- MATHOT, JACQUES A. (*A*)
Eclair Tirage, Usine d'Épinay sur Seine, 2 Av d'Enghien (Seine), France
- MATLACK, CLAUDE C. (*A*)
327 23rd St., Miami Beach, Fla.
- MATSON, ROBERT (*M*)
Motion Picture Engineering Co., 2332 Clifford St., Detroit, Mich.
- MATTHEWS, GLENN E. (*A*)
Research Laboratory, Eastman Kodak Co., Rochester, N. Y.
- MATTHEWS, JAMES (*A*)
P. O. Box 1629, Manila, P. I.
- MAUDSLAY, GEORGE C. (*A*)
National Carbon Co., 599 Eighth St., San Francisco, Calif.
- MAXFIELD, J. P. (*M*)
1522 N. Stanley Ave., Hollywood, Calif.
- MAYER, MAX (*M*)
233 W. 42nd St., New York, N. Y.
- MCAULEY, J. E. (*M*)
McAuley Mfg. Co., 552 W. Adams St., Chicago, Ill.
- MCLINTOCK, NORMAN (*A*)
504 Amberson Ave., Pittsburgh, Pa.
- MCCONNELL, CHARLES R. (*M*)
Bell Telephone Labs., Inc., 463 West St., New York, N. Y.
- MCCOY, JAMES L. (*A*)
Westinghouse Lamp Co., Bloomfield, N. J.
- MCCULLOUGH, R. H. (*M*)
West Coast Theaters, Inc., Washington & Vermont Aves., Los Angeles, Calif.
- MCDOWELL, JOHN B. (*M*)
Agfa, Ltd., Vintry House, Iveen St. Place, London, E. C. 4, Eng.
- MCGINNIS, F. J. (*A*)
Box 2387, Palm Beach, Fla.
- MCGLINNEN, EARL J. (*A*)
Fox Theaters, 2211 Woodward Ave., Detroit, Mich.
- MCGUIRE, PERCIVAL A. (*A*)
International Projector Corp., 90 Gold St., New York, N. Y.
- MCNABB, J. H. (*M*)
Bell & Howell Co., 1801 Larchmont Ave., Chicago, Ill.
- MCNICHOL, DONALD (*A*)
Projection Engineering, 52 Vanderbilt Ave., New York, N. Y.
- MCRAE, DONALD (*A*)
J. E. McAuley Mfg. Co., 552 W. Adams St., Chicago, Ill.
- MECHAU, EMIL (*A*)
E. Leitz, Inc., Rastatt, Germany
- MEEHAN, J. LEO (*A*)
395 Madrona Lane, Bel-Air, Los Angeles, Calif.
- MEES, C. E. K. (*M*)
Research Laboratory, Eastman Kodak Co., Rochester, N. Y.
- MEHTA, HARSHADRAI S. (*A*)
Suresh Film Co., Dadar Main Rd., Dadar, Bombay, 14, India
- MENGE, OTTO F. (*A*)
256 Main St., Buffalo, N. Y.
- METZGER, MAURICE (*A*)
Associated Screen News, Ltd., Western Ave. & Delcarie Blvd., Montreal, Que., Can.
- MEYER, HERBERT (*A*)
Agfa-Ansco Corp., Binghamton, N. Y.

- MIEHLING, RUDOLPH (*M*)
 Universal Sound System, Inc., 13th
 & Cherry Sts., Philadelphia, Pa.
- MIKETTA, CASIMIR A. (*M*)
 Lyon & Lyon, National City Bank
 Bldg., Los Angeles, Calif.
- MILLER, ROBERT A. (*M*)
 Bell Telephone Labs., Inc., 463 West
 St., New York, N. Y.
- MILLER, WESLEY C. (*A*)
 Metro-Goldwyn-Mayer, Culver City,
 Calif.
- MISTRY, D. L. (*M*)
 24 Nepean Road, Malabar Hill,
 Bombay, 6, India
- MISTRY, M. L. (*M*)
 24 Nepean Road, Malabar Hill,
 Bombay, 6, India
- MITCHELL, GEORGE A. (*M*)
 Mitchell Camera Corp., 655 N.
 Robertson Blvd., W. Hollywood,
 Calif.
- MITCHELL, R. FAWN (*A*)
 5017 N. Lincoln St., Chicago, Ill.
- MOLE, P. (*M*)
 Mole-Richardson, Inc., 941 N. Sycamore
 Ave., Hollywood, Calif.
- MORENO, R. M. (*A*)
 DuPont-Pathé Film Mfg. Corp.,
 Parlin, N. J.
- MORRIS, LLOYD P. (*A*)
 606 W. Elm St., Urbana, Ill.
- MORTON, H. S. (*M*)
 3787 Chicago Blvd., Detroit, Mich.
- MORTON, WM. MCK. (*A*)
 R. F. D. No. 7, Knoxville, Tenn.
- MOYSE, HOLLIS W. (*M*)
 DuPont-Pathé Film Mfg. Corp.,
 Parlin, N. J.
- MUELLER, WILLIAM A. (*M*)
 Vitaphone Corp., 5842 Sunset Blvd.,
 Hollywood, Calif.
- MULLER, JOHN P. (*A*)
 2629 Calhoun St., New Orleans, La.
- MURPHY, MELVIN J. (*M*)
 75 East Blvd., Rochester, N. Y.
- MURRAY, WILLIAM W. (*A*)
 528 Madison Ave. Scranton, Pa.
- MYERS, DUDLEY T. (*M*)
 British International Pictures, Ltd.,
 Elstree, Herts, Eng.
- MYERS, LOUIS E. (*A*)
 4516 Sunset Blvd., Hollywood, Calif.
- NAGASE, TOKUTARO (*M*)
 D. Nagase & Co., Ltd., Itachibori-
 Minamidori-Nishiku, Osaka, Ja-
 pan
- NELSON, OTTO (*M*)
 National Cash Register Co., Dayton,
 Ohio
- NEWMAN, ARTHUR S. (*M*)
 2 Salisbury Road, Highgate Hill,
 London, N. 19, Eng.
- NICHOLS, EDW. C. C. (*M*)
 Gaumont British Picture Corp.,
 New Gallery House, 123 Regent
 St., London, S. W., Eng.
- NICHOLSON, ROBERT F. (*M*)
 Phi Gamma Delta Club, 106 W. 56th
 St., New York, N. Y.
- NICKOLAUS, JOHN M. (*M*)
 Metro - Goldwyn - Mayer Studios,
 Culver City, Calif.
- NIEMANN, CARL H. (*A*)
 Korting & Mathiesen Electrical, Ltd.,
 711 Fulham Road, London, S. W.
 6, Eng.
- NIETER, HANS M. (*M*)
 British Schufftan Process, Ltd., Els-
 tree, Herts, Eng.
- NIXON, IVAN L. (*M*)
 Bausch & Lomb Optical Co., Roch-
 ester, N. Y.
- NOLAN, RAYMOND (*A*)
 Fox-Hearst Corp., 460 W. 54th St.,
 New York, N. Y.
- NORDEN, KONRAD (*M*)
 Allgemeine Elektrizitäts-Gesellschaft
 Friedrich Karl-Ufer 2/4, Berlin,
 N. W. 40, Germany
- NORLING, J. A. (*M*)
 Loucks & Norling, 245 W. 55th St.,
 New York, N. Y.

- NORRISH, B. E. (*M*)
Associated Screen News of Canada,
Ltd., Western Ave. & Delcarie
Blvd., Montreal, Que., Can.
- OAKLEY, NORMAN F. (*A*)
DuPont-Pathé Film Mfg. Corp.,
Parlin, N. J.
- ODELL, LESLIE F. (*A*)
British Talking Pictures, Ltd., Wem-
bley Park, Middlesex, Eng.
- O'DONNELL, JOSEPH P. (*M*)
Cinema Studios Supply Corp., 1438
N. Beachwood Drive, Hollywood,
Calif.
- OLSON, EDWARD B. (*A*)
3957 S. Broadway, Los Angeles,
Calif.
- OLSON, JAMES W. (*A*)
National Theater Supply Co., 2310
Cass Ave., Detroit, Mich.
- ORAM, EDWIN (*A*)
Taylor, Taylor & Hobson, Ltd., 74
Newman St., London, W. 1, Eng.
- ORMSTON, FRANK D. (*M*)
RCA Photophone, Inc., 411 Fifth
Ave., New York, N. Y.
- ORTH, GEORGE (*A*)
131 Nagle Ave., New York, N. Y.
- OSBORNE, A. W. (*A*)
"Hilton" North Drive, Ruislip,
Middlesex, Eng.
- OWENS, FREEMAN H. (*A*)
2647 Broadway, New York, N. Y.
- PACENT, LOUIS G. (*M*)
Pacent Reproducer Corp., 91
Seventh Ave., New York, N. Y.
- PAGE, LOUIS I. (*A*)
RKO Studios, Inc., 780 Gower St.,
Hollywood, Calif.
- PALMER, M. W. (*M*)
Paramount - Famous - Lasky Corp.,
6th & Pierce Aves., Long Island
City, N. Y.
- PARKER, OLIVER B. (*M*)
Pacent Electric Co., 91 Seventh Ave.,
New York, N. Y.
- PARKINS, CLAUDE F. (*A*)
Studio Film Labs., Ltd., 80 Wardour
St., London, W. 1, Eng.
- PARSHLEY, CHARLES W. (*A*)
University Theater, Cambridge,
Mass.
- PATERSON, FRANK T. (*A*)
Oriole Theater, Detroit, Mich.
- PATTON, GEORGE E. (*M*)
Ontario Govt. M. P. Bureau, Parlia-
ment Bldg., Toronto, Ontario,
Can.
- PEARSON, GEORGE W. (*M*)
3 Rupert St., London, W. 1, Eng.
- PECK, CHARLES DE ROSSA (*A*)
309 W. Douglas Ave., Wichita, Kans.
- PENNOW, WILLIS A. (*A*)
Lit-War Co., Wellston, Ohio
- PENROD, A. C. (*A*)
Bristol Studios, Waterbury, Conn.
- PEREIRA, ARTHUR (*M*)
498 Hornsey Road, London, N. 19,
Eng.
- PERISSI, HARRY F. (*A*)
44 Whitehall St., New-York, N. Y.
- PETERSON, F. W. (*M*)
I. G. Farbenindustrie Aktiengesell-
schaft, Kinetechnische Abteilung,
Berlin, S. O. 36, Germany
- PETTENGILL, GEORGE W., JR. (*A*)
Motion Picture Service Co., 125
Eighth St., N., St. Petersburg, Fla.
- PETTERSON, SVEN ARVID (*A*)
Hasselblads Fotografiska, A. B. 16,
Hamngatan, Stockholm, Sweden
- PEYTON, JOHN T. (*A*)
Griffith Amusement Co., 11½ N.
Lee St., Oklahoma City, Okla.
- PFEIL, EUGENE A. (*A*)
P. O. Box 2, Kenmore, N. Y.
- PHELPS, L. G. (*M*)
Phelps-Films, Inc., 126 Meadow St.,
New Haven, Conn.
- PHILLIPS, FRANK B. (*A*)
Kodak, Ltd., Wealdstone, Middle-
sex, Eng.
- PHILLIPS, JOSEPH J., JR. (*A*)
5510 Baum Blvd., Pittsburgh, Pa.

- PHILLIPS, LOUIS (A)
National Theater Supply Co., 133
Meadow St., New Haven, Conn.
- PHILLMORE, C. E. (A)
138 N. Parkside Ave., Chicago, Ill.
- PLANSKOY, LEONTI (M)
83 Al. Yerozolimska, Warsaw, Po-
land
- POLLACK, A. M. (A)
American Silversheet Co., 800-812
Beaumont St., St. Louis, Mo.
- POMEROY, ROY J. (M)
1626 N. Crescent Heights, Holly-
wood, Calif.
- PORTER, C. D. (A)
Public Theaters Corp., 57 Ellis St.,
N. E., Atlanta, Ga.
- PORTER, LAWRENCE C. (M)
Engr. Dept., General Electric Co.,
Nela Park, Cleveland, Ohio
- POTTER, ROBERT (A)
General Talking Picture Corp., 318
East 48th St., New York, N. Y.
- POWERS, WALTER P. (M)
Pacnet Reproducer Corp., Film
Centre Bldg., New York, N. Y.
- POWRIE, JOHN H. (M)
Warner Research Lab., 461 Eighth
Ave., New York, N. Y.
- PRICE, ARNOLD F. (M)
Bell Telephone Labs., Inc., 463 West
St., New York, N. Y.
- PUFFER, B. FRANK (M)
Symzak, 100 W. 72nd St., New
York, N. Y.
- PULVER, M. (M)
Duncan Watson & Co., 62 Berners
St., London, W. 1, Eng.
- QUELCH, ALBERT L. (M)
British Screen Productions, Ltd.,
Worton Hall Studios, Isleworth,
Eng.
- QUINLAN, WALTER (M)
Fox Film Corp., 1401 Northwestern
Ave., Hollywood, Calif.
- RACKETT, GERALD F. (M)
1129 Browning Blvd., Los Angeles,
Calif.
- RAESS, H. F. (A)
Warner Research Laboratory, 461
Eighth Ave., New York, N. Y.
- RALKE, CARL H. (A)
Bell & Howell Co., 6324 Santa Mon-
ica Blvd., Hollywood, Calif.
- RAMSAYE, TERRY (M)
Pathé Exchange, Inc., 35 W. 45th St.,
New York, N. Y.
- RANIERI, LUIGI (M)
Societa Anonima Italiana Cinema
Educativo, 37 Piazza Poli, Rome,
Italy
- RAVEN, A. L. (M)
Raven Screen Corp., 1476 Broadway,
New York, N. Y.
- RAY, REID H. (M)
Ray-Bell Films, Inc., 817 University
Ave., St. Paul, Minn.
- RAYMOND, MATTHEW (M)
35 Grosvenor Place, London, S. W. 1,
Eng.
- RAYTON, WILLIAM B. (M)
Bausch & Lomb Optical Co., Roch-
ester, N. Y.
- REARDON, JAMES (M)
Welsh Pearson Elder Films, Ltd.,
3 Rupert St., London, W. Eng.
- REDHEAD, JOHN C. A. (A)
Kodak, Ltd., Wealdstone, Middle-
sex, Eng.
- REDPATH, WM. (M)
156 King St., W., Toronto, Ont., Can.
- REEB, OTTO G. L. (A)
Rotherstrasse 20-23, Berlin O. 17,
Germany
- REEVES, ARTHUR (A)
1605 N. Cahuenga Ave., Hollywood,
Calif.
- REICH, CARL J. (M)
Seebold Invisible Camera Corp., 739
Clinton Ave., Rochester, N. Y.
- REIFSTECK, CARL N. (A)
Westinghouse Electric & Mfg. Co.,
East Pittsburgh, Pa.

- RENWICK, F. F. (*A*)
British Photo Plates & Papers, Ltd.,
Rodenside Laboratory, Ilford,
Essex, Eng.
- RICH, G. WILLARD (*A*)
Williams, Rich, & Morse, 61 Broad-
way, New York, N. Y.
- RICHARD, A. P. A. (*A*)
Service Technique, Eclair Tirage,
12 Rue Gaillon, Paris, France
- RICHARDSON, E. C. (*M*)
Mole-Richardson Inc., 941 N. Sycamore
Ave., Hollywood, Calif.
- RICHARDSON, FRANK H. (*M*)
1148 Boynton Ave., New York, N. Y.
- RICKER, MAURICE (*A*)
39-23 58th St., Woodside, L. I., N. Y.
- RICKS, HUBERT M. (*A*)
Weston Electrical Instrument Corp.,
614 Frelinghuysen Ave., Newark,
N. J.
- RINALDY, E. S. (*A*)
Chester, N. J.
- RITSON, ROBERT (*A*)
14 Mayfield Ave., North Finchley,
London, N. 9, Eng.
- ROBERTS, JOHN G. (*A*)
Bell Telephone Labs., Inc., 463 West
St., New York, N. Y.
- ROBIN, JOSEPH E. (*M*)
1352 University Ave., New York, N. Y.
- ROBINSON, K. D. (*A*)
Photographic Research Lab., 2 W.
16th St., New York, N. Y.
- ROBINSON, LEWIS T. (*M*)
General Engr. Laboratory, General
Electric Co., Schenectady, N. Y.
- ROEMER, H. H. (*M*)
Lake Shore Towers, 12 Apt. North,
3920 Lake Shore Drive, Chicago,
Ill. *Via* Lake View P. O.
- ROGERS, JAMES E. (*M*)
"Cluny" Deacons Hill Road Elstree,
Herts, Eng.
- ROGERS, ROWLAND (*A*)
Picture Service Corp., 74 Sherman
St., at Harris Ave., Long Island
City, N. Y.
- ROLAND, EDWARD C. (*M*)
Ilex Optical Co., 726 Portland Ave.,
Rochester, N. Y.
- ROSEMAN, ISIDORE (*A*)
Kodak A.-G., Markgrafenstrasse 7-6,
Berlin, Germany
- ROSEN, JOSEPH (*A*)
Publix Theaters Corp., 60 Scollay
Square, Boston, Mass.
- ROSENBERGER, HEINZ (*A*)
Rockefeller Institute, 66th St. &
Ave. A., New York, N. Y.
- ROSENTHAL, ALFRED (*A*)
Zimmerstrasse 35, Berlin, S. W. 68,
Germany
- ROSS, O. A. (*M*)
198 Broadway, Room 903, New
York, N. Y.
- ROSS, PHIL (*M*)
19 Mayow Rd., Forest Hill, London,
S. E. 23, Eng.
- ROTHENBERG, MAURICE (*A*)
Globe Theater, Boston, Mass.
- ROWSON, SIMON (*M*)
76 Wardour St., London, W. 1,
Eng.
- ROY, ERNEST G. (*M*)
Kay Film Printing Labs., Ltd., 49 A
Oxford Rd., Finsbury Park,
London, Eng.
- RUBIN, HARRY (*A*)
Publix Theaters Corp., Paramount
Bldg., Times Square, New York
N. Y.
- RUDOLPH, PAUL (*M*)
Grosbieszitz near Goerlitz, Silesia,
Germany
- RUDOLPH, WILLIAM F. (*A*)
Famous-Players-Lasky Corp., 5451
Marathon St., Los Angeles, Calif.
- RUOT, MARCEL (*A*)
Cine Kodak Service Japan, Inc.,
Dojima Bldg., Osaka, Japan
- RUSSELL, WESLEY F. (*M*)
Hall & Connolly, Inc., 24 Van Dam
St., New York, N. Y.

- SABINE, PAUL E. (A)
Riverbank Laboratories, Geneva,
Ill.
- SAMUELS, IRVING (A)
Automatic Devices Co., Hunsicker
Bldg., Allentown, Pa.
- SANIAL, ARTHUR J. (M)
365 W. 20th St., New York, N. Y.
- SANTÉE, HOWARD B. (M)
Electrical Research Products, Inc.,
250 W. 57th St., New York, N. Y.
- SAVILLE, VICTOR (M)
Burlington Films, Ltd., 80 Regent
St., London, W. 1, Eng.
- SCHADE, WILLY (A)
Ilex Optical Co., 726 Portland Ave.,
Rochester, N. Y.
- SCHMID, FRED (M)
C. P. Goerz American Optical Co.,
317 E. 34th St., New York, N. Y.
- SCHMITZ, ERNEST C. (A)
Kodak Co., 39 Ave. Montaigne,
Paris, France
- SCHULTE, WALTER B. (A)
Burgess Battery Co., Madison, Wis.
- SCHWARTZ, GARÉ (M)
9 Deacon Hill Road, Elstree, Herts,
Eng.
- SCHWARZ, G. ALFRED (A)
The Columbus Industrial Film Co.,
150 S. 3rd St., Columbus, Ohio
- SCRIVEN, EDWARD O. (M)
Bell Telephone Labs., Inc., 463
West St., New York, N. Y.
- SEASE, VIRGIL B. (M)
DuPont-Pathé Film Mfg. Co., Parlin,
N. J.
- SEILER, ALVIN (A)
National Theater Supply Co., 723
Seventh Ave., New York, N. Y.
- SENNER, ADOLPH G. (A)
422 E. 58th St., New York, N. Y.
- SERRURIER, IWAN (M)
Moviola Co., 1451 Gordon St.,
Hollywood, Calif.
- SETHI, GOBIND R. (A)
% American Express Co., 65 Broad-
way, New York, N. Y.
- SHACKELFORD, J. B. (A)
455 N. Formosa St., Hollywood,
Calif.
- SHAFRANEK, LAWRENCE J. (A)
Rialto Theater, West 25th St. &
Bridge Ave., Cleveland, Ohio
- SHAMRAY, P. L. (M)
Smith & Aller, Inc., 6656 Santa
Monica Blvd., Hollywood, Calif.
- SHANNON, J. T. (M)
Keese Engineering Co., 7380 Santa
Monica Blvd., Hollywood, Calif.
- SHAPIRO, A. (M)
Universal Stamping & Mfg. Co., 2939
N. Western Ave., Chicago, Ill.
- SHEA, TIMOTHY E. (M)
Bell Telephone Labs., Inc., 463 West
St., New York, N. Y.
- SHEPPARD, SAMUEL E. (M)
Research Laboratory, Eastman Ko-
dak Co., Rochester, N. Y.
- SHIMEK, JOHN A. (A)
Bell & Howell Co., Rockwell &
Belle Plaine Ave., Chicago, Ill.
- SHOTWELL, HAROLD H. (A)
Operadio Mfg. Co., 13th & Indiana
Sts., St. Charles, Ill.
- SIMPSON, FREDERICK H., JR. (A)
Box 208, Kingston, Ont. Can.
- SINTZENICH, HAROLD A. C. (M)
Kodak House, Hornby Road, Bom-
bay, India
- SISTROM, WILLIAM (M)
Pathé Studio, Culver City, Calif.
- SKINNER, GEORGE A. (A)
114 E. 52nd St., New York, N. Y.
- SKITTRELL, J. Y. (M)
Olympic Kinematograph Labora-
tory, School Road, London, W. 10,
Eng.
- SLOAN, JAMES B. (A)
4, The Avenue, Bedford Park,
London, W. 4, Eng.
- SLOMAN, CHERI M. (A)
3008 Lakewood Ave., Detroit, Mich.
- SMACK, JOHN C. (A)
S. S. White Dental Mfg. Co., 152
W. 42nd St., New York, N. Y.

- SMITH, J. W. (*M*)
Williamson Film Printing Co., 80
Wardour St., London, W. C. 1,
Eng.
- SMITH, J. WESLEY (*M*)
Smith & Aller, Inc., 6656 Santa
Monica Blvd., Hollywood, Calif.
- SMITH, W. C. (*M*)
Educational Studio, 7260 Santa
Monica Blvd., Los Angeles, Calif.
- SMITH, JOHN C. (*M*)
Asiatic Explorations, Inc., P. O. B.
82, Bangkok, Siam
- SNOW, CLARENCE H. (*M*)
DeFrenes & Co., 60 N. State St.,
Wilkes-Barre, Pa.
- SPAHR, ORAL F. (*M*)
Enterprise Optical Co., 564 W. Ran-
dolph St., Chicago, Ill.
- SPENCE, JOHN L., JR. (*M*)
Akeley Camera, Inc., 175 Varick St.,
New York, N. Y.
- SPONABLE, EARL I. (*M*)
277 Park Ave., New York, N. Y.
- SPRAY, JOSEPH H. (*M*)
Warner Bros. Pictures, Inc., 1277 E.
14th St., Brooklyn, N. Y.
- STAFFORD, J. W. (*A*)
Fox Film Corp., 850 Tenth Ave.,
New York, N. Y.
- STAMBAUGH, CHARLES D. (*A*)
Art Film Studios, Inc., 6601 Euclid
Ave., Cleveland, Ohio
- STAMBAUGH, REX V. (*M*)
Art Film Studios, Inc., 6601 Euclid
Ave., Cleveland, Ohio
- STECHEBART, BRUNO E. (*M*)
Bell & Howell Co., 1801 Larchmont
Ave., Chicago, Ill.
- STEDEROTH, FRED F. (*A*)
41 Watsessing Ave., Bloomfield, N. J.
- STEIN, ADAM, JR. (*A*)
Acoustic Products Corp., 50 W.
57th St., New York, N. Y.
- STERN, ERNEST (*A*)
Film Pioneers, 161 Harris Ave., Long
Island City, N. Y.
- STINEMAN, R. P. (*M*)
918 Sunset Blvd., Los Angeles, Calif.
- STOLLER, H. M. (*M*)
Bell Telephone Labs., Inc., 463 West
St., New York, N. Y.
- STONE, CARRINGTON H. (*A*)
Jenkins & Adair, Inc., 2815 Mildred
Ave. (Lakeview), Chicago, Ill.
- STORY, FRANK J. (*A*)
624 Ingraham St., N. W., Washing-
ton, D. C.
- STRANGE, REGINALD G. (*M*)
R. G. Strange & Co., Ltd., 12 Little
Denmark St., London, W. C. 2,
Eng.
- STRENGE, F. WALTER (*M*)
961 Washington Ave., Brooklyn, N. Y.
- STRICKLER, J. F. (*A*)
Jam Handy Pictures Corp., 6227
Broadway, Chicago, Ill.
- STRONG, HARRY H. (*A*)
Strong Electric Co., 2501 LaGrange
St., Toledo, Ohio
- STRUBLE, CORNELIUS D. (*A*)
640 W. 69th Terrace, Kansas City,
Mo.
- STRUSS, KARL (*M*)
United Artists Studio, D. W. Grif-
fith, 1041 N. Formosa St., Holly-
wood, Calif.
- STUBBE, GERHARD (*A*)
American Askania Corp., 1024 Ma-
rine Bank Bldg., Houston, Texas
- SUDZUKY, SHIGE (*M*)
"Kyoeki-Sho-Sho," 44 Matsumoto-
cho, Shiba, Tokio, Japan
- SULLIVAN, THEODORE (*M*)
1129 Detroit St., Hollywood, Calif.
- SUMMERS, JOHN A. (*M*)
Engr. Dept., General Electric Co.,
Nela Park, Cleveland, Ohio
- SWAAB, M. L. (*A*)
National Theater Supply Co., 1315-
17 Vine St., Philadelphia, Pa.
- TAMLIN, B. G. (*A*)
9 Giles St., c/o Jeffery Lab., Rose
Park, So. Australia

- TATTENHAM, DANIEL F. (A)
Kalocolor Pictures, Inc., 666 Lake
Shore Drive, Chicago, Ill.
- TAYLOR, ARTHUR J. (M)
Automatic Film Printers, Ltd.,
Charles St., Barnes, London, Eng.
- TAYLOR, JOHN B. (M)
General Electric Co., Schenectady,
N. Y.
- TAYLOR, LAURENS A. (M)
Radio Engr. Dept., General Electric
Co., Schenectady, N. Y.
- TEITEL, ALBERT (M)
Protecto Film, Inc., 105 W. 40th St.,
New York, N. Y.
- TERRANEAU, RANDAL (M)
"Daughne" Sheen Common Drive,
Richmond, Surrey, Eng.
- TERRY, ROY V. (M)
Bell Telephone Labs., Inc., 463 West
St., New York, N. Y.
- THEISS, JOHN H. (M)
35 Linden Ave., Metuchen, N. J.
- THOMAS, WILLIAM A. (A)
259 Wilbank Ave., Greenwich, Conn.
- THOMAS, WILLIAM F. (A)
3200 Boston Blvd., Apt. 5, Detroit,
Mich.
- THORNTON, CECIL V. (A)
British International Pictures, Ltd.,
Elstree, Herts, Eng.
- TOUZE, GEORGES (A)
First National Pathé, Ltd., 103
Wardour St., London, W. 1,
Eng.
- TOWNSEND, LEWIS M. (M)
Paramount-Famous-Lasky Corp.,
Paramount Bldg., New York,
N. Y.
- TOZER, ALEXANDER R. (M)
Pathé of France, Ltd., 5 Lisle St.,
London, W. C. 2, Eng.
- TROLAND, LEONARD T. (M)
Technicolor Motion Picture Corp.,
120 Brookline Ave., Boston, Mass
- TRONOLONE, CHARLES (M)
Consolidated Film Industries, 1776
Broadway, New York, N. Y.
- TRONOLONE, NICK (M)
Consolidated Film Industries, 203
W. 146th St., New York, N. Y.
- TUTTLE, H. B. (M)
Eastman Kodak Co., 343 State
Street, Rochester, N. Y.
- TUTTON, FREDERIC G. (A)
W. O. Floing, Inc., 11 E. 47th St.,
New York, N. Y.
- VAUGHN, EDWARD A. P. (M)
National Screen Service, Ltd., 25
Denmark St., London, W. C. 2,
Eng.
- VARNIER, M. C. (A)
Route 1, Box 92D, Fort Pierce, Fla.
- VENTIMIGLIA, GAETANO (A)
18, Abinger Road, Chiswick, Lon-
don, W. 4, Eng.
- VICTOR, A. F. (M)
242 W. 55th St., New York, N. Y.
- VINTEN, WILLIAM C. (M)
106 Wardour St., London, W. 1, Eng.
- VOLCK, A. GEORGE (M)
6627 Emmett Terrace, Hollywood,
Calif.
- WAKE, SYDNEY (M)
Standard Kine Labs., Ltd., 49 Greek
St., London, W. 1, Eng.
- WALEY, HUBERT D. (A)
51 Ladbroke Grove, London, W. 11,
Eng.
- WALLER, FRED (M)
R. F. D. No. 3, Huntington, N. Y.
- WARMISHAM, ARTHUR (A)
Taylor, Taylor & Hobson, Leicester,
Eng.
- WATKINS, STANLEY S. A. (M)
Western Electric Co., Bush House,
Aldwych, London, W. C. 2, Eng.
- WATSON, J. S., JR. (A)
6 Sibley Place, Rochester, N. Y.
- WATTS, FREDERICK (M)
First National Pathé, Ltd., 103
Wardour St., London, W. 1, Eng.
- WAYLAND, LLOYD K. (A)
511 Eleanor St., Knoxville, Tenn.

- WELMAN, VICTOR A. (A)
207 Finance Bldg., Cleveland, Ohio
- WELSH, THOMAS A. (M)
Welsh Pearson Elder Films, Ltd.,
3 Rupert St., London, W. 1, Eng.
- WENTE, EDWARD C. (M)
Bell Telephone Labs., Inc., 463 West
St., New York, N. Y.
- WEST, HORACE B. (A)
Kodak, Ltd., Wealdstone, Middle-
sex, Eng.
- WHITEHEAD, ARTHUR J. (A)
Filmophone, Ltd., 101 Wardour St.,
London, W. 1, Eng.
- WHITEHOUSE, JOHN H. A. (A)
Windrush, Ruislip, Middlesex, Eng.
- WHITING, DONALD F. (M)
Fox-Hearst Corp., 460 W. 54th St.,
New York, N. Y.
- WHITMORE, WILL (A)
Electrical Research Products, Inc.,
250 W. 57th St., New York, N. Y.
- WILDING, NORMAN E. (A)
Wilding Picture Productions, Inc.,
1358 Mullett St., Detroit, Mich.
- WILLIAMSON, ALAN J. (M)
Four Winds, Longdown Lane, Ep-
som Downs, Surrey, Eng.
- WILLIAMSON, C. M. (A)
Williamson Mfg. Co., Ltd., Litch-
field Gardens, London, N. W. 10,
Eng.
- WILLFORD, E. A. (M)
National Carbon Co., P. O. Box 400,
Cleveland, Ohio
- WILSON, STUART K. (A)
12 Whitehall Rd., Harrow, Eng.
- WILSTACH, FRANK J. (M)
Motion Picture Producers & Dis-
tributors of America, Inc., 469
Fifth Ave., New York, N. Y.
- WINN, CURTIS B., JR. (A)
212½ East "C" St. & Euclid Ave.,
Ontario, Calif.
- WINTERMAN, CLEMENCE (M)
Brent Laboratories, North Circular
Road, London, N. W. 2, Eng.
- WOLFERZ, ALFRED H. (A)
Weston Electrical Instrument Corp.,
614 Frelinghuysen Ave., Newark,
N. J.
- WOOD, HAROLD (M)
Film Department, Kodak, Ltd.,
Kingsway, London, W. C. 2, Eng.
- WOODS, FRANK E. (M)
Academy M. P. Arts & Sciences,
7010 Hollywood Blvd., Hollywood,
Calif.
- WOODS-TAYLOR, GEORGE (M)
British Filmcraft Productions, Ltd.,
Wood St., Walthamstow, Eng.
- WOOLFE, HARRY B. (M)
British Instructional Films, Ltd.,
46 Brewer St., London, W., Eng.
- WORSHAM, OSCAR L. (A)
206 Burwell Ave., Knoxville, Tenn.
- YOUNG, AL. (M)
Du-Art Film Labs., Inc., 245 W. 55th
St., New York, N. Y.
- ZERK, OSCAR U. (M)
665 Grace St., Chicago, Ill.
- ZIEBARTH, C. A. (M)
Bell & Howell Co., 1801 Larchmont
Ave., Chicago, Ill.
- ZUBER, JOHN G. (A)
Bell & Howell Co., 1801 Larchmont
Ave., Chicago, Ill.
- ZUCKER, FRANK C. (A)
220 W. 42nd St., New York, N. Y.

SUSTAINING MEMBERS

Agfa Ansco Corporation
 Audio-Cinema, Inc.
 Bausch & Lomb Optical Co.
 Bell & Howell Co.
 Bell Telephone Laboratories, Inc.
 Case Research Laboratory
 Consolidated Film Industries
 DuPont-Pathé Film Manufacturing Corp.
 Eastman Kodak Co.
 Electrical Research Products, Inc.
 General Theatres Equipment Co.
 Mole-Richardson, Inc.
 National Carbon Co.
 Paramount-Famous-Lasky Corp.
 RCA Photophone, Inc.
 Technicolor Motion Picture Corp.

Transactions of the S. M. P. E.

A limited number of most of the issues of the *Transactions* is still available. These will be sold at the prices listed below.

Please note that nos. 1, 6, 8, and 9 are out of print.

Orders should be addressed direct to the *Secretary*, J. H. Kurlander, Westinghouse Lamp Co., Bloomfield, N. J.

No.	Price	No.	Price	No.	Price
2	\$0.25	16	\$2.00	28	\$1.25
3	0.25	17	2.00	29	1.25
4	0.25	18	2.00	30	1.25
5	0.25	19	1.25	31	1.25
7	0.25	20	1.25	32	1.25
8	0.25	21	1.25	33	2.50
10	1.00	22	1.25	34	2.50
11	1.00	23	1.25	35	2.50
12	1.00	24	1.25	36	2.50
13	1.00	25	1.25	37	3.00
14	1.00	26	1.25	38	3.00
15	1.00	27	1.25		

Membership

in the

Society of Motion Picture Engineers

is open to all who are engaged in any branch of the motion picture industry or allied work. The society is international in character and its convention papers with complete discussions are furnished free to members.

REASONS WHY

YOU

SHOULD JOIN

The Society of
Motion Picture
Engineers

- 1—The S. M. P. E. is an internationally recognized organization of Motion Picture Engineers.
- 2—The S. M. P. E. is becoming an ever more important factor in developing, stabilizing, and standardizing the motion picture industry.
- 3—At two conventions each year reliable data concerning a wide range of subjects are presented long before they become available elsewhere.
- 4—Papers read at conventions are printed with full discussions in a monthly Journal and distributed free to all members.
- 5—The S. M. P. E. affords unique opportunities for personal contact with leaders in the industry.
- 6—S. M. P. E. publications are recognized standard authority on Motion Picture Engineering.
- 7—The S. M. P. E. will help you in many ways. Join now.

COUPON

HERFORD TYNES COWLING, *Chairman*
Membership Committee, Society of Motion Picture Engineers
343 State Street, Rochester, N. Y.

Dear Sir—

Please mail application blank and requirements for membership in the S. M. P. E. to—

Name.....
(Please print)

Position.....
(Company or other Affiliation)

Street and City Address.....

Name.....

Position.....

Street and City Address.....

JOURNAL OF THE SOCIETY OF MOTION PICTURE ENGINEERS

LOYD A. JONES, EDITOR *pro tem.*

Associate Editors

G. L. CHANIER
O. M. GLUNT
A. C. HARDY

P. MOLE
W. B. RAYTON
P. E. SABINE

S. E. SHEPPARD
J. L. SPENCE
L. T. TROLAND

Publication Office, 20th & Northampton Sts., Easton, Pa.
Editorial Office, 343 State St., Rochester, N. Y.

Published Monthly

Copyrighted, 1930, by the Society of Motion Picture Engineers

Subscription to non-members \$12.00 per year; single copies \$1.50. Order from the Secretary of the Society of Motion Picture Engineers, 20th and Northampton Sts., Easton, Pa., or 2 Clearfield Ave., Bloomfield, N. J.

Papers or abstracts may be reprinted if credit is given to the Journal of the Society of Motion Picture Engineers.

The Society is not responsible for statements made by authors.

Application pending for second-class entry at the Post Office at Easton, Pa.

LOUDSPEAKERS AND THEATER SOUND REPRODUCTION

LOUIS MALTER*

INTRODUCTION

The ultimate goal in theater reproduction of sound motion pictures is the complete simulation in each part of the theater of the sound originally impinging upon the pickup microphone. This goal is at present far from having been achieved, one of the weakest links in the chain between sound striking the microphone and the sound impinging upon the ear of the auditor being the loudspeaker.

At the present time the two chief types of loudspeakers in use in theaters are the cone speaker with directional baffle and the horn type speaker. Diagrams of these two types are shown in Fig. 1.

In the following discussion the elements which measure the satisfactoriness of a loudspeaker, and the influence of these elements on the reproduction obtained from the two types of loudspeakers mentioned above will be considered. The results of certain measurements will be used to explain the quality of reproduction obtained with each type of loudspeaker in theaters.

ELEMENTS DETERMINING LOUDSPEAKER PERFORMANCE

The extent to which a loudspeaker can deliver satisfactory reproduction is measured by five factors, which may be classified in order of importance as follows:

1. Frequency range.
2. Uniformity of response.
3. Radiation distribution characteristics.

If the pressure at a great distance from the speaker is measured at various angles with the normal to the mouth of the speaker a continuous curve is obtained. If the intensity along the normal is set equal to unity the curve obtained is defined as the radiation distribution characteristic for the particular frequency at which the measurement is obtained. The family of curves showing the radiation distribution characteristics throughout the frequency range is a measure

* RCA Photophone, Inc., New York.

of the quality of reproduction at various angles to the normal. The ideal characteristic is that in which the intensity is uniform for all frequencies throughout the angle defined by the entire audience in a theater at the center of the speaker mouth and which then falls off to zero very sharply outside this angle.

4. Efficiency.

The absolute efficiency of a loudspeaker is defined as the ratio of the total acoustic power radiated by the loudspeaker to the total acoustic power radiated by an ideal loudspeaker if fed from the same electrical source.

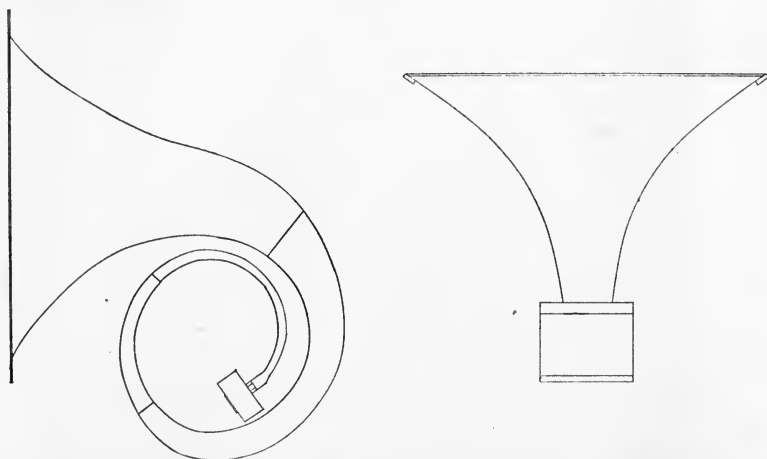

FIG. 1. Horn type loudspeaker (left); directional baffle type loudspeaker (right).

5. Input power capacity.

The input power capacity of a loudspeaker is measured by the value of $\frac{e^2}{4r}$, where e is the maximum open circuit voltage which can be impressed upon the loudspeaker terminals without producing noticeable distortion, and r is a resistance equal in magnitude to the impedance to which the speaker is designed to be connected.

LOUDSPEAKER MEASUREMENTS

In order to obtain an accurate and absolute comparison between the performance of the "directional baffle type" loudspeaker and the horn type loudspeaker, frequency response characteristics of the most widely used type of directional baffle type loudspeaker and of the most widely used type of horn loudspeaker were obtained in the following way.

Each loudspeaker was placed on the ground out of doors pointing directly upward and at a sufficiently great distance from buildings so that reflections from these did not affect the results obtained. A condenser microphone was suspended directly above the center of the loudspeaker mouth at a distance of 20 feet. (See Fig. 2.) The

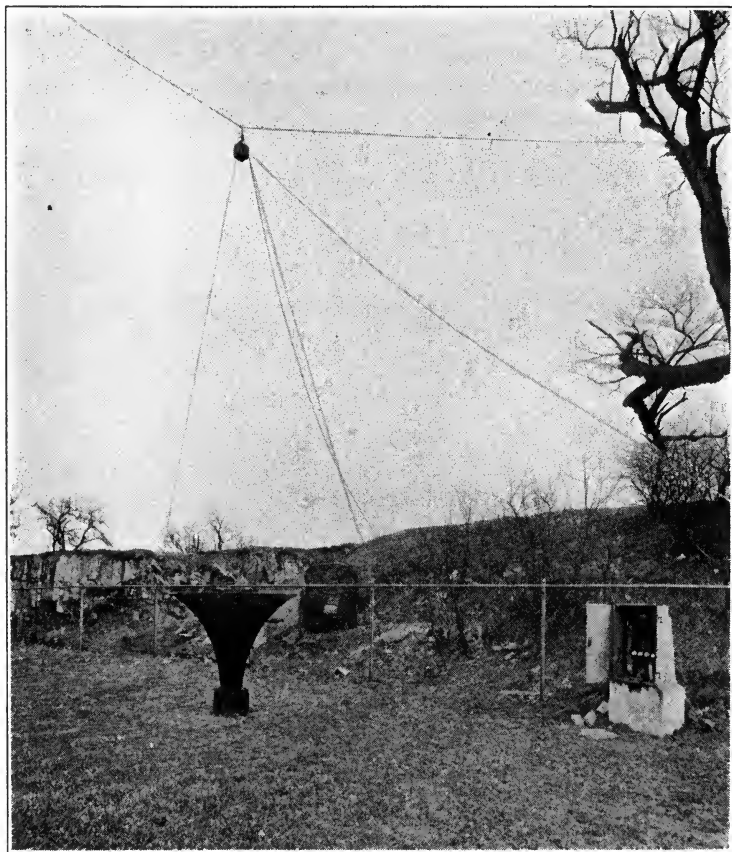

FIG. 2. Setup to determine frequency response characteristics of speaker for higher frequencies.

condenser microphone was connected to a sound amplifier. The entire sound measuring equipment was corrected electrically so as to possess a uniform over-all frequency characteristic.

The frequency-response characteristics obtained in this manner are

correct down to a frequency at which the radiation distribution characteristic of the speaker becomes so broad that sufficient sound is reflected from the ground to interfere with the radiation shooting straight up. In order to obtain the frequency characteristic for the *lower* frequencies, the speaker is placed along the ground with its mouth pointed towards the condenser microphone, which is placed close to the ground and at a distance of 20 feet from the speaker mouth. (See Fig. 3.) In this case the phase difference at the microphone between the direct radiation and that reflected from the ground is negligibly small at low frequencies so that the actual low frequency

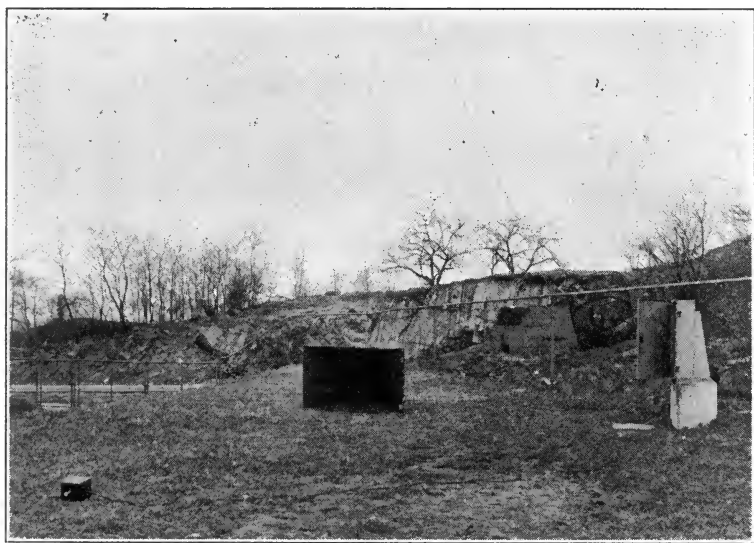

FIG. 3. Setup to determine frequency response characteristics for lower frequencies.

characteristic is obtained. This low frequency characteristic, however, must be divided by two due to reflection from the ground. (The assumption of practically complete reflection from the ground has been checked by experiment.) The fact that over a certain region (300 to 500 cycles) both methods yield the identical result is a further check on the composite method.

Fig. 4 is a photograph of the beat-frequency oscillator and high quality amplifier used in making the measurements. These were set up indoors and leads run out to the speaker and the bullet amplifier

associated with the condenser microphone. The recording mechanism shown permits of a rapid and accurate frequency response characteristic being taken in a few moments. A complete description of a similar sound pressure recording mechanism has been previously published.¹

DISCUSSION OF EXPERIMENTAL RESULTS

The frequency response characteristics obtained are shown in Fig. 5. In order to enable a fair comparison to be made between the frequency characteristics of the two types of speakers the two frequency response curves have been so placed as approximately to overlap in the center of the range, *i. e.*, between 300 and 800 cycles. This has necessitated raising the curve of the directional baffle type loudspeaker. (See later discussion under "Efficiency.") A careful

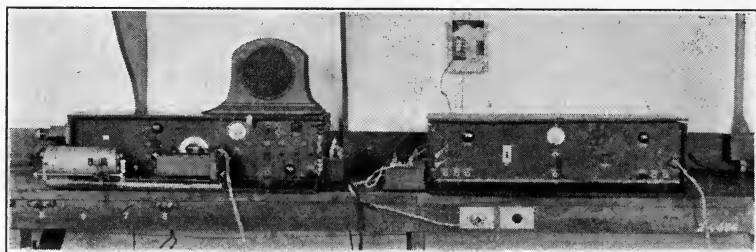

FIG. 4. High quality heat frequency oscillator and amplifier.

study of these curves enables us to make a competent comparison between the two types of speakers as regards frequency range, uniformity of response, and efficiency.

Frequency Range and Uniformity of Response.—It is immediately evident that the frequency range of the directional baffle type speaker is greater at both the low and high ends of the scale. The cut-off frequencies of the directional baffle type speaker are about 85 cycles and 6000 cycles at the low and high ends, respectively, whereas those of the horn type speaker are about 125 cycles and 5000 cycles, respectively. Thus at the lower end of the frequency scale the directional baffle type speaker has a half octave greater frequency range than the horn type and about $\frac{1}{5}$ octave more at the higher end.

¹ WOLFF AND RINGEL: "Loudspeaker Testing Methods," *Proc. Inst. Radio Eng.* (May, 1927).

As regards uniformity of response the directional baffle type of speaker obviously has the advantage. Between 300 and 5000 cycles the response of the directional baffle type is slightly more irregular, but between these limits the variations in the response of the horn type are greater. Below 300 cycles, however, the horn type speaker is appreciably less responsive than the directional baffle type. As will be seen below, this deficiency in low frequency response in the horn type speaker is a serious defect.

Efficiency.—In order to enable a fair comparison to be made between the frequency response characteristics of the two types of speakers, the response curve of the directional baffle type speaker was

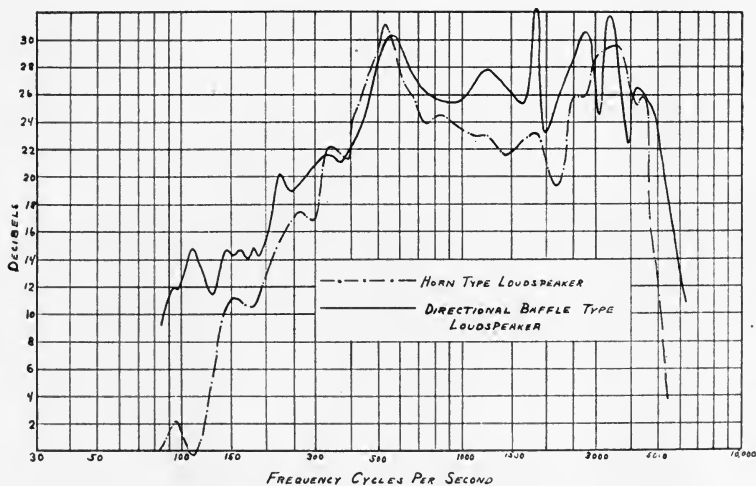

FIG. 5. Relative frequency response characteristics of two speakers.

raised 7 decibels. In order to determine the relative average efficiencies of the two types of speakers the curve for the directional baffle type speaker was placed at its proper level, and the average response between its cut-off limits (90 and 6000 cycles) determined by means of a planimeter. The result obtained is 15.6 decibels. The average response of the horn type loudspeaker for the same input power and between the same limits is 18.3 decibels. The average straight-ahead response of the horn type loudspeaker is thus 2.7 decibels greater than that of the directional baffle type loudspeaker, for the same power input. This corresponds to a power efficiency ratio of 1.9 to 1.0. This difference corresponds to between 1 and 2

steps on the average gain control and is consequently of minor importance.

Radiation Distribution Characteristics.—The radiation distribution characteristics of both types of speakers as now used are sufficiently good to yield satisfactory results. These distribution characteristics are fairly uniform through angles of about 20 degrees to each side of the normal to the mouth opening. In the average size of theater this is sufficient. In wider and larger houses, two or more speakers may be used, thus securing good directional characteristics as well as permitting an increase in the total amount of radiation as required by the larger size of the house.

Input Power Capacity.—No accurate measurements were made with respect to this quantity. However, it has been our observation that similar houses require the same number of speakers of either type for satisfactory sound reproduction. This indicates that, in view of the somewhat greater efficiency of the horn type speaker, the directional baffle type speaker has the edge in respect to input power capacity. This is what might be expected from the fact that the radiating surface of the directional baffle type speaker, *i. e.*, a cone, is much sturdier than the fragile metal diaphragm of the horn type speaker.

RESULTS IN THEATERS

It is exceedingly interesting to compare the results obtained with both types of speakers on listening tests in theaters and see to what extent these results are explainable on the basis of the measurements described above.

Comparisons of this sort must be made separately for both speech and music.

If, in the reproduction of speech, we fix our attention upon the *understandability* only, we find that each of the loudspeakers is equally good. However, although speech on each of these speakers is equally understandable, the reproduction on the directional baffle type speaker is far more *natural* than on the horn type speaker. Reproduction on the horn type speaker has an unnatural quality. All voices sound very much alike whether of the same or opposite sex. Looking away from the screen makes it sometimes difficult to distinguish the sex, except from the context. Male voices, particularly, sound too high pitched and unnatural.

These results are easily explainable on the basis of the obtained frequency characteristics. It is well known that the elimination of

all frequencies below 300 cycles and above 4000 cycles exerts a negligible effect upon the understandability of speech. Since, on the whole, the response of the two speakers between these limits is the same, we would expect the understandability to be the same. This is what is actually observed.

However, the characteristic frequencies of the speaking voice lie below 300 cycles. They center around 125 cycles for the male voice and around 250 cycles for the female voice. It is these "fundamental" frequencies which give to each speaking voice its individuality and distinctiveness. A lack or deficiency of the frequencies below 300 cycles will rob the voice of these characteristics. This accounts for the superiority in naturalness of speech reproduction on the directional baffle type loudspeaker. The response of the directional baffle type speaker, between 100 and 300 cycles, is considerably greater than that of the horn type speaker between the same limits. This is particularly true below 140 cycles. Around 100 cycles the difference in response is around 12 decibels.

The reproduction of music is also adversely affected by the deficiency in the response below 300 cycles. Music reproduced on a horn type speaker lacks the fullness and depth apparent in the reproduction by the directional baffle type speaker. The complete reproduction of the lower register instruments is impossible on the horn type speaker. The result is that music loses its real quality and retains merely its melody. This is particularly true for music of a symphonic nature.

In a recent paper² certain statements are made in a discussion of horn and cone (or baffle) type speakers. The cone (on baffle) type speakers referred to in that paper are of a type wherein cones are set in a flat baffle, a type which is much less widely used than the directional baffle type speakers. Some of the claims made for the horn type loudspeaker are not borne out by our experiments. Thus it is claimed that the horn type loudspeaker and flat baffle type of loudspeaker are equally satisfactory as regards frequency characteristics. This may be true in theory but tests of actual devices as used in commercial practice show that the upper and lower cut-off frequencies of the flat baffle type of loudspeaker, which coincide approximately with those of the directional baffle type using the same cone, are much more widely separated than those of the horn type loudspeakers.

² BLATTNER AND BOSTWICK: "Loudspeakers for Use in Theaters," *J. Soc. Mot. Pict. Eng.*, XIV (Feb., 1930), No. 2, p. 151.

In addition the claim for power efficiency ratio of the horn type speaker to flat baffle type of 10 to 1 refers to a single cone in a flat baffle. In practice cones are never used this way in theaters, being either used in multiple on a flat baffle or, as is commonly the case, being set in a directional baffle. Either of these setups results in a marked increase of efficiency. A comparison of a horn type speaker with a single cone is thus not representative of the relative characteristics of standard apparatus.

The radiation resistance characteristic shown for a horn type loudspeaker with a 50 cycle cut-off is not typical of the horns employed in practice. The construction of a horn with so low a cut-off is very expensive and the size of the horn would probably be such as to make it too large for the average theater. Aside from these considerations, the smooth cut-off shown is attainable only with an infinitely long horn, that is, attainable only with the unattainable. The frequency characteristic of a finite horn always exhibits horn resonances such as those which appear on the actual horn characteristic given in Fig. 4. In addition, as has been shown above, considerations of efficiency favor the horn type of loudspeaker only to a slight extent.

CONCLUSIONS

The above results can now be summarized as follows. In power handling capacity the two speakers are about the same. In efficiency the horn type speaker is somewhat superior. The directional characteristics of both types are satisfactory. As regards frequency response characteristics, the directional baffle type speaker is markedly superior to the horn type in the reproduction of both speech and music. On the basis of these factors it appears quite conclusively that for theater reproduction, of the commercial devices in use at the present time, the directional baffle type loudspeaker yields more satisfactory results.

DISCUSSION

MR. RYDER: Does this paper deal with two types of speakers driven by the same motor or with each of the speakers as a complete unit?

MR. MALTER: In considering the reproduction of speakers one cannot consider merely the characteristics of the component parts but must consider the characteristics of the reproducing system as a whole, since the various units exercise an influence on each other. The purpose of this paper has been to compare the characteristics of the two most widely used types of complete units. As I pointed out, on the basis of the measurements the directional baffle type speaker is the louder. The directional baffle and the horn type do not allow the same driving unit to be used owing to differences in construction.

MR. RYDER: The tests Mr. Malter mentioned were based on the placing of the microphone on the earth, which may be more suitable for one speaker than for another because of the type of the horn. Was the method of test partial to one or other of the types?

MR. MALTER: The type of measurements has nothing to do with the horns. The method was the best way of obtaining the characteristics of any loud speaker of that size.

MR. FLETCHER: The first question I want to ask is whether these measurements were made on just one horn type and one baffle type, or were ten or twenty used? I know that we have found the variation from one type to another is almost as much as was shown. Why did you pick the particular ones you did? The second question is, on what was your statement based that one had better naturalness? Was it a matter of opinion or were measurements made? The third question concerns the statement that you get the same understandability of speech because the frequency response between 300 and 4000 is the same. We have made measurements on this which show there is a difference in the understandability of speech, so that if the tests were made carefully that would have been shown by articulation tests.

MR. MALTER: To answer the first question as regards the number of speakers, employed in the tests: these chosen were chosen by listening tests of these types all of which gave practically the same quality of reproduction. As regards the point as to which types were chosen, we chose the speakers of each type most widely used in the theaters and not those having a relatively small distribution. As regards the question on the subject of naturalness, this is a factor which is to a large extent subjective. Measurements of this factor cannot be made very accurately in an objective fashion, and the conclusion as to naturalness is the result of the impartial observations of a large number of observers. With regard to articulation, the measurements do indicate practically identical articulation. The effect of frequencies of 4000 cycles is not in agreement with the results published by Mr. Fletcher in his book on "Speech and Hearing."

MR. BLATTNER: May I ask if the frequency characteristic curves have been corrected for the open air transmission characteristic of the microphone used in making the measurements? Another point with regard to efficiency: at a frequency of about 2000 cycles a difference between the two curves was shown of something greater than 2 decibels, and if I understood the author correctly, the baffle speaker would be louder than the horn at that range. This difference in efficiency is somewhat different from the impression we have had from different types and numbers of speakers of both kinds, and we should like further information. The horn speaker is a little more efficient than was indicated. I believe that with the metal diaphragm in the horn type, the power capacity is not a problem although there are few data available with regard to this point. We know there is little difference. With regard to Mr. Malter's reference to our paper of last fall, most of the questions brought out by Mr. Malter were discussed in the paper. The question of response in using two or more baffle speakers was explained. The effect is limited to the lower frequencies, and this can be improved in the horn type by designing two separate horns to be combined. With regard to the practicability of using the horns at lower frequency, as described in our paper, this is quite practicable because we have been using

horns with a 57 cycle cut-off for three or four years. The fact that Mr. Malter's horn type cuts off at higher frequency than described in our paper leaves a question of whether he was considering a horn of the type which we discussed in our paper.

MR. MALTER: With regard to the open air characteristics of the microphone, I assume that Mr. Blattner refers to higher audible frequencies. Corrections were made on these characteristics. With regard to the second point on efficiency, the relative efficiencies as determined were in regard to frequency response, and the characteristics shown in the figure were obtained under conditions such as to enable an accurate frequency response comparison to be made. That was mentioned in the paper. With regard to the third point on input power capacity. I agree with Mr. Blattner that few measurements have been made by anyone in this respect, and in the conclusion we rate both on the same level with regard to input power capacity. Mr. Blattner states that the questions of the increase of efficiency due to combinations were brought out in the paper delivered in Toronto. I wasn't there, but I read and studied the paper carefully and don't recall any references to it in the paper. I should like to ask Mr. Blattner a question: He states that he has had a horn in his laboratory cutting off theoretically at 57 cycles; I should like to know where it actually cuts.

MR. BLATTNER: You get loading of the diaphragm at about 50 per cent above the theoretical.

MR. FLETCHER: With regard to the lowering of articulation which we were discussing, it is not very much, of course, if you take all speech sounds together, but there is an observable difference which is recorded in the book Mr. Malter mentions.

MR. MALTER: I agree with Mr. Fletcher, but the discussion was limited to the understandability of speech and the elimination of frequencies above 4000; although this may reduce the intelligibility of certain sounds, it doesn't in any particular manner lower the understandability of speech as a whole.

MR. BLATTNER: May I refer Mr. Malter to the last paragraph of our paper with regard to the multiplicity of units on the horn type of speaker?

MR. ROSS: Mr. Malter stated that male voices have an average frequency of 128 and female voices 256, and that therefore a cut-off at 4000 cycles is immaterial. Male voices in song most nearly average 256 cycles and female voices 512 cycles. The harmonics consisting of the partials and their octave harmonics and the octave harmonics of the fundamental determine the beauty of the singing voice. Many of these harmonics lie above 4000 cycles. The horn type speaker producing an additional 1000 cycles is believed therefore to produce more faithful reproduction of voice in song if not in speech also.

MR. MALTER: For correct reproduction we should reproduce all frequencies, and the greater the frequency range, the greater the naturalness. In that respect, as I pointed out, the directional type of speaker has the edge.

MR. BRAUN: Were any tests made showing at what point either of the two types of speakers introduces distortion?

MR. MALTER: No careful tests were made on that point.

MR. LAWLEY: May I ask what the size of the final opening of this directional baffle was?

MR. MALTER: Five feet by three feet.

MR. LAWLEY: Was the horn the same size?

MR. MALTER: Approximately. I have the figures with me and can let you have them.

MR. MAXFIELD: In regard to the matter of the speech of men and women sounding alike, I have heard a lot of recording reproduced on both speakers, but I have never heard a good record which resulted in such uncertainty on any speaker. In the early days, bad acoustics on the set flooded the market with records in which it is difficult to differentiate between men's and women's voices, but that is dying out. As regards the practical cut-off of the horn type speakers, those with which I have come in contact give trouble at times with the 60 cycle hum. The horn type of speakers at least produced audibility down to 60 cycles.

MR. MALTER: I agree with Mr. Maxfield that poor recording sounds bad on any type of speaker and good recording will improve the response from any speaker. Our results are not only on reproduction in theaters but on listening tests with a high quality amplifier and condenser microphone, and it is on the results obtained in theaters and from the listening tests that the conclusions were drawn.

MR. TUTTLE: Mr. Malter's paper is now being printed and will be published in the June issue of the JOURNAL. It is important, therefore, that all those who have contributed to this discussion assure themselves of the accuracy of the stenographic report before leaving Washington. There will not be, in the case of this paper, opportunity for the usual distribution of discussion for corrections as the copy must be sent to the printer at once.

APPARATUS DEVELOPED TO SIMPLIFY MANUFACTURE OF LENS WHEELS FOR CONTINUOUS PROJECTORS

ARTHUR J. HOLMAN*

The continuous projector described briefly in Volume XII, Number 36, of the *Transactions* under the classification, "Symposium on New Motion Picture Apparatus," is essentially a precise optical instrument requiring a higher degree of accuracy in manufacture than is customary in optical work. The lens wheels, shown in position in the mechanism (Fig. 1), are the essential and characteristic elements of this projector. In order that the screen image may possess the critical definition and the steadiness essential to good projection and may also have, to the fullest extent, the peculiarly pleasing qualities this system of projection is capable of producing, it is essential that the lens wheels be accurate.

The optical accuracy of the lens wheels depends principally on three factors: first, the accuracy of curvature of surfaces of each lens sector; second, the exactness of matching of all lens sectors on the lens wheel; and third, the exactness of positioning of optical centers of lens sectors in the final lens wheel assembly. The first requirement calls for the best product of a first class optical shop. The second requirement presents to such a first class shop a restriction never before imposed in quantity production, for these lens sectors must be "matched" in the highest sense of the word. The third requirement is entirely new to the optical industry and involves a new and precise method of centering and indexing.

With these problems standing in the way of commercial manufacture, it is not at all surprising that those skilled in the arts of projection and lens making have hitherto considered this projector impossible from a practical standpoint although they are willing to admit that exceptionally pleasing screen results are obtained with a perfected machine. The inventions described herein have entirely solved these difficulties of manufacture and will, I trust, be of interest to the members of our Society, especially in view of the fact that we are about to

* 59 Auburn St., Brookline, Mass.

present to the motion picture industry a new system of projection having many possibilities in the presentation of sound, action, and natural color.

IMPROVED LENS GRINDING AND POLISHING MACHINE

The optical industry has never been called on for large quantities of matched lenses of relatively large diameter which must be exactly alike as to focal length, thickness, resolving power, and other optical characteristics, and, as the commercial production of such lenses is

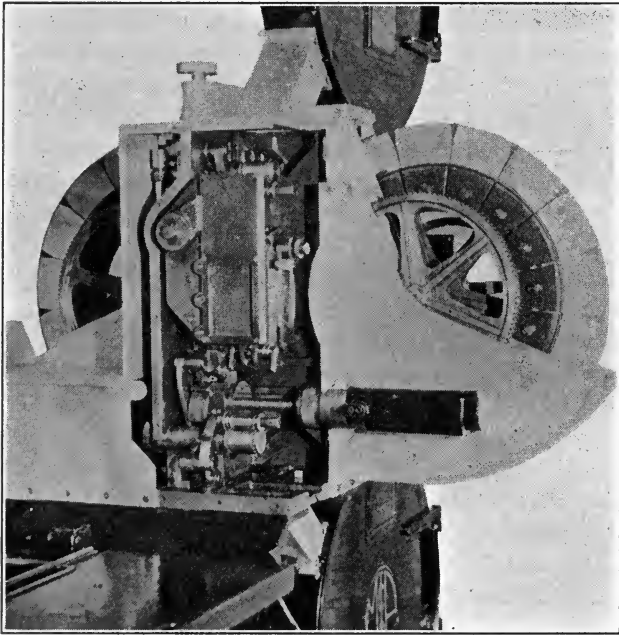

FIG. 1. Continuous projector mechanism showing lens wheels in position.

out of the question with present methods of manufacture, it became necessary to develop an improved grinding and polishing machine. This machine, illustrated in Fig. 2, operates on entirely new principles and is covered by basic patents.

Lenses are ground today on laps which have been surfaced to the exact curvature desired on the lens, and an expert lens maker can produce a fine ground surface on glass very closely approaching the ac-

curacy of curvature of the lap surface. But if this expert lens maker continues to grind surface after surface on successive lens blanks with the same lap, it will wear irregularly, lose its original contour and soon become incapable of grinding to the exact curvature of the first lens surfaced. The more skilled the lens maker, the more nearly the

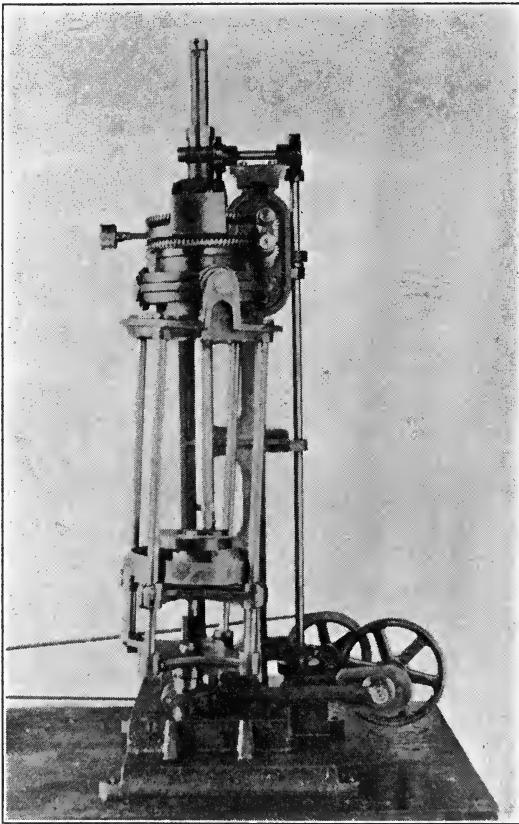

FIG. 2. Improved lens grinding and polishing machine.

lap will conform to its original shape as the grinding progresses but even the expert cannot prevent a gradual changing in curvature, which means a changed focal length or a departure from the true sphere or both, in the finished lens. To restore the lap to its original curvature requires special grinding with a matched lap of opposite

curvature and exact gauging to a master curve. Then the fine ground glass surface requires polishing and, since this operation is carried out on a pitch polisher which is more or less plastic, and therefore subject to continual change in shape, considerable skill is required on the part of the operator to produce a uniform highly polished surface without departing from the curvature to which the surface was ground.

The most accurate curved optical surfaces are at present produced by expert lens makers with hand controlled movements of the lens blank in conjunction with a power operated spindle on which the lap of the polisher rotates. Surfaces of lesser accuracy are produced in quantities on machines requiring no manual operation but the inherent characteristics of the hand and machine methods are essentially the same. The expert lens maker can "feel" the effects of grinding or polishing and control the hand movements accordingly, whereas the machine goes through the same cycle regardless of the progress of the grinding or polishing. The lens maker's skill resides in his ability to "feel" the effects of the grinding and to modify his hand stroke in such a manner as to correct uneven surfacing.

The cause of uneven wearing of the lap in grinding and uneven polishing of the fine ground glass surface is discovered when the relative movements of lens blank and lap or polisher are analyzed. When it is remembered that the lap or polisher usually spins on the axis normal to the curved surface at its center and the lens blank tends to spin on an axis passing through its center, it is not difficult to see that relative movements of lens blank and tool are largely the resultant of each spinning about its own center, and therefore the rate of relative movement of elements on the surface of the lens blank across elements on the tool is dependent largely on the distance of these elements from the axis of rotation of the lens blank and the tool, respectively. As the local abrading action is dependent on the speed of relative movement, it is easily seen that it is most difficult to prevent uneven grinding or polishing in zones about the centers of rotation. This is the inherent and unavoidable cause of error in all present systems of lens manufacture.

The one way to avoid this error is to produce relative movements of lens blank and tool which are not primarily the resultant of rotation of these parts on their respective axes and my improved grinder and polisher accomplishes this desired result in the following manner. All movements of the lens blank and lap are constrained to take place about the center of curvature of the lap surface; a condition

which merely requires that the lap and lens chuck be pivoted at the center of curvature of the lap. Fig. 3, reproduced from an assembly drawing, shows a plan, front and side views, and a horizontal and vertical cross-section through the pivot center.

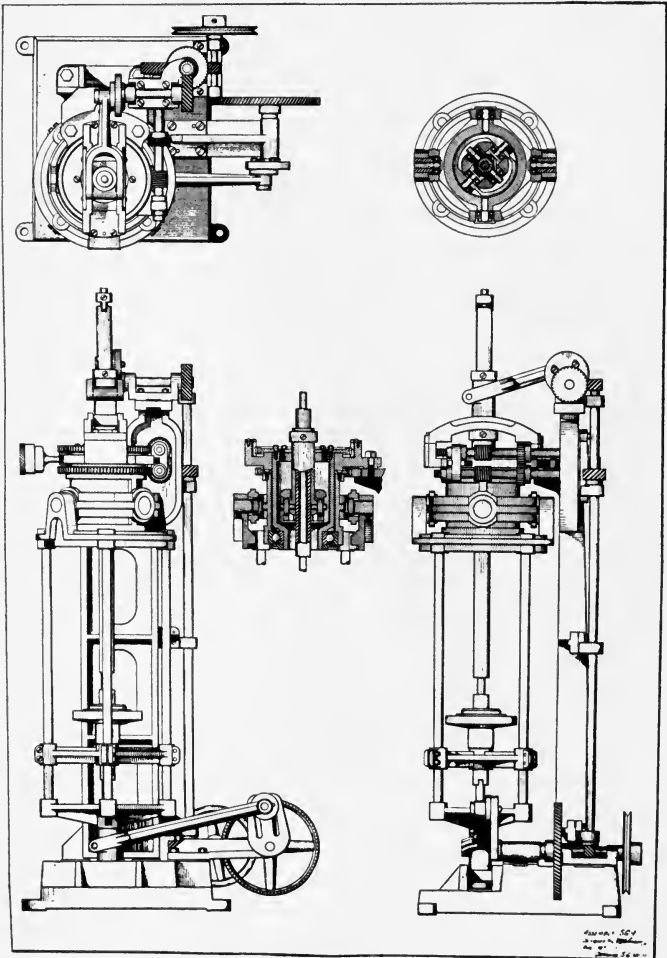

FIG. 3. Assembly and cross-section views of improved lens grinding and polishing machine.

The machine consists essentially of a pair of rotatably supported concentric sleeves, each of which carries a universal joint; the outer

universal joint supporting a cage on which is mounted the concave member, and the inner universal joint supporting a central shaft on which is mounted the convex member. The machine includes mechanism for oscillating the cage about the center of the outer universal joint and oscillating the central shaft about the center of the inner universal joint in a plane at right angles to that in which the cage oscillates. The operating gear train is arranged to provide a slight difference in the frequency of oscillation of the cage as compared with the oscillation of the central shaft. The concentric sleeves are arranged to rotate either in opposite directions or at slightly different rates in the same direction, but the drive for these sleeves operates very slowly in order that the resultant relative rotation of lens blank and lap about their respective axes may be a minimum. The foregoing is sufficient to illustrate that the relative movements of lens blank and lap are produced primarily by each member oscillating in a plane at right angles to the other and at slightly different frequencies, the pattern of the path of any element on the surface of the lens blank over the surface of the lap being further modified by the slow relative rotation of lens blank and lap.

The slight difference in frequencies of the oscillating members causes a constantly changing phase angle which is most effective in varying the relative movements of lens blank and lap. Assuming that the adjustable cranks have been set to give equal amplitudes of oscillation to the lens blank and the lap, and the machine has been operated till both reach a maximum at the same instant, then the path of the center of the lens blank across the lap will lie in one plane (neglecting for the moment the relatively slow rotation of lens blank and lap) and this plane will make an angle of 45 degrees with the planes of oscillation. As the device continues to operate, the oscillating members become more and more out of phase and, when the phase angle becomes 90 degrees, the path of the center of the lens blank across the lap is a circle. When the phase angle is 180 degrees the path lies in a plane again but this plane makes an angle of 90 degrees with the "in phase" plane mentioned above. When the phase angle becomes 270 degrees the path is again a circle but this circle is generated in the reverse direction. At 360 degrees the path returns to the initial "in phase" plane.

The impression created by observing the device in operation is about as follows. At the "in phase" period there is a relatively long resultant stroke along a straight line at 45 degrees to the planes of

oscillation; the stroke gradually shortens as the relative motion becomes elliptical, the minor axis increasing and the major axis, which lies along the 45 degree line, gradually decreasing till the relative motion becomes circular; the circle elongates into an ellipse and the ellipse flattens into a straight line at right angles to the "in phase" line; the motion again becomes elliptical (this time, however, the center of the lens blank travels in the reverse direction around the ellipse) and passes, in the reverse order, through the above mentioned forms back to the original "in phase" straight line.

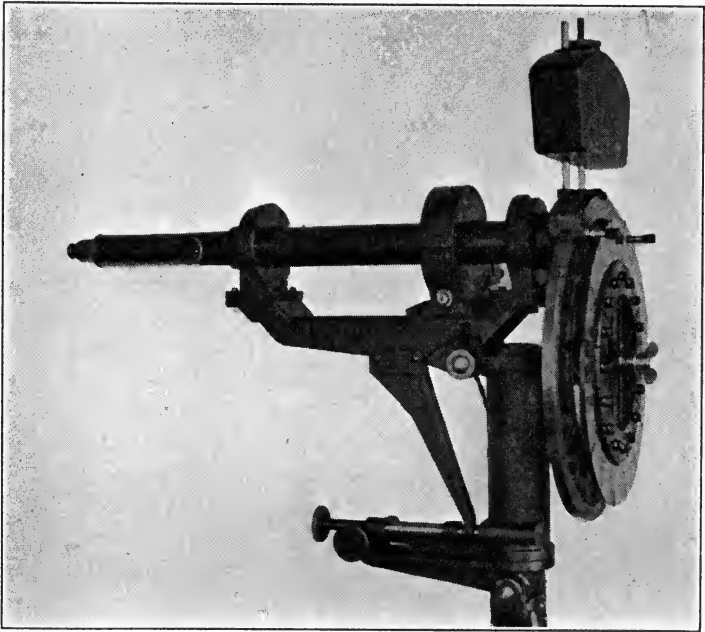

FIG. 4. Lens setter, right side view.

It will be evident from the foregoing that the tendency toward uneven grinding and polishing is entirely eliminated in this machine and therefore the lap and lens surface will remain true to curve during the grinding and polishing operations. As a matter of fact the lens surface is actually generated about the center of curvature of the lap and therefore the only possible change in curvature that can occur is the very slight change caused by the even wearing away of the lap

in grinding, but this is so very slight that the same lap may be used for grinding many lens surfaces without any appreciable variation, and the lap surface will never depart from the true spherical form. A micrometer adjustment of the radius of oscillation of the lap may be easily provided which will assure a constant curvature for any number of lenses. Moreover the relative movements of lens blank and lap are such that the very finest grinding can be done quickly, and polishing is accomplished in a surprisingly short time. Since the variable speed zones of the ordinary methods of grinding and polish-

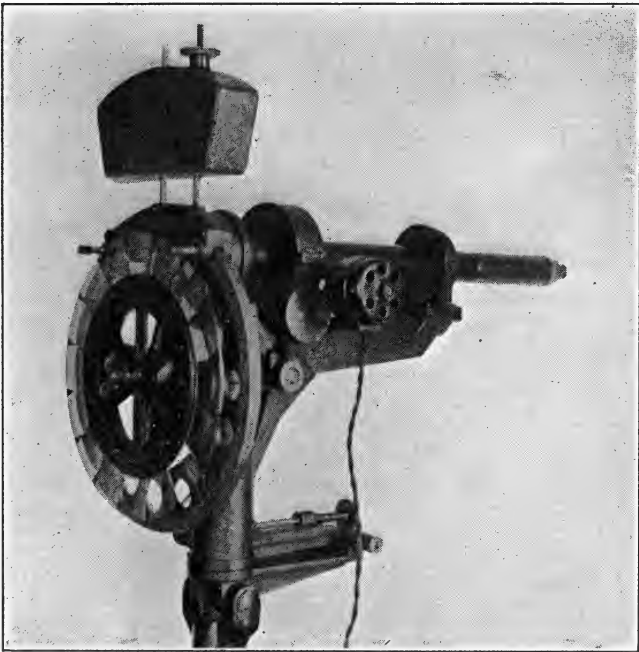

FIG. 5. Lens setter, left-front view.

ing have been eliminated, the abrading action is uniform over the entire glass surface. This is the ideal condition, permitting not only rapid grinding but also exceptionally fine grinding without danger of scratching because the abrading material works down uniformly over the entire surface of the tool.

The machine is simple to operate as a grinder, requiring only occasional attention to feed the abrading material and to examine the

condition of the surface being produced. When polishing very little attention is required. No particular skill is necessary for either grinding or polishing as the accuracy of the work is automatically controlled by the machine, and one attendant can look after several grinding machines or many polishers.

The device is suitable for grinding and polishing concave and convex surfaces and the radius of curvature, which is determined by the radius of oscillation, is easily adjustable over a wide range to any required exact value. When the machine is changed over to grind to a new radius of curvature a lap of corresponding curvature must be substituted for the former one. The machine is provided with stops which may be set to limit the extent of grinding, thus making it possible to accurately control the thickness of the lenses produced. For grinding spherical surfaces the centers of the universal joints must coincide. Aspherical surfaces may also be produced by making one universal joint eccentrically adjustable or by displacing one center of oscillation along the vertical axis.

This machine is simple, compact, self-contained and of rugged mechanical construction; is capable of producing the most accurate surfaces, and is quickly adjustable to a wide range of work. It is to be noted that the accuracy of the lenses is determined entirely by the accuracy with which the centers of oscillation are maintained. The universal joints are provided with ball bearings throughout. The inner and outer sleeves rotate, the one upon the other, on ball bearings, and the construction of these parts is such that they are effectively sealed to prevent entrance of abrasives, hence the device will operate with little attention over long periods with extreme accuracy. It is evident, therefore, that this invention makes entirely practical the production of large quantities of optically accurate and truly matched lenses at a low cost.

LENS SETTER FOR POSITIONING LENS SECTORS ON LENS WHEEL

Having secured exactly matched lenses properly contoured to form sectors of the lens wheel, we now face the third and last problem in lens wheel construction, namely, that of exactly positioning the optical centers of these lens sectors in the final lens wheel assembly. It will be obvious that the correct arrangement of these optical centers will represent a symmetrical pattern about the axis of the lens wheel shaft. That is, all the optical centers should lie on a common circle and the angular spacing between them should be equal. The nearer

our final lens wheel assembly approaches to this ideal condition, the steadier will be our projected picture, the better will be the definition, and the more apparent will be the peculiarly pleasing screen qualities produced by this system of projection.

The instrument for accomplishing the exact positioning of the optical centers of lens sectors operates on the double error principle.

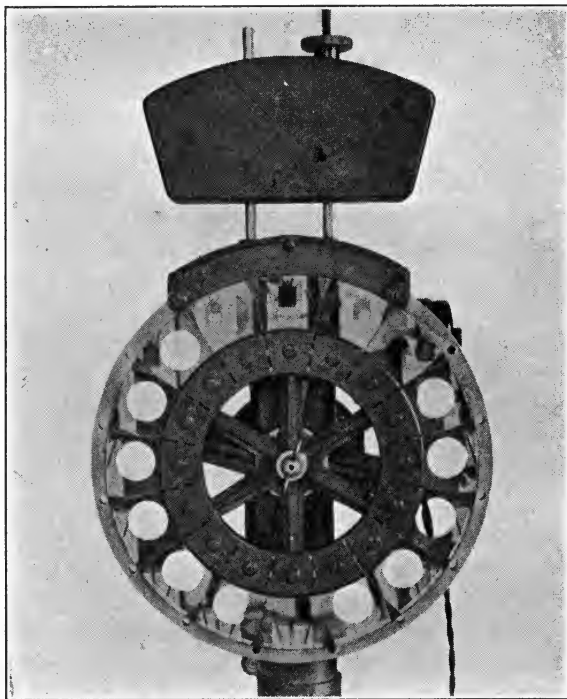

FIG. 6. Lens setter, front view showing lens wheel below axis of telescope tube.

In Fig. 4 is shown a right side view, in Fig. 5 a left front view of this instrument. Fig. 6 and Fig. 7 are head-on views showing the lens wheel in different positions, the displacement being due to rotation of the telescope tube. The lens setter consists essentially of a rotatable telescope tube having an offset bracket whereon the lens wheel is mounted in a manner whereby a lens sector may be rotated about the axis of the telescope tube, a pair of cross hairs intersecting on the axis of the telescope tube, an eye piece adjusted to permit observation

of the image of a target formed in the plane of the cross hairs by the lens sector, and an index ring concentric with the lens wheel and arranged to advance the lens wheel by equal increments to produce exact angular displacement of successive lens sector centers. The offset distance from the axis of the telescope tube to the axis of the lens wheel is equal to the radius of the circle on which the optical centers of the lens sectors are to be located. The index ring is of large diameter and must be accurately made. The variation in chords be-

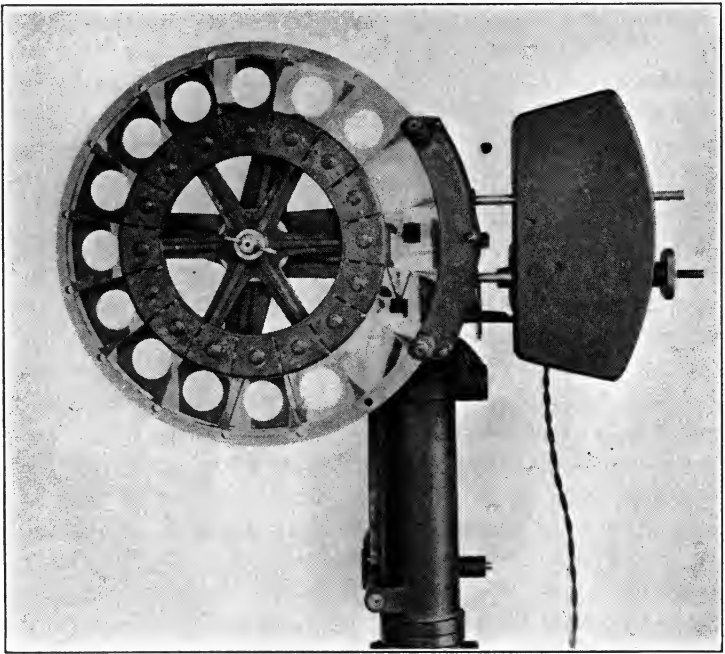

FIG. 7. Lens setter, front view showing telescope tube rotated 90 degrees from position shown in Fig. 6.

tween centers of index holes should not exceed 0.0001 in. The rotating telescope tube carrying the offset bracket on which the lens wheel is mounted, is provided with ball bearings and is driven, through a reduction gear, by a small motor. An adjustable counter weight is provided opposite the offset bracket to balance the weight of the lens wheel and index ring, thus permitting uniform rotation of the telescope tube while the motor is operating. The eye piece is mounted

on an annular boss projecting from the rear telescope tube bearing housing and does not rotate with the telescope tube. The whole device is mounted in a manner whereby the axis of the telescope tube may be oriented in both the horizontal and vertical planes by means of tangent screws for sighting on a target.

The lens sectors, which are plano-convex, have a flat surface ground on the spherical side parallel to the plano side where they are to be clamped in the lens wheel and paper washers are inserted between the glass and the metallic lens wheel flanges.

The method of assembling the lens sectors on the lens wheel is as follows. The lens wheel hub complete with flange plates is mounted on the index ring shaft, turned to the position where the line joining the axis of the telescope tube and the axis of the index wheel bisects a flange sector, and locked in position by the wing nut on the index ring shaft. A lens sector with paper washers attached is placed against the solid flange of the lens wheel and the flange sector bolt is tightened sufficiently to hold the lens sector in position. The lens sector is adjusted till its straight edges are radial and its optical center is positioned approximately on the axis of the telescope tube. This approximate positioning is made merely by eye. The lens setter is then sighted at a distant target and adjusted by means of the tangent screws till the image of the center of the target appears at the intersection of the cross hairs. The motor is then started and as the telescope tube slowly rotates, the movement of the image of the target with respect to the cross hairs is noted. The motor is stopped when the lens wheel is 180 degrees from the position it occupied when the device was originally sighted at the target. The displacement of the image of the center of the target from the intersection of the cross hairs represents double the actual displacement of the optical center of the lens sector from the axis of the telescope tube and the device is realigned by means of the tangent screws, till the image of the center of the target moves exactly half way back to the intersection of the cross hairs. The axis of the telescope tube is then correctly aligned with respect to the center of the target and the lens sector is shifted in its clamp till the image of the center of the target falls at the intersection of the cross hairs. The flange sector bolt is then set up and the motor is again operated to check the accuracy of the setting. If the image of the target does not move with respect to the cross hairs as the telescope tube rotates, the lens sector is correctly positioned. The lens wheel is then moved to No. 2 lens sector position by

means of the index ring, the index stop pins are inserted and No. 2 lens sector is loosely clamped in position by eye. Since the telescope tube is correctly aligned it is only necessary to shift the lens sector in the clamp till the image of the target is centered on the cross hairs and set up the flange sector bolt. The motor is operated again to check the setting and if no movement of the image of the target with respect to the cross hairs is visible this sector is correctly positioned. In like manner the remaining sectors are positioned, and, as a final check, No. 1 lens sector is indexed into position on the telescope tube again and checked to see that there has been no shifting of the lens wheel hub with respect to the index ring during the above operations. If No. 1 sector, on being rotated, shows no movement of the image at the cross hairs, the lens sectors are all correctly positioned and the lens wheel is removed from the lens setter.

With a little practice in using the instrument illustrated, a 16 sector lens wheel can be accurately assembled and checked in a couple of hours, and, when the operation is completed, the optical center of each lens sector will be less than 0.001 in. from its theoretically correct position. This accuracy is easily secured because the apparent movement is proportional to twice the actual displacement. In ten years' experience with lens wheels thus constructed I have never found it necessary to reposition a lens sector and therefore it is not extravagant to state that once a lens wheel is assembled its accuracy is established and it will not change while in service. Barring accidental breakage, a lens wheel is good indefinitely.

Although much time, money, and thought have been required for the development of the apparatus described, the solution of the three critical problems in lens wheel manufacture has worked out very simply and the desired accuracy can be built into these essential parts of this type projector at a very moderate cost. Hence the greatest barrier to the introduction and commercial manufacture of this projector has been successfully removed.

THE PHOTOGRAPHIC TREATMENT OF VARIABLE AREA SOUND FILMS

J. A. MAURER*

One of the most important of the problems which arise in the photographic recording of sound is that of defining for the film laboratory workman the procedure by which he will obtain the most satisfactory results. This problem as it presents itself in the case of the variable density record has been the subject of several papers which have been read before this Society. The purpose of the present paper is to present an analysis for the case of the variable area record.

This type of record is much less critical in its requirements than the variable density type because there is no need to consider linearity in the photographic tone scale. Since the purpose of the film is merely to reproduce the profile, or outline, of the sound waves, the record is inherently free from non-linear distortion, regardless of what contrast is reached in the development of negative and positive or of what their transmissions may turn out to be.

But this does not mean that the variable area record has no photographic problems worth studying, for there are two other important properties of the record which may be affected by improper photographic procedure. These are the response at high frequencies and the range of volume which can be reproduced.

Fortunately the requirements of the two turn out to be not very different, though they have to do with entirely different properties of the photographic materials.

PHOTOGRAPHIC CONSIDERATIONS AND VOLUME RANGE

When one first looks at a number of variable area sound tracks it is difficult to resist the impression that the best record is the one that looks like *A* in Fig. 1, that is, a track the exposed half of which is jet black. But, as will soon appear, the sort of track shown at *B* will give practically as high a level in reproduction as the one at *A*, while even as weak-appearing a one as *C* may be acceptable if handled

* RCA Photophone, Inc., New York.

properly. The reason for this is the difference between the response of the eye to differences in intensity of light and the response of the photo-electric cell to similar differences.

The current passed by the photo-cell is a linear function of the amount of light which falls on it. Obviously, then, the greatest response that can be obtained from any film is that corresponding to complete extinction of the light when the dark part of the wave is over the slit and 100 per cent transmission over the light half of the cycle. This output can be cut down in two ways: by the transmission of some light through the dark half of the track, and by the

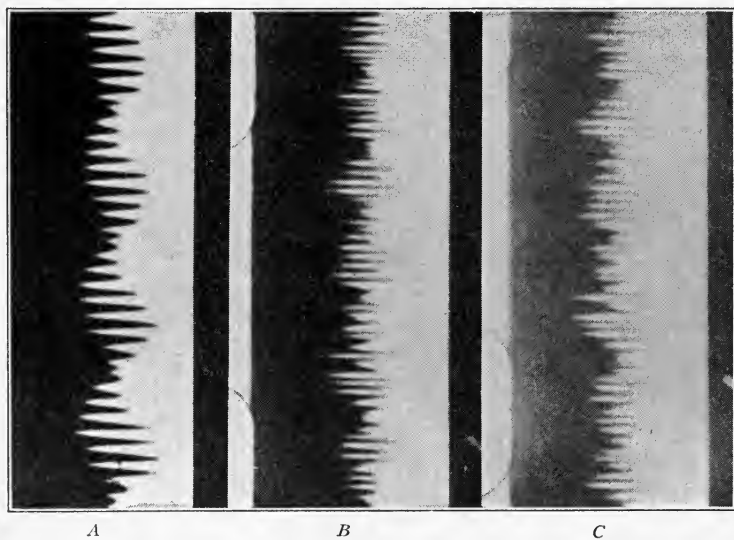

FIG. 1. Three variable area records.

absorption of some light by the half which should be transparent. If we call the maximum possible output 100 per cent and subtract from this first the per cent of light actually transmitted by the dark half and then the per cent absorbed by the light half of the track we will have left the per cent output, in terms of photo-cell current, that will be obtained from the film.

These relations are shown in the curves of Fig. 2. The upper curve shows the outputs which would be obtained from the indicated densities on the dark side of the track if there were no absorption on the clear side. The lower curve shows the amounts by which these values

must be cut down if the clear side has a deposit of the density shown in the lower row of figures.

The most interesting point which is brought out by these curves is the large reduction in output which is caused by what, to the eye, is a very slight fogging of the clear side of the sound track. All the values plotted in the lower curve are very low in the scale. A density of 0.2 appears to the eye as a light gray. A density of 0.05 is almost invisible unless we have a clear strip of film with which to compare it. Yet this density, as we see, reduces the sound output by 11 per cent. Thus from the standpoint of efficiency it is much more important to keep the clear side of the track free from fog than to strive for very high densities on the dark side.

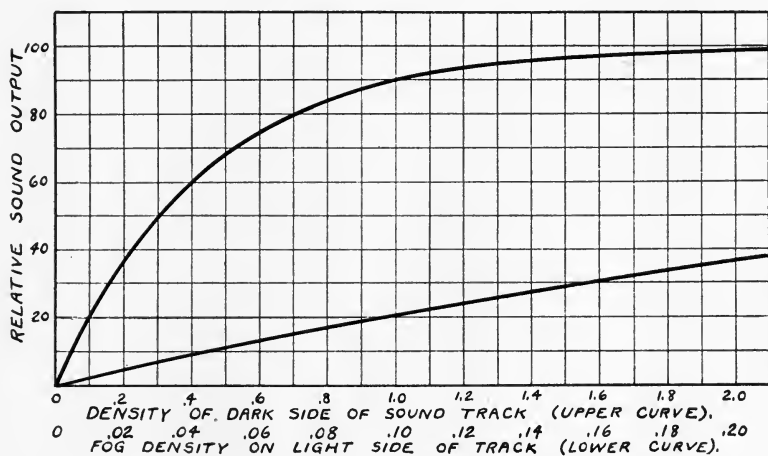

FIG. 2. Increase in sound output with increasing track density and loss of sound output with fogging of clear side.

If we have an accurate "H and D" curve for the film we use in printing, developed to the proper degree of contrast, we can determine from it and the curves of Fig. 2 just how a given sound negative will behave in printing. Such a curve is given in Fig. 3. This curve is for Eastman positive stock developed to a "gamma" (contrast factor) of 2.0 in a typical developer such as would be used for prints. From such data as are available to the writer this seems to be an average gamma for the prints being made at the present time. The curves obtained in experimental work on other film stocks resemble this one so closely in shape that the results obtained from it should be generally applicable.

Suppose we have a negative in which the exposed half of the track has a density of 1.2 while the rest of the film is fogged to a density of 0.08. The transmissions corresponding to these densities are 6.3 per cent and 83 per cent, respectively. A film exposed under this negative will receive $83/6.3$ or 13.2 times as much light on one side of the track as on the other. The logarithm of this ratio is 1.12. If the printer exposure is adjusted so as to give a density of 1.3 on the dark side of the print sound track we see from Fig. 3 that the logarithm

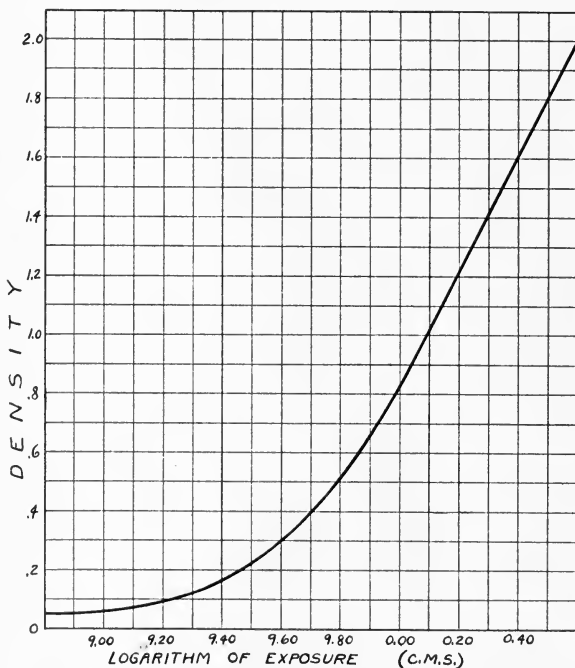

FIG. 3. H & D curve for positive film developed to $\gamma = 2.0$.

of the exposure is 0.25. The logarithm of the exposure on the protected side is 0.25 minus 1.12, or 9.13-10, which, as we see by Fig. 3, corresponds to a density of 0.08. Consulting Fig. 2 we find that a print having a track density of 1.3 with a density of 0.08 on the clear side will have a sound output of 95 per cent minus 17 per cent, or 78 per cent.

By a repetition of this process it is easy to obtain curves showing the behavior to be expected of prints made from any type of negative.

This has been done in Fig. 4, where each curve corresponds to a given negative density and shows by its rise and fall how the sound output varies with the depth to which it is printed. Naturally with short printer exposures the output is low because of the low density of the print. As the exposure is increased the sound output increases up to a certain point, after which it falls off again because the clear side of the track begins to be fogged.

The curves of Fig. 4 have been plotted in decibels because this enables us to interpret them directly in terms of the steps on the gain control of a theater installation. The zero level is the same as the

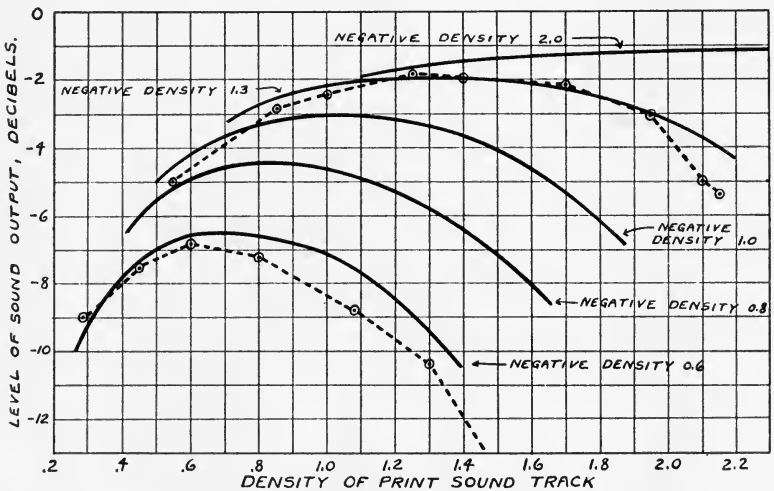

FIG. 4. Dependence of sound output on negative and print density. (Dotted curves are experimental.)

100 per cent line of Fig. 2. It will be remembered that the smallest step on the gain control is two decibels, this being the smallest noticeable difference in level. Then from Fig. 4 it appears that prints made from negatives of density 1.0 or greater are all within one step of the same level. As far as sound output is concerned there is no need of working for greater densities in the negative.

A point worth noting is that a level of minus one decibel on this scale is the highest obtainable in practice because positive film will always fog in the developer to a density of at least 0.05 regardless of whether it has received any exposure or not. The 11 per cent loss caused by this amount of fog amounts to almost exactly one decibel.

The solid lines of Fig. 4 are, of course, theoretical, except in so far as they are based on Fig. 3, which is an experimental curve. The dotted curves will serve to show how well this theory is borne out by experiment. To obtain these experimental curves two negatives were used, one weak and heavily fogged, the other about average in density and fog. The records were of the frequencies 500, 1000, 3000, 5000, and 6000 cycles, at constant amplitude. Prints were made at enough different printer light settings to obtain the form of the curve of output versus density. These prints were all developed for the same length of time, to a gamma of approximately 2. The output measurements were made by running the films on a standard projector and reading with a 1000 ohm thermal voltmeter the a.c. voltages impressed across the loudspeaker coils. The amplifier used in these tests was calibrated over the entire range of frequencies, since the tests were for the purpose of obtaining data on the frequency response of the films as well as on the general output level. The points plotted here are proportional to the averages of the outputs at 500 and 1000 cycles. Since the method of measurement does not give any absolute level for the curves, the level has been fixed by measuring the track density and fog density of the print which gave the highest point on the right hand curve and giving to that point the level thus determined from the curves of Fig. 2. It will be seen that when this is done the other points all fall into place and the curves fit well into the family of theoretical curves.

Fig. 4 tells us all that we need to know about the upper limit of the volume range. The lower limit is determined by the ground noise level. This latter is a much more difficult matter to discuss, but it is possible to draw certain conclusions. If both negative and print have received careful handling, experience shows that the ground noise on a new print is inappreciable. The noise that is important in the theater is due to dust and scratch marks which have accumulated on the film in the course of repeated projectings and rewindings. Now this will be at a maximum if the clear side of the sound track is entirely transparent. If there is a layer of fog over this side of the track it will reduce the level of ground noise in the same way that a neutral density filter placed over the slit would reduce it. The general level of sound is reduced at the same time, of course, so that if we are printing from a fairly dense negative the ratio of ground noise to maximum sound is not changed by overprinting which fogs the clear side of the track. But if the negative is weak the case is somewhat

different. As we make prints denser than those which have maximum sound output the darkening of the clear side of the track depresses the noise level at a fairly rapid rate, while the continuing increase of density on the dark side keeps the general output level from falling so rapidly. The result is that up to a fairly high density of printing the ratio of maximum sound to ground noise level is improved. This effect is shown in Fig. 5.

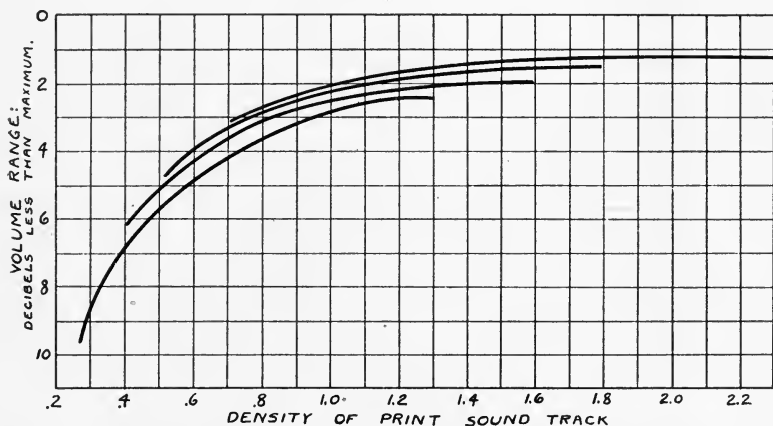

FIG. 5. Volume range as affected by print density considering only ground noise caused by dirt on prints.

On the basis of Figs. 4 and 5 it seems reasonable to draw the following conclusions:

1. The negative density should be kept above 1.0 for best results, but there is no need to work for very high densities.
2. Negatives denser than 1.0 should be printed so as to obtain a density of about 1.3 in the print.
3. A negative having a density of 0.8 should be printed to a density of about 1.1; a negative of density 0.6 should be printed to a density of 0.9; others in proportion.
4. The sound output from a negative of density 0.8 will require the gain control to be advanced about one point in order to equal the output from one of density 1.0; a negative of density 0.6 will require that it be advanced two points. This is, of course, on the assumption that the recording is all done at the same amplitude.

These conclusions are based solely on the consideration of volume

range. The remainder of the paper will show how little they need to be modified in order to obtain good frequency range.

PHOTOGRAPHIC CHARACTERISTICS AND FREQUENCY RANGE

The questions to be decided by consideration of the frequency range are: What density above 1.0 is most desirable, and by what combination of exposure and development is it best to obtain this density?

Exposure depends, of course, on the speed of the film stock being used. But since we know that for best results we need a film of high resolving power and high working contrast, our choice is restricted to the various positive stocks or to emulsions which resemble them in general behavior. If we specify exposures by the densities to which they develop under average treatment the discussion will apply equally well to all of the films now in use.

Obtaining maximum response at high frequencies means working so as to obtain the maximum resolving power of the film. Now resolving power is an intricate subject in itself, and one which has been the subject of much research. This is hardly the time or place to review the results of this research in any detail. Those who are interested will find the most important papers in the *Journal of the Optical Society* for the years 1927, 1928, and 1929.

The results which are of immediate interest can be stated rather briefly. As applying to the positive film stocks used for variable area recording they are as follows:

Resolving power is not greatly affected by changes in the time of development or in the constitution of the developer. It does decrease somewhat with increasing development, and this decrease is most noticeable when the exposure has been heavy.

If we adopt an average development and give a series of different exposures we find that the resolving power reaches a maximum of about seventy lines per millimeter at a density in the neighborhood of 1.2 or 1.3. Over the range of densities from 1.0 to 1.6 the resolving power is high, sixty lines to the millimeter or better. Below a density of 1.0 or above 1.6 the resolution falls rapidly. The combination of exposure and development particularly to be avoided is one giving densities of 2.0 or greater, for under these conditions the resolving power is reduced to less than half its maximum value.

Resolving power is also dependent upon the contrast of the object being recorded on the film. If this contrast is less than about 10 (log contrast less than 1.0) the resolving power is poor; for object

contrasts greater than 10 it is fairly satisfactory; above a contrast of 20 the improvement in resolution is not noticeable except by very precise measurements.

The contrast of the image impressed on the film in a variable area recorder is usually at least 10. The contrast of a negative of density 1.3 is about 18. Thus if we work for densities of 1.3 in both negative and print, we will have satisfied practically all requirements for obtaining the highest resolving power of the film in both negative and positive. Since a resolving power of 60 lines per millimeter would theoretically allow us to record a frequency of 27,000 cycles per second on film running 90 feet per minute, while the highest frequencies in which we are interested in practice are not above 6000, we should ex-

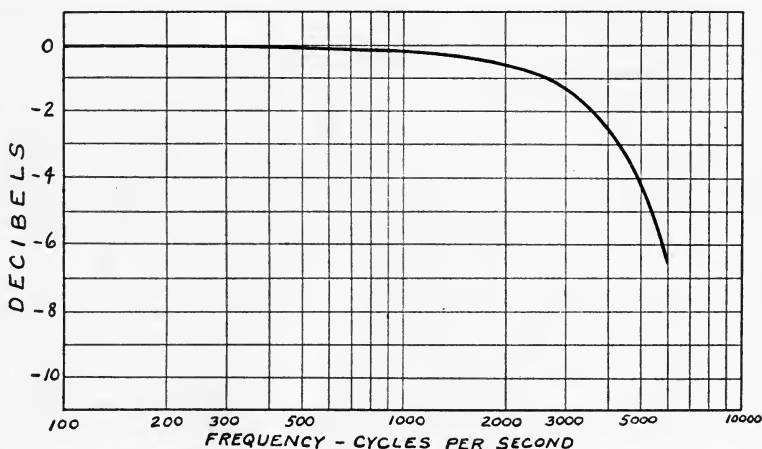

FIG. 6. Loss of high frequency output due to slit widths, including both recording and reproducing.

pect to find that the photographic loss of high frequencies is not ordinarily a serious matter. The experimental results about to be given will show that this is indeed the case.

These results were obtained from the same series of measurements which gave the two dotted curves of Fig. 4. The differences in general level which were shown in Fig. 4 have been eliminated by replotting all the results in terms of the output obtained at 500 cycles on each film. This frequency is so low that the losses due to imperfect resolving power and the width of the slits used in recording and reproducing are all negligible. Thus the results can be compared strictly on the basis of high frequency response.

The loss of high frequencies as measured by running the films through the projector comes from two causes, the width of the slits referred to above and the spreading of the image on the film itself. At present we are interested only in the latter effect. I have, therefore, made a further correction in the curves by subtracting from the losses found in the experiment those losses known to be due to the slits.

These slit losses can be calculated mathematically. The result of such calculation for the widths of the slits now in use is given in Fig. 6. It will be understood, then, that in the figures which are to follow the zero level is, in effect, the curve of Fig. 6. When the photographic losses are isolated in this way it becomes much easier to observe how they vary with differences in handling.

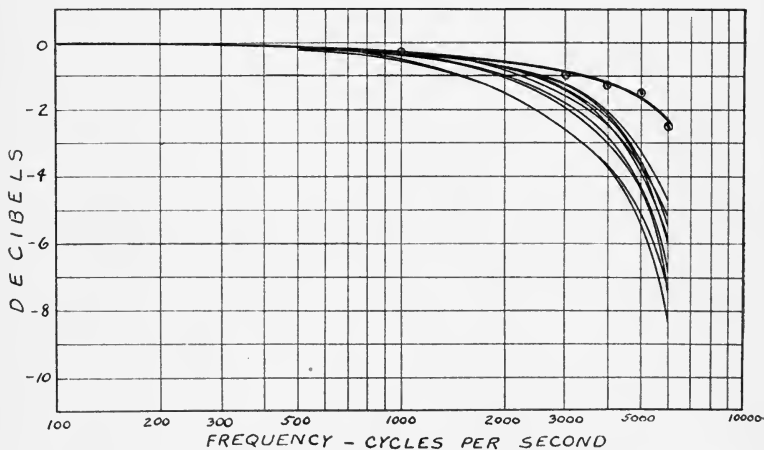

FIG. 7. Photographic loss of high frequencies in making a sound negative (upper curve) and in printing from this negative. (Highest print curve for density 1.25, lowest for density 2.15.)

Fig. 7 shows the losses due to recording on Eastman positive film and then making from that negative a series of nine prints, the densities of the prints varying over the range from 0.5 to 2.15. The negative was made on a recorder which was in commercial operation, no special attempt being made to place it in perfect adjustment. Thus the result is representative of what is obtained in practice. Possibly a slight improvement could have been made by refocusing the lenses, but since the loss in the negative is only 2.4 db. at the highest frequency, it is evident that this improvement could be only slight, and of no practical importance.

The curves for the prints show in striking fashion how little the frequency range is affected by ordinary changes in photographic procedure. The range of densities in these prints corresponds to a range of exposure of at least seven to one, yet the greatest difference in level among them at 6000 cycles is 3.8 decibels. It will be remembered that the slit loss at 6000 cycles is 6.4 decibels.

Fig. 8 shows the printing losses at 3000 and 5000 cycles plotted as functions of print density. If there were no change in the frequency characteristic with different depths of printing these curves would be straight lines parallel to the zero axis. Over the middle range of densities they do approximate such a character, while the drop at the low and high densities is, as before mentioned, comparatively

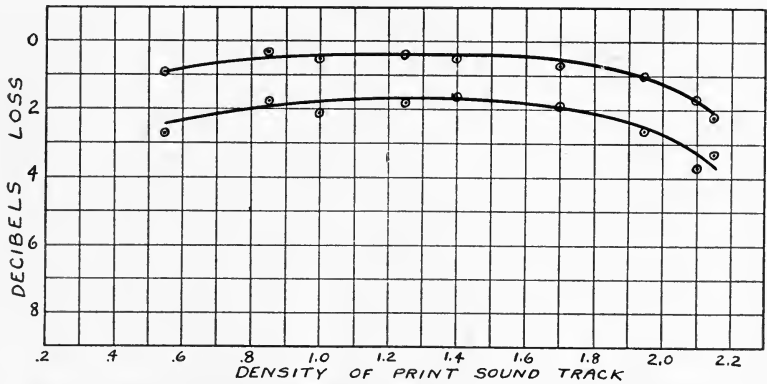

FIG. 8. Printing losses at 3000 and 5000 cycles plotted to show effect of depth of printing.

small. These curves bring to light clearly the fact which was emphasized in connection with resolving power, that is, the range of densities from 1.0 to 1.6 is the one in which the best reproduction is obtained, while the best density appears to be about 1.3.

The effect, or rather lack of effect, of differences among the film stocks now on the market is shown by Fig. 9. These curves show the losses due to recording on Eastman positive, DuPont positive, and DuPont "V.A." film, using in each case an exposure and development which gave a density between 1.0 and 1.4. The curve given for the DuPont positive is really two curves with different exposure and development but practically the same resultant density. The two coincide too closely to be shown as separate on the graph. It is evident that these films all have practically the same resolving

power, and differ only in speed and, slightly, in inherent contrast. The DuPont "V.A." film is much the fastest of the three, but also has the lowest contrast.

The makers of film have been for some time experimenting with new emulsions for sound recording. As far as the variable area process is concerned I believe the line of attack is fairly well indicated by the results which have been given. Improvement in resolving power without increase in speed will result in only slight improvement of sound reproduction. What is needed is increase of speed without loss of resolving power to a point which will permit a considerable reduction in the width of the recording slit. But even this will be of

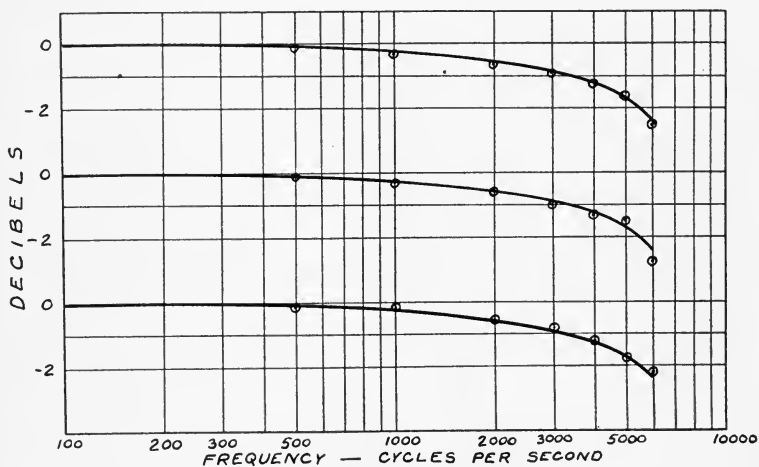

FIG. 9. Comparison of losses on three different film stocks. The curve drawn is the same in all three cases.

importance only when other parts of the system, in particular the loudspeakers, have been developed to a point which will permit the reproduction of frequencies in the range between six and ten thousand cycles per second.

Before concluding, let me summarize the properties of variable area recording as they are shown by this study:

If the recording is done on any of the present "positive" film stocks the best results will be obtained by working for a density of 1.3 in both negative and positive, with development to a gamma of approximately 2 in each case.

But on the basis of the ability of the ear to distinguish differences

in frequency range and volume, all records made from negatives of densities between about 1.0 and 1.6 will give identical results if the prints are made to a density of approximately 1.3.

If for any reason a negative of low density must be used, the result will be different to the ear only in that the volume is slightly reduced.

Variations in development of the records have no effect except as they change the density.

These results confirm the impression which has come from practical experience, that the variable area type of record permits very wide latitude in photographic treatment without sacrifice of quality in the sound.

DISCUSSION

MR. E. D. COOK: I was very interested to hear this excellent paper by Mr. Maurer. There are two comments I should like to make. One of them relates to the name that has gripped us in regard to this type of recording. In applying a name we ought to accept the name from the ideal. In so far as the varying area is present, it only contributes distortion and it would seem desirable to stick to the older term of "variable amplitude."

The second comment is relative to my paper before the New York branch of the Society, at which time I had no opportunity to reply to discussions on the calculation of slit effects. I am pleased to know that Mr. Maurer has come to this same conclusion; the effect is quite serious.

MR. TAYLOR: I was going to endorse what Mr. Cook said until he called it "variable amplitude." Amplitude is measured in a great many ways. "Variable width" appears to be a better term.

MR. PALMER: I have one question about the density of the sound track negative. It seems to me that in a system such as he described it should be very easy to produce a negative of a desired density and do that consistently because of the fact that you are using a constant candle power, and I don't understand why there should be so much variation in density on the sound track negative.

MR. MAURER: It is extremely easy to control the density of the sound track within much narrower limits than those I referred to in my discussion. Ordinarily, I believe those limits are 1.3 to 1.4 or a range somewhat similar to that. The reason it is not a simple matter to keep the density where we want it is that in order to obtain the advantages of high resolving power we have gone to the slowest film at high contrast in order to keep down high frequency losses. With this high contrast a smudge of finger grease on a lens cuts down density noticeably. The wide range referred to in my paper was to show that this wide range has little effect on the quality of the reproduced sound.

MR. SHEA: I think it is very interesting to have a paper on the proper processing conditions with the variable area method. For a considerable time an impression prevailed that little attention had to be paid to the proper choice of processing for variable area recording. I think that has been dissipated, and the fact that it has been is nothing against the method. Curiously, some of the chief benefits are in processing. The technic whose optimum has resulted in

marked gains to the industry in uniformity and saving in film recording has benefited the laboratories which are glad to work the scientific methods. The scientific method gives the laboratory man better evidence to show that he is doing his job right.

I should like to take exception to the statement that we are not interested in frequencies above 6000 cycles. The present aim is to attain between 8000 and 9000. One of the methods we use in determining whether reproducers are in proper adjustment is to examine critically at 15,000 cycles where maladjustment shows up more readily than at lower frequencies.

With regard to the reproduction loss at 6000 cycles, of $6\frac{1}{2}$ decibels, for standard practice, I believe that is incorrect.

In reply to Mr. Cook's discussion relating to comments at the New York meeting, Mr. Stryker has a paper in which actual experimental confirmation shows a close check and the loss for a one mil slit at a frequency of 6500 is 2 decibels; if it were more than this, we would change the design.

MR. MAURER: Frequencies above 6000 are going to be of decided importance in the reproduction of sound. This analysis made a number of months ago was confined to 6000 cycles because the response over the loud speakers now in use cuts off substantially at 6000 cycles. With reference to the disagreement with regard to the amount of the slit loss, I am unable to say where the disagreement may arise.

MR. HYNDMAN: I don't believe that Mr. Palmer's original question was given due consideration. He assumed that the density could be controlled by adjusting the lamp. As a matter of fact, that is the easiest problem. The principal problem of controlling density is one of development. It is very easy to get consistent results for contrast or density. At present, there is a laboratory in New York that is developing variable density film to an average track density of 0.7, and they have been very successful with their particular method of processing in meeting this value within about 5 per cent.

MR. TUTTLE: Mr. Maurer's paper also will appear in the June JOURNAL. All those contributing to the discussion are urged to see that the material is corrected before they leave the convention.

THE APERTURE EFFECT

ELLSWORTH D. COOK*

The earlier workers who recorded on, and reproduced from film will no doubt recall the poor high frequency response obtained. It has never been particularly difficult to obtain fair reproduction between the frequencies of 1000 and 2500 cycles from phonograph records, but many of the early film reproducers suffered severe losses in even this restricted range. It was soon found that the width of the beam of light which fell on the film played an important part in the reproduction of the higher frequencies. It was obvious that if the thickness of this beam of light should happen to be an integral number of wave-lengths of the recorded signal, no sound corresponding to that wave-length could be reproduced. It was also recognized that this effect was present in recording as well as in reproducing. Moreover, it is evident that this effect is oftentimes made more serious by the lens system. In order to explain the aperture effect, it is desirable to examine the complete process of recording and reproduction by means of a rectangular beam of light whose thickness in the direction of film travel is small. A little consideration shows that the same reasoning applies to both systems of recording under certain assumptions. For simplicity, the variable amplitude system will be examined. It will be evident that the ideal aperture is supposed to measure only the amplitude of the wave. In so far as area is involved, distortion results. This is mentioned because sometimes this system is called variable area recording. It is more correctly called variable amplitude recording.

It is assumed that the film is moving with constant velocity, V , and the rectangular beam of light is of uniform intensity. It is further assumed in this system of recording that wherever light falls on the film, it is fully exposed. The corresponding assumption for the variable density system would be that the exposing power of the light on the film varies linearly with the product of the intensity of the light and the time of exposure of any element of film.

* United Research Corporation, Long Island, N. Y. (This paper was read before the New York Section, April 16, 1930.)

If a cosine wave of unit amplitude and frequency $\left(\frac{\omega}{2\pi}\right)$ is recorded, the result is as shown in Fig. 1.

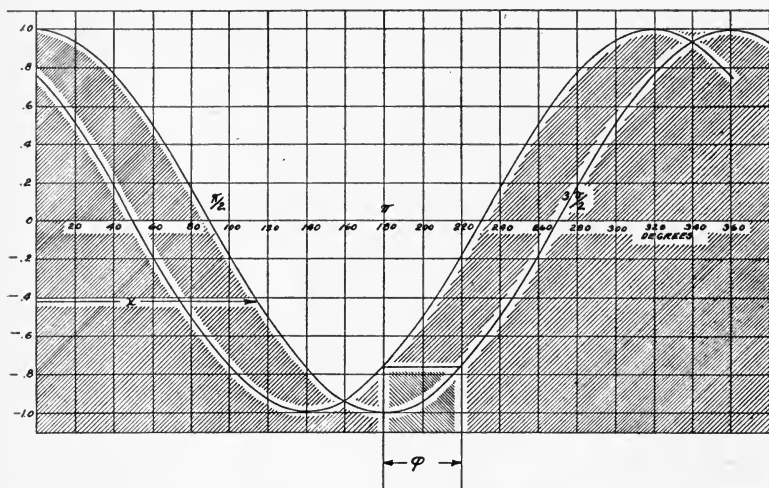

FIG. 1. Recorded wave shape for cosine wave. $\varphi = \left(\frac{2\pi s}{\lambda}\right)$ = angular width of recording aperture. s = linear width of recording aperture.

Analytically, this may be expressed as follows:

$$f\left(\frac{2\pi x}{\lambda}\right) = \cos\left(\frac{2\pi x}{\lambda}\right) \text{ for } 0 \leq \theta \leq (\pi - \varphi/2)$$

$$f\left(\frac{2\pi x}{\lambda}\right) = \cos\left(\frac{2\pi x}{\lambda} + \varphi\right) \text{ for } (\pi - \varphi/2) \leq \theta \leq (2\pi - \varphi) \dots (1)$$

$$f\left(\frac{2\pi x}{\lambda}\right) = 1 \text{ for } (2\pi - \varphi) \leq \theta \leq 2\pi$$

where

$$x = \text{linear distance from origin along film} = (vt)$$

$$f = \left(\frac{\omega}{2\pi}\right) = \text{frequency being recorded on film}$$

$$\lambda = (v/f) = \text{wave-length of that frequency on film}$$

$$\theta = (2\pi x/\lambda) = (\omega t) = \text{angular position of arbitrary point, } x$$

$$s = \text{linear width of recording aperture at the film in direction of film travel}$$

$$\varphi = \left(\frac{2\pi s}{\lambda}\right) = \text{angular width of recording aperture}$$

$$y = \text{amplitude of recorded wave at point, } x$$

The distortion introduced by the aperture effect is twofold in recording, the amplitudes of the various frequencies are altered in rela-

tion to one another and new frequencies are introduced. This is easily seen by analyzing the envelope curve of Fig. 1 in Fourier series.

$$y = f\left(\frac{2\pi x}{\lambda}\right) = \left[a_0 + \sum_{n=1}^{n=\infty} a_n \cos n\theta + \sum_{n=1}^{n=\infty} b_n \sin n\theta \right] \dots\dots\dots (2)$$

It will be found preferable to find a_1 and b_1 directly rather than to deduce these coefficients from general expressions for a_n and b_n .

$$y = \left\{ \begin{aligned} & \left(\frac{\varphi}{2\pi} + \frac{\sin \varphi/2}{\pi} \right) + \left(\{ 1 + \cos \varphi \} \left\{ \frac{1}{2} - \frac{\varphi}{4\pi} \right\} + \frac{\sin \varphi}{2\pi} \right) \cos \theta \\ & + \left(\frac{\cos \varphi - 1}{2\pi} - \left(\frac{1}{2} - \frac{\varphi}{4\pi} \right) \sin \varphi \right) \sin \theta \\ & - \sum_{n=2}^{n=\infty} \left\{ \frac{\sin n\varphi + (-1)^n 2n \sin \frac{\varphi}{2} \cos \frac{n\varphi}{2}}{n(n^2 - 1)\pi} \right\} \cos n\theta \\ & + \sum_{n=2}^{n=\infty} \left\{ \frac{1 - \cos n\varphi + (-1)^n 2n \sin \frac{\varphi}{2} \sin \frac{n\varphi}{2}}{n(n^2 - 1)\pi} \right\} \sin n\theta \end{aligned} \right\} \dots (3)$$

This may be simplified as follows:

$$y = \left[C_0 + \sum_{n=1}^{n=\infty} C_n \sin \left(\frac{2\pi nx}{\lambda} + \delta_n \right) \right] \dots\dots\dots (4)$$

Where

$$\left. \begin{aligned} C_0 &= a_0 \\ C_n &= \sqrt{a_n^2 + b_n^2} \\ \delta_n &= \arctan \left(\frac{a_n}{b_n} \right) \end{aligned} \right\} \dots\dots\dots (5)$$

The coefficients C_n have been plotted in Fig. 2. They show the effective loss of fundamental response and the generation of harmonics occasioned by increasing the size of the aperture.

The aperture effect is again encountered in the reproducer. If it is assumed that the light intensity is uniform over a rectangular reproducing aperture and the reproducing film speed, q , is constant the distortion introduced will be found to be in the alteration of the amplitudes of the various frequencies only, no additional frequencies being introduced. If $C_1 D$ is the amplitude of the recorded wave of fundamental frequency and H is one-half of the width of the sound track available, then the percentage modulation may be expressed as

$$k = \frac{D}{H} \text{ When the printed record is considered, the origin and base}$$

line must be properly chosen. The recorded wave on the final film may be expressed as

$$p = H \left[1 + k \left\{ C_0 + \sum_{n=1}^{\infty} C_n \sin \left(\frac{2\pi nx}{\lambda} + \delta_n \right) \right\} \right] \dots\dots\dots (6)$$

It is considered that no light is transmitted through the exposed part of the film and the unexposed parts pass light freely. The total light

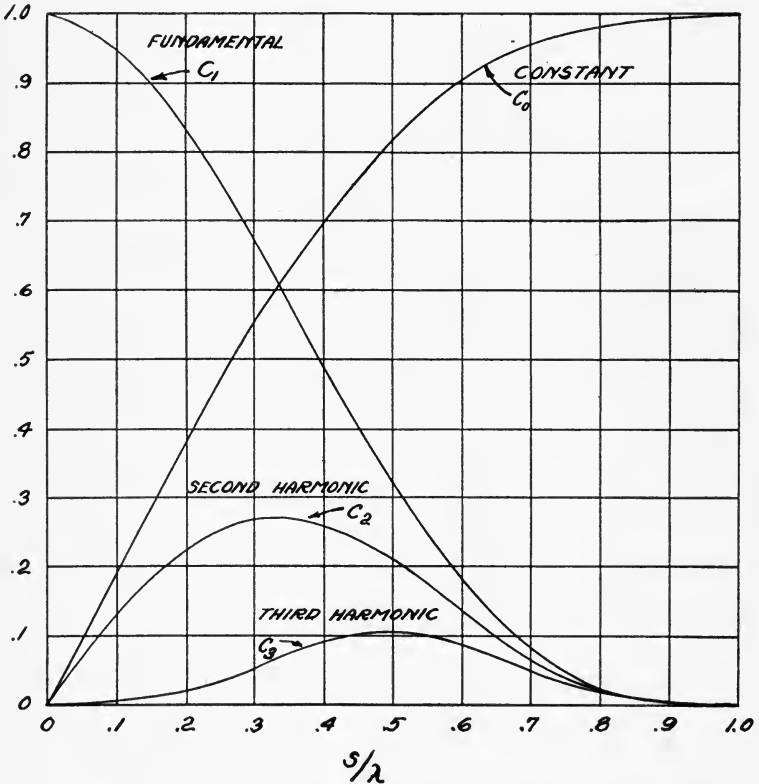

FIG. 2. Aperture effect in recording process. s = linear width of recording aperture. λ = wave-length of fundamental wave on film.

falling on the photo-electric cell is Q , and is proportional to the product of the light intensity, I , and the area of the reproducing aperture uncovered by the unexposed part of the film as it passes the aperture. The width of the reproducing aperture parallel to the length of the film will be called r .

$$Q = (kHI) \left[\int_x^{x+r} \left(\frac{1}{k} + C_o \right) dx + \sum_{n=1}^{n=\infty} C_n \int_x^{x+r} \sin \left(\frac{2\pi nx}{\lambda} + \delta_n \right) dx \right]. \quad (7)$$

or

$$Q = (rkHI) \left[\left(\frac{1}{k} + C_o \right) + \sum_{n=1}^{n=\infty} C_n \left(\frac{\lambda}{\pi nr} \sin \frac{\pi nr}{\lambda} \right) \sin \left(\frac{2\pi nx}{\lambda} + \delta_n + \alpha_n \right) \right]$$

where:

$$\alpha_n = \arctan \left(\frac{1 - \cos \left(\frac{2\pi nr}{\lambda} \right)}{\sin \left(\frac{2\pi nr}{\lambda} \right)} \right)$$

$$Q = Q_o \left[P_o + \sum_{n=1}^{n=\infty} P_n \sin \left(\frac{2\pi nx}{\lambda} + \delta_n + \alpha_n \right) \right] \dots \dots \dots (8)$$

where in this expression x is the distance from the origin along the film being reproduced.

The coefficients P_n have been evaluated up to P_3 and are plotted in Figs. 3, 4, and 5. It will be seen from Fig. 3 that any increase in the aperture width in either the recording or reproducing system will result in the loss of fundamental reproduction which can be overcome only by an increased recording speed so that the ratios, s/λ and r/λ , are again reduced. It will be evident from the physics of the phenomena as well as from the curves, that it is more desirable to use small apertures in recording than in reproducing since it is here that new or distortion frequencies are added. However, one must guard against the conclusion that a decrease in the reproducing aperture width will decrease distortion in all cases since an examination of the curves will reveal that for certain fundamental frequencies, an increase in reproducing aperture alone may actually decrease the amount of second harmonic reproduced even though the fundamental response is likewise decreased. This is illustrated more completely in Fig. 6.

It is true, however, that wide apertures in either the recorder or reproducer should be guarded against because the fundamental high frequencies are lost. The generation of harmonic distortion is another matter entirely.

In the above discussion, the width of the beam of light used in recording and reproducing is discussed. The manner of formation of this beam was not considered. It is unfortunately true that the lens system itself may cause aperture distortion in some cases. In

an optical system which uses the focussed slit, one must not assume that the beam of light at the film has the dimensions of the primary aperture plate reduced by the geometric magnification ratio. This would be true only for lenses having no chromatic or spherical aberration. A case having chromatic aberration will be examined. Fig.

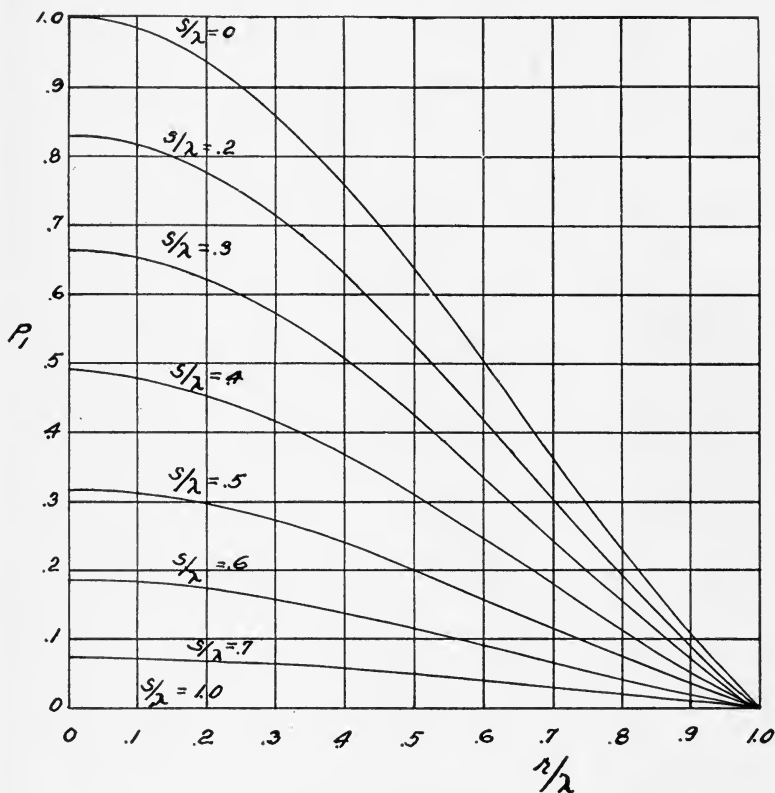

FIG. 3. Effect of recording and reproducing apertures on coefficient of fundamental component. s = linear width of recording aperture. r = linear width of reproducing aperture. λ = wave-length of fundamental on film.

7 shows the diagram of the equivalent system. The minimum possible aperture at the film will be calculated, assuming thin lens formulas and assuming that the wave-lengths of the colors in the exciter lamp system fall between λ_1 and λ_2 and all of the colors transmitted are individually capable of completely exposing the film. Then the effective aperture width due to chromatic aberration becomes the

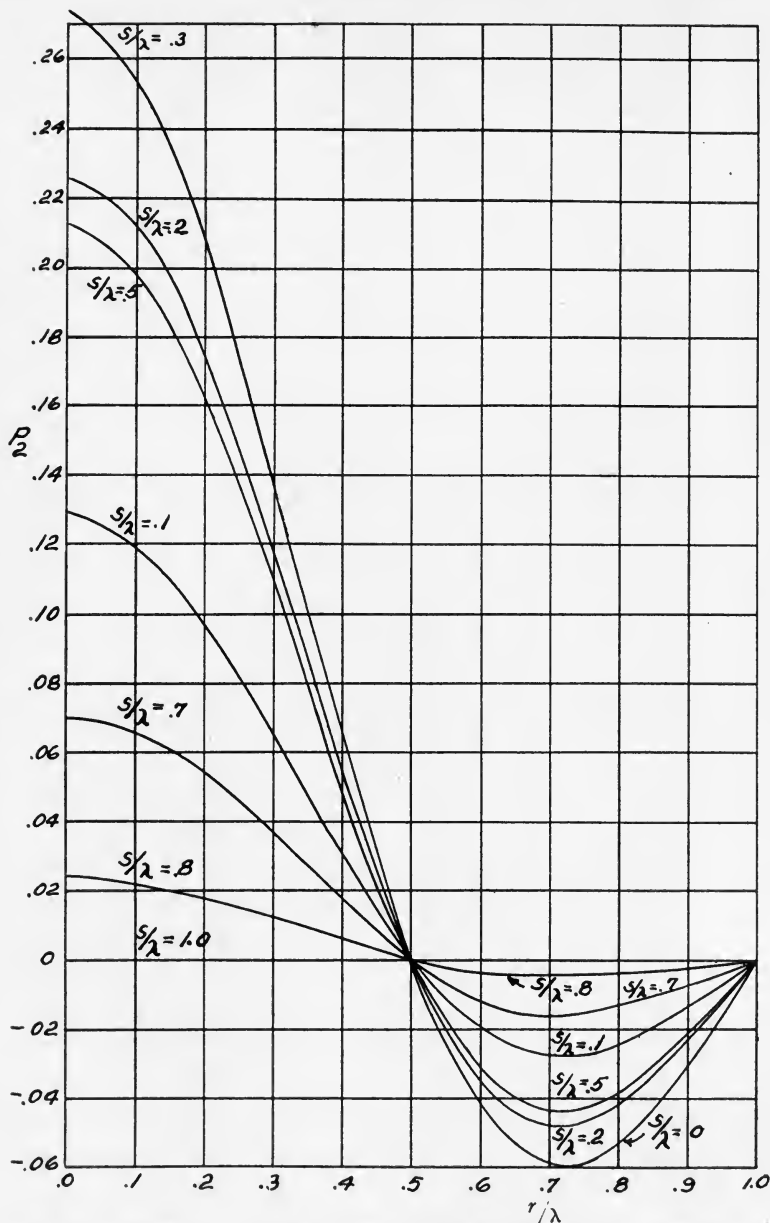

FIG. 4. Effect of recording and reproducing apertures on 2nd harmonic coefficient, for cosine wave of recording galvanometer displacement. r = linear width of reproducing aperture. s = linear width of recording aperture. λ = wave-length aperture of fundamental on film.

aperture considered in the preceding analysis. The indices of refraction for the wave-lengths, λ_1 and λ_2 , are n_1 and n_2 , respectively, and the widths of the image of the primary aperture are $2W_1$ and $2W_2$

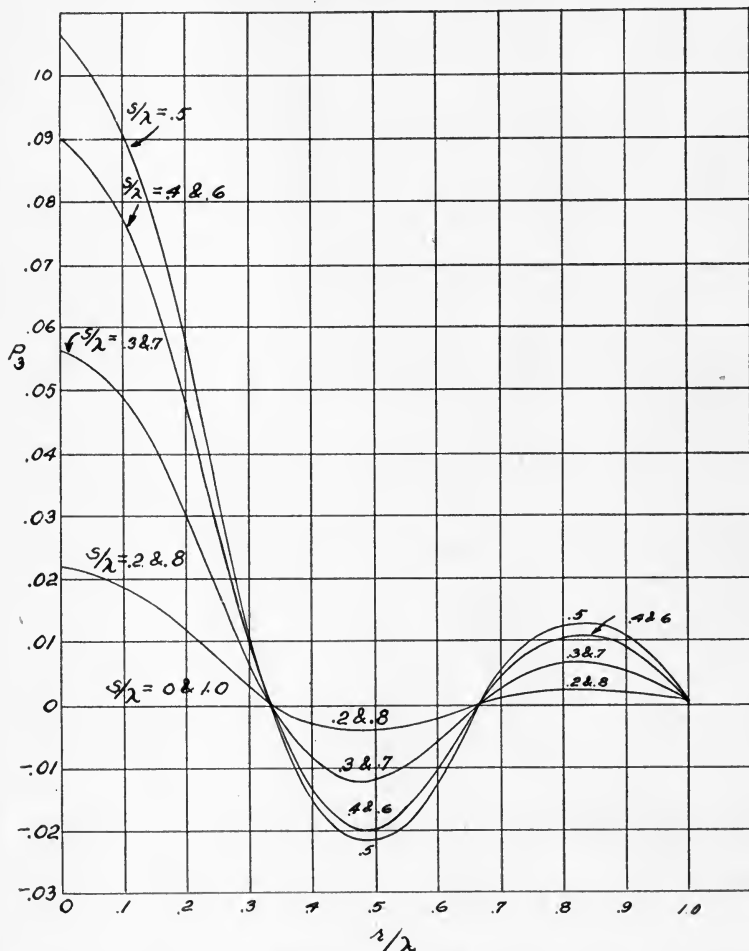

FIG. 5. Effect of recording and reproducing aperture on 3rd harmonic coefficient for cosine wave of recording galvanometer displacement. s = linear width of recording aperture. r = linear width of reproducing aperture. λ = wave length of fundamental on film.

located at distances, V_1 and V_2 , from the lens. The minimum effective aperture is $2W_m$ located at the intersection of the extreme rays, AM and BP , for the two extreme or boundary indices of refraction, or

distance, V , from the lens. The ordinates along ray, AM , will be called W' while those along BP will be called W'' , then

$$\left. \begin{aligned} W' &= \left[W_1 + \left(\frac{D + W_1}{V_1} \right) (V - V') \right] \\ W'' &= \left[W_2 + \left(\frac{D - W_2}{V_2} \right) (V_2 - V) \right] \end{aligned} \right\} \dots\dots\dots(9)$$

If the original or primary aperture had a width of $2W$, the image widths, $2W_1$ and $2W_2$, for the extreme indices of refraction are known.

$$\left. \begin{aligned} W_1 &= (W) \left(\frac{V_1}{U} \right) \\ W_2 &= (W) \left(\frac{V_2}{U} \right) \end{aligned} \right\} \dots\dots\dots(10)$$

At the point of intersection of rays, BP and AM , it is seen that W' and W'' are equal. Hence, substituting the above relations for W_1 and W_2 in the relations for W' and W'' , equating and solving for V one obtains

$$V = \left[\frac{2V_1V_2}{V_1 + V_2} \right] \dots\dots\dots(11)$$

The minimum effective aperture width may now be obtained from the equation for W'

$$W_m = \left[\frac{2 \left(\frac{W}{U} + \frac{D}{V_1} \right) (V_1V_2)}{(V_1 + V_2)} - D \right] \dots\dots\dots(12)$$

But

$$\frac{1}{f} = (n - 1) \left(\frac{1}{r_1} - \frac{1}{r_2} \right) \dots\dots\dots(13)$$

where n is the index of refraction of the lens and r_1 and r_2 the radii of the two faces of the lens. In this case, let $r_1 = r_2$; hence for thin lenses,

$$f = \frac{r}{2(n - 1)} \dots\dots\dots(14)$$

But

$$\frac{1}{f} = \left[\frac{1}{U} + \frac{1}{V} \right] \dots\dots\dots(15)$$

Solving for V between these two equations,

$$V = \left[\frac{Uf}{U - f} \right] = \left[\frac{Ur}{2U(n - 1) - r} \right] \dots\dots\dots(16)$$

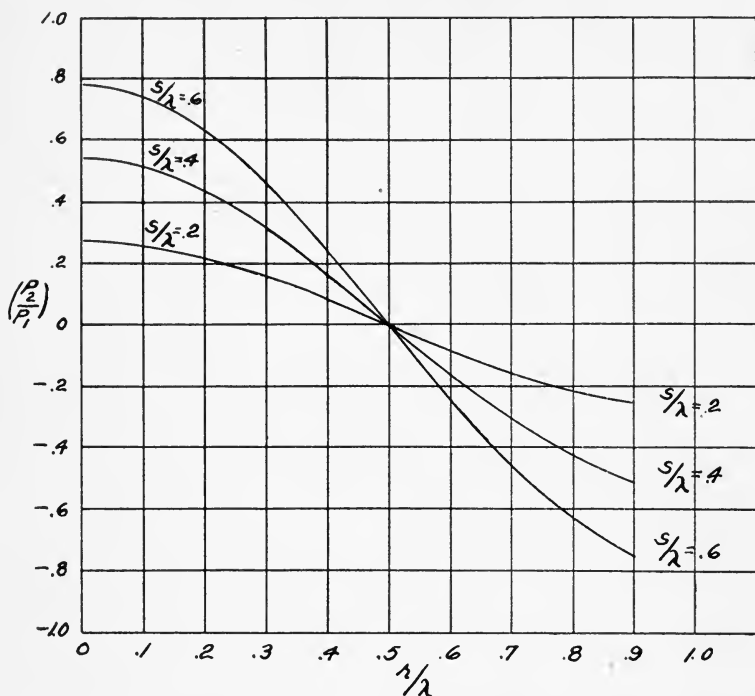

FIG. 6. Effect of recording and reproducing apertures on ratio of fundamental and 2nd harmonic coefficients for cosine wave of recording galvanometer displacement. s = linear width of recording aperture. r = linear width of reproducing aperture. λ = wave-length of fundamental on film.

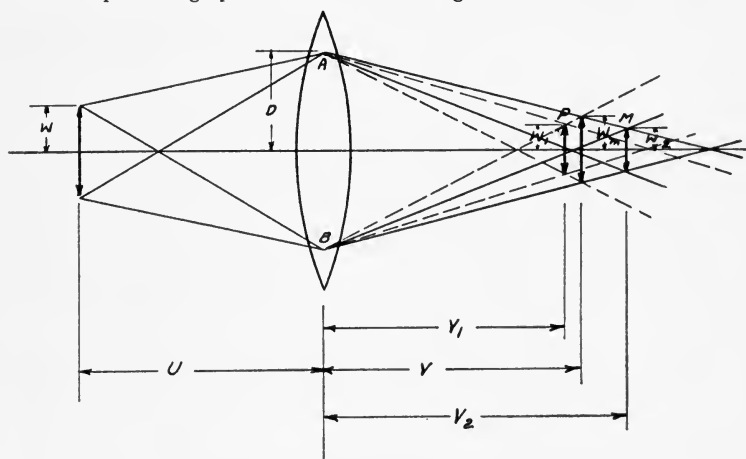

FIG. 7. Effect of chromatic aberration on aperture width.

Therefore, for the two extreme indices of refraction,

$$\left. \begin{aligned} V_1 &= \left[\frac{Ur}{2U(n_1 - 1) - r} \right] \\ V_2 &= \left[\frac{Ur}{2U(n_2 - 1) - r} \right] \end{aligned} \right\} \dots\dots\dots (17)$$

and,

$$\left(\frac{1}{V_1} + \frac{1}{V_2} \right) = \left(\frac{V_1 + V_2}{V_1 V_2} \right) = \left[\frac{2}{r}(n_1 + n_2 - 2) - \frac{2}{U} \right] \dots\dots (18)$$

Hence,

$$V = \left[\frac{1}{\left(\frac{n_1 + n_2 - 2}{r} \right) - \frac{1}{U}} \right] \dots\dots\dots (19)$$

and

$$W_m = \left[\frac{Wr + DU(n_1 - n_2)}{U(n_1 + n_2 - 2) - r} \right] = \left[W \frac{V}{U} + \frac{DV(n_1 - n_2)}{r} \right] \dots (20)$$

In the last form, W_m is expressed as the sum of two terms, the first is that considered in the usual magnification formula while the second

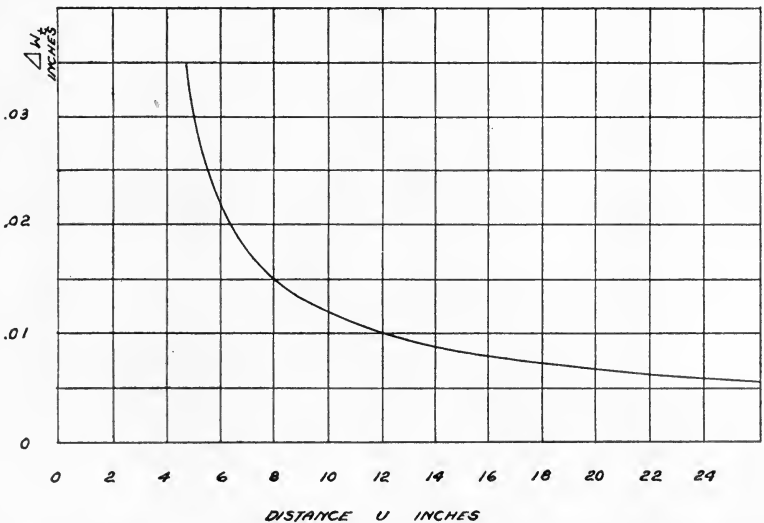

FIG. 8. Experimental results for auxiliary increase in effective aperture width due to chromatic and spherical aberration in a lens chosen to exaggerate effects.

term is the minimum increase in effective aperture possible with chromatic aberration under the above assumptions. It is interesting to note that the increment of aperture due to chromatic aberration

does not depend upon the primary aperture at all and may be decreased by increasing U , the object distance, since this decreases image distance, V .

This is most easily seen from the first form for W_m given in equation (20). In this expression, the variables, r , D , n_1 and n_2 , are to be considered fixed for any given primary aperture, W , lens, and exciter lamp conditions. Although the magnification ratio, V/U , for the image of W will be reduced if U is increased, the additional image width, ΔW_c , due to chromatic aberration alone will also be reduced. It will be observed from the second form of equation (20) that this effect is also decreased if a lens of large focal length is used or if the lens aperture, D , is made small. Of course, if monochromatic light is used,

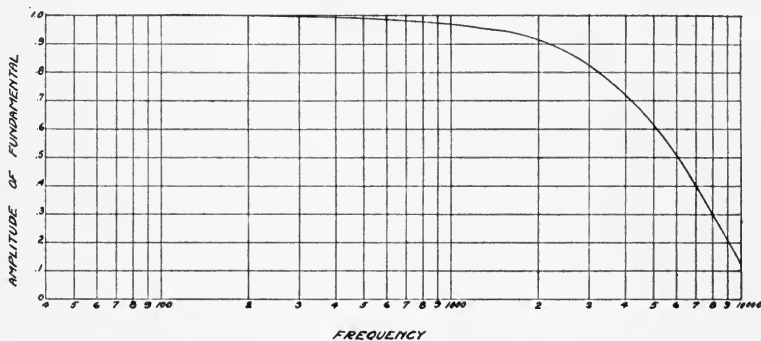

FIG. 9. Recording and reproducing aperture effect on fundamental response. Recording and reproducing effective apertures (0.001) inches and film speed 90 ft./min.

the effect is eliminated altogether. Fig. 8 shows the effect of increasing U on the total additional aperture width, ΔW_t , due to the combined effects of chromatic and spherical aberration in an experimental lens. The effects of spherical aberration must be treated at another time.

The above analytical work was performed to estimate the possible limiting amounts of the aperture effect on the fidelity in film recording and reproduction. It will be evident from the text that by proper design, these effects can, and should be, minimized. For example, if the loud speaker is incapable of adequately reproducing frequencies above 5000 cycles, the introduction of harmonics due to the recording aperture effect can be reduced to a negligible amount by the use of the proper recording aperture, since the frequencies introduced will then be made higher than the cut-off frequency of the loud speaker or at least placed in a range where faithfulness

of response is of a somewhat lesser importance. The effects of chromatic and spherical aberration of lenses on the aperture width can be almost entirely eliminated by the use of properly corrected lenses. Some improvement may be made in these effects even when poorly corrected lenses are used by preventing the extreme light rays from making large angles with the axis of the optical system. Actual photographs of the effective aperture are available and these clearly show the existence of the increased aperture width when improperly corrected lenses were used. Experimentally determined frequency characteristics of the overall process have also shown that the fidelity will not be satisfactory unless these effects are minimized by the proper choice of the width of the various apertures.

The writer wishes to acknowledge the assistance of Messrs. L. W. Bailey and G. L. Dimmick in connection with the calculations and experimental work upon which the above analysis is based.

CURVED GATES IN OPTICAL PRINTERS

WILLIAM S. VAUGHN AND FORDYCE TUTTLE*

In certain types of optical motion picture printers, it is desirable for the film, in its printing position, to be curved along its length. With certain pull-downs, for example, it is almost essential that a curved gate be used; and in some cases it is possible, by using curved gates, to dispense with pressure pads and thus avoid the difficulties attendant upon accumulated dirt, grease, and emulsion.

The question arises: When a curved object gate is used, what should be the shape of the image gate in order that the image formed by the printing lens will fall on the raw stock? Assuming a lens with a field that is flat over the angle subtended at the lens by the aperture

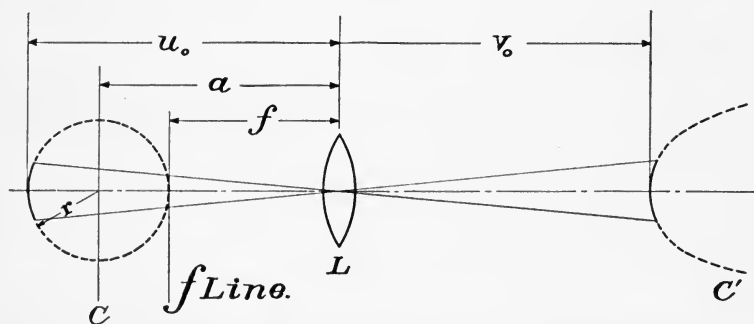

FIG. 1. Image of a curved object formed by a flat field lens.

in the object gate, the problem has been solved analytically for the general case.

(Note: The analytical treatment and the diagrams which follow are two-dimensional and apply to a vertical plane which includes the optical axis of the system. The object gate is thus designated as a circle instead of a circular cylinder, etc.)

Let the circle, C (see Fig. 1), of radius, r , represent the object circle,

* Development Department, Eastman Kodak Co., Rochester, N. Y.

the solid-line portion of this circle being the object gate proper. Let a be the distance of the center of the circle from the lens L . Let the focal length of L be f . Let C' be the curve representing the image of C formed by lens, L . Let u_o and v_o be conjugate distances of the object and image gates, measured along the optical axis. Only the absolute values of these quantities will be considered.

By the methods of simple geometry; and the use of the lens formula, we obtain the equation of the image curve, C' :

$$\frac{(f - a + r)^2(f - a - r)^2}{f^4r^2} x^2 + \frac{(f - a + r)(f - a - r)}{f^2r^2} y^2 = 1 \dots \dots \dots (1)$$

But since (Fig. 1)

$$a = u_o - r$$

$$\therefore \frac{[f - (u_o - 2r)]^2[f - u_o]^2}{f^4r^2} x^2 + \frac{[f - (u_o - 2r)](f - u_o)}{f^2r^2} y^2 = 1 \dots \dots \dots (2)$$

which we may write

$$Ax^2 + By^2 = 1 \dots \dots \dots (3)$$

The coefficient of x^2 is always positive, for real values of u_o , r , and f , but the coefficient of y^2 may be positive or negative, depending on the relative magnitudes of u_o , r , and f . Five cases arise:

Two cases for virtual images:

(a) If $f > u_o$ and $f > u_o - 2r$, then $B > 0$ and the image curve is an ellipse. Geometrically, this means that the object circle lies entirely to the right of the f -line, or the plane of the principal focus.

(b) If $f = u_o$ and $f > u_o - 2r$, then the image curve is a parabola. Geometrically, this means that the object circle lies to the right of the f -line, and is tangent to it.

Three cases for real images:

(c) If $f < u_o$ but $f > u_o - 2r$, then $B < 0$ and the image curve is a hyperbola (one branch is for a virtual image). Geometrically, this means that the object circle is intersected by the f -line.

(d) If $f < u_o$ and $f = u_o - 2r$, the image curve is a parabola (real). Geometrically, this means that the object circle lies to the left of the f -line, and is tangent to it. (See Fig. 1.)

(e) If $f < u_o$ and $f < u_o - 2r$, then $B > 0$, and the image curve is an ellipse (real). Geometrically, this means that the object circle lies wholly to the left of the f -line.

It is difficult mechanically to shape a gate into a parabola, hyper-

bola, or ellipse, and hence a value of r was sought which would make the gate a circle, that is, make the coefficients of x^2 and y^2 in (2) equal. This value is:

$$r = \frac{u_o(u_o - 2f)}{2(u_o - f)} = \frac{u_o - v_o}{2} \dots\dots\dots(4)$$

This value not only makes the image curve a circle, but a circle of

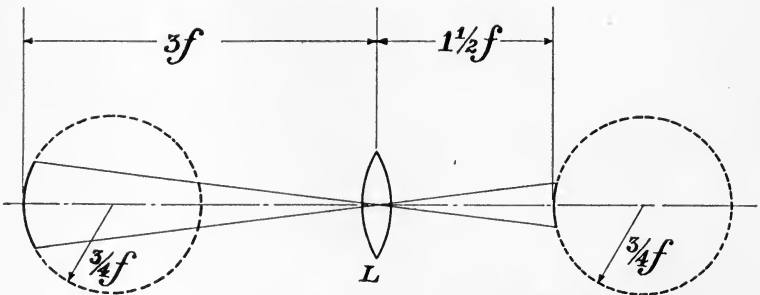

FIG. 2. Special solution for a 2:1 reduction printer.

exactly the same size as the object circle. For any magnification we may express r as a function of f and m (magnification) as follows:

$$r = \frac{1}{2}f(m - \frac{1}{m}) \dots\dots\dots(5)$$

Thus for a print with a 2:1 reduction ratio (see Fig. 2)

$$r = \frac{1}{2}f(\frac{3}{2}) = \frac{3}{4}f$$

From (5) we see, however, that it is impossible to make use of this special solution for printing at one-to-one magnification, for in that case $m = 1$ and the radius becomes zero.

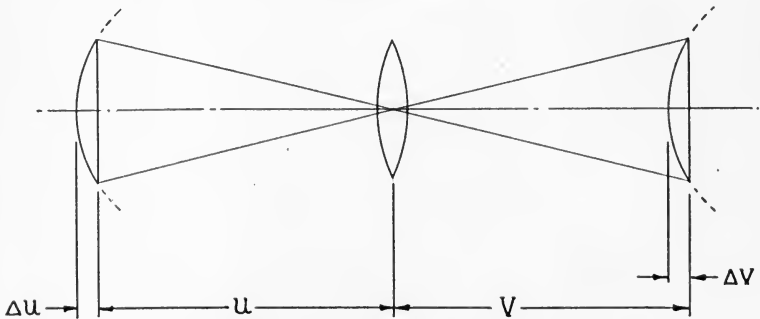

FIG. 3. Illustration of method of computing best circle for image gate.

If certain prescribed conditions of the system preclude using the value of r derived from Equation 5 (as in the case of one-to-one magnification), we may resort to an approximation method for finding the radius for a circular image gate which will cut the image curve in three points, one on the axis and the other two symmetrically spaced with respect to the axis. Thus if we wish to make the top, center, and bottom of the image fall on a circular image gate we choose a radius of curvature such that

$$r = \frac{1/2 \text{ cord of image gate}}{\text{Sin} \left[180^\circ - 2 \text{ arc tan} \left(\frac{1/2 \text{ chord of image gate}}{\text{sagitta of image gate}} \right) \right]}$$

where the chord of image gate is computed (see Fig. 3) as v/u times the chord of object gate, and the sagitta of the image gate is:

$$\Delta v = v - \frac{f(u + \text{sagitta of object gate})}{(u - f + \text{sagitta of object gate})}$$

It should be mentioned that with any curved object gate there will be distortion in the image. The central portion of the picture will be vertically expanded or condensed relative to the top and bottom of the picture, depending on whether the picture is being enlarged or reduction printed.

SOME PROPERTIES OF CHROME ALUM STOP BATHS AND FIXING BATHS (PART II)*

J. I. CRABTREE AND H. D. RUSSELL

PART II. CHROME ALUM FIXING BATHS

INTRODUCTION

The desirable properties of chrome alum fixing baths are analogous to those of potassium alum fixing baths as outlined in a previous paper.¹ A satisfactory bath should have the following properties: (1) It should fix the film sufficiently rapidly and should have a fairly long fixation life; (2) the bath should harden the film to a sufficient degree and should maintain its hardening properties either with or without use; (3) it should not sulfurize prematurely at temperatures below 85°F.; (4) the propensity of the bath to deposit a sludge on the addition of developer should be a minimum; and (5) there should be a minimum tendency to produce blisters even when used in conjunction with a strongly alkaline developer.

Previous work with chrome alum fixing baths in this laboratory has been confined to the compounding of baths suitable for use at high temperatures and a satisfactory formula which maintains its hardening properties even with use over a period of one or two weeks has been recommended.² At normal temperatures, however, when used in a deep tank such a formula tends to harden the film to an undesirable and unnecessary degree, and is relatively expensive.

In order to compound an efficient chrome alum fixing bath formula for motion picture work at normal temperatures it was attempted to study the various properties of a mixture of chrome alum, sodium sulfite, an acid, and hypo, in a manner similar to the methods used to study the properties of aluminum alum as described in a previous paper.¹ An attempt was therefore made to prepare curves showing the hardening produced by various concentrations of a chrome alum solution with the addition of varying proportions of acetic acid,

* Communication No. 432, Kodak Research Laboratories (continued from May, 1930).

sulfuric acid, and sodium sulfite. The results at first obtained were very inconsistent and duplicable only within a small degree of accuracy so that further experiments were made to determine the reason for this inconsistency. It was at first observed that the time elapsing between the preparation of the bath and the time of testing apparently influenced the hardening produced by the bath. For this reason it was decided that the most satisfactory method of arriving at a suitable formula was to make a large number of tests with baths in which the quantities of sodium sulfite, chrome alum, and various acidifiers were altered independently and to determine the properties of the resulting baths. The following acidifiers were tested: acetic, citric, and sulfuric acids, sodium bisulfite and sodium bisulfate.

Method of Testing the Experimental Baths.—Since the most important factor under consideration was the retention of the hardening properties of the baths with keeping, only this property in addition to the sulfurization life of the experimental baths was determined in the preliminary tests. To facilitate storage of the large number of samples, most of the solutions were kept in stoppered bottles and then poured into trays for use.

The hardening properties of the various baths were determined as follows: Strips of motion picture positive film were exposed through a step tablet, developed, rinsed, and fixed in the various baths for five minutes at 65°F. to 70°F. After washing for twenty minutes the strips were pinned to a small wooden frame and placed in a beaker of water. A thermometer was suspended in the beaker and the water heated by means of an electric hot plate at the rate of about 5 degrees per minute. The frame was moved up and down about twice a minute in order to stir the water and remove air bubbles from the strips of film. The melting temperature of the gelatin on the various strips was taken as that temperature at which it flowed from the support.

Table I gives the composition (grams per liter), duration of hardening properties, and the sulfurization life of a number of experimental baths. The same quantity (240 grams per liter of sodium thiosulfate) was used in all the fixing baths. Several of the tests were duplicated and both series of results are given. In a few cases the solutions were stored in open trays instead of bottles and these are indicated by a "T" following the experiment number.

The following facts may be deduced from a study of Table I.

(1) Sulfuric acid is superior to acetic and citric acids or sodium bisulfite for use in a chrome alum fixing bath because with a sulfuric acid bath the hardening properties do not fall off so rapidly with age. The formulas containing 3 cc. of sulfuric acid per liter liberated so much sulfur dioxide gas that they were considered unsatisfactory for use. Those containing 1.0 cc. of sulfuric acid per liter appeared to have too low an acidity to be practical. A concentration of 2 cc. per liter was considered the most satisfactory concentration.

Baths containing citric acid gave no hardening whatsoever and in this respect the behavior of citric acid in a chrome alum bath is similar to its effect with potassium alum baths.

(2) Chrome alum baths containing sodium bisulfite have poor keeping properties unless a relatively high concentration of chrome alum is present.

(3) An increase in the concentration of sodium sulfite lowers the hardening life with age and increases the sulfurization life while a decrease prolongs the hardening life and causes the bath to sulfurize more readily.

(4) With high concentrations of chrome alum the degree of hardening increases, the hardening properties are maintained better on storage, while the sulfurization life is decreased. The reverse is true if the concentration of chrome alum is lowered.

(5) The hardening properties of some baths fall off more rapidly with age when stored in an open tray.

(6) With a fixed proportion of chrome alum and sodium sulfite, the hardening produced with alkaline film increases with the acid concentration of the bath within the limits tested. Apparently with the higher concentrations of acid tested the conditions are most suitable for the formation of a basic chromium sulfate which produces the maximum degree of hardening. This observation agrees with the fact that it was possible to restore the hardening properties of some partially used chrome alum fixing baths by the addition of further quantities of acid.

(7) The formulas having the best hardening properties have an optimum ratio of 3:5 by weight of sodium sulfite to chrome alum. Less sulfite hastens sulfurization while the addition of more sulfite lowers the degree of hardening produced.

Further tests were made with the most promising formulas as well as others which were suggested from a study of the previous experiments. These tests were all made by storing the solutions in trays

TABLE I
Hardening Properties of Chrome Alum Fixing Baths

No.	Sodium Sulfite, Grams	Potass. Chrome Alum, Grams	Sulfuric Acid, Cc.	Melting Point—Degrees Fahrenheit										Sulfurization Life—Days	
				0 Days	2 Days	3 Days	5 Days	7 Days	8-9 Days	11 Days	14 Days	17 Days	21 Days	70°F.	110°F.
1	15	15	2	186	142	125	123	130	124	107	131	129	26+	4	
1	15	15	2	188	138	138	108	102	110	160	99	26+	3		
1T	15	15	2	168	111	104	200+	200+	200+	200+	200+	200+	26+	1	
2	10	15	2	177	200+	200+	97	198	198	200+	200+	200+	26+	26+	
3	20	15	2	119	106	99	166	198	200+	200+	200+	200+	25	1	
4	10	15	1	200+	178	152	180	102	200+	200+	200+	200+	26+	2	
4	10	15	1	194	125	111	111	102	200+	200+	200+	200+	25	1	
4T	10	15	1	162	125	111	111	102	200+	200+	200+	200+	26	12	
5	20	15	1	100	100	96	94	185	202	200+	200+	200+	26	2	
6	15	20	2	188	179	146	157	185	200+	200+	200+	200+	25	2	
6	15	20	2	193	177	177	107	107	200+	200+	200+	200+	25	2	
6T	15	20	2	144	137	115	116	107	200+	200+	200+	158	21	1	
7	15	25	2	201	199	200+	200+	200+	200+	200+	200+	200+	15	1	
7	15	25	2	198	200+	200+	200+	200+	200+	200+	200+	200+	19	1	
7T	15	25	2	144	200+	200+	200+	200+	200+	200+	200+	200+	26+	26+	
8	15	15	1	122	105	100	98	160	146	152	160	200+	26+	2	
9	20	20	1	116	105	99	98	160	146	152	160	200+	26+	12	
10	20	30	1	204+	174	148	146	200+	200+	200+	200+	200+	21	1	
11	15	15	3	137	167	165	189	200+	200+	200+	200+	200+	13	1	
11	15	15	3	154	155	155	103	103	200+	200+	200+	200+	2	1	
11T	15	15	3	156	108	104	105	103	200+	200+	200+	200+	2	2	
12	10	20	2	204+	200+	200+	200+	200+	200+	200+	200+	200+	23	2	
13	12.5	20	1	160	184	200+	200+	200+	190	200+	200+	200+	18	1	
14	12.5	20	1.5	136	200+	200+	200+	200+	200+	200+	200+	200+	13	1	
14	12.5	20	1.5	182	200+	200+	200+	200+	200+	200+	200+	200+	13	1	
14T	12.5	20	1.5	153	200+	185	200+	165	181	200+	200+	200+	30+	1	

TABLE I (Continued)
Hardening Properties of Chrome Alum Fixing Baths

No.	Sodium Sulfite, Grams	Potass. Chrome Alum, Grams	Sulfuric Acid, Cc.	Melting Point—Degrees Fahrenheit											Sulfurization Life—Days	
				0 Days	2 Days	3 Days	5 Days	7 Days	8-9 Days	11 Days	14 Days	17 Days	21 Days	70°F.	110°F.	
15	12.5	20	2	145	200+					200+	200+	200+	200+	200+	18	1
15	12.5	20	2	155	200+	200+				200+	200+	200+	200+	200+	8	<1
15T	12.5	20	2	190	200+	200+	200+			200+	200+	200+	200+	200+	14	1
16	12.5	25	1	175	200+	200+	200+			200+	200+	200+	200+	200+	18	<1
16	12.5	25	1	185	200+	200+	200+			200+	200+	200+	200+	200+	8	<1
16T	12.5	25	1	200+	200+	200+	200+			200+	200+	200+	200+	200+	21	1
17	12.5	25	1.5	133	200+	200+	200+			200+	200+	200+	200+	200+	18	<1
17	12.5	25	1.5	194	200+	200+	200+			200+	200+	200+	200+	200+	8	<1
17T	12.5	25	1.5	190	200+	200+	200+			200+	200+	200+	200+	200+	14	1
18	12.5	25	2	148	200+	200+	200+			200+	200+	200+	200+	200+	18	<1
18	12.5	25	2	189	200+	200+	200+			200+	200+	200+	200+	200+	8	<1
18T	12.5	25	2	191	200+	200+	200+			200+	200+	200+	200+	200+	7	4
1T	15.0	15	2	175	138	200+	200+	200+	123	119	200+	200+	117	200+	23+	1
28	17.5	30	2	193	200+	200+	200+			200+	200+	200+	200+	200+	11	1
28	17.5	30	2	200+	200+	200+	200+			200+	200+	200+	200+	200+	13	1
28T	17.5	30	2	158	200+	200+	200+			200+	200+	200+	200+	200+	30	<1
29	17.5	40	2	200+	200+	200+	200+			200+	200+	200+	200+	200+	11	<1
29	17.5	40	2	146	200+	200+	200+			200+	200+	200+	200+	200+	8	1
29T	17.5	40	2	175	200+	200+	200+			200+	200+	200+	200+	200+	7	1 hr.
30	17.5	50	2	200+	200+	200+	200+			200+	200+	200+	200+	200+	11 hr.	1
31	17.5	25	3	150	200+	200+	200+			200+	200+	200+	200+	200+	11 hr.	<1
32	17.5	30	3	172	200+	200+	200+			200+	200+	200+	200+	200+	11 hr.	<1
33	17.5	35	3	200+	200+	200+	200+			200+	200+	200+	200+	200+	11 hr.	<1

TABLE I (Continued)
 Hardening Properties of Chrome Alum Fixing Baths

No.	Sodium Sulfite, Grams	Potass. Chrome Alum, Grams	Citric Acid, Grams	Sodium Acetate, Grams	Melting Point—Degrees Fahrenheit								Sulfurization Life—Days			
					0 Days	1 Days	2 Days	4 Days	5 Days	8 Days	12 Days	14 Days	21 Days	70°F.	110°F.	
20	10	30	6	20	99											20
21	10	15	6	20	108											20+
22	24	45	9		99											1
23	15	13	9	20	100											20+
24	15	30	9	20	94											20+
25	10	15	5		97											7
26	20	40	2.5		200+	133	105									19+
27T	40	80	2.5		200+	200+	170									37+
27T	40	80	2.5		200+	200+		134								24+
43T	20	40	2.5		150	150	109									4
44T	20	40	10		113	124	114	104	109							2
45T	20	40	20	10	161	122	109	104	109							2
35	15	15	25		98	99	97									17
36	15	15	50		98	99	97									17
40	15	25	50		123	110	97									4
42	40	80	25		200+	192										1
38	15	25	7.5		166	200+	200+	200+	200+	200+	181					42
1	15	25	11.0		153	200+	200+	200+	200+	200+	200+					27

TABLE II
Hardening Properties of Chrome Alum Fixing Baths

No.	Sodium Sulfite, Grams	Potass. Chrome Alum, Grams	Sulfuric Acid, Cc.	Sodium Pyro Sulfate, Grams	Melting Point—Degrees Fahrenheit								Sulfurization	
					0 Days	1 Days	3 Days	10 Days	15 Days	26 Days	36 Days	Room Temp.	110°F.	
14	12.5	20	1.5		170	200+	200+	200+	200+	200+	130	115	30	<1
17	12.5	25	1.5		170	200+	200+	200+	200+	200+	178	200+	12	<1
7	15.0	25	2.0		147	200+	200+	200+	200+	200+	178	200+	30	<1
50	15.0	30	2.0		172	200+	200+	200+	200+	200+	178	141	12	<1
51	15.0	25		7.5	161	200+	200+	200+	200+	200+	178	141	30	<1
52	15.0	25		11.0	141	200+	200+	200+	200+	200+	178	141	12	<1
28	17.5	30	2.0		184	200+	158	200+	200+	132	178	141	12	<1
29	17.5	40	2.0		200+	200+	200+	200+	200+	200+	178	141	12	<1
32	17.5	30	3.0		174	190	131	200+	200+	200+	178	141	12	<1
56	20.0	30	1.5		200+	200+	200+	115+	113	200+	200+	200+	30	6
57	20.0	40	1.5	Glacial Acetic Acid, Cc.	200+	200+	200+	200+	200+	200+	200+	200+	30	1
27	40.0	80		7.5	200+	200+	200+	120	123	99	95	36	6	

and diluting them from day to day to compensate for evaporation since the first tests showed that some of the solutions retained their hardening properties longer when stored in bottles. The results are shown in Table II.

Sludging Properties.—Tests were made to determine the sludging tendencies of the various baths listed in Table II before any definite judgment could be made as to the relative values of the various formulas. Quantities (50 cc.) of the different fixing baths were placed in small glass bottles having wide mouths. Various quantities of a highly alkaline developer containing 5 per cent sodium carbonate (desiccated) were then added to the solutions and after shaking they were stored at room temperature. The solutions were then observed

TABLE III
TIME (DAYS) REQUIRED FOR A PRECIPITATE TO FORM IN FIXING BATHS

*No.	Cc. of Developer Added to 100 Cc. of Fixing Bath					
	0.0	1.0	2.5	5.0	10.0	15.0
14	14-S	>15	>15	3-Cr	Im.	Im.
17	7-S	7-S	>15	Im.	Im.	Im.
7	10-S	>15	>15	2-Cr	Im.	Im.
50	7-S	14-S	>15	<1-Cr	Im.	Im.
51	14-S	>15	>15	5-Cr	Im.	Im.
52	7-S	7-S	>15	Im.	Im.	Im.
28	14-S	>15	>15	2-Cr	>1-Cr	Im.
29	7-S	7-S	15-S	<1-Cr	Im.	Im.
32	7-S	7-S	15-S	Im.	Im.	Im.
56	14-S	>15	>15	8-Cr	6-Cr	3-Cr
57	15-S	>15	>15	3-Cr	<1-Cr	<1-Cr
27	>15	>15	>15	>15	>15	>15

* Compositions are given in Table II.

S = Precipitate of Sulfur.

Cr = Precipitate of Chromium Hydroxide.

Im. = Immediate Precipitate of Chromium Hydroxide.

daily and the times required to precipitate either sulfur or a chromium sludge noted. The results are recorded in Table III.

A SUITABLE CHROME ALUM FIXING BATH FORMULA FOR MOTION
PICTURE WORK

It was considered that for motion picture work the fixing bath should not harden the film excessively but it should maintain its hardening properties on keeping, should not sludge on the addition of a relatively large quantity of developer, and should not sulfurize within a period of one to two days at 110°F. which corresponds roughly to

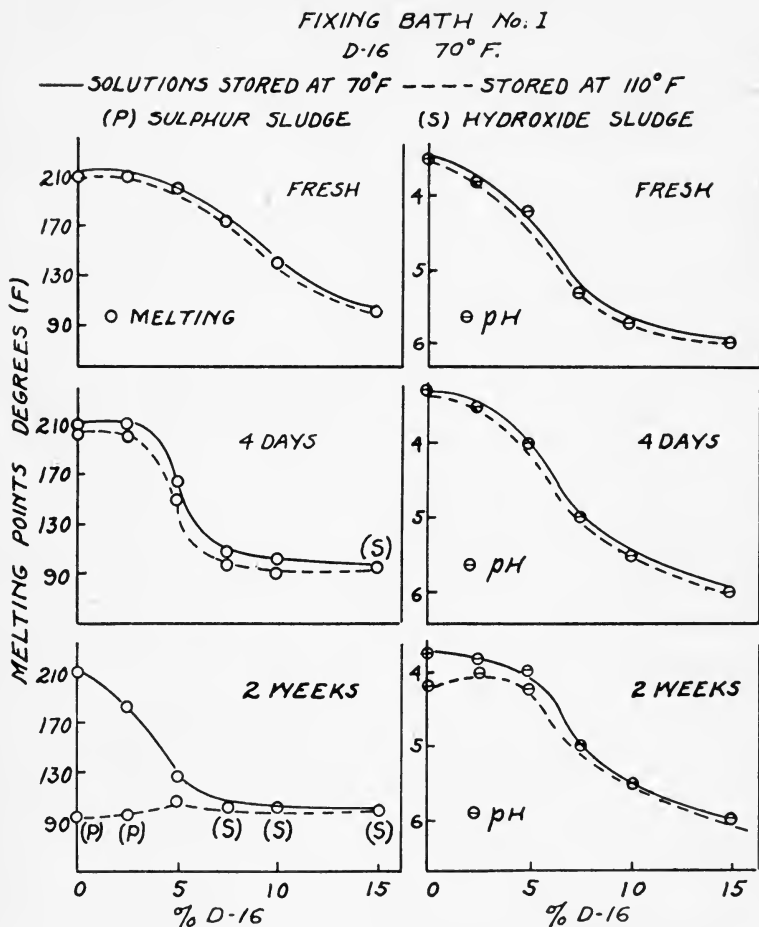

FIG. 1. Effect of the addition of D-16 developer on the hardening properties of chrome alum fixing bath No. I.

a period of about four weeks at 70° F. From a study of the above tables in the light of these requirements two formulas were chosen having the following composition:

Formula I

	Metric	Avoirdupois
Hypo	300 grams	125 lbs.
Sodium sulfite (desiccated)	15 grams	6 lbs. 4 oz.
Potassium chrome alum	20 grams	8 lbs. 5 oz.
Sulfuric acid (concentrated)	2 cc.	12 ³ / ₄ oz.
Water to make	1 liter	50 gals.

Formula II

Hypo	300 grams	125 lbs.
Sodium sulfite (desiccated)	17.5 grams	7 lbs. 5 oz.
Potassium chrome alum	32.0 grams	13 lbs. 4 oz.
Sulfuric acid (concentrated)	2 cc.	12 ³ / ₄ oz.
Water to make	1 liter	50 gals.

It is not desirable to prepare a stock hardener consisting of the sulfite, alum, and sulfuric acid because this would lose its hardening properties on keeping.

Practical exhaustion tests were made with the above formulas to determine their behavior on exhaustion with motion picture film developed in the D-16 and D-76 developers, the processing being conducted both at 70°F. and 85°F.

(1) *Effect of Addition of Developer on Hardening Properties.*—Since the loss of hardening properties of a chrome alum fixing bath with immediate use is a result of the addition of developer, increasing quantities of D-16* and D-76** developers were added to definite quantities of fixing bath No. I stored in bottles at 70°F. and 110°F., and the hardening properties of these solutions determined at daily intervals as follows:

Strips of Eastman motion picture positive film were developed for five minutes in D-16 developer, then placed directly in the fixing

**Formula D-16*

	<i>Metric</i>	<i>Avoirdupois</i>
Elon	0.3 gram	2 oz.
Sodium sulfite (desiccated)	40.0 grams	16 ¹ / ₂ lbs.
Hydroquinone	6.0 grams	2 ¹ / ₂ lbs.
Sodium carbonate (desiccated)	19.0 grams	7 ³ / ₄ lbs.
Potassium bromide	0.9 gram	5 ³ / ₄ oz.
Citric acid	0.7 gram	4 ¹ / ₂ oz.
Potassium metabisulfite	1.5 grams	10 oz.
Water to make	1.0 liter	50 gals.

Average time of development: 5 to 10 minutes at 65°F. (18°C.)

***Formula D-76*

	<i>Metric</i>	<i>Avoirdupois</i>
Elon	2 grams	13 oz.
Sodium sulfite (desiccated)	100 grams	42 lbs.
Hydroquinone	5 grams	2 lbs.
Borax	2 grams	13 oz.
Water to make	1 liter	50 gals.

Average time of development: 12 to 25 minutes at 65°F. (18°C.)

bath, without rinsing, for five minutes, washed twenty minutes and the melting points determined. Similarly, strips of Eastman panchromatic negative motion picture film were developed for ten minutes in D-76 developer, fixed for ten minutes, washed for twenty minutes, and the melting points determined.

The acidity of the various solutions was determined by a colorimetric method using indicators, as described in Part I of this paper.

Fig. 1 shows the effect of the addition of D-16 developer on the hardening properties of fixing bath No. I from which it is seen that:

(a) The hardening action and the acidity of the fresh bath gradually decreased as the quantity of developer added increased, and the degree of hardening was not satisfactory after a quantity of developer had been added equal to 7.5 per cent of the volume of the bath. This corresponds to 150 feet of unrinsed motion picture positive film per gallon which may be considered as the life of the fresh bath.

(b) After standing four days at 70°F. the life of the bath was reduced to 100 feet of film per gallon and after two weeks at 70°F. to 75 feet per gallon.

(c) The hardening action of the solutions stored at 70°F. was similar to that of solutions stored at 110°F. until the latter sulfurized.

(d) A minimum degree of hardening was obtained after the solutions had been stored two weeks at 110°F.

(e) The acidity of the solutions containing 2.5 per cent and 5 per cent of D-16 increased on standing.

(f) The hardening properties of the solutions whose pH value was greater than 4.0 decreased on ageing, which indicates that the pH of the bath should always be maintained at a value less than 4.0 in order to obtain uniform hardening properties.

The hardening properties of fixing bath No. I diminished more rapidly on the addition of a definite volume of D-76 than was the case with D-16. With D-76 at 70°F. the life is about 100 feet of unrinsed motion picture negative film per gallon of fresh fixing bath but when four days old this is reduced to 60 feet per gallon. The life on storage at 110°F. was of the same order.

(2) *Effect of the Addition of Sodium Sulfite and Sodium Carbonate on Hardening Properties.*—The following table indicates the relative effect of sodium sulfite and sodium carbonate when added to the fixing bath. The hardening tests were made with positive film developed in D-16 at 70°F., the samples being stored at 110°F.

From these tests it would appear that 2.5 parts by weight of sodium sulfite produce the same effect as one part by weight of sodium carbonate, which ratio corresponds to the relative alkalinity of the two salts using phenolphthalein as an indicator. It is apparent, therefore, that the falling off in hardness with immediate use is largely a result of a change in the acidity of the bath.

TABLE IV

Effect of Addition of Sodium Sulfite and Sodium Carbonate on Hardening Properties of Chrome Alum Fixing Bath, No. I

Grams Sodium Sulfite (des.) per 100 Cc. Fixing Solution	Melting Points		
	Fresh	2 Days	5 Days
0.4	>212°F.	180°F.	170°F.
0.8	>212°F.	145°F.	140°F.
1.2	174°F.	106°F.	106°F.
1.6	134°F.	97°F.	97°F.
2.4	116°F.	97°F.	97°F.
Grams Sodium Carbonate (des.) per 100 Cc. Fixing Solution			
0.2	>212°F.	182°F.	180°F.
0.4	172°F.	P—96°F.
0.6	124°F.	P—96°F.
0.8	106°F.	P—96°F.
1.0	100°F.	P—95°F.

P = Precipitate of Chromium Hydroxide.

(3) *Effect of Exhaustion and Revival with Acid.*—A practical test was made by exhausting gallon quantities of the fixing bath with Eastman motion picture positive and panchromatic negative film (Type 2) using the developers D-16 and D-76, respectively, at 70°F. and 85°F. The film was processed as follows: The positive film was developed for five minutes in D-16, placed in the fixing bath *without rinsing* for five minutes, and washed twenty minutes. Ten per cent of sodium sulfate (desiccated) was added to D-16 at 85°F. in order to prevent excessive swelling of the gelatin. The negative film received similar treatment in D-76 but was developed for ten minutes and likewise fixed for ten minutes.

The method used for the determination of the acidity at each revival point will be described later. The average quantity of concentrated sulfuric acid added to the baths at each revival point was

1.2 cc. per liter or 0.15 oz. per gallon with the D-16 developer, and 1.8 cc. per liter or 0.23 oz. per gallon with D-76. One hundred cc. samples were taken after processing 50 feet of film and after revival. These were stored in stoppered bottles at 70°F. and their hardening properties determined at regular intervals.

The results of the tests are given in Figs. 2, 3, 4, 5, from which it is seen that with D-16 at 70°F. (Fig. 2) the hardening action of fixing bath No. I decreased from 212°F. to 190°F. after fixing 100 feet of positive film per gallon. On revival with acid the hardening

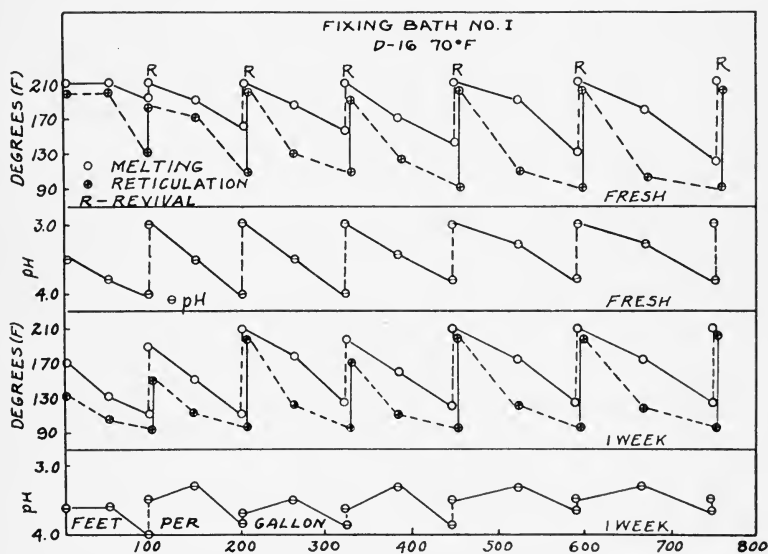

FIG. 2. Effect of exhaustion with acid revival on the hardening properties of chrome alum fixing bath No. I (D-16 developer at 70°F.).

action was restored to its original value but fell off to 160°F. after processing 200 feet per gallon. A maximum degree of hardening was again obtained after the addition of acid and again it decreased to 160°F. after processing 325 feet per gallon. The hardening properties were then restored by the addition of acid but they decreased to 150°F. on further exhaustion to 450 feet. The bath was finally exhausted to 750 feet per gallon after revival with acid at the 590 foot and 750 foot stages. A minimum degree of hardening was produced at these revival points but the hardening action increased after the addition of

acid. Except in the case of a few samples which were taken after revival, the hardening properties of practically all the samples decreased after standing one week. The low degree of hardening obtained with the samples taken before revival indicates that the revival points should be more frequent in order to maintain uniform hardening properties. A comparison between the acidity curve of the fresh bath and the one after the samples had stood one week indicates that (1) the acidity tends to reach a constant value on ageing, (2) the

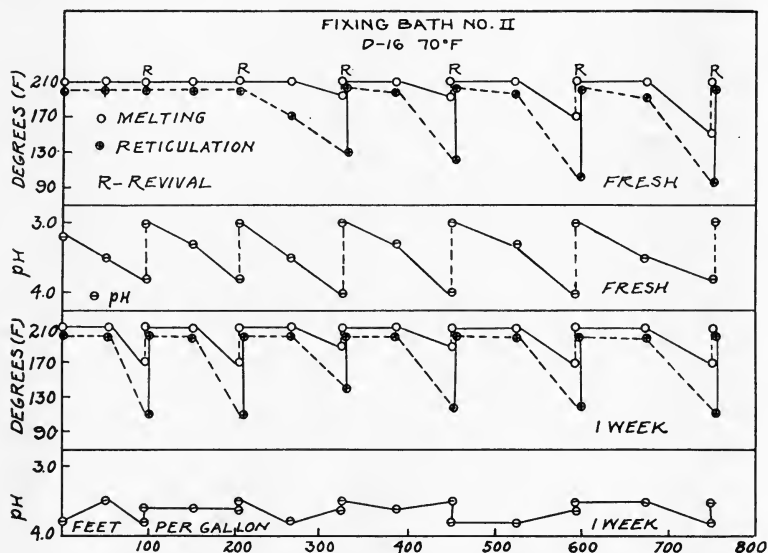

FIG. 3. Effect of exhaustion with acid revival on the hardening properties of chrome alum fixing bath No. II (D-16 developer at 70°F.).

acidity must be maintained between a pH of 3.0 and 3.8 in order to obtain satisfactory hardening properties in the fresh bath, and (3) the hardening properties after standing one week decreased even when the acidity was between these pH values.

With D-16 at 70°F. (Fig. 3) the hardening properties of fixing bath No. II were superior to those of fixing bath No. I. In the fresh bath 325 feet of film per gallon were processed with acid revival at the 100 foot and 200 foot stages before a decrease in the hardening properties occurred. The hardening properties were then restored by the addition of acid but decreased after processing 450 feet of film. The addition of acid revived the hardening action and the bath was further

exhausted to 750 feet per gallon, with acid revival after processing 590 feet and 750 feet, respectively. At these revival points the hardening properties had again decreased but were increased by the addition of acid. The film processed in the samples taken before revival and stored one week reticulated at a low temperature, which indicates that the bath should have been revived more frequently. A comparison between the acidity curve of the fresh bath and the one after storing for one week indicates that the acidity tends to come to

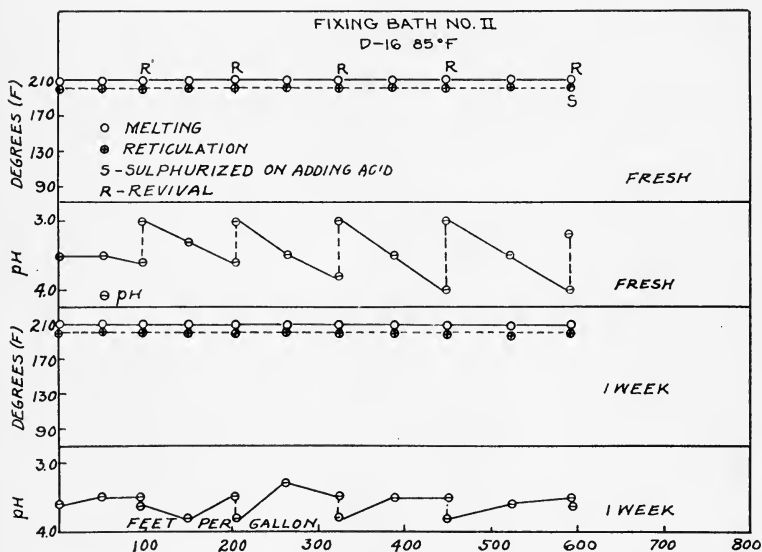

FIG. 4. Effect of exhaustion with acid revival on the hardening properties of chrome alum fixing bath No. II (D-16 developer at 85° F.).

a constant pH value and that satisfactory hardening is produced when the pH of the bath is maintained between a value of 3.0 and 3.8.

With D-16 (Fig. 4) more uniform hardening properties of the fixing bath No. II were obtained at 85°F. than at 70°F. which indicates that an increase in the temperature increases the hardening action. However, this advantage is offset by the fact that the bath tends to sulfurize more readily at 85°F. than at 70°F. The bath produced a satisfactory degree of hardening up to 600 feet per gallon, but was not exhausted beyond this point because it sulfurized on the addition of acid. No decrease in hardening properties was observed after the samples had stood one week.

With D-76 at 70°F. (Fig. 5) the hardening properties of fixing bath No. II were very similar to those of fixing bath No. I. During exhaustion with 600 feet of negative film per gallon, a low degree of hardening was obtained before each revival point but after the addition of acid, a maximum degree of hardening was produced. This indicates that more uniform hardening properties could have been maintained by the addition of acid at more frequent intervals.

From a study of the hardening properties of chrome alum fixing baths as represented in Figs. 1 to 5, it was concluded that (1) more uniform hardening properties could be maintained on exhaustion

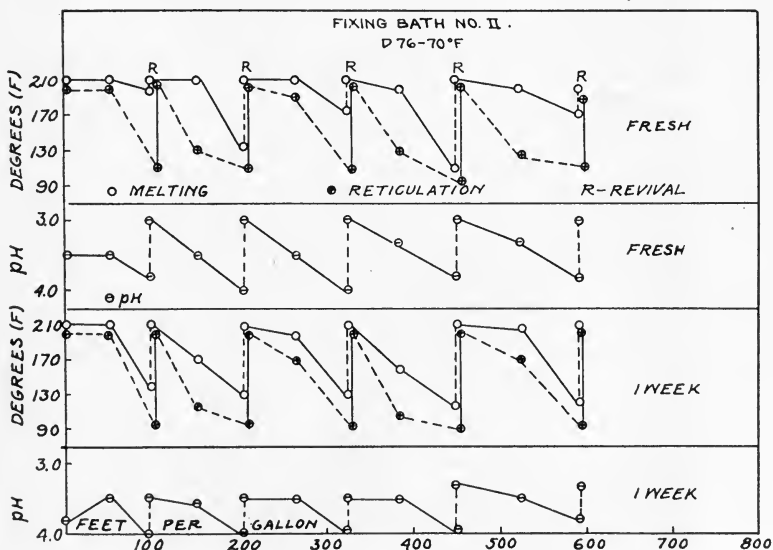

FIG. 5. Effect of exhaustion with acid revival on the hardening properties of chrome alum fixing bath No. II (D-76 developer at 70°F.).

with the No. II formula than with No. I; (2) more uniform hardening properties were maintained at 85°F. than at 70°F.; and (3) the acidity must be maintained between a pH of 3.0 and 3.8 in order to maintain satisfactory hardening properties on exhaustion.

(4) *Method of Revival with Acid.*—The quantity of acid to be added at each revival point was determined by the following method: A 25 cc. sample of the fixing bath was added to 50 cc. of distilled water containing 5 cc. of brom-phenol-blue indicator and titrated with a

2.5 per cent solution of sulfuric acid.* The acid was added slowly until the solution was just acid to the indicator. The number of cubic centimeters required multiplied by 3.8 gives the number of cubic centimeters of concentrated acid to add per gallon.

It is *absolutely essential* that the following procedure be adopted when the bath is revived with sulfuric acid in order to prevent sulfurization. The sulfuric acid should be diluted by pouring one part (by volume) of the concentrated acid into ten parts of water. Then cool to 70°F. and add slowly to the cooled fixing bath while *stirring* the latter *rapidly*. The acidity of the fixing bath should be tested before all the acid is added so as to be sure that the quantity of sulfuric acid has been determined accurately. If the bath is to be used immediately after revival enough sulfuric acid can be added to bring the acidity to a pH of 3.0; otherwise the bath should not be revived until ready for use. Although the addition of sulfuric acid to fixing baths increases their tendency to sulfurize, none of the baths in the exhaustion tests sulfurized in less than one week at 70°F.

The quantity of acid which it is necessary to add at each revival point and the number of feet of film which can be processed before revival depends upon the quantity of developer retained by the film and the alkalinity of the developer. With the apparatus used in this investigation 100 feet of motion picture positive film developed in D-16 carries into 1 gallon of fixing bath 5 per cent of D-16. One hundred feet of panchromatic negative film developed in D-76 transfers 6.5 per cent of D-76 per gallon of fixing bath. The results of the exhaustion tests indicate that with positive film developed in D-16 developer, and *without rinsing*, the fixing bath should be revived every 75 feet per gallon, and with negative film developed in D-76 developer the bath should be revived every 50 feet per gallon if uniform hardening properties are to be obtained. An increase in the number of feet of film per gallon which can be processed before revival is necessary can be obtained by rinsing the film in water after development.

(5) *Revival of Hardening Properties by Addition of Chrome Alum.*—Preliminary experiments were made to determine the effect of adding further quantities of chrome alum to fixing bath No. I which had been exhausted with respect to its hardening properties. The addition of

* The acid solution contained 2.5 cc. of pure concentrated sulfuric acid per 100 cc. of solution. This concentration was chosen so that 1 cc. per 25 cc. of fixing bath would be equal to 1 cc. of concentrated acid per liter.

1.0 per cent chrome alum had little effect on the hardening properties but on the addition of sulfuric acid the hardening properties increased. Hence it was concluded that this procedure was no more economical than to compound a bath containing more chrome alum in the first place and to revive it with sulfuric acid. Furthermore, concentrated solutions of chrome alum tend to stain the film green, especially at high temperatures, which necessitates that the concentration be kept as low as possible. An attempt was also made to increase the hardening life of the chrome alum fixing bath No. I by buffering with 10 per cent sodium sulfate (desiccated). This required the addition of 1.0 cc. of concentrated sulfuric acid per liter in order to adjust the acidity to that of the original bath. The hardening life was prolonged but the time to clear negative film was also increased, which was undesirable.

(6) *Sludging Life*.—Two types of sludges are apt to form in a chrome alum fixing bath, namely, sulfur and chromium hydroxide. Chrome alum fixing baths containing sulfuric acid sulfurize readily and should, therefore, be exhausted as soon as possible after mixing.

A sludge of chromium hydroxide tends to form on the addition of developer and the quantity which forms depends on (a) the alkalinity of the developer and the quantity carried into the bath, (b) the degree of rinsing before fixing, and (c) the time and temperature of storage.

This sludge may form either on the film or in the bath but is generally precipitated first on the film. The formation of this precipitate is also retarded by reviving the bath with acid at intervals.

Practical sludging tests were made by adding increasing quantities of D-16, D-76, sodium sulfite, and sodium carbonate to samples of fixing bath No. I and storing at 70°F. and 110°F. The results are shown in Table V from which it is seen that the sulfurization life is approximately one day at 110°F., but this is raised to five days on the addition of 5 per cent of D-16.

The sulfurization and sludging life of the chrome alum fixing bath No. II were similar to those given above for the No. I fixing bath.

During the active hardening lives of the baths either with or without revival no sludges should be encountered in practice.

(7) *Time of Fixation*.—Experiments indicated that the fixation capacity of the chrome alum fixing baths above is of the same order as that of a potassium alum bath containing an equal hypo concentration, data for which have been given in a previous paper.¹

TABLE V

Sludging Life of Fixing Bath No. I with Addition of Developer, Sodium Sulfite, and Sodium Carbonate

Material Added per 100 Cc. Fixing Solution	Stored at 70°F.		Stored at 110°F.	
	Hydroxide	Sulfur	Hydroxide	Sulfur
40 cc. D-16	2 days	40 hrs.
25 cc. D-16	30 days	2 days
20 cc. D-16	2 days
10 cc. D-16	2-4 days
5 cc. D-16	5 days
0 cc. D-16	10 days	1 day
8 cc. D-76	5 days
10 cc. D-76	5 days
12 cc. D-76	5 days
15 cc. D-76
0.5 gram sodium sulfite	5 days
1.0 gram sodium sulfite	4 days
2.5 gram sodium sulfite
5.0 gram sodium sulfite	7 days
0.01 gram sodium carbonate	8 days	3 days
0.05 gram sodium carbonate	30 days	5 days
0.1 gram sodium carbonate	40 days	20 hrs.
0.5 gram sodium carbonate	1 day	3 hrs.
2.5 gram sodium carbonate	30 min.	30 min.

(8) *Effect of Time of Bathing and Temperature of Bath on Hardening Properties.*—The effect of time of fixation and temperature on the hardening produced with motion picture positive film developed in D-16 and fixed in the fresh chrome alum fixing bath No. I, is shown in Table VI, from which it is seen that at temperatures ranging from

TABLE VI

Effect of the Time of Fixing and Temperature on the Hardening of Motion Picture Positive Film

Temperature of Fixing Bath	Time of Fixing	Melting Points
50°F.	5 min.	140°F.
50°F.	15 min.	200°F.
65°F.	5 min.	168°F.
65°F.	15 min.	212°F.
75°F.	5 min.	202°F.
75°F.	15 min.	212°F.
90°F.	5 min.	206°F.
90°F.	15 min.	212°F.

50°F. to 65°F. a fixation time of fifteen minutes is necessary to produce maximum hardening, while at 75°F. to 90°F. maximum hardening is produced in five minutes.

A similar study made with Eastman panchromatic negative motion picture film developed in D-76 and treated in fixing bath No. II indicated that the minimum time in which negative film could be hardened satisfactorily was five minutes at temperatures above 65°F., but at lower temperatures a longer time was required.

(9) *When to Discard the Bath.*—A fixing bath is usually discarded for one or more of the several following reasons: (a) it sludges, (b) it does not harden satisfactorily, (c) the time of fixation is excessive, or (d) it is muddy or stains the film.

At normal temperatures with D-16 and D-76 and suitable revival, the hardening properties are maintained up to the point when the time for fixation with positive and negative film is doubled, at which point the bath is usually discarded. The rate of fixation may be maintained by discarding a portion of the bath and adding a concentrated hypo solution at intervals, but experiments have shown that this procedure is no more economical than to discard the bath more frequently.

With the chrome alum fixing bath No. II the exhaustion can be carried to the point at which the fixing power of the hypo is exhausted, if the bath is suitably revived with acid.

(10) *Fixing Bath Troubles.*—Troubles with chrome alum fixing baths are roughly of the same nature as those encountered with potassium alum baths as outlined previously.¹ Only those peculiar to chrome alum baths will be discussed.

(a) *Sludging.*—A yellowish white sludge consists of sulfur while a greenish gelatinous precipitate consists of chromium hydroxide. The former is a result of the presence of too much acid in the bath or of storing at too high a temperature. The green sludge is caused by the presence of too much developer in the fixing bath and may be prevented either by rinsing in water before fixing, by the use of an acid stop bath before fixing, or by revival of the bath with acid as recommended. With the chrome alum fixing baths I and II, however, the hardening properties are exhausted long before a green sludge is obtained, so that in actual practice this sludge should not be encountered.

If a sludge or scum of chromium hydroxide deposits on the film

even when observing the above precautions, this may be prevented largely by thorough agitation when the film is first immersed in the fixing bath.

(b) *Stains*.—Stains similar to those outlined in Part I under "Stop Bath Troubles" are likewise apt to be produced with chrome alum fixing baths, especially when fixing in baths containing a high concentration of chrome alum at high temperatures. The remedy is to use a bath containing a lower concentration of chrome alum and to renew this more frequently.

DISCUSSION OF THE HARDENING PROPERTIES OF CHROME ALUM IN VARIOUS BATHS

The anomalous hardening properties of chrome alum solutions may be summarized as follows:

1. The addition of an alkali, sodium bisulfite, or developer to a plain chrome alum solution causes a decrease in the hardening properties and acidity of the bath and a change of color from purple to green.

2. The addition of borate, acetate, citrate, and other organic acid radicles causes a decrease in hardening properties similar to that by the above salts, but does not give a corresponding change in color. The presence of 5 per cent sodium acetate in a chrome alum bath changes the color to a deep purple which is similar to the color of a chromic acetate solution.

3. Successful revival of the hardening properties of exhausted baths is possible with sulfuric acid, the life of the bath after revival depending upon the amount of developer already in the bath.

4. A maximum degree of hardening results when the solution in contact with the gelatin film has a definite basicity or alkalinity resulting after the acid in the fixing bath has neutralized the alkali in the developer that is retained by the film. Since the acidity of a fixing bath or stop bath changes with use, its hardening properties change also.

5. The acidity of a plain chrome alum solution must be maintained within certain limits before a maximum degree of hardening can be obtained. For the hardening of neutral or well washed film, the acidity range lies between a pH of 3.8 to 4.0 and for alkaline film (as defined in Part I) between a pH of 3.0 and 3.8. Since the acidity of 2 per cent and 3 per cent chrome alum solutions is about 3.2, these solutions do not harden neutral gelatin.

6. The hardening life of chrome alum fixing baths can be prolonged

by the addition of sulfuric acid at intervals or by increasing the concentration of chrome alum. The addition of too much acid is apt to cause blistering and sulfurization and too much chrome alum increases the tendency of the bath to stain the film.

Since the addition of sodium sulfite to a chrome alum solution causes it to turn from a purple to a deep green color and also produces a decrease in hardening properties, an attempt was made to restore the hardening properties of such chrome alum solutions by treatment with various oxidizing agents such as potassium perchlorate, iodine, potassium persulfate, nitric acid, and potassium permanganate. The hardening was not revived and the original color was only obtained in solutions that were distinctly acid. The color change was therefore not due to a reduction process as might be expected in the presence of sodium sulfite.

By the addition of oxidizing agents together with sulfuric acid to an exhausted stop bath, it is possible to prolong the hardening life to a greater extent than when sulfuric acid is added alone, owing to the oxidation of the sodium sulfite. If the sodium sulfite in an exhausted bath is oxidized with sodium dichromate and sulfuric acid, the concentration of the chromium ion is increased and the hardening life is thereby prolonged. However, in the case of a bath exhausted with film developed in D-76 to 700 feet per gallon and revived with enough sodium dichromate to react with all of the sodium sulfite, the chrome alum content would be increased by 6 per cent. This is undesirable because a high concentration of chrome alum tends to stain the film green. The addition of oxidizing agents to exhausted chrome alum fixing baths is also undesirable, because a certain proportion of the hypo is thereby oxidized and its fixing properties destroyed.

Since potassium nitrite catalyzes the conversion of green chrome alum to the violet modification⁸ and oxidizes sodium sulfite, various exhausted chrome alum hardening baths containing 2 per cent sodium nitrite were tested for an increase in hardening properties. The color and hardening was only revived in baths whose acidity was adjusted between a pH of 4.0 and 3.0. The hardening of exhausted baths to which sulfuric acid alone had been added was increased, but the addition of nitrite greatly hastened the reaction. From the results obtained potassium nitrite was thought to be a suitable material for preventing the rapid decrease in hardening properties of chrome alum solutions but practical tests showed that the propensity of the

bath to blister was also greatly increased and the odor of the gas evolved was very objectionable.

Two types of chromium salts are known which although of similar chemical composition differ widely in their chemical properties. Recoura⁴ and other workers have investigated the properties of the two types of chromium salts (violet and green) and it has been shown that boiling a solution of the violet modification of chrome alum converts it to the green modification which on standing slowly changes back to the violet one.

Tests were made to determine whether it was possible to obtain suitable hardening with the green modification of chrome alum. Samples of violet chrome alum were boiled for two hours, then cooled, and the hardening compared with that of the original violet solution as follows. Test strips were developed in D-16 for five minutes, treated in the chrome alum solution for three minutes, bathed in a 30 per cent solution of hypo for five minutes, washed twenty minutes, and the melting points determined. The results are given in Table VII.

TABLE VII

Effect of Boiling on Hardening Properties of a Chrome Alum Solution

% Chrome Alum	Melting Points		
	Fresh	Boiled 2 Hours	After Boiling and Adjusting Acidity to pH 3.2
0.2	120°F.	110°F.	170°F.
0.4	>212°F.	110°F.	>212°F.
0.8	>212°F.	110°F.	>212°F.
1.6	>212°F.	110°F.	>212°F.
3.0	>212°F.	110°F.	>212°F.
4.0	>212°F.	110°F.	>212°F.

From the above table it is seen that the hardening properties of chrome alum solutions towards alkaline gelatin are almost completely destroyed on boiling. A determination of the acidity of these solutions after boiling showed that it had increased to a pH of 2.0 which accounts for the low degree of hardening produced. After adjusting the acidity to a pH of 3.2 by adding alkali, the hardening properties were restored, although the green color still remained. This is not conclusive evidence that the green modification hardens because there is always a gradual change from the green to the violet taking place

and the hardening produced by the green modification may have been due to the presence of a small quantity of violet salt which formed during cooling after boiling.

This change from violet to green, according to Vallance and Eldridge,³ is accompanied by an increase in acidity and is apparently due to hydrolysis together with a change in structure, probably as follows:



This conclusion is based upon considerations of cryoscopic and conductivity measurements, a study of absorption spectra, and upon observations regarding precipitation with barium chloride in aqueous solutions.

When in solution, chrome alum hydrolyzes forming basic salts which polymerize on heating and more slowly at ordinary temperature on standing. Such a reaction may be represented by the following equation:



where

$$a + b = y$$

from which it may be concluded that the hardening effect of chrome alum is probably a result of the precipitation of chromium hydroxide in the gelatin or at least of a reaction between the basic salt and the gelatin so that it is to be expected that the repression of the hydrolysis such as by the addition of sulfuric acid would diminish the hardening towards neutral gelatin while an increase in the degree of hydrolysis by a reduction of the acidity would increase the hardening.

From a study of hardening and pH curves during the practical exhaustion tests, it is seen that the acidity and hardening produced changes with the age of the baths. The acidity of the fresh solutions, which are alkaline to brom-phenol-blue, increases, whereas the acidity of the solutions which are acid to the indicator decreases. This can be accounted for by the hydrolysis equation since increasing quantities of developer lower the acidity, causing more hydrolysis to take place, which in turn causes a decrease in the number of chromic ions, and also a decrease in the hardening properties. The addition of acid causes the opposite reactions to take place. This indicates that the hardening action of chrome alum solutions is due to the presence of chromic ions and that conditions favoring their formation

such as the addition of acid, the addition of chrome alum, and the oxidation of the sulfite, would increase the hardening action.

Although the addition of sodium sulfite to a chrome alum solution reduces the acidity and therefore tends to increase hydrolysis, a secondary reaction undoubtedly takes place and apparently a compound is formed which does not tend to dissociate. This would explain the fact that in the presence of an excess of sodium sulfite a chrome alum fixing bath has a minimum tendency to sludge on the addition of developer. The extent of the reaction with sodium sulfite apparently increases with age since the hardening properties of some fixing baths or a used chrome alum stop bath fall off with time especially with baths containing a low concentration of chrome alum. With a high concentration of alum, the rate of decrease in hardening is slower but it is necessary to have a minimum concentration of 2 per cent to insure reasonably good keeping properties.

Since the formation of basic chromium salts or chromium hydroxide is necessary for the hardening of gelatin, solutions of chrome alum containing a relatively high concentration of sodium acetate would not be expected to harden film because the formation of basic chromium salts is prevented in the presence of acetates. This explains why organic acids such as acetic, citric, and tartaric cannot be used as acidifiers in chrome alum solutions.

PERMANENCE OF HARDENING PRODUCED BY ALUMS

As indicated in the experimental procedure, the degree of "hardening" as expressed by melting point determinations is merely relative and the results should not be considered as being directly applicable to darkroom practice. For instance, if the melting point or relative hardening is indicated as 150°F. or more, this does not mean that the film hardened in the manner indicated could be washed indefinitely at that temperature without affecting the emulsion. The following experiments were made to determine the relative permanence of the hardening produced by chrome alum in relation to the experimentally determined hardening value.

Strips of film were fixed in hardening fixing baths which produced varying degrees of hardening and the melting points were determined in the usual manner. Duplicate strips of each of the films were washed at varying temperatures and the time noted for the film to become soft or swollen to such an extent that it was unsatisfactory for practical purposes. The results are given in Table VIII.

TABLE VIII

Effect of Prolonged Washing at Various Temperatures on Film Hardened by Different Hardening Agents

Temperature and Duration of Washing	Condition of Gelatin or M. P.* °F. after Test			
	Film No. 1	Film No. 2	Film No. 3	Film No. 4
48 hrs. at 60°F.	108°F.	170°F.	95°F.	212°F.
48 hrs. at 70°F.	104°F.	150°F.	Slight swelling -95°F.	212°F.
24 hrs. at 75°F.	110°F.	165°F.	Slight swelling -95°F.	212°F.
24 hrs. at 80°F.	Soft after 1 ¹ / ₄ hrs. -95°F.	Soft after 5 hrs. -170°F.	Soft—reticulated 15 min.	212°F.
24 hrs. at 90°F.	Reticulated 8 min.	Reticulated 30 min.	Reticulated 2 min.	212°F.
24 hrs. at 100°F.	Reticulated 2 min.	Reticulated 5 min.		212°F.
24 hrs. at 150°F.				212°F.
Initial hardness determined in usual way	135°F.	180°F.	95°F.	212°F.

* M. P.—Melting Point.

Film No. 1 Film hardened in potassium alum hardening fixing bath.

Film No. 2 Film hardened in potassium alum hardening fixing bath.

Film No. 3 Unhardened.

Film No. 4 Hardened in fresh chrome alum fixing bath.

From these results it is seen that chrome alum produces a more rugged type of hardening than aluminum alum. Also, chrome alum hardening is more stable than potassium alum hardening with respect to the action of acids and alkalis. Strips of film were hardened in each of the two types of fixing baths, washed for five minutes in running water, and then placed in solutions of varying concentrations of sodium hydroxide for five minutes. It was found that the hardening produced by both chrome alum and potassium alum is readily destroyed by alkali but the hardening produced by chrome alum is more resistant to the action of acetic acid and sodium hydroxide than that produced by potassium alum.

THE RELATIVE MERITS OF CHROME ALUM AND POTASSIUM ALUM STOP BATHS AND FIXING BATHS

A choice between the use of potassium alum and chrome alum in fixing baths for motion picture work depends upon the particular requirements involved. Usually excessive hardening of motion pic-

ture film is unnecessary, although a moderate degree of hardening is desirable so that in a relatively damp atmosphere the gelatin will not become excessively tacky and tend to produce an accumulation of gelatin on the pressure springs in the projector gate.

If the processing conditions are such that the wash water is warm or if rapid drying at high temperatures is necessary, then a degree of hardening greater than that which is usually attainable in potassium alum baths is necessary. For processing under tropical conditions the use of chrome alum baths is imperative.

(1) The question of a choice between a chrome alum stop bath or fixing bath at high temperature is largely determined by the available space. The use of a chrome alum stop bath, with or without the addition of sodium sulfate, followed by a potassium alum fixing bath is very desirable because a chrome alum fixing bath may lose its hardening properties before the fixing power of the hypo is exhausted. A chrome alum stop bath being much less expensive can be renewed more frequently. The alternative is to use a chrome alum fixing bath containing a relatively large proportion of chrome alum.

(2) The question of the desirability of using a potassium alum or chrome alum fixing bath for processing motion picture film at normal temperatures may be decided by a study of the following comparison of their properties.

(a) Chrome alum either tends to harden the gelatin so that it does not melt in boiling water, or it does not harden the gelatin at all. In some cases chrome alum merely hardens the upper layers of the gelatin coating leaving the lower substrata unhardened and in this condition the film is susceptible to reticulation. Potassium alum fixing baths produce a medium degree of hardening so that the gelatin usually melts at a temperature around 120°F. to 180°F.

(b) The hardening action of potassium alum baths does not fall off with age as is the case with many chrome alum baths and the former respond more readily and consistently to revival with acid. Fig. 6 shows the effect of reviving the F-2 potassium alum fixing bath at intervals with acid, and it is seen that the hardening varies largely between the limits of 120°F. to 180°F., the hardening of the final bath being of the same order as that of a fresh bath. The hardening properties of the potassium alum fixing bath F-2 (Fig. 6) cannot be compared directly with the hardening properties of chrome alum fixing baths on exhaustion since they were not exhausted under comparable conditions. In the case of the F-2 bath the exhaustion was

made with motion picture positive and negative film developed in D-16 and D-76 which was rinsed before placing in the fixing bath, while in the case of the chrome alum fixing bath the film was not rinsed before immersing in the fixing bath. The effect of the addition of D-16 developer to the potassium alum fixing baths F-1 and F-2 and the chrome alum fixing baths No. I and No. II is shown in Fig. 7. The procedure for the hardening tests was similar to that given on page 675. The addition of developer to a fixing bath corresponds to an exhaustion without acid revival with unrinsed film and with motion picture positive film developed in D-16. Five per cent of D-16 is equivalent to processing 100 feet per gallon.

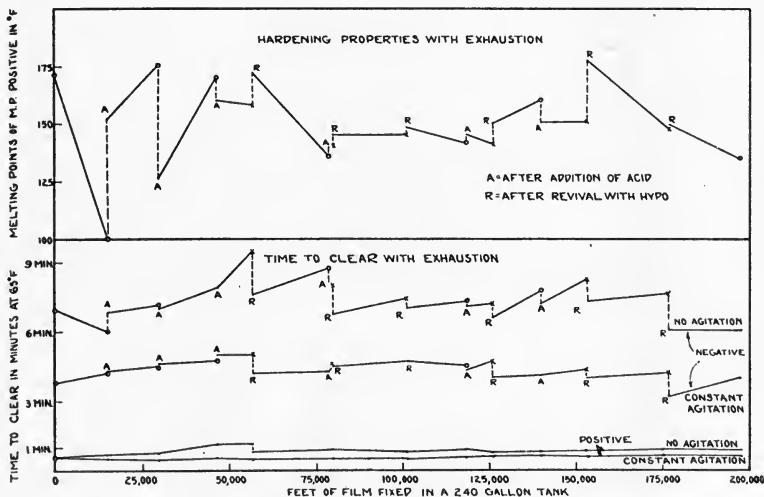

FIG. 6. Effect of exhaustion on the hardening properties and clearing time of potassium alum fixing bath F-2. Bath was revived at intervals with acetic acid and hypo.

With the potassium alum baths (Curves A and B) the hardening action increased as the quantity of developer increased, until 10 per cent of D-16 was added which caused an immediate precipitation. After standing for one day, both baths containing 7.5 per cent of D-16 sludged, which indicates that the life of the fresh bath is slightly less than 150 feet of film per gallon.

With the fresh chrome alum baths (Curves C and D) the hardening properties of No. I fell off rapidly after the addition of 7.5 per cent of D-16, while the hardening action of No. II did not decrease until

10 per cent of D-16 was added. Fixing bath No. I containing 10 per cent and 15 per cent developer sludged after storing one week at 70°F. and the life after storing two weeks decreased to about 4.5 per cent of D-16 or 75 feet per gallon, while with No. II only the bath containing 15 per cent developer sludged and the hardening life was decreased to 7.5 per cent of D-16 or 150 feet per gallon.

A comparison between the hardening properties of these baths indicates that (1) with the fresh chrome alum fixing bath No. II a

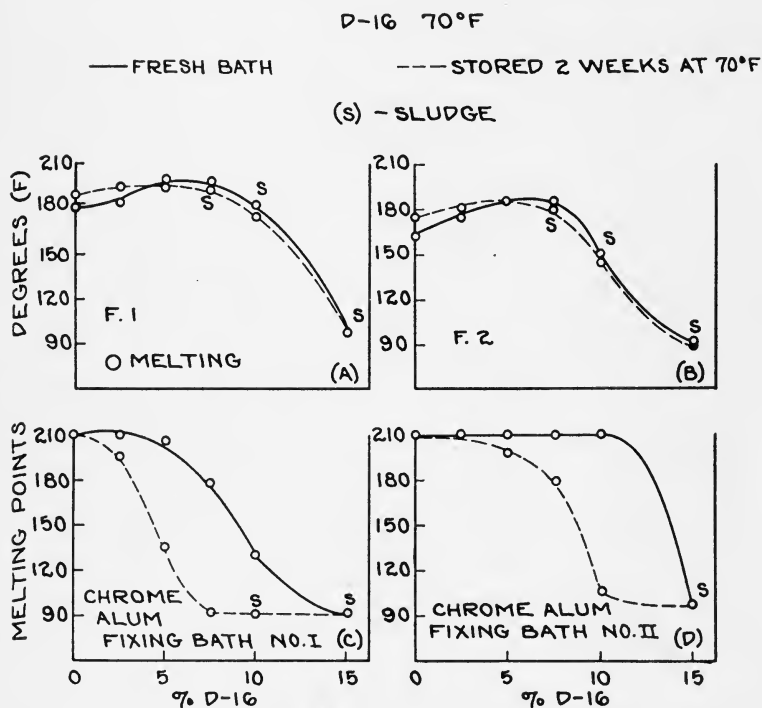

FIG. 7. Effect of the addition of D-16 developer on the hardening properties of the potassium alum fixing baths F-1 and F-2 and the chrome alum fixing baths Nos. I and II.

greater quantity of D-16 developer can be added before a loss in hardening properties occurs or before a sludge is precipitated than with the other baths, (2) after storing two weeks at 70°F. the developer life of the chrome alum fixing bath No. II is similar to that of the fresh potassium alum bath, (3) the hardening properties of a potassium alum bath change very little with age, (4) the hardening properties of

the chrome alum fixing bath No. I are inferior to those of No. II, and (5) the maximum degree of hardening which can be obtained on the addition of developer with potassium alum baths occurs just before the baths sludge, while with chrome alum fixing baths the hardening properties are destroyed long before the baths sludge.

(c) Although the developer capacity of some chrome alum fixing baths or the quantity of developer which can be added before sludging occurs is greater than with potassium alum baths, this advantage is offset by the fact that on revival of a chrome alum bath with sulfuric acid it is more apt to sulfurize than when adding acetic acid to potassium alum baths in the absence of adequate stirring.

(d) Both types of baths tend to deposit a scum on the film consisting of a basic aluminum or chromium sulfite, in the absence of agitation when using excessively alkaline developers. The aluminum scum is readily soluble in a weak solution of sodium carbonate but once the film is dried, the chromium scum is very difficult to remove.

(e) Film which is fixed in a fresh potassium alum bath tends to appear slightly opalescent after washing, but the opalescence disappears on drying. This opalescence does not appear with chrome alum baths at normal temperatures but this feature is of little importance in motion picture work.

SUMMARY

Owing to the fact that chrome alum either when used in a stop bath or when compounded in a suitable fixing bath is capable of hardening gelatin to an extent such that it will not melt or reticulate in boiling water, it is recommended for use with motion picture film when developing at high temperatures or whenever excessive hardening of the film is desired.⁵

Two varieties of chrome alum exist, namely, a violet and a green modification. It is probable that the latter is incapable of hardening gelatin. A change to the green variety occurs if the violet solution is boiled or if sodium bisulfite or an acid solution of sodium sulfite is added and the solution allowed to stand. In turn, the green variety is more or less changed back to the violet in the presence of sodium nitrite or an excess of sulfuric acid.

The difficulty involved in the use of chrome alum solutions is to maintain a constant degree of hardening since the hardening produced is influenced by a variety of factors as follows:

(a) Maximum hardening results when the solution in contact with

the gelatin film has a definite basicity or alkalinity resulting after the acid in the fixing bath has neutralized the alkali in the developer retained by the film.

(b) Since all developers contain sodium sulfite and an alkali, the acidity and the hardening properties decrease with the addition of developer. The color of a plain chrome alum solution also changes from violet to green on the addition of developer or on boiling, but this has little effect on the hardening properties if the acidity of the solution is maintained between certain limits.

(c) Since most fresh fixing baths contain sodium sulfite their hardening properties fall off even without use at a rate depending on the particular formula used. Usually a high concentration of chrome alum insures a longer life and although the presence of an excess of acid or the addition of sodium nitrite tends to maintain the hardening properties, blisters are apt to form as a result of the excessive acidity or the liberation of nitric oxide from the nitrite.

(d) More uniform hardening properties can be maintained by processing at 85°F. than at 70°F. but this advantage is offset by the fact that the gelatin film tends to blister and to swell excessively at this temperature.

When developer is added to a chrome alum stop bath or fixing bath, the immediate cause for a drop in the hardening is a change in the alkalinity of the bath but the hardening properties can usually be restored immediately by reacidifying. With chrome alum stop baths containing developer a maximum degree of hardening is obtained with alkaline film (as defined in Part I) when the acidity of the bath is maintained between a pH of 3.0 and 3.8 and with neutral film between a pH of 3.8 and 4.0. With chrome alum fixing baths the alkalinity of the film has very little effect on the hardening action but the acidity of the bath must be maintained between a pH of 3.0 and 3.8 in order to obtain a maximum degree of hardening. The effect of sulfite in destroying the hardening properties is not thoroughly understood but this is probably due partly to the formation of a chromium complex which has no hardening effect on gelatin, and partly to the buffering action of sulfurous acid on the acidity of the baths.

Compared with potassium alum fixing baths, chrome alum baths do not sludge as readily but for normal temperature work potassium alum baths are equally satisfactory for use with motion picture film because they do not harden excessively and if revived at intervals with acid no sludging occurs.

PRACTICAL RECOMMENDATIONS

A Suitable Chrome Alum Fixing Bath.—The following formula (F-23) is recommended for processing motion picture film.

Solution A

	Metric	Avoirdupois
Hypo*	240 grams	100 lbs.
Sodium sulfite (desiccated)	12.5 grams	5 lbs. 4 oz.
Water to make	750 cc.	38 gallons

Solution B

	Metric	Avoirdupois
Water	150 cc.	9 gallons
Sodium sulfite (desiccated)	5 grams	2 lbs. 1 oz.
Sulfuric acid 5%**	40 cc.	2 gallons
Potassium chrome alum	32 grams	13 lbs. 4 oz.
Water to make	250 cc.	12 gallons

* A bath which fixes more rapidly may be obtained by increasing the hypo concentration in the above formula to $2\frac{1}{2}$ lbs. per gallon (300 grams per liter).

** To prepare 5 per cent sulfuric acid add one part by volume of concentrated sulfuric acid to 19 parts by volume of cold water and mix carefully with stirring. The acid must be added to the water, otherwise an explosion is liable to occur.

Dissolve the constituents of solution *A* and cool to 70°F . Then mix solution *B* by adding the chemicals in the order given and cool to 70°F . Then add solution *B* to solution *A* while stirring the latter thoroughly.

If the solutions are mixed in a deep tank and the hypo bath is not adequately stirred, the chrome alum solution will tend to float on top of the hypo solution and sulfurization is apt to occur. A churn type of stirring paddle is recommended. Solutions *A* and *B* must be cool when mixed, otherwise the bath will sulfurize.

It is not desirable to store the solution *B* as a stock hardener because it would lose its hardening properties on keeping.

Life of the Bath.

a. Sulfurization Life.—The sulfurization life of the bath without use is about two weeks when stored at 70°F ., and at higher temperatures is considerably less. However, as soon as developer is added, the sulfurization life is greatly increased, by virtue of the decrease in acidity and the addition of sodium sulfite.

b. Sludging Life.—The addition of 10 per cent of D-16 developer causes a sludge of chromium hydroxide to form in the bath after storing at 110°F . for four days, while 15 per cent of D-16 is required to sludge the bath in one week at 70°F . No sludges were obtained at 70°F . or 110°F . with the D-76 developer.

c. Hardening Life.—The limiting quantities of *unrinsed* film which

it is desirable to process in the above bath at 70°F. and 85°F. are given in Table IX.

TABLE IX
Hardening Life of Fixing Bath with and without Revival with Acid

Nature of Film	Temperature of Solutions	Developer	Hardening Life of Bath with Revival	Without Revival
M. P. Pos.	70°F.	D-16	600 ft. per gal.	200 ft.
M. P. Pan. Neg.	70°F.	D-76	300 ft. per gal.	125 ft.
M. P. Pos.	85°F.	D-16	600 ft. per gal.	200 ft.
M. P. Pan. Neg.	85°F.	D-76	300 ft. per gal.	125 ft.

If the film is rinsed before fixing or if a less alkaline developer is used the life of the bath without revival is increased and a greater quantity of film can be processed before it is necessary to revive with acid.

Revival of Bath.—With use, the hardening properties fall off rapidly as the acid is neutralized by the alkali in the developer carried over by the film. For example, when developing motion picture film with D-16 the melting point of the film drops from 212°F. to 110°F. after processing 300 feet per gallon. The hardening properties should be revived by the addition of dilute sulfuric acid after each 50 feet of film have been processed per gallon in the case of *unrinsed* motion picture negative film developed in the D-76 formula, and every 75 feet per gallon with *unrinsed* positive film developed in the D-16 formula.

In order to determine the correct quantity of acid necessary to revive the bath, about 25 cc. or one ounce should be titrated with a 2.5 per cent solution of sulfuric acid, using brom-phenol-blue as the indicator, and sufficient acid added until the color changes to yellow, thereby restoring the acidity to a pH of 3.0. The quantity of acid necessary to revive the bath proper can then be calculated. The concentrated acid should first be diluted by pouring one part by volume into ten parts of water. Then cool to 70°F. and add slowly to the cool fixing bath while stirring the latter rapidly.

The acidity of the bath should be checked at frequent intervals in order to be certain that the pH never becomes greater than 4.0, if uniform hardening properties are desired and if sludges are to be avoided.

Since chrome alum baths tend to sulfurize readily, they should be exhausted as soon after mixing and reviving as possible. If the bath

is to be used intermittently, it should not be revived until ready for use.

With regard to the relative merits of chrome alum as against potassium alum fixing baths, if revival of a potassium alum bath is possible it is to be preferred. If revival with acid is not possible a chrome alum bath has a longer hardening life and has a much less tendency to deposit a sludge with use. Chrome alum baths are particularly suitable for high temperature work because of their powerful tanning action.

ACKNOWLEDGMENT

The authors wish to acknowledge their indebtedness to H. A. Hartt, J. F. Ross, T. Gaski, L. E. Muehler, and F. B. Stratton who assisted in the experimental work.

REFERENCES

- ¹ CRABTREE, J. I., AND HARTT, H. A.: "Some Properties of Fixing Baths," *Trans. Soc. Mot. Pict. Eng.*, **XIII** (1929), No. 38, p. 364.
- ² CRABTREE, J. I.: "High Temperature Development of Roll Film, Film Packs, Plates, and Paper," *B. J. Phot.*, **LXIV** (1917), p. 555.
- ³ VALLANCE AND ELDRIDGE: "Text Book of Inorganic Chemistry," **VII**, Part III, *Lippincott*, Philadelphia, Pa. (1926), p. 78.
- ⁴ RECOURA, A.: "Chromosulfochromic Acids," *Bull. Soc. Chim. de France*, **III**, 16 (1896), p. 934.
- ⁵ CRABTREE, J. I.: "Development of Motion Picture Film at High Temperatures," *Trans. Soc. Mot. Pict. Eng.* (1924), No. 19, p. 39.

ABSTRACTS

The Editorial Office will welcome contributions of abstracts and book reviews from members and subscribers. Contributors to this section are urged to give correct and complete details regarding the reference. Items which should be included in abstracts are:

Title of article

Name of author as it appears on the article

Name of periodical and volume number

Date and number of issue

Page on which the reference is to be found

In book reviews, the following data should be given:

Title of book

Name of author as it appears on the title page

Name of publishing company

Date of publication

Edition

Number of pages and number of illustrations

The customary practice of initialing abstracts and reviews will be followed. Contributors to this issue are as follows: G. L. Chanier, Paul E. Sabine, and the Monthly Abstract Bulletin of the Kodak Research Laboratories.

A Method for Estimating Audible Frequencies. W. A. MARRISON. *Projection Eng.*, March, 1930, p. 14. The author indicates a method which permits one to estimate by ear frequencies in the range from approximately 50 to 4000 cycles. If one is not able to recognize a certain pitch without auxiliary means, one should first adopt an approximate standard. The lowest notes one can sing or whistle may be used as such a standard and can usually be relied upon to within 10 per cent. The next step is to learn to recognize musical intervals. The frequency ratios corresponding to the musical intervals are given and the author explains how to use them to find the frequency of any tone in comparison with another of which the frequency is known. A table of equally tempered scale based on $A_3 = 435$ is given, as well as the Lissajous figures corresponding to frequency ratios for five different phase angles. The musical intervals are indicated beside the corresponding Lissajous figures. G. L. C.

Sound Theater as an Acoustic Laboratory. J. S. PARKINSON. *Ex. Herald World*, 97, Section 2, Dec. 21, 1929, p. 38. This is an analysis of acoustical problems in the motion picture theater. Reproduced sound of the human voice presents a different problem from directly spoken sound. A horn is directional, whereas the average speaker's voice is only slightly so. External sound waves are also collected to produce so-called "feed-back" effects with horns. Reverberation in the general sense is defined as the length of time a sound requires to decay to inaudibility. In the author's opinion, there is a universal tendency in theaters

to keep the sound level too high with a resulting over-lap in the sound successions which is unpleasant. In other words, there is an upper limit of reverberation time. A balance must be found between loudness and reverberation for each theater. A summary is presented of Knudson's work on the quality of articulation in auditoriums and his method of testing is described. The ideal decay curve of sound heard in an auditorium should be comparatively smooth, whereas most rooms have some flat walls and pockets which cause sharp breaks in this curve. More attention should be paid in the future to naturalness and quality of sound rather than to intelligibility alone.—*Kodak Abstr. Bull.*

Glance at Cinema Inventions. *Bioscope (Mod. Cinema Technique)*, 81, Dec. 18, 1929, p. 1. Of patents issued in 1928 and 1929, 52 are concerned with color, 57 with synchronism, 21 with stereoscopy, 8 with continuous motion, 10 with mechanisms to avoid fire, 9 with filming apparatus, 5 are mechanisms for preparing films, 30 are for perfecting projection, and 23 are sundry inventions in the technical and photographic field. There is a notable increase in stereoscopic patents as compared with a similar review in 1918 to 1919. Continuous motion and anti-fire devices are about the same in number, while there is a striking decrease in inventions for perfecting material for film manufacture, filming, projection and similar devices.—*Kodak Abstr. Bull.*

Vibration Plus Amplification in Acoustical Treatment. D. FOX. *Ex. Herald World*, 97, Section 2, Dec. 21, 1929, p. 31. Sound motion pictures have greatly stimulated research on acoustical problems. Q. Q. Sabine of Harvard was the first to make a series of actual measurements of several theaters and halls. According to a recent estimate made on the acoustic properties of the motion picture theaters of the United States, 80 per cent have faulty acoustics. E. Berliner, in studying these problems, applied the basic principles of vibrating diaphragms. He found that agitation of an air body enclosed in hard walls caused vibrations which resounded as reverberations. When this air body, called a tympanum, was enclosed by vibratory walls, the sound was amplified and the reverberation eliminated. The tympanums consist of flat disks of wire netting covered on one side with heavy paper, and on the opposite side with an acoustic plaster composed of cement mixed with pumice, sawdust, asbestos, and several other materials. These disks are nailed over the wall leaving a half-inch space between the wall and the netting. Several public buildings have been finished with this type of acoustic lining with improved acoustic results.—*Kodak Abstr. Bull.*

Reverberation Time in "Dead" Rooms. CARL F. EYRING. *J. Acoustical Soc. Amer.*, I, No. 2, Pt. 1, January, 1930, p. 217. The well known Sabine formula $T = 0.05 V/a$ for the time of reverberation was experimentally determined by experiments in rooms in which the total absorbing powers were relatively low and the reverberation times correspondingly high. Theoretically, it is based upon the assumption of a homogeneous distribution of intensity, interference effects being neglected, and a random direction of propagation. This in effect amounts to assuming that the absorption at the bounding surfaces of the room is a continuous process. That these assumptions are valid in the case of "live" rooms, that is, rooms in which a large number of reflections are necessary to reduce the intensity of the reverberant sound to $1/1,000,000$ of its initial intensity, is shown by the agreement between theory and experiments. Measurement of the reverberation

time in a "dead" room, that is, one in which the average coefficient of absorption was of the order of 0.5, gave values lower than those computed by the formula. For such a case the author maintains that the assumptions of homogeneous distribution and random direction do not hold and that the absorption is not a continuous process but is more properly considered as taking place in a finite number of discrete steps, with an intervening time interval of $\Delta t = p/v$, where v is the velocity of sound and p is the mean free path of a sound element between reflections. From these assumptions he derives the equation

$$T = \frac{0.05V}{-S \log_e (1 - \alpha_a)}$$

where S is the total area of the room and α_a is the average absorption coefficient.

This equation gives results which agree more closely with the experimental results in "dead" rooms. In more reverberant rooms the two formulas give practically the same values. The author points out the importance of the new point of view in the talking picture industry where conditions of high absorption are frequently desired in sound stages. P. E. S.

High Speed Camera. *Science ind. phot.*, No. 4, April, 1930, p. 160. The Institute for Physical Research of the University of Tokyo has shown, during the recent Scientific Congress in Tokyo, a camera taking 40,000 pictures a second, by means of a drum having 180 mirrors revolving at a speed of 225 revolutions a second. G. L. C.

Film Container Reel. R. C. HOLSLAG. *Movie Makers*, 5, February, 1930, p. 123. A combined reel and humidifying can is described which consists of a flange that clips over the circumference of an unperforated reel. A new projector stand is also described which holds the projector, film splicer, spare reels, rewind, and translucent screen.—*Kodak Abstr. Bull.*

Special Carbon Arc for Wide Films. *Mot. Pict. News*, 41, Feb. 1, 1930, p. 69. A special carbon arc, claimed to have from 30 to 50 per cent greater brilliancy than the sun affords, is now being marketed.—*Kodak Abstr. Bull.*

Novel Projector Shutter. *Bioscope (Mod. Cinema Technique)*, 81, Dec. 18, 1929, p. v. The new Berger projector shutter, recently marketed by the Globe Reliance Corporation of America, is said to pass 50 per cent more light than any previous design. The shutter consists of three rotating members, each with three blades. The shutters are so stepped that the blades pass behind each other, and the actual gate shutter is formed in the central portion, so that at any one moment the shutter consists of one edge of a blade from each of the rotating members.—*Kodak Abstr. Bull.*

Philips Incandescent Projector Lamp. T. J. J. A. MANDERS. *Cinemat. franç.*, 12, Dec. 21, 1929, p. 103. *Bioscope (Mod. Cinema Technique)*, 82, Feb. 12, 1930, p. iii. *Kinotechnik*, 11, Sept. 5, 1929, p. 468. The Philips projection lamp avoids loss of light by absorption caused by blackening of the lamp walls. The upper part of the bulb is spherical, the lower part narrowing to a cylinder, near the bottom of which is the filament. The leads enter at the top. Convection currents within the bulb carry the tungsten vapor from the filament to the upper part of the bulb, where it deposits. The loss in efficiency throughout the life of the lamp is very small.—*Kodak Abstr. Bull.*

Running the Talkies. XVII. R. H. CRICKS. *Kinemat. Weekly*, 154, Dec. 5, 1929, p. 63. A new film and disk sound reproducing system has been invented by A. W. Harris and marketed by the British Phototone Company. Special features are discussed, such as the novel form of the synchronizer. Instead of the usual sound gate, there is a drum around which the film passes on its way from the bottom sprocket to the spool box. The drum being mounted separately from the projector, the effect of vibration of the latter is eliminated. A radiovisor bridge selenium cell is used in place of the usual photo-electric cell.—*Kodak Abstr. Bull.*

Corophone. New Talkie Apparatus. *Kinemat. Weekly*, 154, Dec. 12, 1929, p. 61. Brief notes on the Corophone reproduction equipment for sound-on-film or disk are given. The sound-on-film leads can be fitted to practically all projectors. For the illumination of the light-sensitive cell, a dual light source is provided which is run from a battery. No other batteries are employed.—*Kodak Abstr. Bull.*

Running the Talkies. XVIII. British Acoustic. R. H. CRICKS. *Kinemat. Weekly*, 154, Dec. 12, 1929, p. 61. The new form of the British Acoustic reproduction equipment is described and criticized. The optical system is unique in that instead of the usual narrow slit, 0.002 inch in width, there is an aperture about $\frac{1}{8}$ inch square. The rays from the exciting lamp are focused on this, and a second lens focuses the image of the sound track on a selenium cell. It is suggested that the range of tone of the latter is not quite equal to that of a photo-electric cell. It is capable, however, of a current emission about ten times as great as the photo-electric cell. The price of the outfit is approximately 5500 dollars.—*Kodak Abstr. Bull.*

Unbreakable Movie Film. *Sci. Amer.*, April, 1930, p. 299. A regular 16 mm. film is cut in strips $4\frac{3}{4}$ inches long. Every strip is then sealed between two pieces of thin steel through which an aperture for each frame has been punched and along the edges of which are a number of holes that are equivalent to the sprocket holes in the film. Each film section is equal in length to 16 frames. The projector consists of a magazine in which the strips are stacked, an electro-magnet to draw the top section, claws to move intermittently past the aperture, and a take-up magazine. As each frame stops in the aperture a 100 watt lamp projects the image onto a mirror placed above the aperture, which mirror deflects the beam of light along a horizontal axis onto a translucent screen. The strips fall by gravity in the take-up magazine from which a conveyor chain transfers them to the bottom of the feed magazine. Test runs exceeding 15,000 passages through the system have shown no wear whatever upon the film. G. L. C.

Analysis of Camera Silencing Devices. *Projection Eng.*, March, 1930, p. 13. The article describes the tests made by a committee of the Academy of Motion Picture Arts and Sciences. It is recommended that the motor be mounted as an integral part of the camera so that any external silencing device will be effective for both. The type of tripod used does not seem to have much effect on the noise. The amount of noise transmitted through the silencing device appeared to be nearly independent of the direction of the pick-up device from the camera. A table gives a comparison of various silencing equipments. The first column gives a brief description of the nature of the silencing equipment. Column 2 shows how much louder the noise of the uncovered camera was than average whispering. The next column shows the sound insulating ability in db. of the various devices

tested. The following column shows how many db. louder or softer is the noise of the camera enclosed in its protecting device than average whispering. The last column indicates whether the tripod is a standard wood tripod or a special tripod.

G. L. C.

Orthochromatic and Color Motion Picture Photography: Color Filters. P. LOB AND W. EWALD. *Kinotechnik*, 11, Sept. 5, 1929, p. 453. Glass, glass mounted, and gelatin filters are studied and compared photographically as well as by means of a spectroscope, micro-actinometer, and photo-cell.—*Kodak Abstr. Bull.*

Study of the Color Sensitiveness of Various Types of Photo-electric Cells. W. F. HESS. *Rensselaer Polytechnic Institute Bulletin*, No. 23, July, 1929. Spectral sensitivity curves from 400 to 800 millimicrons are given for five differently prepared caesium cells, for a rubidium and for a Burt sodium cell, and curves for the uniformity of one type of caesium cell, selecting six at random for the test.—*Kodak Abstr. Bull.*

Soviet Educational Film Production. *Intern. Phot. Bull.*, March, 1930, p. 16. The Soviet motion picture industry is actively engaged in turning out educational, scientific, and social films. Among the films now in production are: "Soviet Fordism," "The Grain Factory," "Hygiene for Women," "National Economy and Culture in the U. S. S. R.," "Coal and Metal." A monthly bulletin is issued for the workers in film studios concerning the achievements of the European and American motion picture industries, with a view to raising the skill of the Soviet workers.

G. L. C.

Paris Will Make Crime Talkies. *Intern. Phot. Bull.*, March, 1930, p. 16. Sound pictures are to be used by the Paris Surete Generale to record every question and answer, and every gesture of the examining magistrate and the suspect when the latter undergoes examination.

G. L. C.

Muybridge Semi-Centennial. W. R. MILES. *Internat. Phot.*, 1, June, 1929, p. 18. The author describes the ceremonies held at Stanford University on May 7 and 8, 1929, in honor of the fifteenth anniversary of E. J. Muybridge's experimental work. Leland Stanford, investigating the motion of a horse's legs, arranged to take a series of instantaneous consecutive photographs. This was the forerunner of motion picture photography. When Stanford began his experiments, $\frac{1}{12}$ of a second exposure was required. The first picture was taken with a single camera and was hand operated, but later twelve cameras were arranged at intervals of 21 inches to take consecutive pictures. The shutter was first operated by a latch string, but later it was arranged that the horse closed an electric circuit at the proper point and thus photographed himself. Contact was also made by a spring operated electrical circuit breaker having one contact for each camera. By means of the electrically operated shutters it was possible to take a number of simultaneous photographs.—*Kodak Abstr. Bull.*

Federal Chemist Warns against Improper Storage of Film. *Mot. Pict. News*, 40, Section 1, Dec. 28, 1929, p. 22. This is taken from a technical report prepared by C. E. Monroe, chief chemist of the U. S. Bureau of Mines. Flameless combustion of nitrocellulose films accompanied by evolution of nitrous fumes and carbon monoxide can be started at temperatures as low as 150°C. (300°F.), as a result of brief contact with an electric lamp, a heated steam coil, a glowing cigarette, or other sources of heat. No instances of spontaneous combus-

tion resulting from spontaneous decomposition of films have been recorded. Collodion cotton for seventy-five years, at least, has been packed for shipment in cardboard cartons which give sufficient access of air to allow any gases that may be formed to escape. Nitrogen oxides produced during decomposition of films are nitric oxide (NO) and nitrogen tetroxide (NO_2); the former combines rapidly with the oxygen of the air to form the latter gas which is brownish red in color. These gases combine with others and with water to form corrosive acids. A proper supply of water will quench fires in nitrocellulose films.—*Kodak Abstr. Bull.*

SOCIETY OF MOTION PICTURE ENGINEERS

OFFICERS

President

J. I. CRABTREE, Eastman Kodak Co., Rochester, New York

Past President

L. C. PORTER, General Electric Co., Nela Park, Cleveland, Ohio

Vice-Presidents

H. P. GAGE, Corning Glass Works, Corning, N. Y.

K. C. D. HICKMAN, Eastman Kodak Co., Rochester, N. Y.

Secretary

J. H. KURLANDER, Westinghouse Lamp Co., Bloomfield, N. J.

Treasurer

W. C. HUBBARD, General Electric Vapor Lamp Co., Hoboken, N. J.

Board of Governors

H. T. COWLING, Eastman Teaching Films, Inc., 343 State St., Rochester, N. Y.

J. I. CRABTREE, Research Laboratory, Eastman Kodak Co., Rochester, N. Y.

H. P. GAGE, Corning Glass Works, Corning, N. Y.

K. C. D. HICKMAN, Research Laboratory, Eastman Kodak Co., Rochester, N. Y.

W. C. HUBBARD, General Electric Vapor Lamp Co., Hoboken, N. J.

J. H. KURLANDER, Westinghouse Lamp Co., Bloomfield, N. J.

W. C. KUNZMANN, National Carbon Co., Cleveland, Ohio

D. MACKENZIE, Electrical Research Products, Inc., 7046 Hollywood Blvd., Los Angeles, Calif.

P. MOLE, Mole-Richardson, Inc., 941 N. Sycamore Ave., Hollywood, Calif.

M. W. PALMER, Paramount-Famous-Lasky, Inc., 6th & Pierce Aves., Long Island City, N. Y.

L. C. PORTER, General Electric Co., Nela Park, Cleveland, Ohio

S. ROWSON, Ideal Films, Ltd., 76 Wardour St., London, W. 1, England

E. I. SPONABLE, 277 Park Ave., New York, N. Y.

ProjectionL. M. TOWNSEND, *Chairman*

H. W. DREYER	C. GREENE	R. MIEHLING
G. C. EDWARDS	H. GRIFFIN	W. B. RAYTON
P. H. EVANS	N. M. LAPORTE	F. H. RICHARDSON
T. FAULKNER	R. H. McCULLOUGH	H. B. SANTEE
J. H. GOLDBERG	W. A. McNAIR	D. F. WHITING

PublicityW. WHITMORE, *Chairman*

F. C. BADGLEY	B. W. DUPUE	O. A. ROSS
	G. E. MATTHEWS	
	G. F. RACKETT	

SolicitationE. P. CURTIS, *Chairman*

J. W. COFFMAN	E. A. WILLIFORD
---------------	-----------------

Standards and NomenclatureA. C. HARDY, *Chairman*

M. C. BATSEL	P. H. EVANS	G. F. RACKETT
W. H. CARSON	R. E. FARNHAM	W. B. RAYTON
L. W. DAVEE	H. GRIFFIN	V. B. SEASE
A. DEBRIE	R. C. HUBBARD	T. E. SHEA
L. DEFOREST	L. A. JONES	J. P. SPENCE
J. A. DUBRAY	N. M. LAPORTE	E. I. SPONABLE
E. W. ENGSTROM	G. MITCHELL	L. T. TROLAND
	W. P. POWERS	

Studio LightingA. C. DOWNES, *Chairman*

L. J. BUTTOLPH	R. E. FARNHAM	M. W. PALMER
	K. C. D. HICKMAN	

Theater LightingC. E. EGELER, *Chairman*

J. C. AALBERG	F. FALGE	C. GREENE
F. A. BENFORD	R. E. FARNHAM	E. HUSE
A. C. DOWNES		L. A. JONES

LONDON SECTIONSIMON ROWSON, *Chairman*A. NEWMAN, *Vice-Chairman*PAUL KIMBERLEY, *Manager*L. EVELEIGH, *Secretary*ALAN WILLIAMSON, *Manager*H. WOOD, *Treasurer*WILLIAM VINTEN, *Manager***NEW YORK SECTION**M. W. PALMER, *Chairman*M. C. BATSEL, *Manager*D. E. HYNDMAN, *Sec.-Treas.*T. E. SHEA, *Manager***PACIFIC COAST SECTION**P. MOLE, *Chairman*C. DUNNING, *Manager*G. F. RACKETT, *Sec.-Treas.*E. HUSE, *Manager***Membership Committee**J. COURCIER, *Chairman*

E. JEWELL

Papers and ProgramsE. HUSE, *Chairman*

LONDON SECTION

During the month of March the London Section of the Society held two executive meetings and two general members' meetings.

At the executive meeting held on March 7th the Chairman announced that Sir Oliver Lodge had accepted the invitation to become the principal guest at the Society's first annual dinner on April 10th. Mr. Newman, *Vice-Chairman*, was elected to be the London representative on the new Historical Committee of the Society. The London Section agreed to coöperate with the Royal Photographic Society of Great Britain in their meeting to which they had invited Herr Kossovsky, a sound expert from Germany, to address them on the sound situation in Germany.

At the executive meeting held on March 28th the progress of the dinner committee was reported and discussed. Responding to the request from the Parent Society it was decided to ask Mr. Rowson, Mr. Newman, and Mr. John Maxwell to make talkie records and have them sent to Mr. Hickman.

The first general members' meeting was held at the E. L. M. A. Lighting Service Bureau, Savoy Street Strand, on March 10th, with Mr. S. Rowson in the chair. There were 17 members and 10 visitors present and before the paper of the evening was read, the Chairman called upon Mr. Carl Gregory of the Parent Society to address the meeting. Mr. Gregory repeated a message of greeting from the President and Council and spoke of the pleasure experienced by the Parent Society by the extreme activity of the London Section. The paper read was "Incandescent Lighting in the Studios," by Mr. Villiers of G. E. C. England, followed by demonstrations of lighting units.

At the second meeting of the month, held at the Royal Photographic Society on March 24th, with Mr. Arthur S. Newman, *Vice-Chairman*, in the chair, 20 members and 6 visitors were present. A paper was read on "Lenses with Special Reference to Colour Correction," by Mr. Warmishan of Taylor, Taylor, & Hobson, which was notable for the interesting and simple language in which the paper was couched. The chairman announced that the meeting on April 14th would be the last of this session.

MEETING OF THE INTERNATIONAL CONGRESS

The Eighth International Congress of Photography will be held

in 1931 in Dresden. It will convene on Tuesday, July 28th, and adjourn the following Saturday, August 1st.

C. E. KENNETH MEES,
National Secretary of
American Section
Commission Permanente

SOCIETY NOTES

Addresses of Members.—An up-to-date membership list was given in the May issue of the JOURNAL. Each member is requested to check carefully the accuracy of his name and address and advise the Secretary, Mr. J. H. Kurlander, 2 Clearfield Avenue, Bloomfield, N. J., of any errors or corrections.

Occasionally letters or copies of the JOURNAL are returned "Unclaimed." We will publish these names in the JOURNAL from time to time and will be glad to have information of the addresses of such members. A case in point is that of Robert Potter.

Board of Governors Meeting.—At the Board of Governors meeting held at the Wardman Park Hotel, Washington, D. C., on May 4th, a large number of business matters were transacted and recommendations made as follows:

- (1) That honorary memberships be conferred upon the presidencies of the Royal Photographic Society and Die Deutsche Kinotechnische Gesellschaft. (This recommendation was approved by a unanimous vote of the members present on May 5th.)
- (2) That a suitable award, such as a medal or plaque, be donated annually by the Society for outstanding achievement in motion picture engineering. The President was authorized to appoint a Committee of Awards.
- (3) That the names of Detroit and New York City be placed on the ballot for circulation to members for the determination of the meeting place of the fall convention.

A petition was received, signed in proper form by ten active members of the Society in good standing, requesting authorization to organize a Chicago section of the Society. A motion was made and passed that this petition be granted.

Constitution and By-Laws.—The amendments to the By-Laws as

revised by the Constitution and By-Laws Committee and approved by the Board of Governors were submitted to the membership on May 6th and were unanimously approved. It will be recalled that the amended Constitution was approved by the membership at the 1929 Toronto meeting. The amendments involve the establishment of sustaining memberships, the reestablishment of the same entrance fees for foreign and domestic members, the participation of the membership at large in the nomination of officers, etc.

The Spring Meeting.—The spring meeting of the Society was held at the Wardman Park Hotel, Washington, D. C., May 5th-8th, inclusive. The convention was called to order on Monday, May 5th, and the members welcomed by Major General Herbert B. Crosby, Commissioner of the District of Columbia.

An extensive and interesting series of technical papers was presented during the four days' sessions and in spite of the tropical temperature, the papers sessions were very well attended. One of the outstanding features of the papers session was a demonstration of a projector with an optical intermittent. The quality of the projected image was of such a high order of excellence that your president has suggested that the Projection Committee investigate very thoroughly and report at an early date on the subject of projection with optical intermittents.

Excellent facilities were available for the projection of sound films and this was made possible through the courtesy of the RCA Photophone, Inc., and the General Theaters Equipment Corporation. Messrs. J. Frank, Jr., and H. Griffin were in charge of projection and the services of the projectionists were donated by Local No. 224 to which the Society is indebted.

On Monday evening, May 5th, an excellent motion picture entertainment was presented for the benefit of the members and guests. The feature picture was *Journey's End* donated through the courtesy of Tiffany Productions, Inc.

Further entertainments were given on the evenings of May 6th and May 8th, the features, *Song of My Heart* and *All Quiet on the Western Front*, being shown through the courtesy of the Fox Film Corporation and Universal Pictures, Inc.

A feature of the banquet on Wednesday, May 7th, were speeches of welcome by Mr. Wm. DeMille, President of the Academy of Motion Picture Arts and Sciences, and other Academy members including M. C. Levy, Milton Sills, June Collyer, Glenn Tryon, Anita Page,

Dorothy Jordon, Eddie Nugent, and Peter Mole. Addresses of welcome were also delivered through the medium of the sound film by H. L. Clarke, George Eastman, H. B. Franklin, J. E. Otterson, D. Sarnoff, and H. M. Warner.

President Crabtree introduced the Master of Ceremonies, the Hon. William P. Connery, Jr., Representative of the Seventh District of Massachusetts, who in turn introduced Mr. C. F. Jenkins, founder and first president of the Society.

An interesting address was given by Will H. Hays, President of the Motion Picture Producers and Distributors of America, Inc., in which he announced that he was authorized by President Hoover to state that arrangements are being made to preserve motion picture film records and the collaboration of the Society would be appreciated in making recommendations for the best method of preserving the film. President Crabtree replied that a committee would be appointed immediately in order to collaborate in this work.

SUSTAINING MEMBERS

Agfa Ansco Corporation
 Audio-Cinema, Inc.
 Bausch & Lomb Optical Co.
 Bell & Howell Co.
 Bell Telephone Laboratories, Inc.
 Case Research Laboratory
 Consolidated Film Industries
 DuPont-Pathé Film Manufacturing Corp.
 Eastman Kodak Co.
 Electrical Research Products, Inc.
 General Theatres Equipment Co.
 Mole-Richardson, Inc.
 National Carbon Co.
 Pacent Reproducer Corp.
 Paramount-Famous-Lasky Corp.
 RCA Photophone, Inc.
 Technicolor Motion Picture Corp.

Transactions of the S. M. P. E.

A limited number of most of the issues of the *Transactions* is still available. These will be sold at the prices listed below.

Please note that nos. 1, 6, 8, and 9 are out of print.

Orders should be addressed direct to the *Secretary*, J. H. Kurlander, Westinghouse Lamp Co., Bloomfield, N. J.

No.	Price	No.	Price	No.	Price
2	\$0.25	16	\$2.00	28	\$1.25
3	0.25	17	2.00	29	1.25
4	0.25	18	2.00	30	1.25
5	0.25	19	1.25	31	1.25
7	0.25	20	1.25	32	1.25
8	0.25	21	1.25	33	2.50
10	1.00	22	1.25	34	2.50
11	1.00	23	1.25	35	2.50
12	1.00	24	1.25	36	2.50
13	1.00	25	1.25	37	3.00
14	1.00	26	1.25	38	3.00
15	1.00	27	1.25		



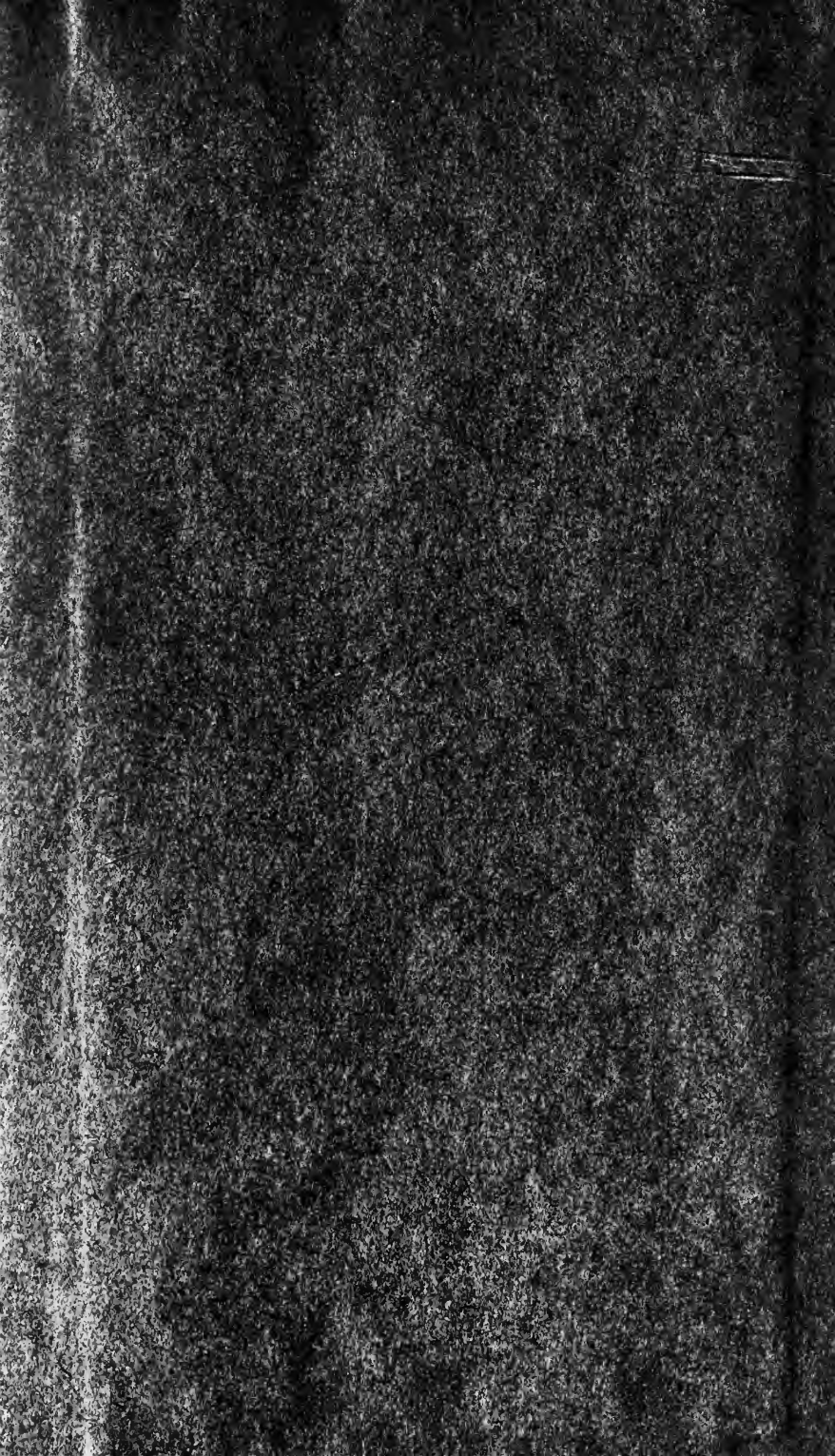

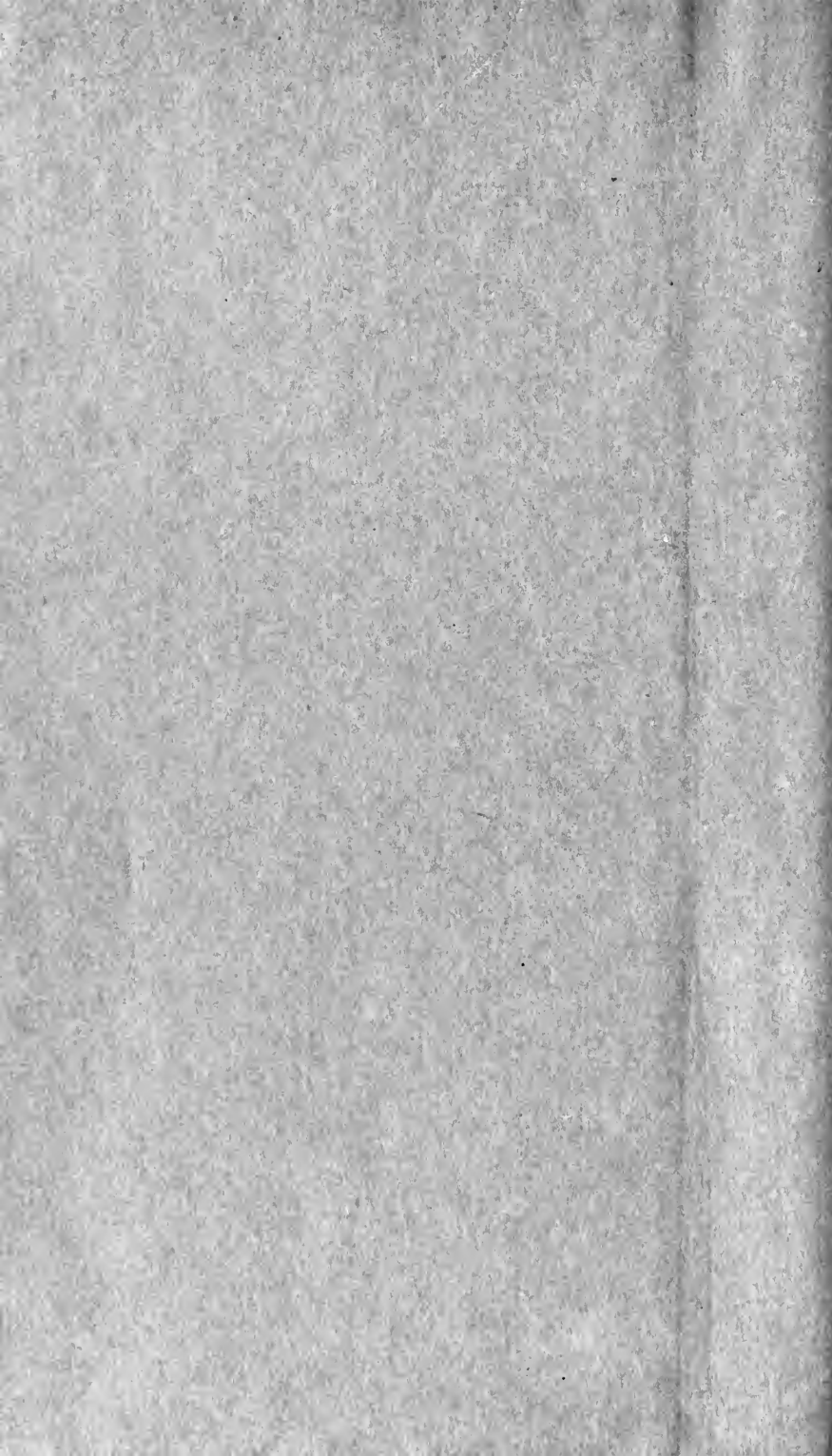

ST & VILERS
BOUND
SEP 23 1930

