



JOURNAL  
 AND  
 PROCEEDINGS  
 OF THE  
 ROYAL SOCIETY  
 OF  
 NEW SOUTH WALES  
 FOR  
 1914  
 (INCORPORATED 1881.)

---

VOL. XLVIII.

EDITED BY  
 THE HONORARY SECRETARIES.

---

THE AUTHORS OF PAPERS ARE ALONE RESPONSIBLE FOR THE STATEMENTS  
 MADE AND THE OPINIONS EXPRESSED THEREIN.



---

SYDNEY:  
 PUBLISHED BY THE SOCIETY, 5 ELIZABETH STREET NORTH, SYDNEY.  
 LONDON AGENTS:  
 GEORGE ROBERTSON & Co., PROPRIETARY LIMITED,  
 17 WARWICK SQUARE, PATERNOSTER ROW, LONDON, E.C.

1914.

233865 ✓





506.944

v. 48  
1914  
1st set

## CONTENTS.

## VOLUME XLVIII.

	PAGE.
ART. I.—PRESIDENTIAL ADDRESS. By HENRY G. SMITH, F.C.S. ...	1
ART. II.—Napier Commemorative Lecture. The Discovery of Logarithms by Napier of Merchiston. By Professor H. S. CARSLAW, SC. D. ... ..	42
ART. III.—On the Accuracy of Neumann's Method for the Estimation of Phosphorus. By H. S. H. WARDLAW, B.SC. ... ..	73
ART. IV.—Hepaticæ Australes. By Dr. FRANZ STEPHANI and Rev. W. WALTER WATTS. (Communicated by Mr. J. H. MAIDEN). ... ..	94
ART. V.—Dimorphic Foliage of <i>Acacia rubida</i> , and Fructification during Bipinnate Stage. By R. H. CAMBAGE, F.L.S. [ <i>With Plate I.</i> ] ... ..	136
ART. VI.—The Australian Journal of Dr. W. Stimpson, Zoologist, with an introduction. By CHARLES HEDLEY, F.L.S. ... ..	140
ART. VII.—On the Nature of the Deposit obtained from Milk by Spinning in a Centrifuge, (Preliminary Communication) By H. S. HALCRO WARDLAW, B.SC. ... ..	152
ART. VIII.—The Geology of the Cooma District, N.S.W., Part I. By W. E. BROWNE, B.SC. [ <i>With Plates II, III, IV, V.</i> ] ... ..	172
ART. IX.—The Oxidation of Sucrose by Potassium Permanganate By C. W. R. POWELL, Science Research Scholar, University of Sydney, (Communicated by Prof. FAWSITT). ... ..	223
ART. X.—The Composition of some Lime-sulphur Sprays made according to Recognised Formulæ. By A. A. RAMSAY. (Communicated by F. B. GUTHRIE, F.I.C., F.C.S.) ... ..	242
ART. XI.—On the Diffusible Phosphorus of Cow's Milk. By H. S. HALCRO WARDLAW, B.SC.... ..	253
ART. XII.—Mountains of Eastern Australia and their Effect on the Native Vegetation. By R. H. CAMBAGE, F.L.S. [ <i>With Plate VI.</i> ] ... ..	267
ART. XIII.—Description of a Limestone of Lower Miocene Age from Bootless Inlet, Papua. By FREDERICK CHAPMAN, A.L.S., F.R.M.S. (Communicated by W. S. DUN). [ <i>With Plates VII, VIII, IX.</i> ] ... ..	281
ART. XIV.—Notes on Tasmanian Hydrozoa. By E. A. BRIGGS, B.SC., Zoologist, Australian Museum, Sydney. (Communicated by C. HEDLEY, F.L.S. with the authority of the Trustees of the Australian Museum, Sydney.) [ <i>With Plates X, XI.</i> ] ... ..	302

	PAGE.
ART. XV.—Notes on the Catalase Reaction of Milk. By H. B. TAYLOR, B.SC. (Communicated by Professor C. E. FAWSITT).	319
ART. XVI.—The Development and Distribution of the Natural Order Leguminosæ. By E. C. ANDREWS, B.A., F.G.S. ...	333
ART. XVII.—On the Recovery of Actinium and Ionium from the Olayr Ores. By S. RADCLIFF. ... ..	408
ART. XVIII.—The Hæmatozoa of Australian Batrachians, No. 2. By J. B. CLELAND, M.D. ( <i>Syd.</i> ) ... ..	412
ART. XIX.—Observations on some reputed Natural Eucalyptus Hybrids, together with descriptions of two new species. By J. H. MAIDEN, F.L.S. and R. H. CAMBAGE, F.L.S. ... ..	415
ART. XX.—Notes on Eucalyptus, (with a description of a new species) No. 3. By J. H. MAIDEN, F.L.S. ... ..	423
ART. XXI.—Notes on Australian Fungi, No. 1. By J. B. CLELAND, M.D., ( <i>Syd.</i> ) and EDWIN CHEEL, Botanic Assistant, Botanic Gardens, Sydney... ..	433
ART. XXII.—A new Croton from N.S.W. By R. T. BAKER, F.L.S. [ <i>With Plate XII.</i> ] ... ..	444
ART. XXIII.—A Note on Desert Sandstone "Blows." By A. PADDISON. (Communicated by R. T. BAKER, F.L.S.) ...	448
ART. XXIV.—Eudesmin and its Derivatives, Part 1. By Professor R. ROBINSON, D.SC., Professor of Organic Chemistry in the University of Sydney, and H. G. SMITH, F.C.S., Assistant Curator of the Technological Museum... ..	449
ART. XXV.—On the Butyl Ester of Butyric Acid occurring in some Eucalyptus Oils. By H. G. SMITH, F.C.S. ... ..	464
ART. XXVI.—Note on the Estimation of Fat in Food for Infants By H. G. CHAPMAN, M.D., M.S. ... ..	469
ART. XXVII.—Studies in Statistical Representation, III., Curves, their Logarithmic Homologues, and Anti-logarithmic Generatrices; as applied to Statistical Data. By G. H. KNIBBS, C.M.G., F.S.S., etc., and F. W. BARFORD, M.A., A.I.A... ..	473
ART. XXVIII.—The Distribution of Frictional Losses in Internal Combustion Engines. By E. P. TAYLOR, B.E. (Communicated by Prof. S. H. BARRACLOUGH) ... ..	497
ART. XXIX.—A note on the Phenols occurring in some Eucalyptus Oils. By R. ROBINSON, D.SC. and H. G. SMITH, F.C.S. ...	518
ABSTRACT OF PROCEEDINGS ... ..	i.—xxiv.
PROCEEDINGS OF THE GEOLOGICAL SECTION ... ..	xxv—xxxiv.
TITLE PAGE, NOTICES, PUBLICATIONS, CONTENTS, ... ..	(i.—vi.)
OFFICERS FOR 1914-1915... ..	(vii.)
LIST OF MEMBERS, &c. ... ..	(ix.)
INDEX TO VOLUME XLVIII. ... ..	xxxv.

## DATES OF PUBLICATION.

---

### VOLUME XLVIII.

- Part I—pp. 1 - 128, published August 5, 1914.  
,, II—pp. 129 - 288, ,, November 25, 1914.  
,, III—pp. 289 - 519, ,, March 31, 1915.  
,, IV—pp. i. - xxxvii., (i.) - (xxii.) published April 19,  
1915.
- 
- 

### ERRATA.

- Page 19, After bornyl-acetate, in line 21, read:—accompanied by a small amount of geranyl-acetate.
- Page 248, Table III, column three, section (b) read Monosulphide 1·35; Polysulphide 4·10; Thiosulphate 1·90; Sulphate and sulphite ·12; Total sulphur 7·47; Total lime 4·22.
- Page 251, Table IV, column four, read Degree Baumée 1·97; column seven, read Total lime 3·90.

## PUBLICATIONS.

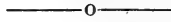

The following publications of the Society, if in print, can be obtained at the Society's House in Elizabeth-street:—

Transactions of the Philosophical Society, N.S.W., 1862-5, pp. 374, out of print.

Vol.	I. Transactions of the Royal Society, N.S.W., 1867, pp. 83,					„
„	II.	„	„	„	„	1868, „ 120, „
„	III.	„	„	„	„	1869, „ 173, „
„	IV.	„	„	„	„	1870, „ 106, „
„	V.	„	„	„	„	1871, „ 72, „
„	VI.	„	„	„	„	1872, „ 123, „
„	VII.	„	„	„	„	1873, „ 182, „
„	VIII.	„	„	„	„	1874, „ 116, „
„	IX.	„	„	„	„	1875, „ 235, „
„	X.	Journal and Proceedings			„	1876, „ 333, „
„	XI.	„	„	„	„	1877, „ 305, „
„	XII.	„	„	„	„	1878, „ 324, price 10s. 6d.
„	XIII.	„	„	„	„	1879, „ 255, „
„	XIV.	„	„	„	„	1880, „ 391, „
„	XV.	„	„	„	„	1881, „ 440, „
„	XVI.	„	„	„	„	1882, „ 327, „
„	XVII.	„	„	„	„	1883, „ 324, „
„	XVIII.	„	„	„	„	1884, „ 224, „
„	XIX.	„	„	„	„	1885, „ 240, „
„	XX.	„	„	„	„	1886, „ 396, „
„	XXI.	„	„	„	„	1887, „ 296, „
„	XXII.	„	„	„	„	1888, „ 390, „
„	XXIII.	„	„	„	„	1889, „ 534, „
„	XXIV.	„	„	„	„	1890, „ 290, „
„	XXV.	„	„	„	„	1891, „ 348, „
„	XXVI.	„	„	„	„	1892, „ 426, „
„	XXVII.	„	„	„	„	1893, „ 530, „
„	XXVIII.	„	„	„	„	1894, „ 368, „
„	XXIX.	„	„	„	„	1895, „ 600, „
„	XXX.	„	„	„	„	1896, „ 568, „
„	XXXI.	„	„	„	„	1897, „ 626, „
„	XXXII.	„	„	„	„	1898, „ 476, „
„	XXXIII.	„	„	„	„	1899, „ 400, „
„	XXXIV.	„	„	„	„	1900, „ 484, „
„	XXXV.	„	„	„	„	1901, „ 581, „
„	XXXVI.	„	„	„	„	1902, „ 531, „
„	XXXVII.	„	„	„	„	1903, „ 663, „
„	XXXVIII.	„	„	„	„	1904, „ 604, „
„	XXXIX.	„	„	„	„	1905, „ 274, „
„	XL.	„	„	„	„	1906, „ 368, „
„	XLI.	„	„	„	„	1907 „ 377, „
„	XLII.	„	„	„	„	1908, „ 593, „
„	XLIII.	„	„	„	„	1909, „ 466, „
„	XLIV.	„	„	„	„	1910, „ 719, „
„	XLV.	„	„	„	„	1911, „ 611, „
„	XLVI.	„	„	„	„	1912, „ 275, „
„	XLVII.	„	„	„	„	1913, „ 318, „
„	XLVIII.	„	„	„	„	1914, „ 584, „

# Royal Society of New South Wales.

---

## OFFICERS FOR 1914-1915.

---

### Patron:

HIS EXCELLENCY THE RIGHT HONOURABLE SIR RONALD  
CRAUFURD MUNRO FERGUSON, P.C., G.C.M.G.  
Governor-General of the Commonwealth of Australia.

### Vice-Patron:

HIS EXCELLENCY SIR GERALD STRICKLAND, G.C.M.G., etc.  
Governor of the State of New South Wales.

### President:

C. HEDLEY, F.L.S.

### Vice-Presidents:

F. H. QUAIFFE, M.A., M.D.	J. H. MAIDEN, F.L.S.
D. CARMENT, F.I.A., F.F.A.	HENRY G. SMITH, F.C.S.

### Hon. Treasurer:

H. G. CHAPMAN, M.D.

### Hon. Secretaries:

R. H. CABBAGE, L.S., F.L.S. | Prof. POLLOCK, D.S.C.

### Members of Council:

J. B. CLELAND, M.D., CH.M.	W. M. HAMLET, F.I.C., F.C.S.
Prof. T. W. E. DAVID, C.M.G., B.A.,	T. H. HOUGHTON, M. INST. C.E.
W. S. DUN. [D.S.C., F.R.S.]	J. NANGLE, F.R.A.S.
R. GREIG-SMITH, D.S.C.	C. A. SUSSMILCH, F.G.S.
F. B. GUTHRIE, F.I.C., F.C.S.	H. D. WALSH, B.A.I., M. INST. C.E.

## NOTICE.

---

THE ROYAL SOCIETY of New South Wales originated in 1821 as the "Philosophical Society of Australasia"; after an interval of inactivity, it was resuscitated in 1850, under the name of the "Australian Philosophical Society," by which title it was known until 1856, when the name was changed to the "Philosophical Society of New South Wales"; in 1866, by the sanction of Her Most Gracious Majesty Queen Victoria, it assumed its present title, and was incorporated by Act of the Parliament of New South Wales in 1881.

---

## TO AUTHORS.

---

Authors of papers desiring illustrations, are advised to consult the editors (Honorary Secretaries) before preparing their drawings. Unless otherwise specially permitted, such drawings should be carefully executed to a large scale on smooth white Bristol board in intensely black Indian ink, so as to admit of the blocks being prepared directly therefrom, in a form suitable for photographic "process." The size of a full page plate in the Journal is  $4\frac{1}{4}$  in.  $\times$   $6\frac{3}{4}$  in. The cost of all original drawings, and of colouring plates must be borne by Authors.

---

## FORM OF BEQUEST.

---

£ bequeath the sum of £ \_\_\_\_\_ to the ROYAL SOCIETY OF NEW SOUTH WALES, Incorporated by Act of the Parliament of New South Wales in 1881, and I declare that the receipt of the Treasurer for the time being of the said Corporation shall be an effectual discharge for the said Bequest, which I direct to be paid within \_\_\_\_\_ calendar months after my decease, without any reduction whatsoever, whether on account of Legacy Duty thereon or otherwise, out of such part of my estate as may be lawfully applied for that purpose.

*[Those persons who feel disposed to benefit the Royal Society of New South Wales by Legacies, are recommended to instruct their Solicitors to adopt the above Form of Bequest.]*

## INDEX.

	PAGE		PAGE
<b>A</b>			
Abstract of Proceedings ...	i.	Carslaw, Prof. H. S., Napier Commemorative Lecture ...	42
<i>Acacia longifolia</i> , Willd, and certain allied species, Notes on ... ..	...xxii.	Catalase Reaction of Milk, Notes on the ... ..	319
— <i>rubida</i> , Dimorphic foliage of ... ..	136	Chapman, F., Description of a Limestone of Lower Miocene Age from Bootless Inlet, Papua ... ..	281
Accuracy of Neumann's Method for the Estimation of Phos- phorus ... ..	73	—, H. G., Note on the Esti- mation of Fat in Food for Infants ... ..	469
Actinium ... ..	408	Chemical factor in the study of Plants, The value of the ...	12
Andrews, E. C. The Develop- ment and Distribution of the Natural Order Legu- minosæ ... ..	333	Cheel, Edwin, Notes on Aus- tralian Fungi, No. 1 ...	433
Australian Antarctic Expedi- tion ... ..	8	— Notes on <i>Acacia longifolia</i> , Willd, and certain allied species ... ..	...xxii.
— Journal of Dr. W. Stimp- son, The ... ..	140	Cleland, J. Burton, The Hæma- tozoa of Australian Batrach- ians, No. 2 ... ..	412
<b>B</b>			
Baker, R. T., A new Croton from New South Wales... ..	444	— Notes on Australian Fungi No. 1 ... ..	433
Barford, F. W., Studies in Stat- istical Representation, III. Curves, their Logarithmic Homologues, and Anti- logarithmic Generatrices; as applied to Statistical Data ... ..	473	Composition of some lime-sul- phur sprays made according to recognised formulæ ...	242
Batrachians. The Hæmatozoa of Australian ... ..	412	Cooma District, The Geology of the... ..	172
Briggs, E. A., Notes on Tas- manian Hydrozoa... ..	302	Cow's Milk, On the Diffusible Phosphorus of ... ..	242
British Association in Australia	10	Croton, a new, from New South Wales ... ..	444
Browne, W. R., The Geology of the Cooma District, New South Wales, Part I. ...	172	Curves their Logarithmic Homo- logues and Antilogarithmic Generatrices, as applied to Statistical Data ... ..	473
<b>C</b>			
Cabbage, R. H., Dimorphic foliage of <i>Acacia rubida</i> , and Fructification during Bipinnate Stage ... ..	136	<b>D</b>	
— Mountains of Eastern Australia and their effect on the Native Vegetation	267	Desert Sandstone Blows, Note on	448
— Observations on some re- puted natural Eucalyptus hybrids, together with de- scriptions of two new species	415	Dimorphic foliage of <i>Acacia</i> <i>rubida</i> , and Fructification during Bipinnate Stage ...	136
		Discovery of Logarithms by Napier of Merchiston ...	42
		Distribution of Frictional Losses in Internal Combustion Engines ... ..	497

<b>E</b>	PAGE	<b>E</b>	PAGE
Earth's Crust, Pressure in relation to the solid components of the ... ..	xiv.	Limestone of Lower Miocene Age from Bootless Inlet, Papua. Description of a ...	281
Estimation of Fat in Food for Infants, Note on the ...	469	List of Members ... ..	(ix.)
Eucalyptus, Notes on ...	423	<b>M</b>	
— Oils, On the butyl ester of butyric acid occurring in some ... ..	464	Maiden, J. H., Notes on Eucalyptus, No. 3... ..	423
Eudesmin and its Derivatives, Part I ... ..	449	—, Observations on some reputed natural Eucalyptus hybrids with descriptions of two new species ... ..	415
<b>F</b>		Members, List of ... ..	(ix.)
Foraminiferal Limestones, Note on the bearing of, upon the occurrence of Petroleum Fields ... ..	283	—, Newly elected ... ..	iii, x, xii, xvi, xviii, xx.
Frictional losses in Internal Combustion Engines, The Distribution of ... ..	497	—, Honorary ... ..	(xx)
Fungi, Notes on Australian ...	433	Mountains of Eastern Australia and their effect on the Native Vegetation ... ..	267
<b>G</b>		<b>N</b>	
Geological Section ... ..	xxv.	Napier Commemorative Lecture	42
Geology of the Cooma District, New South Wales, Part I.	172	Native Vegetation, Mountains of Eastern Australia and their effect on the ... ..	267
<b>H</b>		Nature of the Deposit obtained from Milk by Spinning in a Centrifuge ... ..	152
Hæmatozoa of Australian Batrachians, No. 2 ...	412	<b>O</b>	
Harper, L. F., Identity of the Sydney Harbour Collieries Coal Seam ... ..	xxix.	Obituary... ..	2
Hedley, C. The Australian Journal of Dr. W. Stimpson, Zoologist ... ..	140	Observations on some reputed natural Eucalyptus hybrids, together with descriptions of two new species	415
Hepaticæ Australes ... ..	94	Officers ... ..	(vii)
<b>I</b>		Olary Ores, On the Recovery of Actinium and Ionium from the ... ..	408
Identity of the Sydney Harbour Collieries Coal Seam ...	xxix.	Oxidation of Sucrose by Potassium Permanganate ... ..	223
Ionium ... ..	408	<b>P</b>	
<b>K</b>		Paddison, A., Note on Desert Sandstone Blows ... ..	448
Knibbs, G. H., Studies in Statistical Representation, III. Curves, their Logarithmic Homologues and Antilogarithmic Generatrices, as applied to Statistical Data	473	Phenols occurring in some Eucalyptus Oils, A note on the	518
<b>L</b>		Powell, W. R., The Oxidation of Sucrose by Potassium Permanganate ... ..	223
Leguminosæ, The Development and Distribution of the Natural Order ... ..	333	Presidential Address, H. G., Smith ... ..	1
		Pressure, in relation to the solid components of the Earth's crust ... ..	xiv.



	PAGE		PAGE
<b>R</b>			
Radcliff, S., On the Recovery of Actinium and Ionium from the Olary Ores ... ..	408	Statham, E. J., Pressure, in relation to the solid components of the Earth's crust	xiv.
Radium ... ..	6	Stephani, Dr. Franz, Hepaticæ Australes ... ..	94
Ramsay, A. A., The Composition of some Lime-sulphur Sprays made according to recognised formulæ ...	242	Stimpson, Australian Journal of Studies in Statistical Representation ... ..	140 473
Recovery of Actinium and Ionium from the Olary Ores, On the ... ..	408	<b>T</b>	
Robinson, R., Eudesmin and its Derivatives, Part I. ..	449	Tasmanian Hydrozoa, Notes on	302
—, A note on the Phenols occurring in some Eucalyptus Oils... ..	518	Taylor, E. P., The Distribution of Frictional losses in Internal Combustion Engines	497
<b>S</b>		—, H. B., Notes on the Catalase Reaction of Milk ...	319
Smith, H. G., Presidential Address ... ..	1	<b>W</b>	
—, A note on the Phenols occurring in some Eucalyptus Oils. ... ..	518	Wardlaw, H. S. H., On the Accuracy of Neumann's Method for the Estimation of Phosphorus ...	73
—, Eudesmin and its derivatives, Part I. ... ..	449	—, On the Diffusible Phosphorus of Cow's Milk ...	253
—, On the butyl ester of butyric acid occurring in some Eucalyptus Oils ...	464	—, On the nature of the Deposit obtained from Milk by spinning in a Centrifuge	152
		Watts, Rev. W. Walter, Hepaticæ Australes ... ..	94

---

Sydney :  
F. W. WHITE, PRINTER, 344 KENT STREET.  
1915.

---

LIST OF THE MEMBERS  
OF THE  
*Royal Society of New South Wales.*

---

P Members who have contributed papers which have been published in the Society's Transactions or Journal; papers published in the Transactions of the Philosophical Society are also included. The numerals indicate the number of such contributions.

† Life Members.

Elected.

1908		Abbott, George Henry, B.A., M.B., CH.M., Macquarie-street; p.r. 'Cooringa,' 252 Liverpool Road, Summer Hill.
1877	P 5	Abbott, W. E., 'Abbotsford,' Wingen.
1904		Adams, William John, M. I. MECH. E., 175 Clarence-street.
1898		Alexander, Frank Lee, c/o Messrs. Goodlet and Smith Ltd., Cement Works, Granville.
1905		Anderson, Charles, M.A., D.S.C. <i>Edin.</i> , Australian Museum, College-street.
1909	P 7	Andrews, E. C., B.A., F.G.S., Geological Surveyor, Department of Mines, Sydney.
1878		Backhouse, His Honour Judge A. P., M.A., 'Melita,' Elizabeth Bay.
1894	P 20	Baker, Richard Thomas, F.L.S., Curator, Technological Museum.
1894		† Balsille, George, 'Lauderdale,' N.E. Valley, Dunedin, N.Z.
1896		Barff, H. E., M.A., Warden of the University of Sydney.
1908	P 1	Barling, John, 'St. Adrians,' Raglan-street, Mosman.
1895	P 9	Barracrough, S. Henry, B.E., M.M.E., ASSOC. M. INST. C.E., M. I. MECH. E., Memb. Soc. Promotion Eng. Education; Memb. Internat. Assoc. Testing Materials; Lecturer in Mechanical Engineering in the University of Sydney; p.r. 'Marmion,' Victoria-street, Lewisham.
1906		Basnett, Nathaniel James, Punch-st., Mosman.
1894		Baxter, William Howe, Chief Surveyor, Existing Lines Office, Railway Department, Bridge-street.
1877		Belfield, Algernon H., 'Eversleigh,' Dumaresq.
1909	P 2	Benson, William Noel, B.Sc., The University, Sydney.
1905		† Bignold, Hugh Baron, Chambers, Wentworth Court, 64 Elizabeth-street.
1913		Bishop, Joseph Eldred, Killarney-street, Mosman.
1905		Blakemore, George Henry, Castlereagh Chambers, 10 Castlereagh-street, Sydney.
1888		† Blaxland, Walter, F.R.C.S. <i>Eng.</i> , L.R.C.P. <i>Lond.</i> , Fremantle, West Australia.
1893		Blomfield, Charles E., B.C.E. <i>Melb.</i> , 'Woombi,' Kangaroo Camp, Guyra.
1898		Blunno, Michele, Licentiate in Science (Rome), Government Viticultural Expert, Department of Agriculture, Sydney.

Elected		
1907		Bogenrieder, Charles, 'Scibile,' Little's Avenue, off Nicholson-street, Balmain.
1879		†Bond, Albert, 131 Bell's Chambers, Pitt-street.
1907		Boyd, Robert James, M.E., ASSOC. M. INST. C.E., 'Greenstead,' Park Road, Burwood,
1910		Bradley, Clement Henry Burton, M.B., CH.M., D.P.H., Demonstrator in Physiology in the University of Sydney.
1876		Brady, Andrew John, L.K. and Q.C.P. <i>Irel.</i> , L.R.C.S. <i>Irel.</i> , 175 Macquarie-street, Sydney.
1891		Brennand, Henry J. W., B.A., M.B., CH.M. <i>Syd.</i> , 'The Albany,' Macquarie-st., p.r. 'Wobun,' 310 Miller-st., North Sydney.
1914		Broad, Edmund F., 'Cobbam,' Woolwich Road, Hunter's Hill.
1878		†Brooks, Joseph, F.R.A.S., F.R.G.S., 'Hope Bank,' Nelson-street, Woollahra.
1913	P 1	Browne, William Rowan, B.Sc., Assistant Lecturer and Demonstrator in Geology in the University, Sydney.
1906		Brown, James B., Resident Master, Technical School, Granville; p.r. 'Aberdour,' Daniel-street, Granville.
1903		Bruck, Ludwig, 15 Castlereagh-street.
1898		†Burfitt, W. Fitzmaurice, B.A., B.Sc., M.B., CH.M. <i>Syd.</i> , 'Wyoming,' 175 Macquarie-street, Sydney.
1890		Burne, Alfred, D.D.S., Buckland Chambers, 183 Liverpool-st.
1907		Burrows, Thomas Edward, M. INST. C.E., L.S., Metropolitan Engineer, Public Works Department; p.r. 'Balboa,' Fern-street, Randwick.
1909		Calvert, Thomas Copley, ASSOC. M. INST. C.E., 'Maybank,' Manly.
1904	P 6	Cambage, Richard Hind, L.S., F.L.S., Chief Mining Surveyor; p.r. Park Road, Burwood. <i>Hon. Secretary.</i>
1907		Campbell, Alfred W., M.D., CH.M. <i>Edin.</i> , 183 Macquarie-street.
1876		Cape, Alfred J., M.A. <i>Syd.</i> , 'Karoola,' Edgecliffe Rd., Edgecliffe.
1897	P 4	Cardew, John Haydon, M. INST. C.E., L.S., 75 Pitt-street.
1901		Card, George William, A.R.S.M., F.G.S., Curator and Mineralogist to the Geological Survey, Department of Mines, Sydney.
1891		Carment, David, F.I.A. <i>Gr. Brit. &amp; Irel.</i> F.F.A., <i>Scot.</i> , 4 Whaling Road, North Sydney. <i>Vice-President.</i>
1909		Carne, Joseph Edmund, F.G.S., Assistant Government Geologist, Department of Mines, Sydney.
1903	P 1	Carslaw, H. S., M.A., SC.D., Professor of Mathematics in the University of Sydney.
1913	P 2	Challinor, Richard Westman, F.I.C., F.C.S., Lecturer in Chemistry, Sydney Technical College.
1909	P 2	Chapman, H. G., M.D., B.S., Assistant Professor of Physiology in the University of Sydney. <i>Hon. Treasurer.</i>
1913	P 3	Cheel, Edwin, Botanical Assistant, Botanic Gardens, Sydney.
1909	P 15	Cleland, John Burton, M.D., CH.M., Principal Assistant Microbiologist, Department of Public Health, 93 Macquarie-st.
1913		Cooke, William Ernest, M.A., F.R.A.S., Government Astronomer and Professor of Astronomy in the University of Sydney, The Observatory, Sydney.
1896	P 2	Cook, W. E., M.C.E. <i>Melb.</i> , M. INST. C.E., Water and Sewerage Board, North Sydney.

Elected	
1904	P 2 Cooksey, Thomas, PH.D., D.S.C. <i>Lond.</i> , F.I.C., Second Government Analyst; p.r. 'Clissold,' Calypso Avenue, Mosman.
1913	Coombs, F. A., F.C.S., Instructor of Leather Dressing and Tanning, Sydney Technical College; p.r. 55 Willoughby Road, North Sydney.
1876	Codrington, John Frederick, M.R.C.S. <i>Eng.</i> , L.R.C.P. <i>Lond.</i> , L.R.C.P. <i>Edin.</i> , 'Roseneath,' 8 Wallis-street, Woollahra.
1906	Colley, David John K., Superintendent, Royal Mint, Sydney.
1882	Cornwell, Samuel, J.P., Brunswick Road, Tyagarah.
1909	P 1 Cotton, Leo Arthur, B.A., B.S.C., Assistant Lecturer and Demonstrator in Geology in the University of Sydney.
1892	P 1 Cowdery, George R., ASSOC. M. INST. C.E., Blashki Buildings, Hunter-st.; p.r. 'Glencoe,' Torrington Road, Strathfield.
1886	Crago, W. H., M.R.C.S. <i>Eng.</i> , L.R.C.P. <i>Lond.</i> , 16 College-street, Hyde Park.
1912	Curtis, Louis Albert, L.S., 'Redlands,' Union-street, Mosman.
1875	Dangar, Fred. H., c/o W. E. Deucher, 12 and 14 Loftus-street.
1890	Dare, Henry Harvey, M.E., M. INST. C.E., Water Conservation and Irrigation Commission, 29 Elizabeth-street, Sydney.
1876	P 3 Darley, Cecil West, M. INST. C.E., Australian Club, Sydney.
1910	Darnell-Smith, George Percy, B.S.C., F.I.C., F.C.S., Department of Agriculture, Sydney.
1886	P 21 David, T. W. Edgeworth, C.M.G., B.A., D.S.C., F.R.S., F.G.S., Professor of Geology and Physical Geography in the University of Sydney.
1909	Davidson, George Frederick.
1892	P 1 Davis, Joseph, M. INST. C.E., Director-General, Public Works Department, Sydney.
1885	P 3 Deane, Henry, M.A., M. INST. C.E., F.L.S., F.R. MET. SOC., F.R.H.S., 'Campsie,' 14 Mercer Road, Malvern, Victoria.
1894	Dick, James Adam, B.A. <i>Syd.</i> , M.D., C.M., F.R.C.S. <i>Edin.</i> , 'Catfoss,' Belmore Road, Randwick.
1875	P 12 Dixon, W. A., F.I.C., F.C.S., 97 Pitt-street.
1906	Dixson, William, 'Merridong,' Gordon Road, Killara.
1876	Docker, His Honour Judge E. B., M.A., 'Mostyn,' Billyard Avenue, Elizabeth Bay.
1913	Dodd, Sydney, D.V.S.C., F.R.C.V.S., Lecturer in Veterinary Pathology in the University of Sydney.
1913	P 2 Doherty, William M., Analyst, Department of Public Health, Sydney.
1873	P 2 Du Faur, E., F.R.G.S., 'Flowton,' Turramurra.
1908	P 3 Dun, William S., Palæontologist, Department of Mines.
1908	Esdale, Edward William, 54 Hunter-street.
1879	P 4 Etheridge, Robert, Junr., J.P., Curator, Australian Museum; p.r. 'Inglewood,' Colo Vale, N.S.W.

Elected		
1877		† Fairfax, Edward Ross, <i>S. M. Herald</i> Office, Hunter-street.
1896		Fairfax, Geoffrey E., <i>S. M. Herald</i> Office, Hunter-street.
1868		Fairfax, Sir James R., Knt., <i>S. M. Herald</i> Office, Hunter-st.
1887		Faithfull, R. L., M.D., <i>New York</i> , L.R.C.P., L.S.A. <i>Lond.</i> , 5 Lyons Terrace.
1902		Faithfull, William Percy. Australian Club.
1912		Farnsworth, W. J., D.D.S. <i>Penn.</i> , 'Shelcote,' Shelcove Road, Neutral Bay.
1910		Farrell, John, Assistant Teacher, Sydney Technical College; p.r. 8 Thompson-street, Darlinghurst.
1909	P 1	Fawsitt, Charles Edward, D.Sc., PH.D., Professor of Chemistry in the University of Sydney.
1881		Fiaschi, Thos., M.D., M.CH. <i>Pisa</i> , 149 Macquarie-street.
1888		Fitzhardinge, His Honour Judge G. H., M.A., 'Red Hill,' Beecroft.
1900		† Flashman, James Froude, B.A., B.Sc., M.D., CH.M., Jersey Road, Burwood.
1879		† Foreman, Joseph, M.R.C.S. <i>Eng.</i> L.R.C.P. <i>Edin.</i> , 'Wyoming,' Macquarie-street.
1905		Foy, Mark, 'Eumemering,' Bellevue Hill, Woollahra.
1904		Fraser, James, M. INST. C.E., Engineer-in-Chief for Existing Lines, Bridge-street; p.r. 'Arnprior,' Neutral Bay.
1907		Freeman, William, 'Clodagh,' Beresford Road, Rose Bay.
1899		French, J. Russell, General Manager, Bank of New South Wales, George-street.
1881		Furber, T. F., F.R.A.S., Lands Department.
1876		George, W. R., 'Warialda,' Neutral Bay.
1906		Gosche, W. A. Hamilton, 24½ Pitt-street, Sydney.
1897		Gould, Senator The Hon. Sir Albert John, K.C.M.G., 'Eynesbury,' Edgecliffe.
1907		Green, W. J., Chairman, Hetton Coal Co., Athenæum Club.
1914		Greig, Arthur, ASSOC. M. I. MECH. E., Designing Engineer, Harbours Branch, Public Works Department.
1899		Greig-Smith, R., D.Sc. <i>Edin.</i> , M.Sc. <i>Dun.</i> , Macleay Bacteriologist, Linnean Society's House, Ithaca Road, Elizabeth Bay.
1912		Grieve, Robert Henry, B.A., 'Langtoft,' Llandaff-st., Waverley.
1912		Griffiths, F. Guy, B.A., M.D., CH.M., 135 Macquarie-st., Sydney.
1899	P 2	Gummow, Frank M., M.C.E., Corner of Bond and Pitt-streets.
1891	P 16	Guthrie, Frederick B., F.I.C., F.C.S., Chemist, Department of Agriculture, 137 George-street, Sydney.
1880	P 4	Halligan, Gerald H., F.G.S., 'Riversleigh,' Hunter's Hill.
1912		Hallmann, E. F., B.Sc., Biology Department, The University, Sydney.
1892		Halloran, Henry Ferdinand, L.S., 82 Pitt-street.
1909		Hammond, Walter L., Science Master, Hurlstone Agricultural Continuation School, Hurlstone Avenue, Summer Hill.
1912		Hamilton, A. G., Lecturer on Nature Study, Teachers' College, Blackfriars.

Elected		
1887	P 8	Hamlet, William M., F.I.C., F.C.S., Member of the Society of Public Analysts; Government Analyst, Health Department, Macquarie-street, North.
1912		Hare, A. J., Under Secretary for Lands, 'Boolorool,' Monte Christo-street, Woolwich.
1905	P 1	Harker, George, D.Sc., Assistant Lecturer and Demonstrator in Organic Chemistry in the University of Sydney.
1887	P 23	Hargrave, Lawrence, Wunulla Road, Woollahra Point.
1913		Harper, Leslie F., F.G.S., Geological Surveyor, Department of Mines, Sydney.
1884	P 1	Haswell, William Aitcheson, M.A., D.Sc., F.R.S., Professor of Zoology and Comparative Anatomy in the University of Sydney; p.r. 'Mimihau,' Woollahra Point.
1900		Hawkins, W. E., 88 Pitt-street.
1914		Hector, Alex. Burnet, 481 Kent-street.
1891	P 2	Hedley, Charles, F.L.S., Assistant Curator, Australian Museum, Sydney. <i>President.</i>
1899		Henderson, J., F.R.E.S., Manager, City Bank of Sydney, Pitt-st.
1884	P 1	Henson, Joshua B., ASSOC. M. INST. C.E., Hunter District Water Supply and Sewerage Board, Newcastle.
1905		Hill, John Whitmore, 'Willamere,' May's Hill, Parramatta.
1876	P 2	Hirst, George D., F.R.A.S., c/o Messrs. Tucker & Co., 215 Clarence-street.
1914		Hoare, Robert R., Staff Paymaster, Royal Navy, Garden Island, Sydney.
1892		Hodgson, Charles George, 157 Macquarie-street.
1901		Holt, Thomas S., 'Amalfi,' Appian Way, Burwood.
1905		Hooper, George, Assistant Superintendent, Sydney Technical College; p.r. 'Banksome,' Henson-street, Summer Hill.
1891	P 2	Houghton, Thos. Harry, M. INST. C.E., M. I. MECH. E., 63 Pitt-st.
1906		Howle, Walter Cresswell, L.S.A. <i>Lond.</i> , Bradleys Head Road, Mosman.
1913		Hudson, G. Inglis, J.P., 'Gudvangen,' Arden-street, Coogee.
1904		Jaquet, John Blockley, A.R.S.M., F.G.S., Chief Inspector of Mines, Department of Mines.
1904		Jenkins, R. J. H., 'Ettalong,' Roslyn Gardens, Rushcutters' Bay.
1905	P 8	Jensen, Harold Ingemann, D.Sc., Government Geologist, Darwin, Northern Territory.
1907		Johnson, T. R., M. INST. C.E.
1909	P 13	Johnston, Thomas Harvey, M.A., D.Sc., F.L.S., Lecturer in Biology in the University of Queensland, Brisbane.
1867		Jones, Sir P. Sydney, Knt., M.D. <i>Lond.</i> , F.R.C.S. <i>Eng.</i> , 'Llandilo,' Boulevard, Strathfield.
1911		Julius, George A., B.Sc., M.E., M. I. MECH. E., Culwulla Chambers, Castlereagh-street, Sydney.
1907		Kaleski, Robert, Holdsworthy, Liverpool.
1883		Kater, The Hon. H. E., J.P., M.L.C., Australian Club.

Elected		
1873	P 3	Keele, Thomas William, M. INST. C.E., Commissioner, Sydney Harbour Trust, Circular Quay; p.r. Llandaff-st., Waverley.
1914		Kemp, William E., A.M. INST. C.E., Public Works Department, Sydney.
1887		Kent, Harry C., M.A., F.R.I.B.A., Dibbs' Chambers, Pitt-street.
1901		Kidd, Hector, M. INST. C.E., M. I. MECH. E., 'Craig Lea,' 15 Mansfield-street, Glebe Point.
1896		King, Kelso, 120 Pitt-street.
1878		Knaggs, Samuel T., M.D. <i>Aberdeen</i> , F.R.C.S. <i>Irel.</i> , 'Northcote,' Sir Thomas Mitchell Road, Bondi.
1881	P 23	Knibbs, G. H., C.M.G., F.S.S., F.R.A.S., Member Internat. Assoc. Testing Materials; Memb. Brit. Sc. Guild; Commonwealth Statistician, Melbourne.
1877		Knox, Edward W., 'Rona,' Bellevue Hill, Double Bay.
1913		Kuntzen, Harold Eric, Australian Glue and Gelatine Works, Alexandria.
1911	P 2	Laserson, Charles Francis, Technological Museum.
1913		Lawson, A. Anstruther, D.Sc., F.R.S.E., Professor of Botany in the University of Sydney.
1906		Lee, Alfred, 'Glen Roona,' Penkivil-street, Bondi.
1909		Leverrier, Frank, B.A., B.Sc., K.C., 182 Phillip-street.
1914		Lightoller, G. H. Standish, M.B., CH.M., 'Yetholm,' New South Head Road, Darling Point.
1883		Lingen, J. T., M.A. <i>Cantab.</i> , University Chambers, 167 Phillip-street, Sydney.
1906		Loney, Charles Augustus Luxton, M. AM. SOC. REFR. E., Equitable Building, George-street.
1911		Longmuir, G. F., B.A., Science Master, Technical College, Bathurst.
1912		Lovell, Henry Tasman, M.A., PH.D., 'Tane,' Hodson Avenue, Cremorne.
1884		MacCormick, Sir Alexander, M.D., C.M. <i>Edin.</i> , M.R.C.S. <i>Eng.</i> , 185 Macquarie-street, North.
1887		MacCulloch, Stanhope H., M.B., CH.M, <i>Edin.</i> , 24 College-street.
1878		MacDonald, Ebenezer, J.P., c/o Perpetual Trustee Co, Ld., 2 Spring-street.
1903		McDonald, Robert, J.P., Pastoral Chambers, O'Connell-street; p.r. 'Wairoa,' Holt-street, Double Bay.
1891		McDouall, Herbert Chrichton, M.R.C.S. <i>Eng.</i> , L.R.C.S. <i>Lond.</i> , D.P.H. <i>Cantab.</i> , Hospital for the Insane, Gladesville.
1906		McIntosh, Arthur Marshall, 'Glenbourne,' Hill-st., Roseville.
1891	P 2	McKay, R. T., ASSOC. M. INST. C.E., Geelong Waterworks and Sewerage Trusts Office, Geelong, Victoria.
1876		Mackellar, The Hon. Sir Charles Kinnaird, M.L.C., M.B., C.M. <i>Glas.</i> , Equitable Building, George-street.
1880	P 9	McKinney, Hugh Giffin, M.E., Roy. Univ. <i>Irel.</i> , M. INST. C.E., Sydney Safe Deposit, Paling's Buildings, Ash-street.
1912	P 1	MacKinnon, Ewen, B.Sc., Agricultural Museum, George-st. N.
1903		McLaughlin, John, Union Bank Chambers, Hunter-street.
1901	P 1	McMaster, Colin J., Chief Commissioner of Western Lands; p.r. Wyuna Road, Woollahra Point.



Elected		
1894		McMillan, Sir William, K.C.M.G., 'Darrah,' 311 Edgecliff Road, Woollahra.
1899		MacTaggart, J. N. C., M.E. <i>Syd.</i> , ASSOC. M. INST. C.E., Water and Sewerage Board District Office, Lyons Road, Drummoyne.
1909		Madsen, John Percival Vissing, D.S.C., B.E., P. N. Russell Lecturer in Electrical Engineering in the University of Sydney.
1883	P 27	Maiden, J. Henry, J.P., F.L.S., Hon. Fellow Roy. Soc. S.A.; Hon. Memb. Royal Society, W.A.; Netherlands Soc. for Promotion of Industry; Philadelphia College Pharm.; Southern Californian Academy of Sciences; Pharm. Soc. N.S.W.; Brit. Pharm. Conf.; Corr. Fellow Therapeutical Soc., Lond.; Corr. Memb. Pharm. Soc. Great Britain; Bot. Soc. Edin.; Soc. Nat. de Agricultura (Chile); Soc. d' Horticulture d' Alger; Union Agricole Calédonienne; Soc. Nat. etc., de Chérbourg; Roy. Soc. Tas.; Roy. Soc. Queensl.; Inst. Nat. Génévois; Hon. Vice-Pres. of the Forestry Society of California; Diplômé of the Société Nationale d'Acclimatation de France; Government Botanist and Director, Botanic Gardens, Sydney. <i>Vice-President.</i>
1880	P 1	Manfred, Edmund C., Montague-street, Goulburn.
1897		Marden, John, M.A., LL.D., Principal, Presbyterian Ladies' College, Sydney.
1908		Marshall, Frank, B.D.S. <i>Syd.</i> , 141 Elizabeth-street.
1914		Martin, A. H., 17 Hughes-street, Potts Point.
1875	P 27	Mathews, Robert Hamilton, L.S., Assoc. Etran. Soc. d' Anthrop. de Paris; Cor. Mem. Anthrop. Soc., Washington, U.S.A.; Cor. Mem. Anthrop. Soc. Vienna; Cor. Mem. Roy. Geog. Soc. Aust. Q'sland; Local Correspondent Roy. Anthrop. Inst., Lond.; 'Carcuron,' Hassall-st., Parramatta.
1903		Meggitt, Loxley, Co-operative Wholesale Society, Alexandria.
1912		Meldrum, Henry John, p.r. 'Craig Roy,' Sydney Rd., Manly.
1905		Miller, James Edward, Broken Hill, New South Wales.
1889	P 8	Mingaye, John C. H., F.I.C., F.C.S., Assayer and Analyst to the Department of Mines; p.r. Campbell-street, Parramatta.
1879		Moore, Frederick H., Union Club, Sydney.
1877		†Mullens, Josiah, F.R.G.S., 'Tenilba,' Burwood.
1879		Mullins, John Francis Lane, M.A. <i>Syd.</i> , 'Killountan,' Darling Point.
1876		Myles, Charles Henry, 'Dingadee,' Everton Rd., Strathfield.
1893	P 3	Nangle, James, F.R.A.S., Superintendent of Technical Education, The Technical College, Sydney; p.r. 'St. Elmo,' Tupper-street, Marrickville.
1891		†Noble, Edward George, 8 Louisa Road, Balmain.
1893		Noyes, Edward, ASSOC. INST. C.E., ASSOC. I. MECH. E., c/o Messrs. Noyes Bros., 115 Clarence-street, Sydney.
1903		†Old, Richard, Waverton, Bay Road, North Sydney.
1913		Ollé, A. D., 'Kareema,' Charlotte-street, Ashfield.
1896		Onslow, Col. James William Macarthur, 'Gilbulla,' Menangle.

Elected		
1875		O'Reilly, W. W. J., M.D., CH.M. Q. Univ. <i>Irel.</i> , M.R.C.S. <i>Eng.</i> , 171 Liverpool-street, Hyde Park.
1891		Osborn, A. F., ASSOC. M. INST. C.E., Water Supply Branch, Sydney, 'Uplands,' Meadow Bank, N.S.W.
1880		Palmer, Joseph, 96 Pitt-st.; p.r. Kenneth-st., Willoughby.
1878		Paterson, Hugh, 183 Liverpool-street, Hyde Park.
1906		Pawley, Charles Lewis, 137 Regent-street.
1901		Peake, Algernon, M. INST. C.E., 25 Prospect Road, Ashfield.
1899		Pearse, W., Union Club; p.r. 'Plashett,' Jerry's Plains, viâ Singleton.
1877		Pedley, Perceval R., Lord Howe Island.
1899		Petersen, T. Tyndall, F.C.P.A., 4 O'Connell-street.
1909	P 1	Pigot, Rev. Edward F., S.J., B.A., M.B. <i>Dub.</i> , Director of the Seismological Observatory, St. Ignatius' College, Riverview.
1879	P 7	Pittman, Edward F., ASSOC. R. S. M., L.S., Under Secretary and Government Geologist, Department of Mines.
1881		Poate, Frederick, Surveyor-General, Lands Department, Sydney.
1879		Pockley, Thomas F. G., Union Club, Sydney.
1887	P 8	Pollock, J. A., D.Sc., Corr. Memb. Roy. Soc. Tasmania; Roy. Soc. Queensland; Professor of Physics in the University of Sydney. <i>Hon. Secretary.</i>
1896		Pope, Roland James, B.A., <i>Syd.</i> , M.D., C.M., F.R.C.S., <i>Edin.</i> , 183 Macquarie-street.
1910		Potts, Henry William, F.L.S., F.C.S., Principal, Hawkesbury Agricultural College, Richmond, N.S.W.
1914		Purdy, John Smith, M.D., C.M. <i>Aberd.</i> , D.P.H. <i>Camb.</i> , Metro- politan Medical Officer of Health, Town Hall, Sydney.
1893		Purser, Cecil, B.A., M.B., CH.M. <i>Syd.</i> , 139 Macquarie-street.
1901	P 1	Purvis, J. G. S., ASSOC. M. INST. C.E., Water and Sewerage Board, 341 Pitt-street.
1908		Pye, Walter George, M.A., B.Sc., <i>S. M. Herald</i> Office, Pitt and Hunter-streets; p.r. 'Gainsford Lodge,' 331 Ernest-street, North Sydney.
1876	P 1	Quaife, F. H., M.A., M.D., M.S., 'Yirrimbirri,' Stanhope Road, Killara. <i>Vice-President.</i>
1912	P 2	Radcliff, Sidney, Radium Hill Works, Woolwich.
1890	P 1	Rae, J. L. C., 'Lisgar,' King-street, Newcastle.
1865	P 1	†Ramsay, Edward P., LL.D. <i>St. And.</i> , F.R.S.E., F.L.S., Queens- borough Road, Croydon Park.
1906		Redman, Frederick G., P. and O. Office, Pitt-street.
1914		Rhodes, Thomas, Civil Engineer, Public Works Department, Sydney.
1909		Reid, David, 'Holmsdale,' Pymble.
1902		Richard, G. A., Mount Morgan Gold Mining Co., Mount Morgan, Queensland.

Elected		
1906		Richardson, H. G. V., 32 Moore-street.
1913	P 2	Robinson, Robert, D.Sc., Professor of Organic Chemistry in the University of Sydney.
1913		Roseby, Rev. Thomas, M.A., LL.D. <i>Syd.</i> , F.R.A.S., 'Tintern,' Mosman.
1884		Ross, Chisholm, M.D. <i>Syd.</i> , M.B., C.M. <i>Edin.</i> , 151 Macquarie-st.
1895	P 1	Ross, Herbert E., Equitable Building, George-street.
1897		Russell, Harry Ambrose, B.A., c/o Messrs. Sly and Russell, 369 George-street; p.r. 'Mahuru,' Fairfax Road, Bellevue Hill.
1893		Rygate, Philip W., M.A., B.E. <i>Syd.</i> , ASSOC. M. INST. C.E., City Bank Chambers, Pitt-street, Sydney
1913		Scammell, W. J., Mem. Phar. Soc. <i>Grt. Brit.</i> , 18 Middle Head Road, Mosman.
1905		Scheidel, August, PH.D., Managing Director, Commonwealth Portland Cement Co., Sydney; Union Club.
1892	P 1	Schofield, James Alexander, F.C.S., A.R.S.M., Assistant Professor of Chemistry in the University of Sydney.
1856	P 1	†Scott, Rev. William, M.A. <i>Cantab.</i> , Kurrajong Heights.
1904	P 1	Sellers, R. P., B.A. <i>Syd.</i> , 'Mayfield,' Wentworthville.
1908		Sendey, Henry Franklin, Manager of the Union Bank of Australia Ltd., Sydney; Union Club; p.r. 'The Hermitage,' Vaucluse Road, Rose Bay.
1883	P 4	Shellshear, Walter, M. INST. C.E., Inspecting Engineer, London.
1900		Simpson, R. C., Technical College, Sydney.
1910		Simpson, William Walker, 'Abbotsford,' Leichhardt-street, Waverley.
1882		Sinclair, Eric, M.D., C.M. <i>Glas.</i> , Inspector-General of Insane, 9 Richmond Terrace, Domain; p.r. 'Broomage,' Kangaroo-street, Manly.
1893		Sinclair, Russell, M. I. MECH. E., Vickery's Chambers, 82 Pitt-st.
1891	P 3	Smail, J. M., M. INST. C.E., Chief Engineer, Metropolitan Board of Water Supply and Sewerage, 341 Pitt-street.
1912		Smart, Bertram James, B.Sc., Public Works Office, Lithgow.
1893	P 48	Smith, Henry G., F.C.S., Assistant Curator, Technological Museum, Sydney. <i>Vice-President.</i>
1874	P 1	†Smith, John McGarvie, 89 Denison-street, Woollahra.
1892	P 2	Statham, Edwyn Joseph, ASSOC. M. INST. C.E., Cumberland Heights, Parramatta.
1914		Stephens, Frederick G. N., F.R.C.S., M.B., CH.M., 'Gleneugie,' New South Head Road, Rose Bay.
1913		Stewart, Alex. Hay, B.E., Metallurgist, Technical College, Sydney.
1900		Stewart, J. Douglas, B.V.SC., M.R.C.V.S., Professor of Veterinary Science in the University of Sydney; 'Berelle,' Homebush Road, Strathfield.
1903		Stoddart, Rev. A. G., The Rectory, Manly.
1909		Stokes, Edward Sutherland, M.A. <i>Syd.</i> , F.R.C.P. <i>Irel.</i> , Medical Officer, Metropolitan Board of Water Supply and Sewerage, 341 Pitt-street.
1883	P 4	Stuart, Sir Thomas P. Anderson, M.D., CH.M., LL.D. <i>Edin.</i> , D.Sc., Professor of Physiology in the University of Sydney; p.r. 'Lincluden,' Fairfax Road, Double Bay.

Elected		
1901	P 6	Süssmilch, C. A., F.G.S., Technical College, Newcastle, N.S.W.
1912		Swain, E. H. F., District Forester, Narrabri.
1906		Taylor, The Hon. Sir Allen, M.L.C., A.M.P. Society, Pitt-street.
1906		Taylor, Horace, Registrar, Dental Board, 7 Richmond Terrace, Domain,
1905		Taylor, John M., M.A., LL.B. <i>Syd.</i> , 'Woonona,' 43 East Crescent-street, McMahon's Point, North Sydney.
1893		† Taylor, James, B.Sc., A.R.S.M.
1899		Teece, R., F.I.A., F.F.A., General Manager and Actuary, A.M.P. Society, 87 Pitt-street.
1861	P 19	Tebbutt, John, F.R.A.S., Private Observatory, The Peninsula, Windsor, New South Wales.
1878		Thomas, F. J., 'Lovat,' Nelson-street, Woollahra.
1879		Thomson, The Hon. Dugald, Carrabella-st., North Sydney.
1885	P 2	Thompson, John Ashburton, M.D. <i>Bruce.</i> , D.P.H. <i>Cantab.</i> , M.R.C.S. <i>Eng.</i> , Australian Club, Sydney.
1896		Thompson, Major A. J. Onslow, Camden Park, Menangle.
1913		Thompson, Joseph, M.A., LL.B., Vickery's Chambers, 82 Pitt-street, Sydney.
1913		Tietkens, William Harry, 'Upna,' Eastwood.
1879		Trebeck, P. C., 12 O'Connell-street.
1900		Turner, Basil W., A.R.S.M., F.C.S., Victoria Chambers, 83 Pitt-st.
1913		Ullrich, Richard Emil, Accountant, 43 Bond-street, Mosman.
1883		Vause, Arthur John, M.B., C.M. <i>Edin.</i> , 'Bay View House,' Tempe.
1890		Vicars, James, M.E., Memb. Intern. Assoc. Testing Materials; Memb. B. S. Guild; Challis House, Martin Place.
1892		Vickery, George B., 78 Pitt-street.
1903	P 3	Vonwiller, Oscar U., B.Sc., Assistant Professor of Physics in the University of Sydney.
1879		Walker, H. O., Commercial Union Assurance Co., Pitt-street.
1899		† Walker, The Hon. J. T., F.R.C.I., Fellow of Institute of Bankers <i>Eng.</i> , 'Wallaroy,' Edgecliffe Road, Woollahra.
1910		Walker, Charles, 'Lynwood,' Terry Road, Ryde.
1910		Walker, Harold Hutchison, Major, C.M.F., 'Vermont,' Belmore Road, Randwick.
1901		Walkom, A. J., A.M.I.E.E., Electrical Branch, G.P.O., Sydney.
1891	P 2	Walsh, Henry Deane, B.A.I. <i>Dub.</i> , M. INST. C.E., Commissioner and Engineer-in-Chief, Harbour Trust, Circular Quay.

Elected 1903		Walsh, Fred., J.P., Capt. C M.F., Consul-General for Honduras in Australia and New Zealand; For. Memb. Inst. Patent Agents, London; Patent Attorney Regd. U.S.A.; Memb. Patent Law Assoc., Washington; For. Memb. Soc. German Patent Agents, Berlin; Regd. Patent Attorn. Comm. of Aust; Memb Patent Attorney Exam. Board Aust.; George and Wynyard-streets; p.r. 'Walsholme,' Centennial Park, Sydney E.
1901		Walton, R. H., F.C.S., 'Flinders,' Martin's Avenue, Bondi.
1913	P 3	Wardlaw, Hy. Sloane Halcro, B.Sc. <i>Syd.</i> , 87 Macpherson-street, Waverley.
1883	P 17	Warren, W. H., LL.D., WH. SC., M. INST. C.E., M. AM. SOC. C.E., Member of Council of the International Assoc. for Testing Materials, Professor of Engineering in the University of Sydney.
1876		Watkins, John Leo, B.A. <i>Cantab.</i> , M.A. <i>Syd.</i> , Parliamentary Draftsman, Attorney General's Department, Macquarie-st.
1910		Watson, James Frederick, M.B., CH. M., Australian Club, Sydney, p.r. 'Midhurst,' Woollahra.
1910		Watt, Francis Langston, F.I.C., A.E.C.S., 10 Northcote Chambers, off 16½ Pitt-street, City.
1911		Watt, R. D., M.A., B.Sc., Professor of Agriculture in the University of Sydney.
1910	P 1	Wearne, Richard Arthur, B.A., Principal, Technical College, Ipswich, Queensland.
1897		Webb, Frederick William, C.M.G., J.P., 'Livadia,' Manly.
1892		Webster, James Philip, ASSOC. M. INST. C.E., L.S., <i>New Zealand</i> , Town Hall, Sydney.
1907		Weedon, Stephen Henry, C.E., 'Kurrowah,' Alexandra-street, Hunter's Hill.
1907		Welch, William, F.E.G.S., 'Roto-iti,' Boyle-street, Mosman.
1881		†Wesley, W. H., London.
1892		White, Harold Pogson, F.C.S., Assistant Assayer and Analyst, Department of Mines; p.r. 'Quantox,' Park Road, Auburn.
1877		†White, Rev. W. Moore, A.M., LL.D. <i>Dub.</i>
1909		White, Charles Josiah, B.Sc., Science Lecturer, Sydney Training College; p.r. 'Byrntryird,' 49 Prospect Rd. Summer H.
1907		Wiley, William, 'Kenyon,' Kurraba Point, Neutral Bay.
1908	P 1	Willis, Charles Savill, M.B., CH. M. <i>Syd.</i> , M.R.C.S. <i>Eng.</i> , L.R.C.P. <i>Lond.</i> , D.P.H., <i>Lond.</i> , Department of Public Instruction, Bridge-street.
1901		Willmot, Thomas, J.P., Toongabbie.
1890		Wilson, James T., M.B., CH. M. <i>Edin.</i> , F.R.S., Professor of Anatomy in the University of Sydney.
1907		Wilson, W. C., C.E., 30 and 34 Elizabeth-street, Sydney.
1891		Wood, Percy Moore, L.R.C.P. <i>Lond.</i> , M.R.C.S. <i>Eng.</i> , 'Redcliffe,' Liverpool Road, Ashfield.
1909		Woodhouse, William John, M.A., Professor of Greek in the University of Sydney.
1906	P 6	Woolnough, Walter George, D.Sc., F.G.S., Professor of Geology in the University of Western Australia, Perth.
1909		Yeomans, Richard John, 14 Castlereagh-street.

Elected

## HONORARY MEMBERS.

*Limited to Twenty.*

M.—Recipients of the Clarke Medal.

- 1914 Bateson, W. H., M.A., F.R.S., Director of the John Innes Horticultural Institution, England, The Manor House, Merton, Surrey.
- 1900 Crookes, Sir William, Kt., O.M., LL.D., D.Sc., P.R.S., 7 Kensington Park Gardens, London W.
- 1905 Fischer, Emil, Professor of Chemistry in the University of Berlin.
- 1911 Hemsley, W. Botting, LL.D. (*Aberdeen*), F.R.S., F.L.S., V.M.H., Formerly Keeper of the Herbarium, Royal Gardens, Kew; Korresp. Mitgl. der Deutschen Bot. Gesellschaft; Hon. Memb. Sociedad Mexicana de Historia Natural; New Zealand Institute; Roy. Hort. Soc. London; 24 Southfield Gardens, Strawberry Hill, Middlesex.
- 1914 Hill, J. P., D.Sc., F.R.S., Professor of Zoology, University College, London.
- 1901 Judd, J. W., C.B., LL.D., F.R.S., F.G.S., Formerly Professor of Geology, Royal College of Science, London; 30 Cumberland Road, Kew, England.
- 1908 Kennedy, Sir Alex. B. W., Kt., LL.D., D. Eng., F.R.S., Emeritus Professor of Engineering in University College, London, 17 Victoria-street, Westminster, London S.W.
- 1908 P 57 \*Liversidge, Archibald, M.A., LL.D., F.R.S., Emeritus Professor of Chemistry in the University of Sydney, 'Fieldhead,' George Road, Coombe Warren, Kingston, Surrey.
- 1912 Martin, C. J., D.Sc., F.R.S., Director of the Lister Institute of Preventive Medicine, Chelsea Gardens, Chelsea Bridge Road, London.
- 1905 Oliver, Daniel, LL.D., F.R.S., Emeritus Professor of Botany in University College, London.
- 1894 Spencer, W. Baldwin, C.M.G., M.A., D.Sc., F.R.S., Professor of Biology in the University of Melbourne.
- 1900 M Thiselton-Dyer, Sir William Turner, K.C.M.G., C.I.E., M.A., LL.D., Sc.D., F.R.S., The Ferns, Witcombe, Gloucester, England.
- 1908 Turner, Sir William, K.C.B., M.B., D.C.L., LL.D., Sc.D., F.R.C.S. *Edin.*, F.R.S., Principal and Emeritus Professor of the University of Edinburgh, 6 Eton Terrace, Edinburgh, Scotland.

\* Retains the rights of ordinary membership. Elected 1872.

## OBITUARY 1914.

*Ordinary Members.*

- 1876 Brown, H. J.
- 1880 Bush, T. J.
- 1900 Canty, M.
- 1876 MacLaurin, The Hon. Sir Henry Normand.
- 1896 Plummer, J.
- 1904 Ross, W. J. Clunies.
- 1876 Watson, C. Russell.

## AWARDS OF THE CLARKE MEDAL.

Established in memory of

THE REVD. W. B. CLARKE, M.A., F.R.S., F.G.S., etc.,

*Vice-President from 1866 to 1878.*

To be awarded from time to time for meritorious contributions to the Geology, Mineralogy, or Natural History of Australia. The prefix \* indicates the decease of the recipient.

Awarded

- 1878 \*Professor Sir Richard Owen, K.C.B., F.R.S.  
 1879 \*George Bentham, C.M.G., F.R.S.  
 1880 \*Professor Thos. Huxley, F.R.S.  
 1881 \*Professor F. M'Coy, F.R.S., F.G.S.  
 1882 \*Professor James Dwight Dana, LL.D.  
 1883 \*Baron Ferdinand von Mueller, K.C.M.G., M.D., PH.D., F.R.S., F.L.S.  
 1884 \*Alfred R. C. Selwyn, LL.D., F.R.S., F.G.S.  
 1885 \*Sir Joseph Dalton Hooker, O.M., G.C.S.I., C.B., M.D., D.C.L., LL.D., F.R.S.  
 1886 \*Professor L. G. De Koninck, M.D., University of Liège.  
 1887 \*Sir James Hector, K.C.M.G., M.D., F.R.S.  
 1888 \*Rev. Julian E. Tenison-Woods, F.G.S., F.L.S.  
 1889 \*Robert Lewis John Ellery, F.R.S., F.R.A.S.  
 1890 \*George Bennett, M.D., F.R.C.S. *Eng.*, F.L.S., F.Z.S.  
 1891 \*Captain Frederick Wollaston Hutton, F.R.S., F.G.S.  
 1892 Sir William Turner Thiselton Dyer, K.C.M.G., C.I.E., M.A., LL.D., SC.D.,  
 F.R.S., F.L.S., late Director, Royal Gardens, Kew.  
 1893 \*Professor Ralph Tate, F.L.S., F.G.S.  
 1895 Robert Logan Jack, F.G.S., F.R.G.S., late Government Geologist,  
 Brisbane, Queensland.  
 1895 Robert Etheridge, Junr., Curator of the Australian Museum, Sydney  
 1896 \*The Hon. Augustus Charles Gregory, C.M.G., F.R.G.S.  
 1900 \*Sir John Murray, K.C.B., LL.D., SC.D., F.R.S.  
 1901 \*Edward John Eyre.  
 1902 F. Manson Bailey, F.L.S., Colonial Botanist of Queensland, Brisbane.  
 1903 \*Alfred William Howitt, D.SC. F.G.S.  
 1907 Walter Howchin, F.G.S., University of Adelaide.  
 1909 Dr. Walter E. Roth, B.A., Pomeroon River, British Guiana, South  
 America.  
 1912 W. H. Twelvetrees, F.G.S., Government Geologist. Launceston,  
 Tasmania.  
 1914 A. Smith Woodward, LL.D., F.R.S., Keeper of Geology, British  
 Museum (Natural History) London.
-

## AWARDS OF THE SOCIETY'S MEDAL AND MONEY PRIZE.

*Money Prize of £25.*

Awarded.

- 1882 John Fraser, B.A., West Maitland, for paper entitled 'The Aborigines of New South Wales.'
- 1882 Andrew Ross, M.D., Molong, for paper entitled 'Influence of the Australian climate and pastures upon the growth of wool.'

*The Society's Bronze Medal and £25.*

- 1884 W. E. Abbott, Wingen, for paper entitled 'Water supply in the Interior of New South Wales.'
- 1886 S. H. Cox, F.G.S., F.C.S., Sydney, for paper entitled 'The Tin deposits of New South Wales.'
- 1887 Jonathan Seaver, F.G.S., Sydney, for paper entitled 'Origin and mode of occurrence of gold-bearing veins and of the associated Minerals.'
- 1888 Rev. J. E. Tenison-Woods, F.G.S., F.L.S., Sydney, for paper entitled 'The Anatomy and Life-history of Mollusca peculiar to Australia.'
- 1889 Thomas Whitelegge, F.R.M.S., Sydney, for paper entitled 'List of the Marine and Fresh-water Invertebrate Fauna of Port Jackson and Neighbourhood.'
- 1889 Rev. John Mathew, M.A., Coburg, Victoria, for paper entitled 'The Australian Aborigines.'
- 1891 Rev. J. Milne Curran, F.G.S., Sydney, for paper entitled 'The Microscopic Structure of Australian Rocks.'
- 1892 Alexander G. Hamilton, Public School, Mount Kembla, for paper entitled 'The effect which settlement in Australia has produced upon Indigenous Vegetation.'
- 1894 J. V. De Coque, Sydney, for paper entitled the 'Timbers of New South Wales.'
- 1894 R. H. Mathews, L.S., Parramatta, for paper entitled 'The Aboriginal Rock Carvings and Paintings in New South Wales.'
- 1895 C. J. Martin, D.Sc., M.B., F.R.S., Sydney, for paper entitled 'The physiological action of the venom of the Australian black snake (*Pseudechis porphyriacus*).'
- 1896 Rev. J. Milne Curran, Sydney, for paper entitled 'The occurrence of Precious Stones in New South Wales, with a description of the Deposits in which they are found.'



ISSUED AUGUST 12th, 1914

Vol. XLVIII.

Part I.

JOURNAL AND PROCEEDINGS  
OF THE  
**ROYAL SOCIETY**  
OF  
NEW SOUTH WALES  
FOR  
1914.

PART I, (pp. 1-128).

CONTAINING PAPERS READ IN  
MAY to JUNE (*in part*).



SYDNEY:  
PUBLISHED BY THE SOCIETY, 5 ELIZABETH STREET NORTH, SYDNEY.  
LONDON AGENTS:  
GEORGE ROBERTSON & Co., PROPRIETARY LIMITED,  
17 WARWICK SQUARE, PATERNOSTER ROW, LONDON, E.C.

1914.



JUL 13 1914

# PRESIDENTIAL ADDRESS.

By HENRY G. SMITH, F.C.S.

[*Delivered to the Royal Society of N.S. Wales, May 6th, 1914.*]

It is now my privilege, on this, the ninety-third anniversary of the foundation of this Society, to address you as your President. It gives me great pleasure to be able to congratulate you on the present satisfactory position of the Society; the membership has increased, and no less than eleven new members were admitted on one evening. The financial statement, together with other items of interest concerning the progress of the Society, will be found recorded in the report from the Council, published in another portion of the Journal.

Considerable interest was taken by the members in the proceedings at the monthly meetings, and the four popular Science Lectures were well attended, not only by the members, but also by the general public. In some instances the available room was not sufficient to accommodate all who wished to be present. This attempt by the Society to popularise science in Sydney is to be commended, and should be continued. It speaks well for the active interest in science, that members are willing to undertake the great trouble of preparing lectures of the nature of those so far given, and such effort must tend eventually to awaken more general interest in scientific subjects.

The Society is, therefore, grateful to Mr. E. C. Andrews, B.A., Mr. James Nangle, Mr. W. M. Hamlet, F.I.C., and to Professor W. H. Warren, for delivering these lectures during the year.

*Obituary.*—I will now refer briefly to those of our members who, during the year, have been removed by death.

This Society did itself the honour, and at the same time expressed approval of the scientific efforts of Dr. Alfred Russel Wallace, when, in the year 1895, it elected him as one of its Honorary Members. Although 90 years old when he died, yet, his scientific life had been one long period of strenuous activity and continuity of purpose. He will perhaps be best remembered as an advocate for and co-worker with Darwin in the exposition of the cause of natural selection, and in the time to come when scientists of the next generation shall look back on the efforts of the workers of this, one of the names to be remembered with appreciation will be that of Dr. Wallace. The message he has left to us is one of encouragement, and suggestion, and we recognise that as one of the active men of his day he did his share in the forward march of scientific progress.

Dr. Critchley Hinder was elected to this Society in 1896, and although he did not take a very active part in the affairs of the Society during later years, yet, his marked ability and activity in the field of surgery brought his name prominently to the front, and in this connection he became one of the best known practitioners in Sydney, if not in the whole State. Dr. Hinder graduated with honours at the Sydney Medical School in 1889, and was one of the second batch of graduates from that school. After filling various positions as a medical man, he was, in 1894, appointed assistant honorary surgeon to the Royal Prince Alfred Hospital, an institution with which he remained actively connected, until, at the time of his death, he held the position of second on the staff of full surgeons. He was lecturer and examiner in clinical surgery in connection with the University Medical School, and a member of the Faculty of Medicine. He greatly assisted in the establish-

ment of the Western Suburbs Cottage Hospital, and was one of the founders of the Western Suburbs Medical Society. In 1909 he was elected President of the New South Wales Branch of the British Medical Association, and was Vice-President in the section of surgery at the Australasian Medical Congresses at Adelaide and Melbourne. In many other directions he took an active part in the progress and welfare of the people, and was a citizen worthy to be remembered. His death on the 14th September—brought about through an accidental wound obtained in the course of his professional duties—removed from among us one of our most brilliant members, and from scientific surgery one of its best exponents. Dr. Hinder wrote numerous articles, and was the author of a copiously illustrated work “Lectures on Clinical Surgery,” published in 1904.

Mr. J. H. Goodlet, better known perhaps as Colonel Goodlet, was elected a member of this Society as far back as 1859, and was, at the time of his death, the second oldest member. When quite a young man he took an active interest in the work of this Society, and although not a contributor to the proceedings, yet, he continued to show his appreciation of its efforts until the last. It is, however, as a philanthropist that he will be chiefly remembered, and from his large hearted benefactions many institutions in New South Wales have greatly benefitted. His practical sympathy with the sick was always in evidence, and his action in the establishment of the first home for consumptives in New South Wales, was only one example of his continuous efforts to benefit the afflicted. He was treasurer to the Sydney Female Refuge for forty years, a director of the Sydney Hospital for many years, and he also took an active part in the affairs of the Benevolent Society, as well as many others. Born in Leith, Scotland, he came to Australia when but seventeen years old, and was seventy-eight years of age at the time of his death.

Mr. Lewis Whitfeld, the well known Sydney Barrister, was elected to this Society in 1879. He was called to the Bar in 1888, and was in active practice to the last, as he appeared in Court on the morning of the day of his death. The suddenness of his death on the 28th June, when playing golf at Rose Bay, was extremely sad. He was a man highly respected, and his active assistance in the cause of scientific effort was shown by his long association with this Society.

Mr. John Plummer, who died on the 9th March, 1914, was elected a member of this Society in 1896. He was connected with journalistic effort in New South Wales for more than thirty years, and had previously been occupied with literary and statistical work in England. At one time he was sub-editor of the "Morning Advertiser," which position he relinquished to join the staff of the "Graphic." In 1879 he came to Sydney as the representative of that journal at the International Exhibition in the Garden Palace. His sympathies were always with the efforts of this Society, and with scientific work generally. He was in his eighty-fourth year at the time of his death.

Dr. C. Russell Watson, who died on the 24th January, 1914, was elected a member of this Society in 1876. For a great number of years he carried on his duties as a medical practitioner in Erskineville, near Sydney, where he gained the respect and regard of all those who came into contact with him. His many acts of kindness and his benevolent actions generally, caused him to be highly esteemed, and the district has lost a good resident as well as this Society a good member.

\* \* \* \* \*

The new buildings of the Institute of Tropical Medicine at Townsville, Queensland, were opened on June 28th. This institution has been established to deal specially with

diseases peculiar to Northern Australia, and at the commencement of its existence was assisted by contributions from various Australian Universities. It is now supported by an annual grant of £4,000 from the Federal Government, as well as one of £500 from the Queensland Government. This is a direct recognition of the value to a country of systematic scientific research, and one might express a hope that this policy will be extended to the furtherance of research in other directions. That the results obtained by this institute may be as successful, and as advantageous to the people of Australia, as similar investigations undertaken in Africa and Central America have been to the inhabitants of those regions, is, I am sure, the wish of every member of this Society.

A research of considerable importance now being undertaken at Cobar in this State, under the direction of the Rev. Edward F. Pigot, S.J., B.A., of the Riverview College Observatory, Sydney, is the investigation of the elastic rigidity of the earth, derived from the tidal deformation of our planet by the sun and the moon. This research on the "body-tides" or "earth-tides" has been in progress in Europe for a number of years, and in the hands of more recent investigators, *e.g.*, Schweydar (Heidelberg), Orloff (Dorpat), and above all, Hecker (Potsdam), remarkable results have been obtained by horizontal pendulums of extreme sensibility, with photographic registration. The curves obtained have, however, exhibited certain anomalous secondary features, and with the view of investigating these, a Commission of the International Seismological Association was appointed. The commission is establishing research stations in Asia, Africa, North America, and Australia, in addition to the European stations already existing. The stations must be at a sufficient distance from the coast to avoid disturbing influences of the oceanic tidal wave, and

for this reason Cobar was selected as the Australian station, this locality being 360 miles north-westerly of Sydney. The instruments have been installed there recently, in a disused portion of one of the mines, 430 feet below the surface so as to avoid thermal warping due to solar radiation. The registration of each station will be continued for at least two years, and the measurements and reductions will be carried out at head-quarters in Europe.

Perhaps the most momentous question which has arisen during the past year, concerning the health of the people, is the marvellous success which has attended the treatment of cancer with radium. The initial experimental stages have shown most satisfactory results, and the more that is known about the action of radium on growths of this nature, the more enthusiastic specialists become. Early this year, Dr. W. S. Lazarus-Barlow, of the Middlesex Hospital, England, made some startling statements when recounting the satisfactory results of treatment at that institution. The United States of America has shown considerable anxiety in reference to this question, and through the kindness of Mr. Radcliff, I have been able to read the reports of the inquiry on radium before the Committee of Mines and Mining (The House of Representatives) held on January 19th last. Testimony to the efficacy of radium in the treatment of cancer was given by Dr. H. A. Kelly of Baltimore; Dr. Robert Abbe, Senior Surgeon, St. Luke's Hospital, New York City; Dr. H. R. Gaylord, Director, State Institute for Study of Malignant Disease, Buffalo; and Dr. C. F. Burnham, Johns Hopkins Hospital, Baltimore; who all certified to the splendid results they obtained with radium, and Dr. Kelly declared that radium was the most remarkable therapeutic agent which has ever been put into the hands of man, and that it had far greater curative effects in cancer than had been hitherto suspected. The cry was in all cases for more radium, so that even



more satisfactory results might be obtained, and attempts are being made in that country to give the Government greater control over the production of radium, and to a certain extent a monopoly of all deposits of carnotite, pitchblende, or other ores containing radium in sufficient quantity for extraction, in lands belonging to the United States.

At the present time, no less than 75,000 people die annually in the United States from cancer, and if it is only possible to save ten or fifteen per cent. of these by this method, then any expenditure of money in the preparation or purchase of the necessary radium would be justified, if it could be obtained. The German Government, progressive as ever, gave last year a million marks with which to purchase radium, to be used in their teaching institutions and hospitals for public work. Important as this question must be to those countries whose populations are large, yet, it is just as important to us in Australia, as the deaths in this country from cancer are proportionate to those of other countries, and we should not be behind in the endeavour to save to the nation the lives of those who are now shown to die unnecessarily. Mr. Knibbs, the Commonwealth Statistician, informs me that the deaths from the various forms of cancer in the Commonwealth during the year 1913 numbered 3,603.

During the year one of our members, Mr. S. Radcliff, brought under the notice of the Society, and the world generally, the methods adopted by him at the works at Woolwich, near Sydney, in extracting the small amount of radium from the ore deposits at Olary, South Australia. This ore was found by European chemists to be difficult of treatment, so that buyers could not be found for it. It is thus creditable in the extreme that the possibility of profitably treating the ore locally has been shown. The success of the process adopted depends largely on the fact that it

is possible to extract the radium without having to decompose the whole of the mineral constituents in the ore, and when it is considered that the material treated contains only one part of the element radium in 214 million parts of ore, it is seen how intricate the process becomes, and how carefully the manufacture must be carried on. Under such conditions as maintain in this and similar ores, it is hardly to be expected that radium will ever be cheap, although even at its present price a lot of radium could be purchased for the cost of a modern battleship.

When the mineral deposits of the little known portions of Australia shall be systematically prospected, it is very probable that more extensive deposits of radium bearing minerals will be discovered, and production thus increased. It is worthy of consideration, therefore, whether the needs of our own people are not sufficiently imperative to demand the retention in Australia of our own material, until home requirements are satisfied, even if the State finds it necessary also to undertake the manufacture of the radium itself, in order to augment the supply.

It is, however, the scientific aspect of this question which appeals more strongly to us, because we recognise that all such discoveries must result in increased stimulus to further physical and chemical researches. We are only just on the threshold of the utilisation of minute quantities of matter, and the advantages of these, both in the animal and vegetable kingdoms, will be more and more brought out as research proceeds and satisfactory results accumulate.

The Australian Antarctic Expedition under Dr. Douglas Mawson has now returned to Australia, having completed the work it set out to accomplish. This Society took advantage of the opportunity when the leader was in Sydney to tender to him a hearty welcome on his return to Australia, and the Society's rooms on that occasion were

well filled by members wishing to do honour to him and to his brave companions. The forced detention of Dr. Mawson and some other members of the expedition in Antarctica for a longer period than was intended, should be the means of adding considerably to the magnitude of the scientific results obtained by the expedition generally, so that the delay may be advantageous after all. We are anxiously waiting for the further statement of these scientific results, and Dr. Mawson proposes making an announcement during the visit of the British Association in August next. Some of the general scientific results from the expedition were recorded and explained by Mr. Cambage in his Presidential Address of last year, and these indicate the extent of the observations and the efforts of the members to carry out successfully the duties allotted to them. How much Australia is likely to be advantaged by the results of the expedition will be seen later, for it must necessarily be some time, perhaps years, before all the scientific data can be systematically arranged. We must wait, therefore, for the publication of the promised volumes to see in what directions these data help towards a general scientific advance. That progress will be considerable in certain directions cannot be doubted, and the results of the labours of the members of this expedition will show that Australia is not behind in the effort to advance the scientific knowledge of the world, nor in the ability necessary to carry it out to a successful issue.

Symon's Meteorological Magazine for July, 1913, speaks eulogistically about the inclusion of the Antarctic regions within the system of daily reports, and congratulates Dr. Mawson on the realisation of what was but recently a fantastic dream.

Another matter for congratulation in connection with the progress of Antarctic Research is the approaching issue

of some of the scientific results of the Shackleton Expedition. Professor T. W. Edgeworth David, F.R.S., B.A., etc., has just returned from Europe, having there completed and prepared for press the first volume of the geological reports of that expedition. I am sure we all congratulate Professor David on the completion, so far, of a work of such magnitude.

The meeting of the British Association in Australia this year is such a momentous epoch in the scientific life of this country, that every effort should be made to render the meetings to be held here in August next as successful as possible. That the British Association should have decided to hold its annual meeting in 1914 so far from the centre of the Empire, is indeed a compliment to us, and a recognition of the efforts of the scientific workers of this young country. This visit will act as a stimulus to the aspirations and ambitions of Australian scientists, and encourage them to work with renewed energy in the future. The liberal financial assistance given to this undertaking by the Federal and State Governments—described in detail in the Presidential Address of last year—is a matter for gratification on all sides. We, as a Society, are not unmindful of this generosity, and fully appreciate the help thus given. The British Association has, since its inception, done much to foster a progressive scientific spirit throughout the British Dominions, and has followed, in this particular, the policy enunciated in the preface to the first report in 1831, a paragraph in which reads as follows:—"with a just sense, therefore, of the consequences to Science of combining the Philosophical Societies dispersed throughout the provinces of the Empire in a general co-operative union." We in Australia can reciprocate the spirit of such a policy, and endeavour to do our share towards its consummation.

I take this opportunity of expressing my thanks to the Honorary Secretaries and to the Honorary Treasurer for

the manner in which they have conducted the affairs of the Society during the year. It is not generally recognised how much valuable time is given by these Honorary Officers in the interest of the Society, but the preparation of the annual volume, the library management, the arrangement of the financial affairs of the Society, the correspondence and many other duties all demand considerable attention and exacting service.

In this connection, I would direct your attention to a matter of some moment to the Society. As you are aware our highly respected Honorary Secretary, Mr. J. H. Maiden, has expressed a wish to retire from that office. It is now 21 years since Mr. Maiden was first elected to the position of Honorary Secretary, and with the exceptions of the years 1896 and 1911 when he was your President, his services have been continuous. His efforts have always been willingly given to further the welfare of this Society, and his natural ability for organising and his methodical methods have enabled its affairs to proceed smoothly and efficiently. The Royal Society is under a great obligation to Mr. Maiden for his unselfish devotion to duty, and for his endeavours to increase its importance as a scientific institution. He has always been ready to help in every possible way, and we all regret that he has now ceased to hold the position of Honorary Secretary. We wish him long life, continued health, and energy. Although he retires from the office of Secretary, yet the Society will continue to have his advice and counsel in the direction of its affairs.

\* \* \* \* \*

I now come to the main portion of my address, and ask you to bear with me while I endeavour to explain to you some features brought out by the study of our Native Flora. I have to thank my colleague Mr. Baker for botanical advice and assistance, and my Laboratory Assistant, Mr. Randle,

for the preparation of the ashes. I need hardly say that I have taken full advantage of the resources of the Technological Museum.

**The value of the chemical factor in the study of Plants.**

When choosing the subject for this address it appeared to me that the time was opportune to review the results so far obtained from the phytochemical investigations which have formed the principal portion of the research work of the Technological Museum during recent years, and endeavour to show in what directions these data appear to assist the establishment of broad generalisations, the correct understanding of which would go far towards securing important economic results.

It is now more than twenty years since my colleague (Mr. R. T. Baker, F.L.S.) and I first commenced our joint investigations into the economic possibilities and scientific characters of certain groups of the indigenous flora of this continent, a study which has been continued to the present time. During this period, the chief botanical and chemical features—more or less complete—of about 160 distinct species of *Eucalyptus* have been collaterally determined, while practically the whole of the coniferous trees of Australia have been similarly treated. Besides these largesystematic investigations many species of *Melaleuca*, growing in eastern Australia, have been worked in a corresponding manner, as well as several other species belonging to different genera.

A considerable amount of general evidence in a new direction has thus been collected, the consideration of which should make it possible to offer some reasonable suggestions as to the manner in which certain chemical phenomena appear to have influenced the botanical characters of some of these plants, or at least, to have become in contemporaneous agreement with those morphological

distinctions which go to differentiate the several species in the larger Australian genera.

It might perhaps be accepted that real insight into the constructive unity of the plant would be more satisfactorily obtained from the consideration of results derived from separate lines of investigation, and no objection can now be taken to the conclusions arrived at from specialised effort in any direction, so long as it assists the object in view. Botanical science already relies upon the efforts of workers in many sections, such as those of morphology, anatomy, cytology, physiology, and ecology, all these being in co-operation with the systematic side. But it is now shown that some of these sections are particularly dependent upon the results of chemical reactions, the principal effect of which may be observed in well defined botanical changes, these eventually becoming quite distinctive in character, and as such are now recognised.

The time absorbing and exacting nature of extensive chemical investigations in directions sufficiently comprehensive to enable generalisations to be undertaken, is, perhaps, one reason why some biologists have, in the past, not always been prepared to take advantage of such evidence as is to be derived from extended chemical studies carried out in parallel directions with their own, and on the same or similar material. If the results of the chemical work with the principal Australian genera have been helpful to my botanical colleague, certainly his investigations on the same material have greatly assisted my conclusions. This co-operation necessarily broadened the outlook in both directions and offered considerable advantages to thought and suggestion, while enabling a deeper insight to be obtained into some of the problems underlying the evolutionary formation of these genera and of their peculiarities of distribution.

The demonstrated results of life effort are now recognised as being largely due to chemical action, and extended investigations of the chemical and physical causes which are responsible for these changes would throw considerable light on the metabolic processes of the plant, the value of the results being, of course, governed largely by the extent of the observations, and on the completeness with which they have been undertaken.

Professor Vines has admitted that in studying the differentiation of the cell wall the botanist received valuable aid from the chemist, and research in this direction probably began with Payen's discovery that the characteristic and primary chemical constituent of the cell wall is a carbohydrate which he termed cellulose. This is only one of numerous instances of appreciation; but it is to the slow accumulation of isolated chemical facts such as this, that we may hope to arrive at more definite conclusions as to the chemical reactions by which pronounced anabolic changes are brought about, and the directions in which the substances thus formed are utilised.

Darwin was evidently convinced that chemical conditions influence greatly the growth and characterisation of plants, because in the first chapter of the *Origin of Species* he writes:—"such facts as the complex and extraordinary out-growths which variably follow from the insertion of a minute drop of poison by a gall producing insect, show us what singular modifications might result in the case of plants from a chemical change in the nature of the sap."

It would be possible, of course, to multiply references of a similar nature, but these are sufficient to indicate the opinions of workers generally on the effect of chemical influences in the establishment of natural floras.

In dealing with genera of economic importance it is, of course, the utilitarian side of the question which dominates,



and commercial progress must be advantaged when proper value is attached to the results of chemical work, if this is able to supply the evidence required. Morphological characters are not always sufficiently distinctive to enable important differences to be determined, and with certain genera discrimination is difficult between species the botanical features of which have very much in common. For instance, one species may yield in quantity a substance which has, or may have, considerable economic importance, while another species, thought perhaps by some to be identical with it, has no economic possibilities in a similar direction. If these distinctive peculiarities are eventually found to be definite throughout the whole extent of the distribution of the species, then such a constancy of specific character, in this direction, is shown, that it becomes desirable to investigate more deeply the morphological and other features, so that these may be arranged in agreement with the combined botanical and chemical evidence. When examined under such a suggestion it may be expected that differences which originally appeared not to be particularly worthy of notice for specific purposes, would become well defined characteristics, and thus allow discrimination between them to be easily made. Such has been our experiences during the investigations, so far undertaken with the *Melaleucas*, the *Callitris* and the *Eucalypts*.

*Melaleuca genistifolia* and its allied species will furnish one illustration in support. *M. genistifolia* was first described by Dr. Smith in 1776. In 1858 Baron von Mueller named a species *M. bracteata*, which tree has botanical characters somewhat closely resembling *M. genistifolia*. Bentham certainly thought so, because in the *Flora Australiensis* he there synonymised them. The chemical evidence is conclusive that the two trees are quite distinct, so much so, that all doubts are now set at rest, and the

botanical differences which Mueller saw are now shown to be distinctive. The essential oils obtained from the leaves by steam distillation are alone sufficient for the purpose, as these are distinctly different in the two trees, that from *M. genistifolia* has no possible commercial value, as it consists very largely of pinene, between 80 and 90 per cent. of the oil being that constituent, and it does not appear to contain in any degree the characteristic constituent of the oil of the other species. The oil of *M. bracteata* consists very largely of methyl-eugenol—a constituent heavier than water—while the very small amount of terpene present is phellandrene. The oil also contains a small amount of an ester of cinnamic acid, a little cinnamic aldehyde, and some eugenol. None of these constituents occur in the oil of *M. genistifolia*. Surely these two plants must be distinct. The yield from *M. bracteata* is about one per cent., so that it produces an oil containing methyl-eugenol in larger amount than is obtainable from the leaves of any other known plant. Since the first results were published the Technological Museum has received material of *M. bracteata* from Kinbombi in Queensland, hundreds of miles from the previous locality. The oil from this material was identical in character with that from New South Wales, showing the constant nature of this chemical character. If the time ever came when it might be desirable to cultivate *M. bracteata* for its oil, it would not do to substitute *M. genistifolia*, the closely agreeing botanical characters notwithstanding.

The correct position of *M. trichostachya* with that of *M. linariifolia* has also been decided in a similar manner. The leaf oil of *M. trichostachya* is rich in cineol and the species may thus eventually be of some commercial importance, but *M. linariifolia* has no economic value in a like direction.

Differences of a like nature are even more strongly emphasised with the several species agreeing somewhat in botanical features with *M. leucadendron*.

When these chemical characters have been definitely determined, botanical differences often appear more distinctly marked, so that specific features are not likely to be again mistaken.

The acceptance of such economic influence towards discrimination does not in any way detract from the value of specialisation in the higher branches of botanical science, for indeed it must rather be considered as helpful, suggesting perhaps the existence of peculiar conditions, in certain directions, which previously were indifferently noticed or not understood.

A scientific discovery often has immediately a commercial value, but while the latter is, from a scientific point of view, subordinate to the former, yet, the study from the economic side often gives the necessary stimulus to effort, and promotes activity in the endeavour to solve the more scientific problems, often with the idea that the result may ultimately be of monetary value. Many of the facts of theoretical science have been the outcome of economic work, and have often been suggested from the practical side. This suggestion has been demonstrated over and over again during the remarkable progress which has taken place in specialised organic chemistry during the last fifty years, and many of the laws governing constitution and construction of organic compounds have been the outcome of effort directed by economic considerations. Is it not then to be expected that chemical laws governing the growth of, and the formation of plant constituents, as well as those which lead to special peculiarities, will be discovered in a similar way, when economic considerations require that the subject shall be studied with that care,

skill and perseverance which have made modern organic chemistry such a splendid consummation?

It is, perhaps, to be regretted that the prosecution of pure science, in many directions, is now so largely dependent upon the commercial aspect, and that the idea of carrying on scientific work for the pure love of it, regardless of all monetary considerations, is so rapidly becoming obsolete. But nevertheless whatever may be the stimulus to scientific effort the results are the same, and all tend, in one direction or another, to the betterment of human conditions.

In Australia the circumstances are such that the tendency is to devote larger effort to the investigation and discrimination of economic material; but even so, the opportunity for deeper study is also present, and it is desirable that the relations of trees to their environment, the influences which have enabled certain forms to survive adverse conditions, the development of species and distribution of particular genera, and the reasons for predominance of certain structural characters, so pronounced throughout the members of some groups, should be more deeply investigated. It is upon the results of experimental work that we may hope to establish these broader generalisations, and in this direction those from chemical research would be perhaps the most helpful. The discrimination between species alone, if this be the object of the work, may be considered as the least valuable of all these investigations, as such decisions, when so restricted, do not enable us to understand the general causes which have been responsible for generic structural differences.

The work so far carried out in this way with the *Callitris* of Australia has added to the knowledge of the general characters of the group, and this result was largely made possible by the co-ordination of the results of both botanical and chemical investigations. The peculiarities of the genus

were thus more completely indicated, and the contemporaneous alterations, both in botanical features and chemical constituents, could thus be followed throughout the series.

In the foliage of *Callitris* spp. the secretion of essential oil takes place in one or more pockets hidden in the summit towards the free ends of the adnate decurrent leaves, and in the numerous sections observed the secretion glands show no passage to the outer air. It thus appears that with the *Callitris* there is no exhalation of the essential oil product, this apparently being utilised by the plant in other ways. Although the oil constituents vary considerably in the various species, yet, these are comparatively constant for each, and it does not matter how extensive is their natural geographical distribution the results are the same. The yield of oil for each species is also fairly constant, indicating also a uniformity in secretion. The formation of the alcohols borneol and geraniol in the oils of the *Callitris* is also in a uniform direction. In those species which, perhaps, constitute the oldest members of the genus now living in Australia, the greater portion of the ester consists of bornyl-acetate, but as the genus evolved, the latter ester increased in amount until in the oils of certain species growing on the extreme eastern portion of the continent, and in Tasmania, it had entirely supplanted the bornyl-acetate, and at the same time had increased in percentage amount. By analysis it was possible to follow the diminution of the one ester, and the corresponding increase of the other, and also to show that when the bornyl-acetate had been quite supplanted that the free alcohol was entirely geraniol. As the chemical characters changed the botanical features altered in agreement.

The comparative constancy of individual species, in both botanical and chemical directions, is so definite that there is little fear that subsequent investigations will upset con-

clusions based on evidence of this nature, but rather that further study will demonstrate more completely the indications of divergence so obtained.

Whatever may be the object of the plant in the formation of these particular essential oil constituents, it seems evident that definite lines of molecular arrangement are followed, and it is possible that the formation of these characteristic constituents is a part of the economy of the plant, leading to the completion of the metabolic processes of the particular species in which they occur. It thus appears that the influences directing the formation of these chemical products are practically constant, even under diverse conditions of natural growth, so that the products thus formed have a discriminative value and bear a constant relation to other structural characteristics of the plant. This chemical feature thus becomes really of morphological value, as much perhaps as either a fruit or a bud, although the identification is more subtle, and it is of course, less easily available for observation.

It would be well if the chemical characters of the closely related genera of Africa, *Tetraclinis* of the north, and *Widdringtonia* of the south, were determined so that the origin and method of distribution of these, together with *Callitris*, might be more satisfactorily followed.

Dr. Henry has shown that the sandarac resins of *Callitris* and of *Tetraclinis* are similar, but more complete investigation with the exudations of all the species of the three genera would probably show a gradation in the percentage amounts of the chief resin acids or resinoids, the arrangement of which in proper sequence—together with the determination of their leaf oil constituents—would probably assist greatly their classification. The leaf oils of *Tetraclinis* and of *Widdringtonia* have not so far been chemically determined, so that comparison in this direction with those

of *Callitris* cannot yet be made. The knowledge of the identity of the predominant terpene in these African oils, together with that of the composition of their esters, whether bornyl- or geranyl-acetates, would probably assist towards suggesting a theory to account for the territorial distribution of the three genera. That they are very old seems conclusive, and that they were originally distributed over land connections now no longer in evidence seems also a reasonable conclusion.

Professor Saxton, from his studies with *Tetraclinis*, recently published in the Annals of Botany, thinks that the southern sub-family *Callitroideæ* were derived from the essentially northern sub-family *Cupressoideæ*, and from the available evidence suggests the former existence of a great Antarctic continent with a land connection between Southern Africa and southern Australia.

It will probably be found that pinene was the earliest terpene in the leaf oils of these sections of the Conifereæ, and that the other terpenes and oxygen bearing compounds developed later. Such a result would be in agreement with those already obtained with some other large and ancient genera.

The most important result so far derived from the phytochemical studies with the genus *Eucalyptus*, and the closely related genus *Angophora*, is, perhaps, the intimate connection shown to exist between the leaf venations of the mature lanceolate leaves of the several species and their essential oil constituents. This striking correlation enabled suggestions to be formulated, particularly in respect to *Eucalyptus* species with closely agreeing characters, which when followed up led to a more intimate acquaintance with the genus, and, perhaps, has also been the means of stimulating research by workers in other directions, with very gratifying results. This frequently recurring agreement

between the salient points, both botanically and chemically, appeared to point to important functional characteristics, so that it has been possible to suggest, with perhaps more than a degree of probability, the line of descent followed during the evolution of this most extensive Australian genus.

The comparative constancy of chemical constituents in the products of individual species—essential oil, astringent exudation, tannin, etc., suggests the idea that each species acts as if it were a chemical factory, manufacturing particular chemical constituents, under natural conditions, according to a specific formula. What these conditions of formation are it should be our endeavour to determine. It does not matter how extensive the distribution of the species, the chemical constituents are still in agreement, and this has been found to be the case with members of the same species growing both in Tasmania and on the mainland, districts hundreds of miles apart. These agreeing results seem to suggest that the establishment of the species itself is largely governed by the chemical requirements of the tree, particularly in its earlier stages. If the conditions of growth still remain in conformity with original factors the species continue, generation after generation to repeat, in every detail, both the botanical and chemical features characteristic of the tree. This has been well demonstrated with several *Eucalyptus* species common to both Australia and Tasmania, which were evidently quite definitely fixed long before Tasmania was separated from the mainland, a period sufficiently long for some species peculiar to the island to have definitely established themselves. Available evidence also indicates that a few species have found conditions of separation not so congenial, the struggle to overcome certain adverse conditions having brought about changes not difficult to trace. Here we



have, now proceeding, perhaps, evidences of the influences which in the dim past have largely been responsible for the original establishment of the numerous species and groups of the genus, which have thus become not only divergent but progressive.

It seems then not unreasonable to consider that if sufficient time were allowed for the completion of the changes now proceeding that the several groups of the genus *Eucalyptus*, as we know them to-day, would eventually establish themselves as new genera of the *Myrtaceæ*.

Hooker, in his *Flora of Tasmania*, evidently felt a difficulty in discrimination, because, when writing from the botanical standpoint, he says, "that it is much easier to see peculiarities than to appreciate resemblances, and that important general characters which pervade all the members of a family or flora are too often overlooked or undervalued."

To assist in the endeavour to attach their true value to these important general characters of the genus *Eucalyptus* is, I am sure, the ambition of all workers upon these scientifically interesting and economically valuable trees.

The genus *Angophora* furnishes considerable evidence, both botanically and chemically, in the direction of showing that the *Corymboseæ* is perhaps, the oldest of the many groups into which the genus *Eucalyptus* divides itself. The venation of the mature lanceolate leaves is the same, the chemical constituents of the essential oils are similar, the exudations are in agreement, and the general morphological features have strong resemblances, excepting, of course, the important character of the *Eucalypts*, the operculum.

The genus *Angophora* is probably a very old and perhaps a decaying one, and originally may have had a much more extensive distribution in Australia. It does not appear to have had the power to adapt itself generally to the changing

conditions of soil and climate in the same way that *Eucalyptus* had, and this is illustrated by the fact that the leaf oils of the *Angophoras* are all practically identical in composition, while the exudations of the species are also similar. The principal terpene in these oils is pinene, and this has an identical specific rotation in all the species, a constancy so very different from that found in *Eucalyptus*. The ester is geranyl-acetate and this also occurs in very many species of *Eucalyptus*, reaching a maximum in *E. Macarthuri*.

These results taken together seem to indicate that the constituents of the oils of the earlier members of the genus *Eucalyptus* had their origin in those of the genus *Angophora* if not in a still older one.

From the *Corymboseæ* group the genus *Eucalyptus* evolved in various directions, and to enable the conditions adverse to distribution to be overcome, both the botanical features and chemical characters underwent considerable changes. The mature lanceolate leaves altered considerably the disposition of their veins, denoting eventually the presence of eucalyptol (cineol) in their oils, or of that of the terpene phellandrene in those of the more recent species. The form and structure of their anthers and of their seedlings changed in agreement. The appearance of their barks became more diverse, and distinct groups were established considered on a cortical classification; while the texture, hardness and general characters of the woods of the several groups varied considerably. The tannins and astringent exudations are also shown to have been correspondingly under the influences of the factors which were instrumental in bringing about changes in the genus; constituents characteristic of the exudations of earlier members continue for a time and then are found no more, while even the tannin in the members of the later groups is not the same substance as that in the earlier.

These distinctive changes, which can now be somewhat readily followed, suggest the evolutionary formation of the several species and groups. The extended period which must have elapsed before the species succeeded in reaching such definiteness in general features, indicates also a considerable age for the genus, and suggests the probability that these changes have been by slow and almost imperceptible stages.

The evidences which have so far accumulated appear to point to chemical influences being largely the direct cause of these distinctive changes, and our knowledge of the groups would be greatly advanced if it were possible to discover the mechanism of these chemical reactions. That they are physiological in effect is evident, and it is to the results of extended study in this branch of science that we may hope to understand more and more those complex chemical reactions, ever at work building up distinct organic material from very simple substances.

The results of Plant Metabolism are, perhaps, more often considered as directly traceable to the effects of organic influences, than to those in which inorganic constituents appear to play a more important part. It may even be suggested that the deeper consideration of these latter processes has so far been neglected; certainly this is so in comparison with those studies carried out from the strictly organic side. It is generally recognised, however, that the available food of plants is intimately associated with the presence of certain elements, and metabolism does not appear to be able to proceed satisfactorily without their assistance.

The methods whereby these inorganic elements—often present in most minute quantities—are able to assist in the synthetic production of these complex organic bodies are certainly not understood, and the presence of manganese

for instance, in small amounts in all the species of *Callitris* and *Eucalyptus* growing in Australia, does not suggest that this element, at all events, is there by accident. If it were possible to follow this substance through all its ramifications in the tree it would probably be found to be in unstable association, and a necessary factor in the production of more stable substances, if not even largely responsible for the very existence of the plant itself.

Professor Bertrand, in an address before the International Congress of Applied Chemistry, discussed the role played by traces only of chemical substances in biological chemistry. He pointed out that besides the three or four elements which it is generally recognised go to form plant substances, there may be more than thirty other elements which may be detected in the plant in minute proportions, even to less than one 100,000th of the plant's weight, but which play an important part in the life of the plant and in its development. As will be shown later with certain of the Eucalypts this minuteness may extend to less than one in a million parts of anhydrous timber.

It may be that the correct application of these minute quantities of mineral substances, which probably act as catalysts, would result in enormous economic advantages in production, and lead to increased formation in the plant of what at present are but rare and costly commodities.

The discovery of radium and its influences on plant growth has stimulated enquiry in corresponding directions, and Stocklasa has shown that both uranium and lead nitrates, in small proportions, definitely augment vegetable growth and production, although having less influence than radium itself. The literature in regard to this subject of inorganic influence on plants is now somewhat extensive, from a perusal of which it may be seen that a considerable number of the so-called rarer elements have at one time or another

been detected as occurring in plants, as well as minute quantities of such common elements as copper, zinc, barium, etc. In one species of Eucalyptus copper was detected; this was found in the ash of the timber of the "Ironbark" *E. sideroxylon*, growing at Condobolin, and was separated in the metallic form. The general map published by the Mines Department does not include Condobolin in the cupriferous districts of New South Wales, but there is now no doubt but that copper does occur in that district as indicated by this Eucalyptus.<sup>1</sup>

The repeated occurrence of manganese in the ash of the wood of the Australian *Callitris* led to an extended study as to position, and it was found that this element occurs in all parts of the plant; seeds, seed cases, leaves, bark, as well as in the timber, but always in minute proportion. As the manganese is found in the ashes of all the species of *Callitris* it is reasonable to suppose that its presence is essential to the satisfactory growth of these trees, and is perhaps, as important in this connection as either potassium or phosphorus.

These results with the *Callitris* led to further inquiry in the same direction with the other extensive Australian genus—Eucalyptus. So far as investigation has proceeded it is shown that manganese is also a constant constituent in the ash of all the species of this genus, and further, that there is a remarkable uniformity between the percentage amounts of manganese in the ash of the several species belonging to the same group, and that this is irrespective of the location where the trees grow, even if these are hundreds of miles apart. It appears, therefore, that the uniformity in the amounts of this necessary food material, taken in conjunction, perhaps, with other ash constituents,

---

<sup>1</sup> Since the above was written Mr. Cambage informs me that leases have been granted near Condobolin to the north, for working copper, etc., indicated in Map Sheet 9 of the Mining Districts of New South Wales.

may be connected in some way with the original establishment of the particular form and structure of the distinctive features which are characteristic of the species or group.

The amount of manganese in the ashes of the timbers of all the species of the "Ironbarks" tested was in remarkable agreement, ranging from 1.5 per cent. in those of *E. crebra* and *E. melanophloia* to 1.15 per cent. in that of *E. sideroxylon*. If the presence of this element were an accident due to location of growth then there could not be this uniformity in percentage amount, and the presence of manganese in the soil in varying quantities may be thus a contributing factor to the distribution of these particular species. It is apparent, however, that manganese is a very widely distributed substance, for besides being found in all species of *Callitris* it most probably occurs in every species of *Eucalyptus*, and members of this genus extend over the greater portion of Australia.

Those *Eucalyptus* trees which grow on the higher and poorer lands appear to contain less manganese in their ash than those which require a soil richer in ordinary mineral plant food, and this again may account somewhat for the position where certain *Eucalyptus* species grow.

This question of the natural distribution of the *Eucalypts* is one which has had particular interest for scientists for a long time. It may be, however, that species location is more largely due to chemical influences, and as our knowledge extends in this direction it may be possible to give, eventually, a satisfactory explanation as to why certain species of *Eucalyptus*, under natural conditions, grow luxuriantly in one place but not in another.

Mr. Cambage in his Presidential Address of last year brought forward considerable data, which added to our knowledge regarding this question of *Eucalyptus* distribution, and directed attention to the influences certain soils appear to have on the location of members of the genus.

Dr. Cuthbert Hall informs me that he has experienced great difficulty with the seedlings of *E. fastigata*, *E. dextropinea*, and a few other species, and that he has been unable to grow the seedlings of these species beyond the second leaf stage, as with a very few exceptions they then all died, the soil apparently not being suitable.

It is not possible, of course, to know the real extent of these influences until the chemistry of the species in its relation to the soil, on which it grows naturally, shall have been fully determined. Although the soil and its constituents exert the chief influences upon the natural distribution of species, yet, altitude or climate, seems to be a contributing factor also. The conditions directing these influences are, however, at present very imperfectly understood, and it may be that one set of factors is the corollary of the other, both acting along parallel lines.

The marked differences in the characters and amounts of inorganic constituents which appear to be necessary to the natural growth of the different species, or rather groups of Eucalypts, arrests one's attention; particularly when it is seen that there is roughly a relative constancy in requirements with certain elements with the members of each group. This unconformity in mineral constituents with species belonging to different groups, but growing in close proximity to each other, seems to indicate that the solvent action of the roots of the several species is not of a uniform character, or else that certain of the mineral substances dissolved have a poisonous action upon some species, although necessary to the growth of others. Magnesium appears to be a necessary constituent for the growth of all species of Eucalyptus, and is one of the principal mineral constituents in the ashes of some of them. On the other hand calcium does not seem to be in such demand by the members of certain groups, although it is found in great

quantity in the ashes of species belonging to some others, particularly those of the typical "Boxes," (See Table II). Phosphorus is always present, although in certain species or groups it is in comparatively small amount, while in the ashes of all the "Stringybarks" and allied groups alumina was always detected, as well as a small amount of iron. Potassium was, of course, always present, although very small in amount in some species, as well as varying quantities of sulphur, and in some cases chlorine and sodium. The alkalis are more pronounced in the ashes of those species in which calcium is less abundant, and the largest percentages of phosphorus are found there also.

A considerable number of Eucalypts, particularly those belonging to the groups in which calcium is a pronounced constituent, construct oxalic acid as one of the products of metabolism. In some species the oxalic acid is often produced in such abundance that in some cases as much as one-sixth of the air dried bark consists eventually of calcium oxalate. These species, however, are usually of small size, often occurring in the shrubby or "Mallee" form. It is hardly to be supposed that such Eucalypts would live long enough to enable them to grow into very large trees, so that the largest Eucalypts of Australia can hardly belong to groups the members of which are subjected to such adverse chemical influences. The gigantic Eucalyptus trees of this continent, as, for instance, those belonging to such species as *E. regnans*, *E. pilularis*, *E. Delegatensis*, *E. obliqua*, etc., only use calcium in comparatively small quantities, while magnesium is an important mineral constituent in these trees. Species belonging to such groups do not, under ordinary circumstances, form oxalic acid in excess, nor other poisonous constituent, so that it is not unreasonable to assume, that under the most favourable conditions these Eucalypts could continue to construct their woody tissue for thousands of years. That these



species are, however, easily susceptible to the effect of constructive poisons is indicated by the destructive effects of *Loranthus* when this parasite takes possession. A few years ago some fine trees of "Blackbutt" *E. pilularis* were growing in the neighbourhood of the Marrickville Railway Station. They became badly infected by the "Mistletoe" *Loranthus* sp., and after a time first one and then another died, until all were eventually destroyed. This result is, in certain localities, not an uncommon occurrence with the Eucalypts.

It is, perhaps, largely due to the composition of the soil upon which these little ash-giving species choose to grow, and the comparatively small amount of the necessary mineral food available in like situations, that these particular Eucalypts have acquired the power of almost dispensing with the necessity of storing mineral material in the trunk of the tree, perhaps with the object of not depriving the leaf portion of the required mineral food supply. It can be readily calculated how large an amount of mineral matter would be stowed away in the trunks of these enormous Eucalyptus trees, if the percentage was as large as that found in the timbers of the smaller trees of some other groups. The giant trees of *E. regnans* growing in the Gippsland Ranges of Victoria are cases in point. These trees are sometimes over 70 feet in circumference, and nearly 400 feet in height. A sample of the timber from a smaller tree of this species from near Warburton in Victoria gave only 0.054 per cent. of ash, calculated on the anhydrous wood, so that a ton of this wood, when freed from moisture, only contained one pound three ounces of mineral substances. This result is quite in agreement with the ash contents of the timbers of other species belonging to this and closely associated groups, so that it may be assumed, from these data, that the largest trees of this species of Eucalyptus only store up mineral matter in their

timbers to the extent of about one pound to 2,000 pounds of anhydrous wood. Taking the percentage result of mineral substances as determined in the ash of *E. regnans* as fairly representative, it will be seen, from the figures tabulated further on, that the amount of lime (CaO) in the timbers of these big trees would only be about one 15,000th part of the weight of the timber when calculated free from moisture. Although the amount of magnesia (MgO) is somewhat greater, yet, even this constituent only represents about one 10,000th part of the weight of the anhydrous wood.

It has been stated previously that manganese is a constant constituent in the Eucalypts generally, and it thus appears to be essential to the growth of these trees. The amount of manganese in the ash of the timber of *E. regnans* was only 0.274 per cent., so that this element only represents one part in 676,000 parts of the anhydrous wood. The leaves of *E. regnans*, however, gave 2.85 per cent. of ash, this being in agreement with the amount obtained with the leaves of allied species.

A Eucalyptus which often grows to a very large size in Eastern Australia is the "Blackbutt" *E. pilularis*. One of the local sights at Bulli in New South Wales is the big tree of this species which is growing near that place. It has a circumference of 59 feet, and is about 280 feet high. It is not difficult to suggest the distribution of mineral constituents in this tree also, as considerable data have been obtained from the timbers, as well as other portions of representative trees of this species. This material was collected from trees growing at the following widely distributed localities, Ashfield, Thirlmere, Ulladulla, North Coast New South Wales, and Marrickville (two specimens). This species has been chosen for more extended investigation because it is a good representative Eucalypt in New

South Wales, and complete material could readily be obtained in the immediate neighbourhood of Sydney, although any other closely related species would, no doubt have served the purpose as well. The comparative constancy of the results with the mineral constituents in this species is remarkable, and it is evident that some directing influence must be responsible for this similarity in amount of mineral contents of trees of one species growing at localities so far apart.

The highest ash content in the timbers of this species tested was 0·088 per cent. of the anhydrous wood. This was obtained from a tree growing at Marrickville (tree No. 1). The lowest amount was 0·029 per cent. from a commercial specimen from the North Coast, the next being 0·037 per cent. from another Marrickville specimen (tree No. 2). The mean of the six samples from the above localities was 0·0518 per cent. of ash, or one ton of the timber of this species would only contain about 1 lb. 2½ ounces of mineral matter. From these agreeing results it may be expected that the big tree of *E. pilularis* above mentioned will also be in agreement, and that the anhydrous wood of its trunk probably only contains about one 15,000th part by weight of lime (CaO) and one 30,000th part of magnesia (MgO), while the manganese will only represent one part in about 900,000 parts by weight of the timber.

It seems difficult to understand in what manner such minute portions of mineral substances could assist construction, if not largely catalytic. The results with two distinct trees of *E. pilularis* growing on the sandstone formation at Marrickville show, however, that trees which contain only about 0·05 per cent. of total ash in the wood have almost 3 per cent. of mineral matter in their leaves, while the buds and petioles contain about 3·8 per cent. The constituents of the ash of the leaves are in much the same

ratio as in that of the wood, but the total quantity is nearly 60 times as much. The manganese is also in larger amount in the ash of the leaves. The two specimens of *E. pilularis* from Marrickville were both in good condition and perfectly sound. No. 1 was growing at the foot of the sandstone cliffs, the other (No. 2) on the top of the hill beyond Cook's River. The manganese might thus be more readily available to No. 1, owing to its position of growth, than to the other. The results suggest that this is so, because the manganese is consistent in this direction with all parts of the trees. The top of the sandstone hills around Sydney could hardly be more unpromising for the presence of manganese, yet, the Eucalypts manage to find and use it.

The results here tabulated are too uniform in character to permit the assumption that the minute quantities of manganese are not essential to successful growth. The closely agreeing percentages of manganese in the ashes of all the timbers of *E. pilularis* tested, are of such a nature that the idea of accidental inclusion can hardly be admitted.

The uniformity which is shown to exist between the ash contents of the leaves and buds, as well as in that of the timbers of *E. pilularis*, and other species, indicate that these amounts can hardly be accidental, and the whole arrangement may be looked upon as nature's method for making the most of the available mineral food supplies. The leaves would naturally fall to the ground in time, so that the mineral substances they contain would be again available for use, but if the same percentage amount had been stored in the woody portions of trees, which might, perhaps, live on for thousands of years, too large an amount of the limited supply would have been withdrawn, and this would naturally lead to exhaustion. It may, therefore, be considered that the small amount of ash in the timber of those groups associated with *E. pilularis* is the least

possible upon which these trees can continue to live and thrive. What necessary function the inorganic matter plays in the development of cellulose, as well as in other natural colloidal substances is not known, but that it is incidental to the vital processes of the plant can hardly be doubted. More complete and extended studies in colloidal chemistry, and a knowledge of the influences exerted by the enzymes, or organic catalysts, when considered with those of inorganic origin, would, no doubt, do much to solve many of the problems so closely connected with the phenomena of vegetable life.

The table (No. 1) gives the percentages and parts of ash and manganese in the portions of the trees treated. The species include representatives of the several groups into which the genus *Eucalyptus* naturally divides itself. The results show that the inorganic portions of the groups of trees are somewhat constant in character, and agree closely in this respect with the organic chemical constituents of the various species of *Eucalyptus*. Perhaps it is for this reason that the organic chemical characters are of such a constant nature.

It will be observed that the similarity existing between the members of the "Ironbark" group, for instance, and between those of the "Boxes" is not peculiar, and that the two "Stringybarks," *E. macrorrhyncha* and *E. eugenioides* also show agreeing results, while *E. obliqua* is more in conformity with *E. Delegatensis* and *E. regnans*, this being in agreement with the botanical evidence. *E. botryoides* is also shown to differ somewhat from *E. saligna*, while the two "Peppermints" *E. amygdalina* and *E. dives* are in accord. The figures also indicate that of the "Ironbarks," *E. crebra* would prefer to grow on land less rich in available basic mineral food material than would appear to be necessary for some of the other members of this group.

*E. sideroxylon* approaches *E. crebra* in this respect while *E. paniculata* would appear to require good land similar to that chosen by the members of the "Box" group. The presence of manganese in the soil is essential for all, and it may appear remarkable perhaps that no matter whether the percentages of the total mineral substances in the timbers of the "Ironbarks" be great or small the percentage of manganese in the ash is practically the same with all of them. The indication is that the "Boxes" also, as well as the other groups will also show agreement in this respect when complete data shall be available.

Table No. I.

	Percentage of Ash in anhydrous material.	Percentage of Manganese in ash	One part of ash in parts anhydrous material	One part of Mn in parts ash	One part Manganese in parts anhydrous material
<i>E. pilularis</i>					
(wood) Thirlmere ...	0.051	0.200	1960	500	980,000
„ Ashfield ...	0.065	0.200	1538	500	769,000
„ Ulladulla ...	0.041	0.260	2438	385	938,630
„ North Coast	0.029	0.210	3448	476	1,641,248
„ Marrickville					
No. 1 tree	0.088	0.220	1136	455	516,880
No. 2 tree	0.037	0.200	2703	500	1,351,500
Mean of above calculated from the ash and manganese percentages.	0.0518	0.215	1930	465	897,450
<i>E. pilularis</i>					
(leaves) Marrickville					
No. 1 tree	2.91	1.5	34	67	2,278
No. 2 tree	2.69	0.25	37	400	14,800
(buds with petioles)					
No. 1 tree	3.79	1.33	26	75	1,950
No. 2 tree	3.786	0.233	26	430	11,180
(seed cases = fruits)					
No. 2 tree	2.893	0.15	35	667	23,345
(seeds) No. 2 tree ...	1.044	0.316	96	317	30,432
<i>E. regnans</i>					
(wood) Warburton,	0.054	0.274	1852	365	675,980
Victoria					
(leaves) ditto	2.851	0.666	35	150	5,250
<i>E. macrorrhyncha</i>					
(wood) Woodlands	0.072	0.733	1390	136	189,040

Table No. I—continued.

	Percentage of Ash in anhydrous material.	Percentage of Manganese in ash	One part of ash in parts anhydrous material.	One part of Mn in parts ash.	One part Manganese in parts anhydrous material.
<i>E. eugenoides</i> (wood) Ilford ...	0.075	0.766	1333	130	173,290
<i>E. obliqua</i> (wood) Monga ...	0.025	0.22	4000	455	1,820,000
<i>E. Delegatensis</i> (wood) Laurel Hill	0.038	0.30	2632	333	876,456
<i>E. amygdalina</i> (wood) Moss Vale...	0.033	0.666	3030	150	454,500
(leaves) Braidwood	3.852	0.633	26	158	4,108
<i>E. dives</i> (wood) Rydal	0.059	0.50	1695	200	339,000
<i>E. botryoides</i> (wood) Belmore ...	0.152	0.833	658	120	78,960
„ Milton ...	0.132	0.60	758	166	125,828
<i>E. saligna</i> (wood) Newcastle ...	0.08	0.60	1250	166	207,500
„ commercial sample	0.045	0.733	2222	136	302,192
<i>E. goniocalyx</i> (wood) Delegate R.	0.137	0.333	730	300	219,000
<i>E. maculata</i> (wood) Cooloongolook	1.56	0.76	64	132	8,448
<i>E. Smithii</i> (wood) Hill Top ...	0.482	0.90	208	111	23,088
<i>E. hemiphloia</i> (wood) Belmore ...	1.79	0.25	56	400	22,400
<i>E. Woollsiana</i> (wood) Cobar ...	0.716	0.50	140	200	28,000
<i>E. albens</i> (wood) Grenfell ...	0.476	0.50	202	200	40,400
<i>E. melliodora</i> (wood) Colombo ...	0.552	0.583	181	171	30,951
<i>E. viminalis</i> (wood) Tasmania ...	0.161	0.833	621	120	74,520
„ Black Mounth	0.418	0.566	239	177	42,303
<i>E. microcorys</i> (wood) Dunoon ...	0.582	0.20	172	500	86,000
<i>E. paniculata</i> (wood) Newcastle ...	0.477	1.40	210	71	14,910
„ Stroud ...	0.348	1.33	288	75	21,600
<i>E. siderophloia</i> (wood) Thirlmere ...	0.170	1.25	588	80	47,040
<i>E. melanophloia</i> (wood) Narrabri ...	0.172	1.50	582	67	38,994
<i>E. sideroxylon</i> (wood) Condobolin	0.072	1.15	1390	87	120,930
<i>E. crebra</i> (wood) Thirlmere ...	0.060	1.50	1667	67	111,689

The Table No. II gives the percentages of phosphoric acid, lime, and magnesia, in the ashes of a few representative species of distinct groups of Eucalypts. It was a difficult matter to completely burn the woods of the little-lime-containing species, like *E. macrorrhyncha*, *E. pilularis*, etc., as the ash was so readily fusible, this being due to the large amount of potash and other alkalis present. It might be thought, therefore, that these species would produce an abundance of potassium carbonate when burned, but unfortunately the total mineral contents in their timbers is remarkably small, as can be seen from Table I. With the "Boxes" the ash is almost entirely lime, with little magnesia, and there seems to be a remarkable agreement in this respect with species of the several groups which have closely agreeing botanical characters. It is in the members of this group, particularly the species which contain the aldehyde aromadendral in their oils, that the greatest amount of oxalic acid seems to be formed, so that the abundance of lime in these trees may be necessary to combine with the excess of this acid. The alkalis in this group appear to be just as small in amount as the lime is abundant; in the ash of *E. albens* the potash (as  $K_2O$ ) was 1.64 per cent., and this represented practically the whole of the alkalis present. It is thus not feasible to obtain potassium carbonate in quantity by burning the timbers of this group of Eucalypts. With the "Ironbarks" the lime is still in considerable amount, and the magnesia relatively increasing. The alkalis in this group, although greater in amount than in the "Boxes," do not appear to much exceed 25 per cent. of the total mineral constituents. The amount of magnesia in the ash-like timbers of *E. Delegatensis* and *E. regnans* is remarkable, even exceeding the lime in this respect, and the lime and magnesia taken together represent—as carbonates—about three-fourths of the entire mineral constituents of these trees, consequently the alkalis



are comparatively small in this group also. This fact, taken together with the small ash yield, renders the timbers of these species of little use for the production of potassium carbonate. A greater amount of potassium could, of course, be obtained from the leaves of the more pronounced alkali-bearing species.

The data given in these tables suggest somewhat strongly the direction of chemical influences governing the natural distribution of the several species of the groups of this most extensive genus.

Table No. II.

		Percentage in Ash. (P <sub>2</sub> O <sub>5</sub> )	Percentage in Ash. (CaO)	Percentage in Ash. (MgO)
"Boxes"	{ <i>E. hemiphloia</i> (wood) ...	0.49	52.42	1.40
	{ <i>E. albens</i> (wood) ...	0.74	50.20	2.87
"Ironbarks"	{ <i>E. siderophloia</i> (wood) ...	1.58	31.14	6.55
	{ <i>E. paniculata</i> (wood) ...	1.64	28.12	7.29
"Ashes "	{ <i>E. Delegatensis</i> (wood) ...	1.50	19.50	23.42
	{ <i>E. regnans</i> (wood) ...	1.96	12.73	20.10
"Blackbutt"	{ <i>E. pilularis</i> , Ashfield (wood)	1.92	18.9	6.65
	{ do. mixed species (wood)	1.80	14.2	6.10
	{ do. No. 1 tree (leaves)	1.49	11.0	13.60
"Stringybarks"	{ <i>E. macrorrhyncha</i> (wood)	1.61	10.13	7.79
	{ <i>E. eugenioides</i> (wood) ...	1.41	11.23	6.30

The time at my disposal only permitted the investigation of a limited number of species of Eucalypts, in fact it was only possible to touch the fringe of this important question concerning the mineral food requirements of the members of the several groups of this great genus, but sufficient has been done to demonstrate somewhat clearly that great advantage to Australia would be likely to accrue from more complete and extended studies on this group of trees.

The natural vegetation of this continent represents one of its chief assets, and cannot be neglected without detracting from the general prosperity of the people. Considerable portions of the more settled States of Australia still remain available for extended effort in Forestry expansion, and in the State of New South Wales, in June 1912, the area included in Forest Reserves was 7,600,000 acres, although no less than 90,000 acres had been revoked from existing Forest Reserves during the year.

It is not desirable that land eminently suitable for agricultural purposes should be withheld from cultivation, or retained entirely for forestry purposes, although it is possible that by adopting this policy the cultivation of some well known economic species of Eucalyptus may be largely restricted. There are, however, so many other species which furnish timber of excellent quality for constructive works of various kinds, that this is after all a matter of minor importance; these species, too, often grow well upon soil far too poor to allow of its profitable employment in other directions. The land in Australia which is covered with Eucalyptus trees is often of indifferent quality, and to allow the difficulties of distribution to be overcome, Nature devised methods which at present are largely hidden from observation, but with which it is desirable that we should become better acquainted. Not only does this apply to species of particular value as timber trees, but also to those species which furnish products of economic value for various purposes.

Such knowledge can only be obtained by determined effort and by long continued researches in specialised directions.

To overcome the difficulties inherent to scientific investigations in Australia of such national importance, it seems desirable that scientists should be employed for this specific

purpose alone, as it can hardly be expected that such work can proceed with the desired rapidity, or be altogether satisfactory, while the results are dependent upon the efforts of scientific officers whose time is so largely occupied with routine duties. As the results of this work would be of general value to Australia it seems fitting that the Federal authorities should provide the main portion of the funds necessary to carry on such important researches.

The Governments of some of the Australian States are—by the establishment of scholarships and in other ways—already providing money for the furtherance of research. The New South Wales Government in particular has been liberal in this respect, and has provided money for this purpose to be expended at the University and in other directions. But generous as this act may be considered, yet the amount is not sufficient to enable extensive investigations of a national character to be successfully carried out.

One might express a wish that the time is not far distant when those in authority will recognise the advisability of spending money unstintingly to further scientific investigations into the latent possibilities of the unique vegetable resources of this Continent, as well as for researches in other directions. It is hardly possible that too much money can be judiciously spent on researches of this nature, for without doubt, such expenditure would be eventually recouped many times over.

The establishment of Chairs in Organic Chemistry and Botany at the Sydney University, together with the increasing activity in the Organic Chemistry Classes at the Technical College, as well as similar advances made in the other States, will be the means of supplying the trained material from which that band of scientific workers may be recruited; men who by thought and sentiment will be

stimulated to activity in the cause of Australian scientific progress, and whose ambition shall be to assist in the accumulation and arrangement of the scientific facts thus obtained, so that those deeper chemical and physiological reactions underlying the persistence of these natural forms may be brought to light and profitably utilised.

---

## NAPIER COMMEMORATIVE LECTURE.

---

### THE DISCOVERY OF LOGARITHMS BY NAPIER OF MERCHISTON.

By Professor H. S. CARSLAW, Sc.D.

---

*Delivered before the Royal Society of New South Wales at a Special Meeting held on May 21st, 1914, in celebration of the Tercentenary of the publication of the *Mirifici Logarithmorum Canonis Descriptio*.*

---

The subject of our lecture to-night is the Discovery of Logarithms by Napier of Merchiston. This event was announced in his book, *Mirifici Logarithmorum Canonis Descriptio*, published in Edinburgh in 1614. Except for the Canon or Table of Logarithms, it is written in Latin. To quote from the title in the English Edition of 1616, it contains *A Description of the Admirable Table of Logarithmes: with a declaration of the most plentiful, easy and speedy use thereof in both kindes of Trigonometrie as also in all Mathematicall calculations*. This year, in many different countries, the ter-centenary of Napier's great discovery is being celebrated. The Royal Society of New South Wales joins in these celebrations, and I regard it as a great privilege that I have been invited to pay our tribute to the memory of a man whose service to the science

of mathematics, and to all sciences in which complicated numerical calculations form a part, it would be impossible to over-estimate. In Australia of all countries it is peculiarly fitting that this service should be remembered, for there is not a ship which has crossed the 12,000 miles of ocean, separating us from the homeland, that does not owe the happy conclusion of its voyage, at least in part, to the genius and labour of the man whose work we honour this night.

First of all, what manner of man was John Napier of Merchiston. He was the eldest son of Archibald Napier and Janet Bothwell, and was born in 1550 at the seat of his father, the Castle of Merchiston near Edinburgh. On his father's death, he succeeded him as Laird, or, in the language of the time, Baron, of Merchiston,<sup>1</sup> and his son Archibald was raised to the peerage, by the title of Lord Napier in 1627, ten years after John Napier's life had ended. In the annals of our country the house of Napier and Ettrick has a distinguished place.

Of his own life, however, few details are known. Born nearly a century before Newton, to quote the somewhat ambiguous words of his descendant and biographer Mark Napier, "in the most savage age of a barbarous land," the antiquary finds little that will help him to reconstruct the daily life of Napier. A large number of his papers perished in a fire which broke out in the house of one of his descendants; and, so far as the facts of the life go, the biography by Mark Napier, published in 1834, from which we have just quoted, is largely conjecture. He matriculated at the

---

<sup>1</sup> John Napier is often spoken of as Lord Napier, but this is a mistake. He was not a nobleman, but only what would in England be called a lord of the manor. Such persons were formerly designated *barones minores* or lesser barons. In the title page of the *Descriptio* Napier calls himself *Ioannes Neper, Baron Merchistonii*, and in Wright's English translation, approved by the author, John Neper, Baron of Merchiston.

University of St. Andrews at the age of 13: but, even though his student days began thus early, his mind seems to have found its most congenial field of labour in searching out the mysteries of the Apocalypse. According to his own account, it was in his "tender years and barneage in Sanct-Androis at the Schooles," and in connection with political events, that he first turned his mind to this study. Thirty years later, in 1593, he published *A Plaine Discovery of the whole Revelation of St. John*; and, if he were not by that time well-known among the theologians of his day, this work must have established his fame. It had a large circulation, and was translated into Dutch, French, and German. To tell the truth, I have made no effort to make myself acquainted with its contents, even though in the Address to the Godly and Christian Reader he states that he was "constrained of compassion, leauing the Latine, to haste out in English this present worke, almost unripe, that hereby the simple of this *Iland* may be instructed..." It is not in praise of Napier, the theologian, but in honour of Napier, the discoverer of logarithms, that we are met. But if you recollect the period in which he published his views upon these mysteries, and the nature of the disputes in which the theologians of those days found keenest pleasure, you will not be surprised to learn that the *Plaine Discovery* was unlikely to have such free and unrestricted circulation as his later works in the countries over which the Pope and the King of Spain then had jurisdiction.

Even at this period of his life Napier seems to have made some progress towards his great discovery, for we are told on the authority of Kepler, that about this time Tycho Brahe had heard from a Scottish correspondent that a canon, or table, of such aids to computation was in process of construction. Indeed mathematics had long shared with theology the studious hours of Napier. He had done something towards extending the sciences of arithmetic and

algebra; and there is evidence that he possessed a method of extracting roots of any degree. Further it has to be remembered that though the decimal notation for integers had been introduced in the Tenth Century, it had not yet been extended to fractions. Several writers about his time had suggested a new notation for fractions. For example, Stevin, in 1585, wrote

3 ① 7 ② 5 ③ 9 ④ and 8 ⑤ 9 ⑥ 3 ⑦ 7 ⑧

for our  $\cdot 3759$  and  $8\cdot 937$ . If not the first, Napier was at least one of the first to use the present notation. It is almost safe to say that his tables would not have been constructed without it.

Towards the end of the Sixteenth Century the progress of science was greatly impeded by the continually increasing complexity of numerical calculation. Astronomy was making wonderful advances. Kepler was examining the orbits of the planets. Galileo was soon to turn his telescope to the stars. And the numerical calculations of astronomers involved immense labour with the means at their disposal. The tables of sines, cosines, etc., were, of course, already in their hands: though, as we shall see later, the language of trigonometry was then somewhat different. German mathematicians had constructed the trigonometrical tables to an enormous degree of accuracy. But the precision, which the astronomical computations needed, greatly increased the work of the calculator. Nor was this the case in astronomy alone.

Napier seems to have laid aside his earlier work in arithmetic and algebra, and set out to devise some means of lessening this labour. He was not the only worker in the same field. To Napier in Merchiston, and to Bürgi, in Prague or Cassel, a similar inspiration seems to have come, at the same time and quite independently. We learn from one of Kepler's works that Bürgi had made some

progress in his tables many years before the publication of Napier's canon; but he did not publish them till 1620, and then only in part. By that time the value of Napier's discovery was already recognised, and the labours of the astronomer were shortened so much that, as has been said, the length of his life was many times multiplied.

Bürgi's work was entitled *Arithmetische und Geometrische Progresstabulen, sambt gründlichen unterricht, wie solche nützlich in allerley Rechnungen zu gebrauchen und verstanden werden sol.*" But the explanation promised in the title was not included in the book. About 1850 a copy of his MSS. was found in Dantzic, containing the missing description of the tables. From this MSS. it is now clear that he was very near indeed to anticipating Napier; for had he had the pen of a ready writer, or had he been a man of a different temperament, there can be little doubt that his tables would have seen the light earlier.

I have already remarked that the idea from which both Bürgi and Napier started was the same. We see it in the title of Bürgi's book, *Arithmetische und Geometrische Progresstabulen*. Two progressions, an arithmetical and a geometrical, are calculated. Multiplication and division in the one correspond to addition and subtraction in the other. For example, consider the series

1, 2, 3, 4, 5, 6, 7, 8,.....15.....(A.P.)

2, 4, 8, 16, 32, 64, 128, 256, .....32768...(G.P.).

The product of 128 and 256 in the G.P. is 32768, as this is the number corresponding to the sum of 7 and 8 in the A.P.

This idea was not new. Aristotle had used it long ago, and, since his time, several mathematicians had returned to it. But none of them had fully realised its possibilities, nor did any of them conceive or execute the plan of computing a pair of corresponding series, sufficiently dense, to be of practical use in calculation. If the index notation,



with which every schoolboy is now familiar, had been part of the mathematical apparatus of these days, the discovery of logarithms would not have tarried so long. But it was not till 1637 that Descartes introduced the modern notation  $a^2, a^3, a^4$ , etc., which took the place of  $aa, aaa, aaaa$ , etc., and other similar, but to us, clumsy devices. Indeed the logarithms of Bürgi and those of Napier, at any rate in their earliest form, were quite independent of the idea of a *base* at all. It was not till about 1750 that a systematic exposition of logarithms as exponents found a place in the text-books of algebra.

Bürgi's two series are as follows:—

$$10 \times 0, \quad 10 \times 1, \quad 10 \times 2, \dots 10 \times n, \dots (\text{A.P.})$$

$$10^8, \quad 10^8 \left(1 + \frac{1}{10^4}\right), \quad 10^8 \left(1 + \frac{1}{10^4}\right)^2, \dots 10^8 \left(1 + \frac{1}{10^4}\right)^n, \dots (\text{G.P.})$$

The terms of the A.P. he calls the *red* numbers, and he prints them in red in his tables. The terms of the G.P. he calls the *black* numbers, and they are printed in the ordinary type.

An extract from his tables is now given:—

	28 000	28 500	29 000	29 500	30 000	up to 31 500
0	1323 11129	1329 74308	1336 40811	1342 10655	1349 83856	
10	..... 24362	..... 87605	..... 54175	..... 24086	..... 97355	
20	..... 37593	1330 00904	..... 67541	..... 37518	1350 10854	
30	..... 50826	..... 14204	..... 80907	..... 56952	..... 24355	
40	..... 64061	..... 27506	..... 94267	..... 64387	..... 37858	

If we wish, for example, to multiply any two of the *black* numbers, we have only to look along the table to see what the corresponding *red* numbers are; these have to be added and the *black* number which corresponds to their sum read off. The required product will be this *black* number multiplied by  $10^8$ . The closer the black numbers of the table are to each other, the more accurate an instrument does

it provide. If we have to deal with numbers between two consecutive *black* numbers, the ordinary rule of proportional parts would be used.

We pass now to Napier's work, and we are fortunate in being able to listen to his own words, as given in the preface to Wright's translation of the *Descriptio*, published in London in 1616. Down to the reference to the change from the Latin into English, this is a literal translation of the preface to Napier's original:—

“Seeing there is nothing (right well beloved students in the mathematics) that is so troublesome to mathematicall practise, nor that doth more molest and hinder calculators, than the multiplications, divisions, square and cubical extractions of great numbers, which, besides the tedious expence of time, are for the most part subject to many slippery errors; I began, therefore, to consider in my minde, by what certaine and ready art I might remove those hindrances. And having thought upon many things to this purpose, I found at length some excellent briefe rules to be treated of (perhaps) hereafter. But amongst all, none more profitable than this, which together with the hard and tedious multiplications, divisions, and extractions of rootes, doth also cast away from the worke it selfe, even the very numbers themselves that are to be multiplied, divided, and resolved into rootes, and putteth other numbers in their place, which performe as much as they can do, onely by addition and subtraction, division by two, or division by three: which secret invention, being (as all other good things are) so much the better as it shall be the more common; I thought good heretofore to set forth in Latine for the publique use of mathematicians. But now some of our Countrymen in this Island well affected to these studies, and the more publique good, procured a most learned mathematician to translate the same into our vulgar English tongue, who after he had finished it, sent the copy of it to me, to bee seene and considered on by myself. I having most willingly and gladly done the same, finde it to bee most exact and precisely conformable to my minde and the originall. Therefore

it may please you who are inclined to these studies, to receive it from me and the translator, with as much good will as we recommend it unto you. Fare yee well."

To understand this work properly, we must remember that its chief object was to render easier computations involving the trigonometrical ratios. What we call the sine, cosine, etc., were by the mathematicians of Napier's time regarded not as ratios but as lines.

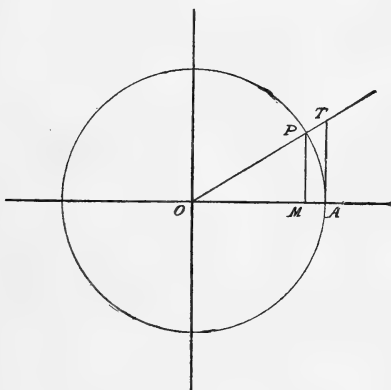

The line  $PM$  measured the *sine* of the arc  $AP$ ;  $OM$  was the *cosine*;  $AT$  the *tangent*, etc. In the tables, the values of the *sine*, *cosine*, *tangent* etc., were given as integers; for, as we have seen, the decimal notation for fractions had not been invented when they were compiled. If additional accuracy was required, they were computed on the assumption that the "*radius*" was proportionally great. With Napier the *radius* or *sinus totus* was taken as  $10^7$ . Later, trigonometrical tables in which the radius was  $10^{10}$  were often used; and it is due to the use of these tables that the logarithmic sines, etc., as we sometimes call them, have the characteristics 10, 9, 8, etc.

As Napier takes the radius as  $10^7$ , and thus the sine of a right angle—the *sinus totus*—as  $10^7$ , it will now be clear why he works with the series:—

$$0, 1, \quad 2, \quad \dots \quad n \dots$$

$$10^7, 10^7(1 - \frac{1}{10^7}), \quad 10^7(1 - \frac{1}{10^7})^2, \dots \quad 10^7(1 - \frac{1}{10^7})^n, \dots$$

By calculating a sufficient number of terms in these two series a set of numbers was obtained, dense enough to be used in dealing with the sines of angles between  $0^\circ$  and  $90^\circ$ , at differences of a minute.

But as a matter of fact, though this is the idea at the root of Napier's work, he made to it a very remarkable addition, placing his tables in a class quite apart from that in which those of Bürgi stand. We shall see later that when he comes to define logarithms, it is not from the correspondence of the above arithmetical and geometrical series that they are obtained, and that in his definition he approaches very closely to the principles on which Newton 50 years later founded the Differential Calculus.

The construction of his tables is explained fully in the *Constructio*, written before the *Descriptio* but not published till 1619, after his death. Napier proceeded as follows:—

He formed first of all a G.P. of 101 terms in which the first term was  $10^7$  and the common ratio  $(1 - \frac{1}{10^7})$ .

We shall denote the terms of this series by  $a_0, a_1, a_2,$  etc., and take  $r_1$  for the common ratio.

$$\left. \begin{aligned} \text{Thus } a_0 &= 10^7 \\ a_1 &= 10^7(1 - \frac{1}{10^7}) = a_1 r_1 \\ a_2 &= 10^7(1 - \frac{1}{10^7})^2 = a_1 r_1^2 \\ a_{100} &= 10^7(1 - \frac{1}{10^7})^{100} = a_1 r_1^{100} \end{aligned} \right\} r_1 = 1 - \frac{1}{10^7}.$$

These successive numbers were easily calculated, when the notation for the decimal fractions was introduced, and the approximation carried only as far as was necessary

for his purpose. They are contained in his *First Table*, which, except for the letters  $a$ , reads as follows:—

*First Table.*

$$\begin{array}{r}
 a_0 = 10000000 \cdot 0000000 \\
 \hline
 \phantom{a_0} \phantom{=} 1 \cdot 0000000 \\
 a_1 = 9999999 \cdot 0000000 \\
 \hline
 \phantom{a_1} \phantom{=} \phantom{0000000} \cdot 9999999 \\
 a_2 = 9999998 \cdot 0000001 \\
 \hline
 \phantom{a_2} \phantom{=} \phantom{0000001} \cdot 9999998 \\
 a_3 = 9999997 \cdot 0000003 \\
 \hline
 \phantom{a_3} \phantom{=} \phantom{0000003} \cdot 9999997 \\
 a_4 = 9999996 \cdot 0000006 \\
 \text{to be continued up to} \\
 a_{100} = 9999900 \cdot 0004950.
 \end{array}$$

Now the last term of this G.P. is

$$a_{100} = a_0 r_1^{100}.$$

If we write  $\rho_2 = \frac{a_{100}}{a_0} = r_1^{100}$ , a new G.P. containing 51 terms can be formed, with  $a_0$  and  $a_{100}$  for its first two terms, and  $\rho_2$  for its common ratio.

Let us denote its terms by:—

$$\beta_0, \beta_1, \beta_2, \dots, \beta_{50}.$$

$$\begin{array}{l}
 \text{Then } \beta_0 = a_0 \\
 \beta_1 = \beta_0 \rho_2 = a_0 r_1^{100} = a_{100} \\
 \beta_2 = \beta_0 \rho_2^2 = a_0 r_1^{200} = a_{200} \\
 \beta_{50} = \beta_0 \rho_2^{50} = a_0 r_1^{5000} = a_{5000}
 \end{array}
 \left\{ \begin{array}{l}
 a_0 = 10^7 \\
 r_1 = 1 - \frac{1}{10^7} \\
 \rho_2 = r_1^{100}.
 \end{array} \right.$$

Napier does not calculate the terms of this series. To do so would have been a more formidable task than the calculation of the set of numbers he proceeded to obtain.

Instead of  $\beta_1 = 9,999,900 \cdot 0004950$  he takes the number 9999900, which differs from it by only a small fraction.

We shall denote this number by  $b_1$ .

$$\text{We shall write } b_0 = a_0 \text{ and } r_2 = \frac{b_1}{b_0} = 1 - \frac{1}{10^5}.$$

The numbers in Napier's *Second Table* are the 51 terms of the G.P., beginning with  $b_0$ ,  $b_1$ , and with the common ratio  $r_2$ .

$$\text{Thus } \left. \begin{array}{l} b_0 = a_0 \\ b_1 = b_0 r_2 \\ b_2 = b_0 r_2^2 \\ \vdots \\ b_{50} = b_0 r_2^{50} \end{array} \right\} \begin{array}{l} a_0 = 10^7 \\ r_2 = 1 - \frac{1}{10^5} \end{array}$$

This *Second Table*, except for the  $b$ 's, reads as follows:—

*Second Table.*

$$b_0 = 10000000 \cdot 000000$$

$$\underline{100 \cdot 000000}$$

$$b_1 = 9999900 \cdot 000000$$

$$\underline{99 \cdot 999000}$$

$$b_2 = 9999800 \cdot 001000$$

$$\underline{99 \cdot 998000}$$

$$b_3 = 9999700 \cdot 003000$$

$$\underline{99 \cdot 997000}$$

$$b_4 = 9999600 \cdot 006000$$

and so on up to

$$b_{50} = 9995001 \cdot 224804^1$$

Next another G.P. is formed. This consists of 21 terms. The first term is the same as  $a_0$  or  $b_0$ . We shall denote it by  $c_0$ . The second is 9,995,000, very nearly the same as  $b_{50}$ . We shall denote it by  $c_1$ . The ratio  $\frac{c_1}{c_0} = 1 - \frac{1}{2000}$  is to be denoted by  $r_3$ .

This G.P. will be as follows:—

$$\left. \begin{array}{l} c_0 = b_0 = a_0 \\ c_1 = c_0 r_3 \\ c_2 = c_0 r_3^2 \\ \vdots \\ c_{20} = c_0 r_3^{20} \end{array} \right\} \begin{array}{l} a_0 = 10^7 \\ r_3 = 1 - \frac{1}{2000} \end{array}$$

It is easily calculated. It forms the first column of Napier's *Third Table*, and reads as follows:—

<sup>1</sup> Napier has 9995001·222927, and this mistake affects certain numbers in his *Radical Table*.

$$\begin{aligned}
 c_0 &= 10000000\cdot00000 \\
 &\quad 5000\cdot00000 \\
 c_1 &= \frac{9995000\cdot00000}{4997\cdot50000} \\
 c_2 &= \frac{9990002\cdot50000}{4995\cdot00125} \\
 c_3 &= \frac{9985007\cdot49875}{4992\cdot50374} \\
 c_4 &= \frac{9980014\cdot99501}{\text{and so on up to}} \\
 c_{20} &= 9900473\cdot57808.
 \end{aligned}$$

This Third Table of Napier's, in which these  $c$ 's form the first column, contains 69 columns. The terms at the top of these columns are the terms of the G.P., beginning with  $c_0$  and 9,900,000, a number differing slightly from  $c_{20}$ . If we denote these terms by

$$d_0, d_1, d_2 \text{ up to } d_{68},$$

we have  $\frac{d_1}{d_0} = 1 - \frac{1}{10^2}$ .

This common ratio we denote by  $r_4$ .

Thus we have

$$\left. \begin{aligned}
 d_0 &= c_0 = b_0 = a_0 \\
 d_1 &= d_0 r_4 \\
 d_2 &= d_0 r_4^2 \\
 d_{68} &= d_0 r_4^{68}
 \end{aligned} \right\} \begin{aligned}
 a_0 &= 10^7 \\
 r_4 &= 1 - \frac{1}{10^2}.
 \end{aligned}$$

These form the terms in the first row of the Third Table. The columns each contain 21 terms in G.P., the common ratio being now  $1 - \frac{1}{2000}$ .

This Third Table, except for the  $c$ 's and  $d$ 's, reads as follows :—

	First column.	Second column.	Third column.	Sixty-ninth column
	$d_0$	$d_1$	$d_2$	$d_{68}$
$c_0$	10000000·0000	9900000·0000	9801000·0000	5048858·8900
$c_1$	9995000·0000	9895050·0000	9796099·5000	5046334·4605
	9990002·5000	9890102·4750	9791201·4503	5043811·2932
	9985007·4987	9885157·4237	9786305·8495	5041289·3879
	up to			
$c_{20}$	9900473·5780	9801468·8423	9703454·1539	4998609·4034

In this Third Table Napier obtained a set of numbers lying between the radius ( $10^7$ ) and half the radius ( $\frac{1}{2} \times 10^7$ ). They are close enough to one another to allow the table to be used in dealing with the sines of angles from  $90^\circ$  to  $30^\circ$  at intervals of  $1'$ , when the logarithms of these sines, according to Napier's definition of logarithms, are to be determined. They are not exactly in a G.P., but each of the 69 columns of the Third Table is a G.P. of 21 terms.

If we had proceeded from the one G.P. to the other, as in the case denoted above by the terms

$$\beta_0, \beta_{12}, \dots \beta_{50},$$

we would have had

$$\left. \begin{aligned} \gamma_0 &= \beta_0 = a_0 \\ \gamma_1 &= \gamma_0 \rho_3 = a_0 r_1^{5000} = a_{5000} \\ \gamma_2 &= \gamma_0 \rho_3^2 = a_0 r_1^{10000} = a_{10000} \\ \gamma_{20} &= \gamma_0 \rho_3^{20} = a_0 r_1^{100000} = a_{100000} \end{aligned} \right\} \begin{aligned} \gamma_1 &= \beta_{50} \\ \rho_3 &= \rho_2^{50} = r_1^{5000}, \end{aligned}$$

instead of the series

$$c_0, c_{12}, c_{24}, \dots c_{202},$$

which forms the first column of the Third Table.

Also the terms at the top of the columns of the Third Table would have been

$$\delta_0, \delta_{12}, \dots \delta_{68},$$

where

$$\left. \begin{aligned} \delta_0 &= \gamma_0 = \beta_0 = a_0 \\ \delta_1 &= \gamma_{20} = \delta_0 \rho_4 = a_{100000} \\ \delta_2 &= \delta_0 \rho_4^2 = a_{200000} \\ \delta_{68} &= \delta_0 \rho_4^{68} = a_{6800000} \end{aligned} \right\} \rho_4 = \frac{\gamma_{20}}{\gamma_0} = r_1^{100000}.$$

The last term in the 69th column would, in this case, be the same as the first in the 70th column, namely

$$a_0 \rho_4^{69}, \text{ or } a_0 r_1^{6900000} \text{ or } a_{6900000}$$

Now the word *logarithm* is due to Napier. From its derivation he means by it *the number of the ratios*.

In the series

$$0, \quad 1, \quad 2, \quad \dots \quad n \quad \dots$$

$$10^7, \quad 10^7(1 - \frac{1}{10^7})^1, \quad 10^7(1 - \frac{1}{10^7})^2, \dots 10^7(1 - \frac{1}{10^7})^n, \dots$$



the term  $10^7 \left(1 - \frac{1}{10^7}\right)^n$  is got from  $10^7$  by  $n$  successive applications of the ratio  $1 - \frac{1}{10^7} : 1$ .

The number of the ratios for  $10^7 \left(1 - \frac{1}{17^7}\right)^n$  would thus be  $n$ .

With this definition of logarithms, the logarithms of the numbers denoted by the Greek letters in the above scheme would be the suffixes of the corresponding  $\alpha$ 's, and the last term in the 69th column of the Third Table would have for its logarithm 6,900,000.

Such a table of logarithms would correspond exactly to Bürigi's Table of *Red* and *Black* numbers. But Napier did not introduce his *logarithms* in this way. The method which he followed, and the definition which he gave, are very remarkable: for they indicate, as we have remarked above, that he had already in his mind, though it may be very dimly and vaguely, the principles on which Newton, some 50 years later, built up the Differential Calculus. It will be best to borrow from the *Constructio* the different steps in Napier's argument.<sup>1</sup>

"Hitherto we have explained," he says, "how we may most easily place in tables sines or natural numbers progressing in geometrical proportion."

22. "It remains, in the Third Table at least, to place beside the sines or natural numbers decreasing geometrically their logarithms or artificial numbers increasing arithmetically."

23. "To increase arithmetically is, in equal times, to be augmented by a quantity always the same."

24. "To decrease geometrically is this, that in equal times, first the whole quantity then each of its successive remainders is diminished, always by a like proportional part."

---

<sup>1</sup> Cf. Macdonald's English translation of the *Constructio*, Edinburgh, 1889. In quoting from this work, Macdonald's rendering is followed.

25. "Whence a geometrically moving point approaching a fixed one has its velocities proportionate to its distances from the fixed one."

26. "The logarithm of a given sine is that number which has increased arithmetically with the same velocity throughout as that with which radius began to decrease geometrically, and in the same time as radius has decreased to the given sine."

The discussion which Napier gives in sections 22–26 of the *Constructio*, of which we have quoted the headings only, we shall replace by the following argument in our modern notation, using the methods of the Calculus, of course unknown in Napier's time.

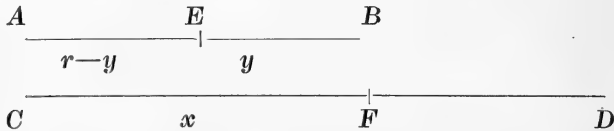

His definitions of logarithms can be put in the following terms:—Imagine two straight lines  $AB$  and  $CD$ ,  $AB$  being of length equal to the radius  $r$ , and  $CD$  of infinite length. Let two particles start from  $A$  and  $C$  at the same time and with the same initial velocity, and move along these two lines. But while the velocity of the particle which starts at  $C$  is to remain constant, that of the particle which starts from  $A$  is to decrease in such a way that at any stage of its journey from  $A$  towards  $B$ , say at  $E$ , the velocity at  $E$ : the velocity at  $A = EB : AB$ .

When one particle is at  $E$  on  $AB$ , let the other particle be at  $F$  on  $CD$ . Then the number which measures  $CF$  is called the logarithm of the number which measures  $EB$ .

With the notation of the Calculus, the relation between a number and its logarithm can easily be found:—

Let  $CF = x$ , and  $BE = y$  at the time  $t$  from the start from  $A$  and  $B$ .

Let the common initial velocity be  $cr$ .

Then  $x = crt$  and  $\frac{d}{dt}(r - y) = cy$ .

From the second of these equations  $\frac{dy}{dt} + cy = 0$ .

Thus, using the initial conditions,  $y = re^{-ct}$ .

Therefore  $x = r \log_e \frac{r}{y}$ .

If we write  $\log_N y$  for Napier's logarithm of  $y$ , as defined above,  $x = \log_N y = r \log_e \frac{r}{y}$ .

The relation between  $x$  and  $y$  can also be put in the form

$$y = 10^7 e^{-\frac{x}{10^7}}, \text{ when } r = 10^7.$$

$$\text{i.e. } y = 10^7 \left\{ \text{Lt}_{m \rightarrow \infty} \left( 1 - \frac{1}{m} \right)^m \right\}^{\frac{x}{10^7}}$$

On comparing this with

$$y = 10^7 \left[ \left( 1 - \frac{1}{10^7} \right)^{10^7} \right]^{\frac{x}{10^7}},$$

we see that the values of  $y$  given by the latter will not differ by much from those given by the former.

From the relation  $x = \log_N y = r \log_e \frac{r}{y}$ , it is clear that if points are taken on  $AB$  such that  $BP_1, BP_2, BP_3$ , etc., descend in G.P., the corresponding points on  $CD$ , namely  $Q_1, Q_2, Q_3$ , etc., ascend in A.P.

Further, the logarithm of radius is zero.

Also  $\log_N(uv)$  is *not*  $\log_N u + \log_N v$ , neither is  $\log_N(u/v)$  the same as  $\log_N u - \log_N v$ .

But if  $z = \frac{uv}{r}$ ,  $\log_N z = \log_N u + \log_N v$ ,

and if  $\frac{z}{r} = \frac{u}{v}$ ,  $\log_N z = \log_N u - \log_N v$ .

Finally, if  $\frac{u}{v} = \frac{u'}{v'}$ , then  $\log_N u - \log_N v = \log_N u' - \log_N v'$ .

Thus it is clear that if a table of these logarithms could be calculated, multiplication and division would be reduced to addition and subtraction.

It must now be seen how Napier obtained this table or canon of logarithms. He relies on the fact that the logarithms of numbers in G.P. have a common difference; and also on the two following theorems.

I. (*Constructio*, Section 28). *The logarithm of any given sine is greater than the difference between radius and the given sine, and less than the difference between radius and the quantity which exceeds it in the ratio of radius to the given sine.*

II. (*Constructio*, Section 39). *The difference of the logarithms of two sines lies between two limits; the greater limit being to radius as the difference of the sines to the less sine, and the less limit being to radius as the difference of the sines to the greater sine.*

These theorems are easy to establish with the aid of the logarithmic series. Napier obtains them direct from his definition of logarithms.

I. Let  $s$  be a sine nearly equal to the radius  $r$ .

$$\begin{aligned} \text{Then } \log_{NS} &= r \log_e \frac{r}{s} \\ &= r \log_e \left(1 + \frac{r-s}{s}\right) \\ &= -r \log_e \left(1 - \frac{r-s}{r}\right). \end{aligned}$$

Expanding  $\log_e \left(1 + \frac{r-s}{s}\right)$  and  $\log_e \left(1 - \frac{r-s}{r}\right)$ , we have

$$(r-s) \frac{r}{s} > \log_{NS} > (r-s).$$

A close approximation to  $\log_{NS}$  would thus be the arithmetical mean between

$$(r-s) \frac{r}{s} \text{ and } (r-s), \text{ namely } \frac{1}{2s} (r-s) (r+s).$$

II. Again let  $s_1$  and  $s_2$  be two sines nearly equal to each other,  $s_1$  being the greater.

$$\begin{aligned}
 & \text{We have } \log_N s_2 - \log_N s_1 \\
 &= r \log_e \frac{r}{s_2} - r \log_e \frac{r}{s_1} \\
 &= r \log_e \frac{s_1}{s_2} \\
 &= r \log_e \left( 1 + \frac{s_1 - s_2}{s_2} \right) \\
 &= -r \log_e \left( 1 - \frac{s_1 - s_2}{s_1} \right).
 \end{aligned}$$

Then it follows as in Theorem I. that

$$r \left( \frac{s_1 - s_2}{s_2} \right) > \log_N s_2 - \log_N s_1 > r \left( \frac{s_1 - s_2}{s_1} \right).$$

We can now grasp Napier's method. He takes, to begin with, his First Table. The logarithm of the first term is zero. Theorem I., above, shows that the logarithm of the second term lies between  $r - s$  and  $(r - s) \frac{r}{s}$ ; that is, between 1'000,000,0 and 1'000,000,1. If this is taken as the arithmetic mean of these two numbers, we have for the logarithm of this term 1'000,000,05. The remaining terms in the table form with these two a G.P. Therefore, the logarithms have a common difference 1'000,000,05. Hence the logarithm of the last term is 100'000,005.

We pass from the logarithm of the last term in the First Table, to that of the second term in the Second Table, by the help of Theorem II. The logarithm of this term is found to lie between two limits, close to each other, and approximately as above, it is to be taken as 100'000,500,0. As the first term is *radius*, its logarithm is zero; and as the terms in the table form a G.P., their logarithms are obtained by adding step by step the common difference. In this way the logarithm of the last term is given as 5,000'025,000,1.

By a process exactly similar, it is easy to pass from the last term of the Second Table to the second term in the first column of the Third Table. The first term in that

column is *radius*, so its logarithm is zero. The logarithm of the second term is given as 5,001·250,417. This number is the common difference of the logarithms of the numbers in that column. From the last term in it, we pass, as before, to the first term of the second column. Its logarithm is found to be 100,503·358. The numbers at the top of the columns of this Third Table form a G.P., so we are now able to write down their logarithms. The second term in each column differs only slightly from the first term. Thus by Theorem II., above, its logarithm can be found. Also from the first and second terms, the others in these columns are got by addition of the proper common difference.

These are the steps taken by Napier in calculating the logarithms of the terms in his Third Table. The results are contained in his Radical Table, an extract from which is appended.

*The Radical Table.*

First column.		Second column.		and the others up to	Sixty-ninth column.	
Natural Numbers.	Logarithms.	Natural Numbers.	Logarithms.		Natural Numbers	Logarithms
1000000·0000	·0	9900000·0000	100503·3		5048858·8900	6834225·8
9995000·0000	5001·2	9895050·0000	105504·6		5046334·4605	6839227·1
9990002·5000	10002·5	9890102·4750	110505·8		5043811·2932	6844228·3
9985007·4987	15003·7	9885157·4237	115507·1		5041289·3879	6849229·8
up to	up to	up to	up to		up to	up to
9900473·5780	100025·0	9801468·8423	200528·2		4998609·4034	6934250·8

The numbers in the Radical Table for which the logarithms have been found, form a set dense enough to allow of the logarithms of the sines from  $90^\circ$  to  $30^\circ$  at differences of  $1'$  to be calculated.

To obtain the logarithms of the sines of the angles from  $0^\circ$  to  $30^\circ$ , Napier indicates two separate methods. In the first the given sine is to be multiplied by some number 2, 4, 8, 10, 20, 40, 80, 100, 200, or any other proportional number contained in a small table he has calculated in

which the corresponding differences of the logarithms for these multipliers are given.

In the second the formula

$$\sin 2 \theta = 2 \sin \theta \sin \left( \frac{\pi}{2} - \theta \right)$$

is used, but it must be noticed that this formula, in his notation, where the sines are lines in a figure of which the radius is  $r$ , must be written as

$$\frac{r}{2} \sin 2 \theta = \sin \theta \sin \left( \frac{\pi}{2} - \theta \right).$$

It follows that, with Napier's logarithms,

$$\log \sin 2 \theta + \log \frac{r}{2} = \log \sin \theta + \log \sin \left( \frac{\pi}{2} - \theta \right).$$

Thus the table of logarithms of sines can be extended to  $15^\circ$ . Then applying the same formula, it can be continued to  $7^\circ 30'$ , and so on indefinitely.

Further from the logarithms of the sines of angles not less than  $45^\circ$  those of angles from  $22^\circ 30'$  to  $45^\circ$  can be obtained. From these again the interval  $11^\circ 15'$  to  $22^\circ 30'$  can be filled up, and so on. And in this way an independent investigation of the logarithms of the sines from  $30^\circ$  to  $45^\circ$  was available.

Part of the first page of this table, as given in the *Descriptio*, is appended.

Gr. 0 + | -

min.	Sinus.	Logarithmi	Differentiæ	Logarithmi	Sinus	
0	0	Infinitum	Infinitum	0	10000000	60
1	2909	81425681	81425680	1	10000000	59
2	5818	74494213	74494211	2	9999998	58
3	8727	70439560	70439560	4	9999996	57
4	11636	67562746	67562739	7	9999993	56
5	14544	65331315	65331304	11	9999989	55
27	78539	48467431	48467122	309	9999692	33
28	81448	48103763	48103431	332	9999668	32
29	84357	47752859	47752503	356	9999644	31
30	87265	47413852	47413471	381	9999619	30 min.

The fourth, or middle column, contains the differences between the logarithms of the sines and the logarithms of the tangents.

Since we have, according to the notation of the time,

$$\sin \theta : \cos \theta = \tan \theta : \text{radius},$$

$$\log \tan \theta - \log \text{radius} = \log \sin \theta - \log \cos \theta.$$

But  $\log \text{radius} = 0$ .

Therefore  $\log \tan \theta = \log \sin \theta - \log \cos \theta$ .

It will be noticed that the logarithms of tangents of angles between  $0^\circ$  and  $45^\circ$  are positive, but, between  $45^\circ$  and  $90^\circ$ , they are negative.

Further, since  $\sin \theta : \text{radius} = \text{radius} : \text{cosec } \theta$ , and  $\cos \theta : \text{radius} = \text{radius} : \text{sec } \theta$ , we have

$$\log \text{cosec } \theta = -\log \sin \theta, \text{ and } \log \text{sec } \theta = -\log \cos \theta.$$

Thus the logarithms of the trigonometrical ratios can all be derived from his table.

To make it answer the purpose of a table of logarithms of common numbers, the author states that the following procedure should be adopted:—

A number being given, find that number in any table of natural sines, or tangents, or secants, and note the degrees and minutes in its arc. Then in his table find the logarithm of the corresponding sine, tangent or secant, and this will be the logarithm of the required number.

After the definitions and descriptions of logarithms, Napier explains, in the *Descriptio*, the tables which it contains, and shows how to take out the logarithms of sines, tangents, secants, and common numbers; as also how to add and subtract logarithms. He then goes on to teach the uses of these numbers. Firstly, in finding any of the terms of three or four proportionals, showing how to multiply and divide, and to find powers and roots, by logarithms. And secondly, developing the uses of the



theory in plane and spherical trigonometry, especially as applied in astronomical calculations. In the sections on spherical trigonometry, in addition to some new theorems, he gives the general theorem of what are now called Napier's Circular Parts, by which in one rule he brought together in a form, very easy to remember, the results for the different cases of the solution of right-angled spherical triangles.

To Napier's table of logarithms a cordial reception was at once given by the mathematicians of his day. In 1616 it was translated into English by Wright. Ursinus printed it in his *Cursus Mathematicus* in 1618, and in 1625 published the *Magnus Canon Triangulorum Logarithmicus*, in which Napier's work was carried from eight figures to nine; and in addition, the intervals were diminished from minute to minute into intervals of 10 seconds. Kepler also immediately recognised the power of the instrument which Napier had invented. And it is characteristic of him that he calculated the tables afresh—or employed his "familiar" to do so<sup>1</sup>—for equidistant sines instead of equidistant angles. His version of the tables was published in 1624, under the title *Chilias Logarithmorum ad todidem numeros rotundos*. A further extension of the original tables from sines to natural numbers was made in 1634 by Crüger.

But in England long before this date, most important developments had been made in the original theory of Napier. Briggs—Professor of Geometry at Gresham College, London, and a graduate of Cambridge; afterwards, like other Cambridge graduates, to become Professor of Mathematics at Oxford—immediately on the appearance of the *Descriptio* was filled with admiration of the invention there explained. Not only so, he recognised that a new

---

<sup>1</sup> Cf. Kepler's letter to Napier, published in Mark Napier's Life, written two years after Napier's death.

and better system of logarithms could be substituted for Napier's original system. He visited Napier at Merchiston in 1615 and 1616, and was preparing to visit him again in 1617, when news of his death arrived. With the subsequent history of logarithms the names of Napier and Briggs are most intimately associated.

Briggs' account of the matter is given in his *Arithmetica Logarithmica* (1624):—

"I myself, when expounding publicly in London their doctrine to my auditors in Gresham College, remarked that it would be much more convenient that 0 should stand for the logarithm of the whole sine, as in the Canon Mirificus, but that the logarithm of the tenth part of the whole sine, that is to say, 5 degrees 44 minutes 21 seconds, should be 10,000,000,000. Concerning that matter I wrote immediately to the author himself; and as soon as the season of the year and the vacation time of my public duties of instruction permitted, I took journey to Edinburgh, where, being most hospitably received by him, I lingered for a whole month. But as we held discourse concerning this change in the system of logarithms, he said that for a long time he had been sensible of the same thing, and had been anxious to accomplish it, but that he had published those he had already prepared, until he could construct tables more convenient, if other weighty matters and his frail health would permit him so to do. But he conceived that the change ought to be affected in this manner, that 0 should become the logarithm of unity, and 10,000,000,000 that of the whole sine; which I could not but admit was by far the most convenient of all. So, rejecting those which I had already prepared, I commenced, under his encouraging counsel, to ponder seriously about the calculation of these tables."

Napier himself, in several places in the original edition of the *Descriptio*, and again, in more exact terms in a note in Wright's English translation, refers to modifications which he proposed to make in the original system. He

returns to the same topic in the dedication of the *Rabdologia* of 1617, an English translation of which reads as follows:—

“The difficulty and prolixity of calculation (most illustrious Sir), the weariness of which is so apt to deter from the study of mathematics, I have always, with what powers and little genius I possess, laboured to eradicate. And with that end in view, I published of late years the Canon of Logarithms, wrought out by myself a long time ago, which, casting aside the natural numbers, and the more difficult operations performed by them, substitutes in their place others affording the same results, by means of easy additions, subtractions, bisections, and trisections. Of which logarithms, indeed, I have now found out another species much superior to the former, and intend, if God shall grant me longer life, and the possession of health, to make known the method of constructing, as well as the manner of using them. But the actual computation of this new Canon, I have left, on account of the infirmity of my bodily health, to those versant in such studies; and especially to that truly most learned man, Henry Briggs, Public Professor of Geometry in London, my most beloved friend.”

The change referred to in those passages practically amounts to a choice of a base for the logarithms: and in our modern notation, the choice between which Napier and Briggs hesitate, is between 10 and  $1/10$  for the base.

After his death at the age of 67, in the same year as the publication of the *Rabdologia*, the *Mirifici Logarithmorum Canonis Constructio* was published by the care of his son in 1619. From this work we have already quoted frequently in the preceding account of Napier's discovery. It had been written several years before the publication of the *Descriptio*, but the author had delayed publishing it “until he had ascertained the opinion and criticism on the canon of those who are versed in this kind of learning.”<sup>1</sup>

In the *Constructio*, Napier uses the term *artificial* numbers, for what he calls logarithms, in the *Descriptio*; and

---

<sup>1</sup> See Introduction to the *Constructio* by Robert Napier.

he contrasts these artificial numbers with the natural numbers or sines. In the margin, presumably by Robert Napier, the word *logarithm* is inserted in the corresponding place.

To this work was also added an Appendix "On the Construction of another and better kind of Logarithms, namely one in which the logarithm of unity is 0." This is the system of logarithms referred to above in the quotation from the preface to the *Rabdologia*, and it is by the hand of Napier himself. It contains, moreover, "propositions for the solution of spherical triangles by an easier method; with notes on them and on the above-mentioned Appendix by the learned Henry Briggs."

Napier's Appendix begins with the words:—

"Among the various improvements of Logarithms, the more important is that which adopts a cypher as the logarithm of unity, and 10,000,000,000 as the logarithm of either one tenth of unity or ten times unity. Then, these being once fixed, the logarithms of all other numbers necessarily follow."

He gives three methods of finding these logarithms.

According to the first, the procedure is as follows:— Divide the given logarithm of one-tenth, or of ten, namely 10,000,000,000, by 5, ten times successively, and thereby obtain 2,000,000,000, 400,000,000, etc., down to 1024. Also divide the last by 2, ten times successively, and there will be produced 512, 256, etc., 4, 2, 1.

The numbers which correspond to these logarithms are obtained by extractions of fifth roots and square roots. And, when these have been obtained, the same procedure can be employed with regard to them, and the table extended indefinitely.

It appears from this account, that Napier possessed a method of extracting fifth roots. Briggs, to whom the

calculation of the logarithms fell, did not employ this method.

The second method Napier explains as follows:—

“Any common number being formed from other common numbers by multiplication, division, (raising to a power) or extraction (of a root); its logarithm is correspondingly formed from their logarithms by addition, subtraction, multiplication, by 2, 3, etc. (or division by 2, 3, etc.): whence the only difficulty is in finding the logarithms of the prime numbers; and these may be found by the following general method.

For finding all logarithms, it is necessary as the basis of the work that the logarithms of some two common numbers be given or at least assumed; thus in the foregoing first method of construction, 0 or a cypher was assumed as the logarithm of the common number one, and 10,000,000,000 as the logarithm of one-tenth or of ten. These therefore being given, the logarithm of the number 5 (which is a prime number) may be sought by the following method. Find the mean proportional between 10 and 1, namely  $\frac{316227766017}{100000000000}$ , also the arithmetical mean between 10,000,000,000 and 0, namely, 5,000,000,000; then find the geometrical mean between 10,000,000,000 and  $\frac{316227766017}{100000000000}$  namely  $\frac{562341325191}{100000000000}$ , also the arithmetical mean between 10,000,000,000, and 5,000,000,000, namely 7,500,000,000;...”

Expressed in a few words, this method consists in inserting geometrical means between the numbers, and arithmetical means between the logarithms. It is the method which Briggs employed in calculating his tables. It is also the method which most teachers will now use in explaining to their classes, with the index notation, the principle on which the theory of logarithms is based, and a way in which they might be calculated.

In his third method Napier explains how a close approximation to the logarithm of any given number can be obtained by finding the number of figures in the result obtained by raising the given number to a power equal to the assumed logarithm of 10.

As an example, he takes the case of the logarithm of 2, in the system where the logarithm of unity is 0 and the logarithm of 10 is 10,000,000,000.

“Suppose it is asked,” he says, “what number is the logarithm of 2? I reply, the number of places in the result obtained by multiplying together 10,000,000,000 of the number 2.

But, you will say, the number obtained by multiplying together 10,000,000,000 of the number 2 is innumerable. I reply, still the number of places in it, which I seek, is numerable.

Therefore with 2 as the given root, and 10,000,000,000 as the index, seek for the number of places in the multiple, and not for the multiple itself; and by our rule you will find 301029995 etc. to be the number of places sought, and the logarithm of the number 2.”

This should be 3010299957, and the logarithm of 2, on this system, lies between 3010299956 and 3010299957.

When Napier says the logarithm is the number of places in the result obtained by multiplying together 10,000,000,000 of the number 2, he means that the logarithm is *nearly* this.<sup>1</sup> He understands that it lies between this number and the one next below it.

Having agreed upon a reconstruction of the logarithm tables, the calculation was to be left altogether in the hands of Briggs. And on Napier's death in 1617, the whole

---

<sup>1</sup> *Constructio* English Trans., p. 61 (Briggs' note).

responsibility for this great task fell to the former. So eagerly did he set himself to the work that in 1617 he was able to publish the logarithms of the first 1,000 numbers (*Logarithmorum Chilias prima*, London, 1617). In 1620 Gunter published in London tables of the logarithms of sines and tangents for every minute to seven decimals. In 1624 Briggs followed his earlier work by the *Arithmetica Logarithmica*, in which the logarithms of all numbers from 1 to 20,000 and 90,000 to 100,000 are given to 14 places. A specimen of these tables is given below.

*Briggs' Table of Logarithms (1624).*

Numeri absoluti.	Logarithmi	Numeri absoluti	Logarithmi
16501	4,21751,02642,9403 2,63184,8511	16534	
16502	4,21753,65827,7914 2,63168,9029		
16503	4,21756,28996,6943 2,63152,9567		

It will be seen that Briggs takes  $\log 10 = 1$ , and that we have now to deal with decimal fractions in the ordinary way. Napier, by choosing 10,000,000,000 as the logarithm of 10, practically obtained these logarithms on the usual scale to ten places. While Briggs was busily engaged in completing his Tables, calculating the logarithms of the numbers from 20,000 to 90,000 to fourteen places, he was anticipated by a Dutchman, Vlacq, who in 1628 published an *Arithmetica Logarithmica*, which he called a second edition of Briggs' work of the same name. This contained the logarithms of all numbers from 1 to 100,000, calculated to ten places of decimals. In addition, it included the logarithms of the usual six trigonometrical functions for every minute, to the same number of places. A specimen of the tables is given on the next page :—

Vlacq's Table of Logarithms (1628).

CHILIAS 50.				CHILIAS 51.				CHILIAS 51.			
Num.	Logarithmi.	Diff.	Num.	Logarithmi	Diff.	Num.	Logarithmi.	Diff.	Num.	Logarithmi.	Diff.
49951	4,69854,41871	86943	50001	4,69897,86901	86857	50051	4,69941,27589	86770	50051	4,69941,27589	86770
49952	4,69855,28814	80941	50002	4,69898,73758	86854	50052	4,69942,14359	86768	50052	4,69942,14359	86768
49953	4,69856,15755		50003	4,69899,60812		50053	4,69943,01127		50053	4,69943,01127	

30	SINUS.	Sin. Compl.	TANG.	Tang. compl.	SECAN.	Sec. compl.
0	9,69897,00043 21,87385	9,93753,06317 7,29619	9,76143,93726 29,17004	10,23856,06274 29,17004	10,06246,93683 7,29619	10,30102,99957 21,87385
1	9,69918,87428 21,85916	9,93745,76698 7,30108	9,76173,10730 29,16024	10,23826,89270 29,16024	10,06254,23302 7,30108	10,30081,12572 21,85916



These trigonometrical functions were still regarded as lines, not ratios. Vlacq took the radius as  $10^{10}$ . Owing to this, the logarithm of the sine of  $90^\circ$  is 10, and the logarithms of the other sines have the characteristics 9, 8, etc. The common explanation of the characteristics, 10, 9, 8, etc. in the logarithms of the trigonometrical ratios—namely, that the number 10 has been added to the logarithm of the ratio to make the characteristic positive—is not correct. The truth is that the tables of logarithms, which we now possess, have been copied, more or less directly, from the tables drawn up by Briggs and Vlacq between 1620 and 1630. The principal change has been that, during one period, there has been a fashion for a smaller, and, in another period, for a larger number of decimal places. Also, of course, such errors in computation as had crept into the work of these two pioneers have been eliminated.

Briggs died in 1632. The last years of his life were devoted to the calculation of more extensive tables of the logarithms of the trigonometrical functions. The work of Briggs, like that of Vlacq, has never been superseded. The rapidity and industry with which they performed this immense piece of computation must always be the admiration of mathematicians.

In the accounts of some writers on the History of the Discovery of Logarithms—notably in that which Hutton prefixed to his mathematical tables—greater credit than he could rightly claim has been ascribed to Briggs for the improvement in logarithms from the form in which Napier first published them. The credit for the change to the base 10 must be shared between Napier and Briggs; but, as the idea of the change had occurred to Napier as early, if not earlier, than to Briggs, those, who would call the logarithms to the base 10 “Briggsian” Logarithms, do

scanty justice to the man whose memory we are met to honour. And a mistake almost equally serious is that which we commit when we call the logarithms to the base  $e$  Napierian Logarithms, if, by giving them his name, we mean that they are in any way associated with Napier. In fact, the place of the number  $e$  in the theory of logarithms, as well as the possibility of defining logarithms as exponents, were discoveries of a much later date.

The announcement of Napier's invention was made in 1614. It is remarkable that before 14 years had passed, the logarithm tables, almost in the form in which they are used at the present time, had been completed and published. Few more far-reaching inventions have ever been made. Still fewer have been brought to perfection in so short a time.

---

ON THE ACCURACY OF NEUMANN'S METHOD FOR  
THE ESTIMATION OF PHOSPHORUS.

By H. S. HALCRO WARDLAW, B.Sc.,

Science Research Scholar of the University of Sydney.

(From the Physiological Laboratory of the University of Sydney.)

[*Read before the Royal Society of N. S. Wales, June 3, 1914.*]

FOR the estimation of phosphates in the presence of any metals but those of the alkalis the customary procedure entails two precipitations, each of which requires about twelve hours for completion. (1) The phosphate is precipitated as ammonium phosphomolybdate by adding a solution of ammonium molybdate containing nitric acid. (2) The precipitate of ammonium phosphomolybdate is dissolved in ammonium hydroxide and the phosphate is precipitated from it as magnesium ammonium phosphate by the addition of magnesia mixture. This latter precipitate is ignited to magnesium pyrophosphate, from the weight of which the amount of phosphate may be calculated. This method was first employed by Sonnenschein.

The tediousness of this process and the frequency with which estimations of phosphate are required for a number of purposes have led to many attempts to estimate the phosphate directly from the phosphomolybdate precipitate, either by weighing (Eggertz, Baxter, Baxter and Griffin, Chesneau), or volumetrically. These direct methods all have the drawback that there is some uncertainty as to the exact composition of the precipitate of ammonium phosphomolybdate obtained, so that although individual workers, performing their analyses under very uniform conditions, may have obtained satisfactory concordance in their results, these methods have not met with very general

acceptance for any but routine work and where great accuracy is not required.

Of the volumetric methods for the estimation of phosphate from the ammonium phosphomolybdate precipitate, those of Hundeshagen and of Grete depend on the direct titration of the phosphate against standard molybdic acid, but the majority are simple acid-alkali titrations, the ammonium phosphomolybdate being dissolved in excess of standard alkali, and the excess determined by titration with standard acid. The amount of phosphate present is obtained from the amount of standard alkali used up in the interaction with the precipitate. In addition to all the disadvantages due to uncertainties as to the composition of the precipitate, these methods are also generally faced with the difficulties attendant on an indistinct end-point. Taking the formula given to the precipitate by Hundeshagen, who was the first to investigate the conditions of formation of ammonium phosphomolybdate, the reaction which occurs with caustic soda is given by the equation:

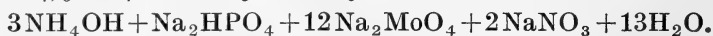

On titrating back the excess of acid, therefore, an indicator to which  $\text{NaH}_2\text{PO}_4$  reacts acid, *i.e.*, a feebly acid indicator such as litmus or phenolphthalein, must be used. The ammonia formed in the reaction, however, will exert its usual disturbing influence on the sharpness of the end-point shown by this class of indicators, and will materially influence the accuracy of the determination. Early methods of this type are those of Thilo, Handy, and Pemberton jun.

In 1902, however, a method which showed a distinct advance on the previous alkalimetric methods was published by A. Neumann. In this method the ammonia formed in the reaction with caustic soda is eliminated by boiling before titration. Neumann therefore avoids all errors

traceable to an indistinct end-point. Neumann's method was especially developed for the analysis of organic substances and in connection with a process for the combustion of the organic matter and the conversion of the phosphorus into phosphates by means of oxidising acids. The organic substance is oxidised by heating with a mixture of equal volumes of concentrated nitric and sulphuric acids, renewed as required. The oxidation is complete when the acid mixture remains clear and almost colourless after the boiling off of all the nitric acid. Neumann calls the product obtained an "acid-ash." By this process the well known danger of loss of the phosphorus of organic compounds by volatilisation during ignition is entirely obviated. The phosphate in this acid-ash, which must not contain more than a certain maximal amount of sulphuric acid, is precipitated as ammonium phosphomolybdate in the presence of ammonium nitrate (10%) by the addition of an aqueous solution of ammonium molybdate. The precipitate is washed acid-free by decantation with ice-cold water, dissolved in excess of seminormal sodium hydroxide, the ammonia is boiled off, and the excess of alkali is determined by titration with seminormal sulphuric acid. Neumann takes the equation given above as correctly representing the reaction which occurs with the alkali, and according to this each cubic centimetre of seminormal alkali interacting with the ammonium phosphomolybdate corresponds to 1.268 milligrams of  $P_2O_5$ .

Plimmer and Bayliss have modified Neumann's acid-ashing process by adding a definite volume of concentrated sulphuric acid at the beginning of the oxidation process, and putting in nitric acid from time to time as required until the oxidation is complete. This avoids the difficulty of limitation of the amount of acid mixture, which, in the case of substances containing much fat and carbohydrate, such as milk, is rather a serious disadvantage. Plimmer

and Bayliss also wash the precipitate in a different way; they use suction and water at ordinary temperatures, and are able to complete the washing in five minutes. Gregersen recommends precipitating in the presence of 15% ammonium nitrate instead of 10%, and states that there is a lower as well as an upper limit to the amount of sulphuric acid which may be present in the acid-ash. He also calls attention to a point of some importance which was overlooked by Neumann, that is, that it is necessary to eliminate carbon dioxide from the solution before the final titration; neglect of this leads to errors of several tenths of a cubic centimetre in the titration.

I have only been able to find one set of control experiments on Neumann's method showing really satisfactory results; this occurs in Gregersen's paper mentioned above. Neumann's own paper gives extremely few control experiments. Another series of control experiments published by Plimmer and Bayliss shows variations amounting to as much as 5%, yet on the basis of these results the authors describe the method as extremely accurate. Donath gives a set of control estimations showing variations of the same extent, and describes the method as elegant. Mathison makes the statement that on  $K_2HPO_4$  Neumann's method gave results agreeing to 1% with those obtained by the magnesia mixture method. Ehrström on the other hand states that the method sometimes gives inaccurate results for no apparent reason. In a recent paper by Haslam figures are given which go to show that in the determination of very small amounts of phosphorus (less than one milligram) Neumann's method may give results of higher accuracy than those obtainable by the usual methods of analysis. As, however, Neumann's method is one which is coming into general use for all classes of biochemical work, it seems that more detailed information as to the

errors to which the method may be subject will be of value. The present communication is an account of the errors I have met with in the use of this method, the effect of some conditions on these errors, and an attempt to locate them.

#### Details of Method.

Neumann's method was first used in the present work for the analysis of milk; the modification of the acid-ashing process due to Plimmer and Bayliss was used and carbon dioxide was eliminated before the final titration. In the second series of experiments the estimations were performed on standard phosphate solutions. Here, of course, the acid-ashing process is unnecessary, but when the requisite amount of sulphuric acid is added to the solution a product is obtained closely resembling the acid-ash of an organic substance, and the subsequent treatment of the two series of estimations is the same in each case. The following is a summary of a typical estimation on milk:—

Ten cc. of milk were placed in a 500 cc. round bottomed long necked Jena glass flask, 10 cc. of concentrated sulphuric acid and 10 cc. of concentrated nitric acid were added and the whole was gently heated until the nitrogen peroxide fumes thinned off; the mixture was then cooled, another 10 cc. of nitric acid were added, and the heating resumed till the fumes thinned off again. After four similar additions of nitric acid, the heating was continued until this had all been driven off; the mixture remained clear and became almost colourless after ten minutes' further heating, indicating completion of the oxidation. The time required was about four hours. After cooling, the acid-ash was diluted with about 30 cc. of water and boiled for five minutes (to get rid of the nitric oxide formed by the decomposition of the nitrosyl-sulphuric acid produced), then made up to 100 cc. with water, 35 cc. of 50% ammonium nitrate solution were added, the liquid was brought just to the

boil, and the phosphate was precipitated by the addition of 40 cc. of 10% ammonium molybdate, the liquid being thoroughly shaken up for about one minute after the addition. The precipitation performed thus occurs in the presence of 10% ammonium nitrate at a temperature not lower than  $70^{\circ}$ – $80^{\circ}$  C. and is complete in a few minutes. After standing for half an hour, the supernatant fluid was poured off through a thin 15 cm. filter, and the precipitate was washed four times by decantation with 150 cc. of ice-cold water each time (temperature  $5^{\circ}$ – $8^{\circ}$  C.), the filter being filled with iced water after each washing. The final washings were neutral to litmus. The filter, containing a small quantity of the precipitate, was then added to the main bulk in the flask, some water was put in, and N/2 NaOH was run in until the precipitate was dissolved (19.0 cc. required), 6.0 cc. excess being then added (total 25.0 cc.). The solution was diluted, the filter broken up by vigorous shaking, and the ammonia boiled off. The solution was then cooled, its volume was made up to 150 cc., 6 drops of 0.5% alcoholic phenolphthalein added, and titrated with N/2  $\text{H}_2\text{SO}_4$  (6.25 cc. required), 2.0 cc. excess were added, the  $\text{CO}_2$  was boiled off, and the hot solution neutralised again with N/2 NaOH (1.25 cc. required). Thus the total volume of alkali used was  $25.0 + 1.25 = 26.25$  cc., and of acid,  $6.65 + 2.0 = 8.65$  cc. The difference between these two volumes, 17.6 cc., multiplied by 1.268 gives 22.3, according to Neumann the number of milligrams of  $\text{P}_2\text{O}_5$  present.

An attempt was first made to wash the precipitate by suction in the way recommended by Plimmer and Bayliss, but in every case it was found impossible to prevent visible amounts of the precipitate from passing through the filter. The precipitation was also tried in the presence of 15% ammonium nitrate according to Gregersen's directions, but



as the variations shown by the duplicate analyses given in Table I were no less than those shown by the analyses performed as described above, Neumann's proportions were reverted to. The values given are the amounts of  $P_2O_5$  in 10 cc. of milk.

Table I.

*Amounts of  $P_2O_5$  found in 10 cc. of milk by Gregersen's modification of Neumann's method.*

Estimation.	Result A.	Result B.	Difference.
1	24.9 mg.	23.1 mg.	1.8 mg.
2	27.3 „	28.6 „	1.3 „
3	25.8 „	26.1 „	0.3 „
4	22.4 „	22.2 „	0.2 „

The maximum difference between any two of the results shown on this table is 1.8 mg.; the average difference between two estimations is 0.9 mg. (Compare with Table II.)

In the series of estimations on standard phosphate solutions the method of transferring the small amount of precipitate on the filter to the flask was different; the precipitate was dissolved out with 60 cc. of 1 : 3 ammonia, and the filter then washed ammonia free, the washings being added to the flask; the ammonia is all got rid of again in the subsequent boiling with caustic soda. This procedure makes the titration rather easier, as a large amount of filter paper in the solution is apt to obscure the end-point.

### Results.

(a) *Milk.*—The following are some of the results obtained in the analysis of milk, illustrating the very variable closeness of agreement between the duplicate analyses. The figures represent the amount of  $P_2O_5$  in 10 cc. of whole milk.

Table II.

*Amounts of  $P_2O_5$  found in 10 cc. of milk by Neumann's method.*

Estimation.	Result A.	Result B.	Difference.
5	21.4 mg.	21.0 mg.	0.4 mg.
6	19.8 „	22.0 „	2.2 „
7	21.9 „	22.5 „	0.6 „
8	23.9 „	25.3 „	1.4 „
9	27.9 „	26.8 „	1.1 „
10	21.4 „	21.3 „	0.1 „
11	22.3 „	22.3 „	0.0 „

The maximum difference between any two of the results in this table is 2.2 mg.; the average difference between two estimations is 0.8 mg.

(b) *Standard phosphate solution.*—The standard solutions of phosphate were prepared by dissolving 6.6 gm. of microcosmic salt in water and making the solutions up to one litre. These solutions have about the same concentration of  $P_2O_5$  as milk. The solutions were standardised either (a) by evaporating a known volume of the solution to dryness in a weighed crucible, igniting, and weighing the sodium metaphosphate formed, or (b) by estimating the amount of phosphate present by the magnesia mixture method. The values obtained by the two methods agree together as closely as the individual estimations of either method, as the following figures for solution A (about 3.3 gm. of microcosmic salt per litre) show:—

Table III.

*Standardisation of Phosphate Solution.*

Volume of solution.	Weight of $NaPO_3$	Weight of $Mg_2P_2O_7$	Weight of $P_2O_5$	$P_2O_5$ in 20 cc.
40 cc.	0.0349 gm.	...	0.0484 gm.	0.02420 gm.
40 „	0.0351 „	...	0.0487 „	0.02435 „
30 „	...	0.0574 gm.	0.0366 „	0.02436 „
30 „	...	0.0571 „	0.0364 „	0.02426 „
30 „	...	0.0576 „	0.0367 „	0.02440 „

The following table gives the results obtained by Neumann's method for the amount of  $P_2O_5$  in 10 cc. of the standard phosphate solutions. The errors vary considerably but are all positive.

Table IV.

*Amounts of  $P_2O_5$  found in 10 cc. of standard solutions by Neumann's method.*

Estimation.	Result by Neumann.	Difference from mean.	Result by weighing as	Percentage error.		
12	23.0 mg.	+ 0.29 mg.	$Mg_3P_2O_7$ (Soln. B.)	+ 3.1		
13	23.3 „	+ 0.09 „		4.0		
14	22.8 „	+ 0.49 „		2.2		
15	23.1 „	+ 0.19 „		22.3 mg.	3.6	
16	24.0 „	- 0.71 „		...	7.6	
17	23.7 „	- 0.41 „		...	6.2	
18	23.1 „	+ 0.19 „		...	3.6	
Mean	23.29 „	0.34 „		...	4.3	
19	22.7 „	+ 0.64 „		$NaPO_3$ (Soln. C.)	+ 0.9	
20	23.3 „	+ 0.04 „			3.6	
21	23.1 „	+ 0.24 „			2.7	
22	23.3 „	+ 0.04 „			22.5 mg.	3.6
23	23.5 „	- 0.16 „			...	4.4
24	23.3 „	+ 0.04 „			...	3.6
25	23.8 „	- 0.46 „			...	5.8
26	23.7 „	- 0.36 „			...	5.3
Mean	23.34 „	0.25 „			...	3.6

The extreme difference between any two members of the first series of the above results is 1.2 mg., and of the second series, 1.1 mg. The average difference from the mean in the first case is 0.34 mg., or 1.5%, and in the second case, 0.25 mg., or 1.1%. The mean of these figures is 1.3%, and this we may take as the average casual error of these results. The means of the figures for the percentage difference of the two above sets of results from the standard results are 4.3 and 3.6% respectively, and the mean of these two figures is 4.0%. This value represents the average constant error of the results. We see from the table, therefore, that as a first approximation, the results obtained

by Neumann's method are  $4.0\% \pm 1.3\%$  high. The casual error of the results shown here is a good deal smaller than those shown by the results on milk given in Tables I and II, a fact which seems to indicate that there may be sources of error in the preliminary acid-ashing process to which the milks were submitted.

#### Sources of Error.

In the estimation of phosphorus by the method of Neumann modified as described, there are, apart from the preliminary acid-ashing process, five stages at which sources of error may be sought.

1. The precipitation. It may (a) be incomplete, (b) the precipitate may not have the composition assigned to it.
2. The washing. (a) This may be insufficient, (b) the precipitate may be dissolved by the wash-water, (c) the precipitate may be decomposed by the wash-water.
3. The boiling off of ammonia. (a) It may be incomplete, (b) the substances present may be altered in some way.
4. The boiling off of carbon dioxide. (a) It may be incomplete, (b) the substances present may be altered.
5. The final titration. (a) The end point may not be satisfactory, (b) the value obtained will depend on the nature of the substances present.

Let us now consider the possibility of error coming in at these several stages.

1. (a) The completeness of the precipitation was proved by digesting the filtrate for several hours with excess of ammonium molybdate and ammonium nitrate. Mere traces only of further precipitation were ever obtained in this way, and as the precipitate contains only about  $1.6\%$  of phosphorus no appreciable error is introduced here. (b) At

the present stage of the work we have no grounds for stating whether the composition of the precipitate is that assumed by Neumann or not (see later).

2. (a) The sufficiency of the washing was proved by the neutrality to litmus of the wash-water. (b) By evaporating down the washings extremely slight amounts of the precipitate were found to have dissolved, but the quantity was too small to introduce any appreciable error. (c) It has been shown by Hundeshagen, and confirmed by Neumann, that large amounts of water cause the two loosely bound molecules of nitric acid to split off from the molecule of ammonium phosphomolybdate, a fact that was also noticed in the present work. This, however, is indicated by the washings becoming acid again, and washing was always stopped as soon as the washings became neutral.

3. (a) The freedom of the alkaline solution from ammonia was judged by testing the issuing steam with litmus paper. It was found necessary to boil the solution for considerably over an hour, instead of for twenty minutes, as stated by Neumann, before the issuing steam no longer reacted with litmus paper. The ammonia is therefore not readily got rid of. Bang considers this stage to be the weak point of the whole method, and recommends the removal of the ammonia as hexamethylene tetramine by the addition of formaldehyde. (b) We are not in a position to say whether this boiling, latterly with rather concentrated caustic soda, may not modify the substances present in some way.

4. (a) The acid solutions were vigorously boiled for ten minutes, so that little carbon dioxide could have remained in solution, and any error arising from this source must be very small. (b) With regard to any possible effect on the nature of the substances present we can again say nothing.

5. (a) The end-point of the titration left little to be desired, being determinable to one drop without difficulty.

This final titration was always performed on the acid solution while still nearly boiling, and although cold alkali was added, no error worth considering could be introduced in this way as the amount of alkali used was only about 1 cc. and the amount of carbonate introduced by it into the hot solution, if any, would be very small. (b) What has already been said about the composition of the substances in the solution applies here too.

All the errors set forth above about which we have definite information can thus only be of small amount, and of them three would tend to give high, two low results. The analysis of standard phosphate solutions showed us, however, that positive errors of considerable magnitude were invariably met with, and as all sources of error except those depending on the composition of the precipitate and the substances derived from it have been accounted for, we are forced to conclude either that the precipitate obtained has not the composition assumed, or that the reaction with the alkali does not take place according to the equation given above, or that the products formed are subsequently modified in such a way as to alter the amount of alkali combined with. These factors may also act simultaneously.

It has been shown by Baxter, Kilgore, Baxter and Griffin, Chesneau, Hissink and van der Waerden, Lagers, Artman, and by other workers, that the precipitate of ammonium phosphomolybdate as prepared by them invariably contained an amount of molybdenum in excess of that required by the formula given by Hundeshagen,  $(\text{NH}_4)_3 \cdot \text{PO}_4 \cdot 12 \text{MoO}_3 \cdot 2 \text{HNO}_3$ . It must be remembered that in preparing this substance Hundeshagen was careful to avoid excess of molybdic acid, whilst the precipitate obtained in the course of analysis is formed in the presence of considerable excess of molybdate. Hissink and van der Waerden, Richardson, and Artman have also shown that the presence of sulphuric

acid still further increases the amount of molybdenum found in this precipitate, the amount increasing with the quantity of sulphuric acid present until according to Hissink and van der Waerden, a maximum of 12.65 Mo for each P is reached. Richardson, and Artman state that the precipitate formed in the presence of sulphuric acid or a sulphate always contains sulphate, even after being washed till neutral. Richardson supposes that sulphuric acid may to a certain extent form a sulphomolybdate analogous to the phosphomolybdate, and which would react towards alkali like the latter. In the precipitate prepared as described above, however, I have not been able to detect more than traces of sulphate after complete washing. The precipitate was dissolved in sodium hydroxide and the ammonia boiled off. The solution was acidified with hydrochloric acid, and barium chloride was added. Richardson, and Artman simply dissolved the precipitate in nitric acid and then tested with barium chloride.

The conditions under which the precipitate of ammonium phosphomolybdate is formed in Neumann's method for the estimation of phosphorus thus seem to be particularly favourable to the appearance of a precipitate containing excess of molybdenum. I have, therefore, determined the amount of molybdenum contained in the precipitate formed under these conditions in order to discover what part of the error observed may be due to excess of molybdenum, as this would enable the precipitate to react with a larger amount of alkali than that assumed by the formula given above and therefore lead to high results in the estimations by Neumann's method.

**Molybdenum-content of precipitate of Ammonium  
Phosphomolybdate.**

After trying several methods for the estimation of molybdenum, the method given by Brearley and Ibbotson

for the estimation of phosphorus was adopted. In this method the precipitate of ammonium phosphomolybdate is dissolved in ammonium hydroxide, the solution is nearly neutralised, and the phosphate and molybdate are precipitated together as a mixture of lead phosphate and lead molybdate by the addition of lead acetate. The phosphate is said not to be precipitated quite completely in this way, but as the lead phosphate formed amounts to only 10% of the whole precipitate the error introduced is not large. Knowing the amount of phosphate present we may calculate the weight of lead phosphate which should be formed, and by subtracting this from the total weight of the mixed precipitate we may obtain the weight of lead molybdate thrown down. The following are the details of an estimation.

The precipitate of ammonium phosphomolybdate obtained as described above from 10 cc. of standard phosphate solution was washed acid free with iced water and dissolved in ammonium hydroxide, the solution was made up to 200 cc. and divided into two equal parts, each part being then treated independently. The ammonia was nearly neutralised with hydrochloric acid, about 20 gm. of ammonium chloride were added, the solution was heated to boiling, and 200 cc. of a boiling solution of lead acetate and acetic acid (16 cc. 50%, saturated, lead acetate and 16 cc. of glacial acetic acid made up to 1000 cc.) were poured in. A dense white precipitate immediately formed, and the boiling was continued for ten minutes to ensure that the precipitate became granular. The precipitate is finely divided and very heavy, but when prepared as described it filters easily. The precipitate was washed free from chlorides with hot water and ignited with the filter in a muffle, very high temperatures being avoided as the precipitate is fusible.



Each precipitate obtained thus contains the equivalent of 11.28 mg. of  $P_2O_5$  (standard solution D). We see from the formula of Hundeshagen for the ammonium phosphomolybdate that for each molecule of  $Pb_3(PO_4)_2$  24 molecules of  $PbMoO_4$  should be formed. The weight of lead phosphate corresponding to the above amount of  $P_2O_5$  is  $0.01128 \times 811/142 = 0.0644$  gm. ( $P_2O_5 = 142$ ,  $Pb_3(PO_4)_2 = 811$ ); the weight of lead molybdate formed at the same time should be  $0.01128 \times 24 \times 367.1/142 = 0.699$  gm. ( $PbMoO_4 = 367.1$ ). The total weight of the precipitate should therefore be  $0.0644 + 0.699 = 0.7634$  gm. The weights of the precipitates of lead phosphate and lead molybdate actually obtained are given in the following table:—

Table V.

*Weights of lead phosphate and lead molybdate equivalent to 11.28 mg. of  $P_2O_5$ .*

Phosphomolybdate precipitate.	Weight of Lead Salts from		Mean of Two Results
	Portion A.	Portion B.	
27	0.8075 gm.	0.8048 gm.	0.8062 gm.
28	0.8048 "	0.8049 "	0.8049 "
29	0.8085 "	0.8050 "	0.8067 "
30	0.8118 "	0.8095 "	0.8107 "

The mean weight for the whole series is 0.8071 gm. If 0.0644 gm., the weight of the lead phosphate formed, be subtracted from this we get 0.7427 gm. instead of 0.699 gm. as the weight of the lead molybdate formed. This number is 6.25% in excess of that required by the formula of ammonium phosphomolybdate used by Neumann, and instead of  $(NH_4)_3PO_4 \cdot 12 MoO_3 \cdot 2 HNO_3$  would give us  $(NH_4)_3PO_4 \cdot 12.75 MoO_3 \cdot 2 HNO_3$ . This result is not far from that of Hissink and van der Waerden mentioned above; they found the molecular proportion of  $MoO_3$  to be 12.65. Assuming the excess of molybdenum to be present as molyb-

date, each formula weight of the precipitate containing the proportion of molybdenum found in the present case should require for its neutralisation 29.5 mols of NaOH instead of 28 as assumed by Neumann, so that the results calculated by means of Neumann's factor would be  $(29.5/28 - 1) 100 = 5.2\%$  too high. This excess of molybdenum is therefore sufficient to account for the high results shown in Table IV. The error of these results is  $+ 4\% \pm 1.3\%$ .

#### **Influence of some conditions on the Error.**

The influence of the following conditions upon the error of the results obtained in the estimation of phosphorus by Neumann's method have been observed:—

1. Amount of phosphate estimated.
2. Rate of addition of precipitant.
3. Length of time between precipitation and filtration.
4. Temperature of precipitation.

1. *Amount of Phosphate estimated.*—Forty cc. of 10% ammonium molybdate solution are stated by Neumann to be a suitable amount for the precipitation of any quantity of  $P_2O_5$  between two or three milligrammes and sixty milligrammes. As, however, errors had already been encountered in the use of Neumann's method, three series of estimations were performed on different amounts of standard phosphate solution to ascertain whether these errors remained about the same size or depended upon the amount of phosphate precipitated. The proportions of the reagents used for the precipitation were those given previously; the amounts of sodium hydroxide used to dissolve the precipitates were, of course, increased in proportion to the amount of phosphate present, but the procedure was otherwise as described above. The following are the results obtained:—

Table VI.

*Influence of amount of phosphate estimated on error of Neumann's method.*

Estimation.	P <sub>2</sub> O <sub>5</sub> present.	P <sub>2</sub> O <sub>5</sub> found.	Percentage Error.	Deviation from Mean.
31	44.5 mg.	51.0 mg.	+ 14.3	+ 0.6 mg.
32		50.3 "	12.7	- 0.1 "
33		50.0 "	12.1	- 0.4 "
34		49.9 "	11.9	- 0.5 "
Mean		50.4 "	13.2	
12	22.3 mg.	23.0 "	+ 3.4	0.0 "
13		23.2 "	3.8	+ 0.2 "
14		22.8 "	2.2	- 0.2 "
15		23.1 "	3.6	+ 0.1 "
Mean		23.0 "	3.4	
35	11.25 mg.	11.4 "	+ 0.9	- 0.1 "
36		11.7 "	+ 3.5	+ 0.2 "
37		11.7 "	+ 3.5	+ 0.2 "
38		11.2 "	- 0.9	- 0.3 "
Mean		11.5 "	+ 1.8	

These results show that the error increased rapidly with the amount of phosphate estimated. For 44.5 mg. of P<sub>2</sub>O<sub>5</sub> the average error is 13.2%, for 22.3 mg. it is 3.4%, for 11.25 mg. it is 1.8%. The results for 11.25 mg. of P<sub>2</sub>O<sub>5</sub> are peculiar as among them there is one with a negative error. The percentage error of these results shows a considerable variation, but the actual differences of the results from the mean value show that the absolute error is no greater than those shown by the other series of estimations.

2. *Rate on addition of Precipitant.*—The rate of addition of the precipitant is stated by Baxter and Griffin and by Artman to exert a marked influence on the excess of molybdenum carried down by the precipitate of ammonium phosphomolybdate; rapid addition of the ammonium molybdate leads to the appearance of a precipitate containing more molybdenum than is present in the precipitate formed

by the slow addition of the ammonium molybdate. This effect is ascribed to the occurrence of local excess of the reagent when the latter is added quickly. The following are the results obtained when two, three, five, and ten minutes were the respective times taken to add the precipitant to the phosphate solution. The solution was thoroughly shaken while the precipitant was being added.

Table VII.

*Influence of rate of addition of precipitant on error.*

Estimation.	Precipitant added in.	P <sub>2</sub> O <sub>5</sub> found.	P <sub>2</sub> O <sub>5</sub> present.	Error, per cent.
39	10 min.	22.8 mg.		+ 1.2
40	5 "	23.8 "		5.8
41	3 "	23.8 "	22.5 mg.	5.8
42	2 "	23.2 "		3.0
	poured in	23.6 "		5.0

As long as the time taken to add the precipitant remains less than five minutes, therefore, no certain diminution of the positive error is observed. When the precipitant is added, in ten minutes, there is a considerable diminution of the error, but as the solution has by this time cooled down about 20° C., this diminution is due to incomplete precipitation and not to any decrease in the excess of molybdenum due to the slow addition of the ammonium molybdate (*vide infra*).

3. *Length of time between filtration and precipitation.*—Baxter and Griffin concluded from their experiments that the excess of molybdenum in the precipitate of ammonium phosphomolybdate obtained by them was due to the occlusion of a mixture of ammonium molybdate and molybdic acid, and showed that this occlusion apparently took place in two stages, (1) during the precipitation, (2) while the precipitate, already formed, lay in contact with the mother liquor. They therefore advise that the precipitate be filtered off as soon as is compatible with complete

precipitation. In Neumann's method the length of time for which the precipitate of ammonium phosphomolybdate remains in contact with the mother liquor is not long, about thirty minutes, so, as will be seen from the following experiments, this factor is not likely to be the source of any considerable error. Two pairs of phosphate estimations were carried out by Neumann's method on 20 cc. portions of standard phosphate solution, the precipitates in one case being filtered off after having stood under the mother liquor for twenty minutes, in the other case being left in contact with the mother liquor for three days. The following are the results obtained:—

Table VIII.

*Influence of length of time between precipitation and filtration on error.*

Estimation.	Stood for	P <sub>2</sub> O <sub>5</sub> found.	P <sub>2</sub> O <sub>5</sub> present.	Error, per cent.
33	20 min.	50.0 mg.	44.6 mg,	+ 12.1
34	20 „	49.9 „		11.9
31	3 days	51.0 „	44.6 mg,	14.3
32	3 „	50.3 „		12.7

The increase in the error of the results given by the precipitates which have stood the longer time in contact with the mother liquor is within the experimental variations to which the method is subject, so that, contrary to what Baxter and Griffin found in their case, here variations in the length of time of contact between precipitate and mother liquor do not affect the composition of the precipitate.

4. *Temperature of precipitation.*—Baxter states that the temperature of precipitation has an important influence on the excess of molybdenum carried down by the precipitate of ammonium phosphomolybdate. When the precipitation occurred at room temperature, Baxter found an excess of about 1% of molybdenum in the precipitate; in the pre-

precipitate obtained at  $50^{\circ}$ – $60^{\circ}$  C. the excess of molybdenum was about twice as great. Chesneau also calls attention to the effect of temperature on the composition of this precipitate. He states that above  $65^{\circ}$ – $70^{\circ}$  C. ammonium tetramolybdate— $(\text{NH}_4)_2\text{O}\cdot 4\text{MoO}_3$ —is formed in a solution of ammonium molybdate, and that it is this substance which is carried down by the precipitate of ammonium phosphomolybdate. Many other authors state that at high temperatures molybdic acid is thrown down from solutions of ammonium molybdate, and that the precipitate of ammonium phosphomolybdate formed is contaminated with this. Precipitation at as low a temperature as possible is therefore generally advised. With the proportions of the reagents used by Neumann, however, it was not found possible to bring about precipitation within reasonable time at low temperatures. When the solutions were kept at room temperature no sign of precipitation appeared even after standing for two days. When the reagents were mixed at  $40^{\circ}$  C. and maintained at this temperature, only partial precipitation had occurred after four hours. Even at  $60^{\circ}$ – $70^{\circ}$  C. the precipitation was by no means complete in half an hour. It was therefore found necessary, in order to ensure complete precipitation, to adhere to the temperature of precipitation set down by Neumann.

#### Summary.

1. The values obtained in the estimation of phosphate by Neumann's method were always high, the error increasing with the amount of phosphate estimated. For 22 mg. of  $\text{P}_2\text{O}_5$  the mean error was + 4%.

2. The source of this error is an excess of molybdenum carried down in the precipitate of ammonium phosphomolybdate.

3. The error does not depend on the rate of addition of the precipitant.

4. The error is independent of the time of contact between the precipitate and the mother liquor.

5. The error cannot be reduced by lowering the temperature of precipitation, as this leads to incomplete precipitation.

In conclusion I wish to express my thanks to Professor Anderson Stuart, in whose laboratory this work was done, and to Assistant-Professor Chapman for his advice and encouragement.

## REFERENCES.

- Artmann (1910), *Zeitschr. f. analyt. Chem.*, XLIX, 1.  
 Bang (1911), *Biochem. Zeitschr.*, XXXII, 443.  
 Baxter (1902), *Amer. Chem. J.*, XXVIII, 298.  
 — and Griffin (1905), *Ibid.*, XXXIV, 204.  
 Chesneau (1907), *Comptes rendues*, CXLV, 720.  
 — (1908), *Ibid.*, CXLVI, 758.  
 Donath (1904), *Zeitschr. f. physiol. Chem.*, XLII, 141.  
 Eggertz (1860), *J. f. prakt. Chem.*, LXXIX, 496.  
 Ehrström (1903), *Skand. Arch. f. Physiol.*, XIV, 82.  
 Gregersen (1907), *Zeitschr. f. physiol. Chem.*, LIII, 453.  
 Grete (1889), *Zeitschr. f. analyt. Chem.*, XXVIII, 617.  
 Handy (1892), *Chemical News*, LXVI, 324.  
 Haslam (1913), *Biochem. J.*, VII, 492.  
 Hissink and van der Waerden (1905), *Chem. Weekblad*, II, 179.  
 (Cited by Lagers, *loc. cit.*)  
 Hundeshagen (1889), *Zeitschr. f. analyt. Chem.*, XXVIII, 141.  
 Ibbotson and Brearley (1900), *Chemical News*, LXXXII, 55.  
 — — *Ibid.*, LXXXIII, 122.  
 Kilgore (1894), *J. Amer. Chem. Soc.*, XVI, 765.  
 Lagers (1908), *Zeitschr. f. analyt. Chem.*, XLVII, 561.  
 Mathison (1909), *Biochem. J.*, IV, 233.  
 Neumann (1902), *Zeitschr. f. physiol. Chem.*, XXXVII, 115.  
 — (1904), *Ibid.*, XLIII, 32. See also :  
 — (1897), *Arch. f. Anat. u. Physiol., physiol. Abth.*, 552.  
 — (1900), *Ibid.*, 159.  
 Pemberton jun. (1893), *J. Amer. Chem. Soc.*, XV, 382.  
 Plimmer and Bayliss (1906), *J. of Physiology*, XXXIII, 439.  
 Richardson (1907), *J. Amer. Chem. Soc.*, XXIX, 1314.  
 Sonnenschein (1851), *J. f. prakt. Chem.*, LIII, 343.  
 Thilo (1887), *Chem. Zeitung*, XI, 193.  
 (Cited by Lenz (1888), *Zeitschr. f. analyt. Chem.*, XXVII, 251).

## HEPATICÆ AUSTRALES.

By Dr. FRANZ STEPHANI and the Rev. W. WALTER WATTS.

(Communicated by Mr. J. H. MAIDEN.)

[*Read before the Royal Society of N. S. Wales, June 3, 1914.*]

**Introduction.**

By W. WALTER WATTS.

FOR some years I have been in the habit of sending specimens of Hepatics, collected in various parts of Australia, to Dr. Franz Stephani, of Leipsic, whose phenomenal labours in this family of Cryptogamic plants have won for him a world-wide fame. My own collecting has been done, mainly, in the following districts:—the Richmond River; the Blue Mountains, including Mount Wilson; New England; Yarrangobilly; the South Coast as far down as Cambewarra; and Wyong, about 60 miles north of Sydney. A considerable number of new species, collected by me and by the late Mr. W. Forsyth, have already been described by Dr. Stephani and published in his great systematic work, "Species Hepaticarum." The present paper contains descriptions of 49 new species by Dr. Stephani, and many new records, which will form a substantial addition to our knowledge of the Hepatics of Australia, and especially of New South Wales.

Through the kind services of Dr. Annand and the Rev. F. G. Bowie, M.A., of Tangoa, Santo, of the Rev. T. Riddle, late of Epi, and particularly of the Rev. Dr. Gunn, of Aneityum and Futuna, I have been enabled to send to Dr. Stephani a considerable number of specimens from the New Hebrides; as well as material collected by myself on Lord Howe Island. Some of Dr. Gunn's material reached Dr. Stephani through the Rev. David Lillie, of Caithness, N.B.



In the present paper, Dr. Stephani describes 27 new species from the New Hebrides and 6 from Lord Howe Island. The new species found in Mr. Lillie's parcel are not described herein, but are placed on record in the belief that they are described, or are about to be described, elsewhere. Dr. Gunn is to be congratulated upon the remarkably interesting material collected by him, and by the natives under his direction; and it is to be sincerely hoped that he will continue to prosecute his researches.

The new Australian species herein described, and the records herein published, may be compared with those published by Carrington and Pearson in the Proceedings of the Linnean Society of N.S.W. in 1887, p. 1035, collected by Mr. Thomas Whitelegge. Unless otherwise stated, all the Australian species herein recorded were collected by me.

#### **Hepaticæ Australes.**

##### *Aneura aequicellularis* St., n.sp.

Sterilis parva gracillima, viridis, in rupibus humidis pulvinatim caespitans. *Frons* ad 2 cm. longa, pinnata et bipinnata, in sectione transversa biconvexa (0.67 mm. lata, 0.25 mm. crassa) marginibus acutis. *Cellulae* corticales  $27 \times 72\mu$ , internae vix minores. Reliqua desunt.

*Hab.* Australia, New South Wales, (Wentworth Falls): Watts legit No. 1117.

##### *Aneura bipinnata* St., Blackheath, N.S.W.

##### *Aneura gigantea* St., n.sp.

Sterilis. *Frons* ad 8 cm. longa, 15 mm. lata, tenuis, flaccida, rufescens vel fusco-brunnea in sicco subatra, marginibus breviter lateque inciso-lobatis, lobis oblique patulis, integerrimis vel apice minute inciso-bidentulis. *Cellulae corticales* unistratosae, tenerimae parvae, duplo longiores quam latae, *cellulae internae* multoties majores, unistratosae, 0.13 mm. latae, 0.25 mm. longae.

*Hab.* Australia, N.S. Wales, (Cambewarra): Watts legit No. 920.

*Aneura Gunniana* St., n.sp.

Dioica mediocris, pallide virens, in cortice dense depresso-caespitans. *Frons* ad 2 cm. longa, irregulariter longeque pinnata et bipinnata, tenuis (1.83 mm. lata, 0.17 mm. crassa) ramis trunco subaequilatis, omnibus plano-convexis, utrinque longe attenuatis, cuticula levis. *Frondis cellulae* internae subaequales, corticales multo majores (in sectione transversa). *Rami masculi* in trunco numerosi, minute spicati, alveolis paucijugis.

*Hab.* Insulae Novae Hebridae (Aneityum): Dr. Gunn legit (Watts 57).

*Aneura hebridensis* St., n.sp.

Monoica, minor, pallide virens, flaccida, pulvinatim caespitans. *Frons* ad 2 cm. longa, irregulariter longeque bipinnata, in sectione transversa biconvexa, triplo latior quam crassa, marginibus acutis; rami vix angustiores, simillimi, saepe flagellatim attenuati, radicantes. *Cellulae* frondis internae aequimagnae, quam corticales multo majores. *Rami feminei* (steriles) capitati, piliferi, rami masculi validi, alveolis numerosis.

*Hab.* Novae Hebridae (Aneityum): Dr. Gunn legit (Watts, 57a)

*Aneura pusilla* St., n.sp.

Sterilis, exigua, in rupibus calcareis caespitans. *Frons* ad 15 mm. longa, regulariter breviterque bipinnata; truncus primarius 1.17 mm. latus, plano-biconvexus, 0.25 mm. crassus, marginibus frondis utrinque obtusis, facie postica subplana; rami gradatim angustiores, ultimis filiformibus saepe flagellatim attenuatis radicanibus. *Cellulae* frondis corticales parvae, internae multo majores, centrales maximae, parietibus ubique tenuibus.

*Hab.* Australia, (Old Railway Cutting, Blackheath): Watts legit, 1051.

*Aneura rufescens* St., n.sp.

Dioica maxima rigidula, dilute brunnea, dense depresso caespitans, muscis consociata, terricola. *Frons* ad 6 cm. longa, regulariter breviterque pinnata, pinnis brevibus, 5 mm. longis, apice saepe flagellatis, radicanibus, in trunco ramisque anguste alata, alis

2 – 3 cellulas latis; in sectione transversa plano-biconvexa (medio 10 cellulas crassa) cellulae corticales multo minores. *Androecia* numerosa, in ramulis pusillis, alveolis 6 – 8 jugis. Reliqua desunt.

*Hab.* Australia, New South Wales, (National Pass, Wentworth Falls): Watts legit, 1124.

*Aneura tasmanica* St., Horse Shoe Falls, Blackheath, N.S.W.

*Aneura Walesiana* St., n.sp.

Dioica, mediocris, rufescens, rigidula, in rupibus humidis dense depresso-caespitans. *Frons* ad 25 mm. longa, regulariter breviterque pinnulata; pinnis approximatis, oblique patulis, trunco primario duplo angustioribus, 4 – 5 mm. longis, linearibus, rarius flagellatim attenuatis; truncus primarius anguste biconvexus, 2.17 mm. latus, medio 0.33 mm. crassus; *cellulae* internae magnae aequales, corticales multo minores; rami masculi breves, alveolis paucijugis.

*Hab.* Australia, New South Wales, (Blackheath): Watts legit, 1023.

*Archilejeunea Wattsiana* St., n.sp.

Autoica, mediocris, flavescens, flaccida, corticola, dense depresso-caespitans. *Caulis* ad 2 cm. longus, irregulariter remoteque pin-natus. *Folia* caulina conferta, recte patula, parum concava, in plano ovato-elliptica; symmetrica (2 mm. longa, ubique 1.5 mm. lata) apice late rotundata, brevissima basi inserta, basi antica longe truncata, caulem vix tegentia, integerrima. *Cellulae* superae 18/18 $\mu$ , basales 27/36 $\mu$ , trigonis magnis. *Amphigastria caulina* late obconica, caule quintuplo-latiora, transverse inserta, apice late truncato-rotundata, integerrima. *Perianthia* utrinque innovata, obovato-oblonga (3 mm. longa, 1.5 mm. lata) apice truncato-rotundata, rostro parvo, plicis posticis angustis, longe decurrentibus, divergentibus. *Folia floralia* perianthio parum breviora, obovato-oblonga, acuta, superne regulariter minuteque dentata, falcatis patula, *lobulus* tertio brevior, linearis, breviter solutus, acutus. *Amphigastrium florale* lobulis aequilongum ligulatum, leviter

obconicum, apice breviter emarginato-bidentatum irregulariterque spinulosum. *Androecia* in parvis ramulis terminalia, bracteis quadrijugis.

*Hab.* Lord Howe Island, (Transit Hill): Watts legit, 127.

*Balantiopsis decurrens* St., n.sp.

Sterilis mediocris, flaccida, flavo-rufescens, terricola, dense depresso-caespitans, subpulvinata. *Caulis* ad 2 cm. longus, parum longeque ramosus. *Folia caulina* conferta, recte patula, leviter concava, decurvula, in plano anguste oblonga (2·17 mm. longa, medio 1 mm. lata, basi utrinque breviter decurrentia, apice late emarginata, angulis spina valida armatis; adsuntspinae 2, medianae ad remotae in margine supero foliorum. *Cellulae* superae 18/18 $\mu$ , basales 18/36 $\mu$ , paucis majoribus interjectis 18/54 $\mu$ ; cuticula aspera. *Lobulus* folio oblique incumbens, duplo brevior, 1 mm. longus et latus, carina 0·67 mm. longa, leviter sinuata, apice late emarginatus, angulis spina valida armatis, sub apice utrinque remote bidentulus. *Amphigastria caulina* lobulo aequimagna, profunde sinuatim inserta angustequae decurrentia, profunde bifida, sinu angusto, lobis linearibus, apice trisetosis, supra basin utrinque unidentata, medio utrinque longa seta inserta, setis apice breviter furcatis.

*Hab.* Australia, (Wyang): Watts, 985.

*Balantiopsis diphylla* (Tayl.) Mitt. Valley of Waters, N.S.W.

*Balantiopsis hastatistipula* St., n.sp.

Sterilis, mediocris, flaccida, rufescens, terricola, laxe intricata. *Caulis* ad 3 cm. longus, parum longeque ramosus. *Folia caulina* conferta, oblique patula, decurva, in plano oblonga (2·17 mm. longa, medio 1 mm. lata) apice breviter emarginato-biloba, sinu subrecto, lobis late triangulatis acutis porrectis, sub apice utrinque unispinis. *Cellulae* superae 18/27 $\mu$ , basales 18/72 $\mu$  trigonis nullis. *Lobulus* anticus folio oblique incumbens aequilatus, rhomboideus, apice late truncatus, grosse quadrifidus, laciniis inaequalibus, superis validioribus, omnibus e lata basi cuspidatis. *Amphigastria caulina* lobulo foliorum aequimagna, sinuatim inserta, basi hastatim

hamata, supra basin utrinque longa seta armata, apice ad medium biloba, lobis late linearibus, apice longissime emarginato-bispinosis.

*Hab.* Australia, (Blackheath), Watts, 1052.

*Balantiopsis Kingwella* St., n.sp.

Sterilis mediocris, flaccida, tenerrima, flavicans, terricola, dense depresso-caespitans. *Caulis* ad 25 mm. longus, simplex vel parum longeque ramosus. *Folia caulina* conferta, oblique patula, leviter decurva, in plano ovata (1.67 mm. longa, medio 1.1 mm. lata) apice ad 1/6 emarginato-biloba, sinu semirotondo, segmentis e lata basi setaceis, porrectis, sub apice utrinque remote bisetulis. *Cellulae* superae 27/27 $\mu$ , basales 18/54 $\mu$ , trigonis nullis, cuticula striolata. *Lobulus* folio duplo minor, oblique incumbens, ovatus, carina folio triplo brevior, substricta, apice ad 1/4 emarginato-bilobatus, lobis e lata basi attenuatis, apice setaceis, sub apice varie spinosus, spinis 1 - 3. *Amphigastria caulina* folio multo minora (0.83 mm. longa et lata) apice breviter biloba, lobis apice emarginato-bisetulis, sub apice utrinque quadriseta.

*Hab.* Australia, (Kingwell, Wyong): Watts, 943.

*Balantiopsis pusilla* St., n.sp.

Sterilis pusilla rufescens, in rupibus dense depresso-caespitans. *Caulis* ad 15 mm. longus, tenuis, parum longeque ramosus. *Folia caulina* contigua, oblique patula, plana, oblongo-elliptica (1 mm. longa, medio 0.67 mm. lata) laciniis exceptis, apice longe trifida, laciniis remotis, angustis 0.17 mm. ad 0.25 mm. longis. *Cellulae* foliorum superae 18/36 $\mu$ , basales 18/54 $\mu$  trigonis minutis. *Lobulus* majusculus, folio triplo brevior, e lata basi lanceolatus, inaequaliter bifidus. *Amphigastria caulina* magna, ambitu obovata, disco basali integro obtusato, supra basin utrinque bidentato, apice longissime bifido, laciniis linearibus, disco aequilongis, apice breviter furcatis.

*Hab.* Australia occidentalis (Herb. Watts). [I have no trace of this.—W.W.W.]

*Balantiopsis subkingwella* St., n.sp.

Dioica, mediocris flaccida, dilute brunnea, terricola, laxe caespitans. *Caulis* ad 25 mm. longus, simplex vel parum longeque

ramosus. *Folia caulina* conferta, oblique patula, parum concava, in plano oblonga (2 mm. longa, 0.83 mm. lata) apice vix angustiore, brevi basi inserta, apice ligulata, margine *supero* 8 spinoso, spinis irregularibus, validis et angustis, plus minus longis mixtis, apice ad 1/6 inciso-biloba, sinu recto, lobis late triangulatis, longis apiculatis, margine *infero* superne paucispinoso. *Cellulae* superae  $18/27\mu$ , basales  $18/54\mu$ , mediae  $18/36\mu$ , trigonis nullis, cuticula striolata. *Amphigastria* caulina magna (ambitu 1.33 mm. longa, 1.67 mm. lata) sinuatim inserta, supra basin utrinque unispina, medio utrinque grosse unispina, spinis supra basin utrinque longa seta armatis, apice longe bifida (0.83 mm. longa) segmentis validis, apice geminatim bifidis, sub apice utrinque longa seta armatis. *Sacculus* floralis grosse cylindricus; folia floralia caulinis simillima, majora. *Androecia* desunt.

*Hab.* Australia (Kingwell, Wyong): Watts, 945, 971a.

*Balantiopsis Wattiana* St., n.sp.

Sterilis mediocris, flaccida, flavo-rufescens, terricola, dense depresso-caespitans. *Caulis* ad 2 cm. longus, simplex vel parum longeque ramosus. *Folia caulina* conferta, oblique patula, leviter decurva, in plano late obovata (1.83 mm. longa, 1 mm. lata) symmetrica, apice ad 1/5 biloba, sinu recto obtuso, lobis late triangulatis cuspidatis, sub apice utrinque remote valideque trisetosa. *Cellulae* superae  $18/36\mu$ , basales  $27/90\mu$ , parietibus tenuibus, cuticula levis. *Lobulus* folio duplo minor subquadratus, carina brevis, folio oblique incumbens, apice latissime emarginatus, grosse bilobatus, lobis e lata basi longe setosis, sub apice utrinque remote bispinosus. *Amphigastria caulina* lobulo foliorum subaequimagna, transverse inserta, ad 2/3 inciso-bifida, disco basali integro obtusato, laciniis lanceolatis longeque in setam excurrentibus, in sinu nudis, extus remote grosseque trisetosis.

*Hab.* Australia, N.S. Wales, (Blackheath and Wyong): Watts leg. 940a, 973, 949, etc.

*Brachirolejeunea grossivitta* St., n.sp.

Sterilis magna, robusta, flaccida, rufo-brunnea, corticola, dense depresso-caespitans. *Caulis* ad 5 cm. longus, irregulariter pinnatus,

pinnis 1 - 2 cm. longis, simplicibus, paucis longioribus interjectis, similiter pinnulatis. *Folia* caulina confertissima, oblique patula, falcata, canaliculatim concava, in plano ovato-oblonga (2 mm. longa, medio 1 mm. lata) ad medium inserta, apice acuta, basi antica rotundata, caulem tegentia, integerrima. *Cellulae* foliorum superae 18/18 $\mu$ , basales 18/54 $\mu$ , parietibus tenuibus. *Lobulus* folio quadruplo brevior, ovato-triangularis, carina substricta, amplo sinu in folium excurrente, apice quam basis quadruplo angustiore, truncato, angulo spina valida porrecta armato. *Amphigastria caulina* magna (1 mm. longa et lata) transverse inserta, subrotunda, medio gibbosa, integerrima.

*Hab.* Novae Hebridæ (Aneityum): Gunn legit (Watts, 23).

*Chandonanthus difficilis* St., n.sp.

Sterilis magna robusta rigida, flavo-rufescens, terricola, laxè intricata lateque expansa. *Caulis* ad 7 cm. longus, simplex vel parum longeque ramosus. *Folia* caulina confertissima, valde concava, squarrose patula, in plano 3.4 mm. lata, 2 mm. longa, profundissime quadrifida, laciniis canaliculatim concavis, cuspidatis, remote grosseque spinosis, inaequalibus, *lacinia supera* valde irregulariter armata, spinis plus minus longis, validis vel angustis iterum spinosis vel nudis, hamatis vel strictis, *laciniae reliquae* latiores, apice grosse trifidae, sparsim valideque spinosae, lacinia quarta ultima integerrima. *Amphigastria caulina* parva, breviter bifida, marginibus ubique irregulariter spinosis.

*Hab.* Novae Hebridæ (Aneityum): Gunn leg. (Watts, 29).

*Chandonanthus fragillima* St., Aneityum: comm. Gunn, per Rev. D. Lillie.

*Chandonanthus hamatus* St., Aneityum and Futuna: com. Gunn, (Herb. Watts).

*Cheilolejeunea hamata* St., n.sp.

Dioica major gracillima, viridis, flaccida, corticola, dense depresso-caespitans maximeque intricata. *Caulis* ad 6 cm. longus, bipinnatus, ramis primariis 2 cm. longis, ubique remote minuteque pinnatis. *Folia caulina* oblique patula, parum imbricata, concava

apiceque decurva, in plano ovata (0.9 mm. longa, medio 0.6 mm. lata) ad medium inserta, basi antica truncato-rotundata, apice late acuminata acuta. *Lobulus* oblongus, folio subtriplo brevior, carina oblique adscendens, leviter arcuata, amplo sinu in folium excurrens, apice oblique truncato, angulo acuto, sub apice constrictus. *Amphigastria caulina* maxima, caule triplo latiora, leviter sinuatim inserta, ad  $2/3$  emarginato-biloba, sinu recto obtuso, lobis late lanceolatis porrectis acutis. *Flores feminei* uno latere innovati. *Folia floralia* caulinis aequilonga, lanceolata, acuta, lobulo duplo brevior, lineari, breviter soluto, apice rotundato. *Amphigastrium florale* foliis floralibus parum brevius, lanceolatum, ultra medium emarginato-bifidum, rima angusta, laciniis anguste lanceolatis porrectis acutis.

*Hab.* Novae Hebridae (Aneityum): comm. Gunn, (Watts, 60).

*Cheilolejeunea parvisaccata* St., Tangoa, Santo: leg. Dr. Annand, 1909.

*Cheilolejeunea Wattsiana* St., n.sp.

Dioica pusilla flaccida, viridis, corticola, pulvinatim caespitans. *Caulis* ad 15 mm. longus, capillaceus, irregulariter denseque ramosus. *Folia caulina* parum imbricata subrecte patula, valde decurva, in plano ovata, subsymmetrica apice obtusa, basi antica truncato-rotundata. *Cellulae* superae  $18/18\mu$  trigonis nullis, basales  $27/45\mu$  trigonis majusculis. *Lobulus* parvus, obovatus, folio quadruplo brevior, carina oblique adscendens, stricta, stricte in folium excurrens, apice oblique emarginatus, angulo acuto. *Amphigastria caulina* majuscula, caule triplo latiora, transverse inserta, apice ad  $1/3$  emarginato-biloba, sinu subrecto, lobis triangulatis acutis. *Folia floralia* caulinis multo majora, spathulata (1.33 mm. longa, medio supero 0.67 mm. lata) apice obtusa; lobulus magnus, tertio brevior, anguste spathulatus ad  $1/3$  solutus, obtusus. *Amphigastrium florale* foliis floralibus aequilongum, oblongo-obconicum, ad  $1/2$  inciso-bifidum, rima angusta, laciniis lanceolatis acutis.

*Hab.* Lord Howe Island (Watts, 84).



*Chiloscyphus argutus* Nees. Tangoa Santo: leg. Dr. Annand, 1909.

*Chiloscyphus cambewarranus* St. Mount Wilson, N.S.W.: leg. Watts, 1911.

*Chiloscyphus maximus* St., n.sp.

Dioica magna robusta, flavo-virens, flaccida, corticola, laxe intricata. *Caulis* ad 4 cm. longus, simplex, parum longeque ramosus. *Folia caulina* parum imbricata, recte patula, leviter concava, in plano oblongo-conica, opposita (4.5 mm. longa, basi 4 mm. lata, apice 1.25 mm. lata) truncata, angulis spinula armatis, spinis divergentibus. *Cellulae* superae 36/36 $\mu$ , basales 45/72 $\mu$  trigonis nullis. *Amphigastria* caulina magna, caule quadruplo latiora, subquadrata, foliis utrinque late connata, apice profunde emarginato-quadrifida, laciniis mediis porrectis, externis divergentibus. *Folia floralia* parva, obconica, 1 mm. longa, apice 0.67 mm. lata, irregulariter sexspinosa, spinis plus minus longis. *Amphigastrium florale* intimum foliis floralibus subaequilongum, oblongo-obconicum, apice ad medium quadrifidum, laciniis mediis longioribus, validis, externis setaceis, omnibus leviter divergentibus.

*Hab.* Australia (Etta's Glen, Black Spur, Vict.): Watts, 968.

*Chiloscyphus montanus* St., n.sp.

Dioica mediocris flaccida, dilute virens, corticola, dense depresso-caespitans. *Caulis* ad 2 cm. longus simplex vel sparsim longeque ramosus. *Folia* caulina contigua, recte patula, parum concava, in plano oblongo-conica (1.58 mm. longa, basi 1.17 mm. lata, apice 0.67 mm. lata) marginibus superis et inferis nudis substrictis, apice ad 1/3 emarginato-bifida, sinu recto, lobis triangulatis cuspidatis porrectis. *Cellulae* superae 18/36 $\mu$ , basales 27/54 $\mu$  trigonis magnis, cuticula levis. *Amphigastria* caulina magna, caule quadruplo latiora, late obconica, folio proximo breviter connata, ad 2/3 emarginato-bifida, sinu amplo, lobis anguste lanceolatis divergentibus, acutis. *Androecia* lateralia, bracteis quinquejugis.

*Hab.* Australia, (Neate's Glen, Blackheath): Watts, 927.

*Chiloscyphus multifidus* St. Mount Gower, Lord Howe Island: leg. Watts, August, 1911.

*Cuspidatula monodon* Hook. et Tayl. The Saddleback, Mount Gower, Lord Howe Island, leg. Watts, 1911.

*Drepanolejeunea Riddleana* St., n.sp.

Dioica exigua, pallide flavo-virens, flaccida, terricola, dense depresso-caespitans lateque expansa. *Caulis* ad 10 mm. longus, simplex vel parum longeque ramosus. *Folia caulina* remota, ex erecta basi recte patula, lanceolata longeque attenuata, apice setacea (0.58 mm. longa, 0.17 mm. lata) integerrima. *Cellulae* superae  $18/18\mu$ , basales  $18/27\mu$  trigonis nullis. *Lobulus* maximus, folio duplo brevior, anguste oblongus, triplo longior quam latus, erectus caulique parallelus, carina papulosa bene arcuata, apice recte truncatus, angulo acuto, margine supero stricto, cauli subparallelo. *Amphigastria* caulina minuta, cauli aequilata, profundissime emarginato-bifida, laciniis erectis setaceis. *Perianthia* quoad plantae staturam maxima, late pyriformia (0.83 mm. longa, medio 0.58 mm. lata) apice rotundata, rostro angusto, plicis posticis ad medium decurrentibus angustis, late divergentibus, omnibus integerrimis. *Folia floralia* perianthio parum breviora, lanceolata acuta, marginibus remote denticulatis, apice nudis; *lobulus* subduplo brevior, anguste lanceolatus, ad medium solutus, apice obtusus. *Amphigastrium* florale minimum, lobulo subduplo brevius, rectangulatum, sub apice utrinque brevidentatum, apice ad  $1/3$  emarginato-bifidum, segmentis setaceis. *Androecia* desunt.

*Hab.* Insulae Novae Hebridae (Epi): Riddle legit, Hb. Watts.

*Eulejeunea flava* Sw. Tangoa, Santo: leg. Dr. Annand, 1909.

*Fimbriaria conocephala* St. Newington Hospital Grounds, near Sydney.

*Fimbriaria dioica* St., n.sp.

Dioica minor, in rupibus gregariè crescens. *Frons* ad 15 mm. longa, simplex, validissima, antice sulcata, duplo latior quam crassa, grosse costata, costa valde producta, 3 mm. lata, 1.25 mm. crassa,

alae costam parum superantes, breviter attenuatae, stratum anticum hypoporum humile. *Squamae* posticae magnae, purpureae, appendiculo magno, subrotundo, integerrimo. *Pedunculus* capituli longissimus (3 cm.). *Capitula* alte conica, involucri brevisculo. *Perianthia* involucri plus duplo longiora longeque exserta, pallida. Reliqua desunt.

*Hab.* Australia, N.S. Wales (near Gladesville): Watts, 1095.

*Fimbriaria subplana* St. Pittwater Road, Sydney, N.S. Wales, and Lord Howe Island, (Northern Look-out).

*Fimbriaria tasmanica* St. Newington Hospital Grounds.

*Fimbriaria Whiteleggei* St. Newington Hospital Grounds, and Kingwell, Wyong.

*Fossombronina Forsythii* St. Newington Hospital Grounds near Sydney.

*Fossombronina grossepapillata* St., n.sp.

Dioica pusilla flaccida, flavo-rufescens, gregarie crescens, terricola. *Caulis* ad 12 mm. longus, simplex. *Folia* caulina conferta, erecto-homomalla, latissima (3.5 mm. longa, 1.5 mm. lata) hic illic plicata, apice ampliata, rotundata integerrima, 2 mm. lata. *Cellulae* superae 36/36 $\mu$ , basales 54/90 $\mu$  trigonis nullis. *Perianthia* late obovato-obconica (3.5 mm. longa, medio 2.75 mm. lata) apice duplo angustiore quadriloba, lobis late triangulatis, porrectis acutis, sinibus amplis obtusis. *Folia* floralia intima reniformia 3.5 mm. longa, 4.5 mm. lata, inferne late obcuneata, apice late rotundata, regulariter multilobata, sinibus recurvis, lobis aequilongis acutis vel obtusis vel irregulariter repandis. *Sporae* 36 $\mu$  grosse papillatae brunneae.

*Hab.* Australia, (Young): Watts, 988.

*Frullania asperifolia* St., n.sp.

Sterilis flaccida, fusco-brunnea, corticola, dense depresso-caespitans, late expansa. *Caulis* ad 3 cm. longus, irregulariter bipinnatus. *Folia* caulina conferta, oblique patula, canaliculata concava, marginibus incurvis, in plano late ovato-elliptica (2 mm. longa, medio 1.4 mm. lata) apice rotundata, basi antica valde

ampliata, caulem late superantia, rotundato appendiculata. *Cellulae* superae  $18/18\mu$  parietibus flexuosis, trigonis nodulosis, basales  $18/36\mu$  trigonis maximis acutis, parietibus strictis, cuticula papillata. *Lobulus* majusculus, cauli aequilatus, cucullatus, vertice rotundatus, rostro longe producto obtuso, valido. *Amphigastria* caulina magna, in plano 1.17 mm. longa, medio 0.9 mm. lata, obovato-obcuneata, sinuatim inserta, apice breviter exciso-bidentata, dentibus late triangulatis acutis.

*Hab.* Australia, (Yarrangobilly Caves and Mount Wilson): Watts, 1093, etc.

*Frullania Baileyana* St. Centennial Glen, Blackheath, and Mount Wilson.

*Frullania belmorensis* St., n.sp.

Sterilis pusilla, rigidula, fusco-purpurea, corticola, dense depresso-caespitans lateque expansa. *Caulis* ad 2 cm. longus, regulariter breviterque pinnulatus, paucis ramis longioribus interjectis, similiter pinnulatis. *Folia* caulina imbricata, recte patula, valde concava, in plano late ovata (1.1 mm. longa, 0.75 mm. lata) basi antica ampliata, caulem late superantia ipsa basi rotundata. *Cellulae* superae  $18/18\mu$  trigonis magnis, parietibus validis, basales  $18/36\mu$ , trigonis majusculis. *Lobulus* quoad plantae staturam maximus, cucullatus, subduplo longior quam latus, cauli subcontiguus et parallelus, vertice obtusus, ore truncato, sub ore constrictus. *Amphigastria* caulina majuscula, caule triplo latiora, transverse inserta, late obovato-obconica, superne utrinque angulata, apice ad  $1/3$  inciso-biloba, sinu recto, lobis triangulatis acutis porrectis.

*Hab.* Australia, (Belmore Falls): Watts, 931.

*Frullania Billardieriana* D. et M. Aneityum: Gunn, per Lillie, 1911.

*Frullania cinnamomea* Carr et Pears. Blackheath and Mount Wilson.

*Frullania Crawfordii* St. Base of Mount Lidgbird, Lord Howe Island: leg. Watts.

*Frullania deflexa* St. Aneityum: Gunn, per Lillie.

*Frullania difficilis* St. Mount Wilson, N. S. Wales.

*Frullania excisula* St., n.sp.

Sterilis magna gracilis flaccida, rufo-brunnea, corticola, dense depresso-caespitans. *Caulis* ad 5 cm. longus, inferne simpliciter denseque pinnulatus, superne longe ramosus, ramis 2 cm. longis, remote breviterque pinnatis. *Folia* caulina conferta, oblique patula, valde concava, in plano subrotunda (1.17 mm. longa et lata) basi optime cordatim ampliata, symmetrica, integra. *Cellulae* 18/18 $\mu$  trigonis parvis nodulosis, parietibus flexuosis, medio minute nodulosis, basales 27/36 $\mu$  trigonis magnis acutis, parietibus strictis. *Lobulus* majusculus, cauli aequilatus, cucullatus, erectus, cauli appressus, vertice rotundatus, ore truncato, rostro brevissimo, latiusculo obtuso, marginem lobuli vix attingente. *Amphigastria* caulina maxima, foliis subaequimagna, subrectangulata, sinuatim inserta (1 mm. longa, ubique 0.83 mm. lata) apice truncato-rotundata medioque minute exciso-bidentula.

*Hab.* Australia, N.S. Wales (Mount Wilson and Blackheath): Watts, 1030, 1071.

*Frullania falciloba* Tayl. Lord Howe Island and Mount Wilson, N. S. Wales.

*Frullania falsa* St. Lord Howe Island; Mount Wilson, and Wollondilly River, N.S. Wales, legit Watts.

*Frullania filipendula* St. Lord Howe Island (Northern Hills and Saddleback); also at Mount Wilson, N.S.W., Watts.

*Frullania Forsythiana* St. Denman Mountain and Yarran-gobilly, N.S. Wales.

*Frullania grossiloba* St. Mount Wilson and Wyong, N.S.W.

*Frullania howeana* St., n.sp.; *F. grandifolia*, St., in sched.

Sterilis mediocris, olivacea, aetate fusco-brunnea, flaccida in latas plagas expansa, corticola. *Caulis* ad 5 cm. longus, dense longeque pinnatus, rarius bipinnatus. *Folia* caulina conferta,

recte patula, valde concava, apice arcte decurva, in plano ovato-elliptica, subsymmetrica (2.75 mm. longa, medio 2.25 mm. lata) apice late rotundata, antice caulem late superantia, basi antica circinatim appendiculata. *Cellulae* superae  $18/18\mu$  trigonis nodulosis, parietibus flexuosis, basales  $18/36\mu$  parietibus interrupte trabeculatis. *Lobulus* ovato-oblongus, a caule recte patens, duplo longior quam latus, vertice leviter arcuatus, ore in rostrum angustum truncatum excurrans. *Amphigastria* caulina reniformia (1.5 mm. lata, 1.1 mm. longa) transverse inserta, apice ad 1/3 emarginato-biloba, sinu amplissimo, segmentis triangulatis acutis, leviter conniventibus, marginibus ceterum ubique repandis varieque recurvis, subcrispatis.

*Hab.* Lord Howe Island, (Watts, 62).

*Frullania immersa* St. Aneityum: comm. Gunn, 1911  
(Hb. Watts, 47<sup>h</sup> 54).

*Frullania minutistipula* St., n.sp.

Sterilis pusilla, gracillima, flaccida, flavescens, aliis hepaticis corticolis consociata. *Caulis* ad 2 cm. longus, irregulariter breviterque pinnatus. *Folia caulina* remota, recte patula, valde concava, subconvoluta, in plano obovata (0.83 mm. longa, 0.58 mm. lata) apice late rotundata, basi ampliata, caulem late superantia, ipsa basi breviter rotundata. *Cellulae* foliorum superae  $18/18\mu$ , basales  $18/27\mu$  trigonis magnis, parietibus ubique validis. *Lobulus* magnus, folio duplo brevior, cylindricus, triplo longior quam latus, vertice obtusus, oblique patens, *stylus foliaceus*, lanceolatus, lobulo parum brevior. *Amphigastria* parva, transverse inserta, obovato-obconica, caule parum latiora, apice rotundata, minute inciso-biloba, sinu semirecto, lobis triangulatis acutis.

*Hab.* Australia, (Rodriguez Pass): Watts, 1001<sup>b</sup>, 1001<sup>c</sup>.

*Frullania nodulosus* Nees. Tagoa, Santo; leg. Dr. Annand  
1909.

*Frullania obtusifolia* St. Eastern slope of Mount Lidgbird,  
Lord Howe Island: Watts, 1911.

*Frullania pacifica* Tayl. Futuna: Gunn, 1911.

*Frullania pallida* St. Aneityum: Gunn, per Lillie, 1911.

*Frullania pentapleura* Hook. et Tayl. The Pines and the Northern Hills, Lord Howe Island: Watts, 1911.

*Frullania Powelliana* St. Aneityum and Futuna: comm. Gunn, 1911 (Hb. Watts, 47<sup>k</sup>, 75).

*Frullania Rechingeri* St. Futuna and Aneityum: Gunn, (Hb. Watts).

*Frullania rubella* Gotts. Mount Wilson, N.S. Wales, 1911.

*Frullania seriata*. Lord Howe Island (north and south):

*Frullania Simmondsii* St., n.sp.

Sterilis minor, flavo-rufescens, in cortice repens. *Caulis* ad 2 cm. longus, regulariter breviterque pinnulatus, pinnulis 3 mm. longis, simplicibus, rarius iterum pinnulatis. *Folia* caulina imbricata, subrecte patula, concava, in plano subrotunda (0.58 mm. longa et lata) antice caulem superantia, basi antica exappendiculata. *Cellulae* superae 18/18 $\mu$  trigonis parvis, basales 27/36 $\mu$  trigonis magnis. *Lobulus* majusculus, folio subduplo brevior, a caule remotus, cauli parallelus, obovato-oblongus, vertice obtusus, ore oblique truncato, crenulato. *Amphigastria* caulina majuscula, caule triplo latiora, late obtuneata, ad medium inciso-biloba, sinu angusto, lobis oblique truncatis tridentatis.

*Hab.* Australia, (near Brisbane): Simmonds leg. (Watts, 1110).

*Frullania squarrosa*. Lord Howe Island (Northern Hills and Lookout): Watts, 1911.

*Frullania Wattsiana* St. Neates' Glen, Blackheath, N.S.W.

*Frullania Wildii* St. Lord Howe Island, north and south; also Denman Mountain, N.S.W.: leg. Watts.

*Frullania Zippelii* Sande. Aneityum: comm. Gunn, (Herb. Watts, 47<sup>e</sup>).

*Hygrolejeunea hebridensis* St., n.sp.

Sterilis mediocris, pallide virens, flaccida, aliis hepaticis consociata. *Caulis* ad 3 cm. longus, parum longeque ramosus. *Folia*

caulina conferta, oblique patula, canaliculatim concava, apice arcte decurva, in plano late ovata (1.17 mm. longa, medio 0.83 mm. lata) brevi basi inserta, basi antica truncato-rotundata, caulem tegentia, apice subobtusa, marginibus ubique celluloso-crenulatis. *Cellulae* superae 27/27 $\mu$ , basales 36/45 $\mu$  trigonis parvis, parietibus tenuibus. *Lobulus* in situ majusculus, folio plus triplo brevior, carina saccatim rotundata, recto angulo in folium excurrens, apice quam basis quadruplo angustiore, recte truncato, sub apice leviter contracto. *Amphigastria* caulina magna, similiter crenulata, reniformia (0.75 mm. lata, 0.5 mm. longa) sinuatim inserta, apice ad 1/3 emarginato-biloba, sinu semirecto, lobis late triangulatis acutis.

*Hab.* Insulae Novae Hebridae (Tangoa, Santo): leg. Bowie (Watts, 20).

*Isotachis Gunniana* Mitt. Wentworth Falls, N.S.W.

*Isotachis inflexa* Gotts. Blackheath, N.S.W., 1911.

*Isotachis terricola* St., n.sp.

Sterilis minor rigidula, fusco-brunnea, apicibus dilutioribus, terricola, pulvinatim caespitans. *Caulis* ad 15 mm. longus, simplex vel furcatus. *Folia* caulina valde conferta oblique patula, canaliculatim concava, in plano subrotunda (2.5 mm. longa et lata) profunde sinuatim inserta, apice ad 1/3 inciso-biloba, sinu recto, lobis late triangulatis acutis porrectis, sub apice utrinque denticulo armatis. *Cellulae* superae 27/27 $\mu$ , basales 18/54 $\mu$  parietibus validis, cuticula striolata. *Amphigastria* caulina foliis minora (2.2 mm. longa et lata) late obtusata, apice ad 1/3 inciso biloba, sinu recto, lobis triangulatis, apiculatis divergentibus, sub apice utrinque unispina, supra basin utrinque denticulo armata.

*Hab.* Australia (Blackheath): Watts, 1016.

*Jamesoniella ovifolia* Schiffn. Aneityum: Gunn., per Lillie, 1911.

*Lepidozia appressifolia* St. Fitzroy Falls and Blackheath.

*Lepidozia asymmetrica* St. Wyong, Cambewarra and Blackheath N.S.W.



*Lepidozia buffalona* St., n.sp.

Sterilis exigua gracillima, pallide virens, subhyalina, terricola, dense intricata lateque expansa. *Caulis* ad 15 mm. longus, regulariter remoteque pinnulatus, pinnulis 3 mm. longis, recte patulis. *Folia* caulina remota, oblique vel subrecte patula, parum concava, in plano late obconica (0·5 mm. longa, basi 0·17 mm. lata, apice 0·5 mm. lata) symmetrica, apice ad medium quadrifida, sinibus obtusis, laciniis anguste lanceolatis, basi 2 cellulas latis, leviter divergentibus. *Cellulae* disci superae  $27/27\mu$ , basales  $27/45\mu$  parietibus validis. *Amphigastria* caulina parva, transverse inserta, caule parum latiora, apice profunde emarginato-quadrifida, laciniis angustis, setaceis divergentibus.

*Hab.* Australia, (Buffalo Creek, near Gladesville; Blue Mountains and Cambewarra): Watts, 977, 941, 978, 965, 982, 914, etc.

*Lepidozia capilligera* L.L. Rodriguez Pass and Wentworth Falls, Blue Mountains; and Lane Cove River, near Sydney, N.S.W.

*Lepidozia centipes* Tayl. Rodriguez Pass, Blue Mountains, N.S.W.

*Lepidozia communis* St., n.sp.

Sterilis exigua, pallide virens, terricola, dense caespitans lateque expansa. *Caulis* ad 8 mm. longus, regulariter remoteque pinnatus. *Folia* caulina remotiuscula, oblique patula, leviter decurva, in plano subquadrata (0·67 mm. longa, 0·54 mm. lata) discus basalis integer 0·33 mm. longus, apice quadrifidus, laciniis porrectis, anguste lanceolatis, basi 3 cellulas latis, apice setaceis. *Amphigastria* caulina parva, cauli aequilata, quadrata, ad medium quadrifida, laciniis porrectis, basi 2 cellulas latis.

*Hab.* Australia, (Grand Canyon, Blackheath): Watts, 1014.

*Lepidozia crassitexta* St., n.sp.

Sterilis magna gracilis flaccida, flavo-virens, aetate fusca, terricola, dense depresso-caespitans lateque expansa. *Caulis* ad 3 cm. longus, regulariter denseque pinnatus, pinnis ad 13 mm. longis, attenuatis, apice setaceis radicantibus. *Folia* caulina conferta,

oblique patula, valde decurva, in plano subquadrata (1.17 mm. longa, 1 mm. lata) lata basi inserta, basi antica rotundata, apice ad medium quadrifida, sinubus angustis, obtusis, laciniis leviter divergentibus, anguste lanceolatis attenuatis, basi 6 – 8 cellulas latis, laciniis superis brevioribus *v.e.* minus profunde solutis. *Cellulae* superae 27/27 $\mu$ , in disco 18/36 $\mu$ , basales 27/36 $\mu$  parietibus ubique crassis.

*Hab.* Australia, (Rodriguez Pass, Blackheath): Watts, 1005.

*Lepidozia fila* St. Aneityum, Gunn, 1911 (Hb. Watts, 42).

*Lepidozia furcatifolia* St., n.sp.

Sterilis parva gracillima rigida, flavo-rufescens, terricola, aliis hepaticis consociata. *Caulis* ad 2 cm. longus, sparsim remoteque ramosus, ramis saepe apice breviter furcatis, flagellis posticis sparsis longis nudis radicanibus. *Folia caulina* imbricata, oblique patula, leviter decurva, in plano oblonga (0.83 mm. longa, 0.33 mm. lata) apice ad medium bifida, laciniis anguste lanceolatis, saepe inaequalibus, leviter divergentibus; discus basalis integer rectangulatus, basi antica rotundatus. *Cellulae* superae 18/27 $\mu$  basales 27/36 $\mu$  parietibus validis, marginales in facie externa grosse incrassatae. *Amphigastria* caulina exigua, cauli aequilata et vix visibilia, reniformia, duplo latiora quam longa, apice breviter inciso-triloba, lobis latis acutis vel obtusis.

*Hab.* Australia, (Horse Shoe Falls, Blackheath): Watts, 1027.

*Lepidozia Gunniana* St., n.sp.

Sterilis minor, pallide flavicans, muscis consociata, rigida. *Caulis* ad 3 cm. longus, regulariter breviterque pinnatus, paucis ramis longioribus interjectis similiter pinnulatis. *Folia caulina* remota (in ramis contigua) oblique patula, apice parum decurva, in plano subrectangulata (0.4 mm. longa, 0.3 mm. lata) symmetrica, apice breviter quadrifida, segmentis brevibus, mediis 4 cellulas longis, reliquis 2 cellulas longis, omnibus basi 2 cellulas latis. *Cellulae* superae 27/27 $\mu$ , basales 27/45 $\mu$  parietibus tenuibus, trigonis nullis. *Amphigastria* caulina parva, cauli aequilata, optime

quadrata, apice breviter quadridentata, dentibus 2 cellulas longis, obtusis.

*Hab.* Insulae Novae Hebridae, (Aneityum): Gunn legit (Watts, 24).

*Lepidozia hastatistipula* St., n.sp.

Sterilis, minuta, rigida, fusco-brunnea, terricola, gregarie crescens. *Caulis* ad 8 mm. longus, parum longeque ramosus. *Folia caulina* remota, oblique patula, leviter decurva, in plano subrotunda (0.83 mm. longa, medio 0.9 mm. lata). *Discus* basalis integer obcuneatus (basi 0.25 mm. latus, apice 0.5 mm. latus) supra basin et sub apice utrinque unispinus, apice quadrifidus, laciniis 0.5 mm. longis, setaceis porrectis vel leviter divergentibus. *Cellulae* superae 18/27 $\mu$  basales 18/36 $\mu$  parietibus validis. *Amphigastria* caulina magna, ambitu obovato-obconica, (0.83 mm. longa, 0.5 mm. lata) discus basalis integer obcuneatus, inferne nudus, superne utrinque unidentatus, apice regulariter quadrifidus, laciniis 0.33 mm. longis, anguste lanceolatis, superne setaceis.

*Hab.* Australia, (Healesville, Vict.): Watts, 966.

*Lepidozia lateconica* St., n.sp.

Sterilis exigua, omnium minima, fusco virens, in sicco subatra, aliis hepaticis terricolis consociata. *Caulis* ad 5 mm. longus, irregulariter longeque ramosus. *Folia caulina* remota, recte patula, erecto-homomalla, parum concava, in plano late obconica (0.6 mm. longa, 0.33 mm. lata) apice attenuata, acuta, medio utrinque grosse lobata, lobis oblique patulis, lanceolatis, 0.17 mm. longis. *Cellulae* ubique 18/36 $\mu$ , trigonis nullis. *Amphigastria* caulina exigua, cauli aequalata, vix visibilia, subquadrata, limbo basali integro brevissimo, lineari, apice remote trifida, laciniis setaceis, sinubus latis.

*Hab.* Australia, (Barron Falls, North Queensland; leg. Mrs. Brotherton) Watts, 976.

*Lepidozia Lindenberghii* Gotts. Mount Gower, Lord Howe Island, Watts, 1911.

H—June 3, 1914.

*Lepidozia longiscypha* Tayl. Buffalo Creek, near Sydney;  
Centennial Glen, Blackheath; Cambewarra Mountain,  
N.S. Wales.

*Lepidozia microstipula* St., n.sp.

Sterilis exigua, fusco-virens, flaccida, terricola, late expansa. *Caulis* ad 7 mm. longus, parum longeque ramosus, capillaceus. *Folia caulina* remota vel contigua, oblique patula, parum concava, in plano 0.58 mm. longa, 0.67 mm. lata, sinuatim inserta; *disco basali* integro 0.2 mm. longo, 0.5 mm. lato, late obconico, apice longe quadrifida, *laciniis* lanceolatis, 0.33 mm. longis, acutis, mediis porrectis, lateralibus oblique patulis, sinubus obtusis, basi 4 cellulas latis. *Cellulae* superae  $18/18\mu$  basales  $18/27\mu$  trigonis nullis. *Amphigastria* caulina minima, ambitu obovato-obconica, ad medium emarginato-bifida, sinu amplo, laciniis capillaceis, disco basali tres cellulas longo et lato, obconico.

*Hab.* Australia, (Lane Cove River, above Fig Tree Bridge):  
Watts, 958.

*Lepidozia multifida* St., n.sp.

Dioica magna robusta flaccida, pallide virens, corticola dense depresso-caespitans. *Caulis* ad 4 cm. longus, validus dense breviterque pinnatus, pinnis saepe flagellatim attenuatis. *Folia* caulina imbricata, oblique patula, decurva, in plano subrotunda (1.5 mm. lata, 1.33 mm. longa) asymmetrica, ubique grosse armata, margine supero 5 spinoso, spinis parum patulis, margine infero quadrifido, laciniis profunde solutis, aequilongis plus minus validis, omnibus apice longius setaceis. *Cellulae* superae  $18/18\mu$ , mediae  $18/27\mu$ , basales  $18/45\mu$ , parietibus crassis, cuticula levis. *Amphigastria* caulina foliis aequimagna, ambitu subrotunda, circumcirca profunde sexfida, laciniis inaequalibus, setaceis vel lanceolatis, saepe profunde bifidis vel trifidis, segmentis angustis, apice semper longe setaceis. *Perianthia* cylindrica, 5 mm. longa, sub apice plicata, ore parvo truncato breviter fisso, segmentis plus minus longe spinulosis. *Folia floralia* intima oblongo-elliptica (2.5 mm. longa, medio 1.5 mm. lata) apice late rotundata, marginibus inferis nudis, superis

irregulariter denticulatis. *Amphigastrium florale* intimum foliis floralibus subaequale, apice quidem truncatum breviter dentatum.

*Hab.* Australia, New South Wales (Blue Mountains): Watts, 974, 975, 964.

*Lepidozia nova* St., n.sp.

Sterilis magna gracilis flaccida, pallide virens, dense depresso-caespitans, terricola. *Caulis* ad 4 cm. longus, regulariter breviterque pinnatus, pinnis 3 mm. longis, subrecte patulis, simplicibus, frondem linearem formantibus. *Folia caulina* parum imbricata, recte patula, decurvula, in plano late triangulata (basi 1.33 mm. lata, 1.33 mm. longa) apice fere ad medium usque inciso-biloba, sinu subrecto, laciniis e lata basi longe attenuatis, 0.67 mm. longis, marginibus reliquis maxime irregularibus, varie incisus sublaceratis, setis plus minus validis, minutis vel longioribus vel longissimis mixtis. *Cellulae* superae 18/18 $\mu$ , basales 36/36 $\mu$  trigonis nullis. *Amphigastria caulina* foliis parum minora, ambitu 1 mm. longa et lata, laciniis primariis 4 validis, utrinque longa seta armatis.

*Hab.* Australia, (Blue Mountains and Mount Wilson): Watts, 1033, 1054 and 1066.

*Lepidozia Oldfieldiana* St. Horseshoe Falls, Blackheath, and Kingwell, Wyong, N.S.W.

*Lepidozia quadriseta* St. Horseshoe Falls, Blackheath, N.S. Wales.

*Lepidozia quadrastipula* St., n.sp.

Sterilis pusilla gracillima, pallide virens, terricola, dense depresso-caespitans. *Caulis* ad 12 mm. longus, regulariter breviterque pinnatus, pinnulis 3 mm. longis, recte patulis. *Folia caulina* contigua, subrecte patula, parum concava, in plano late obconica (0.58 mm. longa, basi 0.25 mm. lata, apice 0.5 mm. lata); discus basalis integer 0.25 mm. longus, apice quadrifidus, laciniis 0.33 mm. longis, anguste lanceolatis, basi 4 cellulas latis, leviter divergentibus. *Cellulae* superae 18/27 $\mu$ , basales 27/36 $\mu$ , trigonis nullis. *Amphigastria caulina* exigua, cauli aequilata, in plano optime quadrata,

apice ad  $1/3$  emarginato-quadrifida, laciniis setaceis, 2 cellulas longis, porrectis.

*Hab.* Australia, (Rotunda, Neate's Glen, Blackheath): Watts, 1009.

*Lepidozia rigida* St., n.sp. Aneityum: Gunn, per Lillie, also Hb. Watts, 36.

*Lepidozia septemfida* St. Water Nymph's Dell, Wentworth Falls. N.S.W.

*Lepidozia tenera* St. Futuna: Gunn, 1911 (Hb. Watts, 82).

*Lepidozia terricola* St. Belmore Falls, N.S.W.

*Lepidozia trichodes* Ldbg. Aneityum: Gunn, 1911, (Hb. Watts, 47<sup>b</sup>.)

*Lepidozia tripilosa* St., n.sp.

Sterilis, minor, gracilis flaccida, pallide virens vel subhyalina. *Caulis* ad 15 mm. longus, capillaceus, sparsim breviterque pinnatus, flagellis posticis numerosis. *Folia caulina* contigua, recte patula, plano-disticha, subrectangulata (0.75 mm. longa, ubique 0.33 mm. lata) lata basi inserta, disco basali integro subquadrato, apice leviter oblique truncato, trifido, rarius quadrifido, sinus angustis acutis, laciniis setaceis, basi 2 cellulas latis subaequilongis. *Cellulae* superae  $36/36\mu$ , basales  $36/54\mu$  parietibus validis, trigonis nullis. *Amphigastria* parva, disco basali integro unam cellulam longo, sex cellulas lato, apice trifido, laciniis setaceis, 0.25 mm. longis, late divergentibus.

*Hab.* Australia, (Centennial Glen, Blackheath): Watts, 1043.

*Lepidozia ulothrix* Ldbg. Katoomba Falls; Mount Wilson and Rodriguez Pass, Blue Mountains, N.S.W.

*Lepidozia verticillata* Carr. Valley of Waters and Centennial Glen, N.S.W.

*Lepidozia Wattiana* St. Stanwell Park, N.S.W.

*Lepidozia Weymouthiana* St., n.sp.

Sterilis magna flaccida, pallide virens, corticola, laxe intricata. *Caulis* ad 4 cm. longus, carnosus, regulariter denseque pinnatus, pinnis 7 mm. longis, decurvo homomallis. *Folia* caulina imbricata, oblique patula, leviter concava, in plano 1.5 mm. lata et longa, asymmetrica, margine *supero* arcuato, 1.67 mm. longo, basi rotundato, margine *infero* 0.9 mm. longo, stricto, basi truncato, disco basali integro oblique truncato, apice quadrifido, laciniis inaequalibus, superis 0.33 mm. longis, inferis 0.5 mm. longis, omnibus basi 7 cellulas latis. *Cellulae* foliorum superae 18/18 $\mu$ , basales 27/45 $\mu$ , parietibus crassis. *Amphigastria* caulina quadrata (0.9 mm. longa et lata) ad medium quadrifida, laciniis anguste lanceolatis obtusis, porrectis, sinubus obtusis.

*Hab.* Tasmania, (Weymouth, 1168<sup>b</sup>.)

*Lophocolea allodonta* H. et T. Erskine Valley, Lord Howe Island, (Watts).

*Lophocolea belmorana* St., n.sp.

Sterilis minor rigidula, brunnea, apicibus pallidis, virescentibus, terricola, dense depresso caespitans lateque expansa. *Caulis* ad 2 cm. longus, capillaceus, simplex vel parum longequae ramosus. *Folia* caulina conferta, subopposita, erecto-homomalla, concava, in plano late ovata vel subrhombea (1.17 mm. longa, 1 mm. lata) oblique patula, apice late truncato-rotundata, integerrima. *Cellulae* superae 36/36 $\mu$  trigonis magnis, basales 36/45 $\mu$  trigonis parvis. *Amphigastria* caulina majuscula, caule duplo latiora, foliis utrinque breviter connata; disco basali integro subquadrato, utrinque bispinuloso, apice ad medium emarginato-bifido, sinu amplo, laciniis lanceolatis angustis cuspidatis leviter divergentibus.

*Hab.* Australia, (Belmore Falls): Watts, 934.

*Lophocolea Bowiena* St., n.sp.

Sterilis magna flaccida, dilute flavicans vel virescens, in humo late expansa. *Caulis* ad 5 cm. longus, validus, simplex, rarius ramulo auctus. *Folia* caulina imbricata, symmetrica, recte patula, plano-disticha (2.5 mm. longa, basi 1.75 mm. lata, apice truncata

0.75 mm. lata) optime oblongo-conica, apice utrinque spina armata, spinis divergentibus. *Cellulae* superae 18/27 $\mu$ , basales 36/36 $\mu$  parietibus validis. *Amphigastria caulina* parva, caule parum latiora, folio proximo breviter connata; disco humili utrinque unispino, apice emarginato-bifido, laciniis longis, late divergentibus.

*Hab.* Insulae Novae Hebridae, (Santo) Bowie leg. (Watts, 15).

*Lophocolea excisifolia* St., n.sp.

Sterilis pallide flavicans vel subhyalina, flaccida, tenerrima, aliis hepaticis consociata. *Caulis* ad 25 mm. longus, capillaceus, pallidus, simplex vel parum longeque ramosus. *Folia caulina* contigua, oblique vel subrecte patula, parum concava, in plano late ovata, trigona (basi 3.25 mm. lata, 3 mm. longa) asymmetrica, margine supero longe arcuato, infero stricto breviora, apice 1.5 mm. lata, oblique emarginata, angulis breviter lateque acuminatis. *Cellulae* superae 36/36 $\mu$  basales 36/54 $\mu$  trigonis nullis. *Amphigastria caulina* majuscula, breviter obcuneata, apice emarginato-bifida, laciniis longe lanceolatis, validis (1 mm. longis) late divergentibus, supra basin utrinque spinula armatis.

*Hab.* Australia, (Yarrangobilly Caves): Watts, 924<sup>a</sup>.

*Lophocolea heterophylloides* Nees. Lord Howe Island (north and south), Watts, 1911.

*Lophocolea Howeana* St., n.sp.

Dioica minor flaccida, pallide virens, in cortice laxe caespitans. *Caulis* ad 2 cm. longus, sparsim longeque ramosus. *Folia caulina* contigua, recte patula, plana, late conica, symmetrica (1.5 mm. longa, basi 1.75 mm. lata, sub apice 0.75 mm. lata, apice ipso emarginato-bispinoso, spinis e lata basi attenuatis divergentibus. *Cellulae* superae 27/27 $\mu$ , basales 27/45 $\mu$  parietibus validis. *Amphigastria caulina* majuscula, caule triplo latiora, disco basali integro humillimo, utrinque grosse spinoso, apice late emarginato-bispinoso, spinis simillimis. *Perianthia* magna, obovato-oblonga, (6.5 mm. longa, 3 mm. lata) apice profunde trilobata, lobis iterum grosse bifidis, laciniis irregulariter longeque spinosis et setaceis. *Folia floralia* intima parva, obovata, valde concava, squarrose



patula, perianthio plus duplo breviora, apice breviter emarginato-biloba, lobis triangulatis acutis. *Amphigastrium* florale intimum foliis floralibus aequimagnum, simillimum, similiter concavum. *Androecia* desunt.

*Hab.* Australia, (Lord Howe Island : Watts 39).

*Lophocolea Oldfieldiana* St. Western base of Mount Lidgbird and on Mount Gower, Lord Howe Island : Watts, 1911.

*Lophocolea subemarginata* Taylor. Buffalo Gully near Gladesville, N. S. Wales.

*Lophocolea trialata* G. Rodriguez Pass, N.S.W.

*Lophocolea varians* St., n.sp.

Sterilis mediocris rigidula, dilute brunnea, terricola, dense depresso caespitans lateque expansa. *Caulis* ad 3 cm. longus, capillaceus, simplex vel parum longeque ramosus. *Folia caulina* alternantia, imbricata, recte patula, subquadrata (2 mm. longa, 1.75 mm. lata) normaliter apice truncata, angulis apiculatis ; adsunt folia maxime aberrantia, id est: folia apice integerrima, alia in medio apicali unidentata vel truncata, angulis apiculatis vel tridenticulata vel apice late triangulata angulis apiculatis vel apice heteroformia sublacerata. *Cellulae* superae  $18/18\mu$ , basales  $27/27\mu$  trigonis nullis, parietibus validis. *Amphigastria* caulina parva, cauli aequilata, subquadrata, foliis utrinque anguste connata, apice emarginato-bifida, sinu levissimo, laciniis setaceis, late divergentibus, sub apice utrinque spinula patula armata.

*Hab.* Australia, (Ferny Hill, Mount Wilson): Watts, 1080.

*Madotheca hebridensis* St., n.sp.

Dioica maxima gracilis, intense viridis, flaccida, in rupibus humidis pendula. *Caulis* ad 13 cm. longus, remote breviterque ramosus, ramis 10 – 25 mm. longis. *Folia caulina* conferta, recte patula, undulata, in plano late ovato-elliptica (2 mm. longa, medio 1.33 mm. lata) asymmetrica, margine supero longe arcuato, infero stricto, brevi basi inserta, apice rotundata integerrima. *Cellulae*

superae 18/18 $\mu$ , basales 27/36 $\mu$ , trigonis parvis, superne nullis. *Lobulus* magnus, late lingulatus (1 mm. longus, 0.67 mm. latus) apice rotundatus, integerrimus. *Amphigastria* caulina subquadrata (1.1 mm. longa, 0.9 mm. lata) apice truncato-rotundata, profunde sinuatim inserta, marginibus ubique arcte recurvis. *Folia floralia* intima ex angusta basi obovata (2.5 mm. longa, medio 1 mm. lata) apice obtusa; superne irregulariter breviterque pilosa, inferne nuda; *lobulus* ovato-oblongus, profunde solutus, apice late truncatus, marginibus dense irregulariterque spinosis et dentatis. *Amphigastrium florale intimum* obovato-oblongum, lobulo parum majus, ceterum subaequale similiterque armatum.

*Hab.* Insulae Novae Hebridae, (Futuna) Gunn legit: (Watts, 66, 76).

*Madotheca queenslandica* St. Northern Look-out, Lord Howe Island: Watts.

*Madotheca Stangeri* L. et G. At many places on Lord Howe Island: Watts, 1911.

*Marchantia paludicola* St., n.sp. *M. conica*, St. in sched.

Dioica, mediocris tenax, viridis, aetate rufescens, paludicola. *Frons* ad 3 cm. longa, 1 mm. lata, simplex, rarius brevi ramulo aucta. *Costa* humilis sed latissima, in sectione transversa anguste linearis (5 mm. lata, 0.75 mm. crassa; stomata creberrima, ore interno 4 cellulis angustis circumdato. *Squamae* porticae magnae, purpureae, appendiculo integro subrotundo (0.8 mm. longo et lato). *Capitula* feminea hemisphaerica, centro antico valide apiculato, margine breviter crenata, quinquelobata, lobis rotundatis. *Involucra* ore dense longaeque lacerata. *Capitula mascula* rotunda, majora, disciformia, alveolis masculis radiatim insertis, radiis leviter prominulis, margine disci itaque crenato.

*Hab.* Australia, New South Wales, (Cambewarra): Watts, 1106, 1102.

This plant was named *Marchantia conica*; as this denomination had been used before, the name has been changed.

*Marsupidium rigidum* St., n.sp. Mount Gower, Lord Howe Island: Watts, 1911. A few scraps only; description wanting.

*Mastigobryum aneityense* St., n.sp.

Sterilis mediocris, pallide flavo-virens, rigidula. *Caulis* ad 3 cm. longus, parum longeque ramosus. *Folia caulina* conferta, falcatis patula, canaliculatis concava, in plano anguste linearis (3.5 mm. longa, supra basin 1 mm. lata, superne 0.67 mm. lata) basi antica rotundata, apice paucidentata, dentibus triangulatis, acutis, valde heteroformis varieque patulis, interdum sublaceratis. *Cellulae* superae 27/36 $\mu$ , basales 36/54 $\mu$  trigonis majusculis. *Amphigastria* caulina majuscula, caule parum latiora, quadrata marginibus ubique crenatis incis.

*Hab.* Insulae Novae Hebridae (Aneityum): Gunn leg. (Watts, 47<sup>1</sup>, 34).

*Mastigobryum asperum* St., n.sp.

Sterilis major gracilis olivacea, terricola, laxe intricata. *Caulis* ad 5 cm. longus, repetito-furcatus, ramis primariis 2 cm. longis, ultimis brevibus, flagellis longis numerosis. *Folia caulina* contigua, decurvo-homomalla, in plano anguste lingulata, leviter falcata (2 mm. longa, ubique 0.75 mm. lata) margine infero nudo, supero minute denseque crenulato, apice breviter valideque tridentata, dentibus late triangulatis, sparsim crenulatis, acutis. *Cellulae* superae 14/14 $\mu$ , basales 18/36 $\mu$  trigonis nullis. *Amphigastria* caulina magna, rectangularia, (0.75 mm. longa, 0.58 mm. lata) marginibus ubique repandis, hic illic breviter lobatis, minute crenulatis, suberosis.

*Hab.* Insulae Novae Hebridae (Tangoa, Santo). Bowie legit: (Watts, 12).

*Mastigobryum Baileyanum* St. Mount Gower, Lord Howe Island: Watts, 1911.

*Mastigobryum caudistipulum* St. Tangoa, Santo: Bowie, 1909, (Hb. Watts, 11).

*Mastigobryum conistipulum* St. Aneityum: Gunn, per Lillie.

*Mastigobryum Corbieri* St., n.sp.

Sterilis mediocris rigida, flavescens, terricola, in latas plagas expansa, spongiose caespitans. *Caulis* ad 3 cm. longus, furcatus et repetito-furcatus, flagellis sparsis remote seriatis. *Folia* caulina conferta, recte patula, valde decurva, in plano late ovato-trigona (2.5 mm. longa, apice 1 mm. lata, supra basin 2 mm. lata) asymmetrica, margine supero e basi rotundata substricto, inferne leviter sinuato, apice quam basis duplo angustiore, oblique truncato, emarginato-tridentato, sinubus parum profundis, dentibus brevibus latis acutis. *Cellulae* superae  $18/27\mu$ , basales  $27/45\mu$  vel  $27/54\mu$  trigonis majusculis. *Amphigastria* caulina aequilata, squarrose patula, in plano late rectangulata (0.83 mm. lata, 0.5 mm. longa) marginibus ubique irregulariter obtuseque dentatis et erosis.

*Hab.* Australia, (Kingwell, Wyong): Watts, 971<sup>b</sup>.

*Mastigobryum dentistipulum* St., n.sp.

Sterilis mediocris flavescens, aetate virens, valida, rigidula. *Caulis* ad 2 cm. longus, parum longeque ramosus, flagellis sparsis breviusculis. *Folia* caulina opposita, conferta, recte patula, parum concava, in plano oblonga (2.17 mm. longa, supra basin 1.25 mm. lata) subsymmetrica, apice oblique truncata (0.67 mm. lata) emarginato tridentata, dentibus angustis, sub apice regulariter minuteque denticulata, basi utrinque rotundata. *Cellulae* superae  $27/27\mu$  trigonis majusculis, parietibus validis, basales  $36/54\mu$  trigonis magnis, acutis, parietibus tenuibus. *Amphigastria* caulina foliis utrinque late connata, subrectangularia (0.9 mm. lata, 0.67 mm. longa) marginibus irregulariter breviterque inciso-lobatis, lobulis irregularibus, acutis vel obtusis, interdum sublaceratis.

*Hab.* Australia, New South Wales (Lane Cove River and Valley of Waters): Watts. 1096, 1129, 1104.

*Mastigobryum erosifolium* St., n.sp.

Sterilis parva rigidula, dilute brunnea, terricola, pulvinatim caespitans lateque expansa. *Caulis* ad 15 mm. longus, capillaceus,

fuscus, repetito furcatus, flagellis sparsis. *Folia caulina* conferta, decurvo-homomalla, valde concava, in plano ovato-oblonga (1.5 mm. longa, 0.83 mm. lata) asymmetrica, margine supero longe breviterque arcuato, infero stricto, apice ad 1/3 inciso-biloba sinu angusto, laciniis porrectis. valde inaequalibus, supero parum longiore, triplo latiore, marginibus repandis, suberosis. *Cellulae* superae 18/18 $\mu$ , basales 27/27 $\mu$  trigonis subnullis. *Amphigastria* caulina parva, cauli aequilata, in plano 0.33 mm. longa et lata, ad medium inciso-triloba, sinubus angustis, lobis ligulatis obtusis.

*Hab.* Australia, (Cambewarra Mountain): Watts legit, 917.

*Mastigobryum fasciculatum* St. Mount Gower, Lord Howe Island: Watts, 1911.

*Mastigobryum gracillimum* St., n.sp.

Sterilis major flaccida, intense viridis. *Caulis* ad 4 cm. longus, sparsim longeque ramosus, flagellis breviusculis sparsis. *Folia caulina* conferta, oblique patula, decurvula, in plano oblonga (2.33 mm. longa, basi 1.5 mm. lata) symmetrica, apice truncata, 0.5 mm. lata, emarginato-tridentata, dentibus majusculis paucis, minimis interjectis, sub apice similiter denticulata, basi utrinque rotundata. *Cellulae* superae 18/18 $\mu$  parietibus validis, basales 27/45 $\mu$  trigonis majusculis. *Amphigastria* caulina magna, latiora quam longa, rectangulata, (1.33 mm. lata, 0.83 mm. longa) dense valideque dentata, haud raro duplicatim dentata.

*Hab.* Australia, New South Wales, (Wyong, and Valley of Waters): Watts, 939, 987.

*Mastigobryum Gunnianum* St., n.sp.

Sterilis, mediocris, intense flavicans, rigida. *Caulis* ad 3 cm. longus, parum longeque ramosus, flagellis brevibus numerosis. *Folia* caulina conferta, recte patula, canaliculatim concava, margine infero arcte incurvo, in plano oblonga (1.75 mm. longa, supra basin 0.83 mm. lata) asymmetrica, margine infero substricto, supero e basi late rotundata substricto, apice truncata (0.5 mm. lata) emarginato-tridentata, dentibus validis, triangulatis, divergentibus acutis. *Cellulae* superae 18/18 $\mu$  parietibus validis, basales 27/45 $\mu$

trigonis majusculis, acutis. *Amphigastria* caulina magna, rectangulata, transverse inserta (0.83 mm. longa, 0.58 mm. lata) marginibus ubique repandis, apice irregulariter minuteque dentatis.

*Hab.* Insulae Novae Hebridae (Aneityum and Futuna): Gunn leg. (Watts, 46, 67, 69, etc.)

*Mastigobryum hebridense* St., n.sp.

Sterilis magna robusta rigida, dilute olivacea, corticola. *Caulis* ad 5 cm. longus, parum longeque ramosus, validus. *Folia* caulina imbricata, recte patula, canaliculatim concava, in plano anguste ligulata, leviter falcata (4 mm. longa, supra basin 0.5 mm. lata) apice oblique truncata, emarginato-triloba, lobis late triangulatis, acutis, sparsim minuteque dentatis. *Amphigastria* caulina magna, caule triplo latiora, subquadrata, sinuatim inserta, marginibus regulariter breviterque repandis. *Cellulae* superae foliorum  $27/27\mu$  trigonis majusculis acutis, basales  $36/54\mu$  trigonis maximis subnodulosi.

*Hab.* Insulae Novae Hebridae (Aneityum): Gunn leg. (Watts, 59).

*Mastigobryum indigenarum* St., n.sp.

Sterilis mediocris flaccida, dilute flavo-virens. *Caulis* ad 4 cm. longus, regulariter breviterque pinnatus, ramis longioribus interjectis similiter pinnatis, flagellis brevibus, sparsis. *Folia* caulina imbricata, oblique patula, parum concava, in plano ligulata (1.33 mm. longa, ubique 0.5 mm. lata) leviter falcata, apice emarginato-trifida, laciniis angustis porrectis aequalibus, sub apice minute crenulata. *Cellulae* superae  $13/13\mu$  parietibus validis, in vitta  $27/36\mu$  trigonis majusculis. *Amphigastria* caulina parva, cauli aequilata, subquadrata, apice longe angusteque setacea, setis disco subaequilongis, porrectis sub apice utrinque denticulata.

*Hab.* Insulae Novae Hebridae (Aneityum): Gunn com. (Watts, 73.)

*Mastigobryum luzonense* St. Aneityum: Gunn, (Hb. Watts, 53.)

*Mastigolejeunea acutifolia* St., n.sp.

Sterilis major flaccida, rufescens, in cortice laxe caespitans, longe prostrata. *Caulis* ad 5 cm. longus parum longeque ramosus. *Folia* caulina parum imbricata, subrecte patula, canaliculatim concava, in plano oblonga (2.75 mm. longa, medio 1.1 mm. lata) integerrima, apice minute apiculata, marginibus longe arcuatis, basi antica rotundata.. *Cellulae* superae 18/18 $\mu$  basales 18/54 $\mu$ , in vitta 14/36 $\mu$ , parietibus validis, trigonis nullis, *lobulus* majusculus, oblongus, duplo longior quam latus, carina substricta, stricte in folium excurrens, margine supero longe arcuato, apice quam basis triplo angustior, excisus, angulo spina longa hamata armato. *Amphigastria* caulina magna, circularia, 1 mm. longa et lata, integerrima.

*Hab.* Insulae Novae Hebridae (Santo: Bowie leg.; Aneityum: Gunn leg.) Watts, 13, 25<sup>a</sup>, 33.

*Mastigolejeunea Wattsiana* St. Intermediate Hill, etc., Lord Howe Island: leg. Watts, 1911.

*Mastigophora diclados* Endl. Aneityum and Futuna: Gunn (Hb. Watts, 47<sup>d</sup> and 74).

*Mastigophora tenuis* St., n.sp.

Sterilis, magna, gracilis flaccida, dilute rufo-brunnea, corticola, laxe intricata et pendula. *Caulis* ad 8 cm. longus, dense longeque ramosus, ramis trunco aequivalidis, 25 mm. longis, vulgo homomallis, supra basin furcatis. *Folia* caulina dense imbricata, valde concava, in plano 1.4 mm. longa, 1.1 mm. lata, profunde sinuatim inserta, basi utrinque spina armata, spinis validis, lanceolatis, hamatim recurvis, apice profunde triloba, lobis inaequalibus, *supero* maximo, late lanceolato (0.83 mm. longo basi 0.58 mm. lato), lobulo *medio* parum brevior triplo angustiore, lobulo *tertio* (infero) iterum angustiore et parum brevior. *Cellulae* foliorum superae 36/36 $\mu$  trigonis giganteis, saepe confluentibus, medio 36/54 $\mu$  basales 36/72 $\mu$  parietibus minus validis. *Amphigastria* caulina magna, sinuatim inserta, 1 mm. longa, apice ad 2/3 bifida, sinu angusto obtuso, laciniis anguste lanceolatis, cuspidatis porrectis vel divergentibus,

basi utrinque hastatim lobata, lobi lanceolati, apicalibus subaequimagni simillimi, recte patuli, in plano recurvi.

*Hab.* Novae Hebridae (Aneityum): Gunn legit (Watts, 38).

*Metzgeria antarctica* St. Centennial Glen, Blackheath, N. S. Wales.

*Metzgeria atrichoneura* St. Etta's Glen, Black Spur, Victoria: Watts, 1906; The Jungle, Blackheath, N.S.W., 1911.

*Metzgeria comata* St. Aneityum: Gunn per Lillie, 1911.

*Metzgeria glaberrima* St. Cambewarra Mountain and Leura, N. S. Wales.

*Metzgeria Howeana* St., n.sp.

Sterilis minor subhyalina vel leviter flavicans, debilis, corticola, dense depresso caespitans. *Frons* ad 15 mm. longa, subplana 3.5 mm. lata, plano-disticha, *alis* 8-10 cellulas latis, utrinque nudis, marginibus quidem longe denseque setulosus, setulis solitariis, simpliciter seriatis dense consecutivis, decurvis. *Costa* angusta, nuda, cellulis corticalibus utrinque biseriatis. *Cellulae* alarum marginales 27/36 $\mu$ , submarginales 36/36 $\mu$ , ad costam 36/54 $\mu$ , trigonis subnullis.

*Hab.* Australia, Mount Wilson and Wyong: Watts legit, 1065.

*Metzgeria longipila* St., n.sp.

Dioica magna gracillima flaccida, pallide flavo-virens, muscis consociata. *Frons* ad 7 cm. longa, irregulariter ramosa, ramis primariis ad 3 cm. longis, apice breviter furcatis, inferne sparsim breviterque pinnatis, paucis ramis basalibus e latere costae ortis, minute pinnatis, pinnulis iterum lateralibus. *Costa* angusta, in sectione transversa subrotunda, antice et postice 2 cellulis tecta, postice sparsim longeque pilosa. *Alae* valde decurvae, in plano 1 mm. latae, postice sparsim setulosae, marginibus dense pilosis, pilis geminatis, oppositis, divergentibus hamatis. *Cellulae* alarum marginales 27/54 $\mu$ , submarginales 36/36 $\mu$ , ad costam 54/54 $\mu$ . *Rami* feminei reniformes, marginibus longissime setosis.

*Hab.* Insulae Novae Hebridae (Aneityum): Gunn comm. (Watts, 60<sup>a</sup>.)



*Metzgeria nitida* Mitt. Mount Lidgbird, Mount Gower, and Saddleback, Lord Howe Island: Watts, 1911.

*Metzgeria pauciseta* St., n.sp.

Dioica, longissima, gracillima flaccida, flavicans, terricola, dense depresso caespitans lateque expansa. *Frons* ad 4 cm. longa, 1 mm. lata, irregulariter pinnata et bipinnata, nusquam furcata, semper e latere costae ramosa vel ex apice ramorum innovata, planta itaque maxime articulata, articulis 4 – 7 mm. longis. *Costa* angustissima in sectione transversa subrotunda, antice et postice 2 cellulis tecta, postice nuda; *alae* planae, nudaë, marginibus quidem sparsim setulosae, setulis simplicibus, strictis. *Cellulae* alarum 36/36 $\mu$ , ad costam 54/54 $\mu$ . *Rami feminei* obcordati, marginibus dense longaque setulosis.

*Hab.* Insulae Novae Hebridæ (Aneityum): Gunn legit (Watts 47c.)

*Pallavicinius campanulatus* St., n.sp.

Dioica mediocris, pallide virens, rigidula, terricola, dense depresso caespitans. *Frons* ad 2 cm. longa, 5 mm. lata, integerrima, simplex vel e costa innovans. *Involucra* campanulata, e latere costae orta, profundissime trifida, laciniis lanceolatis, irregulariter piliferis sublaceratis. Reliqua desunt.

*Hab.* Australia, New South Wales, (Valley of Waters): Watts legit, 1111.

*Pallavicinius Ridleyi* St. Aneityum: Gunn, 1911 (Hb. Watts, 58).

*Physocoleus casuarinae* St. On tree, Gladesville Hospital, Sydney, N. S. Wales.

*Plagiochila aneitiana* St., n.sp.

Sterilis major rigidula, flavo-rufescens, in cortice dense depresso caespitans. *Caulis* ad 5 cm. longus, simplex, rarissime ex apice furcatus. *Folia caulina* contigua, oblique patula, valde concava leviterque decurva, in plano ovato-trigona (3.5 mm. longa, medio 2.5 mm. lata) basi utrinque longius decurrentia, asymmetrica, margine *supero* late rotundato, regulariter denticulato, inferne

nudo, margine *infero* substricto nudo, apice quam basis subtriplo angustiore, breviter 3—4 dentato. *Cellulae* superae 27/27 $\mu$ , basales 27/63 $\mu$ , trigonis magnis, parietibus validis.

*Hab.* Insulae Novae Hebridae (Aneityum): Gunn legit (Watts, 47<sup>a</sup>.)

*Plagiochila ciliata* Gotts. Tangoa, Santo: Annand, 1909, (Hb. Watts, 7.)

*Plagiochila Ferdinandi Muelleri* St. Northern Lookout and Mount Gower, Lord Howe Island: Watts, 1911.

*Plagiochila fruticella* Tayl. Northern Lookout, Lord Howe Island: Watts, 1911.

*Plagiochila Gunniana* St., n.sp. Aneityum: Gunn, per Lillie.

*Plagiochila hebridensis* St., n.sp.

Dioica magna robusta flaccida, intense viridis, in rupibus humidis dense depresso-caespitans. *Caulis* ad 11 cm. longus, simplex vel parum longeque ramosus. *Folia caulina* contigua, oblique patula, parum concava, in plano anguste oblonga, (4.5 mm. longa, medio 2 mm. lata) symmetrica, margine *supero* leviter arcuato, inferne nudo, superne longius ciliato, margine *infero* substricto, superne irregulariter minuteque dentato, apice obtuso, similiter ciliato. *Cellulae* superae 27/27 $\mu$  basales 36/54 $\mu$  parietibus ubique validis. *Perianthia* juvenilia vix evoluta. *Folia floralia* caulinis simillima, fere ad basin usque spinosa. *Andraecia* desunt.

*Hab* Insulae Novae Hebridae (Aneityum): Gunn comm. (Watts, 78.)

*Plagiochila heterospina* St., n.sp.

Sterilis magna robusta rigida, dilute brunnea, in cortice dense depresso caespitans. *Caulis* ad 6 cm. longus, regulariter remoteque bipinnatus, ramis primariis 3 cm. longis, reliquis sparsis 1 cm. longis. *Folia* caulina conferta, oblique patula, canaliculatim concava, in plano oblongo-trigona (4 mm. longa, supra basin 2.25 mm. lata) asymmetrica, antice longe decurrentia, margine *supero* e basi



## CONTENTS.

	PAGE.
ART. I.—PRESIDENTIAL ADDRESS. By HENRY G. SMITH, F.C.S. ...	1
ART. II.—Napier Commemorative Lecture. The Discovery of Logarithms by Napier of Merchiston. By Professor H. S. CARSLAW, SC. D. ... ..	42
ART. III.—On the Accuracy of Neumann's Method for the Estimation of Phosphorus. By H. S. H. WARDLAW, B.SC. ... ..	73
ART. IV.—Hepaticæ Australes. By Dr. FRANZ STEPHANI and Rev. W. WALTER WATTS. (Communicated by Mr. J. H. MAIDEN). ... ..	94

ISSUED NOVEMBER 25th, 1914

Vol. XLVIII.

Part II.

JOURNAL AND PROCEEDINGS  
OF THE  
**ROYAL SOCIETY**  
OF  
NEW SOUTH WALES  
FOR  
1914

PART II, (pp. 129 - 288).

CONTAINING PAPERS READ IN

JUNE to OCTOBER (*in part*).

WITH SIX PLATES.

(Plates i, ii, iii, iv, v, vi.)



SYDNEY :

PUBLISHED BY THE SOCIETY, 5 ELIZABETH STREET NORTH, SYDNEY.

LONDON AGENTS :

GEORGE ROBERTSON & Co., PROPRIETARY LIMITED,  
17 WARWICK SQUARE, PATERNOSTER ROW, LONDON, E.C.

1914.

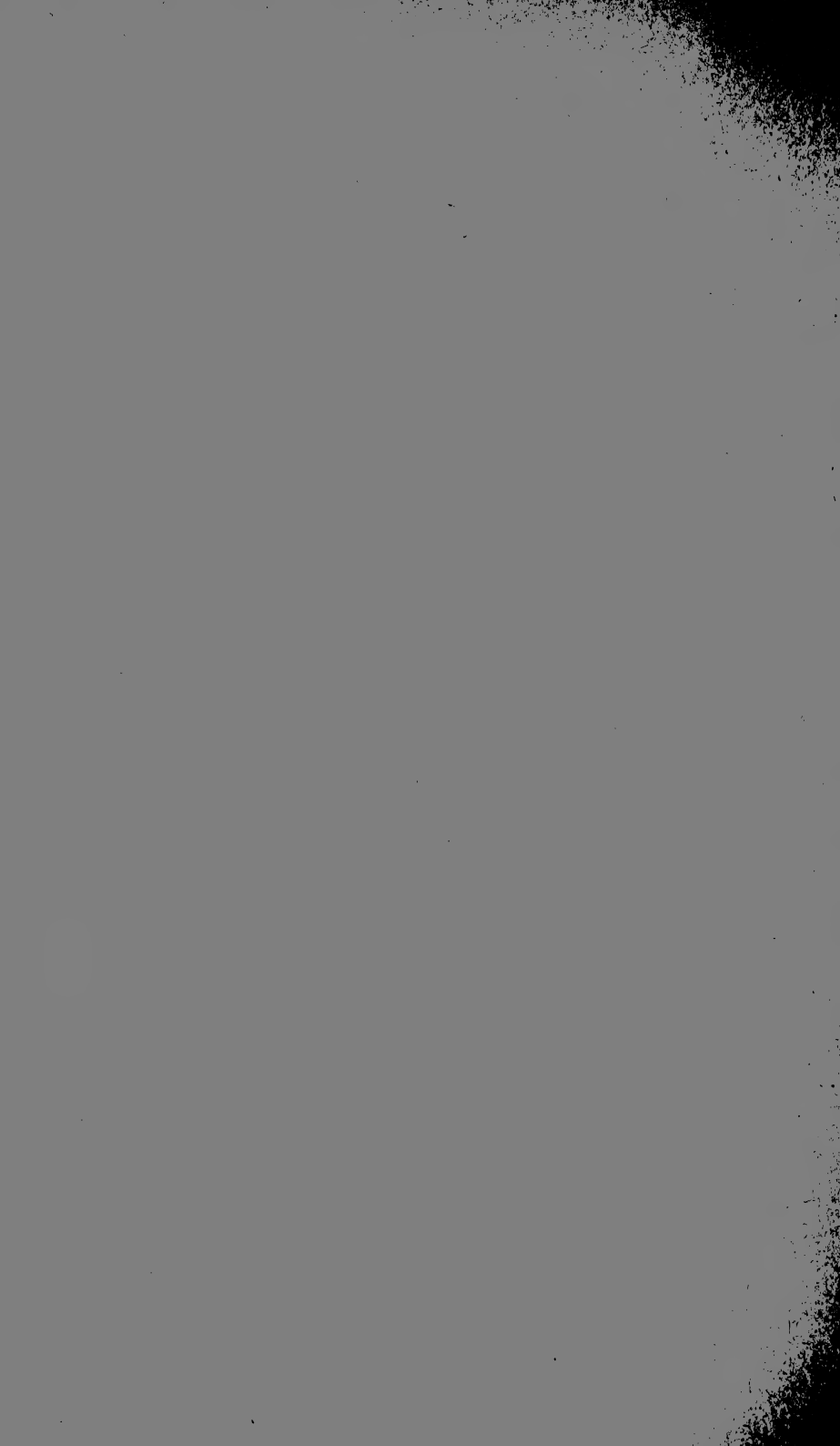

leviter rotundata stricto, remote irregulariterque dentato, margine *infero* stricto nudo vel sub apice paucidentulato, apice ipso 0·75 mm. lato, similiter armato. *Cellulae* superae 18/18 $\mu$  trigonis parvis, basales 18/45 $\mu$  trigonis nodulosi.

*Hab.* Insulae Novae Hebridae (Aneityum): Gunn leg. (Watts, 43<sup>b</sup>).

*Plagiochila Levierii* Schiffn. Aneityum: Gunn, per Lillie.

*Plagiochila Lilliana* St., n. sp. Aneityum: Gunn, per Lillie, 1911.

*Plagiochila palmicola* St., n.sp.

Sterilis magna flaccida, intense rufa, in ramis arborum laxae caespitans vel pendula. *Caulis* ad 10 cm. longus, inferne simplex, superne dense longeque bipinnatus, ramis fasciculatim confertis, 4 cm. longis, attenuatis, inferne validis, superne capillaceis. *Folia caulina* contigua, oblique patula, canaliculatim concava, in plano anguste lingulata (4 mm. longa, supra basin 2·25 mm. lata, apice 1 mm. lata) margine *supero* e basi rotundata stricto, irregulariter spinoso, spinis inferis approximatis, superis sparsis remotis, margine *infero* e basi leviter arcuata stricto, remote minuteque dentato, apice oblique truncato, irregulariter valideque trispinoso. *Cellulae* superae 18/27 $\mu$ , basales 18/36 $\mu$ , trigonis parvis, parietibus validis.

*Hab.* Insulae Novae Hebridae (Aneityum): Gunn leg. (Watts, 28).

*Plagiochila Riddleana* St., n.sp.

Sterilis magna rigidula, olivacea, laxae caespitans lateque expansa. *Caulis* ad 10 cm. longus, sparsim longeque ramosus, ramis apice saepe furcatis. *Folia caulina* conferta, oblique patula, canaliculatim concava, subinvoluta, in plano late ovato-trigona (4·5 mm. longa, supra basin 4·5 mm. lata) asymmetrica, margine *supero* e basi semirotonda stricto, regulariter remoteque denticulato, margine *infero* stricto, nudo, sub apice paucidentulato, apice ipso truncata, 1·25 mm. lata, similiter dentata, dentibus 6, magis approximatis. *Cellulae* superae 18/18 $\mu$ , basales 18/54 $\mu$  trigonis magnis acutis.

*Hab.* Novae Hebridae (Epi): Riddle legit (Watts, 21).



*Plagiochila Rossii* St., n.sp.

Sterilis mediocris rigida, virens, corticola, laxe intricata lateque expansa. *Caulis* ad 6 cm. longus, simplex vel parum longequè ramosus. *Folia caulina* conferta, oblique patula, canaliculatim concava, decurvula, in plano late ovato-trigona (5 mm. longa, supra basin 3.5 mm. lata) margine *supero* e basi rotundata semirotunda stricto, irregulariter denticulato, margine *infero* stricto nudo, sub apice dense minuteque dentato, apice angustissima, 0.75 mm. lata, tridentata. *Cellulae* superae 27/27 trigonis magnis acutis, basales 27/36 $\mu$ , trigonis magnis nodulosis.

*Hab.* Australia, N. S. Wales (The Jungle, Blackheath): Watts, 1035.

*Plagiochila santoensis* St., n.sp.

Sterilis minor gracilis rigidula, flavo-rufescens, corticola, dense depresso-caespitans lateque expansa. *Caulis* ad 35 mm. longus, simplex, rarius ramulo auctus, capillaceus fuscus. *Folia caulina* oblique patula, remotiuscula, leviter concava, in plano anguste oblonga (2.17 mm. longa, medio 0.67 mm. lata) inferne nuda, superne utrinque spinulosa, spinulis plus minus validis, irregulariter distributis, in margine *supero* magnis numerosis, apice emarginato-bifida, laciniis porrectis, angustis, 0.4 mm. longis cuspidatis, parallelis. *Cellulae* superae 27/36 $\mu$ , trigonis parvis, basales 18/36 $\mu$  trigonis subnullis.

*Hab.* Novae Hebridae (Santo): Bowie leg. (Watts, 16.)

*Plagiochila serrifolia* St., n.sp.

Sterilis parva flaccida, tenerrima, pallide virens, terricola, dense depresso-caespitans. *Caulis* ad 2 cm. longus, simplex, rarius ramulo auctus. *Folia caulina* contigua, subrecte patula, parum concava, in plano optime rhombea (1.75 mm. longa, 1.25 mm. lata) margine *supero* substricto, inferne nudo, superne remote denticulato, margine *infero*, illo parallelo, stricto, nudo, apice oblique truncata, basi optime parallela, similiter dentata. *Cellulae* superae 36/36 $\mu$ , basales 27/45 $\mu$  trigonis nullis, cuticula basalis striolata, superne nuda.

*Hab.* Australia, New South Wales (Wyong): Watts, 1100.



*Plagiochila supradecomposita* St., n.sp. Aneityum: Gunn, 1911; (Hb. Watts 33 ex p.) Included in return, but not described in this paper.

*Plagiochila Victoriae* St., n.sp.

Sterilis mediocris, rigida, virens, corticola, laxè intricata, valde aromatica. *Caulis* ad 6 cm. longus, simplex vel parum longè ramosus. *Folia caulina* remotiuscula, decurvo-homomalla, in plano ovato-trigona (4 mm. longa, medio infero 2·5 mm. lata) asymmetrica, margine *supero* valde arcuata, subangulato, regulariter valideque dentato, margine *infero* stricto, nudo, apice 0·65 mm. lato, oblique truncato, tridentato, dente mediano multo minore. *Cellulae* superae 18/18 $\mu$ , basales 18/54 $\mu$ , trigonis magnis acutis.

*Hab.* Australia, Victoria (Lorne: leg. Miss E. L. Watts) Hb. Watts, 910.

*Pleurozia gigantea* Weber. Aneityum: Gunn, 1911; (Hb. Watts, 51.)

*Preissia commutata* (Ldbg.) Nees. Valley of Waters, N. S. Wales.

*Ptychanthus effusus* St. Futuna: Gunn, 1911 (Hb. Watts, 61, 62, 80).

*Ptychanthus rhombilobulus* St., n.sp.

Monoica maxima gracilis rigidula rufescens, corticola, laxè intricata lateque expansa. *Caulis* ad 18 cm. longus, tenuis, regulariter remoteque pinnatus, pinnis inferis longioribus, ad 2 cm. longis, paucis pinnulis auctis. *Folia caulina* imbricata, oblique patula, leviter concava, in plano ovata (3·5 mm. longa, medio 2·25 mm. lata) subsymmetrica, apice apiculata, sub apice utrinque paucidentata, margine *supero* e basi rotundata longe arcuato appendiculo basali rotundato, margine *infero* e basi stricta similiter arcuato. *Cellulae* 14/27 $\mu$  ubique aequales, parietibus validis *Lobulus* parvus, rhombeus (0·6 mm. longus, 0·4 mm. latus) apice truncatus, angulo apiculato. *Amphigastria* caulina magna, late cordiformia (2·25 mm. longa, supra basin 2 mm. lata) basi profunde

excisa, optime cordata, apice angustiore (3 mm. lato) beviter inciso-bilobato, lobis late triangulatis acutis, ubique denticulatis. *Perianthia* anguste pyriformia, bene rostrata, 8 – 10 plicata. *Folia floralia* intima et amphigastrium florale caulinis simillima, lobulo foliorum parvo rhombeo. *Androecia* terminalia, saepe mediana, bracteis 4 – 8 jugis.

*Hab.* Novae Hebridae (Santo: Bowie; Epi: Riddle) Watts' 10, 22.

*Pycnolejeunea Wattsiana* St., n.sp.

Dioica magna gracilis flaccida olivacea, in cortice laxe caespitans lateque expansa. *Caulis* ad 4 cm. longus, breviter remoteque pinnatus, pinnis longioribus paucipinnulatis. *Folia caulina* imbricata, subrecte patula, parum concava apiceque decurvula, in plano oblongo-elliptica (1.5 mm. longa, 0.9 mm. lata) asymmetrica, margine supero longe arcuato, infero substricto, apice rotundata, basi antica rotundata, caulem tegentia, integerrima. *Cellulae* superae 18/18 $\mu$  trigonis parvis, basales 27/36 $\mu$  trigonis majusculis, parietibus validis. *Lobulus* maximus, linearis (0.83 mm. longus, 0.2 mm. latus) carina leviter adscendens, stricta, levi sinu in folium excurrens, apice recte truncatus, angulo acuto. *Amphigastria caulina* magna, caule plus triplo latiora, sinuatim inserta, ad medium bifida, sinu semirecto obtuso, lobis triangulatis acutis porrectis. *Folia floralia* oblongo-obconica (1.17 mm. longa, sub apice 0.6 mm. lata) apice rotundata, integerrima, *lobulus* tertio brevior, sublinearis, quintuplo longior quam latus, breviter solutus, acutus vel obtusus. *Amphigastrium* florale lobulis aequilongum, oblongum, duplo longius quam latum, apice breviter inciso-bilobatum, rima angusta, lobis acutis. Reliqua desunt.

*Hab.* Lord Howe Island (Watts legit, 19, 24).

*Radula javanica* Gotts. Futuna: Gunn, 1911 (Hb. Watts 72).

*Radula reflexa* Nees et Mont. Tangoa, Santo: Annand, 1909 (Hb. Watts, 4).

*Radula tjibodensis* Goobl. Port Moresby, Papua: leg. Conroy, Nov. 1911.

*Radula Wattsiana* St. Rodriguez Pass, Grand Canyon and Blackheath Glen, N. S. Wales.

*Reboulia hemisphaerica*. Valley of Waters, N.S.W.

*Schistochila Blumei* G. and J. Aneityum: Gunn (Hb. Watts, 32).

*Schistochila hebridensis* St., n.sp. Aneityum: Gunn, 1911, per Lillie.

*Schistochila integerrima* St., n.sp. Aneityum: Gunn, 1911, per Lillie.

*Schistochila Lehmanniana* (Nees). Etta's Glen, Black Spur, Victoria: Watts, 1906.

*Schistochila longifolia* St. Aneityum: Gunn, 1911 (Hb. Watts, 40, 48, 52, 56).

*Schistochila sumatrana* St. Tangoa, Santo: Bowie, 1909 (Hb. Watts, 19); Aneityum: Gunn, 1911 (Hb. Watts, 31).

*Symphyogyna dendroides* St. Etta's Glen, Black Spur, Victoria: Watts.

*Symphyogyna hymenophylla*. Leura Glen, N.S.W.

*Symphyogyna multiflora* St., n.sp.

*Dioica minor viridis flaccida terricola, gregarie crescens. Frons* ad 25 mm. longa, angusta (2—3 mm. lata) integerrima, simplex vel pauciramosa; costa valida, ramis oblique patulis, angustis, ex apice innovata et repetito innovata, fronde itaque longissima, ad 4 cm. longa. *Cellulae* marginales  $27/54\mu$ , submarginales  $27/54\mu$  basales  $54/90\mu$ . *Involucra* late obcuneata, apice longe angustaque laciniata. *Capsula* anguste cylindrica, 2 mm. longa. *Elateres* 1 mm. longi, spiris duplicatis. *Sporae*  $14\mu$  subleves, flavescens. *Androecia* ignota.

*Hab.* Australia, New South Wales (Valley of Waters): Watts legit, 1127.

*Symphyogyna rhodina* Tayl. Valley of Waters, N.S.W.

*Symphyogyna semi-involucrata* Aust. Valley of Waters,  
N. S. Wales.

*Thysananthus Bowienus* St., n.sp.

Diocia maxima gracilis rigidula, in cortice pendula laxaque intricata. *Caulis* ad 25 cm. longus, regulariter remoteque pinnatus, ramis simplicibus, hic illic pinnula auctis. *Folia* caulina parum imbricata, oblique patula, canaliculatim concava, in plano oblongo-trigona, (1.67 mm. longa, supra basin 1.9 mm. lata, apice 0.5 mm. lata) symmetrica, marginibus e basi rotundata longe arcuatis, substrictis, apice trigona, angulis minute apiculatis; aliis dentibus interjectis, similibus. *Cellulae* superae  $18/18\mu$ , basales  $14/36\mu$ , trigonis nodulosis in medio et angulis parietum. *Perianthia* (juvenilia) late obconica, inferne nuda, superne longe ciliata, rostro valido. *Folia floralia* et *amphigastrium* florale caulinis simillima. *Androecia* desunt.

*Hab.* Novae Hebridae (Santo): Bowie leg. (Watts, 18).

*Thysananthus hebridensis* St., n.sp. Aneityum: Gunn,  
per Lillie.

*Thysananthus planus* Sande. Aneityum: Gunn, per Lillie.

*Thysananthus spathulistipus* Ldbg. Aneityum: Gunn,  
per Lillie.

*Trichocolea australis* St. Erskine Valley, Lord Howe  
Island: Watts, 1911.

*Trichocolea minutifolia* St., n.sp.

Sterilis pusilla flaccida, pallide virens, corticola, dense depresso-caespitans. *Caulis* ad 25 mm. longus, ramis primariis remotis, 5 mm. longis, dense pinnatis, pinnis 2 mm. longis, superis gradatim brevioribus, frondem trigonam formantibus. *Folia caulina* imbricata, subrecte patula subquadrata, symmetrica (0.67 mm. longa et lata). Discus basalis integer humillimus, unam cellulam longus, apice quadrifidus, laciniis setaceis, superne breviter bipinnatis,

pinnis primariis 0·17 mm. longis, secundariis 0·08 mm. longis, omnibus remotiusculis. *Amphigastria* caulina foliis simillima.

*Hab.* Australia (Wyong): Watts legit, 950.

*Trichocolea samoana* St. Aneityum and Futuna: Gunn, 1911 (Hb. Watts, 50 and 70).

*Trichocolea tomentosa.* Wyong, N.S.W.

*Trichocolea Wattsiana* St., n.sp.

Sterilis pusilla, viridis flaccida, terricola, dense depresso-caespitans lateque expansa. *Caulis* ad 2 cm. longus, regulariter bipinnatus, ramis primariis 6 mm. longis, remotis, sparsim minuteque pinnulatis. *Folia* caulina exigua, imbricata, erecto-homomalla, asymmetrica, discus basalis integer 0·33 mm. latus, apice oblique truncatus (margine supero 0·33 mm. longo, infero 0·17 mm. longo) apice quadrifida, *lacinae* primariae divergentes, 0·67 mm. longæ, validæ, attenuatæ, *ramis* primariis trijugis, inferis 0·5 mm. longis, mediis 0·33 mm. longis, supremis 0·17 mm. longis. *Amphigastria* caulina foliis simillima, symmetrica.

*Hab.* Australia (Wyong): Watts, 986.

*Zoopsis argentea* Hook. Mount Gower, Lord Howe Island: Watts, 1911; also Grand Canyon and Rodriguez Pass, N. S. Wales.

*Zoopsis Leitgebiana* C. et P. Rotunda, Blackheath, and Lane Cove River, N. S. Wales.

*Zoopsis setulosa* Leitg. Horseshoe Falls, Blackheath, Centennial Glen, and Wentworth Falls, N. S. Wales.

---

## DIMORPHIC FOLIAGE OF *ACACIA RUBIDA*, AND FRUCTIFICATION DURING BIPINNATE STAGE.

By R. H. CAMBAGE, F.L.S.

With Plate I.

[Read before the Royal Society of N. S. Wales, June 3, 1914.]

AUSTRALIA is the home of the phyllodineous Acacia, that form of Wattle which, as an adaptation to environment, has gradually dispensed with its ancestral type of pinnate leaves, and developed a flattened leaf-stalk or phyllode to carry on the functions of ordinary leaves. A few of this class are also found in New Caledonia, the Indian Archipelago, and the Pacific Islands.<sup>1</sup>

In a large genus like that of Acacia, there are naturally many stages of transition to be met with in this process of evolution, from those forms which wholly retain the bipinnate leaves on the adult trees, to those which never show them after the plants are a few inches high.

A common sequence of seedling leaves with a number of Acacias, is that immediately after the cotyledons, there comes one simply-pinnate leaf, and after that, a varying number of alternate abruptly bipinnate leaves appear, the common petioles being mere stalks on the lower leaves, but gradually becoming more dilated on the upper ones, until at last they develop without any bipinnate leaves on their tips, and now, as phyllodia of various widths, carry on the functions of leaves.

In addition to those mentioned by Lubbock<sup>2</sup> this is also the usual sequence with, amongst others, such typical

---

<sup>1</sup> B.Fl., Vol. II, p. 301.

<sup>2</sup> See Sir John Lubbock, "A Contribution to our Knowledge of Seedlings," Vol. I, p. 399, (1892).

species as *Acacia rubida*, *A. longifolia*, *A. floribunda*, *A. linifolia*, *A. elongata*, *A. juniperina*, *A. vestita*, *A. hispidula*, *A. Cunninghamii*, *A. falcata* and *A. melanoxylon*. Probably some trace of this ancestral foliage is to be found on all *Acacia* seedlings, but as an evidence that the process of evolution is still in progress there is the fact that not only is there a wide range of leaf-form among various species, but also is there variation in the persistence of the bipinnate leaves on seedlings of the same species.

A seedling of *Acacia melanoxylon* recently raised, ceased to produce bipinnate leaves after it had reached a height of about three inches while other seedlings of this species from sheltered situations at Mount Wilson, have been known to reach five feet before showing any phyllodia.

One of the most interesting *Acacias* which furnish examples of dimorphic foliage is *A. rubida*, *A. Cunn.*, though Bentham makes no allusion to the bipinnate leaves when referring to this species, and was probably not aware of their existence.<sup>1</sup>

This plant grows on siliceous rather than basic formations preferring a fairly cool climate, and extends along the mountain region throughout New South Wales, and slightly into the adjoining States, flourishing in damp spots on the moist rather than on the dry side of the mountains.

#### SEEDLING OF *A. rubida*.

*Hypocotyl* at first curved, later erect, terete, 7 mm. above the soil, 1 mm. thick.

*Cotyledons* sessile, oblong, about 7 mm. long and 3.5 mm. broad, of a red colour on both sides, glabrous.

The *pinnate leaf*, which springs with a short stalk, from the same level as, and about midway between the cotyledons, has up to five pairs of leaflets, each leaflet being much

---

<sup>1</sup> B. Fl., Vol. II, p. 366.

the same shape as the cotyledons and slightly smaller, glabrous, often mucronate, red underneath, the colour showing through as rusty to the upper surface, venation, only seen under lens, resembling that of *A. pruinosa*, having an oblique midrib, and a short second vein nearly parallel to the midrib, the rachis hoary.

Opposite the pinnate leaf and slightly higher, is the first bipinnate leaf with a common petiole of 7 mm., and 8 pairs of leaflets. Above this the leaves are alternately placed with pinnæ in 2 to 5 pairs, up to 5 cm. long; leaflets 10 to 14 pairs. At length the phyllodia begin to appear, but in some cases the plant is as much as 10 feet high while still covered with only bipinnate leaves.

The number of leaflets, either on the pinnate or even on the first bipinnate leaves of the same species does not appear to be constant.

A feature of the cotyledons of this and several other species of *Acacia* is that after coming out of the ground they remain almost erect for nearly a week, and their advent is rapidly followed by the development of the one pinnate leaf which shows above the edges of the cotyledons within two or three days (See Plate I), or earlier than the seedling foliage of *Eucalyptus* species succeed the cotyledons. In one week from the time the cotyledons showed, in January, the pinnate leaf of *Acacia rubida* measured half an inch, and the five pairs of leaflets were nearly fully developed: while the cotyledons had almost assumed a horizontal position. The rate of development, however, is more rapid in summer than in winter.

Although it is a common sight to see the dimorphic foliage on such species as *Acacia neriifolia*, *A. melanoxylon*, *A. rubida*, and others, I can find no record of a phyllodineous species of *Acacia* fruiting before it has developed phyllodia. Such takes place, however, at least in the case



of *A. rubida*. On the 6th December, 1913, I collected several fruiting specimens, and saw many more, of this species having only the bipinnate leaves. The plants are growing in a fairly moist portion of the sandy valley just below the residence of Professor David at Woodford, and those bearing pods, which were then just ripe, varied in height from 9 inches in the stunted forms to 10 feet in the luxuriant ones.

The occurrence is full of interest, especially in connection with problems relating to the evolution of the genus *Acacia*, and although *A. rubida* has developed the dilated petiole, in common with scores of other species, in response to some requirement, it is able to fulfil all its functions both as regards flowering, fruiting, and producing fertile seed, either in its original form or its new state or development.<sup>1</sup>

This discovery raises the interesting question as to whether this species is still developing into a strictly phyllodineous *Acacia*, and will at some future period produce flowers and fruits only after the advent of the phyllodia, or whether it may not be reverting to its original form and will later dispense altogether with the phyllodia. A further paper, on *Acacia* seedlings, which is in course of preparation, may help to throw some light on the question of the evolution of the genus.

#### EXPLANATION OF PLATE.

##### *Acacia rubida*.

1. Cotyledons, 5 days old, with tips of pinnate leaf showing.
2. Cotyledons and pinnate leaf, 2 days later.
3. Twig of plant bearing pods, and having only bipinnate leaves.
4. Twig of plant bearing pods, and having phyllodes.
5. Seeds.

Numbers 1 and 2, slightly under natural size; 3, 4 and 5, slightly under half natural size.

---

<sup>1</sup> For figures of pods of *Acacia rubida*, see Proc. Linn. Soc, N.S. Wales, xxii, (1897) p. 695, (R. T. Baker, F.L.S.). Also "The Forest Flora of New South Wales," Part XLIX, p. 185, by J. H. Maiden, F.L.S.

THE AUSTRALIAN JOURNAL OF DR. W. STIMPSON,  
ZOOLOGIST.

With an introduction by CHARLES HEDLEY, F.L.S.

[*Read before the Royal Society of N.S. Wales, July 1st, 1914.*]

A notable pioneer in Australian marine zoology was Dr. William Stimpson, a native of Boston, U.S.A. and a pupil of Agassiz. Distinguished in his youth for his studies on the marine fauna of New England, U.S.A., he was appointed naturalist to a national scientific expedition to the Pacific, on the U.S.N. "Vincennes," under the command of Capt. John Rodgers. Thus he came to visit Australia. At the conclusion of his journey, he reported to Professor Dana that he had secured a collection of 12,000 species.<sup>1</sup>

As with Hooker, Darwin and Huxley, a voyage round the world brought him greater power and broader thought. To elaborate his discoveries and complete his life work, he settled down as Director of the Chicago Academy of Sciences. But in an instant a dreadful accident ruined his career and wasted all his talents and his industry. A great fire destroyed the city of Chicago in 1871. This conflagration consumed the building of the Academy with all Stimpson's scientific property.

He lost not only his own library, collection, manuscripts and drawings, the labour of a lifetime, but also materials lent to him for study and description by other people and institutions. From this crushing misfortune he never recovered, his health broke down and he died the following year.

---

<sup>1</sup> The American Journ. Science Art., Ser. ii, Vol. xxiii, Jan. 1857, p. 136. Rathburn, Descrip. Cat. G. Internat. Fish Exhib. 1883. p. 21.

According to Stearns,<sup>1</sup> he was a man of charming personality. His industry is shown by fifty-two papers, chiefly dealing with crustacea and mollusca, which he wrote between 1848 and 1872. Among these are several bulky and valuable memoirs.

The account of his Australian discoveries are scattered through a series of publications and have never been assembled. No details of his visit here have appeared in literature, but the manuscript journal of his voyage is preserved at the Smithsonian Institute. By the kindness of Dr. Paul Bartsch I am now enabled to present a copy of that portion of it which relates to Stimpson's visit to Australia.

My correspondent writes:—"I can help you with the date of Stimpson's visit to your territory, for we have his journal. In fact, I will go farther and extract from it all the data which will be of interest to you." Here it follows:

---

"Dec. 8, 1853. S. Lat. 45° 14'. E. Lon. 112° 19'. Wind N.E. 7 kn.

Dec. 9th. S. Lat. 46° 11'. E. Lon. 117° 6'. Wind N. 9 kn.  
The temperature of the air is now 57°, that of the water 49°.

10th. S. Lat. 46° 39'. E. Lon. 122° 20'. Wind N. Av. 8 kn.  
The bird noticed on the 5th inst. as resembling V-23, was seen for the last time to-day. The most southern latitude passed in this voyage is now reached.

11th. S. Lat. 46° 26'. E. Lon. 126° 41'. Wind N.W. Av. 7 kn.  
To-day is Sunday, but as usual in this latitude, at least in our experience, the weather permitted neither the performance of Divine Service, nor the muster of the ship's company.

12th. S. Lat. 46° 19'. E. Lon. 130° 11'. Wind N.W. Av. 6 kn.  
We still pass floating Kelp in considerable quantities. Each bunch consists of a cluster of elongated fronds like those of

---

<sup>1</sup> Stearns, Proc. Californ. Acad. Sci. iv, 1871, 1872, (1873) p. 230.

Laminaria, on stalks radiating from a thick ovate central stalk. Another of the white-bellied Porpoises was killed to-day. The weather is now quite pleasant.

13th. S. Lat  $46^{\circ} 12'$ . E. Lon.  $134^{\circ} 41'$ . Wind N.W. Av. 6 k.

14th. S. Lat.  $45^{\circ} 42'$ . E. Lon.  $139^{\circ} 39'$  Wind S.W. Av. 9 k.

A pure white bird, of the size of *D. fuliginosus*, but rather the shape of *D. exulans*, was seen to-day. While looking at it I could scarce help concluding that it, and *D. chlororhynchus?* also, were among the numerous varieties (if varieties is a proper term for several forms seen in these latitudes) of *D. fuliginosus*.

15th. S. Lat.  $45^{\circ} 45'$ . E. Lon.  $144^{\circ} 27'$ . Wind S.W. Av. 7 k.

16th. S. Lat.  $45^{\circ} 1'$ . E. Lon.  $148^{\circ} 29'$ . Wind W. Av. 9 k.

A cast for temperature was taken with the following results: Surface t. =  $54^{\circ}$ . At 100 fms. =  $50^{\circ}$ . At 500 fms. =  $45^{\circ}$ .

17th. S. Lat.  $42^{\circ} 53'$ . E. Lon.  $151^{\circ} 55'$ . Wind S.W. Av. 8 k.

Having passed the southern point of Van Diemen's Land we now begin to haul up to the northward. A small "Mother Cary's Chicken" was seen to-day, of a species new to us, but very much resembling V-24. The water has a greenish tinge.

18th. S. Lat.  $40^{\circ} 14'$ . E. Lon.  $154^{\circ} 9'$ . Wind S.W. Av. 7 k.

Sunday. In the evening the strong S.W. wind, which has done us so good service for some weeks past, left us, and we enter the region of variables.

19th. S. Lat.  $38^{\circ} 59'$ . E. Lon.  $154^{\circ} 11'$ . Wind N. Av. 5 k.

The temperature is now  $64^{\circ}$ , that of the water  $62^{\circ}$ .

20th. S. Lat.  $38^{\circ} 47'$ . E. Lon.  $152^{\circ} 40'$ . Wind N. Av. 3 k.

The calms now give me an opportunity of using the tow-net to advantage. At noon I took a *Salpa*, a *Vellela*, a small *Physalia* with apical vesicles separate from its regular vesicle cluster, and a singular blue or glaucous *Idotea* which was common on little sticks, etc., covered with Anatifae. A very remarkable Stomapod was also taken.

21st. S. Lat.  $38^{\circ} 1'$ . E. Lon.  $152^{\circ} 34'$ . Wind E. Av. 3 k.

In the evening the tow-net took a variety of interesting animals. Hyperinae were chiefly abundant, both in species and individuals. A *Monolepis*, Pteropoda of the usual genera, many Stomapoda, and a Phylliroe, also occurred. During the daytime three species of *Salpa* (one a singular tentaculiferous form) and a *Firola* of large size, and a few discoid Medusae, were taken.

22nd. S. Lat  $36^{\circ} 20'$ . E. Lon.  $152^{\circ} 14'$ . Wind N.E. Av. 4 k.

Our progress is now much hindered by calms which, however, afford me an opportunity of increasing my collection of pelagic animals. Many forms were added to those already taken, the Hyperines still maintaining their ascendancy. The birds have now all left us, the albatrosses being last seen. The sky at evening now begins to assume the green appearance peculiar to tropical or subtropical regions.

23rd. S. Lat.  $35^{\circ} 55'$ . E. Lon.  $151^{\circ} 10'$ . Wind variable, 2 k.

At noon the coast of New Holland or Australia, was in sight to the westward. It had the appearance of low land, forming a succession of clumps along the horizon, with considerable uniformity of height. To-day a *Salpa*, *Glaucus*, a few Crustacea, and several curious pelagic fish (*Scopeli*, etc.) were added to those species already taken on this coast.

24th. S. Lat.  $34^{\circ} 52'$ . E. Lon.  $151^{\circ} 55'$ . Wind N.W. Av. 6 k.

In the afternoon as we neared the land a petrel was seen flying ahead of the ship instead of astern over the wake, it was of a brown color, or greyish-brown, size of our Gulf petrel; a "Mother Cary's Chicken" but more slender, and with sharper wings, as in the whale bird. At sunset we were within a dozen miles of the land, which was but little elevated, and the nearest points appeared of a rusty brown color. A hot wind came off from the land, bringing with it innumerable insects, many of which sought refuge on the ship, and others having fallen into the water were taken with the tow-net. There were butterflies of four species, two kinds of moths, three of *Libellulae*, many wasps and flies, and a dozen or more species of *Coleoptera*. While we were enjoying this scene, the wind suddenly shifted to the southward and eastward,

and blew most violently, so that we were soon reduced to close reefed topsails and trysails on the off shore tack. The storm ceased, however, soon after midnight.

25th. S. Lat.  $33^{\circ} 50'$ . E. Lon.  $151^{\circ} 52'$ . Wind variable. Av. 4 k.

Sunday —To-day is Christmas, but we are disappointed in our hopes of eating our Christmas dinner ashore. The entrance of Port Jackson, with the lighthouse, was, however, visible in the afternoon, when it unfortunately fell calm, preventing us from reaching the port this day.

26th. At daylight we commenced beating in to the mouth of the harbor, which we entered at eight o'clock, and at nine we anchored below Garden Island, and about  $2\frac{1}{2}$  miles from the town of Sydney. The harbor is one of the most beautiful I have ever seen, the verdure descending to the water's edge. It is so landlocked and its waters are so smooth, that it presents rather the appearance of a pond of fresh water than an inlet of the sea. It is a long, crooked bay, with a series of beautiful coves along each shore, and containing many small islands. The depth of the water is everywhere nearly the same (from 9 to 12 fms.) there being only one shoal in the harbor (the Sow and Pigs, near the entrance) so that for the purpose of commerce it is one of the finest in the world. In the afternoon I took a boat and examined the shores. They were composed of horizontal strata of a coarse but uniform sandstone, which was worn into the most singular shapes by the action of the water and tides, which rise and fall here from 6 to 8 feet. The rocks of the first and second subregions (which only were uncovered this afternoon) were inhabited by several species of crabs of medium size, of the genera *Grapsus*, *Cyclograpsus*, *Cancer*, etc., and a great variety of littoral mollusks of the genera *Trochus*, *Monodonta*, *Nerita*, *Purpura*, *Littorina*, *Siphonaria* and *Patella*, there being in all about eight species of these genera, all very common, and all of about equal size (the *Littorina* excepted), three-fourths of an inch in diameter. A small dark green *Asterina* was also very common; and a Nemertes and a few Amphipods (*Anorchestes*) were found. A little gregarious bivalve resembling

*Venus gemma* was very common. On returning to the ship a dredge-ful of the mud which forms the bottom of the harbor in 8 - 12 ft. produced two singular spinous *Holothuriae*, a long-armed *Ophiolepis*, a *Chetopterus*, a common purple *Astropecten* and several worms and *Amphipoda*.

In the evening, together with several of the officers, I went into one of the coves on a swimming excursion, and landed at a place where a fine sandy beach extended for half a mile between two rocky promontories.

27th. This day was spent in the city of Sydney, which I found to be a large place of 60,000 inhabitants, and having fine buildings, the private residences even being built of sandstone. Through the kindness of Mr. Skead, one of the clerks of Mr. Clark, the American Consul, I visited the shop of Mr. Wilcox, natural history dealer, whom I found to be a man of information, and I spent several hours very agreeably in examining the curious forms of mammalia and birds peculiar to Australia, of which Mr. W. had a very full collection. He also showed me a number of species of oceanic birds of the southern hemisphere, described by Gould and others, by which I find that the number of species is much greater in the Southern Ocean, than I had been led to suppose from what I saw on the passage. The English ship "Akbar," which ship we spoke on the 24th Nov. in 60° E. Lon., arrived here to-day, we having beat her by one day.

28th. To-day I went on a dredging excursion to the mouth of the harbor, with Mr. Wilcox,<sup>1</sup> in my little sheet-iron boat the "Pollywog." We visited the celebrated Trigonia locality, near the "Sow and Pigs," and dredged, besides many living Trigoniæ, some 30 or 40 more species of shells, very many crustaceans and a few annelides (see notes). One of the most curious animals obtained was a marine leech, with actions precisely like those of the common freshwater leeches from which it differed in its small size and the hardness of its papillated skin. This prize, however,

---

<sup>1</sup> Wilcox, see these Proceedings, XLII, p. 129.

escaped. The bottom at the locality was a clean shelly sand, the depth about three fathoms.

29th. I spent this day in the city, examining Wilcox's collection. That gentleman gave me some curious accounts of some naturalists whom I had long known by reputation, but did not dream of finding *in propria persona* in this part of the world. He informed me that Macleay, the originator of the "circular theory" of classification in natural history, was now residing at this place, and that Swainson,<sup>1</sup> who carried out that theory so fully in zoology (see his works in Lardner's Cyclopedia) was now wandering in these parts, poor and neglected, though still hopelessly moping over zoological subjects, though old and past active and useful labor in the field of science. As I listened to Wilcox's account the conceit entered my mind that these two men were banished, as it were, from the scientific world of the Atlantic shores, for the great crime of burdening zoology with the false though much labored theory which has thrown so much confusion into the subject of its classification and philosophical study. In the afternoon I visited the officers of a new French clipper ship now lying in this port, by whom I was treated with the extreme politeness so characteristic of Frenchmen, which contrasts so strongly with the selfish and often contemptuous silence of Englishmen when meeting gentlemen having no formal introduction, and with the awkwardness of Americans in a similar situation. This night I spent ashore at the Royal Hotel, where I met two or three gentlemen from Boston, one of whom had resided in Cambridge, close to my father's residence.

30th. To-day I had an opportunity of examining the shores of the harbor at a low spring tide. I investigated chiefly at Garden Island. The species of invertebrata obtained were too numerous to catalogue here, (for full descriptions or notices see notes). The Ophiuridae were large, and behaved with an activity which was to me quite astonishing. Some of the Ascidians were

---

<sup>1</sup> Swainson, See Proc. Linn. Soc. N.S.W., xxvi, p. 796, and Vict. Nat., xxv, p. 113.



six inches in diameter, with apertures nearly an inch square. Large Chitons and a large Chitonellus were very common, as were also Trochi, Parmophori and Tritons of considerable size, a pretty pink Pleurobranchus, and a green Aplysia. Two species of Echini lived just below low water mark. Crustaceans were not very abundant.

In the evening I went with our Commodore and a few of the officers, to visit and dine with Sir Charles Nicholson, who is probably the chief literary man in the country. He had a splendid library, a botanic garden, etc., and his agreeable manners enabled us, together with the other gentlemen present, to pass a very pleasant evening.

31st. This morning I visited the Sydney Museum (of Science) where I found a very scientific man, Mr. Wall, Curator of the Natural History Department. He showed me many interesting shells, and many unique cetacean skeletons, among which latter were a perfect example of that of *Catodon australis*, which was of great size and mounted outside of the building, and also one of his new genus *Euphysates*. He gave me copies of the work in which this latter genus was described, for distribution among our naturalists at home, and for myself. He gave me an account of his reasons for suggesting the application of a propeller to steam vessels on the same principle as that forming the motive organ of the whale, namely, the tail. He complained of the contempt with which his own countrymen had treated this attempt to make principles taken from nature serve in art, and extolled the Americans for the encouragement always given by them to efforts to make improvements in the mechanic arts, however problematical they might appear to a superficial observer. He also showed me a copy of one of the first numbers of a scientific journal now published in this part of the world (Hobart Town, V.D.L. (?)) which contained an account of the Australian fresh-water Entomostraca, with a few coarse figures, by Rev. Mr. King of Sydney. The genera showed a great similarity to the Entomostraca of this country to those of Europe. Mr. Wall treated us (Messrs. Wright,

Storer, and myself) with great politeness, and after leaving him we went to see Mr. Macleay, who lives in a large house, having extensive grounds, situated beyond the town of Woolloomooloo. He treated us with kindness, and showed us his fine collection of insects, and the plants of his large garden. He appeared to care little for marine invertebrata, and on the whole I was not much interested by my visit. He is a man of immense general information, having a remarkable memory, and is equally versed in zoology and botany. He is now about 80 years of age, and his working days are over.<sup>1</sup> . . . .

To-day I made one of several visits to the Botanic Garden of Sydney, which is very extensive, and much resorted to by the citizens. It is arranged and cared for in a very scientific manner, each tree and plant having its name painted on a board at its foot. In the centre of the garden I noticed the tomb of Cunningham.

Jan. 1, 1854, Sunday. To-day the Commodore, Mr. Boggs, Mr. Kern, and myself, with Mr. Clark and another gentleman, formed a party to visit the monument of La Perouse at Botany Bay. After a ride of about seven miles through a sandy country, and passing through a grove, we arrived at the Sir Joseph Banks Hotel (named after the great naturalist who accompanied Cook on his first voyage, and who landed here). After a good dinner, of which Boston ice was no unwelcome concomitant, we took a boat and proceeded down the bay. Its opening is rather wide, and it is near the shores, shallow, presenting, at low water, many broad sandy beaches, which abound in a *Zostera*, like ours, which affords food to numerous *Trochi*. The second subregion is thickly strewn with a large *Cerithium*.

We landed on a smooth sandy beach near the entrance of the bay, and while the rest of our party walked up the hill to the monument, I searched, with the help of a spade, the sand near low water mark, and found a few crustacea and many very interesting

---

<sup>1</sup> W. S. Macleay, see Proc. Linn. Soc. London, 1864-5, p. cii, but who was then sixty not eighty.—[C.H.]

worms (see notes). A pretty little crab, of a sky-blue color (*Mycteris longicarpus*) lives in crowds on these shores at about half-tide mark, in holes—it corresponds to our fiddler or soldier crab (*Gelasimus vocans*). After a pleasant sail back to the hotel we returned in our carriage to the city of Sydney, where I was happy to hear that the British Surveying Ship “Herald” had arrived from New Caledonia, during our absence.

2nd. The average temperature of the air, during the day, in this part, is 75°, that of the water 70°. The wind usually from the northward.

3rd. To-day I went to the city, after attending to some business matters, took a walk about the town.

4th. This day I dredged, in company with Mr. Wright, in a little cove near the entrance of the harbor, where among the soft sponges of the bottom, I found a rich harvest, curious shrimps, naked mollusks, etc., and a beautiful planaria of the genus *Eolidiceros*.

5th. Through the kindness of our Commander in offering me the use of his boat, I visited the “Herald.” Her naturalist, Mr. MacGillivray, was not on board, but I was very kindly received by the two medical gentlemen connected with the vessel, who were both men of science. One of them<sup>1</sup> showed me a book containing a number of sketches, beautifully drawn, of some elaborate anatomical investigations on the lower animals, which he had made on board ship, having the benefit of a large room with plenty of light. I was shown several interesting specimens collected at New Caledonia and the neighboring islands, among which were several new land shells, and some well preserved specimens of the animal of *Nautilus pompilius*, which, it seems, is used as food by the natives of those islands. There were also many interesting minute shells of the new order *Crucibranchiata*, species of which they had taken abundantly in these seas. They used but little alcohol in their preservation of fishes, etc., almost all their specimens being dried.

---

<sup>1</sup> Probably Dr. John Denis Macdonald.—[C.H.]

I was surprised to find that their Government furnished them no zoological library.

I was ashore to-day for the last time, as the ship is now ready for sea. Her draft is 16 feet aft and 15·5 feet forward.

6th. To-day officers of the "Herald," including the two surgeons I have mentioned, and afterward Mr. MacGillivray, visited our ship. With the latter gentlemen I had a long and exceedingly interesting conversation. I find the lower marine animals of these seas have been little investigated, with the exception of Huxley's examinations of the Hydroid Polypi, and Mr. M. advises me to publish many species which I have found in this harbor, as nothing has as yet been done in this field. Mr. M. is, besides his zoological duties, engaged in obtaining vocabularies of the language of the different islands he visits, and also is preparing an account of the voyage for publication.

7th. We are now under sailing orders, and remain on board, waiting for a fair wind.

8th, Sunday. At sunrise we got under way and proceeded down the harbor, but the wind failing, we anchored outside of the "Sow and Pigs." At noon, however, a stiff southerly breeze sprung up, and we got under way again at one o'clock and stood out of the harbor and on our course to the eastward at the rate of six knots per hour.

9th. S. Lat.  $33^{\circ} 14'$ . E. Lon.  $154^{\circ} 45'$ . Wind S.E. Av. 7 k.

10th. S. Lat.  $31^{\circ} 41'$ . E. Lon.  $158^{\circ} 15'$ . Wind S.E. Av. 6 k.

At noon we made Lord Howes Island, and spent the afternoon in passing it. It consisted of two very high, round-topped mountains, with almost perpendicular sides, with some low land extending from them to the northward. Ball's Pyramid, a high, needle-like rock, was seen to the southward of the island. Flying-fish begin to be seen in abundance, a very large species (10 inches or more) bright green on the back. A few petrels are flying about ahead of the ship, of the size of the Cape pigeon, and mode of

flight of the "whale-bird." They are of a dark grey color, except their white breasts and the inner part of the inferior surfaces of the wings. In the evening specimens of the curious crustacean *Leucifer*, two *Cleodoras* and a *Firola* were taken.

11th. S. Lat. 30° 1'. E. Lon. 159° 52'. Wind E. Av. 6 k.

In the evening I took multitudes of a pale pink *Zoea* and several *Monolepis*.

12th. S. Lat. 28° 22'. E. Lon. 160° 3'. Wind E. Av. 4 k.

The temperature of the air is now 76°, that of the water 78°. A *Phaeton* with a reddish bill, white body and tail, black feet, and with the tail nearly as long as the body, was seen flying over and around the ship to-day.

13th. S. Lat. 28° 8'. E. Lon. 160° 10'. Wind N.E. Av. 4 k.

We have been passing over the positions of and looking for the reported Middleton Island and Shoal, but can find nothing of them.

14th. S. Lat. 26° 41'. E. Lon. 159° 37'. Wind E. Av. 5 k.

Looking out for reefs. We caught a large *Carcharias* (V-95), of which I made a drawing by measurements. A small turtle, about 8 inches in length was seen floating, apparently prevented from diving (to effect which it made violent efforts) by the crowds of *Anatifæ* which adhered to it.

15th. Sunday. S. Lat. 24° 44'. E. Lon. 159° 51'. Wind N.E. Av. 6 k.

In the evening the first booby was seen which had occurred on the voyage. At midnight we were suddenly found to be in shallow water. The ship was immediately got round, but the sounding line gave as low as 15 fathoms before we got clear of the shoal."

---

ON THE NATURE OF THE DEPOSIT OBTAINED FROM MILK  
BY SPINNING IN A CENTRIFUGE.

(*Preliminary Communication.*)

By H. S. HALCRO WARDLAW, B.Sc.,

Science Research Scholar of the University of Sydney.

(From the Physiological Laboratory of the University of Sydney.)

---

[*Read before the Royal Society of N. S. Wales, July 1, 1914.*]

---

WHEN milk is kept in a sterile condition for long periods of time (several years), a white deposit is observed to collect on the bottom of the containing vessel. Salkowski (1900) regards the deposit so obtained as precipitated caseinogen, while Langlois (1913) considers it to be tricalcium phosphate. Preti (1907) has determined the ash, calcium, and phosphorus of the deposit obtained in this way, and found 32.11% ash, 10.7% calcium, 4.33% phosphorus, and on the basis of these results regards the deposit as a mixture of tricalcium phosphate and a calcium compound of caseinogen. Neither Salkowski nor Preti came to a conclusion as to whether the appearance of this deposit was due to purely physical phenomena, whether it was due simply to the action of gravity on suspended matter in milk, or whether it was due to traces of rennin, or to the occurrence of slow chemical changes.

When milk is spun in a centrifuge, Barthel (1910) observed that a deposit similar to the above is obtained in the centrifuge tubes; he considers the deposit to be a mixture of calcium phosphate and caseinogen. In this case, as the time required to obtain the deposit is quite short, the action of traces of rennin or of slow chemical changes is practi-

cally excluded, and the deposition must be due entirely to the action of centrifugal force on suspended matter in the milk. Indeed, I have observed that, if the spinning be continued long enough, part of the milk may be almost freed from suspended matter, and a zone of clear greenish-yellow milk plasma makes its appearance below the layer of fat on the surface. See also Lachs and Friedenthal (1911).

Filtration of milk through porcelain also separates the suspended matter from it, the porcelain allowing through only a clear filtrate. A doubt exists, however, as to whether a purely physical separation is effected in this way (Raudnitz, 1903). Porcelain has been shown by Hermann (1881) to possess the power of precipitating caseinogen from milk, and almost as clear a filtrate is obtained by stirring milk with powdered porcelain and then filtering as by forcing it through the pores of a Chamberland filter-candle.

In spinning milk in the centrifuge, on the other hand we have a purely physical means of separating some of the suspended matter from it, a means which will only separate substances which already exist in suspension in the milk. Very few data with regard to the character and mode of deposition of the substance obtained from milk in this way appear to be available, although a study of this substance is likely to give some definite information as to the physical state and chemical composition of the compounds existing in suspension in milk. Alson (1908) isolated what he considered to be a new protein from this deposit.

The present communication is an account of the preliminary examination of the deposit obtained from milk by spinning it in a centrifuge. The following points have been dealt with:—

1. Effect of removal of the deposit on the superfluid.
2. Rate of deposition.
3. Ash of the deposit; its variation with the time of spinning.
4. Amount of calcium and phosphorus in the ash of the deposit.
5. Amount of nitrogenous and non-nitrogenous organic matter in the deposit.
6. Solubility of the deposit in water.

**1. Effect of removal of the deposit on the superfluid.**

Moore and Roaf (1908) have obtained results which indicate that electrolytes in solution may become associated with a colloid present in such a way that, although their effect on the freezing point of the solution is not altered, their conductivity is very considerably reduced, and they are withdrawn from the solution when the colloid is removed. It was thought, therefore, that some such effect might be observable in the present case, and that the removal of suspended colloidal substance from the milk might also mean the removal of some dissolved matter. A series of determinations of the freezing point was therefore made on milks before and after the removal of different amounts of suspended matter. These determinations of the freezing point were made in a glass vessel without an air mantle. The tube containing the liquid to be frozen dipped directly into a cooling bath of ice and salt at a temperature of  $-2^{\circ}$  to  $-3^{\circ}$  C. (not lower), both the bath and the liquid to be frozen being kept thoroughly stirred. In this way a determination of the freezing point could be made in less than ten minutes and the agreement between separate determinations on the same liquid was satisfactory, as the following figures show:—



*Freezing points of water and of milk.*

Liquid.	Experiment.	Freezing Point.	Supercooling.	Bath temp.
Water	1	2.700	1.2	- 2.5° C.
	2	2.700	1.1	2.5
	3	2.701	0.5	2.5
Milk	1	3.252	2.0	- 3.0
	2	3.251	2.0	3.0
	3	3.251	2.0	3.0

The absence of the air-jacket thus does not affect the precision with which the freezing point can be determined.

The following are the results obtained on milks from which different amounts of suspended matter had been removed :—

Table I.

*Effect of removal of suspended matter on freezing point of milk.*

Milk.	Weight of Deposit.	Freezing Point.	Zero.	Depression.	Acidity.
31	...	3.211	2.669	0.542	...
	0.0545 gm.	3.212		0.543	
	0.0936 "	3.216		0.547	
	0.1138 "	3.220		0.551	
32	...	3.224	2.669	0.555	19.6
	0.0544 "	3.226		0.557	
	0.0830 "	3.266		0.557	
33	...	3.221	2.669	0.552	19.4
	0.0224 "	3.222		0.553	
	0.0487 "	3.219		0.550	
	0.0940 "	3.222		0.553	
	0.1030 "	3.227		0.558	
34	...	3.251	2.700	0.551	19.2
	0.0688 "	3.241		0.541	
	0.0598 "	3.249		0.549	
	0.0766 "	3.247		0.547	
	0.1016 "	3.250		0.550	

From these figures it will be seen that there is no definite diminution in the depression of the freezing point after the removal of various amounts of suspended matter from milk, indeed there seems to be a tendency for the depression of the freezing point to increase eventually. Any effect due to the removal of adsorbed electrolytes in the deposit is therefore within the experimental error in the present case.

It was thought that the tendency for the depression of the freezing point to increase might be due to an increase in the number of particles present in solution brought about by the souring of the milk, by the breaking down of lactose into lactic acid. The splitting of lactose takes place in two main stages, (1) it is hydrolysed by lactase into glucose and galactose, (2) the hexoses thus formed are converted into lactic acid. Each molecule of hexose gives rise to two molecules of lactic acid, so that in all four molecules of lactic acid may be derived from one molecule of lactose. These reactions are represented by the following empirical equations:—

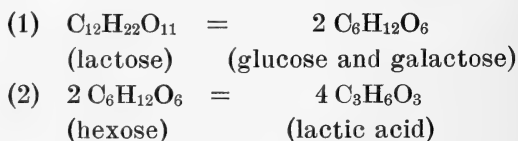

Milk is approximately a 5% or 0.15 N solution of lactose. If the increase of the acidity of milk during souring be due to the formation of lactic acid, then each extra cubic centimetre of N/10 alkali required to neutralise 100 cc. of milk after the onset of souring will correspond to the splitting up of  $0.0001 \times 100 / (0.015 \times 4) = 0.17\%$  of the lactose present. The value of the depression of the freezing point for milk ( $-0.55^\circ \text{C}$ .) shows it to contain a number of dissolved particles equal to that in a 0.3 N solution. We have just seen, however, that milk is a 0.15 N solution of

lactose, the value of the depression of the freezing point for the concentration of lactose in milk is therefore  $-0.225^{\circ}$ . When 0.17% of the lactose in milk breaks up into lactic acid the number of particles in solution is increased by three times that amount (neglecting the ionisation of the lactic acid) since for each molecule of lactose which disappears, four molecules of lactic acid are formed. The breaking up of this fraction of the lactose should therefore cause an increase of the depression of the freezing point due to this substance of 0.51%, that is, from  $0.225^{\circ}$  to  $-0.2263^{\circ}$ . Each additional cc. of N/10 alkali required to neutralise 100 cc. of milk undergoing souring should therefore correspond to an increase of the depression of the freezing point of  $0.0013^{\circ}$ . This value is a maximal figure, as in calculating it we have assumed that the whole of the lactose which breaks up forms lactic acid, actually, however, some of the lactose breaks up in other ways.

The acidities of samples of the milks being spun in the centrifuge were therefore determined at the beginning and at the end of the spinning to ascertain whether the tendency of the depression of the freezing point to increase might be attributed to an increase of the acidity of the milk. The samples for the determination of the acidity were kept under the same conditions as those being spun in the centrifuge. The acidities were determined by titrating 25 cc. of the undiluted milk, containing 2 cc. of 0.5% phenolphthalein as indicator, with N/10 NaOH to the first distinct pink colouration. The acidities shown in the table are expressed as the number of cc. of N/10 alkali required to neutralise 100 cc. of milk. The greatest increase of acidity occurring during the course of the spinning is seen to be 1 cc. of N/10 alkali in 100 cc. of milk, and as this corresponds to an increase of only  $0.0013^{\circ}$  in the lowering of the freezing point it may be said that the alteration

of the freezing point of the milk due to the splitting up of lactose is negligible in the present case.

The effect of the removal of different amounts of suspended matter from milk by spinning in the centrifuge on the acidity of the liquid remaining has also been determined.

Table II.

*Effect of removal of varying amounts of suspended matter on the acidity of the remaining milk.*

Milk.	Time Spun.	Acidity.
44	...	17·6
	1 hour	16·95
	2 "	17·25
	3 "	16·95
45	...	18·4
	1 hour	17·45
	2 "	17·9
	3 "	18·1

The amount of substance removed from the milk by spinning for periods up to three hours (about 0·1 gm.) has therefore very little effect on the acidity of the milk. The amount of substance removed from the milk in this time is about 1/14 of the solids not fat of milk. Removal of the whole of the suspended matter of milk by filtration through porcelain has been shown by Professor Chapman (1908) to reduce the acidity of milk to one-third of its original value.

## 2. Rate of Deposition.

The milk was spun in the present experiments at 2000 revolutions per minute in flat-bottomed cylindrical glass tubes 14 cm. deep and containing 100 cc. The distance of the bottom of the centrifuge tubes from the axis of the centrifuge was 22 cm. The deposit forms a fairly coherent layer on the bottom of the vessel, from which the superfluid can be poured off without disturbing the deposit. The weight of a deposit was determined by transferring it to a

porcelain dish with water, evaporating to dryness over a water bath, and drying to minimal weight in an air oven at 100° C. It was not found possible to get the deposits to constant weight, as the weight after decreasing for a time then began to increase. The heating was therefore continued until this increase of weight began, the minimal weight being taken as the weight of the dry deposit. Even at the temperature of the water bath these deposits became quite brown. The following table shows the weights of deposit obtained after spinning the milk for various periods and the rate of accumulation of the deposit over these periods. The rate of deposition is expressed in milligrams per minute per 100 cc. of milk.

Table III.—*Rate of Accumulation etc. of Deposit from Milk.*

Milk.	Volume.	Time Spun.	Weight of Deposit.	Increment.	Rate of Deposition.
19	400 cc.	30 min.	0.2568 gm.	...	2.140
		120 "	0.6975 "	0.4407 gm.	1.224
		180 "	1.0125 "	0.3150 "	1.321
		210 "	1.1900 "	0.1775 "	1.521
22	400 cc.	60 min.	0.2700 gm.	...	1.125
		135 "	0.5208 "	0.2508 gm.	0.838
		195 "	0.7259 "	0.2051 "	0.854
		225 "	0.9015 "	0.1756 "	1.462
23	400 cc.	60 min.	0.2933 gm.	...	1.222
		150 "	0.5787 "	0.2854 gm.	0.792
		210 "	0.7942 "	0.2155 "	0.898
		270 "	1.0162 "	0.2670 "	1.026
24	300 cc.	60 min.	0.2642 gm.	...	1.468
		120 "	0.4264 "	0.1604 gm.	0.892
		180 "	0.5791 "	0.1555 "	0.859
		240 "	0.7432 "	0.1632 "	0.907

This table shows that there are considerable variations in the rates at which the deposits fall in different milks. Other factors being equal, this points to a difference in the size of the suspended particles in different milks. It will

also be seen that the first portion of the deposit comes down at a rate a good deal greater than that of the succeeding portion. The rate of deposition decreases to a minimum and then begins to rise again during the course of about four hours' spinning. In one case the final rate of deposition was even greater than the first rate of deposition, but as a rule the rate of deposition, after passing through the minimum, did not rise as high as the first rate in the time for which the spinning was continued; it might do so if the spinning were continued longer. There is a variation in the ash-content of the deposit in the opposite direction to the variation in the rate of deposition (see below).

### 3. Ash-content of the Deposit.

The ash of the deposits obtained from milk as described above varies somewhat from one milk to another. The ashing was performed in a muffle furnace; the rear only of the muffle was heated, the porcelain dish containing the deposits being gradually moved from the mouth of the muffle to the hotter parts. As the deposit formed a thin layer on the bottom of the dish, the ashing was very rapid and complete. The following table gives the ash-contents of a series of these deposits.

Table IV.—*Ash-content of Centrifuge-deposit from Milk.*

Milk.	Weight of Deposit.	Weight of Ash.	Percentage of Ash.
4	0.4457 gm.	0.0310 gm.	6.94
6	1.4041 „	0.1001 „	7.13
9	0.6275 „	0.0618 „	9.85
10	0.5304 „	0.0431 „	8.12
12	1.5251 „	0.1157 „	7.89
13	1.0551 „	0.0913 „	8.65
15	0.5594 „	0.0452 „	8.09
17	0.6052 „	0.0503 „	8.32
22	0.3433 „	0.0297 „	8.65
35	0.2070 „	0.0180 „	8.70
37	0.1084 „	0.0107 „	9.87
38	0.1286 „	0.0122 „	9.48
39	0.1339 „	0.0120 „	8.97
41	0.3634 „	0.0247 „	6.80
42	0.2725 „	0.0192 „	7.04

It will be seen from the preceding table that there is considerable variation in the ash-content of these deposits. The extreme values for the percentage of ash in the deposits being 6·80% and 9·87%. As will be seen below this variation is to be attributed in part to differences in the times for which the milks were spun to obtain the deposits.

*Variation of ash-content of deposits with time of spinning.*—Not only are there differences between the ash-contents of the deposits from different milks, but deposits from the same milk show different percentages of ash according to the time for which the milk is spun before collecting the deposit. Samples of deposit after various periods of spinning were got by stopping the centrifuge at the appropriate times, pouring the superfluid off the deposit into a clean tube, and putting this on to spin again to obtain the deposit corresponding to that coming down at the later period. The following table shows the variation of the percentage of ash of the deposit with the length of time for which the milk is spun.

Table V—*Variation of percentage of ash of deposit with time of spinning.*

Milk.	Period.	Wt. of Deposit.	Weight of Ash.	Percentage Ash.
19	30 min.	0·2568 gm.	0·0177 gm.	6·89
	120 "	0·4407 "	0·0349 "	7·92
	180 "	0·3150 "	0·0230 "	7·30
	210 "	0·1775 "	0·0108 "	6·08
22	60 "	0·2700 "	0·0231 "	6·24
	135 "	0·2508 "	0·0203 "	8·09
	195 "	0·2051 "	0·0153 "	7·46
	225 "	0·1756 "	0·0115 "	6·55
23	60 "	0·2933 "	0·0250 "	6·36
	150 "	0·2854 "	0·0200 "	7·71
	195 "	0·2051 "	0·0183 "	8·49
	270 "	0·2670 "	0·0227 "	8·50
24	60 "	0·2642 "	0·0220 "	8·32
	120 "	0·1604 "	0·0137 "	8·54
	180 "	0·1545 "	0·0117 "	7·57
	210 "	0·1632 "	0·0130 "	7·97

From this table we see that the ash-content of the first portion of the deposit is always lower than that of the following portion. The ash-content then tends to decrease again, although in one case there is a continuous increase. We may therefore say that the ash-content of the deposit varies roughly inversely as its rate of deposition. The accompanying curves have been plotted from the means of the results shown in Tables III and V. Curve A has been obtained by plotting time as abscissa and rate of deposition as ordinate. In curve B time is the abscissa and percentage of ash of the deposit the ordinate. The curves show clearly the inverse relationship between ash and rate of deposition.

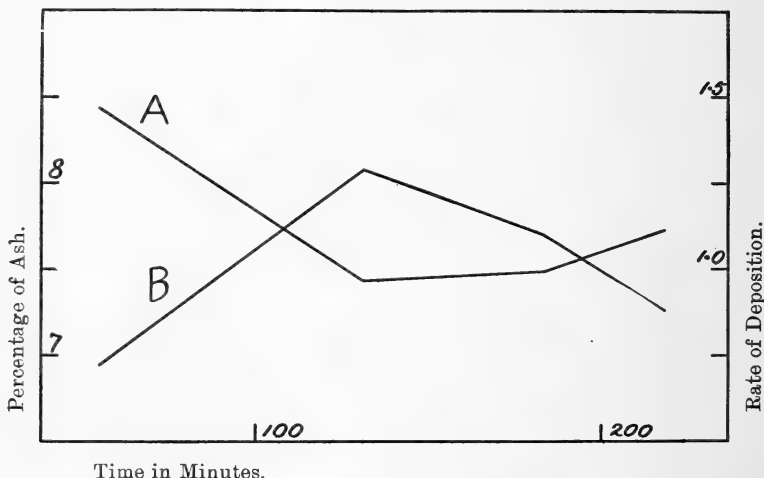

Curves showing variation with Time of Spinning, (A) of Rate of Deposition, in mg. per minute per 100 cc. of milk, (B) of Percentage of Ash in Deposit.

The general form of the curves seems to point to the existence in milk of at least three different substances in suspension: (1) A substance of lower ash-content which comes down first. (2) A substance of higher ash-content which comes down second. (3) A substance of lower ash-content again which comes down third. There are slight



indications that there may be another substance of higher ash-content yet which comes down after this. The data are as yet, however, not sufficient to admit of any definite inference being drawn from them.

#### 4. Amount of Calcium and Phosphorus in the Deposit.

*Methods of Analysis.*—The dried deposits were ashed in a muffle as described, the ash was dissolved in dilute hydrochloric acid, and the CaO was estimated in this solution. The  $P_2O_5$  was estimated in the filtrate and washings from the CaO estimation. The method used for the estimation of calcium was that developed by McCrudden (1911) for dealing with organic ashes, in which calcium, magnesium, iron, and phosphorus are present together. In the case of a small quantity of calcium such as we are dealing with here, the procedure is as follows:—The acid solution of the ash is diluted to 100 cc., made just alkaline with ammonia (a precipitate of calcium phosphate forms), then made just acid again with hydrochloric acid (the precipitate redissolves), and ten drops more of concentrated hydrochloric acid are added. Ten cc. of a 2.5% solution of oxalic acid are then added, and finally 8 cc. of a 20% solution of sodium acetate. The solution is either allowed to stand over night before filtering, or shaken vigorously in a stoppered vessel for ten minutes. The precipitate is then washed free from chloride in the usual way, and ignited to CaO, in which form it is weighed. In the present case the precipitates were ignited by placing them with the filters while still wet in the crucibles and introducing directly into a glowing muffle. The water in the crucible almost at once assumes the spheroidal condition, and the drying and ignition proceed quietly; there is no spluttering nor danger of breaking the porcelain crucible.

$P_2O_5$  was determined in the filtrate and washings from the above estimation. These were made just alkaline with

ammonia, and 2–4 cc. of magnesia mixture were added drop by drop, with constant stirring. After about half an hour one-third the volume of the solution of strong ammonia was added and the solution allowed to stand over night. The precipitate was washed free from chlorides with 1 : 3 ammonia in the usual way and ignited moist as described above, to  $\text{Mg}_2\text{P}_2\text{O}_7$ , in which form it was weighed. The ignited precipitates obtained in this way are often not white, but grey. The following estimations on a standard phosphate solution show, however, that the accuracy of the determination is not impaired by this. The standard solution of phosphate contained 3.3 gm. of microcosmic salt per litre and was standardised by evaporating a known volume to dryness, igniting, and weighing the sodium metaphosphate formed.

Volume of Solution.	Weight of $\text{NaPO}_3$	Weight of $\text{Mg}_2\text{P}_2\text{O}_7$	Weight of $\text{P}_2\text{O}_5$	Weight of $\text{P}_2\text{O}_5$ in 20 cc.
40 cc.	0.0349 gm.	...	0.0484 gm.	0.02420 gm.
40 „	0.0351 „	...	0.0487 „	0.02435 „
30 „		0.0574 gm.	0.0366 „	0.02436 „
30 „		0.0571 „	0.0364 „	0.02426 „
30 „		0.0576 „	0.0367 „	0.02440 „

The amounts of  $\text{P}_2\text{O}_5$  calculated from the weights of  $\text{Mg}_2\text{P}_2\text{O}_7$  thus agree closely with those obtained from the weights of  $\text{NaPO}_3$ .

The following table gives the percentages of ash,  $\text{CaO}$ , and  $\text{P}_2\text{O}_5$  found in a series of the deposits obtained by spinning milk in a centrifuge.

It will be seen that the deposits contain approximately equal weights of  $\text{P}_2\text{O}_5$  and of  $\text{CaO}$ . The average of the ratio  $\text{P}_2\text{O}_5/\text{CaO}$  is 1.01. The percentages of these substances found in the deposits vary from 3.2% to 4.7%. This variation is parallel to the variation in the ash content of the deposit, the ash itself having a fairly constant compo-

Table VI.

*Percentages of Ash, P<sub>2</sub>O<sub>5</sub>, and CaO in Deposits from Milk.*

Milk.	Weight of Deposit.	Weight of Ash.	Percent. of Ash.	Weight of P <sub>2</sub> O <sub>5</sub>	Weight of CaO	Percent. of P <sub>2</sub> O <sub>5</sub>	Percent. of CaO
4	0.4457	0.0310	6.94	0.0142	...	3.185	...
6	1.4041	0.1001	7.13	0.0423	0.0444	3.01	3.16
9	0.6275	0.0618	9.85	0.0286	0.0294	4.56	4.68
10	0.5305	0.0431	8.12	0.0192	0.0194	3.61	3.68
12	1.5251	0.1157	7.59	0.0549	...	3.34	...
13	1.0551	0.0913	8.65	0.0391	...	3.70	...
15	0.5594	0.0452	8.09	0.0202	...	3.61	...
22	0.9015	0.0702	7.68	0.0288	0.0274	3.21	3.04
23	1.0162	0.0880	8.29	0.0383	0.0349	3.61	3.29

sition as is shown by the following figures giving the percentages of P<sub>2</sub>O<sub>5</sub> and CaO calculated on the weight of ash instead of on the weight of the whole deposit.

Table VII.

*Percentages of P<sub>2</sub>O<sub>5</sub> and CaO in Ashes of Deposits.*

Milk.	Percent. P <sub>2</sub> O <sub>5</sub>	Percent. CaO	P <sub>2</sub> O <sub>5</sub> /CaO
4	45.8	...	...
6	42.3	4.44	0.952
9	46.3	4.76	0.952
10	44.6	4.50	0.991
12	44.0	...	...
13	42.8	...	...
15	44.7	...	...
22	41.1	39.0	1.05
23	43.5	39.7	1.10

The average percentage of P<sub>2</sub>O<sub>5</sub> in the ash of the deposit is thus 43.9 and the average percentage of CaO is 43.1.

As the above figures for CaO and P<sub>2</sub>O<sub>5</sub> were obtained from the ash of the deposit, there is a possibility that the values for P<sub>2</sub>O<sub>5</sub> may be low owing to the tendency of the phosphorus of organic compounds to volatilise during ignition. A comparison of the two following estimations shows, however, that the loss of phosphorus in the present case is small. The first of these results was obtained on

the substance ashed in the muffle in the usual way; the second result was obtained after destroying the organic matter with concentrated nitric and sulphuric acids (Neumann's (1902) acid-ashing process.)

*Deposit from Milk 51.*

	Weight of Deposit.	Wt. of $Mg_2P_2O_7$	Percent. of $P_2O_5$
Dry ash ...	0.2527 gm.	0.0146 gm.	3.68
Acid "ash" ...	0.1970 ,,	0.0121 ,,	3.91

These figures show a loss of phosphorus of about 6% during the ignition. This value is not much greater than the experimental error on the estimation of such small quantities of phosphorus as had to be dealt with in these cases.

**5. Amount of Nitrogenous and Non-nitrogenous Organic Matter in the Deposit.**

The ash-content of the deposit obtained from milk by spinning it in a centrifuge shows that there is present about 92% of material which disappears on ignition. The amounts of nitrogen in a series of these deposits have been determined by the method of Kjeldahl. The following are the results obtained:—

Table VIII.  
*Nitrogen-content of Deposit.*

Deposit.	Percentage of Nitrogen.
17	11.9
25	10.7
35	10.95
36	11.95
37	12.05

The average percentage of nitrogen in these deposits is therefore 11.5. This corresponds to a percentage of protein of 72.8 (taking the nitrogen-content of the protein as 15.8%). On being allowed to stand for a day or two in the moist state these deposits set to a firm clot and developed a "cheesy" smell. A flocculent precipitate was formed

when a little acetic acid was added to a suspension of the deposit in water. These facts indicate the presence of caseinogen or its compounds. Two direct estimations of caseinogen were carried out as follows:—The deposits were suspended in volumes of water equal to the volumes of milk from which they were obtained, and the caseinogen was precipitated by the addition of one drop of 33% acetic acid to each 10 cc. of the suspension. The precipitates obtained were separated from the superfluid in the centrifuge, and washed three times with a solution of acetic acid (1 drop of 33% acetic acid to 10 cc. of water). The precipitates were then collected on tared filters dried to constant weight in a glycerine oven at 103°, and weighed. The following are the results obtained:—

*Percentage of Caseinogen in Deposit.*

Deposit.	Weight of Deposit.	Weight of Caseinogen.	Percentage of Caseinogen.
46	0·0779 gm.	0·0441 gm.	56·6
48	0·0916 „	0·0531 „	57·9

The greater part of the nitrogenous material of the deposit therefore consists of caseinogen. The precipitates of caseinogen were found to contain 2% of ash.

On subtracting the mean of these two percentages from the total percentage of protein in the deposit, as calculated from the total nitrogen-content it is seen that there is present in the deposit about 16% of protein not caseinogen. This nitrogenous matter is possibly derived from the general cellular débris from the epithelia of the different parts of the mammary gland of the cow. Such material is always obtained in the deposit formed when milk is allowed to stand, even in the milk from perfectly healthy cows (Ernst, 1913). A microscopic examination of the deposits obtained from milk in the present case showed

that the portions coming down first were very rich in cellular material, consisting for the greater part of cells resembling leucocytes but derived from the epithelium of the mammary gland (Hewlett, Villar and Revis, 1909; Ernst, 1913).

Subtraction of the total protein of the deposit from the total organic material shows the presence of 19% of non-nitrogenous organic matter. The clear superfluid from the caseinogen precipitation showed a powerful reducing action towards Fehling's solution, indicating the presence of a reducing body (lactose?). The percentage of lactose in the deposit was estimated by Pavy's method, caseinogen being first removed by precipitation with acetic acid, and the solution being boiled. In this way 16% of lactose was found to be present in the deposit. The Pavy's solution was standardised against a standard solution of Merck's lactose ( $C_{12}H_{22}O_{11} + H_2O$ ) of approximately the same reducing power as the solution of the deposit.

Fat was tested for by allowing the deposit to stand under petroleum spirit for twenty-four hours, then pouring off the petroleum spirit and evaporating to dryness in a weighed vessel. No residue was left after volatilisation of the spirit. Fat is therefore apparently not present in the deposit in weighable amount. The microscopic examination of the deposit showed the presence of a certain number of granules which stained with osmic acid and Sudan III.

#### 6. Solubility of the Deposit in Water.

When the deposit obtained from milk by spinning it in a centrifuge is shaken up in a volume of water equal to that of the milk from which it was removed, a considerable portion of it goes into solution. The following table gives the amounts of the total deposit and of the potential ash which may be dissolved in this way.

Table IX.  
*Solubility of Deposit and of Potential Ash in Water.*

Milk.	Total Deposit.	Total Ash.	Soluble Deposit.	Ash of Sol. Dep.	Percent. of soluble Deposit	Pot. Ash
29	0·3443 gm.	0·0297 gm.	0·1019 gm.	0·0268 gm.	34·7	90·3
36	0·2070 "	0·0180 "	0·0985 "	0·0095 "	47·5	52·8
37	0·1084 "	0·0107 "	0·0697 "	0·0087 "	64·2	88·8
38	0·1286 "	0·0122 "	0·0318 "	0·0087 "	24·7	71·3
39	0·1339 "	0·0120 "	0·0936 "	0·0111 "	69·9	92·4

By the term "potential ash" is meant that portion of the deposit which after ignition forms the actual ash. The term is used to avoid speaking of the inorganic matter of the deposit, as it is uncertain what portion of the substances which go to form the ash is originally in an organic form of combination; part of the phosphorus and calcium for example, is probably present in the deposit in an organic compound (calcium caseinogenate).

The amount of the total deposit which goes into solution is seen to be very variable, ranging from 24·7 to 69·9%. The fraction of the potential ash which dissolves is greater still and varies from 52·8 to 92·4%. The solubility of the potential ash of the deposit is in marked contrast to that of the actual ash.

In the case of milk 29 the following figures were obtained:

Total Ash.	Soluble Potential Ash.	Soluble Actual Ash.
0·0297	0·0268 (90·3%)	0·0055 (18·5%)

The nature of the combinations of the elements which go to form the ash is therefore completely changed by ignition. The fact that part of this deposit from milk is soluble in water is interesting as it shows that in addition to the presence in milk of substances or conditions which keep insoluble materials in a state of fine suspension and prevent their precipitation, there are also present substances or conditions which keep soluble matter in a similar state.

**Summary.**

1. The removal of suspended matter from milk by spinning in a centrifuge does not lower the freezing point of the milk.
2. The rate of deposition of the suspended matter of milk in a centrifuge is not constant, first decreasing, then increasing.
3. The amount of ash in the deposit shows a variation in the opposite direction to that of the rate of deposition, first increasing then decreasing; the average ash-content of the deposit is 8%.
4. The percentages of calcium and of phosphorus in the ash of the deposit are not subject to much variation; the average values are, CaO 43·1%, P<sub>2</sub>O<sub>5</sub> 43·9%.
5. The nitrogen content of the deposit is also fairly constant; its average value is 11·5% (corresponding to 73% of protein).
6. The deposit contains about 57% of caseinogen.
7. No fat is present in the deposit.
8. The deposit contains about 19% of non-nitrogenous organic matter (16% lactose?).
9. The average composition of the deposit is thus: ash, 8%; caseinogen, 57%; other protein, 16%; lactose, 16%; other non-nitrogenous organic matter, 3%.
10. A considerable portion (25–70%) of the deposit is soluble in water. The soluble portion contains the bulk (up to 90%) of the ash of the deposit.

In conclusion I wish to express my indebtedness to Professor Sir T. Anderson Stuart, in whose laboratory this work was done, and to thank Assistant-Professor Chapman for his advice and encouragement during the course of the work.



## REFERENCES.

- ALSON, J. *Biol. Chem.*, 5, 261, 1898.
- BARTHEL, *Methods used in the Examination of Milk and Dairy Products* (translated by Goodwin), p. 13. Macmillan, London 1910.
- CHAPMAN, *Proc. Linn. Soc. N.S.W.*, 33, 436, 1908.
- ERNST, *Milchhygiene für Tierärzte*, p. 27 ff. Ferdinand Enke, Stuttgart, 1913.
- HERMANN, *Arch. f. die ges. Physiol.*, 26, 442, 1881.
- HEWLETT, VILLAR and REVIS, *J. of Hygiene*, 9, 271, 1909.
- LACHS and FRIEDENTHAL, *Biochem. Zeitschr.*, 32, 134, 1911.
- LANGLOIS, *Richet's Dictionnaire de Physiologie*, Art. "Lait" 1913.
- MCCRUDDEN, *J. biol. Chem.*, 10, 187, 1911-12.
- MOORE and ROAF, *Biochem. J.*, 3, 55, 1908.
- NEUMANN, *Zeitschr. f. physiol. Chem.*, 37, 115, 1902.
- PRETI, *Zeitschr. f. physiol. Chem.*, 53, 419, 1902.
- RAUDNITZ, *Ergeb. d. Physiol.*, 2 (1), 307, 1903.
- SALKOWSKI, *Zeitschr. f. physiol. Chem.*, 31, 329, 1900.
-

## THE GEOLOGY OF THE COOMA DISTRICT, N.S.W.

## PART I.

By W. R. BROWNE, B.Sc.,

Assistant Lecturer and Demonstrator in Geology in the University  
of Sydney.

---

[*Read before the Royal Society of N. S. Wales, July 1, 1914.*]

---

I. Introductory.

II. Stratigraphical and Descriptive.

Summary,

(a) The Metamorphic Series:—Schists and phyllites. Igneous gneisses—mottled, Cooma, blue, white and pink gneisses. Amphibolite. Pegmatites and quartz veins.

(b) Ordovician.

(c) Silurian.

(d) Post-Silurian but Pre-Tertiary:—Quartz-porphyrines. Berridale granite. Myalla Road Syenite.  
Geological age of the igneous intrusions.

(e) Tertiary and Recent:—Olivine Basalt. Diatomaceous earth. Travertine. River Gravels. Aeolian deposits.

III. Economic Geology:—Bushy Hill mines. Tripolite. Limestone. Barytes.

IV. Age of the Metamorphic Series.

V. Geological History up to Tertiary times.

VI. Physiography:—Present topography. Süssmilch's interpretation. Details of development of the river system. Age of the basalts. Origin of the lakes.

### I. Introductory.

Comparatively little has been written, and no detailed work has hitherto been done, so far as I am aware, in connection with the geology of the extremely interesting region round Cooma.

Rev. W. B. Clarke, in his "Southern Goldfields" (Chap. VII, and elsewhere) makes reference to the schists and gneisses, the olivine basalt, the chialstolite slates of Geygderick Hill, and the Berridale granite.

Professor David<sup>1</sup> makes passing mention of the metamorphic rocks, pointing out their lithological similarity to those of Mitta Mitta in Victoria, and to the Pre-Cambrian series along the eastern slopes of the Mount Lofty and Flinders Ranges in South Australia. He suggests that on these grounds the Cooma metamorphic series may be provisionally referred to the Pre-Cambrian.

The physiography of the region has been dealt with in papers by Süssmilch<sup>2</sup> and Griffith Taylor.<sup>3</sup> Other references will be given in the text.

The present paper is the outcome of a visit paid to Cooma in February 1912, at the suggestion of Professor Woolnough, for the primary purpose of examining the pegmatite veins occurring in the gneiss. My attention was attracted by the extent and variety of the metamorphic rocks in the neighbourhood, and a few excursions into the surrounding country suggested in addition some stratigraphical problems of interest.

The town of Cooma is on a branch of the Great Southern Railway Line, 266 miles from Sydney, and 130 miles south

---

<sup>1</sup> Proc. Linn. Soc. N.S.W., Vol. xxxiii, 1908, p. 658.

<sup>2</sup> Notes on the Physiography of the Southern Tableland of N.S.W. This Journal, Vol. xliii, 1909, p. 331.

<sup>3</sup> The Physiography of the Proposed Federal Territory at Canberra. Commonwealth Bureau of Meteorology, Bulletin No. 6, Dec. 1910.

from the junction at Goulburn. It is 60 miles from Mount Kosciusko and is at a height of 2,662 feet above sea-level.

## II. Stratigraphical and Descriptive.

SUMMARY.—The country dealt with in this paper comprises a roughly elliptical area extending from Cooma about 9 miles to the north, 6 miles to the east, and to the south and west 11 miles each: the greater part of this area has been studied in considerable detail. The rocks outcropping include, in addition to a metamorphic series whose age is uncertain, representatives of Ordovician, Silurian and (?) later Palæozoic, as well as of Tertiary and Recent times.

The metamorphic complex consists mainly of mica-schists and quartz-schists in great variety, phyllites and quartzites. These are intruded by a gneissic series. Three varieties of gneiss are recognised, differing in texture and general appearance, and quite distinct from each other. These will be known as the mottled gneiss, the Cooma gneiss, and the blue gneiss respectively. A pink and a white gneiss are probably genetically connected with the blue gneiss. Among the gneisses and schists is found an amphibolite intrusion of limited occurrence, with associated dykes and apophyses of fine-grained pyroxene-amphibole granulite and schist. A number of pegmatite dykes also intersect the metamorphic complex.

The Ordovician rocks consist of slates, gritty slates and quartzites, and one small patch of limestone, unfossiliferous.

In the Silurian are comprised a considerable belt of limestone, slates, gritty sandstones, and quartzite; these lie to the east of the Ordovician rocks. On some horizons there is an abundant fossil fauna. Here too may possibly be included some very highly shattered quartz-porphyrries which occur interbedded with the slates.

For reasons which will be mentioned later, a number of igneous intrusions are referred to the Devonian or Carboni-

ferous. These are the Berridale granite, the Myalla Road syenite, with accompanying dykes of bostonite, and lastly an extensive series of quartz-porphry intrusions.

Tertiary and recent rocks are represented by basalts which are extensively developed over the area, by deposits of diatomaceous earth, of chemically-formed limestone and of alluvial. Late Palæozoic and Mesozoic formations are entirely absent. The strike of the sedimentary and metamorphic series is approximately meridional, the mean of about fifty compass readings being  $347^{\circ}$ .

(a) THE METAMORPHIC SERIES.—The rocks constituting this series occupy a considerable area on all sides of Cooma excepting the east, as may be seen from the map: to the south-west of Cooma they disappear under basalt, so that their southerly extension cannot be accurately determined. Schists, occurring as inliers amid the basalt, have been found  $6\frac{1}{2}$  miles due south of Cooma, and it is quite possible that metamorphic rocks extend much farther south. On the north the series has not been traced farther than Pearman's Hill, 9 miles north of Cooma along the Sydney Road: there is every reason to believe, however, that they extend a great many miles beyond this.

*The Schists.*—In the centre parts of the complex the schists are well crystallized, but on the east and west they pass gradually into phyllites: this is most noticeable on the west, where there is, beginning from the western side of Dairyman's Plain, a gradual transition into the Slack's Creek phyllites: on the eastern side the phyllite belt is not nearly so broad, and it is interrupted in some places by intrusions of gneiss, and in other places concealed by basalt flows. It is to be noted that the schists have a much wider extent to the west than to the east of a meridional line through the main outcrops of the Cooma and the blue gneisses. The sedimentary origin of these schists is proved

by the presence of interbedded quartzites in the form both of lenticular patches a few yards long and a few inches wide, and of more continuous layers. The prevailing quartzose nature of the schists too would tend to indicate their derivation from arenaceous sediments. There is a notable proportion of what may be termed quartz-schist, containing predominant quartz, with a subordinate amount of mica: ordinary mica-schist, too, is plentiful, and a mica-schist with porphyroblasts of (?) cyanite has been found in a few places in close contact with the blue gneiss. A very well-defined variation of the schist is really a kind of very fine-grained gneiss, according to Van Hise's definition of the term.<sup>1</sup> In hand-specimen a fracture perpendicular to the schistosity shows alternate bands of light and dark minerals on a small scale. The dark micaceous layers are about .2 mm. thick, the more acid layers ranging between 1.5 and 2.5 mm. approximately. These rocks seem to be similar in origin to the other schists, with which they are intimately associated, and from which they cannot be differentiated. In many places the schists are interleaved with Cooma gneiss which has been subjected to mechanical deformation: the minerals have been broken up and the grainsize considerably reduced; in such cases it is often impossible to differentiate between a relatively coarse-grained schist and the mechanically altered gneiss.

The planes of schistosity often show much bending and puckering; this is rendered very noticeable when, as frequently happens, little pegmatite veins have been injected along these planes. The numerous pegmatite and quartz veins which occur throughout the schist generally follow the planes of foliation, and quite commonly there have been regular *lit par lit* injections of pegmatite.

---

<sup>1</sup> A Treatise on Metamorphism, p. 782.

*Slack's Creek phyllites.*—Along the western side of Dairyman's Plain, as has been mentioned, the appearance of the schists changes; quartz no longer appears megascopically, the chief visible constituent being mica, and the rocks grade into shimmering micaceous phyllites. These may be named the Slack's Creek phyllites,<sup>1</sup> from their conspicuous development there. A traverse westward from Kiaora homestead exhibited well the variations of these rocks. Succeeding the crystalline schists, very shiny mica-phyllites predominate. These are finely corrugated and highly cleavable. Closely associated are rocks of generally similar character, but more coarsely corrugated, and roughened by knots of (?) incipient andalusite. These knotted phyllites are very frequent in bands of a few inches to a foot thick: the boundaries between them and the bands of plain and finely corrugated phyllite are very sharp, and two varieties can readily be obtained in the same hand specimen.

Interbedded with the phyllites (for the planes of schistosity have also been bedding-planes) are bands of a hard dense dark blue quartzite or quartzitic schist, often a couple of feet or more in width. These quartzites also occur as lenticular bands about 3 or 4 feet long and 4 or 5 inches thick.

The prevailing dip of the phyllites is easterly and varies considerably in amount, from a very high angle down to about 30°.

Just about where the Dry Plain road crosses Slack's Creek there can be seen a black micaceous slate interbedded with the phyllites. Further up the creek, about

---

<sup>1</sup> The term *phyllite* has been objected to in view of the plainly autogenic character of the rock, but the name has been considered necessary on account of the markedly micaceous character of the rock as compared with the schists.

1½ to 2 miles north of where it is crossed by the Adaminaby road, the micaceous slates predominate, having interbedded with them occasional bands of smooth and knotted phyllite, as well as quartzite and a whitish-grey gritty variety of slate.

The Slack's Creek phyllites, as well as the schists, are conspicuously traversed by vertical joints running at a bearing of 80°, or nearly perpendicular to the strike. This system of jointing is noticeable along Spring Creek, at the Wallaby Rocks, and in other places where the schists outcrop. The phyllites are seamed with quartz veins and reefs. In general these bear no fixed relation to the strike of the country, but some have evidently been injected along the planes of schistosity. In some of the veins the quartz is strongly grooved and scored.

To the east of the metamorphic complex the transition from schist to phyllite cannot be traced so clearly as on the western side, partly on account of the capping of Tertiary basalt concealing the outcrops, and partly on account of the pink and white gneisses at Bunyan being intruded just about where the transition band should be. The belt of phyllites is only about one-third as broad as the western belt. It can be seen at intervals along the Sydney Road between Cooma and Bunyan; in only a few cases could slight knotting be observed.

*Igneous gneisses.*—Under this head are treated those three occurrences of gneissic rocks whose igneous origin has been proved beyond doubt, mainly by the presence of inclusions of the sedimentary schists and by definite evidence of intrusion.

On the Murrumbidgee, between Mittagang Bridge and Wallaby Rocks, in the hilly country east of the Bridge, and along the Murrumbucca Road, representatives of all



three varieties of gneiss are seen to intrude the schists, fragments of which they frequently include.

The limits of these three formations, and particularly of the Cooma gneiss and the mottled gneiss, cannot be definitely laid down, owing to obscuration of their textural peculiarities by metamorphic and other influences, and also to the fact that a great deal of the gneiss has been intruded as tongues along the planes of schistosity of the invaded formations. The mapped-in occurrences, therefore, must not be taken to represent the total extent of these rocks.

*The mottled gneiss.*—The mottled gneiss is the oldest of the three: it is a very fine-grained rock, with a characteristic mottled appearance due to the alternation of patches of biotite in wavy bands with patches of the light-coloured constituents. This mottled gneiss has a fairly wide distribution throughout the metamorphic area, in relatively small patches as a rule. Mount Gladstone (Cooma Hill), about three miles to the S.W. of Cooma, is composed principally of this rock, which is also found intruding the schists in various places, principally to the west of the town. So much alteration of the schist has taken place, through metamorphism due to intrusion and the injection of countless little pegmatite veins, and so much change in the mottled gneiss from similar causes, that it is at times impossible to separate them. No doubt a certain amount of contamination of the igneous material has taken place during the process of injection: indeed this is proved by the fact that microscopically sillimanite is seen to be a constant constituent of the mottled gneiss.

The appearance of the gneiss in hand specimen would never suggest its igneous origin, its fine grain and mottled schistose appearance being characteristic rather of an altered sedimentary rock. Indeed for a good while I was inclined to class it as such, until the discovery of schistose

inclusions, and of the occurrence of the rock in tongues through the schist, indicated its intrusive character beyond a doubt.

*The Cooma gneiss.*—The Cooma gneiss comes second in point of age. The main mass of it, which outcrops in and around Cooma, is about 5 miles long, the greatest breadth being a little over  $2\frac{1}{2}$  miles, but this by no means represents the entire outcrop, for isolated patches occur about 5 miles south of Cooma, and nearly as far west as Kiaora homestead, in addition to several small outcrops north of the town. Besides those occurrences which are definitely recognizable as Cooma gneiss there are numerous outcrops of crystalline rock which have all the appearance of Cooma gneiss which has undergone extreme crushing, producing a reduction in the grainsize and a schistose foliation. These probably represent tongues or upward injections of the original rock into the schists, which in consequence of their narrowness have suffered more from mechanical deformation than other intrusions of greater breadth. Such outcrops are to be found at many places among the schists to the north and west of Cooma. Occasional remains of large crystals of feldspar or quartz, as well as lenticular inclusions of schist, point to the shattering of an original massive igneous rock. It seems probable, therefore, that the underground extent of the Cooma gneiss is much greater than might be determined from the main outcrop; in particular a considerable extension to the north and west of Cooma is indicated.

The original granite mass from which the gneiss is derived must have sent numerous apophyses into the surrounding rocks, and this is only to be expected, seeing that the invaded formations were probably already cleaved, and therefore possessed of planes of weakness, at the time of intrusion. These gneissic dyke-like intrusions are fairly

numerous, and a notable feature of their occurrence is that apart from the schistosity due to pressure their texture differs not from that of the main mass of the gneiss; in other words the original apophyses would appear to have been granitic, and not in the nature of quartz-porphry, as might reasonably have been expected. This may be explained by supposing that the apophyses are really but short offshoots from the parent mass, or slight upward projections from the roof of the magma-chamber, so slight that the conditions of their crystallization did not differ essentially from those of the main mass. (See fig. 1.)

Inclusions of the intruded schists are fairly common in the Cooma gneiss in certain places. Beyond Mittagang Bridge on the Murrum-

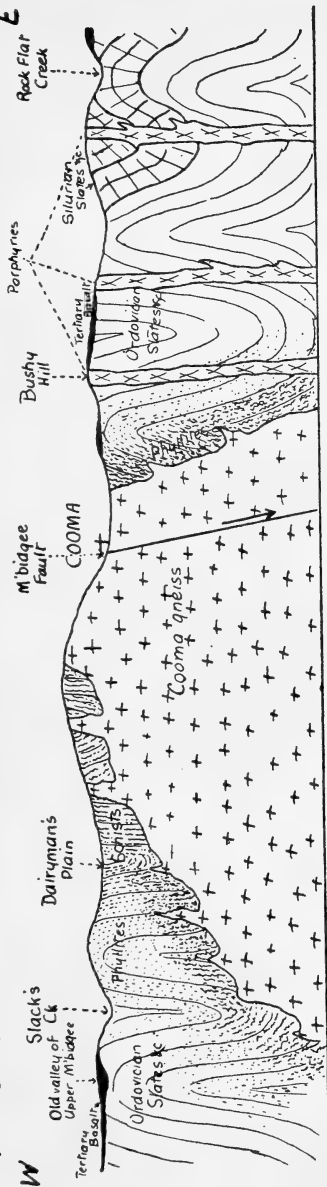

Fig. 1 — E. W. Sketch section through Cooma, showing suggested relations of gneiss, schist, phyllite and slate, and of the Ordovician and Silurian, etc.

bucca Road these are found of lenticular shape about three feet long, and with a maximum breadth of about four inches. They occasionally consist of a hard outer shell of an inch or one and a half inches thick, with a core of softer rotten schist. This may be a kind of case-hardening, due to the heat etc. of the eruptive rock. Partial digestion of the inclusions seems to have occurred, or their recrystallization, as exhibited in the cuttings just outside Cooma on the Berridale road.

In general appearance the Cooma gneiss is very variable. Typically it has quite a granitic fabric and massive structure, but at times it assumes a schistose appearance and develops a rude cleavage, particularly near its boundaries. Again, a typical gneissic structure may be exhibited, bands of light and dark minerals alternating, due in some cases to *lit par lit* injections of pegmatite, but often, I believe, to recrystallization at the time of metamorphism. Here and there are to be found dykes or bands of a more acid gneiss, consisting of quartz, felspar, and white mica, of the same general texture as the ordinary gneiss, but differing in the absence of black mica.

The normal gneiss itself consists, megascopically viewed, of quartz, felspar and biotite in varying proportions, generally with a subordinate amount of white mica. Locally the acidity of the rock may be increased, while again, especially along the borders of some large pegmatite vein, the biotite content increases very largely, giving the rock a very basic appearance. Preliminary microscopic examination shows the constant occurrence of topaz, and of little zircons with pleochroic haloes in the biotite.

The grain of the gneiss is as a rule very even, but felspars up to  $1\frac{1}{4}$  inches long and quartz grains up to 4 inches long occur, giving the rock in places a porphyritic appearance. These are evidently fragments which have resisted crush-

ing, and would indicate that the original granite was either very coarse grained or else porphyritic. That they are not products of recrystallization their sparing distribution would show.

*The blue gneiss.*—The extent of this, particularly to the north, has not been fully traced. The investigated outcrop occupies a fairly large area some distance to the west of the Sydney road between Bunyan and Pearman's Hill, and is well developed at the point where the Murrumbidgee, in emerging from its V-shaped gorge in the Berridale tableland, executes a sharp S-shaped bend. Like the Cooma gneiss, the blue gneiss sends out numerous tongues into the surrounding rocks, and inclusions are frequent, also what look like basic segregations.

For the most part the rock shows well-marked foliated gneissic structure, but as one goes westward across the outcrop between Governor's Hill and the Murrumbidgee, one notices that about  $\frac{1}{4}$  mile from the edge of the intrusion the rock loses its gneissic appearance and becomes granitic, resembling, in fact, a normal biotite granite. Here, too, it weathers into the great rounded tors characteristic of massive granite. At the southern end of the main intrusion there is a porphyritic and relatively acid facies, with pink, simply-twinned orthoclase phenocrysts measuring up to  $\frac{1}{2}$  inch by  $\frac{1}{4}$  inch. As has been mentioned, numerous dykes of blue gneiss are found, usually with the strike of the schists. A long dyke-intrusion can be traced along the Mittagang Road from the Cooma Creek bridge nearly as far as the waterworks distributing reservoir about a mile out of Cooma; further on the same dyke appears in a railway cutting, crosses the Sydney road, and eventually disappears under the basalt behind Cooma Railway Station. A probable continuation of this dyke northward would make its total length somewhere about 6 miles. The width

of the outcrop varies; in some places it is upwards of 100 yards, thinning considerably towards the southern end. The gneissic structure is very pronounced, and the basicity of the rock increases towards the south, megascopic free quartz disappearing and the layers of biotite giving the rock the characteristic bluish-black appearance from which the whole gneiss has been named.

*The white and pink gneisses.*—Along the Sydney Road there is a long band of acidic gneisses which has been traced from a point  $1\frac{1}{2}$  miles north of Tillabudgery Trig. Station as far as Pearman's Hill, a total distance of over  $5\frac{1}{2}$  miles, and which may extend farther north still. At Bunyan the outcrop is not less than 400 yards in width, and it forms a strong feature on the west of the Sydney road for some distance past the Cooma Creek bridge. Two varieties of gneiss are recognised. The white gneiss has in many places strongly marked gneissic foliation, the folia consisting of quartz and felspar alternately, with subordinate development of white mica in small flakes. Apparently of somewhat later origin, since it intrudes the white gneiss, is a pink rock strongly jointed, very compact and seen under the microscope to consist mainly of quartz, with very subordinate felspar, the whole stained with hæmatite, and possessing marked schistosity.

The affinities of these two gneisses it has been found impossible to determine with complete satisfaction. Not far past Cooma Creek bridge the white and blue gneisses were found in close association, and what looked like an intermediate type of gneiss, very similar to the blue gneiss, but with very subordinate mica, was also seen. On the whole it seems as if the white and the pink gneisses were genetically related to the blue gneiss as later acid differentiates from the same magma. A pink rock which intrudes the blue gneiss at Pearman's Hill may be a phase of the pink

gneiss. It is however devoid of gneissic banding, and has more of the appearance of a felspathic porphyry.

*Amphibolite*.—In the town of Cooma, 200 yards or so south of the R. C. Church, is an outcrop of amphibolite intrusive into the Cooma gneiss. The main outcrop is of rudely circular form, and about 50 yards in diameter. The rock consists largely of coarse amphibole crystals up to  $\frac{3}{8}$  of an inch long, medium and fine-grained modifications occurring in subordinate association. The first two kinds are massive, but the fine-grained rock is in places notably schistose, with bands of fine pegmatite running parallel to the schistosity. The mutual relations of the three varieties are obscure, the grainsize changing abruptly without any apparent reason.

Interstitial white material in the coarse and medium-grained varieties probably represents felspar. Apophyses from the main mass are thrown out to both north and south; medium-grained amphibolite is found in the street between the R. C. Church and Convent, and a narrow dyke can be traced for upwards of half a mile to the south. Pegmatite veins seam the main outcrop in all directions, and the southward dyke is generally in close proximity to a narrow vein of pegmatite.

Small isolated patches of amphibolite, usually not more than a yard or two in diameter, are found. One is on the north side of the Berridale road at the first rise out of Cooma, having associated with it ill-defined dykes of fine-grained amphibole schist; another occurrence of coarse-grained rock is at Pine Valley, a little north of the Berridale road, and a third has been noticed to the west of the Mittagang road, near the S.W. corner of Portion 108. These last two occurrences, like that in the town of Cooma, are closely associated with pegmatite veins: the probable significance of this will be discussed later.

This amphibolite must be taken to represent an original dioritic or gabbroic rock intruded subsequently to the Cooma gneiss, but anterior to the large pegmatite veins.

*The pegmatites.*—Pegmatite veins are distributed very widely among the crystalline metamorphic rocks, but in spite of this their relations to the surrounding rocks are by no means clear in all cases. There have been three separate igneous intrusions in connection with which pegmatites might have been injected. With regard to the blue gneiss no evidence has been found to show that there was a proper pegmatitic phase of the intrusion: it is different with the others. The schists, particularly to the south and west of Cooma, are in places very strongly injected with pegmatitic material. Owing to the fact of the mottled gneiss and the Cooma gneiss having been intruded over very much the same area, it is often impossible to tell to which intrusion these injections are due. Furthermore, both of the igneous gneisses have themselves been subjected to pegmatisation. This may be observed in the bed of Cooma Creek a few miles north of Cooma, at the head of Snake Gully near "Kiaora," and elsewhere. Long veinlets of pegmatite follow the lines of foliation of the gneiss, occasionally bulging out into lenticular masses. The sedimentary schists have been similarly affected, the little pegmatite stringers being very numerous, and following the puckerings and foldings of the schist. These veinlets are as a rule narrow, varying in width from  $\frac{1}{4}$  of an inch up to a couple of inches or so, although some in the Cooma gneiss attain a width of 6 inches. They consist for the most part of quartz and flesh-coloured felspar, with subordinate white mica and black tourmaline.

Apparently distinct from these minor pegmatites, there have been observed a number of larger and more truly pegmatitic injections. The principal of these and their



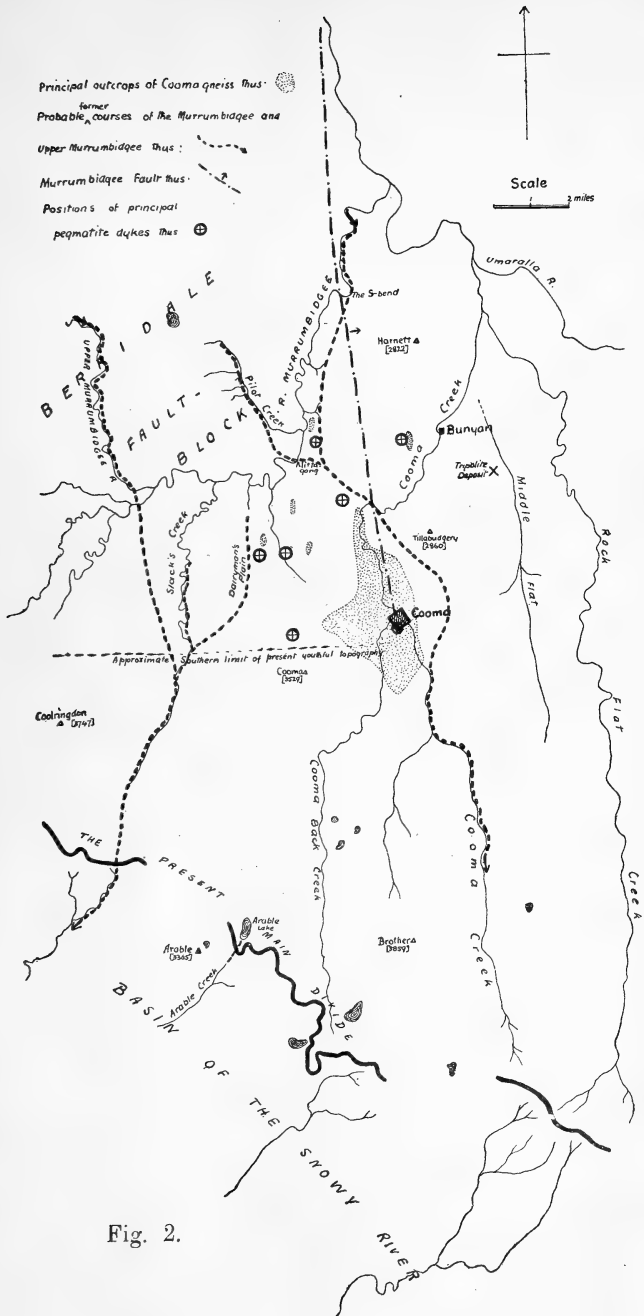

Fig. 2.

position relations to the Cooma gneiss, are indicated on the map (Fig. 2). They nearly all have an approximately meridional trend, and consist of quartz, felspar, mica and tourmaline; no other minerals have been recognized megascopically. Mr. C. F. Laseron, of the Technological Museum, Sydney, has kindly given me a piece of rock picked up by him near the Cooma pegmatite dykes, composed mainly of quartz and epidote. Unfortunately however, the relations of this fragment with the pegmatite could not be established although there is a strong probability of some connection between them.

Graphic granite is a feature of all the occurrences, and there are also coarse irregular intergrowths of quartz and felspar. Occasionally a rude "comb structure" is developed by the crystallization of large feldspars growing towards the centre, the central space being filled with quartz. Mica, both white and brown, is developed, the latter sometimes being particularly noticeable along the sides of the veins with the short axes of the crystals parallel to the walls of the intrusion. Tourmaline often occurs in large segregations, but may also be irregularly distributed: in the Cooma veins the tourmaline occurs mostly along the boundary between the comb structure feldspars and the central filling of quartz.

There is at times a notable local increase in the basicity of the country rock in the vicinity of a pegmatite vein, expressed by a concentration of biotite along the margin of the intrusion.

The dimensions of the veins are not in every case ascertainable, owing to the presence of a covering of soil. The occurrence west of Mittagang road appears to be about 20 feet wide, two others are 15 feet and 6 feet respectively, while those in the town of Cooma are not more than a foot or two in width. Some of them must have considerable

length: the main vein in Cooma has been traced south for about a mile, and it is probably the same which outcrops along the east bank of Cooma Creek a mile or so north of the town. None of the other outcrops have been traced for more than 150 yards.

The contacts with the invaded formations are as a rule quite sharp. In the case of the Cooma pegmatite this is very marked indeed; here a great number of veins intersect the amphibolite and the gneiss, and in each case the boundaries are very definite.

In a number of the veins or dykes there is evidence of crushing subsequent to intrusion. This chiefly affects the margins of the dykes and shows itself in jointing parallel to the walls, and in marginal granulation of the pegmatite, producing a coarse aplitic-looking and rather friable rock. Most of the dykes exhibit this to some extent, but a notable exception is the Cooma pegmatite, which remains quite massive, this being possibly due to its being in the heart of the Cooma gneiss and so more effectively protected from crushing than those dykes which are among the less resistant schists. A certain amount of ragged-looking white mica often developed in the cracks of the felspars may be secondary.

The relative proportions of quartz and felspar in these pegmatites are very variable, quartz being sometimes very subordinate and at other times the predominant mineral. The dyke at "Kiaora" is characterized by a number of elongated outcrops of quartz up to 8 or 10 yards in length, bordered by felspar and graphic granite.

*Quartz veins.*—By the decrease and vanishing of felspar we have veins of tourmaline greisen and of quartz with tourmaline. These probably represent the last phase of pneumatolytic action, and have an origin similar to that

of the pegmatites, although no actual case was found of a pegmatite vein grading into a quartz vein.

Quartz veins are very common among the altered rocks, often grooved and slickensided, and generally following the strike of the country. Some of them are metalliferous: mispickel occurs in one to the N.W. of "Kiaora," and I understand that silver was formerly mined in a quartz reef at the mouth of Slack's Creek. Some of the barren quartz reefs which outcrop may be connected with the intrusion of the Berridale granite.

The relations of the pegmatites and the gneisses, as has been said, are not at all clear. The Cooma gneiss is the most likely intrusion for the pegmatite to be connected with, but it may be noted that on the hill behind the R.C. Church in Cooma, the pegmatites intrude the amphibolite, which in turn appears to intrude the Cooma gneiss. Moreover the well-defined boundaries of the veins would indicate the intrusion of the pegmatite after the complete solidification of the invaded rocks. On the whole, however, it seems most reasonable to suppose that the injections represent the pneumatolytic phase of the Cooma gneiss. As for the minor pegmatites—those narrow stringers which seam both gneisses and schists—it is hard to say whether they are all to be correlated as phases of the Cooma gneiss magma or not.

The very striking, though not constant, association of pegmatite and amphibolite suggests that these two may represent complementary differentiates from the magma of the Cooma gneiss. This, however, is a matter which can only be determined, if at all possible, by laboratory investigation.

(b) **ORDOVICIAN.**—While it is not intended at the present juncture to discuss the relations of the metamorphic series with the other formations, it may be remarked here that

there are strong indications of a gradual passage from the crystalline schists through phyllites to Ordovician slates. Going due west from Kiaora homestead, one notices that the Slack's Creek phyllites appear to grade into dark micaceous slates which become less micaceous and more like ordinary slate. At McCarty's Crossing, near the junction of Bridle Creek and the Murrumbidgee, are bands of hard dense blue-black slates interbedded with whitish-grey felspathic-looking slates, and dipping east. The black slates contain obscure marks of graptolites, which have been identified as such by Mr. W. S. Dun. Lithologically these slates are similar to those interbedded with the phyllites on Slack's Creek, and appear to be of the same age.

Going west along the Adaminaby road slates similar to those at McCarty's crossing are found to occur as far as Wambook Creek. I was unable to examine in detail the slates occurring here, but Mr. C. F. Laseron has kindly shewn me specimens of slates containing well-preserved graptolites, found by him some distance up Wambook Creek from the road, and exhibited before the Linnean Society in 1909.<sup>1</sup> Mr. Laseron has also very kindly furnished me with the following list of the graptolites represented:—*Diplograptus foliacius* (very abundant), *Climacograptus bicornis*, *C. hastata* (very abundant), *Dicellograptus elegans*, *D. caduceus*, *D. affinis*, (?) *Pleurograptus*.

These slates are chialstolite-bearing, the presence of this mineral being due to contact metamorphism of the slates by the intrusion of the Berridale granite.

Following the Adaminaby road past Wambook Creek one meets with a succession of rotten slates, and farther on of quartzites, extending right on to the outcrop of the Berridale granite, about 14 miles out from Cooma. These

---

<sup>1</sup> Proc. Linn. Soc. N.S.W., xxxiv, 1909, p. 118.

rocks are assumed to be Ordovician, as by their strike they are somewhat to the east of the Geygedzerick Hill slates mentioned below.

Dense black slates outcrop between Cooma and Bunyan, and at Bunyan to a distance of 400 yards east of the Sydney Road. No fossils have so far been discovered in them, but their marked contrast with the Silurian slates farther to the east, and their lithological similarity to those west of Slack's Creek, seem sufficiently striking to determine their age as Ordovician. The exact eastern boundary of these slates is not known, its determination being rendered difficult by the quartz-porphry intrusions, by cappings of basalt, and by the recent alluvials of Cooma and Middle Flat Creeks. However there is a distinct difference in appearance between these slates and those outcropping further to the east which are definitely Silurian, so the Ordovician may be taken as having its eastern boundary approximately as given on the map.

At Bunyan these slates have been locally silicified, or replaced by silica, with retention of their original cleavage and other characteristics. This I can only ascribe to the intrusion of the white gneiss: traversing across the strike one observes all gradations from evident gneiss to equally evident silicified slate; there is no distinct line of demarcation between them.

Although they are not included in the map, and are somewhat beyond the area dealt with, some mention must be made of the Ordovician slates of Geygedzerick Hill,  $2\frac{1}{4}$  miles N.E. of Berridale. I am indebted in the first instance for information as to their existence to Mr. L. Grater, a science student at the University of Sydney, who kindly gave me some specimens of the slates which he had picked up on the spot. The hill, or rather ridge, looks to be the end of a tongue of slates and quartzites almost surrounded by

granite, the quartzite being mostly on the lower slopes nearest the igneous rock, while the slates appear on top of the ridge. Contact metamorphism has produced a very dense black slate, only imperfectly cleaved, and exceedingly rich in chiasmolites. These vary very much in size, some being of microscopical dimensions, while others are upwards of  $1\frac{1}{2}$  inches in length. In spite of the alteration which they have undergone, the slates contain a great abundance of fairly well preserved graptolites, *Tetragraptus*, *Didymograptus* and *Diplograptus* being recognized. The presence of these fossils in such a good state of preservation here and elsewhere, denotes that the cleavage planes of the slates coincide with the bedding-planes of the original sediments.

It is interesting to note that the presence of chiasmolites in the slates of Geygedzerick Hill was observed by Rev. W. B. Clarke in 1851,<sup>1</sup> though, curiously enough, he seems to have failed to notice the graptolites, in spite of the fact that, on his own testimony, he was ever on the lookout for them in the slates of New South Wales.

A small patch of dark blue limestone is interbedded with the slates at Pearman's Hill. The outcrop is not more than 15 yards long by about 5 yards wide. The rock shows signs of great compression, and is crystalline; possibly this is due to the presence of the white gneiss a few yards away, that is of course, if the latter is really intrusive. A diligent search failed to reveal any fossils in the limestone.

According to David, Helms and Pittman,<sup>2</sup> the Ordovician rocks extend about  $6\frac{1}{4}$  miles to the west of Berridale, where they are intruded by the Kosciusko granite. It is interesting to note that Mr. C. F. Laseron has recently<sup>3</sup> found

---

<sup>1</sup> Southern Goldfields, p. 115.

<sup>2</sup> Proc. Linn. Soc. N.S.Wales, xxvi, 1901, p. 30.

<sup>3</sup> Personal communication from Mr. Laseron.

graptolite-bearing beds in the neighbourhood of Cobargo, which lies about 44 miles from Cooma in a direction roughly  $10^{\circ}$  S. of E. The slates are identical in appearance with those of Geygedzerick Hill and Wambrook Creek. The following forms were determined by Mr. Laseyron:—*Diplograptus foliaceus*, *Climacograptus*, *Dicellograptus* (?) *gracilis*, *D. affinis*. It would be interesting to trace the relations of these rocks to the Ordovician of Cooma and Berridale. The interposition of Silurian sediments to the east of Cooma suggests their deposition in a trough or synclitorium of Ordovician rocks.

(c) SILURIAN.—As the Ordovician lies, roughly speaking, to the west of Middle Flat and the Silurian to the east, and as, in spite of some discordances, the prevailing dip is towards the east, it is natural to assume that the upward sequence, or the sequence of deposition, for the Silurian beds is from west to east. That being so, the lowest sediments are slates, with interbedded limestone and brown quartzites, passing upwards into gritty sandstones, carbonaceous shales and quartzitic sandstones alternating with bands of clay-shale. The limestone, carbonaceous shales and gritty sandstones are fossiliferous; the other horizons are barren.

The slates vary in colour, and are extremely cleavable and much jointed, splitting readily into small pieces. Their stratigraphical position is sufficiently determined by their association with the other fossiliferous beds.

The limestone runs in a general N.N.W. direction and forms a belt about 4 miles long. Its northern end, which disappears under the alluvials of Cooma Creek, has a width of outcrop of over 1,000 yards; this gradually decreases as one goes south, till at Toll Bar Bridge it is not more than 100 yards. The main mass disappears here, but the belt continues southwards as a series of small isolated



lenticular patches, the most southerly of which crosses the Greenhill Road a little to the west of Rock Flat Creek. Here there are seen to be two intermittent outcrops of two distinct kinds of limestone, separated by slates, and sometimes 40 yards apart. The main outcrop is of light blue limestone, massive and fossiliferous, the other harder, of a deeper blue, flaggy, unfossiliferous, and much intersected with veins of white secondary calcite. Occasionally this band is broken up into smaller bands, about 4 inches wide, interbedded with the slates. The limestone is traversed by cracks or joints striking a little west of north. The dip appears to be easterly on the western side, and westerly on the eastern, the angles in both cases being very high. Caves are said to exist in the limestone, fairly extensive and containing stalactites.

The main outcrop of the limestone is constantly attended by quartz-porphry on both sides, which has very probably intruded and to some extent destroyed part of the limestone. A certain amount of assimilation may have taken place; a specimen of quartz-porphry collected from near the junction showed under the microscope numerous little patches of what look like epidote. Along the eastern boundary of the limestone, however, the quartz-porphry (and possibly the limestone too) has been converted into a kind of ironstone, thus destroying any evidence of contact effects. This ironstone is indeed more or less characteristic of the limestone outcrop, and where the latter cannot be traced ironstone is often found. The occurrence is suggestive of a metasomatic replacement.

There is in the limestone abundant development of *Favosites*, both the large massive and the small dendroid species, also *Heliolites*, *Tryplasma*, *Pentamerus*, and *Stromatopora*. The fossils are in general well preserved.

East of the limestone there is a further development of slates. Between Rosebrook homestead and the Umaralla

River the rest of the sequence is well shown. One passes in succession over grits, carbonaceous shales and quartzitic sandstones interstratified with shales in bands up to a foot in thickness. These are vertical at first but towards the river they have a westerly dip which decreases to  $56^{\circ}$ .

*Rhynchonella* in great abundance, *Strophomena*, and (?) *Tryplasma* have been found in the grits and carbonaceous shales. The fossils are a good deal compressed, and their species are indeterminate.

(d) POST-SILURIAN BUT PRE-TERTIARY.—To these rather wide limits are referred three apparently independent occurrences of igneous rocks, the quartz-porphyrries, the Berridale granite, and the Myalla Road syenite.

*Quartz-porphyrries*.—This is a general term employed to denote a series of intrusions with many differences both textural and mineralogical, but evidently of common origin. They outcrop along roughly meridional lines, and so far have not been found west of a north and south line through Cooma, but intruded among the slates and other sedimentary rocks to the east and north-east of the town. Southward they disappear under the Tertiary basalt, to the north they have been traced as far as Bredbo, 20 miles from Cooma, where their extent is very great. They have played a considerable part in determining the contours of the present land surface, for, as one goes east from Cooma, it is observed that, generally speaking, the porphyries form a series of parallel low ridges, while the valleys in between have been cut out of the softer and less resistant slates. The porphyries are perhaps best described as irregular dyke-like intrusions into the slates, although the outcrops attain a width of about half a mile in places. Their intrusive nature is abundantly proved by inclusions of the intruded slate, as well as by the tapering terminations of the outcrops. Very little contact metamorphism is observable, barring a little local induration of the slates.

The rock has been subjected to pressure subsequently to its consolidation; this has caused a good deal of shattering and alteration, in some cases changing the original appearance almost beyond recognition. From a field examination of the porphyries it has been concluded that there must have been at least three distinct series of intrusions, possibly four. There is first of all the very much sheared type, exemplified in the Bushy Hill formation, now reduced to what Van Hise would call a quartz-porphyry slate,<sup>1</sup> quite schistose in structure. The cleavage pieces have a somewhat greasy lustre, with dark green colour and greasy feel, due possibly to the development of chloritic minerals. Frequent eyes and lenticles of unshattered quartz, the relics of former phenocrysts, are scattered about the rock. Doubtless a certain amount of alteration is to be attributed to the mineralised waters which percolated through the porphyry at this place. Northwards right along the line of the Bushy Hill outcrop the porphyry is much "mylonized," in places so much so as to be recognizable only with difficulty. On Bushy Hill the cleavage planes are vertical, and no where has the departure from the vertical been found to be more than 40°. Very little in the way of ferromagnesian constituents has been observed in the Bushy Hill porphyry. In addition to quartz, felspar occasionally appears as phenocrysts.

Between "Rosebrook" homestead and the Umaralla River one passes over a couple of outcrops of porphyry of a light grey colour, with large and abundant phenocrysts of quartz, felspar, and a dark green chloritic-looking mica in small hexagonal plates. This rock is rather shattered; it is intruded among Silurian slates and appears to be of no great extent. In the size and abundance of its quartz crystals it much resembles some of the "mylonized"

---

<sup>1</sup> A Treatise on Metamorphism, p. 779.

porphyry, and may possibly be the unaltered equivalent of this latter. In general appearance and mineral constitution it also bears a striking resemblance to a quartz-porphyry from Yass district, with which indeed it may be genetically connected.

Closely associated with this Rosebrook porphyry is a dark blue exceedingly compact felsitic rock, with relatively small development of phenocrysts, which are mainly quartz. By weathering and bleaching this rock assumes the appearance of a quartzite, as at Toll Bar Bridge. From here to Rosebrook it forms a considerable part of the eastern boundary of the limestone; it is entirely free from shattering. A ridge of the same rock is to be seen near Rock Flat, proving for it a meridional extension of at least 16 miles.

Another variety of porphyry, which is found to the east of Cooma and north as far as "Rosebrook," is a dark rock with much smaller and very abundant phenocrysts of quartz and felspar; at first sight the rock appears to be tuffaceous but this is not so. It is in all cases highly and irregularly jointed, and very often shows a rude cleavage. On the appearance of the rock in the field one would pronounce it to be of an entirely distinct type from the Bushy Hill and Rosebrook porphyries, the chief differences being the smaller grainsize of the phenocrysts and the greater abundance of felspar.

The remaining type of porphyry has evidently been intruded last of all, and has been subjected to very much less crushing than the other varieties. It is to be found on the Greenhill Road about two miles out from Cooma. Though just a little east of the line of the Bushy Hill outcrop, and west of some of the small-grained porphyry, the rock is here quite massive and free from shattering, proving its relative youth. The same porphyry also occurs farther to the east along the road to "Nitholme" and on the Kydra

Road at and past Middle Flat. Going about a quarter of a mile N.N.W. from "Nitholme," one observes that this porphyry is intrusive into the fine-grained variety; the outcrop is very wide, about one-half to three-quarters of a mile in places. Generally the rock is massive, but sometimes it is a bit shattered at the periphery of the mass. Its intrusive character is shown near Rosebrook, where an isolated outcrop of it forms a conical hill sharply differentiated from the other porphyries and from the slates.

This porphyry is a very handsome rock, abundantly porphyritic in quartz and felspar, usually also with hornblende in varying amount. Quartz-porphyry was found in which practically all the base had been replaced by oxide of iron, leaving intact only the porphyritic quartz and felspars, and again in another place kaolinization had occurred, resulting in a soft white rock studded with quartz grains.

*Berridale granite.*—Only a very small portion of the whole area of this was examined, and then not in great detail. It was only studied where it touched on the main area investigated.

As one goes from Cooma to Berridale the granite is first met about  $9\frac{1}{2}$  miles out. Great rounded monoliths of it strew the plain, and it can be seen stretching for a considerable distance on either side of the road most of the way into Berridale, the outcrop being occasionally concealed under small residual patches of basalt. On the Cooma side, the junction of the granite with the intruded Ordovician slates and quartzites has been to some extent eroded, and is masked by alluvial.

The granite was also met with along the Adaminaby road at a point 14 miles from Cooma, but a journey of 20 miles south on the Bobundarah road failed to reveal any signs of it, so evidently the boundary of the outcrop takes a sweep to the south somewhere between the Berridale and Bobundarah roads.

The rock is a typical biotite granite and it exhibits considerable variation both in grain and in the proportions of ferro-magnesian minerals present. This variation is of the usual type, that is with decreasing basicity and coarser grain inwards from the margin of the intrusion; this is well exhibited as one proceeds from the margin of the mass towards Berridale. A slight but distinct gneissic foliation, apparently primary, was noticed at one place, but the extent of this phenomenon was not traced. Basic segregations are fairly numerous, and a number of aplitic dykes intersect the granite; some of these were entirely of the ordinary granular type, while others exhibited occasional graphic fabric, and others again had miarolitic cavities filled with tourmaline.

On Arable Station just on the north-eastern border of the granite occurs a dyke of a dark grey porphyritic rock, without megascopic quartz, and of rather indefinite megascopic characters. In thin section the rock is seen to be of lamprophyric type.

At every place where the edge of the granite was encountered a selvage of quartzite of varying width was found, while large quartz dykes were, as might be expected, very common. The quartzite border was noticed on the Adaminaby Road, on the Berridale Road and south of it, on Arable Station, and at Geygedzerick Hill. Contact effects were not specially looked for, but this constant occurrence along the irregular granite border suggests that the quartzite represents a complete replacement of the original sedimentary rocks by silica from the granitic magma for some distance from the actual contact. Another contact phenomenon has been already alluded to, namely, the production of chiastolite in the intruded slates.

*Myalla Road syenite.*—Five miles along the Myalla road south from Cooma, there is an isolated outcrop of syenite

of boss-like appearance. The mass is over two miles long, with a maximum width of a little under two miles; it is surrounded on all sides by schists and olivine basalt, and is 7 miles away from the nearest outcrop of Berridale granite. The syenite is in general massive, and weathers into great rounded tors like granite, which undergo a kind of spheroidal exfoliation. Jointing is developed at times: one reading on a joint plane gave its dip as  $65^{\circ}$  in a direction E.  $10^{\circ}$  S. Megascopically the rock would be called a syenite, as it is seen to consist of felspar (orthoclase) and hornblende, but a microscopic examination would place it rather among the quartz-monzonites. Towards the eastern periphery of the mass there is a considerable development of a porphyritic facies, which might be called a syenite-porphry. Irregular basic patches without any definite sharp boundaries are also frequent.

The plutonic rock is intersected by dykes of felspar-porphry or bostonite, with only very small traces of ferro-magnesian constituents, and many apophyses radiate into the surrounding country. One of these forms a conspicuous feature among the schists along the Myalla road, and can be traced for about 6 miles, ultimately coming to an end in a railway cutting a mile north of Cooma. The texture of this dyke-rock changes as we get away from the parent plutonic mass. The felspar phenocrysts may be upwards of half an inch in length and very numerous, the base being fine-grained but evidently holocrystalline. Farther away the base gets exceedingly fine-grained and phenocrysts are very much fewer and smaller, the rock giving the impression of a trachytic lava rather than of a hypabyssal rock, while the subordinate ferro-magnesian constituents have completely disappeared. These variations are evidently functions of the distance from the parent magma, the conditions of consolidation, and especially of heat, as we get

away from the syenite, gradually becoming less and less plutonic in character. The actual contact of the syenite with the older rocks is covered over by basalt or alluvium, so it was not possible to obtain any information as to the nature and amount of the contact metamorphism or the form of the intrusion.

*Geological age of the igneous intrusions.*—There are no means of determining with exactitude the geological age of all these intrusions, nor indeed is there any direct evidence to show that they are genetically connected, or even contemporaneous with each other. It will be observed on referring to the map that the syenite is a long way away, and quite isolated from the granite, and that the porphyries are far removed from both.

With regard to these porphyries, if they all belong to the same series they must be Post-Silurian, but if not, then some may be as old as the Ordovician. Very much mylonized porphyries, hardly recognizable as such, occur in among the Ordovician slates at and north of Bunyan, and it is possible that here they represent contemporaneous submarine sheets interbedded with, and subsequently tilted and compressed along with, the original sediments. On the other hand, others of the porphyries have all the appearance of intrusions, fragments of the intruded slates being included, and slight alteration of the surrounding rocks being produced. The form of the outcrop too, in many cases, suggests a tapering sheet or sill. The intruded formations in these cases embracing Silurian beds, the porphyry must be of later age. Some of the quartz-porphyry, since it is relatively unshattered, must have been injected after the folding and compression had practically ceased.

The granite and the syenite are both clearly later than Silurian, as they have been subjected to strain only to a slight extent. The granite along its marginal portions and



the syenite throughout its observed extent are free from gneissic structures, indicating that their crystallization took place during a period of comparative crustal stability. Since the Carboniferous appears to have been a time of intrusive igneous activity in central and southern New South Wales, it seems not unreasonable to assign these igneous rocks tentatively to that period.

(e) TERTIARY AND RECENT.

*Olivine Basalt.*—The latest evidences of igneous action about Cooma are to be found in the extensive flows of basalt which cover a considerable area of the surface of the country, and must have had a very much greater extent before erosion and denudation reduced the capping to its present dimensions. Besides the large sheets, isolated residual patches of basalt, forming the characteristic table-topped hills, are to be found overlying the Berridale granite, the schists, and the slates and other Palæozoic rocks. Of the highest basalt residuals—the three hills known as The Brothers, about eleven miles south of Cooma—the Middle Brother is 100 feet higher than the next highest Trig. Station in the district, and about 700 feet above the general level of the country, but these figures of course do not necessarily indicate the depth to which the whole country was originally covered with basalt. The basalt has a much greater extent to the south and S.E. of Cooma than to the north; it may be seen practically all the way along the road from Cooma to Nimitybelle and as far as Bombala. There is evidence of a number of successive flows, in the shape of terraced hills, sometimes as many as four terraces being distinguishable. Again occasionally one finds a flow of fresh basalt on top of an older and much decomposed flow.

On the summit of the North Brother, and also, I understand on the Middle and the South Brother, the basalt is

prismatically jointed over a space of two or three acres. The columns are remarkably regular, mainly hexagonal in section and up to 18 inches in diameter, and no columns were observed more than 4 feet long. In texture the rock is exceedingly fine, and olivine occurs in nodules or segregations, in much greater proportion than in the normal basalt. In places there has been a tendency to subsidiary jointing, producing a kind of pisolitic effect on the weathered surface. Only the summit of the North Brother is composed of this very compact basalt; below it the hill is terraced and the basalt is of the ordinary fine-grained type.

A noteworthy example of variation in the texture may be observed west of the Myalla Road 4 miles south of Cooma. Here there is a flat-topped terraced ridge, the topmost terrace being of coarse-grained basalt, doleritic in aspect and microscopically seen to have ophitic fabric. The basalt of the terrace immediately underneath is much finer in grain and of granulitic fabric. Two possible explanations suggest themselves. What we now see as the upper terrace may really represent the bottom part of a thick flow, whose top has been denuded; the bottom part would have cooled comparatively slowly and so have become somewhat coarsely crystalline. Or else the coarse-grained rock might have been intruded as a kind of dolerite sill between two pre-existing flows, one of which is now denuded away.

To the N.W. and east of Cooma the basalt has in some instances filled old pre-Tertiary valleys; for example, the road from Cooma to Murrumbucca viâ Mittagang Bridge runs mostly along such a valley for 11 miles, and the former course of the Upper Murrumbidgee from McCarty's Crossing to the junction of the Dalgety and Berridale Roads is now marked by flows of basalt. No tufts have been anywhere found associated with any of the flows.

The age of the basalts, and the possibility of their extrusion having continued into recent geological times, will be discussed later in connection with the physiography.

*Diatomaceous earth.*—There is a deposit of diatomaceous earth or tripolite about  $1\frac{1}{2}$  miles E.S.E. of Bunyan Railway Station (See Fig. 2). The deposit is referred to in Pittman's "Mineral Resources of N. S. Wales," p. 429, also in the Records of the Geological Survey of N. S. Wales, 1897, p. 128.

From test-holes which have been put down, the deposit is believed to cover an area of 30 acres. It is situated in a hollow on the western side of Middle Flat, surrounded on the north and west by a ridge of slates and mylonized quartz-porphry capped by Tertiary basalt. The deposit is close to the surface, being covered by 18 inches to 2 feet of alluvium, chiefly basaltic soil. Under this is about 2 feet of very hard buff-coloured "mullock," a kind of travertine containing numerous angular fragments of quartz and of diatomaceous earth. This is succeeded by another 2 feet of massive tripolite of a pale creamy-white colour, then comes 3 feet of layered tripolite—"slate," as it is called—which is slightly denser than the other and shows stratification. Under this the deposit is alternately massive and stratified. At intervals, pipes of roughly elliptical section occur, filled with a hard, brittle brown clay, in which remains of bones, etc., are often found. Veins of wood opal are fairly frequent, yellow, red, and green in colour, and very light and brittle. The deposit is being worked, but not in systematic fashion, digging operations not being carried on to a greater depth than 10 or 12 feet.

*Travertine.*—At Rock Flat, 9 miles S.E. of Cooma, on the right bank of the creek, are situated the well-known Rock Flat mineral springs,<sup>1</sup> where carbonated waters rise

<sup>1</sup> For an account of these see Rec. Geol. Surv., N.S.W., 1889, p. 179.

from a depth and flow to the surface. Although at present only one spring—a chalybeate one—is actually flowing, it is only of recent years that the spring which is the source of the present supplies has ceased to flow, and there is evidence that in the past quite a number of springs were active. A considerable amount of travertine has been deposited from these springs, and is still being formed. So far the deposit has a maximum depth of 12 feet, and is said to cover an area of 5 acres. Except at one point where the creek takes a sharp bend to the east, the travertine is wholly on the east or right bank of the stream. The Rock Flat Springs are at the base of a great quartzitic outcrop, from which the place takes its name. The outcrop consists of sandstone on edge, intersected with quartz veins, and which merges into quartzites towards the west, and ultimately into a kind of quartz breccia, the cementing material being also quartz. The dip of the quartzite is about W.  $10^{\circ}$  S. at  $40^{\circ}$ .

Travertine is found sparingly developed in other parts of the region; it has been noted along the Bobundarah Road near the North Brother, also just south of Bunyan along the Sydney Road. It occurs on top of the old metamorphic rocks, and is generally covered by alluvium. Probably it is post-Tertiary in age.

A curious occurrence was found in Butler's Creek, a bit north of Mittagang Bridge. Here the creek, when running, tumbles over a rock-bar about 12 feet high, and down the face of this there is a kind of stalactitic deposit of travertine, evidently formed when only a trickle of water was running, and due to evaporation as the water flowed over the heated rock in summer.

*River gravels.*—Perhaps the most extensive development of these is along the Numeralla Road to the west of the Toll Bar Bridge over Rock Flat Creek. The gravels com-

mence three-quarters of a mile from the creek, and form a very striking feature of the topography, extending half a mile to the south and much farther to the north. They are composed principally of boulders and pebbles of brown quartzite and white quartz. The quartzites are up to 18 inches in length, and there are occasional boulders of nearly three feet in diameter. They all show a good deal of rounding and smoothing and occasionally of polish. Low mounds of gravel and other alluvium are to be seen in the vicinity, and similar accumulations may be observed in the broad flat valley north of the limestone belt. There is little doubt that these gravels belong to Rock Flat Creek or an ancestor of it; their presence at a distance of three-quarters of a mile west from the present bed of the creek, and at least 100 feet higher, would indicate a good deal of migration and erosion on the part of the creek since their deposition. It is rather puzzling to find these gravels, and especially the boulders of three-foot diameter, on the highest point of the ridge separating Middle Flat from Rock Flat Creek. I was at first inclined to ascribe their presence to ice-transport, but doubtless they are fluvial deposits.

Three well-formed crescent-shaped alluvial terraces mark the point near Pearman's Hill where with a sharp S-bend the Murrumbidgee emerges from the Berridale fault-block. The highest is at 130 feet, and the others at 50 and 25 feet respectively, above the present level of the stream. These terraces are of gravel principally, but the middle one is mostly mud.

*Æolian deposits.*—A noticeable feature of the Sydney road between Cooma and Bredbo is the great extent of country partially or wholly covered with drifting sand. Shortly after the road crosses Umaralla River, this sandy country begins, and it continues to within 5 or 6 miles of Bredbo. This mantle of sand gives the region a barren and

desolate appearance. It is due to the disintegration of quartz-porphry, of which there is a very extensive development along the road to Bredbo. The shifting of the sand by the action of the wind has the effect of drifting up the road in many places, of burying fences, and of destroying vegetation.

*Quartzitic conglomerate.*—At various points in the Cooma district one comes across outcrops and boulders of a silicified quartz-conglomerate, apparently forming a surface capping to the slate, etc. Just north of the Myalla Road syenite masses of this conglomerate are seen, and here too we get a dense bluish-grey quartzite, evidently connected with the conglomerate. No evidence could be found as to the age of these occurrences, or their relations with other formations: they are probably the result of deposition from silica-bearing solutions, but whether these were connected with the late igneous intrusions, or are of much more recent date it is impossible to say.

### III. Economic Geology.

*Bushy Hill.*—The Bushy Hill gold mining field is dealt with in the Annual Report of the N. S. Wales Department of Mines for 1898. A number of references are made to it there, including the report of the Chief Inspector of Mines, with petrological appendix by Mr. G. W. Card.

The occurrence of gold at Bushy Hill was noted about 16 years ago, and a certain amount of mining work was done, but, though some good results were obtained, for various reasons work was abandoned almost completely. Gold, copper and lead ores have been obtained. In the old days only the gold was sought after, some good values being obtained from the surface free gold. Telluride yielding high percentages was found, but not in great quantity. The copper occurs as auriferous pyrites, apparently in considerable quantity in places. At present copper is being

extracted from the water in some of the old shafts by the simple method of throwing in scrap-iron, which is in time replaced by metallic copper. Galena is said to have been found on the hill.

Bushy Hill, which is really a long ridge, is composed mainly of a mylonized quartz-porphry which forms the country rock, and the minerals occur mostly disseminated through it. The porphyry contains numerous "eyes" of quartz, while less frequently felspar occurs as phenocrysts. Slates also form part of the country rock. The cleavage planes of quartz-porphry and slates are vertical. On the Cooma side there is quartz-porphry which appears to be of a later date than the other: it is free from crushing, has smaller phenocrysts, and has a siliceous-looking base, resembling to some extent the silicified porphyry at Toll-Bar Bridge. North of Bushy Hill a long sinuous outcrop of quartzite, running in general N. 20° E. extends to near the Numeralla Road.

Between Bushy Hill and Middle Flat is a long reef, forming a conspicuous ridge about half a mile long, and composed of what appears to be a kind of quartzite, seamed with quartz veins. This reef has been found to be barren.

*Tripolite*.—Reference has already been made to the deposit near Bunyan. This is being worked by a company which employs one man in digging the tripolite, drying and bagging it, and despatching it to Melbourne, for what ultimate purpose I have been unable to ascertain.

*Lime*.—At Toll Bar Bridge there is a kiln where the limestone is being burnt on a small scale. There is apparently only a local sale for the lime, but there seems no adequate reason why a bigger industry should not be built up.

*Barytes*.—About 200 yards east of the N.E. corner of Portion 300, Parish of Cooma, and just outside the eastern

municipal boundary, there is a vein of barytes in shattered quartz-porphry. The vein has a maximum width of 14 inches at the surface, but I understand it widens considerably as it is traced downwards. The dip is at  $50^\circ$  in a direction E.  $19^\circ$  N., which is more or less in conformity with the cleavage of the quartz-porphry. The outcrop was traced by me for a distance of about 30 yards. A little excavating has been done and some of the barytes removed, but the work has not advanced beyond the prospecting stage.

#### IV. Age of the Metamorphic Series.

The stratigraphical position of the crystalline complex consisting of the schists, phyllites and quartzites, intruded by the mottled, Cooma, and blue gneisses, is a matter which has exercised me very much without any definite conclusion being reached. At the present stage of the work it is perhaps a trifle premature to discuss the matter fully. In the first place it is only in the area round about Cooma that the field relations have as yet been studied, whereas there is reason to believe that this crystalline series extends considerably farther north than Pearman's Hill; the northerly limit of my investigations up to date; an examination of this northerly extension may perhaps result in the discovery of some conclusive evidence. Secondly, field evidence may quite possibly be supplemented by laboratory investigation, and this latter is by no means complete. However, I have thought it good to make some mention here of this most important question.

The principal difficulty, and it is a great one, which confronts anyone attempting to delimit the various formations around Cooma lies in the fact that no stratigraphical breaks are to be found, the whole of the old Palæozoic rocks being so intensely folded as to obliterate all traces of original unconformities, if such existed. The prevailing dip of planes of schistosity and cleavage is easterly, but many



reversals are found. High dip-angles are the rule, and the cleavage planes are often vertical. Possibly the present state of affairs results from the erosion of a series of isoclinal folds. On the slopes of ridges one occasionally found discordances of dip—beds on one side dipping towards those on the other side, apparently indicating a fold-trough, but in some instances this was clearly seen to be merely a surface phenomenon, the beds, originally vertical or nearly so, inclining over towards the downhill side of the ridge under the influence of gravity.<sup>1</sup> Nothing but extremely detailed mapping of individual horizons could determine the nature of the folding.

With regard to the metamorphic series, the gneisses are quite definitely intrusive into the schists, and the question of age therefore centres round these schists and the phyllites. A number of traverses were made across the strike, both to the east and west of the axis of the complex, and in no case could an abrupt transition in the rock-type be found. Starting from Kiaora homestead, on crystalline schists, as one goes west the rocks become more micaceous and phyllitic in appearance: there is a considerable belt of these rocks, about  $1\frac{1}{2}$  miles wide, which I have named the Slack's Creek phyllites from their typical development and the good sections shewn there. Near the Dry Plain road and beyond it to the west, the phyllites have graded into micaceous slates which are in the same line of strike with the slates in which graptolites occur at McCarty's Crossing, about a mile to the north.

On the eastern side there is the same gradual passage from schist through phyllite into micaceous slate, but here the transition belt is not so broad, practically no knotted phyllite is developed, and there is the intrusion of white gneiss which interrupts the succession of the beds.

---

<sup>1</sup> Mr. E. C. Andrews informs me that he too has found this 'false dip,' as it may be called, troublesome in the field.

Again, as further evidence, as has been stated above, at Bunyan the Ordovician slates are silicified for some distance out from their contact with the white gneiss. Now this white gneiss is closely associated with the blue gneiss, and this would go to show that the gneiss is later than these slates.

It has been urged that strike faulting could have thrown down the Ordovician slates against the Pre-Cambrian schists, but in this case the problem of the transitional phyllites becomes insistent of solution. Of course it may be argued that, as no definite junction between Silurian and Ordovician can be found, any original unconformity between Ordovician and older formations would likewise be obliterated. But on the other hand the Ordovician and Silurian can be separated on fossil evidence, whereas there is nothing but gradual change of lithological characters to differentiate the schists from the slates.

So far as I can interpret it, the evidence available would point to the fact that we are dealing with an area which has been affected by both regional and contact metamorphism. The gneisses have been intruded successively and crystallized under conditions of great pressure; the schists would then be caused by contact metamorphism of the slates in the vicinity of the gneissic intrusions, the intensity of the metamorphism gradually diminishing outwards. It is plain that there is a much greater extent of gneiss than indicated by the outcrops, and in such case the underground extension would go to the west principally. The suggested broad relations between the metamorphic rocks and the other formations of the area are shown in Fig. 1.

I am quite aware that the hypothesis here advanced raises serious difficulties, but at the same time it is to be understood that the evidence so far gathered is by no means regarded as conclusive; nothing at all final can as yet be

stated about the question, and of course it is very doubtful whether the matter will even be settled by future investigation.

#### **V. Geological History up to Tertiary Times.**

We can to some extent trace the sequence of the events which have formed the geological history of the region. In Ordovician times the whole extent of the country was a great sea, in which sandy and muddy sediments were deposited to a considerable thickness: later, in Silurian times, marine conditions still obtained over part of the area at any rate, with deposition of limestones, shales, sandstones and grits. These last would appear to mark a change to shallower water conditions, possibly indicating a positive movement of the earth's crust. Uplift of the area followed, with great earth movements and intense folding along a nearly meridional axis. What was in Silurian times a sea now became dry land, and has not since been submerged.

Subsequently to this uplift, during Devonian or Carboniferous times, intrusions of porphyry, granite and syenite took place. Very extensive denudation and base-levelling must have occurred, and was probably repeated as a result of successive uplifts, so that before the outpouring of the Tertiary lavas the physiography of the country had reached a state of considerable maturity. The granite and syenite had been laid bare by erosion, and the ancient corrugations of the Ordovician and Silurian rocks had been smoothed out by denudation.

#### **VI. Physiography.**

The geological history from the Tertiary till now is really the history of the present topography, and is best to be learnt by considering and studying the surface of the country as it now exists.

It is to be observed that two strikingly different types of topography are presented within the area described. If two lines be drawn, one north and south through Cooma, and the other westwards from a point a few miles south of Cooma, the areas exhibiting these two types are roughly divided off from one another (Fig. 2). To the N.E. we have rugged country, intersected by deep V-shaped valleys, but with some remnants of mature physiography still visible, as for example Dairyman's Plain, the valley of Pilot Creek, and the upper part of Slack's Creek. In other words, we have an area of mature topography with youthful features superimposed. This country is mainly schists and gneisses.

The remainder of the area is generally speaking in strong contrast: it is of a gently undulating nature, characterized by wide shallow valleys running north and south, and bearing all the marks of old age. These valleys are eroded out of the comparatively soft slates, the separating ridges being largely of the more resistant quartz-porphyrines.

The surface of the country is diversified by a number of elevations above the general level; such are the Blue Peak, Mount Gladstone, The Brothers (North, Middle and South), Coolringdon Hill, etc. A number of small lakes are scattered about, mostly in a belt extending for about four miles north of the Great Divide.

The drainage of the country is effected by the river Murrumbidgee and its tributaries. The Murrumbidgee, in the earlier part of its course, as seen in this region follows an approximately E.S.E. direction; it then turns sharply to the east, and flows in this way as far as Mittagang Bridge, when it turns once more, this time sharply northward, or a little east of north. Before the eastward turn the river occupies a middle-aged valley, but from this on it pursues a tortuous course in a youthful valley, between high steep banks of phyllite and schist, which in parts

descend sheer into the water on both sides. The stream continues in this young valley through schists and gneisses to a point about 9 miles N.N.E. of Cooma, where with a sharp S-bend it debouches from between its high containing walls into open country, after which it continues northward, flowing at the base of a steep escarpment which forms its western bank.

During the eastward part of its course the river receives no tributaries from the north, but on the south bank it receives Bridle Creek (with its tributaries Wambrook and Peak Creeks), Slack's Creek, Spring Creek and Snake Gully. These are all characterized, especially near their junctions with the river, by relatively steep grade and by V-shaped valleys. Slack's Creek near its source flows in a broad shallow valley, of which mention will be made later, while Spring Creek rises at the northern extremity of Dairyman's Plain, a shallow valley up to three-quarters of a mile wide. After the river turns north it receives a couple of small youthful creeks, Butler's Creek and another one, unnamed, on its right bank; on the left the only tributary of importance is Pilot Creek, which flows S.E. for 4 miles close up against the eastern side of a mature valley to within a mile of the river, when it plunges into a narrow gorge, joining the Murrumbidgee three-quarters of a mile north of Mittagang Bridge. Pilot Creek forms with the Murrumbidgee a boat-hook bend,<sup>1</sup> the flow of the river being directed northward, while that of its tributary is towards the south.

The drainage of the country is mainly to the north. Cooma Creek and Cooma Back Creek pursue a more or less parallel course through open country in fairly wide valleys to within 5 miles of Cooma, when they begin to converge, uniting in the town to enter a deep valley cut through the Cooma gneiss and schists. Cooma Creek emerges from

---

<sup>1</sup> Griffith Taylor, *op. cit. sup.*, p. 8.

this valley 4 miles along the Mittagang road and flows N.N.E. across a level plain to join Rock Flat Creek. Considerable alluvium marks the confluence of the two streams.

Rock Flat Creek has cut for itself a fairly wide valley. It shows evidence of having shifted its bed somewhat to the east in recent times. From about the 6-mile peg on the Kydra Road, as one looks north there can be seen a long ridge of quartz-porphry forming the left bank of the valley evidently carved out by the creek in the past. The present course of the stream however is upwards of half a mile to the east of this ridge. Again, the gravels along Numeralla Road to which reference has already been made give evidence of easterly movement. Rock Flat Creek joins the Umaralla River 4 miles nearly due east of the S-bend in the Murrumbidgee.

The history of the present topography has been referred to by Griffith Taylor,<sup>1</sup> and discussed in greater detail by Süssmilch.<sup>2</sup> Briefly, the region forms part of what was in late Tertiary times a peneplain area—the Monaro peneplain—the occasional isolated elevations being residuals of a former peneplain—the Mount Ainslie peneplain. This Monaro peneplain has undergone differential uplift, the area in the N.W. which has been roughly indicated above forming part of the Berridale fault-block, with probably a slight tilt down towards the south, and bounded on the east by a steep escarpment—the Murrumbidgee fault-scarp, indicated in Fig. 2. This escarpment crosses the Murrumbidgee near Pearman's Hill, and continues south, gradually merging, as it nears Cooma, into the general level of the country. To the east of the fault-scarp the country has been less elevated, and farther north this relatively depressed area is rather narrow, forming the Colinton senkungsfeld. It broadens considerably towards the south

---

<sup>1</sup> *Loc. cit. sup.*

<sup>2</sup> *Loc. cit. sup.*

and eventually merges into the Berridale fault-block to the south and S.W. of Cooma. This Colinton senkungsfeld is tilted towards the north.

It was probably the same series of earth movements as caused the faulting and differential elevation which also shifted the divide and altered the drainage system of the region. The present divide, which runs roughly E.  $30^{\circ}$  S. at a distance of about 9 miles from Cooma, is very low, and is the result of recent slight tilting of the whole country towards the N.E. The old divide is placed by Süssmilch between Bredbo and Colinton, and by Taylor at Tharwa, 25 miles farther north. Both authors are, however, agreed that the Upper Murrumbidgee used to form part of the Snowy River system, and that for the part of the river between Mittagang Bridge and the old divide there has been a reversal of flow, or in other words that this part also of the river used to belong to the Snowy system, and is now really an obsequent stream.

The above is in the main an abstract of Süssmilch's views as outlined in his extremely interesting and suggestive paper, and there can be little doubt as to their general accuracy.

It might be urged that the so-called Berridale fault-block is due to differential erosion. It is certainly remarkable that to the west of the scarp the rocks are schist and gneiss, while to the east the country is composed mainly of less resistant slates, etc., so that one might expect a greater degree of erosion to the east than to the west. And again the Berridale fault-block merges to the south into the general level of the Colinton senkungsfeld just about where the gneiss-injected crystalline schists cease.

But on the other hand we have evidence of recent uplift and dissection of the fault-block in the presence of the youthful Murrumbidgee valley, which is in places a veritable

gorge (see Plate IV, fig. 4), and in the fact that we find youthful streams flowing in old valleys, as in the case of Pilot Creek. There is no stratigraphical evidence of the fault, but the fact that we do get the same schists and gneisses on the low ground to the west of the scarp as occur on the higher ground to the east, would go to show that the scarp is due to something else than differential erosion.

On the basis of Süssmilch's conclusions I have tried to work out in some little detail the physiographic history of the area with which I am concerned.

The ancient valley of the Upper Murrumbidgee, from the point where near McCarty's Crossing it now turns abruptly east, can be traced south till it joins the broad old valley of Slack's Creek. The ancient course of the river is now blocked by thick basalt flows, and bounded by ridges of phyllite and quartzite, and its contours are in marked contrast to those of the present Upper Murrumbidgee. The latter has been rejuvenated in consequence of the uplift, and has cut down a comparatively recent gorge through its former mature bed. The old valley forms the diagonal of a quadrilateral formed by Bridle Creek and Slack's Creek on the west and east, and the Murrumbidgee and the Adaminaby road on the north and south respectively. The old river joined Slack's Creek or its south-flowing ancestor just south of the Adaminaby road, and thereafter flowed to the S.W., crossing the site of the present divide just a little to the west of the Dalgety road. The valley now known as Dairyman's Plain was probably a tributary.

With regard to the other part of the Murrumbidgee, north of Mittagang, there is less certainty. At the time of the uplift the country was in a state of very mature erosion; the dividing ridges between the broad meridional valleys had been considerably worn down and there was doubtless



much anastomosing in the river system. The probable main features of the drainage are indicated in the map (fig. 2). The mature valley now occupied by Pilot Creek marks the course of a stream which flowed across the line of the present river at Mittagang, and S.E. along the dry valley in which is the present Mittagang road, thence south of Tillabudgery Trig. Station, across the racecourse, along the valley just west of Bushy Hill, and then probably into the valley of the present Cooma Creek. This old Pilot Creek valley is marked by the remnants of a basalt flow throughout its entire length. To this valley there is a tributary dry valley starting at a point about three-quarters of a mile east of Mittagang Bridge, and running a little east of north parallel to the present Murrumbidgee to within a short distance of the S-bend in that river. This valley is cut pretty deeply into the schists and gneisses, but is fairly mature: it is now tapped and drained into the Murrumbidgee by Butler's Creek and another small creek further north.

It is extremely unlikely that the old Murrumbidgee should have flowed south through the Berridale fault-block along its present very youthful channel. More probably it originally flowed S.E. in the present channel of the Umaralla for some distance, then south along the valley of the present Rock Flat Creek, and so on to join the Snowy River.<sup>1</sup> When the tilting and other earth-movements occurred the direction of flow was reversed and the now north-flowing Murrumbidgee began to head back towards the south. At the S-bend for some reason or another it commenced to cut into the fault escarpment, and a new stream was formed which cut across Pilot Creek, captured its head-waters, and converted the southern portion of its bed into a dry valley.

---

<sup>1</sup> An alternative suggestion is that the river flowed through the dry valley between the S-bend and Mittagang, and down southwards through the Mittagang road valley (see Fig. 2).

How the east-flowing part of the river came into being is undoubtedly puzzling. The presence of conspicuous jointing in a direction nearly east and west, already noted, may indicate an east and west fault or buckle along the line of the river. At all events there is a downward slope from the divide to the river.

It is a noteworthy fact that while some of the valleys, as for example those of Pilot Creek and of the old Murrumbidgee south of McCarty's Crossing, are marked by flows of basalt, others such as Dairyman's Plain and the valley between Mittagang and the S-bend are quite free from basalt. It may be that certain of the valleys were more conveniently placed than others with regard to the centres of eruption, for flooding with lava.

From the depth to which the relatively mature valleys such as that of Pilot Creek have been eroded in the Berri-dale fault-block, and the fact that this valley when it emerges along the Mittagang road from the fault-block suffers no change of level, and from consideration of the fact that the valley between Mittagang Bridge and the S-bend is at its northern end on about the same level as the topmost alluvial terrace at the bend, one is inclined to believe that the fault-block rose very gradually, the erosion of the southward-flowing stream keeping pace with the elevation, until the formation of the new divide tilted the country down somewhat towards the north and caused the formation of the present Murrumbidgee gorge through the fault-block. It is probable that the upheaval which caused the present divide gave the country a bit of a tilt to the north-east.

*Age of the basalts.*—A very interesting question is raised by the foregoing discussion, with reference to the exact period of outpouring of the basalts. Such basaltic elevations as Tillabudgery and The Brothers probably antedated

the present Monaro peneplain. It was thought that they might have been centres of eruption, but no evidence has been found to confirm such a view. Now if these are really residuals, it follows that the extrusion of basalt which formed them must have occurred prior to the evolution of the present topography.

Again the Murrumbidgee near the mouth of Bridle Creek is seen to flow between banks which are of slate capped by basalt, as if an old valley had existed which had been filled with lava, and the rejuvenated river had cut through this and down considerably below the level of the former stream-bed.

On the other hand the basalt existing in the Mittagang road valley and that of Pilot Creek must have been extruded subsequent to the formation of these valleys, that is to say, subsequent to the uplift of the Berridale fault-block. In addition to this, the basalt hills are often terraced, denoting a succession of flows, and in various places one finds a flow of perfectly fresh and recent-looking basalt on top of an earlier and much decomposed one.

While therefore there has been no definite field evidence made available, it seems at least possible from the above considerations that the extrusions of lava, which were doubtless connected with the earth-movements, were prolonged over a considerable period or may belong to two widely separated epochs; they may even have lasted into recent geological times. Petrological work on the basalts may do something towards the elucidation of this question, and further field-work may also help to settle the matter.

No decisive evidence as to foci of eruption was discovered. It is thought that one focus may have been the head of Pilot Creek, where the valley is abruptly terminated by the scarp of a basaltic platform raised to a height of about 250 feet above the level of the valley. Of course the out-

pourings may have been in the nature of fissure-eruptions, and the absence of tuffs renders this highly probable.

*Lakes.*—Mr. Süssmilch<sup>1</sup> ascribes the numerous small lakes which indent the surface of the country to warping of the earth's crust as a result of the movements of elevation. They seem to be most naturally associated with the formation of the present main divide, as they occur mostly in a belt about 4 miles wide lying along and to the north of the divide. In the case of Arable Lake it seems possible that its formation was due to ponding of the headwaters of Arable Creek by the upraising of the divide.

#### EXPLANATION OF PLATES.

Plate II.—Geological Map of the Cooma District, N.S. Wales.

Plate III.—Fig. 1. Phyllites in Slack's Creek due west of "Kiaora," showing dip towards the east, and jointing in a direction E. 10° N.

Fig. 2. Dykes of pegmatite intersecting amphibolite, in Cooma town.

Plate IV.—Fig. 3. Outcrop of intensely crushed quartz-porphry at Bunyan. Note the cleavage that has been developed.

Fig. 4. Wallaby Rocks, on the Murrumbidgee, about  $1\frac{1}{2}$  miles up the river from Mittagang Bridge. Note the youthful character of the gorge. The banks are composed of schist mainly.

Plate V.—Fig. 5. The northern portion of the S-bend, Murrumbidgee River, looking a little west of south down the U-shaped dry valley in the Berridale fault-block.

Fig. 6. Another view of the S-bend, looking east, and showing the river emerging from the fault-block. Observe the fault-scarp in the background.

---

<sup>1</sup> *Loc. cit. sup.*

THE OXIDATION OF SUCROSE BY POTASSIUM  
PERMANGANATE.

By C. W. R. POWELL.

Science Research Scholar, University of Sydney.

(Communicated by Prof. FAWSITT.)

[*Read before the Royal Society of N. S. Wales, July 1, 1914.*]

ATTENTION has been drawn at various times to the reaction which ensues when potassium permanganate is added to an acid solution of sucrose. The reaction, which for certain concentrations is very rapid, results in the formation of manganese and potassium salts and various organic acids, but there is not general agreement as to the nature of the acids produced. In most cases it is probable that saccharic and tartaric acids are produced, while oxalic, citric, formic, carbonic and other acids are also formed under suitable conditions.<sup>1</sup> Maumené<sup>2</sup> has found that acids having the formulae,  $C_{12}H_{12}O_{14}$ ,  $C_{12}H_{12}O_{16}$  and  $C_6H_6O_6$  are also formed.

It was noticed by the author that this reaction between sucrose and potassium permanganate in acid solution did not proceed at a constant rate, but that the velocity of reaction gradually increased as the reaction proceeded. The increase in the velocity "constants" was noticed whether the calculation of the constants took place according to the first or second order formulæ. This could only be explained by supposing that either subsidiary reactions exerted a growing influence as the reaction proceeded or that some substance was being formed which had an accelerative effect on the main reaction, which consists of the splitting up of the molecules of sucrose and potassium

---

<sup>1</sup> Chem. News, 72, 257, 1895.    <sup>2</sup> C.R., 1895, 783.

permanganate. This investigation was carried out in order to throw some light on this point as well as to decide the order of the reaction, and to ascertain to what extent the concentration of the acid influenced the velocity of reaction.

*Method.*—The reaction proceeds in acid, neutral or alkaline solution, the rate being slowest in a neutral solution, and increasing with the addition of either acid or alkali. If the solution is not sufficiently acid, however, a dark precipitate is thrown down consisting in all probability mainly of manganese peroxide. This is no doubt the substance referred to by Maumené, who stated that in this reaction the permanganate was reduced to sesquioxide or a mixture of  $MnO_2$  and  $MnO$ , or a combination of both. The stage to which the reaction had advanced at different times was determined by running a measured volume of the reaction mixture into an excess of ferrous ammonium sulphate and then determining the excess by titration against dilute potassium permanganate solution. This method being adopted, the formation of manganese peroxide in the reaction mixture was undesirable as manganese peroxide and sulphuric acid (which was the acid used to acidify the solution) liberate oxygen which would interfere with the titration of the ferrous ammonium sulphate. For this reason the greater number of the determinations were made in solutions sufficiently acid to prevent the precipitation of manganese peroxide.

In the actual experiments 5 ccs. of the reaction mixture were run into 5 ccs. of 0.5 per cent. solution of ferrous ammonium sulphate made acid with about 4 ccs. of 5 normal sulphuric acid. This immediately checked the reaction at a time noted on a stop watch. The excess of ferrous ammonium sulphate was then determined by titration against potassium permanganate (about 0.0031 normal).

**Calculation of velocity constants.**

For the calculation of constants as for a reaction of the first order the equation

$$k = \frac{2.3}{t} \log \frac{b}{(b-x)}$$

was used and for constants as for a reaction of the second order, the equation

$$k = \frac{2.3}{t(a-b)} \log \frac{(a-x)b}{(b-x)a}$$

where  $a$  is the initial concentration of sucrose,  $b$  the initial concentration of potassium permanganate and  $x$  the amount of potassium permanganate decomposed in the time  $t$  minutes. Concentrations are expressed throughout in terms of normality; and the values of  $x$  are given by

$$x = \frac{(n_t - n_o)}{(n_x - n_o)} \cdot b$$

where  $n$  is the number of ccs. of permanganate solution required to neutralise the excess of ferrous ammonium sulphate, after running in 5 ccs of the reaction mixture and  $b$  is as above;  $x$  is thus obtained by determination of the permanganate. The sucrose was not determined at all stages but for the calculation of the second order constants, the assumption was made that this reaction takes place between one molecule of sucrose and one molecule of potassium permanganate.

**The order of the reaction.**

As already stated the reaction does not proceed at a constant rate, so that the determination of the order of the reaction could not be very satisfactorily calculated from the results of experiments made with solutions containing only those substances necessary for the reaction. It was subsequently found, as will be shown in a later paragraph, that the addition of a suitable amount of manganese sulphate to the reaction mixture causes the reaction to proceed at a much more uniform rate. This substance was therefore employed in the following experiments and the results indicate that the reaction involved is of the second order.

1. Concentration of sulphuric acid  $\cdot 58$  N. Concentration of manganese sulphate  $\cdot 017$  N. (a)  $\cdot 0731$  N.; (b)  $\cdot 0113$  N. Temperature  $15^\circ$  C.

$t$	$n$	$x$	$(a-x)$	$(b-x)$	$k_1$	$k_2$
...	3.7	...	$\cdot 0731$	$\cdot 0113$	...	...
5	11.2	$\cdot 0054$	$\cdot 0677$	$\cdot 0059$	$\cdot 132$	$\cdot 000185$
7	13.1	$\cdot 0067$	$\cdot 0664$	$\cdot 0046$	$\cdot 129$	$\cdot 000185$
11	15.0	$\cdot 0081$	$\cdot 0650$	$\cdot 0032$	$\cdot 114$	$\cdot 000168$
16	16.8	$\cdot 0094$	$\cdot 0637$	$\cdot 0019$	$\cdot 110$	$\cdot 000166$
22	18.2	$\cdot 0104$	$\cdot 0627$	$\cdot 0009$	$\cdot 115$	$\cdot 000175$
$\infty$	19.5	$\cdot 0113$	$\cdot 0618$	...		

$k_1$  = velocity constant (first order).  $k_2$  = velocity constant (second order).

2. In the second experiment the concentration of sucrose was halved.

Concentration of sulphuric acid  $\cdot 58$  N. Concentration of manganese sulphate  $\cdot 017$  N. (a)  $\cdot 0365$  N.; (b)  $\cdot 0113$  N. Temp.  $15^\circ$  C.

$t$	$n$	$x$	$(a-x)$	$(b-x)$	$k_1$	$k_2$
...	4.3	...	$\cdot 0365$	$\cdot 0113$	...	...
3	8.3	$\cdot 0022$	$\cdot 0343$	$\cdot 0091$	$\cdot 0719$	$\cdot 000204$
5	10.2	$\cdot 0032$	$\cdot 0333$	$\cdot 0081$	$\cdot 0674$	$\cdot 000191$
7	11.6	$\cdot 0040$	$\cdot 0325$	$\cdot 0073$	$\cdot 0625$	$\cdot 000182$
10	13.4	$\cdot 0050$	$\cdot 0315$	$\cdot 0063$	$\cdot 0582$	$\cdot 000173$
15	16.0	$\cdot 0064$	$\cdot 0301$	$\cdot 0049$	$\cdot 0559$	$\cdot 000170$
20	17.9	$\cdot 0074$	$\cdot 0291$	$\cdot 0039$	$\cdot 0539$	$\cdot 000166$
30	20.7	$\cdot 0090$	$\cdot 0275$	$\cdot 0023$	$\cdot 0528$	$\cdot 000173$
40	22.5	$\cdot 0100$	$\cdot 0265$	$\cdot 0013$	$\cdot 0537$	$\cdot 000183$
$\infty$	24.9	$\cdot 0113$	$\cdot 0252$	...		

3. In the third experiment the concentration of potassium permanganate was halved.

Concentration of sulphuric acid  $\cdot 58$  N. Concentration of manganese sulphate  $\cdot 017$  N. (a)  $\cdot 0731$  N.; (b)  $\cdot 0056$  N. Temp.  $15^\circ$  C.

$t$	$n$	$x$	$(a-x)$	$(b-x)$	$k_1$	$k_2$
...	15.4	...	$\cdot 0731$	$\cdot 0056$	...	...
3	19.0	$\cdot 0019$	$\cdot 0712$	$\cdot 0037$	$\cdot 0138$	$\cdot 000191$
5	21.0	$\cdot 0030$	$\cdot 0701$	$\cdot 0026$	$\cdot 0150$	$\cdot 000215$
7	22.0	$\cdot 0035$	$\cdot 0696$	$\cdot 0021$	$\cdot 0139$	$\cdot 000197$
10	23.2	$\cdot 0041$	$\cdot 0690$	$\cdot 0015$	$\cdot 0133$	$\cdot 000187$
15	24.2	$\cdot 0046$	$\cdot 0685$	$\cdot 0010$	$\cdot 0118$	$\cdot 000164$
$\infty$	26.0	$\cdot 0056$	$\cdot 0675$	...		



4. In the fourth experiment the concentrations of both sucrose and potassium permanganate were halved.

Concentration of sulphuric acid .58 N. Concentration of manganese sulphate .017 N. (a) .0365 N.; (b) .0056 N. Temp. 15° C.

$t$	$n$	$x$	$(a-x)$	$(b-x)$	$k_1$	$k_2$
...	15.1	...	.0365	.0056	...	...
5	18.0	.0016	.0349	.0040	.0672	.000188
7	18.9	.0021	.0344	.0035	.0671	.000190
11	20.3	.0029	.0336	.0027	.0676	.000190
13	20.9	.0033	.0332	.0023	.0677	.000198
20	22.0	.0039	.0326	.0017	.0596	.000175
$\infty$	25.0	.0056	.0309	...		

If this reaction is one of the second order, the velocity constant may be written

$$k = \frac{1}{t(a-b)} \cdot \log \cdot \frac{(a-x)}{(b-x)} \frac{b}{a}$$

so that  $t$ , the time taken for any definite amount of the reaction to proceed may be written

$$t = \frac{1}{k(a-b)} \cdot \log \cdot \frac{(a-x)}{(b-x)} \frac{b}{a}$$

From this equation it can be calculated that if  $a$ , the concentration of sucrose is halved, the time the reaction takes to proceed half-way should roughly double itself; if  $b$  the concentration of potassium permanganate is halved, the time taken to proceed half-way should remain the same; and if both  $a$  and  $b$  are halved the time taken to proceed half-way should be roughly double the time taken before dilution.

That this is the case with the reaction in question is shown by the following figures collected from the foregoing tables:—

Concentration of sucrose (a).	Concentration of pot. permg. (b).	Time taken to proceed half-way.
.0731	.0113	5½ mins.
.0365	.0113	12 "
.0731	.0057	5 "
.0365	.0057	10 "

From this table it may be seen that on halving  $a$ ,  $t$  was found to double; on halving  $b$ ,  $t$  did not alter, while on halving both  $a$  and  $b$ ,  $t$  again doubled: the combined results justifying the designations of the reaction as one of the second order.

**The influence of sulphuric acid on the reaction.**

In preliminary experiments it was found that the concentration of sulphuric acid in the solution had a considerable influence on the rate of reaction. A series of experiments was therefore carried out in which the concentration of the acid was varied from 1.16 normal to 0.058 normal. Determinations were made at 5° C. and 15° C. and the sucrose was maintained in considerable excess in order to minimise the influence of subsidiary reactions. The concentration of sucrose and potassium permanganate remained constant throughout the series.

Sucrose (a) .0731 N. Potassium Permanganate (b) .0113 N.

5. Temperature 5° C. Sulphuric acid .29 N.

$t$	$n$	$x$	$(a-x)$	$(b-x)$	$k_1$	$k_2$
...	6.2	...	.0731	.0113	...	...
53	7.1	.0007	.0724	.0106	.0012	.0000017
70	8.2	.0016	.0715	.0097	.0021	.0000030
84	8.6	.0019	.0712	.0094	.0022	.0000030
105	9.3	.0024	.0707	.0089	.0023	.0000032
129	10.7	.0035	.0696	.0078	.0029	.0000043
$\infty$	20.7	.0113	.0618	...		

6. Temperature 5° C. Sulphuric acid .58 N.

$t$	$n$	$x$	$(a-x)$	$(b-x)$	$k_1$	$k_2$
...	6.1	...	.0731	.0113	...	...
35	6.8	.0005	.0726	.0108	.0013	.0000018
45	7.3	.0009	.0722	.0104	.0018	.0000025
60	8.6	.0019	.0712	.0094	.0030	.0000043
70	10.2	.0030	.0701	.0083	.0045	.0000062
83	11.6	.0041	.0690	.0072	.0054	.0000077
97	13.4	.0054	.0677	.0059	.0067	.0000096
110	14.4	.0061	.0670	.0052	.0071	.0000102
123	16.3	.0075	.0656	.0038	.0089	.0000129
$\infty$	21.4	.0113	.0618	...		

## 7. Temperature 5° C. Sulphuric acid 1.16 N.

$t$	$n$	$x$	$(a-x)$	$(b-x)$	$k_1$	$k_2$
...	6.3	...	.0731	.0113	...	...
4	6.4	.0001	.0730	.0112	.0016	.00000307
14	6.6	.0002	.0729	.0111	.0014	.00000176
29	7.6	.0010	.0721	.0103	.0030	.00000440
41	9.3	.0022	.0709	.0091	.0054	.00000733
45	9.9	.0026	.0705	.0087	.0059	.00000810
56	12.4	.0045	.0666	.0068	.0090	.0000128
61	14.2	.0058	.0672	.0055	.0118	.0000134
66	15.6	.0068	.0663	.0043	.0140	.0000213
75	17.9	.0085	.0646	.0026	.0186	.0000290
84	19.5	.0097	.0634	.0014	.0231	.0000374
$\infty$	21.7	.0113	.0618	...		

## 8. Temperature 15° C. Sulphuric acid .29 N.

$t$	$n$	$x$	$(a-x)$	$(b-x)$	$k_1$	$k_2$
..	6.2	...	.0731	.0113	...	...
37	9.8	.0027	.0704	.0086	.00737	.0000112
44	11.3	.0038	.0693	.0075	.0093	.0000131
55	13.6	.0055	.0676	.0058	.0102	.0000173
63	16.5	.0077	.0654	.0036	.0179	.0000265
68	17.8	.0086	.0645	.0027	.0211	.0000311
76	19.6	.0100	.0631	.0013	.0298	.0000429
$\infty$	21.4	.0113	.0618	...		

## 9. Temperature 15° C. Sulphuric acid .58 N.

$t$	$n$	$x$	$(a-x)$	$(b-x)$	$k_1$	$k_2$
...	6.0	...	.0731	.0113	...	...
12	7.1	.0008	.0723	.0105	.0061	.0000084
22	8.4	.0018	.0713	.0095	.0077	.0000109
32	11.4	.0040	.0691	.0073	.0136	.0000192
39	13.1	.0052	.0679	.0061	.0160	.0000226
47	15.5	.0070	.0661	.0043	.0205	.0000298
57	18.2	.0090	.0641	.0023	.0279	.0000412
$\infty$	21.3	.0113	.0618	...		

## 10. Temperature 15° C. Sulphuric acid 1.16 N.

$t$	$n$	$x$	$(a-x)$	$(b-x)$	$k_1$	$k_2$
...	5.9	...	.0731	.0113	...	...
3	6.6	.0005	.0726	.0108	.0152	.0000207
6	7.1	.0009	.0722	.0104	.0132	.0000195
12	7.8	.0014	.0717	.0099	.0107	.0000153
16	8.8	.0020	.0711	.0093	.0127	.0000169
20	11.1	.0038	.0693	.0075	.0201	.0000288
23	13.3	.0053	.0678	.0060	.0277	.0000392
25	14.9	.0065	.0666	.0048	.0340	.0000494
27	16.4	.0076	.0655	.0037	.0409	.0000603
29	17.9	.0087	.0644	.0026	.0498	.0000748
31	18.9	.0094	.0637	.0019	.0567	.0000858
$\infty$	21.6	.0113	.0618	...		

The acid concentrations so far employed were all sufficient to prevent the separation of manganese peroxide. In some of the following experiments, however, manganese peroxide was precipitated, but the results are nevertheless interesting since they indicate the direction in which the reaction tends to go at lower acid concentrations.

11. Temperature 15° C. Sulphuric acid ·15 N.

$t$	$n$	$x$	$(a-x)$	$(b-x)$	$k_1$	$k_2$
...	7·2	...	·0731	·0113	...	...
17	7·3	·0001	·0730	·0112	·0005	·00000072
51	9·2	·0017	·0714	·0096	·0032	·00000442
60	9·9	·0023	·0708	·0090	·0037	·00000527
74	11·3	·0035	·0696	·0078	·0049	·00000703
81	12·4	·0044	·0687	·0069	·0061	·00000859
92	13·6	·0054	·0677	·0059	·0070	·0000100
101	14·8	·0064	·0667	·0049	·0083	·0000119
$\infty$	20·6	·0113	·0618	...		

12. Temperature 15° C. Sulphuric acid ·058 N.

$t$	$n$	$x$	$(a-x)$	$(b-x)$	$k_1$	$k_2$
...	6·2	...	·0731	·0113	...	...
25	7·3	·0009	·0722	·0104	·0030	·00000457
50	7·9	·0013	·0718	·0100	·0025	·00000337
74	9·1	·0022	·0709	·0091	·0030	·00000406
94	10·3	·0032	·0699	·0081	·0035	·00000496
106	11·2	·0039	·0692	·0074	·0040	·00000562
127	12·6	·0050	·0681	·0063	·0045	·00000712
$\infty$	20·8	·0113	·0618	...		

The reaction between sucrose and potassium permanganate is very complex, as indicated by the variety of products obtained, and it is very probable that the number of subsidiary reactions increases as the reaction proceeds. In any case, their influence on the velocity of reaction would gradually become more marked owing to the gradual decrease in the concentration of sucrose and potassium permanganate, and for this reason the velocities for different acid concentrations were compared at a stage as near to the commencement of the reaction as was possible.

In the following table are given the velocities at which the reaction proceeded for various concentrations of sulphuric acid, when one eighth of the total permanganate had been decomposed. The initial and final velocities are also included in order to give a more general idea of the influence of the acid concentration.

Table A.—*Influence of the acid concentration on the velocity of reaction at 5° C.*

Acid conc.	Velocity of reaction (second order constants).		
	One-eighth.	Initial.	Final.
·29 N.	·0000026	·0000017	·0000043
·58 „	·0000033	·0000018	·0000129
1·16 „	·0000054	·0000091	·0000374

Table B.—*Influence of the acid concentration on the velocity of reaction at 15° C.*

Acid conc.	Velocity of reaction (second order constants).		
	One-eighth.	Initial.	Final.
·058 N.	·0000034	·00000046	·0000071
·15 „	·0000039	·00000070	·0000119
·29 „	·0000050	·0000012	·0000206
·58 „	·000010	·000008	·0000412
1·16 „	·000016	·000021	·0000860

At 15° C. the effect of increasing the acid concentration is to increase the velocity constant at all stages to roughly the same extent, and to increase the final rate to almost exactly the same extent. This is especially so with the higher acid concentrations, the figures referred to being:—

Acid conc.	Velocity ( <i>k</i> ) near end-point.
·29 N.	·000021
·58 „	·000041
1·16 „	·000086

The inference drawn from these experiments was that the velocity of reaction depended directly upon the hydrogen ion concentration, but that the nature of the reaction was little changed by varying that concentration. In order to

confirm the latter conclusion the course of the reaction was studied more closely by noting the time that any particular reaction took to reach some definite stage, say one-eighth or one-sixth of the total decomposition.

Table C.—*Influence of the acid concentration on the velocity of reaction.*

Acid conc.	5° C.		
	Time taken to decompose.		
	One-eighth.	One-sixth.	One-half.
.29 N.	75	90	170
.58 „	53	61	102
1.16 „	31	39	60
	15° C.		
.058 N.	52	64	...
.15 „	46	53	94
.29 „	...	...	56
.58 „	18	23	41
1.16 „	12	15	24

If, as concluded, the nature of the reaction is not altered by varying the concentration of sulphuric acid in the solution, then the increase in the velocity of reaction caused by increasing the hydrogen ion concentration should be the same at any stage of the reaction. An examination of Table C. showed this to be the case, and the fact was made much clearer by expressing the relation between the figures for different experiments as in Table D, where the increase in the velocity of reaction caused by increasing the acid concentration from .58 N. to 1.16 N. is expressed by dividing the time taken to decompose a definite fraction of the whole at the lower concentration by the time taken to decompose a similar amount at the higher acid concentration.

Table D.

Temperature ° C.	Stage at which reactions compared.		
	One-eighth.	One-sixth.	Half-way.
5	1.71	1.56	1.71
15	1.50	1.53	1.71

Furthermore, if the conclusion arrived at be correct, the rate at which the velocity of reaction increases in any one experiment should not be altered by varying the acid concentration, and this was found to be the case as is shown in Table E, where the increase in the velocity of reaction is expressed by dividing the time taken to decompose one-half of the potassium permanganate by the time taken to decompose one-eighth.

Table E.

Acid conc.	Temperature of experiment.	
	5° C.	15° C.
.58 N.	1.94	2.26
1.16 ,,	1.94	2.00

These figures as well as those in Table D are very satisfactory and give added weight to the conclusions already drawn, namely that the velocity of reaction depends on the hydrogen ion concentration and that the nature of the reaction is independent of such concentration, the rate at which the velocity of reaction ( $k$ ) increases, in any one experiment, being the same for any acid concentration, provided that it is not below the concentration necessary for the liberation of oxygen according to the equation:



#### **Influence of subsidiary reactions on the velocity of reactions.**

An examination of the figures for any of the experiments given in the foregoing section will show that the velocity of reaction is not constant but increases until the end point is reached. This may be explained by supposing that secondary reactions proceed, in which the products of decomposition of sucrose are further decomposed, or that some substance is formed which exerts an accelerative influence on the main reaction.

One side reaction that must necessarily take place to a certain extent, is the inversion of sucrose by sulphuric acid,

yielding glucose and fructose. As these two sugars have much simpler molecules than sucrose a quicker reaction with potassium permanganate might be expected, and this was experimentally found to be the case.

The following experiment was performed under similar conditions to the previous experiments, the concentrations employed being as follows:—

	Concentration of glucose	...	...	(a)	·1389	N.
	„	potassium permanganate	(b)	·0113	„	
	„	sulphuric acid	...	1·16	„	
	Temperature 15° C.					
<i>t</i>	<i>n</i>	<i>x</i>	( <i>a</i> - <i>x</i> )	( <i>b</i> - <i>x</i> )	<i>k</i> <sub>1</sub>	<i>k</i> <sub>2</sub>
...	7·1	...	·1389	·0113	...	...
3	10·2	·0024	·1365	·0089	·0795	·0000469
4	14·0	·0053	·1336	·0060	·160	·000116
5	17·4	·0080	·1309	·0033	·244	·000183
6	20·5	·0104	·1285	·0009	·326	·000320
∞	21·7	·0113	·1276	...		

For a solution of sucrose of acid concentration 1·16 N. the amount of inversion which would proceed in 20 minutes (roughly the time taken for complete decomposition for the concentrations given) at 15° C. would be about one-twentieth of the total sucrose, so that for strongly acid solutions the velocity of reaction would be slightly increased as the reaction proceeded, owing to the faster rate of decomposition of the sugars formed.

However, in most of the later experiments, where the rate was considerably increased by the addition of various reagents, the time taken for total decomposition seldom exceeded twenty minutes, so that for the greater number of the experiments the influence of the greater activity of the reducing sugars upon the velocity of reaction may be neglected.

Another of the main products of the reaction is manganese sulphate, and it was thought possible that this



substance might act as an accelerator. The following experiments were therefore made, the concentrations employed being:—

Sucrose	...	...	(a)	·0731 N.
Potassium permanganate	(b)	·0113	„	
Sulphuric acid	...	}	varied	
Mang. Sulphate	...			
Temperature 15° C.				

14. Temperature 15° C. Sulphuric acid ·29 N. Manganese sulphate ·0008 N.

$t$	$n$	$x$	$(a-x)$	$(b-x)$	$k_1$	$k_2$
...	6·8	...	·0731	·0113	...	...
15	8·2	·0012	·0719	·0101	·0072	·0000103
22	9·6	·0024	·0707	·0089	·0104	·0000151
31	11·3	·0037	·0694	·0076	·0128	·0000180
35	12·0	·0043	·0688	·0070	·0136	·0000195
41	12·9	·0050	·0681	·0063	·0143	·0000203
45	13·9	·0059	·0672	·0054	·0164	·0000235
51	14·9	·0067	·0664	·0046	·0175	·0000254
55	15·8	·0076	·0655	·0037	·0194	·0000296
60	16·9	·0084	·0647	·0029	·0222	·0000334
$\infty$	20·5	·0113	·0618	...		

15. Temperature 15° C. Sulphuric acid ·29 N. Manganese sulphate ·004 N.

$t$	$n$	$x$	$(a-x)$	$(b-x)$	$k_1$	$k_2$
...	7·8	...	·0731	·0113	...	...
9	11·8	·0037	·0694	·0076	·044	·0000620
14	14·7	·0064	·0667	·0049	·060	·0000859
22	17·2	·0087	·0644	·0026	·067	·0000987
27	18·1	·0095	·0636	·0018	·069	·0001020
$\infty$	20·0	·0113	·0618	...		

Under similar conditions the velocity of reaction of a solution with an acid concentration of ·29 N., but containing no manganese sulphate was

$t$	$n$	$x$	$(a-x)$	$(b-x)$	$k_1$	$k_2$
...	6·9	...	·0731	·0113	...	...
9	6·95	·0001	·0730	·0112	·0010	·0000011
34	8·8	·0016	·0715	·0097	·0044	·0000062
44	10·0	·0026	·0705	·0087	·0058	·0000083
54	11·6	·0039	·0692	·0074	·0078	·0000110
58	12·2	·0044	·0687	·0069	·0084	·0000120
62	13·7	·0056	·0675	·0057	·0110	·0000158
72	14·9	·0066	·0665	·0047	·0121	·0000176
79	16·1	·0076	·0655	·0037	·0141	·0000206
$\infty$	20·6	·0113	·0618	...		

The effect of manganese sulphate as indicated by these experiments is to considerably increase the initial velocity of reaction. A comparison was made between the figures by tabulating the times taken to decompose definite fractions for the various concentrations of manganese sulphate.

Table F.

Concentration of MnSO <sub>4</sub> .	Time taken to proceed (at 15° C.)		
	One-eighth.	One-sixth.	Half-way.
·0000	31	37	63
·0008 N.	17	20	45
·0040 „	(3)	(4)	12

The velocity of reaction, however, still increases as the reaction proceeds, although not to the same extent as when no manganese sulphate is present. A more complete series of experiments was made with solutions having an acid concentration of ·58 N. in which the addition of manganese sulphate was continued until no further accelerative effect was obtained.

16. Temperature 15° C. Sulphuric acid ·58 N. Manganese sulphate ·0008 N.

<i>t</i>	<i>n</i>	<i>x</i>	( <i>a</i> - <i>x</i> )	( <i>b</i> - <i>x</i> )	<i>k</i> <sub>1</sub>	<i>k</i> <sub>2</sub>
...	6·3	...	·0731	·0113	...	...
5	6·5	·0001	·0730	·0112	·0018	·0000025
15	10·2	·0031	·0700	·0082	·0208	·0000299
18	11·2	·0038	·0693	·0075	·0229	·0000320
22	12·6	·0049	·0682	·0064	·0253	·0000367
27	14·7	·0066	·0665	·0047	·0320	·0000468
41	19·1	·0099	·0632	·0014	·0522	·0000766
∞	20·8	·0113	·0618	...		

17. Temperature 15° C. Sulphuric acid ·58 N. Manganese sulphate ·004 N.

<i>t</i>	<i>n</i>	<i>x</i>	( <i>a</i> - <i>x</i> )	( <i>b</i> - <i>x</i> )	<i>k</i> <sub>1</sub>	<i>k</i> <sub>2</sub>
...	5·3	...	·0731	·0113	...	...
1	5·35	·0001	·0730	·0112	·0090	·0000123
3	6·2	·0007	·0724	·0106	·0210	·0000293
6	9·0	·0028	·0703	·0085	·0471	·0000662
8	10·4	·0036	·0693	·0075	·0518	·0000720
12	12·9	·0058	·0673	·0055	·0588	·0000858
16	15·2	·0074	·0657	·0039	·0676	·0000967
20	17·1	·0090	·0641	·0033	·0772	·000118
∞	20·3	·0113	·0618	...		

18. Temperature 15° C. Sulphuric acid .58 N. Manganese sulphate .008 N.

$t$	$n$	$x$	$(a-x)$	$(b-x)$	$k_1$	$k_2$
...	4.9	...	.0731	.0113	...	...
5.5	9.3	.0033	.0698	.0080	.063	.0000880
12	13.8	.0066	.0665	.0047	.073	.000106
16	16.0	.0082	.0649	.0031	.082	.000119
25	18.5	.0101	.0630	.0012	.090	.000135
$\infty$	20.1	.0113	0618	...		

19. Temperature 15° C. Sulphuric acid .58 N. Manganese sulphate .017 N.

$t$	$n$	$x$	$(a-x)$	$(b-x)$	$k_1$	$k_2$
...	3.7	...	.0731	.0113	...	...
5	11.2	.0054	.0677	.0059	.132	.000185
7	13.1	.0067	.0664	.0046	.129	.000185
11	15.0	.0081	.0650	.0032	.114	.000168
16	16.8	.0094	.0637	.0019	.110	.000166
22	18.2	.0104	.0627	.0009	.115	.000175
$\infty$	19.5	.0113	.0618	...		

20. Temperature 15° C. Sulphuric acid .58 N. Manganese sulphate .034 N.

$t$	$n$	$x$	$(a-x)$	$(b-x)$	$k_1$	$k_2$
...	5.2	...	.0731	.0113	...	...
4	14.0	.0052	.0679	.0061	.153	.000219
8	16.5	.0066	.0665	.0047	.111	.000159
9	17.0	.0069	.0662	.0044	.106	.000152
12	18.6	.0079	.0652	.0034	.097	.000146
17	21.0	.0093	.0638	.0020	.102	.000152
22	21.6	.0097	.0634	.0016	.088	.000135
$\infty$	24.3	.0113	.0618	...		

The velocities of reaction for these experiments are compared in the following table:—

Table G.

Concentration of $MnSO_4$ .	Time taken (at 15° C.) to proceed.		
	One-eighth.	One-sixth.	Halfway.
.0000	18	23	41
.0008 N.	10	11	24
.004 „	4	5	12
.008 „	2	3	10
.017 „	1	1.7	5
.034 „	1	1.6	5

In the first of these experiments, where no manganese sulphate was present, the velocity increased throughout the reaction and the difference between initial and final velocities was fairly large. As manganese sulphate was added the increase in the velocity throughout the reaction gradually lessened, until, when the concentration of manganese sulphate had reached  $\cdot 017$  N., the velocity became practically constant; the difference between initial and final velocities being only  $\cdot 00001$  (second order). On further addition of manganese sulphate the velocity no longer increased, and instead of showing an increase throughout the reaction, a slight decrease was obtained.

This showed that the maximum effect for the complete reaction was obtained when the concentration of manganese sulphate was  $\cdot 017$  N., and it is interesting to note that this figure represents little more than the amount of manganese sulphate that would have been formed by the potassium permanganate and sulphuric acid originally present in the solution. The figures in Table G. show clearly that the velocity of reaction is not increased on further addition of manganese sulphate after the concentration of this salt has reached  $0\cdot 017$  N.

The conclusion may therefore be drawn that the acceleration obtained in those experiments in which no manganese sulphate is used, is due to the formation of this salt as the reaction proceeds, especially so since it has here been proved that if the amount of manganese sulphate that the potassium permanganate and sulphuric acid in the solution would finally form, be added at the commencement of the reaction, a fairly constant velocity of reaction is obtained.

This power possessed by manganese sulphate to accelerate certain reactions has previously been noticed and in some cases its presence is necessary for the reaction to proceed. Harcourt<sup>1</sup> refers to the case of the oxidation of

---

<sup>1</sup> Chem. News, x, 171, 1864.

sulphurous acid, stating that "Sulphurous acid, as is well known, when mixed with a large bulk of water which has been exposed to the air, is but slowly oxidised and the change proceeds still more slowly if the solution is freely acidified. If, however, a minute quantity of manganese sulphate is added the oxidation of the sulphurous acid is at once determined." He then supposes that if the water can act to a small extent upon the manganese salt, as it acts upon a bismuth salt, that is, separate the base from the acid, then, no doubt, the hydrate of manganese thus displaced would absorb free oxygen and the sulphurous acid would at once again reduce the peroxide formed. Without insisting on this definite hypothesis, he thinks it is probable that this action of the manganese salt is in some way related to the fact that the protohydrate of this metal has the property of absorbing oxygen from water and parting with it again to sulphurous acid.

In a later paper in conjunction with *Elsson*,<sup>1</sup> it was found that at ordinary temperature, in a dilute and feebly acid solution, permanganic acid acts very slowly on oxalic acid, but the presence of a manganous salt formed by the reduction of the permanganic acid or previously added, caused a great acceleration. In this case the acceleration reached a maximum when three molecules of manganese sulphate were present to one of potassium permanganate:—

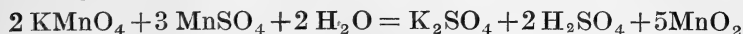

These reactions although somewhat similar, are not identical with the reaction in question, namely the oxidation of sucrose by potassium permanganate. In the latter reaction decomposition can proceed rapidly in either acid, neutral or alkaline solution, and without any previous addition of manganese sulphate. Further, this salt, when added, increases the initial rate of reaction to an extent

---

<sup>1</sup> *Proc. Roy. Soc., London*, xiv, p. 470, 1865.

proportional to the amount added, but ceases to have an accelerative effect when the amount added is equal to that which could have been produced by the potassium permanganate originally present in the solution.

#### Influence of temperature.

Temperature coefficients for 10° C. were worked out for solutions containing varying amounts of sulphuric acid. The coefficients were obtained by comparing the times taken to decompose certain fractions of the total potassium permanganate, the velocity constant being considered proportional to the time. The amount of potassium permanganate decomposed was plotted against the time the reaction had been proceeding, and the time taken for the completion of various fractions of the reaction read off from the curve thus obtained.

Table H.

Acid concentration.	Temperature. ° C.	Time taken to decompose.	
		One-tenth.	One-eighth.
·29 N.	5	67	75
	15	21·9	25·5
·58 „	5	48·5	53
	15	15	17·5
1·16 „	5	30·5	33
	15	9·5	12

Table I.—*Temperature coefficients calculated from the figures in Table H.*

Acid concentration.	Temperature coefficients calculated at	
	One-tenth.	One-eighth.
·29 N.	3·06	2·95
·58 „	3·23	3·03
1·16 „	3·21	2·75

The temperature coefficient is about the same at all concentrations and is similar to that obtained for most chemical reactions.

### Summary.

1. The oxidation of sucrose by potassium permanganate proceeds in acid, neutral or alkaline solutions; manganese peroxide being separated in the last two cases and also in solutions of low acid concentration.

2. The reaction involved is bi-molecular.

3. The reaction does not proceed at a constant rate but gradually increases until the end point is reached.

4. This increase in the velocity of reaction in any one experiment is due to the accelerative effect of manganese sulphate which is one of the products of reaction.

5. Within certain limits the concentration of sulphuric acid does not affect the nature of the reaction; but the (initial) velocity of reaction varies directly with the hydrogen ion concentration.

6. Although glucose reacts with potassium permanganate more rapidly than does sucrose it is not formed in sufficient quantity to affect the velocity constants in the reaction studied.

7. The temperature coefficient for  $10^{\circ}$  C. is about 3.0.

In conclusion I wish to express my thanks to Professor C. E. Fawsitt for his advice in connection with this investigation.

THE COMPOSITION OF SOME LIME-SULPHUR SPRAYS  
MADE ACCORDING TO RECOGNISED FORMULÆ.

By A. A. RAMSAY.

(Communicated by F. B. GUTHRIE, F.I.C., F.C.S.)

[*Read before the Royal Society of N. S. Wales, August 5, 1914.*]

THE use of lime-sulphur sprays as a fungicide and insecticide in the orchard is now very general and is steadily increasing. The term lime-sulphur has been applied to the product of boiling together lime and sulphur with water. These sprays are usually made on the orchard as they are required, and for their manufacture many and varied formulæ have been suggested both here and in America, satisfaction and efficiency having been claimed for each, presumably after actual trial in the field.

It was thought advisable, owing to the absence of specific information, to manufacture a quantity of the spray-fluid according to certain formulæ on a small scale in the laboratory, and to have these examined and analysed to ascertain what results were actually obtained by following the various methods suggested. This has been done, and the results of the investigation are here given. The mixtures examined have been prepared according to:—

Wagga Orchard Formula (a)—using  $4\frac{1}{2}$  lbs. lime, 6 lbs. sulphur, 50 gallons of water.

Farmers' and Fruit Growers' Guide Formula (b)—using 18·91 lbs. lime, 16·66 lbs. sulphur, 50 gals. water.

Illinois Formula (c)—using 15 lbs. lime, 15 lbs. sulphur, 50 gallons of water.

Dural Demonstration Orchard Formula (d)—using 40 lb. lime, 80 lb. sulphur, 50 gallons of water.

(a) As used at Wagga Farm Orchard, N.S.W. (b) Farmer's and Fruit Growers' Guide, 5th Edit., Government Printer N.S.W., 1904, page 378. (c) Agr. Gazette, N.S.W., XXI, page 643. (d) As used at Dural Demonstration Farm, N.S.W.



The boiling was done in a flask under a reflex condenser, pure lime and pure sulphur were used throughout. The methods of analysis used are those published in the Journal of Agricultural Science.<sup>1</sup>

Mayers method,<sup>2</sup> Podreschetnikoff's method,<sup>3</sup> and that of Dusserre and Vuilleumier<sup>4</sup> were tried and abandoned as unsatisfactory. The methods described by James E. Harris<sup>5</sup> were adopted with slight modifications and gave excellent results. In using sodium peroxide as an oxidising agent to convert sulphides of alkaline earths into sulphates, the method as recommended by Harris which is apparently Modrakowski's<sup>6</sup> method is as follows:—

“10 cc. of diluted solution is placed in a tall beaker, covered with a watch glass and 5 or 6 grams sodium peroxide added. After standing a few minutes hydrochloric acid is added with stirring until the solution clears up . . . . after boiling a few minutes to drive off dissolved gases the sulphur may be precipitated as barium sulphate.”

I have followed this method and have failed to obtain concordant duplicates.

The reason I find is due to the presence of higher oxidised products—chlorates, for such a solution discharges the colour from methyl-orange and from indigo. This fact has been noted by Pringsheim.<sup>7</sup>

---

<sup>1</sup> Journal Agricultural Science, Vol. vi, pt. ii, May 1914, p. 194.

<sup>2</sup> E. Dhvique-Mayer, Rev. génér. Chim. pure appl. 1908, p. 273–274. Analyst xxxiii, p. 484.

<sup>3</sup> E. Podreschetnikoff, Zeit. Farben Ind. 1907, p. 6–388. Analyst xxxiii, p. 141.

<sup>4</sup> E. Dusserre and V. Vuilleumier, Chem. Zeit., 1909, p. 33–1129. Analyst xxxiv, p. 545.

<sup>5</sup> James E. Harris, Technical Bulletin No. 6, Michigan Agricultural College, 1911.

<sup>6</sup> G. Modrakowski, Zeit. physiol. Chem. 1903, xxxviii, p. 562. Analyst xxviii, p. 321.

<sup>7</sup> H. H. Pringsheim, Berichte 1903, xxxii, p. 4244–4246. Analyst xxix, p. 97.

These higher oxidised products may be removed, and concordant results obtained, if the solution be reduced with a little potassium iodide, and the excess of iodine removed by boiling. With this alteration, I find the method gives excellent results.

For the determination of the total lime present I now prefer to decompose the sulphides of calcium with N/10 iodine solution, filter off the precipitate of sulphur and determine lime in the filtrate as usual by ammonium oxalate. The method gives excellent results and obviates the necessity of doing a blank determination of lime in the sodium peroxide used.

The results of these analyses are given in Table I in (a) grams per 100 cc. and (b) pounds per 50 gallons. The "calculated lime" is the lime calculated as necessary to combine with the mono-sulphide sulphur plus that necessary to combine with the thiosulphate sulphur plus that necessary to combine with the sulphate and sulphite sulphur. It must be noted how closely this figure agrees with the actual determination of lime.

It will be noted also that in three of these mixtures, viz. the second, third and first, large quantities of the total lime used have not entered into solution and there appears therefore to have been a quite unnecessary expenditure of lime.

The mixtures show a great similarity when the table is examined which sets forth the various forms of sulphur present when expressed in terms of the total sulphur, except that there is a greater proportion of thiosulphate and sulphate sulphur in the first three than in the last, causing less polysulphidal sulphur in those than in number four.

Table I.—*Results of Analyses.*

	Wagga Orchard Formula.	Farmers' and Fruit Growers' Formula.	Illinois Formula.	Dural Demonstration Orchard Formula.
	4½—6—50	18·9—16·66—50	15—15—50	40—80—50
Specific gravity of spray	1·0138	1·0276	1·0345	1·1687
Degree Baumé of spray	1·97	3·80	4·69	20·74
	<i>Chemical composition (in grams per 100 cc.)</i>			
Monosulphide sulphur ...	·220	·603	·545	2·630
Polysulphide (free sulphur)	·672	1·824	1·719	9·260
Thiosulphate sulphur ...	·292	·847	·692	3·080
Sulphate and sulphite sulphur ...	·013	·051	·040	·080
Total sulphur ...	1·197	3·325	2·996	15·050
Total lime ...	·658	1·88	1·619	7·420
Calculated lime ...	·663	1·887	1·630	7·370
Lime not used ...	26·9%	50·3%	46%	7·3%
Sulphur not used ..	nil	nil	nil	5·9%
	<i>Pounds of Ingredients in 50 gallons Spray.</i>			
Monosulphide sulphur ...	1·10	3·01	2·72	13·17
Polysulphide „ ...	3·36	9·12	8·60	46·38
Thiosulphate „ ...	1·46	4·24	3·46	15·42
Sulphate and sulphite sulphur ...	0·06	0·26	0·20	0·40
Total sulphur .. ...	5·98	16·63	14·98	75·37
Total lime ... ..	3·29	9·40	8·10	37·01
	<i>The various forms of sulphur present expressed in per cent. of total sulphur</i>			
Monosulphide sulphur ...	18·38	18·15	18·19	17·47
Polysulphide „ ...	56·14	54·84	57·38	61·53
Thiosulphate „ ...	24·39	25·46	23·10	20·47
Sulphate and sulphite sulphur ...	1·09	1·55	1·33	0·53
Total sulphur ... ..	110·00	100·00	100·00	100·00

At the time of commencing these investigations the Department of Agriculture of New South Wales<sup>1</sup> recommended a dilution of one gallon of concentrated lime-sulphur solution of 34 to 35 degrees Baumé to 12 gallons of water for winter use, and of one gallon concentrated lime-sulphur solution to 50 gallons of water for summer use. This would give for winter use a fluid of 1·0237 to 1·0246, or 3·24 to 3·37°

<sup>1</sup> Agricultural Gazette N.S.W., xxiv, p. 914, xxiii, 85.

Baumé, and for summer use 1·0060 to 1·0063, or ·86 to ·90° Baumé, and the opinion was held that lime-sulphur solutions in general should be diluted to these limits of specific gravity using a Baumé hydrometer for this purpose.<sup>1</sup> American Agricultural authorities state that solutions of lime-sulphur should be diluted to contain 12 to 15 lbs. sulphur per 50 gallons for winter use and to contain  $3\frac{1}{2}$  to 4 lbs. sulphur for summer use.

Assuming that both the above suggestions are based on the results of practical trials in the orchards of the two countries it was thought useful information would be afforded by correlating the results of these experiences.

Table II has been prepared to show—

- (a) the number of gallons of water which must be added to one gallon of the spray so that a fluid of 1·0242 sp. gravity may be obtained (N.S.W. winter strength.)
- (b) the number of gallons of water which must be added to one gallon of the spray so that a fluid of 1·0062 sp. gravity may be obtained (N.S.W. summer strength.)
- (c) the number of gallons of water which must be added to one gallon of the spray so that the resultant fluid may contain 12 to 15 lbs. sulphur in 50 gallons mixture (American winter strength).
- (d) the number of gallons of water which must be added to one gallon of the spray so that the resultant fluid may contain  $3\frac{1}{2}$  to 4 lbs. sulphur in 50 gallons mixture (American summer strength).

This shows that in the case of the Wagga formula the strength is too weak for winter use according to both New South Wales and American recommendations, while for summer strength New South Wales recommends about twice as much water to be added as does America.

---

<sup>1</sup> Quaintance and Scott, "Better Fruit," U.S.A. Department of Agriculture. Agricultural Gazette N.S.W., xxiii, p. 990.

In the Farmers' and Fruit Growers' Guide formula the strength for winter and summer use according to New South Wales, falls within the limits suggested by American authorities.

In the Illinois formula the strength for winter and summer use following the New South Wales recommendation contains about one and a half times as much water as the American authorities recommend.

In the Dural Orchard formula for winter use New South Wales recommends one and one-tenth more water than American authorities, and for summer use one and a quarter times more water than American authorities.

Table II.—*Table of Dilution.*

		Wagga.	Farmers' and Fruit Growers' Guide.	Illinois.	Dural Orchard.
(a) New South Wales recommendation.	Number of gallons of water to be added to one gallon of spray as manufactured to produce a sp. gravity of 1·0242. (Winter use.)	too weak	0·140	0·426	5·971
(b) New South Wales recommendation.	Number of gallons of water to be added to one gallon of spray as manufactured to produce a fluid of sp. gr. 1·0062. (Summer use.)	1·226	3·452	4·565	26·210
(c) Recommendation by United States of America.	Number of gallons of water to be added to one gallon of spray as manufactured to produce a fluid containing 12 to 15 lbs. sulphur per 50 gallons. (Winter use.)	too weak	·388 to ·110	0·251 to 0·000	5·281 to 4·024
(d) Recommendation by United States of America.	Number of gallons of water to be added to one gallon of spray as manufactured to produce a fluid containing 3½ to 4 lbs. sulphur per 50 gallons. (Summer use.)	·708 to 0·495	3·757 to 3·162	3·287 2·747	20·533 17·839

The two schemes therefore are sometimes in agreement, but in other cases are not.

Table III. has been prepared to show the number of pounds of sulphur (in the various states of combination) and of lime in 100 gallons of the mixture obtained by diluting the fluids prepared by the various formulæ as set forth in Table II. This table shows in a clearer manner the differences in composition.

For example one of those lime-sulphur solutions of 1·0242 sp. gravity contains 21·0 lbs. sulphur and 11·4 lbs. lime per 100 gallons, while another also of 1·0242 sp. gravity contains 29·2 lbs. sulphur and 16·5 lbs. of lime per 100 gallons.

Table III.—*Composition of Sprays as diluted according to Table II., in pounds per 100 gallons.*

Sulphur.	Wagga Formula.		Farmers' and Fruit Growers' Guide.		Illinois.		Dural.	
(a) Monosulphide	Too weak		5·28		3·82		3·78	
Polysulphide			16·00		12·06		13·31	
Thiosulphate			7·44		4·85		4·42	
Sulphate and sulphite			·46		·28		·11	
Total sulphur			29·18		21·01		21·62	
Total lime			16·49		11·36		10·62	
(b) Monosulphide	0·99		1·29		0·98		0·97	
Polysulphide	3·02		3·91		3·09		3·41	
Thiosulphate	1·31		1·81		1·24		1·13	
Sulphate and sulphite	·05		·11		·07		·03	
Total sulphur	5·37		7·12		5·38		5·54	
Total lime	2·96		4·03		2·91		2·72	
(c) Monosulphide	Too weak		4·35	5·44	4·36	5·46	4·19	5·24
Polysulphide			13·16	16·46	13·77	17·22	14·77	18·46
Thiosulphate			6·11	7·64	5·54	6·93	4·91	6·14
Sulphate and sulphite			·37	·46	·32	·40	·13	·16
Total sulphur			23·99	30·00	23·99	30·01	24·00	30·00
Total lime			13·59	16·96	12·97	16·22	11·78	14·73
(d) Monosulphide	1·29	1·47	1·27	1·45	1·27	1·46	1·22	1·40
Polysulphide	3·94	4·50	3·84	4·39	4·02	4·59	4·31	4·92
Thiosulphate	1·72	1·96	1·78	2·04	1·62	1·85	1·43	1·64
Sulphate and sulphite	·07	·09	·11	·12	·09	·10	·04	·04
Total sulphur	7·02	8·02	7·00	8·00	7·00	8·00	7·00	8·00
Total lime	3·86	4·41	3·96	4·52	3·78	4·33	3·44	3·93

In the case of mixtures having a sp. gravity of 1·0062, one contains 5·5 lbs. sulphur and 2·7 lbs. lime per 100 gallons, while another contains 7·5 lbs. sulphur and 4·2 lbs. of lime per 100 gallons.

It has not yet been ascertained to which of these forms of sulphur compounds lime sulphur solution owes its efficiency, nor what proportion of this efficiency is due respectively to the monosulphide form, the polysulphide form and to the thiosulphate form.

In the absence of this information it was thought that the examination of a particularly concentrated form of lime-sulphur mixture manufactured abroad, and which has given highly satisfactory results over a wide range of country, at certain observed dilutions, would be desirable.

This concentrated lime sulphur mixture was examined with the following results:—

Specific Gravity	...	...	...	...	1·3013
Degree Baumé	...	...	...	...	33·39
Composition in grams per 100 cc.					
Monosulphide sulphur	...	...	...	...	6·88
Polysulphide sulphur	...	...	...	...	26·51
Thiosulphate sulphur	...	...	...	...	1·62
Sulphate and sulphite sulphur	...	...	...	...	·10
Total sulphur	...	...	...	...	35·11
Total lime	...	...	...	...	13·51

The percentages of the various forms of sulphur in percentage of total sulphur are:—

Monosulphide sulphur	...	...	...	19·60
Polysulphide sulphur	...	...	...	75·50
Thiosulphate sulphur	...	...	...	4·61
Sulphate and sulphite sulphur	...	...	...	·29
Total sulphur	...	...	...	100·00

Field experience has shown that the best results obtained for (a) winter use is by mixing one volume concentrated spray with 10 volumes of water, and (b) for summer use by

mixing one volume concentrated spray with 50 volumes of water. The composition of these mixtures (a) and (b) would be:—

		(a)	(b)
Specific Gravity	... ..	1·0274	1·0059
Degree Baumé	... ..	3·77	0·84
Composition in grams per 100 cc.			
Monosulphide sulphur	... ..	·625	·135
Polysulphide sulphur...	... ..	2·410	·519
Thiosulphate sulphur	... ..	·147	·032
Sulphate and sulphite sulphur	... ..	·009	·002
Total sulphur	... ..	3·191	·688
Total lime	... ..	1·228	·264
Or expressed in pounds 50 imperial gallons			
Monosulphide sulphur	... ..	3·230	·675
Polysulphide sulphur...	... ..	12·070	2·600
Thiosulphate sulphur	... ..	·735	·160
Sulphate and sulphite sulphur	... ..	·045	·010
Total sulphur	... ..	15·980	3·445
Total lime...	... ..	6·150	1·320

Since it is admitted that the above strengths (a) and (b) have given satisfaction in field trials, I have taken these strengths as a standard and have calculated the dilution necessary in the case of these lime sulphur solutions as made by the various formulæ stated, so that the resultant mixtures shall contain the same number of pounds of sulphur per 100 gallons as do the standards chosen, namely one volume of the highly concentrated lime-sulphur solution with ten volumes of water for winter use, and one volume of the highly concentrated lime-sulphur solution with fifty volumes of water for summer use.

These are set forth in Table IV which also gives the specific gravity and degrees Baumé. Underneath will be found a table giving the amount in pounds per 100 gallons of sulphur in the various forms of combination present in these mixtures.



Table IV.—Various Sprays diluted to correspond to a "1 concentrated + 10" and a "1 concentrated + 50" standard.

	Imported Concentrated Dip. Standard.		Wagga.		Farmers' and Fruit Growers' Guide.		Illinois.		Dural Orchard.	
	Winter	Summer	Winter	Summer	Winter	Summer	Winter	Summer	Winter	Summer
Specific gravity ...	1.0274	1.0059	1.0138	1.0079	1.0265	1.0057	1.0345	1.0079	1.0358	1.0078
Degree Baumé ...	3.77	0.84	2.197	1.13	3.67	0.81	4.68	1.13	4.85	1.11
Total sulphur (lbs. per 100 gal.)	31.96	6.89	11.96	6.89	31.96	6.89	30.01	6.89	31.96	6.89
Total lime "	12.30	2.64	6.53	3.79	18.08	8.90	16.22	3.72	15.69	3.38
<i>Dilution.</i>										
Number of gallons lime sulphur	...	...	weak	57.6	96	20.7	weak	22.95	21.20	4.57
Gallons water ...	...	...	2½ times	42.4	4	79.3	slightly	77.05	78.8	95.43
				100.0	100	100.0		100.0	100.0	100.0
<i>Distribution of the total sulphur in the above dilutions, stated as pounds per 100 gallons.</i>										
Monosulphide sulphur ...	6.27	1.35	1.27	5.80	1.25	5.46	1.25	5.58	5.58	1.20
Polysulphide sulphur ...	24.13	5.20	3.87	17.53	3.78	17.22	3.96	19.67	19.67	4.24
Thiosulphate sulphur ...	1.47	.32	1.68	8.14	1.75	6.93	1.59	6.54	6.54	1.41
Sulphate and sulphite sulphur	.09	.02	.07	.49	.11	.40	.09	.17	.17	.04
Total sulphur...	31.95	6.89	6.89	31.96	6.89	30.01	6.89	31.96	31.96	6.89

Looking at Table IV it is seen that lime sulphur solutions containing the same weight of sulphur per unit volume may vary from 1.0265 to 1.0358 in specific gravity or from 3.67 to 4.85 if expressed in degrees Baumé.

It should also be noted that the dilutions calculated in Table IV are just about the mean of the values calculated in Table II.

It appears therefore that the "content of sulphur" is a more suitable method for calculating dilution than is the specific gravity method.

NOTE.—The degrees Baumé stated are the European standard calculated by the formula  $d = \frac{144.3}{144.3 - n}$ . The American degrees Baumé are calculated by the formula  $d = \frac{145}{145 - n}$ .

---

## ON THE DIFFUSIBLE PHOSPHORUS OF COW'S MILK.

By H. S. HALCRO WARDLAW, B.Sc.,

Science Research Scholar of the University of Sydney.

(From the Physiological Laboratory of the University of Sydney.)

---

[Read before the Royal Society of N. S. Wales, August 5, 1914.]

---

NUMEROUS data are available concerning the total quantities of the various elements which are present in milk. With regard to the forms of chemical combination and to the physical states in which these elements exist, however, our knowledge is much less complete. We know that milk contains substances both in solution and in suspension, but as to how the different elements are distributed between these states very few reliable data are to be found.

The separation of the substances in suspension in milk from those in solution has been attempted in three chief ways:—

1. By forcing milk through a filter made of some material having extremely fine pores, such as unglazed porcelain. A perfectly clear filtrate is obtained by this process.
2. By spinning milk in a centrifuge. In this way portion of the suspended matter of milk is obtained as a deposit.
3. By allowing the soluble portion of milk to dialyse away from the substances in suspension.

Although the first method of separation has been known for many years, few statements as to proportions of the substances in milk which pass through a porcelain filter are to be found, and there are considerable discrepancies

between the corresponding figures given by different authors. Further, it has been objected that the passage of milk through porcelain may not simply effect a mechanical separation of the suspended from the dissolved matter of milk, but changes may be induced which bring about the precipitation of substances originally in solution (see Raudnitz, 1902).

With regard to the method of separating the suspended matter from milk by spinning in a centrifuge, still less is known. Indeed, although it has been observed that a separation of some of the suspended matter of milk can be effected in this way, and one or two analyses of separator slime have been made (Fleischmann, 1901; Alson, 1908; Barthel, 1910), the only systematic attempt to determine the nature of the deposit obtained appears to be that of the present author (1914, 2). The investigations in this direction, however, have so far not thrown much light on the state of combination of the substances in solution and in suspension in milk beyond showing that calcium phosphate does not exist in suspension in milk as is generally believed, or rather that it is not deposited when milk is spun in a centrifuge. More complete information will be obtainable in this way only when a more perfect separation of the suspended matter has been brought about.

With regard to the separation of the suspended from the dissolved matter by means of dialysis, again very few data are available. When a body such as milk, in which there must exist a complex series of equilibria between dissolved and suspended substances, is allowed to dialyse against water, the effect is that of diluting the soluble constituents, which will dialyse out into the water. This dilution will disturb the equilibrium between dissolved and suspended matter, and may result in substances, originally in suspension, going into solution, just as a precipitate of an

“insoluble” salt may be dissolved up if the concentrations of the ions with which it is in equilibrium be diminished. Hence, when a quantity of milk is dialysed against a large volume of water the substances obtained in the dialysate will include not only those substances which exist in a state of true solution or in a dialysable or diffusible condition in the unchanged milk, but also those substances in suspension which can be made to go into solution by diluting with water. How considerable the amount of these substances may be has already been shown by the present author (*loc. cit.*). The amounts of the substances in milk which are dialysable under these conditions therefore give no idea as to the amounts of dialysable or diffusible substances in the unchanged milk, the substance secreted by the mammary gland.

In this paper, those portions of the substances present in milk which can be made to dialyse into a large (unlimited) volume of water will be distinguished as the *dialysable* substances. Those substances which exist in unchanged milk in a dialysable or diffusible condition will be called the *diffusible* substances.

To determine the amount of the diffusible substances of milk some means are required by which these may first be separated without disturbing the equilibria existing between them and the remaining constituents; the process of dialysis as ordinarily carried out gives no help. A distinct advance in the study of diffusible substances was made by Moore and Bigland (1911) when they employed the method of dialysis against known volumes of water. In this way the equilibria were displaced to a definite, although still unknown, extent. Another improvement in the study of diffusible substances was that introduced by Zuntz and Loewy (1894), and later employed by Rona and Michaelis (1909). In this method, which is known as the method of

*compensatory dialysis*, the solution in which the amount of a certain constituent in a diffusible condition is to be determined is dialysed, not against water, but against a second solution so made up as to contain in a diffusible condition all the constituents of the second solution except the one the amount of which is to be determined in such concentrations that only the constituent under observation will diffuse, all the other constituents being balanced or compensated by equal concentrations outside the membrane through which dialysis takes place. Apart from the fact that one would require to know a great deal about the solution being examined before such an outer liquid for the dialyser could be prepared, this balancing of all of the constituents of a solution but one does not at all mean that the natural equilibria will remain undisturbed. Returning to the analogy with the equilibrium between a salt and its ions, it is known that any alteration in the concentration of any one of the ions will bring about a re-adjustment of concentrations of the other substances present necessary to reach a state of equilibrium under the changed conditions. Thus, although in special cases it may be possible to prepare these compensating solutions, as Rona and Michaelis have shown, this method does not seem to possess a wide range of applicability.

These authors, however, have employed another method for the examination of the diffusible substances of milk which reduces to a minimum all displacement of equilibria. This method is simply an extension of that of Moore and Bigland. The liquid under examination is allowed to dialyse against a known volume of water, but in this case the volume of the water is made very small in comparison with that of the milk (25 cc. of water to 1000 cc. of milk). The milk is thus only slightly diluted and a much truer estimate of the diffusible substances may be formed. By this method, and by the method of compensatory dialysis, Rona and

Michaelis have determined the amount of diffusible calcium in milk.

This paper is an account of the application of the method of quantitative dialysis to the study of the diffusible phosphorus of cow's milk. A few determinations of the diffusible calcium have also been made.

#### **The Milk Used.**

The milk used for the first experiment was ordinary mixed milk as supplied by a city milk-vendor. This milk is about twelve hours old before it reaches the consumer, and is generally pasteurised. Such milk was found quite unsuitable for the present work as even the addition of toluol did not prevent its souring before the completion of the dialysis. The remaining experiments were made upon the milks of single cows. Each cow from which a sample of milk was taken, was milked directly into a vessel containing 10 cc. of toluol for each litre of milk collected. The access of bacteria is very much hindered in this way; milk collected as described keeps sweet for several days. The essential point here seems to be to prevent the entrance of bacteria, as it has been shown that although toluol kills organisms, such as yeasts, it has practically no effect on the rate of action of the enzymes produced by them (Harden, 1910). Toluol was chosen as the disinfectant as being a hydrocarbon and practically insoluble in water it did not seem likely to have any marked effect on the substances in an aqueous solution such as milk. Toluol does exert a solvent action on the fat of milk, however.

The samples of milk were all collected at about 12 noon; the last milking of the same cow had occurred in each case at about 4 a.m. of the same day. The milk obtained was generally the first portion of the milking.

#### **The Dialyses.**

The dialysis of milk against water was allowed to take place through celloidin membranes. These membranes

were prepared in the form of sacs by covering the inside of a test-tube with a layer of a solution of celloidin and allowing the solvent (alcohol-ether) to evaporate off. Before the ether and alcohol have completely disappeared from the layer of celloidin deposited in this way in the test-tube, the latter should be filled with water and the remainder of the alcohol and ether dissolved out. Membranes prepared by allowing all the ether and alcohol to evaporate off in the air are very brittle. The sacs formed in this way do not adhere firmly to the inside of the test-tube, and with a little patience can easily be coaxed away from the glass. These celloidin membranes, when prepared in the right way are transparent and flexible. They withstand a considerable tensile stress but are very easily torn. If water be poured into the test-tube before enough of the solvent has evaporated from the celloidin, the membrane formed will be opalescent and will tear so easily as to be useless. A suitable solution for the preparation of these membranes consists of equal parts of ether and absolute alcohol containing 5% of celloidin (see Abel, Rowntree and Turner, 1914).

The dialysates obtained in these celloidin sacs are perfectly clear when bacterial contamination is avoided. When a sac has once been used, however, it is rather difficult to clean properly inside, and the dialysate becomes infected and turbid in spite of the presence of toluol in the surrounding milk. In the later experiments this source of contamination was avoided by using a new diffusion sac for each dialysis.

In carrying out the dialyses 25 cc. of water were put in the celloidin sac and the latter suspended in one litre of milk. It was found that no further change occurred in the concentrations of the substances which had diffused through into the water after the dialysis had continued for twenty-



four hours. At the end of this time the molecular concentrations of the dissolved substances on each side of the celloidin membrane were practically the same. The relative molecular concentrations of milk and its dialysates were determined by measuring the depressions of the freezing point of water ( $\Delta$ ) due to the substances in solution in these liquids. The following are the figures obtained.

*Values of  $\Delta$  for spun milk, twenty-four hour dialysate, and forty-eight hour dialysate.*

Experiment.	Spun milk.	24-hr. Dialysate.	48-hr. Dialysate.
61	0.564°	0.580°	0.576°
62	0.576	0.547	0.533
63	0.569	0.530	0.526
64	0.560	0.535	0.539

These results show that the values of  $\Delta$  for milk from which the fat has been removed by spinning in a centrifuge (spun milk) and for the twenty-four hour and forty-eight hour dialysates agree to within about 5%, and that the freezing point of the dialysate does not alter its value once it has approximated to that of milk. When it is remembered that the diffusible part of the milk has been diluted to the extent of 2.5% it will be seen that a closer agreement between the freezing points of milk and its dialysates is hardly to be expected. An experiment in which the values of  $\Delta$  for spun milk, dialysate and the milk in equilibrium with the dialysate were determined, gave the following results.

Spun Milk.	Dialysate.	Outer Liquid.
0.560°	0.542°	0.548°

The values of  $\Delta$  for the dialysate and the liquid in equilibrium with it thus agree very closely.

It will be noticed that the freezing points of the dialysates have been compared, not with the milk with which

they were in equilibrium, but with the same milk freed from fat in the centrifuge. This was done because the freezing point of spun milk is more easily determined than that of the same milk still containing fat. It has already been shown (*loc. cit.*) that the freezing points of whole and spun milk are practically the same.

The milk on which all the work described in the present paper was done contained 1% of toluol as already stated. It was thought that the presence of the toluol might have some effect on the freezing point of the milk, but the following determinations of the value of  $\Delta$  for spun milk (a) without toluol, (b) containing 5% of toluol, show that this is apparently not the case.

Spun Milk Alone.	Spun Milk + Toluol.
0.552°	0.556°

The effect of the toluol, if any, is thus small.

All these determinations of freezing point were carried out in the manner previously described (*loc. cit.*). The agreement between the freezing points of the corresponding liquids is within the limit of accuracy of the method there set down. Each value of  $\Delta$  given is the mean of at least three determinations having an extreme difference of not more than about 0.005°.

During the course of a dialysis the volume of liquid put into the celloidin sac does not remain constant, but diminishes, as the following results show.

*Volume of liquid in celloidin sac before and after completion of dialysis.*

Experiment.	Original volume.	Volume of dialysate.
55	25 cc.	18.6 cc.
56	25 „	15.5 „
58	25 „	16.2 „

These figures were obtained for the dialysis of spun milk; they show the osmotic effect which occurs before the con-

centrations of the substances in solution have become the same on each side of the membrane.

### Results.

Having demonstrated that the process of dialysis as carried out in the present investigation leads to a definite state of equilibrium between the substances on each side of the membrane of the dialyser, we may now enquire what concentrations of substances in the dialysate are in equilibrium with those in the milk. In this paper I shall deal only with the concentrations of calcium and phosphorus. The amounts of calcium (expressed as CaO) were determined in addition to the amounts of phosphorus (expressed as  $P_2O_5$ ) only in the first few experiments.  $P_2O_5$  alone was determined in the later experiments as the length of time required for the analyses was so much increased when CaO was estimated as well, and as the amount of diffusible CaO in milk has already been determined by Rona and Michaelis (*loc. cit.*) by this method.

For these estimations as a rule not more than 10 cc. of dialysate were available; in the case of milk, portions of 20 cc. of spun milk were used, as the removal of the fat considerably reduces the amount of organic matter which has to be destroyed before proceeding to the actual estimation. The organic matter in the liquids under examination was destroyed, and the calcium and phosphorus oxidised by the acid-ashing process of Neumann (1902) as modified by Plimmer and Bayliss (1906), *i.e.*, by oxidation with a mixture of concentrated nitric and sulphuric acids.

*Use of spun milk.*—It has already been shown that the removal of the fat of milk by mechanical means does not alter the freezing point (Wardlaw, *loc. cit.*), that is, removes nothing from solution in the milk. This is no justification for concluding however, that the percentage of any particular constituent such as CaO or  $P_2O_5$  is the same in spun

milk as in whole milk. We must therefore ascertain how the contents of phosphorus and calcium differ, if at all from those of whole milk before we can with strict justification deduce from a comparison of the amounts of these constituents in spun milk and in the dialysate of whole milk the proportions of them which exist in a diffusible condition in whole milk.

When milk is spun long enough in a centrifuge (for over half an hour), the fat collects in a solid layer which may be easily removed from the top of the liquid. The liquid portion is therefore diminished by a volume equal to that of the fat or cream. The following measurements allow this diminution of volume to be calculated in percentages of the original volume of the milk. The milk was spun in cylindrical, flat-bottomed tubes; the volumes of the different portions of the milk were therefore proportional to the lengths of tube occupied by them.

*Diminution of volume of the liquid part of milk due to the removal of the fat or cream in a centrifuge.*

Milk.	Total height in tube.	Length of liquid.	Length of fat.	Diminution of volume.
3	13.0 cm.	12.3 cm.	0.7 cm.	5.4 %
4	12.7 „	12.0 „	0.7 „	5.5 „
6	13.3 „	12.6 „	0.7 „	5.3 „
mean	...	...	...	5.4 „

It will thus be seen that if the fat or cream removed contain no CaO or P<sub>2</sub>O<sub>5</sub>, the amounts of these in a given volume of milk will be increased to the extent of 5.4% by merely spinning in a centrifuge. As, however, cream contains a certain amount of ash, a direct determination of the ash, CaO and P<sub>2</sub>O<sub>5</sub> in the fat or cream removed from 100 cc. of milk was made. The following results were obtained.

*Amounts of ash, CaO and P<sub>2</sub>O<sub>5</sub> in the fat or cream of 100 cc. of milk.*

Ash.	CaO.	P <sub>2</sub> O <sub>5</sub> .
0·0180 gm.	0·0063	0·0046

These quantities amount to 2·4% of the corresponding constituents of whole milk.

The total result of the removal of the fat from milk in this way is thus a "concentration" of the remaining constituents to the extent of 5·4% (the actual molar concentration of the substances in solution is not changed, v. s.), and the removal of 2·4% of the substances which go to form the ash. On the whole there is therefore a "gain" of these substances in a given volume of liquid equal to 3·0% (5·4 - 2·4).

Direct determinations of the amounts of P<sub>2</sub>O<sub>5</sub> in whole and spun milk were also made. These gave the following results:—

*Percentage increase of P<sub>2</sub>O<sub>5</sub> in milk due to the separation of the fat in a centrifuge.*

Milk.	P <sub>2</sub> O <sub>5</sub> in 100 cc. of		Percentage increase.
	Whole Milk.	Spun Milk.	
3	0·210 gm.	0·217 gm.	3·5
4	0·216 „	0·222 „	3·0

These direct measurements thus lead to the same result as was deduced above. The accuracy with which phosphorus could be estimated was not high enough to allow of complete reliance being placed on results obtained by the direct method alone.

We may now proceed to compare the amounts of CaO and P<sub>2</sub>O<sub>5</sub> in spun milk with those in the dialysates of whole milk, remembering that the values obtained for the first quantities must be diminished by 3·0% if strictly corres-

ponding figures are required. The correction is not large, and for comparative purposes need not be made.

*Amount of diffusible CaO.*—The estimations of CaO were made by the method of Aron (1907) in which the Ca is precipitated from the acid ash as  $\text{CaSO}_4$  by the addition of alcohol. The figures below give the proportions of diffusible CaO found in three samples of milk.

*Percentage of CaO of milk in a diffusible condition.*

Milk.	CaO in 100 cc. of				Percentage in	
	Spun milk.		Dialysate.		dialysate.	
	A	B	24-hour.	48-hour.	24-hour.	48-hour.
55	0.180	0.166	0.061	...	35.3	...
56	0.164	0.153	0.061	...	38.3	...
58	0.280	...	0.086	0.077	30.8	27.4

The agreement between the duplicate analyses is not good, but the results show that roundly 30–40% of the calcium of milk is present in a diffusible state. These figures are rather lower than those given by Rona and Michaelis for the four samples of milk examined by them. Their figures range from 40 to 50%; they give no duplicate analyses.

*Amount of diffusible  $\text{P}_2\text{O}_5$ .*—The phosphates in the acid ash were precipitated in the way described by Neumann. These precipitates were dissolved in dilute ammonium hydroxide, the  $\text{P}_2\text{O}_5$  was precipitated again as  $\text{MgNH}_4\text{PO}_4$ , and finally weighed as  $\text{Mg}_2\text{P}_2\text{O}_7$  in the usual manner. The details of these processes will be found in the author's previous papers (*loc. cit.* 1 and 2). The accompanying figures show the results obtained for the amounts of diffusible  $\text{P}_2\text{O}_5$ .

*Percentage of  $P_2O_5$  of milk in a diffusible condition.*

Milk.	$P_2O_5$ in 100 cc. of				Percentage in	
	Spun milk.		Dialysate.		dialysate.	
	A	B	24-hour.	48-hour.	24-hour.	48-hour.
55	0.235	0.232	0.153	...	35.0	...
59	0.216	0.212	0.076	0.136	35.5	...
60	0.233	0.235	0.106	0.131	45.3	...
61	0.259	0.250	0.138	0.139	54.1	54.5
62	0.263	0.261	0.112	0.110	42.1	42.0
63	0.220	0.225	0.123	0.122	55.3	54.8
64	0.221	0.217	0.106	...	48.6	...

These results show that the amount of diffusible  $P_2O_5$  of cow's milk varies from 35 to 55%.

The amount of the soluble or diffusible calcium and phosphorus in milk is thus by no means consistent, but varies between rather wide limits. This variation is striking when the comparative constancy of the freezing point, and therefore of the total amount of dissolved matter is remembered. Jackson and Rothera (1914) have examined this peculiarity and have shown that there is a reciprocal relation between the salts in solution in milk and the amount of milk sugar.

#### Summary.

1. When a large volume of milk is dialysed against a small volume of water, the freezing point of the dialysate after twenty-four hours approximates to that of the milk, and does not change as the dialysis is continued; a definite state of equilibrium is therefore reached.

2. Milk freed from fat in a centrifuge contains 3% more ash-forming substances than whole milk.

3. The diffusible calcium of cow's milk amounts to 30–40% of the total present.

4. The diffusible phosphorus of cow's milk amounts to 35–55% of the total present.

In conclusion I wish to express my indebtedness to Sir Thomas Anderson Stuart, in whose laboratory this work was done, and to thank Assistant-Professor Chapman for the advice and encouragement he has given me during the work.

## REFERENCES.

- ABEL, ROWNTREE and TURNER, *J. of Pharmacol. and exp. Therap.*, 5, 276, 1914.
- ALSON, *J. Biol. Chem.*, 5, 261, 1908.
- ARON, *Biochem. Zeitschr.*, 4, 268, 1907.
- BARTHEL, *Methods used in the Examination of Milk and Dairy Products*, p. 13. Macmillan, London, 1910.
- FLEISCHMANN, *Lehrb. d. Milchwirtsch.* 3 Aufl. Lpzg. 1911. Cited by Raudnitz, *Sommerfeld's Handbuch der Milchkunde*, p. 200. Bergmann, Wiesbaden, 1909.
- HARDEN, *Alcoholic Fermentation*, p. 104, Longmans, London, 1911.
- JACKSON and ROTHERA, *Biochem. J.*, 8, 1, 1914.
- LOEWY and ZUNTZ, *Arch. f. die ges. Physiol.*, 58, 511, 1894.
- MOORE and BIGLAND, *Biochem. J.*, 5, 32, 1911.
- NEUMANN, *Zeitschr. f. physiol. Chem.*, 33, 115, 1902.
- PLIMMER and BAYLISS, *J. of Physiol.*, 33, 439, 1906.
- RAUDNITZ, *Ergeb. d. Physiol.*, II, 1, 193, 1903.
- RONA and MICHAELIS, *Biochem. Zeitschr.*, 21, 114, 1909.
- WARDLAW, (1), *this Journal*, 48, 1914; (2), *ibid.*, 48, 1914.

*Note.*—The milk used for the experiments described in the author's paper on the "Nature of the Deposit obtained from Milk by Spinning in a Centrifuge," p. 152, this volume) was mixed milk about twelve hours old, obtained from a city milk vendor.

---



## THE MOUNTAINS OF EASTERN AUSTRALIA AND THEIR EFFECT ON THE NATIVE VEGETATION.

By R. H. CAMAGE, F.L.S.

[With Plate VI.]

[*Read before the Royal Society of N. S. Wales, September 2, 1914.*]

THE principal mountains of the Australian mainland are situated along its eastern margin, and consist of a notched chain or dividing range, extending from Cape York in the north, to the centre of Victoria in the south. Here the range swings round to the westward, and except for the Grampians and a few isolated peaks, loses much of its rugged and distinctive character. It has a somewhat sinuous course, and the Main Divide lies at varying distances from the coast, for while it follows southerly along the eastern portion of the Cape York Peninsula, coming to within ten miles of the ocean a little to the north of Cairns, (Plate VI) it afterwards recedes to the westward, and opposite Townsville is over 100 miles inland, and is 300 miles west of the coast from Gladstone, while opposite Brisbane it has returned to within 80 miles of the ocean. Coming through New South Wales it may be said to average 80 to 100 miles from the coast, its nearest point being to the south-east of Cooma where it approaches to within about 35 miles in a straight line. Curling round from this point to the west, north-west, and south, it reaches its greatest elevation in Australia, 7,328 feet, on Kosciusko. Passing south-westerly through eastern Victoria, with several points exceeding 6,000 feet above sea-level, it occupies a position about 70—80 miles from the coastline.

This mountain system or Dividing Range and its effect on climate, and consequently on vegetation, can be better

understood if it be regarded as an uplifted plateau which for a great portion of its length presents its higher and steeper face to the east, and in most cases, with a more gradual slope to the westward. In its southern part, where it crosses from New South Wales into Victoria, both faces are steep, particularly the western, while on the Blue Mountains west of Sydney, there is a distinct downward warp to the eastward, up which the railway has to climb from Emu Plains.

As the streams on the eastern side of the mountains are generally short, and in view of the elevation of their sources consequently rapid, they have already succeeded in entrenching themselves to depths of several thousand feet, according to the height of the plateau, with the result that the line of the water-parting is being gradually but surely forced to the westward. The effect of these parallel gorges, which are being thus formed, is to isolate sections of the plateau into lateral spurs, and in frequent instances the elevations on these spurs, especially where residuals of older levels occur, are greater than those of the Main Divide itself. Another feature of the water-parting is that it occupies various positions on these mountains, being sometimes in the centre, but very often towards the edges, and in some instances coincides with the actual margin of the plateau, as at the head of the Kybean River, south-east of Cooma. It will be seen, therefore, that the ridge which divides the waters on the plateau, often exercises less influence on the climate and vegetation than many of the lateral ranges, or in other words, it is the steep eastern margin of the plateau, rather than a slight dividing ridge on the tableland, which dominates the climate of the coastal belt and influences the character of the resultant flora.

In Australia there is a type of vegetation known as brush or jungle, (in Queensland the term "scrub" is now largely

used), largely a tropical element, which has entered the continent, probably through New Guinea, before the last land connection was severed, and this is practically confined to the coastal strip and eastern face of the Main Range in Queensland and New South Wales. Now it is interesting to consider why this brush vegetation has such a limited range in Australia. We can readily understand that, being of tropical origin, its progress southwards will be arrested by the cold of southern latitudes, but seeing that it enters Australia in the north, it is not clear why it does not extend right across the continent from east to west, and come an equal distance south throughout. The reason which suggests itself is that this distribution is regulated by climate and rainfall. It would seem however, that these factors are directly the result of certain topographic conditions, and had the topography of northern and eastern Australia been similar, there would not have been such a wide difference in the two floras.

There is perhaps nothing which shows more evident response to certain physiographic features than the resultant native flora. This response is due to certain natural laws, an important one being that it is the cooling, and, therefore, often the ascending cloud which precipitates most of the rain. The result of this law is a good rainfall throughout practically the whole of the eastern slopes of Australia, for the rainy weather comes from the ocean, and ascends these mountains to their summits, there being none so high as to reach above the rain zone, and the clouds are chilled in their ascent. It seems unquestionable that had this great plateau been only half its present height, and one or two hundred miles further inland, as well as reached by a gentle slope instead of a fairly abrupt face, the rainfall over the present coastal belt, though considerable, would have been less, while that of the area now occupied by the lower western slopes would have been increased.

Our good coastal rainfall is largely due therefore to the comparative proximity of the Main Range to the ocean, to the height of the plateau (averaging from 3,000 to 4,000 feet), and the steepness of its eastern face.

Another effect of this long north and south range is that it tends to keep the western country dry, by shutting off coastal moisture, and thus is produced the two well known distinctive types of coastal and inland floras, the one resulting from moist and temperate surroundings, and the other from colder winter and hotter summer conditions. The plateau itself, owing to its altitude, produces a third type of vegetation, in which is to be found much of what is known as the Antarctic element, and it is along this high land that many southern plants are able to make their way northwards into latitudes which at lower levels are altogether too hot for them. Especially is this the case in connection with the genus *Eucalyptus*, and the only portion of northern New South Wales in which Tasmanian members of this genus are to be found is on and around the New England tableland.

The effect of the two distinct climates produced by this Great Dividing Range is so pronounced that although there is a dense brush vegetation on very many portions of the eastern face, the moment the summit of the plateau is reached and drier western, and colder winter conditions are encountered, while coastal humidity is shut off, the jungle or brush ceases, and its place is taken by open forest country, or by low scrub made up of species distinct from those on the eastern face. This applies practically throughout the whole length of the range, for at Milton, in the south, in latitude  $35\frac{1}{4}^{\circ}$ , where the most southern trees grow of that northern hemisphere species, *Cedrela toona* (Red Cedar) the brush vegetation may be found in the coastal belt, while on the plateau to the west, from Braidwood to

Lake George, the country is all open forest. The same contrast exists between Illawarra on the coast and Moss Vale to Goulburn and Yass on the plateau, and again between the North Coast of New South Wales and the New England tableland. Passing into Queensland we find the same conditions in regard to plant distribution wherever the mountain range is sufficiently high to form a barrier. At Cairns, in latitude  $17^{\circ}$ , brush growths are abundant, but in going westerly from here, the whole of this class of vegetation is left behind before Mareeba is reached, or within 20 miles in a straight line. Between the Mareeba-Parada districts, and the southern shores of the Gulf of Carpentaria, a distance westerly of about 300 miles in a direct line, the country gradually falls from about 1,700 feet to sea level, though some of the hills near Parada exceed 2,000 feet. During the whole of this distance no sign of brush vegetation is seen, though a little occurs on a few of the moist river flats near the Gulf, and the large forest trees are made up chiefly of *Eucalyptus* species, while along the banks of the Etheridge, Gilbert, Norman, Flinders and other rivers are luxuriant growths of *Mela-leucas*, neither of which genera contributes to the ingredients of an Australian brush or jungle. In a distance due south, 200 miles, from the Gulf to Cloncurry, the ascent is almost imperceptible but amounts to about 700 feet, while the divide between the Gulf and Lake Eyre waters is crossed at Whitewood between Hughenden and Winton, at an elevation only slightly exceeding 1,000 feet. From Whitewood to the Gulf of Carpentaria at the mouth of the Flinders River, is a direct distance northwesterly of about 330 miles, and the country has the appearance of a level plain throughout, the fall amounting to only slightly over three feet per mile. It will be seen, therefore, that there is a total absence of any high range to create moist conditions over this large area. Turning next to the westward, there is the Barkly

Tableland with an elevation of about 1,000 feet, at a distance of 150 miles from the Gulf, and this forms some of the highest land in Northern Australia, excepting a few isolated peaks, and also the Main Divide along the Cape York peninsula.

From observations made throughout Eastern Australia in regard to the effect of the mountain chain upon the climate and vegetation, and a comparison between eastern and northern conditions, it would appear that the absence of brush or jungle from Northern Australia is largely owing to the absence of any considerable rainfall for about seven or eight months of the year, viz., from March or April till December, and this dry period would be greatly reduced by the presence of a mountain range upwards of 3,000 feet high and within 100 miles of the coast line. Under present conditions there is no cold zone such as would be formed along a high mountain chain, and which would create conditions of moisture throughout the year, and induce more dense growths.

During the wet season, and with the monsoonal influence, the rainfall along the southern shores of the Gulf of Carpentaria aggregates about twenty inches in the months of January, February and March, but this amount is much exceeded around Cairns, on the steep eastern face of the Main Divide, where the records show an average of about twenty inches for each of those months mentioned. The clouds, which are borne across North-eastern Australia by the south east trade winds, precipitate the rain as they ascend the eastern face of the mountains, and afterwards reach the interior as descending clouds.

Briefly, the conditions necessary for the production of a "brush" flora are a good rainfall, warmth, shelter from cold winds, and a basic rather than a siliceous geological formation. With an abundance of moisture, warmth, and

shelter, a jungle flora may be produced on soils which are fairly siliceous and porous, but towards the colder latitudes, say from Sydney southwards, where the element of cold is beginning to be felt, it is found that this particular class of vegetation is gradually restricted to the more basic formations, with usually less than 55 to 65% silica, such as the basalts, the volcanic tuffs and the shales of Illawarra, and the igneous rocks (monzonite) of Milton. On the other hand, in Northern Queensland, as on Bellenden Ker Mountain near Cairns with excessive moisture and warmth, we find the "brush" vegetation swarming up to the summit, upwards of 5,000 feet, in a formation of granite containing about 72% silica.

In making a comparison between the vegetation of any two areas, the question of soil as well as that of climate must be considered, and it would seem that there is a greater proportion of siliceous soils in Northern Australia as compared with those of the east, the latter being rendered more basic by the presence of large areas of Tertiary basalts. It is clear, however, that the difference of soils in this case is by no means the only factor in accounting for the difference of vegetation, for we have the example of Bellenden Ker on the east, with a siliceous soil though with the excessive rainfall of 165 inches per annum, supporting a brush vegetation, while in much the same latitude, the beautiful rich flats of the Flinders flowing into the Gulf, and which are formed of alluvium, a considerable portion of which is brought down from the basalt tableland to the north of Hughenden, are richly grassed and almost treeless. Neither is there any brush on the basalt where it occurs *in situ* near Hughenden, but on similar elevated formations east of the Main Divide as at the Blackall Range north of Brisbane, and Atherton near Cairns, the brush vegetation is amongst the finest in Australia.

These latter remarks apply to the basaltic lands of the Richmond River, while on the tableland of New England to the westward, with the same class of rock in many places, but a much lower rainfall, and a cooler climate, the country is open forest. Many more similar examples could be quoted.

This goes to show the highly important bearing which topography, in regulating aspects and climate, exercises on the native flora, and it furnishes examples in nature which might profitably be considered in connection with agricultural and forestry matters.

*Geocols.*—In their valuable work on “The Climate and Weather of Australia,” (p. 24), Messrs. Hunt, Taylor and Quayle refer to five geocols, or low gaps across the mountain ranges of New South Wales and Victoria, and which receive a lower rainfall than that of the surrounding hills, and it is by studying the floras of these geocols and contrasting them with those of the higher mountain chain that we are able to more fully appreciate the marked effect of this higher land in differentiating the floras on either side of it, which effect is interrupted, and in some cases wholly removed at the points where the geocols cross the main chain. It is instructive to briefly discuss some of the features of these geocol floras as resulting from climatic influences which are largely produced from the local topography. The first thing to decide is which influence dominates, the coastal or inland. Here again the natural law of the cooling or ascending cloud chiefly precipitating the rain has to be considered, and while all along the high mountain slopes facing the ocean there is a good rainfall, the absence of a high range across the geocol, reduces the precipitation from the ocean side with the result that in every case where the gap is a low one, it is the inland or drier influence which dominates, with the result that the moisture-loving, coast



vegetation is kept back to the eastward and the western or inland flora comes through on to the eastern watershed.

The Kilmore Geocol in Victoria is situated so far towards the cooler southern latitudes that its elevation, about 1,200 feet, is sufficient to allow the colder-loving type of plants such as *Eucalyptus amygdalina* (Messmate or Peppermint), *E. dives* (Peppermint), and *E. viminalis* (Manna Gum) to continue in and across the depression, and as the divide runs east and west at this point, it is fully exposed to the cold from the south, and there is consequently no considerable invasion of either inland or coastal plants to the opposite side.

The Omeo Geocol is situated on an angle of the Main Divide where, after coming from the west, it swings round to the northward into New South Wales, and being about 3,000 feet high, has a climate sufficiently cool for the growth of such mountain species as *Eucalyptus coriacea* (Snow Gum), *E. stellulata* (Sallow or Sally), *E. camphora* (a Swamp Gum), and *E. rubida* (a White Gum). It forms a plateau about ten miles wide across the main axis of the mountain from which the waters fall steeply into the Mitta Mitta on the north and the Tambo River on the south. Within forty miles on either side of the Omeo Geocol the Main Divide rises to elevations of 5,000 to 6,000 feet. This geocol, though a distinct mountain gap, is sufficiently high to form a natural barrier between two floras, but yet such species as *Eucalyptus albens* (White Box) and *E. macrorrhyncha* (Red Stringybark) which prefer a dry to a moist atmosphere, and are not found on the summit of the range in the geocol, have managed to cross this narrow barrier from north to south, and occur below the level of the snowfalls in the warm valley of the Tambo. The presence of these two species on both sides of the Main Divide without their being able to exist on the summit, is of interest, and

may perhaps be accounted for through seeds having been carried across by the agency of birds, or it seems just possible both species may have extended right across before the mountains were uplifted to their present elevations in late Tertiary time.<sup>1</sup>

In a paper on the flora from Bowral to the Wombeyan Caves I have previously referred to the possibility of *E. albens* having crossed the Main Divide before the final uplift.<sup>2</sup>

The Cooma Geocol is a north and south gap with the lowest point on the Main Divide being upwards of 3,000 feet, and is therefore high enough to form a natural barrier, consequently there is little or no invasion of either the dry or moisture-loving floras from one side to the other. Much of this gap is a very expansive open plateau, and therefore the possibilities of plants crossing are less than in the case of the depression at Omeo.

There is however a remarkably long valley down which the Murrumbidgee flows, northwards from near Cooma towards Canberra, and a fair number of western or warmth-loving plants find their way up this somewhat sheltered valley, and in this way reach elevations greater than those they attain anywhere else south of the latitude of Goulburn. *Sterculia diversifolia* (Kurrajong) is an example of this, although it appears unable to face the cold of that portion of the geocol on or near the Main Divide itself,

The Lake George Geocol, though only a little over 2,000 feet above sea level is also a very broad plateau of plains and open forest, and in view of its southern latitude is sufficiently elevated for the growth of the cold-loving plants and therefore acts as a barrier between the moist east,

---

<sup>1</sup> "Geographical Unity of Eastern Australia," E. C. Andrews, B.A., this Journal, Vol. XLIV, p. 420, (1910).

<sup>2</sup> Proc. Linn. Soc. N.S.Wales, Vol. XXXI, p. 452, (1906).

and drier west. In this latitude, about  $35^{\circ}$ , there are few western plants which thrive at elevations exceeding 2,000 feet.

The Cassilis Geocol, in about latitude  $32^{\circ}$ , is only from 1,700–2,000 feet above sea level, and there are higher mountains to the eastward, both north and south of Singleton, which have the effect of shutting off the coastal influence from a fairly large area to the westward, between these mountains and the low portion of the Main Divide near Cassilis. The result is that it is the descending clouds which reach this isolated area, and the rainfall, which on the coastal side of the mountains opposite this point is upwards of fifty inches annually, is less than twenty-four inches in the geocol area. There are many plants in the western districts occupying zones which reach up to elevations of 1,800 feet in latitude  $32^{\circ}$ , and it is easily seen that in following their upper contours along the western side of the Main Divide, these plants on arrival at the broad gap are able to pass through on to the eastern watershed, seeing that from this particular locality the coastal moisture has been largely excluded, and the climatic conditions are more similar to those of the western than the eastern side of the main mountain range.<sup>1</sup>

Part of the Liverpool Range, however, as it winds round north-easterly towards Murrurundi, and forms the north-western side of the geocol, rises to elevations of about 3,000 feet, and receives a greater rainfall from the ascending clouds, with the result that the heads of the gullies which face easterly and are sheltered from the colder and drier westerly influence are filled with brush, and when viewed from the lower open forest areas within the geocol, present a magnificent example of the effect of topography on the native flora.

---

<sup>1</sup> A list of the plants which have crossed is given in the New South Wales Handbook, p. 418, Cambage and Maiden.

Going northerly from here the great New England plateau, with elevations from 3,000—4,500 feet and 5,000 feet, forms a distinct barrier between eastern and western floras, but as Queensland is approached and warmer latitudes are entered, and the elevations become slightly reduced, the effect of the north and south barrier becomes less, and western plants which in southern New South Wales are only found below elevations of 1,500 feet, are now able to flourish at altitudes of about 3,000 feet.

Some interesting floral responses to climatic effect resulting from topographical features are to be seen near Toowoomba in Queensland, where the Main Divide for a considerable distance at about eighty miles from the ocean is only about 2,000 feet high. Some of the results are that such a typical western species as *Eucalyptus microtheca* (the Coolabah of the Bourke district), ascends the Darling Downs almost to the summit, and such western species as *Casuarina Luehmanni* (Bull-Oak) and *Acacia harpophylla* (Brigalow) though not on the actual summit, manage to cross to the eastern watershed and are found on the lower levels around Gatton and Laidley, while areas of brush may be seen nestling under the eastern face of the mountain, practically to the very summit near Toowoomba, but sheltered from westerly conditions. Going north-westerly from Toowoomba, the Divide recedes from the coast, and although some peaks exceed 3,000 feet, for several hundred miles it loses much of its identity as a rain regulator owing to its moderate elevation, and in some instances to the presence of higher mountains to the eastward. Where it is crossed near Jericho by the railway line from Rockhampton to Longreach at a point nearly 300 miles from the ocean, it is only a very slight rise on an extended sandy plateau of scarcely 1,200 feet above sea level, while fifty miles to the eastward, the Drummond Range rises to about 1,500 feet. On both sides of the water-

parting near Jericho, the flora consists almost wholly of western types, and owing to the absence of any high mountain between this point and the coast, some members of the western or interior flora follow the consequent drier atmosphere to within at least twenty miles of the ocean, *Acacia harpophylla*, *Eucalyptus microtheca* and *E. populifolia* (Bimble Box) being found in the suburbs of Rockhampton, while *Casuarina Cambagei* (Belah, regarded as *C. lepidophloia* by Mr. Maiden) is growing to the westward, and also in the village of Marmor to the southward. *Eremophila Mitchelli* (Budtha or Sandalwood) occurs between Marmor and Raglan, and *Casuarina Luehmanni* near Rodd's Bay platform between Gladstone and Bundaberg.

A similar invasion of some western plants on to the eastern watershed takes place at various places north of Jericho as the Main Divide is comparatively low, and also between Hughenden and Townsville, the highest portion of the railway between these points being only slightly over 1,800 feet.

Near Cairns, the Main Divide approaches to within about twenty to thirty miles of the coastline, but presents a steep face to the ocean, so that the eastern or moist atmosphere, which is intensified by Bellenden Ker and Bartle Frere Mountains acting as condensers and inducing abnormal rainfalls, is restricted to the coastal belt, the result being a brush or jungle flora on the eastern side and open forest on the western.

#### Summary.

A study of the topography of Eastern Australia and of the distribution of the native flora along and on each side of the mountain range which forms the Main Divide, serves to show that the two classes of climate, moist and dry, produced on each side of this mountain chain, are not so

much the result of the position of the actual water-parting on the tableland, as that the eastern or ocean face of the plateau is fairly high and steep and at no great distance inland. The effect of the range in the south is to create three climates, a humid and a dry one on the east and west sides respectively, and a cold one on the summit which acts as a barrier between two floras which would otherwise to some extent commingle at lower levels.

In Queensland, a generally lower summit of the plateau, and an increase in temperatures owing to the more northerly position of the range, permit the western or dry influence to cross the mountains in various places, and allow many interior types of plant to thrive on the eastern watershed, while the moisture-loving or coastal brush plants are largely excluded from these invaded areas. This invasion occurs in the Goulburn River Valley near Cassilis in New South Wales, and at such places in Queensland as between Toowoomba and Brisbane, between Jericho and Rockhampton, and between Hughenden and Townsville.

In no case where such a gap occurs does the eastern brush or moisture-loving flora pass through to the west, although it may reach there by other agencies. The absence of a high range extending along behind the coastal belt in Northern Australia is considered to largely account for the absence of any considerable rainfall in that locality during the winter months, and the absence of such rainfall, together with the siliceous nature of much of the soil, appear to account for the general absence of brush or jungle from the central and western portions of Northern Australia. The observations indicate that the rainfall and climate in Eastern Australia are very largely regulated by the topography, and the vegetation, after allowing for the differences of soils, is chiefly the result of rainfall and climate. It would therefore appear that the removal of the forests would not result in a greatly reduced rainfall along the east coast over a long period of, say, fifty years, but would very probably decrease the number of damp days.

DESCRIPTION OF A LIMESTONE OF LOWER MIOCENE  
AGE FROM BOOTLESS INLET, PAPUA.

By FREDERICK CHAPMAN, A.L.S., F.R.M.S., etc.,  
Palæontologist to the National Museum, Melbourne.

With Plates VII, VIII, and IX.

(Communicated by W. S. DUN.)

[Read before the Royal Society of N. S. Wales, October 7, 1914.]

1. Introduction.
2. Note on the Bearing of the Foraminiferal Limestones upon the Occurrence of Petroleum Fields.
3. Detailed Description of the Limestones.
4. Summary.

### 1. Introduction.

THE rock specimens from the above locality, for the examination of which I am indebted to my friend Mr. W. S. Dun, of Sydney, have an important bearing on the geology of Papua. The limestone is in fact, a very fine example of a foraminiferal rock denoting a definite horizon in the Cainozoic system. The specimens were collected at Bootless Inlet, Papua, by Mr. J. E. Carne, F.G.S., during his recent geological explorations in search of petroleum-bearing beds.

The present occasion seems to be the second on which Cainozoic fossils belonging to a definite horizon have been obtained from Papua, the first being the determinations made by C. S. Wilkinson in 1876.<sup>1</sup> That author then recorded *Voluta macroptera*, *Volutilithes anticingulatus* and several other genera of mollusca from the blue clays of Hall's Sound, Papua, and which he regarded as common

---

<sup>1</sup> Proc. Linn. Soc. N. S. Wales, Vol. 1, pt. 2, 1876, pp. 114, 115.

also to the Victorian Cainozoics.<sup>1</sup> He further remarks that "The Miocene clay beds of New Guinea, judging from the specimens collected by Mr. Macleay, are exactly similar in lithological character to the Lower Miocene beds near Geelong, and on the Cape Otway coast in Victoria." Wilkinson accepted McCoy's conclusions as to the Miocene age of the Victorian beds, when he compared them with the clays of Hall's Sound. Since that time, however, some authors have relegated the Victorian beds above named to the lower series, the Eocene. Latterly the writer, having obtained what he regards as conclusive evidence of the sequence and relative ages of the Victorian beds, finds it supports the original idea of McCoy's, that the Geelong and Torquay series are comparable with the Miocene beds of the northern hemisphere. It will, therefore, be of great interest if we can obtain further evidence from Papua as to the relationship of the blue clays to the *Lepidocyclus* limestone herein described.

Wilkinson also referred to an oolitic limestone occurring at Bramble Bay,<sup>2</sup> which he thought to be an upper bed of the Miocene formation. It is here suggested that this and the brecciated rock composed of corals, shells and echinoids, from Yule Island, may have some age affinity with the present brecciated limestone. So far as we can judge from the palæontological evidence, both the *Voluta* clays and the *Lepidocyclus* limestone occur on or about the same horizon; the latter by its characteristic species denoting an Upper Aquitanian stage, whilst the Cape Otway series probably comprises that and the succeeding Burdigalian stages, as seen in the shell marls of Bird Rock and the polyzoal rock of Spring Creek and Batesford<sup>3</sup> respectively.

<sup>1</sup> Wilkinson rightly refers the two species named as common to the Otway series, now called Janjukian, and not, as would be gathered from Mr. Etheridge's note (Pal. Queensland and New Guinea, 1892, p. 697), denoting the fauna of Schnapper Point, Mornington and Muddy Creek.

<sup>2</sup> *Loc. supra. cit.*, p. 115.

<sup>3</sup> The *Lepidocyclus* of Batesford denote a higher stage than those of Papua.



In his paper on the echinoids of New Guinea, Tenison Woods<sup>1</sup> referring to the limestone of Yule Island mentioned by Wilkinson, states that he could not "detect any Foraminifera on subjecting different portions to microscopic examination." He also notes its resemblance both lithologically and palæontologically (in the presence of well preserved *Pectens*) to the Mount Gambier limestone, although the Yule Island rock showed an absence of polyzoa.

Besides the Cainozoic fossiliferous rocks above mentioned, Jurassic,<sup>2</sup> doubtful Cretaceous,<sup>3</sup> and numerous Pleistocene fossils<sup>4</sup> have been recorded from Papua.

## 2. Note on the Bearing of the Foraminiferal Limestones upon the occurrence of Petroleum Fields.

The Cainozoic geology of the petroleum area of the Gulf division of Papua indicates that there are in this district enormous deposits of sandstone, marls and hard limestones. Mr. E. R. Stanley remarks of these beds "All carry fossil remains in parts."<sup>5</sup> The limestones and marls, as shown by this present work and previous papers already quoted,

<sup>1</sup> Proc. Linn. Soc., N. S. Wales, Vol. II, pt. 2, 1877, p. 126.

<sup>2</sup> Etheridge, R. jnr., "Our Present Knowledge of the Palæontology of New Guinea." Rec. Geol. Surv. N. S. Wales, Vol. I, pt. 3, 1889, pp. 175, 176. Also Etheridge and Jack, Geol. and Pal. Queensland and New Guinea, 1892, p. 696.

<sup>3</sup> Etheridge, R. jnr., in Pal. Queensland, etc., p. 696. Also Maitland, A. G., "The Salient Features of British New Guinea (Papua)." Journ. W.A. Nat. Hist. Soc., Vol. II, No. 2, May, 1905, p. 52.

<sup>4</sup> Etheridge, R. jnr., Rec. Geol. Surv., N. S. Wales, Vol. I, pt. 3, 1889, p. 174.

<sup>5</sup> See Report by J. E. Carne, F.G.S., on the Petroleum Oil Field, Vailala River, *ibid.*, p. 174. In this report Mr. Carne states that the blue mudstone and sandstone of the Mura Group and at Orokolo Spring contain indications of petroleum; and that the petroleum-bearing strata of Vailala and the coal-seams at Purari and Curnick Rivers are identical in age. Mr. Carne further draws attention to the probable westerly extension of the oil belt across Dutch New Guinea and thence to Timor and Java. Also "Report on the Geology of the Vailala Petroleum Area, Gulf Division, Papua." Stanley, E. R., Commonwealth Government Report on Papua, for the year ending June 30th, 1912, p. 176.

are of true Cainozoic age, and this opinion as regards the mudstones is further confirmed by Stanley's determination of the fossils from the petroleum-bearing mudstones as consisting largely of *Pleurotomiidæ* and *Dentaliidæ*. Bearing in mind the fact that both the mudstone and the limestone form part of a nearly synchronous series, it is most necessary to follow up this discovery of a Lower Miocene limestone by further collecting in other areas of the country.

The close relationship of these *Lepidocyclina* limestones with oil-bearing strata is not confined to Papua, but is a prominent feature in Borneo, Sumatra and Java, with which fields the present locality is undoubtedly stratigraphically connected. Verbeek and Fennema, in their exhaustive geological treatise on Java and Madoura<sup>1</sup> refer to the probability of the vast number of foraminifera found having been the source of the petroleum in those islands. Thus these authors observe<sup>2</sup> that "il est très probable que l'on doit chercher l'origine du pétrole dans la masse sarcodaire de ces foraminifères, très petits il est vrai, mais existant à des millions d'exemplaires; en effet, cette masse contient des matières grasses, et déjà l'on a réussi à fabriquer artificiellement du pétrole par distillation des graisses."

As a corollary to this theory of a foraminiferal origin of the petroleum in certain areas, one may mention that many of the foraminiferal limestones of Carboniferous age in England and Scotland, as the *Endothyra* and *Saccamina* limestones, are often highly bituminous; and there is also a limestone rich in bitumen found in the Carboniferous of Russia, which is crowded with the remains of the foraminifer, *Schwagerina*. Whilst pointing out the economic value of the foraminiferal remains as a source of hydrocarbon, it is also noted that the fish remains found in these

---

<sup>1</sup> Description géologique de Java et Madoura, Vols. I and II, Amsterdam, 1896.    <sup>2</sup> *Op. cit.*, Vol. II, p. 1043.

Papuan rocks, may in some strata as yet undiscovered, be found to occur in greater abundance than in the present limestone sample, and consequently yield a further supply of oily material, as they have been known to do elsewhere.

### 3. Detailed Description of the Limestone.

#### *General Structure.*

The limestone of Bootless Inlet is a fairly compact rock, but shows a sub-brecciated structure in which the fragmentary character was induced prior to the final cementation of the constituents.

A microscopical examination shows that in its initial stages of formation, this rock was a shallow-water shelly and coral sand, the particles being intermingled with fragments of a now partially or wholly decomposed volcanic rock of diabasic and andesitic nature, some fragments being quite glassy in structure as if derived from submarine ejections. The component organisms forming the rock are foraminiferal tests, among which are some gigantic species of *Lepidocyclina*, fragments of fish-teeth and bone, echinoid remains, polyzoa and calcareous algæ. The separate organisms show signs of severe treatment, being not so much water-worn as angularly chipped and fractured, especially in the case of the larger foraminiferal tests. In most examples the peripheral edges of the large, peltate forms, as *Heterostegina* and *Lepidocyclina*, have been chipped and broken, and some of the organic material has been finely comminuted. Tidal and current action would scarcely account for this subangular, and even angular, condition of the shells, and many of the fragments are so sharply fractured as to lead one to conclude that fishes with crushing teeth, as the *Labridæ* and *Sparidæ*, as well as other predatory animals, such as the echinoids and starfishes, may be partly or wholly responsible for the peculiar condition of the material composing this limestone.

Towards this conclusion strong support is rendered by the relative abundance of fish remains, as teeth and bone fragments, occurring scattered throughout the limestone. The writer had already drawn attention<sup>1</sup> to the possibility of such reef-forming foraminifera as *Carpenteria* which occur in coral islands, having been broken up by predatory fishes which would find a nutritious pabulum in the protoplasmic tests of the larger rhizopods.

*Description of Fossil Remains in the Limestone.*

PLANTÆ.

Genus LITHOTHAMNION, Philippi, 1837, emend. Fosløe, 1900.

LITHOTHAMNION RAMOSISSIMUM, Reuss sp.

*Nullipora ramosissima*, Reuss, 1848, Haidinger's Naturw. Abhandl., Vol. II, pt. ii, p. 29, pl. iii, figs. 10, 11.

*Lithothamnion ramosissimum*, Reuss sp., Gümbel, 1871, Abhandl. k. bayer. Akad. Wiss., Vol. XI, pt. i, p. 34, pl. i, figs. 1a - d. Smith, W. W., 1907, Phil. Journ. Sci., Vol. II, No. 6, p. 396, pl. III? IV. Chapman, 1913, Proc. Roy. Soc. Vict., Vol. XXVI, (N.S.) pt. i, p. 166, pl. xvi, figs. 1 a - c, 2, 3.

Fragments of this branching type of calcareous alga are quite common in the limestone. It often materially helps to build up limestones of Cainozoic, and especially of Miocene age; as for example the "Leitha Kalk" of the Vienna Basin. It generally accompanies the *Lepidocyclina* limestone of the Indo-Pacific area, as at Christmas Island, Borneo, Japan, the New Hebrides and the Philippines. In Australia, *Lithothamnion* is of frequent occurrence in the Janjukian series of Victoria and South Australia.

<sup>1</sup> "Foraminifera collected round the Fynafuti Atoll from Shallow and Moderately Deep Water." Journ. Linn. Soc. Lond., Zool. Vol. XXVIII, 1902, p. 394 (in note on *Carpenteria balaniformis*); and on p. 395 (in note on *C. raphidodendron*).

## LITHOTHAMNION SP.

A laminate or encrusting species also occurs in the limestone. It has numerous conceptacles immersed below the surface of the thallus, and therefore belongs to the above genus. The specimen is probably the encrusting condition of the foregoing species, which, being attached to a free particle, is prevented by its motion from taking on the dendroid habit of the normal form.

## FORAMINIFERA.

Fam. Miliolidæ.

Genus MILIOLINA, Williamson.

## MILIOLINA SP.

A section across the test of a milioline occurs in one of the limestone sections. It resembles *M. circularis*, Bornemann sp. in general contour. It belongs, moreover, to a group which is at home in shallow-water deposits in all parts of the world.

Fam. Textulariidæ.

Genus TEXTULARIA, DeFrance.

TEXTULARIA RUGOSA, Reuss sp.

*Plecanium rugosum*, Reuss, 1869, Sitzungsab. d. k. Ak. Wiss. Wien, Vol. LIX, p. 433, pl. i, figs. 3a, b.

*Textularia rugosa*, Reuss sp., Brady, H. B., 1884, Rep. Chall. Vol. IX, p. 363, pl. xlii, figs. 23, 24. Chapman, 1907, Journ. Linn. Soc. Lond., Zool. Vol. xxx, p. 27, pl. iii, fig. 57.

A vertical section showing the characteristic features of the test of the above species occurs in one of the thin slices of limestone. It is a peculiarly restricted coral reef species, although very rarely found under other and more argillaceous conditions in warm temperate seas. Especially was this so in past times, as in the Oligocene of Gaas,

south of France, and the Oligocene of Grice's Creek, Victoria.

*T. rugosa* is of frequent occurrence in the limestone containing *Lithothamnion* and *Lepidocyclina* of Christmas Island,<sup>1</sup> belonging to the same geological horizon as the present sample. In the living condition it has been frequently recorded from the South Pacific and East Indian areas, as round Funafuti, Honolulu, Sandwich Islands, Admiralty Islands, Friendly Islands, as well as in the Gulf of Suez.

Fam. Globigerinidæ.

Genus GLOBIGERINA, d'Orbigny.

GLOBIGERINA BULLOIDES, d'Orbigny.

*Globigerina bulloides*, d'Orbigny, 1826, Ann. Sci. Nat., Vol. VII, p. 277, No. 1, Modèles, No. 17 and No. 76. Brady, H. B., 1884, Rep. Chall. Vol. IX, p. 593, pls. lxxvii, lxxix, figs. 3-7.

Occasional small-sized tests of the above species occur in the present sample of limestone from Papua. It is a pelagic form, but by no means confined to the open sea, although there most abundant.

GLOBIGERINA TRILOBA, Reuss.

*Globigerina triloba*, Reuss, 1849, Denkschr. Akad. Wiss. Wien., Vol. I, p. 374, pl. xlvii, fig. 11. *G. bulloides*, d'Orb., var. *triloba*, Rss., Brady, H. B., 1884, Rep. Chall., Vol. IX, p. 595, pl. lxxix, figs. 1, 2; pl. lxxxii, figs. 2, 3. *G. triloba*, Rss., Chapman, 1910, Proc. Roy. Soc. Vict. Vol. XXII, (N.S.) pt. ii, p. 281.

<sup>1</sup> Jones and Chapman, "On the Foraminifera of the Orbitoidal Limestone and Reef Rock of Christmas Island." Mon. Christmas Island (Brit. Mus.) by C. W. Andrews, 1900, p. 231.

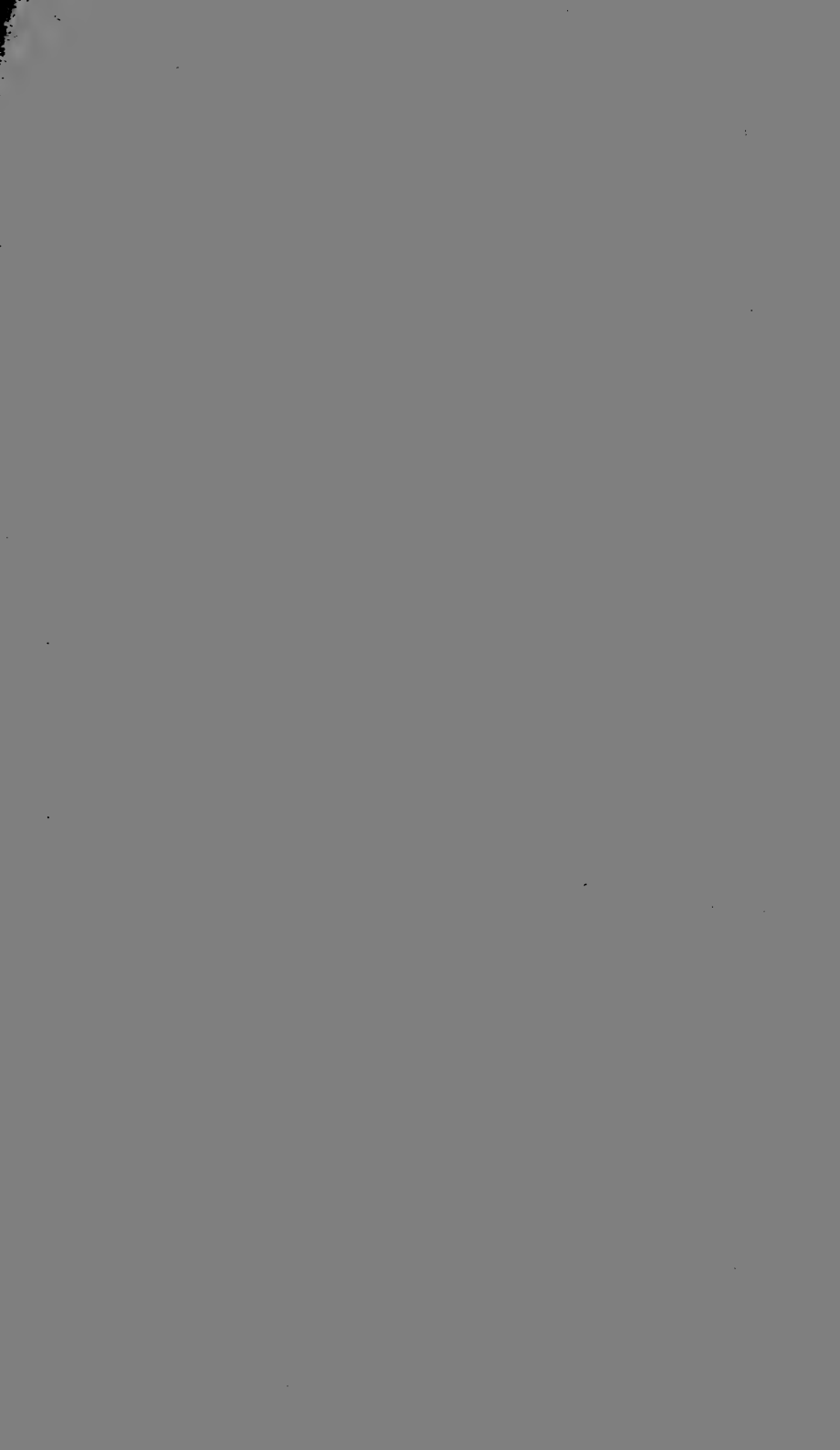

## CONTENTS.

	PAGE.
ART. IV.— <i>Continued</i> ... ..	129
ART. V.—Dimorphic Foliage of <i>Acacia rubida</i> , and Fructification during Bipinnate Stage. By R. H. CAMBAGE, F.L.S. [ <i>With Plate I.</i> ] ... ..	136
ART. VI.—The Australian Journal of Dr. W. Stimpson, Zoologist, with an introduction. By CHARLES HEDLEY, F.L.S. ... ..	140
ART. VII.—On the Nature of the Deposit obtained from Milk by Spinning in a Centrifuge, (Preliminary Communication) By H. S. HALCRO WARDLAW, B.S.C. ... ..	152
ART. VIII.—The Geology of the Cooma District, N.S.W., Part I. By W. R. BROWNE, B.S.C. [ <i>With Plates II, III, IV, V.</i> ] ... ..	172
ART. IX.—The Oxidation of Sucrose by Potassium Permanganate By C. W. R. POWELL, Science Research Scholar, University of Sydney, (Communicated by Prof. FAWSITT). ... ..	223
ART. X.—The Composition of some Lime-sulphur Sprays made according to Recognised Formulæ. By A. A. RAMSAY. (Communicated by F. B. GUTHRIE, F.I.C., F.C.S.) ... ..	242
ART. XI.—On the Diffusible Phosphorus of Cow's Milk. By H. S. HALCRO WARDLAW, B.S.C. ... ..	253
ART. XII.—Mountains of Eastern Australia and their Effect on the Native Vegetation. By R. H. CAMBAGE, F.L.S. [ <i>With Plate VI.</i> ] ... ..	267
ART. XIII.—Description of a Limestone of Lower Miocene Age from Bootless Inlet, Papua. By FREDERICK CHAPMAN, A.L.S., F.R.M.S. (Communicated by W. S. DUN). [ <i>With Plates VII, VIII, IX.</i> ] ... ..	281



ISSUED MARCH 31st, 1915.

Vol. XLVIII.

Part III.

JOURNAL AND PROCEEDINGS  
OF THE  
**ROYAL SOCIETY**  
OF  
NEW SOUTH WALES  
FOR  
1914

---

PART III., (pp. 289-520).  
CONTAINING PAPERS READ IN  
OCTOBER to DECEMBER.  
WITH SIX PLATES.  
(Plates vii, viii, ix, x, xi, xii.)



---

SYDNEY :  
PUBLISHED BY THE SOCIETY, 5 ELIZABETH STREET NORTH, SYDNEY.  
LONDON AGENTS :  
GEORGE ROBERTSON & Co., PROPRIETARY LIMITED,  
17 WARWICK SQUARE, PATERNOSTER ROW, LONDON, E.C.

1915.



Some small, rather thick-shelled examples of this pelagic species occur in the limestone from Papua. It is one of the species accompanying *Lepidocyclina* in the Miocene limestone at Batesford near Geelong.

GLOBIGERINA CONGLOBATA, Brady.

*Globigera conglobata*, Brady, 1879, Quart. Journ. Micr. Sci., Vol. XIX, N.S., p. 72. Idem, 1884, Rep. Chall. Vol. IX, p. 603, pl. lxxx, figs. 1-5; pl. lxxxii, fig. 5.

A few typical examples of this stoutly-built, pelagic foraminifer, so frequently met with in tropical coral-reef deposits, both fossil and recent, occur here. The closely adpressed outer chambers and their excessively thick walls distinguish the form from others of this genus.

Fam. Rotaliidæ.

Genus TRUNCATULINA, d'Orbigny.

TRUNCATULINA cf. LOBATULA, Walker and Jacob sp.

*Nautilus lobatulus*, Walker and Jacob, 1798, Adams' Essays, Kanmacher's ed., p. 642, pl. xiv, fig. 36.

*Truncatulina lobatula*, W. and J. sp., Brady, 1884, Rep. Chall., Vol. IX, p. 660, pl. xcii, fig. 10; pl. xciii, figs. 1, 4, 5; pl. cxv, figs. 4, 5.

A partial section of a thin-walled *Truncatulina*, probably nearest to the above species, occurs in the Papuan *Lepidocyclina* rock. It is a common shallow-water form in almost all existing seas.

Genus CARPENTERIA, Gray.

CARPENTERIA CAPITATA, Jones and Chapman. Pl. VII, fig. 1.

*Carpenteria capitata*, Jones and Chapman, 1900, Mon. Christmas Island (Brit. Mus.), p. 246, pl. xx, fig. 7.

The test in this species is thicker than in *C. monticularis*,<sup>1</sup> and, unlike *C. utricularis*,<sup>2</sup> has a smooth exterior. From *C. raphidodrendon*<sup>3</sup> it is separated by its non-rambling habit, showing a tendency rather to connect *Rupertia stabilis*<sup>4</sup> with *Carpenteria proteiformis*.<sup>5</sup>

Sections of *Lepidocyclina* limestone from Triomoté Island, Loo Choo Islands, show the rock to contain numerous remains of *Carpenteria* which Messrs. Newton and Holland<sup>6</sup> have compared in one instance with the above species, *C. capitata*.

The Christmas Island specimen measures 6 mm. in height, whilst the largest specimen in the present limestone sample is 2.5 mm. Several specimens occur in the limestone sections examined.

#### Genus ROTALIA, Lamarck.

##### ROTALIA CALCAR, d'Orbigny sp.

*Calcarina calcar*, d'Orbigny, 1826, Ann. Sci. Nat., Vol. VII, p. 276, No. 1; Modèle, No. 34. Idem, 1839, Foram. Cuba, p. 93, pl. v, figs. 22 - 24.

<sup>1</sup> *C. monticularis*, Carter, Ann. Mag. Nat. Hist., Ser. 4, Vol. XIX, 1877, p. 211, pl. xiii. Brady, Rep. Chall. Vol. IX, 1884, p. 677, pl. xcix, figs. 1 - 5. Chapman, Journ. Linn. Soc. Lond., Zool., Vol. XXVIII, 1900, p. 14, pl. ii, fig. 5; pl. iv, figs. 5, 6.

<sup>2</sup> *Polytrema utricularis*, Carter, Ann. Mag. Nat. Hist., Ser. 4, Vol. XVII, 1876, p. 210, pl. xiii, figs. 11 - 16. *Carpenteria utricularis*, Carter sp., Brady, Rep. Chall. Vol. IX, 1884, p. 678, pl. xcix, figs. 6, 7; pl. c, figs. 1 - 4. Chapman, Journ. Linn. Soc. Lond., Zool., Vol. XXVIII, 1900, p. 12, pl. ii, fig. 4; pl. iv, figs. 3, 4.

<sup>3</sup> *C. raphidodendron*, Moebius, Tageblatt der 49 Versammlung deutscher Naturforscher und Aerzte in Hamburg, 1876, p. 115. Chapman, Journ. Linn. Soc. Lond., Zool., Vol. XXVIII, 1900, p. 395, pl. xxv, fig. 2.

<sup>4</sup> *Rupertia stabilis*, Wallich, Ann. Mag. Nat. Hist., Ser. 4, Vol. XIX, 1877, p. 501, pl. xx. Jones and Chapman, Mon. Christmas Island, 1900, p. 254, pl. xxi, fig. 11.

<sup>5</sup> *Carpenteria balaniformis* var. *proteiformis*, Goës, Retic. Rhizop. Carib. Sea, 1882, p. 94, pl. vi, figs. 203 - 214; pl. vii, figs. 215 - 219. *C. proteiformis*, Goës, Brady, Rep. Chall., Vol. IX, 1884, p. 679, pl. xcvi, figs. 8 - 14.

<sup>6</sup> Journ. Coll. Sci. Imp. Univ., Tokyo, Vol. XVII, Art. 6, 1902, p. 15, pl. ii, fig. 3.

*Rotalia calcar*, d'Orb. sp., Brady, 1884, Rep. Chall., Vol. IX, p. 709, pl. cviii, fig. 3. Chapman, 1910, Proc. Roy. Soc. Vict., Vol. XXII (N.S.), pt. ii, p. 289, pl. iii, fig. 2.

This is a typical coral-reef species at the present day. As a fossil it occurs in the older Muddy Creek beds (Oligocene); and in the Batesford limestone series (Miocene).

One or two specimens with the salient features well-defined, occur in the limestone. They show the strong papillæ and vestiges of the spurs of secondary shell-growth of this species.

Fam. Nummulinidæ.

Genus AMPHISTEGINA, d'Orbigny.

AMPHISTEGINA LESSONII, d'Orbigny. Plate VII, fig. 2;  
Plate IX, fig. 8.

*Amphistegina lessonii*, d'Orbigny, 1826, Ann. Sci. Nat., Vol. VII, p. 304, No. 3, pl. xvii, figs. 1-4; Modèle, No. 98. Brady, 1884, Rep. Chall. Vol. IX, p. 740, pl. cxi, figs. 1-7. Flint, 1899, Rep. U.S. Nat. Mus. (Rep. for 1897), p. 338, pl. lxxx, fig. 4.

The lenticular tests of the above species are very abundant in portions of the Papuan limestone. The majority of the shells are of the thick, inæquilateral type, typical of the warmer areas of the coral seas at moderately shallow depths. The post-Miocene limestone of Port Stanley, New Hebrides, contains similar varietal forms with thickened tests, associated with the encrusting *Polytrema planum*, Carter.<sup>1</sup>

Genus OPERCULINA, d'Orbigny.

OPERCULINA COMPLANATA, Defrance sp. Plate VII, fig. 2.

*Lenticulites complanata*, Defrance, 1822, Dict. Sci. Nat., Vol. XXV, p. 453.

<sup>1</sup> As at Funafuti and elsewhere, see Chapman, Journ. Linn. Soc. Lond., Zool., Vol. XVIII, 1901, p. 205.

*Operculina complanata*, DeFrance sp., Newton and Holland, 1902, Journ. Coll. Sci., Imp. Univ. Tokyo, Vol. xvii, Art. 6, p. 13, pl. i, figs. 3, 5; pl. iii, fig. 3. Chapman, 1908, Proc. Linn. Soc. N. S. Wales, Vol. xxxii, pt. iv, p. 749, pl. xxxvii, figs. 1, 2; pl. xxxviii, fig. 3.

Several tests of the above species occur in the limestone sections; but the form is not so common as that of *Heterostegina depressa* in the same rock, and which it much resembles in section. In *Heterostegina* the area around the umbilical axis in vertical section is correspondingly thicker than in *Operculina*, and a few fragments in horizontal section bear out this determination.

*O. complanata* is a typical and common form in almost all Cainozoic deposits laid down in warm temperate seas. Amongst other places it occurs at Muddy Creek, Victoria (Oligocene), and the New Hebrides (Miocene); as well as in the Raised Coral Reefs of the Loo Choo Islands, Japan (? Pleistocene).

Genus HETEROSTEGINA, d'Orbigny.

HETEROSTEGINA DEPRESSA, d'Orbigny. Plate IX, fig. 9.

*Heterostegina depressa*, d'Orbigny, 1826, Ann. Sci. Nat., Vol. VII, p. 305, pl. xvii, figs. 5-7; Modèle, No. 99. Brady, 1884, Rep. Chall., Vol. IX, p. 746, pl. cxii, figs. 14-20. Chapman, 1900, Journ. Linn. Soc. Lond. Zool., Vol. xxviii, p. 18, pl. iii, figs. 6, 7.

Unlike the structure of the living forms of this species, which show in the majority of cases that they belong to the megalospheric stage (propagation by budding), the Papuan fossil examples are nearly always microspheric (adapted for sexual generation).

*H. depressa* is very common in thin slices of the Papuan limestone. The species is widely distributed, generally in coral seas and warm temperate areas, and is found fossil from Eocene times.

## HETEROSTEGINA MARGARITATA, Schlumberger.

Plate IX, fig. 11.

*Heterostegina margaritata*, Schlumberger, 1902, Samml. Geol. Reichs. Mus. Leiden, Ser. 1, Vol. VI, pt. iii, p. 252, pl. vii, fig. 4.

One or two well marked examples of this species are found in the limestone sections. They are easily distinguished from *H. depressa* not only by the pustulate ornament of the surface, but from the internal structure seen in section, in which the cones of non-tubulate shell are distinctly marked off from the rest of the test.

The species probably occurs also in the Middle Miocene (Janjukian) of Batesford, as previously remarked by the writer.<sup>1</sup>

Schlumberger's specimens came from Tewe, Borneo, and his figured example shows the megalospheric stage.

## Genus CYCLOCLYPEUS, Carpenter.

CYCLOCLYPEUS COMMUNIS, Martin. Plate IX, fig. 8.

*Cycloclypeus communis*, Martin, 1880, Niederländische Archiv für Zool., Leyden, Vol. v, p. 191, pl. xiii, figs. 1, 2.

Fragments of the tests of this generic type are distributed throughout the Papuan limestone. No isolated test-fragments could be seen, however, on the small portion of the weathered surface of the rock examined, so that a definite determination of the species was impossible.

Two species of this genus have already been recorded from Miocene *Lepidocyclina* limestone; one of these is the above species from Java (Martin) and Borneo (H. Douvillé), the other being *C. pustulosus*, Chapman, from the New Hebrides<sup>2</sup> and Batesford near Geelong.<sup>3</sup>

<sup>1</sup> Proc. Roy. Soc. Vict., Vol. XXII, (N.S.), pt. ii, 1910, p. 295.

<sup>2</sup> Journ. Linn. Soc. N. S. Wales, Vol. xxx, 1905, p. 271, pl. v, fig. 1; pl. vi, fig. 2; pl. vii, fig. 2.

<sup>3</sup> Proc. Roy. Soc. Vict., Vol. XXII, (N.S.), pt. ii, 1910, p. 295, pl. ii, fig. 6; pl. v, fig. 4.

The lengths of the chamberlets near the centre of the disc in *C. communis*, as given by Martin, measure  $\frac{1}{10}$  mm., whilst that of *C. pustulosus* is much smaller, being only about  $\frac{1}{42}$  mm. In the present example the chamberlets of about the third annulus from the primordial chambers have a mean length of  $\frac{1}{14}$  mm., so that the evidence in this respect is in favour of a reference to the above species, *C. communis*.

Genus LEPIDOCYCLINA, Gümbel.

LEPIDOCYCLINA SUMATRENSIS, Brady sp. Plate VII, fig. 3.

*Orbitoides sumatrensis*, Brady, 1875, Geol. Mag., Dec. II, Vol. II, p. 536, pl. xiv, fig. 8.

*Orbitoides (Lepidocyclina) sumatrensis*, Brady, Newton and Holland, 1899, Ann. Mag. Nat. Hist., Ser. 7, Vol. III, p. 259, pl. x, figs. 7, 8, 10, 11 (fig. 12 = *L. tournoueri*, Lem. and Douv.). Jones and Chapman, 1900, Mon. Christmas Island (Brit. Mus.), p. 244, pl. xx, fig. 6.

*Lepidocyclina sumatrensis*, Brady sp., Silvestri, A., 1906, Atti della Pontificia Accad. Rom. d. Nuovi Lincei, Anno LIX, p. 150.

Some typical and beautifully preserved specimens of *L. sumatrensis* occur in the limestone sections. They are of average dimensions, having a diameter of about 3 mm. The Borneo specimens also have a diameter of 3 mm., whilst those from the Loo Choo Islands are only 1.5 mm.

Lemoine and Douvillé have recorded *L. cf. sumatrensis* from France and Spain,<sup>1</sup> but that particular form is herein referred to *L. Andrewsiana*, Jones and Chapman for reasons subsequently mentioned. *L. sumatrensis* has been cited, with some reservation by the present writer, from the New Hebrides Miocene.<sup>2</sup> Other localities for this species are,

<sup>1</sup> Mem. Soc. Geol. France, Vol. XII, pt. ii, 1904, p. 18, pl. i, fig. 14; pl. ii, fig. 15; pl. iii, fig. 6.

<sup>2</sup> Chapman, Journ. Linn. Soc. N. S. Wales, Vol. xxx, 1905, p. 267, and *ibid.*, Vol. xxxii, pt. 4, 1908, p. 753.



Borneo, Sumatra, Christmas Island and the Loo Choo Islands, Japan.

LEPIDOCYCLINA ANDREWSIANA, Jones and Chapman sp.

Plate IX, fig. 8.

*Orbitoides (Lepidocyclina) Andrewsiana*, Jones and Chapman, 1900, Mon. Christmas Island (Brit. Mus.), p. 255, pl. xxi, fig. 14.

*Lepidocyclina sumatrensis*, Newton and Holland (non Brady), 1902, Journ. Coll. Sci. Imp. Univ., Tokyo, Vol. XVII, Art. 6, p. 11, pl. i, fig. 7.

*L. cf. sumatrensis*, Brady, Lemoine and Douvillé, R., 1904, Mem. Soc. Geol. France, Vol. XII, pt. ii, p. 18, pl. i, fig. 14; pl. ii, fig. 15; pl. iii, fig. 6.

*L. Andrewsiana*, J. and C., Chapman, 1908, Journ. Linn. Soc. N.S. Wales, Vol. XXXII, p. 757, pl. xxxix, fig. 10.

This species is distinguished from *L. sumatrensis*, Brady sp., by its lenticular rather than subglobular shape, the circumferential disc as a rule being pronounced. It is a larger species than *L. sumatrensis*, averaging about six millimetres in diameter. The megalospheric condition seems to obtain in all the specimens examined or described. Lemoine and Douvillé figure interesting examples from Spain, France and Italy under the name of *L. cf. sumatrensis*, Brady, but marked differences from that species are evident in the more numerous pustulate central area of the disc, and the tendency to develop a depressed border. These differences have already been noticed by Dr. A. Silvestri,<sup>1</sup> who refers to this form under a separate heading from the species identified with Brady's true *L. sumatrensis*. From *L. tournoueri*, *L. Andrewsiana* is chiefly distinguishable by the compact structure of the latter as regards the peripheral layers. The examples from the Loo Choo Islands

<sup>1</sup> Atti della Pontificia Accad. Rom. d. Nuovi Lincei, Anno LIX, p. 150.

described and figured by Newton and Holland also belong to this species.

*Distribution.*—Spain, France, Italy, New Hebrides, Loo Choo Islands, and Christmas Island.

LEPIDOCYCLINA MURRAYANA, Jones and Chapman sp.

Plate VIII, fig. 7.

*Orbitoides (Lepidocyclina) Murrayana*, Jones and Chapman, 1900, Mon. Christmas Island (Brit. Mus.), p. 252, 253, pl. xxi, fig. 10.

*Lepidocyclina formosa*, Schlumberger, 1902, Samml. des Geol. Reichs-Mus. Leyden, Ser. 1, Vol. VI, pt. 3, p. 251, pl. vii, figs. 1–3. Douvillé, R., 1909, Ann. Soc. Roy. Zool. et Malac. de Belgique, Vol. XLIV, p. 135, pl. vi, figs. 1, 2. Provale, 1909, Rivista Ital. Pal., Anno xv, p. 5, pl. ii, figs. 1–3.

The test of this striking species, which belongs to the group of *L. dilatata*, Michelotti and *L. insulae-natalis*, Jones and Chapman, has an undulating disc, which, when cut equatorially, gives the appearance of a central disc with four or more rays. Schlumberger described his *L. formosa* as a new species, on the supposition that our *L. Murrayana* had rectangular chambers. This was evidently due to a misreading of our original description, where, speaking of *Orbitoides stellata*, we state<sup>1</sup> of that species that it “has rectangular chambers in the median plane and consequently belongs to the *Discocyclina* series.” However, we proceed to say “the earlier known species (*O. stellata*) having rectangular chambers in the median plane, we have named this form, which has the rounded imbricated chambers, distinctively as *Orbitoides (Lepidocyclina) Murrayana*.” It follows therefore that *L. formosa* drops into the synonymy of the above species.

<sup>1</sup> Mon. Christmas Island (Brit. Mus.), 1900, p. 253.

*Distribution*.—Christmas Island, Indian Ocean (Chapman); Borneo (Schlumberger); German East Africa and Madagascar (R. Douvillé).

LEPIDOCYCLINA VERBEEKI, Newton and Holland sp.

Plate VIII, figs. 5, 6 ; Plate IX, fig. 10.

*Orbitoides papyracea*, Brady (non Boubée), 1875, Geol. Mag. Dec. II, Vol. II, p. 535, pl. xiv, fig. 1.

*Lepidocyclus* sp. *g* and *k*, Verbeek and Fennema, 1896, Descr. Geol. de Java et Madoura, Vol. I, pl. xi, figs. 173–175, 177–180; Vol. II, p. 1178.

*Orbitoides (Lepidocyclus) Verbeeki*, Newton and Holland, 1899, Ann. Mag. Nat. Hist., Ser. 7, Vol. III, p. 257, pl. ix, figs. 7–11; pl. x, fig. 1. Jones and Chapman, 1900, Mon. Christmas Island (Brit. Mus.), p. 245. Newton and Holland, 1902, Journ. Coll. Sci. Imp. Univ. Tokyo, Vol. xvii, Art. 6, p. 12.

*Orbitoides? Verbeeki*, M. and H., Smith, W. D., 1906, Phil. Journ. Sci., Vol. I, No. 2, p. 206, pl. ii, fig. 1.

This modification of the species, represented by form *A*, is abundant in the Papuan limestone. It is distinguished from *L. Andrewsiana* by its more lenticular shape and absence of large, well-marked pillars; the superficial papillæ, representing the terminations of these pillars, being very small, and imparting a granulate appearance to the exterior. As a rule the tests are regular, but occasionally the disc tends to become slightly flexuose, but not to so marked a degree as in *L. Murrayana*.

Form *A*.—This is very common. The diameter of the test averages about 7 mm. Verbeek's figured specimen measures 4·6 mm. The megaspheres in the Papuan examples have a larger diameter of 690 $\mu$ –1170 $\mu$ ; whilst Verbeek's specimen is only 360 $\mu$ .

Form B.—This form is rare and of large dimensions, one specimen when complete measuring 23 mm. in diameter.

The enormous development of the form A and its extraordinarily large megasphere make it necessary to refer this form, the most abundant in the Papuan limestone, to a new variety of *L. Verbeeki*, viz., var. *papuaensis*.

*Distribution.*—*L. Verbeeki*, which in all previously figured specimens are of the megalospheric form, excepting perhaps the occurrence in the Philippines recorded by W. D. Smith, occurs in Sumatra, Borneo, Christmas Island, Formosa, the Loo Choo Islands, and probably the Philippines.

The present Papuan occurrence appears to be the first undoubted record of the species in the microspheric stage. (Form B.)

#### ECHINODERMATA.

##### Echinoid spines and plates.

The radioles of several types, probably belonging to more than one species of sea-urchin are present in this limestone. Remains of the plates of the test in addition show this group to be well represented in the sub-littoral fauna at the time. None of the remains are determinable, although in all probability both diadematoids and spatangoids are present.

#### POLYZOA.

Fragmental remains of indeterminate remains of polyzoa are occasionally seen in this limestone.

#### PISCES.

Tooth of fish, allied to ? *Chrysophrys*, Plate VII, fig. 4.

An oblique section of a fish tooth occurs, amongst other obscure fish remains, in one of the limestone sections. On comparing it with a section of the tooth of the living *Chrysophrys* (Sea Bream), the structure is seen to be almost identical, and different from the tooth structure of the *Labridæ* (Wrasses), both of which groups, however, are characteristic feeders on shell-fish and similar food.

## 4. Summary.

The following organic remains have herein been determined as from the *Lepidocyclina* limestone at creek head, one and a half miles inland from Bootless Inlet, Papua:—

*Lithothamnion ramosissimum*, Reuss sp.

*Miliolina* sp.

*Textularia rugosa*, Rss. sp.

*Globigerina bulloides*, d'Orbigny.

„ *triloba*, Rss.

„ *conglobata*, Brady

*Truncatulina* cf. *lobatula*, W. and J. sp.

*Carpenteria capitata*, J. and C.

*Amphistegina lessonii*, d'Orb.

*Operculina complanata*, DeFr. sp.

*Heterostegina depressa*, d'Orb.

„ *margaritata*, Schlumberger.

*Cyclocypeus* cf. *communis*, Martin.

*Lepidocyclina sumatrensis*, Brady sp.

„ *Andrewsiana*, J. and C. sp.

„ *Murrayana*, J. and C. sp.

„ *Verbeeki*, Newton and Holland sp. var.  
*papuaensis*, nov.

Echinoderm remains, indet.

Polyzoa, indet.

Fish tooth, cf. *Chrysophrys*.

Amongst these organisms the important factors in the determination of the Lower Miocene age of the limestone are the genera and species of *Carpenteria*, *Heterostegina*, *Cyclocypeus* and *Lepidocyclina*.

A comparison of the Papuan series of fossils may be profitably made with those given in the table of stages in the Cainozoic series of Borneo by H. Douvillé.<sup>1</sup> This was

<sup>1</sup> "Les Foraminifères dans le Tertiaire de Bornéo." Bull. Soc. Geol. France, Ser. 4, Vol. v, 1905, p. 454.

based on a collection of rocks made in Borneo by Dr. Buxtorf. It shows the Papuan series to be nearest related to Douvillé's stage 10 or Upper Aquitanian, with a slight leaning towards the Lower Aquitanian indicated by the presence of *L. Murrayana*, J. and C. (= *L. formosa*, Schl.). The Upper Aquitanian, however, contains the majority of genera and species found in the present series, as *Heterostegina margaritata*, *Cycloclypeus communis* and *L. Verbeeki*, the latter belonging to the *L. insulæ-natalis* group, with large or medium sized tests, small or undeveloped pillars and closely-set and widely-expanded chamberlets in the peripheral zone. The range of *L. Murrayana* (= *L. formosa*) moreover, is really of higher range in the geological scale than H. Douvillé sets forth in his table, for, as already remarked, this species belongs to the *L. dilatata* group, which is characteristic of the Upper Aquitanian in Italy. In that country Dr. A. Silvestri has shown<sup>1</sup> that *L. dilatata* occurs in company with *L. marginata*, a species which is found in the Miocene of the Geelong District at Batesford, Victoria.

In conclusion it may be noted that this occurrence of a Lower Miocene horizon in Papua is of exceptional interest as showing the existence of another link in the chain of localities where the beds of the old shore-line of the ancient Tethyan sea were laid down. It thus helps to connect with the Victorian occurrence at Batesford, in all probability by way of a portion of the lost shore-line indicated by the subsiding area now occupied in part by the Great Barrier Reef off the north-eastern coast of Australia: whilst a divergent arm extended as far as New Zealand, as shown by the occurrence of *Lepidocyclinæ* at Orakei Bay.

---

<sup>1</sup> "Distribuzione geografica e geologica di Due Lepidocycline comuni nel Terziario Italiano." Mem. del Pont. Acc. Rom. d. Nuovi Lincei, vol. xxix, 1911, p. 52.

## EXPLANATION OF PLATES.

## Plate VII.

- Fig. 1. *Carpenteria capitata*, Jones and Chapman. Section nearly vertical to the plane of growth.  $\times 26$ .
- „ 2. *Operculina complanata*, DeFrance, and *Amphistegina lessonii*, d'Orb. Several vertical sections.  $\times 26$ .
- „ 3. *Lepidocyclus sumatrensis*, Brady sp. Vertical section.  $\times 13$ .
- „ 4. Vertical section of fish tooth (? *Chrysophrys*), showing vasodentinal structure.

## Plate VIII.

- Fig. 5. *Lepidocyclus Verbeeki*, Newton and Holland sp., var. *papuaensis*, nov. Form B. Vertical section.  $\times 8$ .
- „ 6. *L. Verbeeki* var. *papuaensis*, nov. Form A. Vertical section.  $\times 13$ .
- „ 7. *L. Murrayana*, Jones and Chapman sp. Form A. Vertical section.  $\times 16$ .

## Plate IX.

- Fig. 8. *Lepidocyclus Andrewsiana*, Jones and Chapman sp. Form A. Vertical section: *Amphistegina lessonii*, d'Orb., and *Cycloclypeus* cf. *communis*, Martin.
- „ 9. *Heterostegina depressa*, d'Orbigny sp. Vertical section.  $\times 26$ .
- „ 10. *Lepidocyclus Verbeeki*, var. *papuaensis*, nov. Form A. Vertical section.  $\times 17$ .
- „ 11. *Heterostegina margaritata*, Schlumberger. Vertical section.  $\times 19$ .
-

## NOTES ON TASMANIAN HYDROZOA.

By E. A. BRIGGS, B.Sc.,

Zoologist, Australian Museum, Sydney.

(Communicated by C. HEDLEY, F.L.S., with the authority of the Trustees of the Australian Museum.)

With Plates X - XI.

---

[Read before the Royal Society of N. S. Wales, November 4, 1914.]

---

**I. Introduction.**

During a recent Easter encampment of the Tasmanian Field Naturalists' Club, several successful hauls of the dredge were made in the neighbourhood of Freycinet Peninsula, on the eastern coast of Tasmania. By permission of the Trustees of the Australian Museum I was enabled to accompany the party officially, and I obtained a large collection which includes numerous representatives of several invertebrate groups. In company with Professor T. T. Flynn, another day was spent collecting in the D'Entrecasteaux Channel where additional material was secured.

Owing to the generosity of the authorities of the Tasmanian Museum, I have also been enabled to examine the Hydroid collection under their charge which includes a considerable number of local species.

The Hydroids dealt with in the present paper were collected at four definite areas—within Thouin or Wineglass Bay, Freycinet Peninsula, 11 fathoms; off Thouin Bay, 80 fathoms; Storm Bay; and D'Entrecasteaux Channel, 2 to 11 fathoms. The following notes refer to the family *Plumularidæ*, which is represented by fourteen species,



eight of which are here recorded for the first time from the eastern coast of Tasmania. The occurrence among the specimens of *Aglaophenia armata*, and *Aglaophenia tenuissima* is of interest since these species have only within the last month been described by Mr. W. M. Bale from Queensland and the Great Australian Bight respectively. In addition, the collection includes *Nemertesia ciliata*, Bale, recently described from Oyster Bay, Tasmania.

*List of Species.*

Phylum COELENTERATA.

Class HYDROZOA.

Order CALYPTOBLASTEÆ.

Family Plumularidæ.

- \**Plumularia buskii*, Bale.
- \*     ,,     *procumbens*, Spencer.
- \*     ,,     *sulcata*, Lamarck.
- Nemertesia ciliata*, Bale.
- \**Kirchenpaueria mirabilis* (Allman).
- Halicornopsis elegans* (Lamarck).
- Halicornaria furcata*, Bale, var. *intermedia*, Bale.
- \*     ,,     *longirostris* (Kirchenpauer).
- \*     ,,     *superba* (Bale).
- \**Aglaophenia armata*, Bale.
- ,,     *decumbens*, Bale.
- ,,     *divaricata* (Busk).
- ,,     *tasmanica*, Bale.
- \*     ,,     *tenuissima*, Bale.

**II. Description of the Species.**

Order CALYPTOBLASTEÆ.

Family Plumularidæ.

Genus PLUMULARIA, Lamarck.

---

\* Indicates that the species is here recorded for the first time from the eastern coast of Tasmania.

## PLUMULARIA BUSKII, Bale.

*Plumularia buskii*, Bale, Cat. Austr. Hydroid Zoophytes, 1884, p. 125, pl. x, fig. 3, pl. xix, figs. 34, 35; *id.*, Bale, Trans. Roy. Soc. Vict., xxiii, 1886, p. 94; *id.*, Hartlaub, Zool. Jahrb. Syst., xiv, 1901, p. 374, pl. xxii, figs. 22, 32, 36; *id.*, Thornely, Rep. Ceylon Pearl Oyster Fisheries, pt. 2, Suppl. Rep., viii, Hydroidea, 1904, p. 120; *id.*, Ritchie, Proc. Zool. Soc., 1910, p. 832; *id.*, Bale, Biological Results "Endeavour," ii, i, 1914, p. 28.

*Plumularia buski*, Billard, Les Hydroides de l' Expedition du Siboga, i, Plumulariidae, 1913, p. 21, pl. i, fig. 15.

*Plumularia nuttingi*, Billard, Arch. Zool. Exp., (5), viii, 1911, p. lxvi, fig. 8.

I have included in the synonymy of this species the Hydroid, which Hartlaub has recorded from Laysan under the name of *P. buskii*, Bale, although the minute sarcotheca immediately behind the hydrotheca is undoubtedly absent. With regard to the identity of *Plumularia nuttingi*, a further examination of the type specimen in the Siboga collection has convinced Billard that this species is identical with *P. buskii*, Bale.

A few well-preserved colonies, the largest 50 mm. in height, do not differ from others in the Australian Museum from St. Francis Island, South Australia, and from King Island, Bass Strait.

*Dimensions.*—

Stem internode, length	...	...	0·70 — 0·73 mm.
Stem internode, diameter	...	...	0·29 — 0·33 „
Hydroclade, length	...	...	up to 9 „
Hydroclade, thecate internode, length	...	...	0·57 — 0·61 „
Hydrotheca, depth	...	...	0·29 — 0·31 „
Hydrotheca, diameter at mouth	...	...	0·26 — 0·28 „

*Locality.*—D'Entrecasteaux Channel, Tasmania, 2—11 fathoms.

*Distribution.*—Previously recorded from Griffith Point, Victoria (Bale); Laysan Island, Hawaiian Archipelago (Hartlaub); Gulf of Manaar, Ceylon (Thornely); Flying-Fish Cove, Christmas Island, Indian Ocean (Ritchie); Great Australian Bight, 40–100 fathoms (Bale). Billard records the presence of *P. buskii* at nine stations in the eastern part of the Indian Archipelago (Siboga Expedition).

PLUMULARIA PROCUMBENS, Spencer.

(Plate X, fig. 1.)

*Plumularia procumbens*, Spencer, Trans. Roy. Soc. Vict., II, 1891, p. 130, pls. xxi–xxiii; *id.*, Bale, Proc. Roy. Soc. Vict., (n.s.), VI, 1893, p. 115, pl. v, figs. 11, 12; *id.*, Bale, Biological Results "Endeavour," ii, I, 1914, p. 29.

The specimens of this species in the present collection agree with Spencer's description and with the type in the Australian Museum, except for the presence of a nematophore on some of the short intermediate internodes of the hydrocladia, an arrangement which Bale has described in the case of specimens of *P. procumbens* from Port Phillip and the Great Australian Bight.

*Dimensions.*—

Hydroclade-bearing internode, length	...	0·61–0·64	mm.
Hydroclade-bearing internode, diameter		0·12–0·14	„
Hydroclade internode, hydrothecate, length		0·29–0·31	„
Hydroclade internode, intermediate, length		0·10–0·12	„
Hydroclade internode, diameter	...	0·03–0·04	„
Hydrotheca, depth	... ..	0·05–0·06	„
Hydrotheca, diameter at mouth	... ..	0·08	„
Supracalycine sarcotheca, length	... ..	0·07–0·08	„

*Locality.*—Off Thouin or Wineglass Bay, Freycinet Peninsula, Tasmania, 80 fathoms.

*Distribution.*—Previously recorded from Port Phillip, Victoria (Spencer); Great Australian Bight, 40–100 fathoms (Bale).

## PLUMULARIA SULCATA, Lamarck.

(Plate XI, fig. 1.)

- Plumularia sulcata*, Lamarck, Hist. nat. Anim. sans Vertèbres, 1816, p. 128; *id.*, Bale, Cat. Austr. Hydroid Zoophytes, 1884, p. 145; *id.*, Billard, Ann. Sci. Nat., Zool., (9), v, 1907, p. 321; *id.*, Ritchie, Mem. Austr. Mus., iv, 16, 1911, p. 852, pl. lxxxiv, fig. 3, pl. lxxxix, fig. 5; *id.*, Ritchie, Proc. R. Phys. Soc. Edinburgh, xix, 1, 1913, p. 6; *id.*, Bale, Biological Results "Endeavour," II, 4, 1914, p. 172, pl. xxxv, figs. 6, 7.
- Plumularia aglaophenoides*, Bale, Cat. Austr. Hydroid Zoophytes, 1884, p. 126, pl. x, fig. 6.

Owing to the very imperfect nature of Lamarck's original description of *Plumularia sulcata*, the species was not again identified until his type was recently examined and described in full by Billard. Meanwhile the first detailed description of this species was published by Bale, who described it as new in 1884, under the name of *Plumularia aglaophenoides*, but the examination of the type of *P. sulcata* enabled Billard to recognise its identity with Bale's species. Further details of the specific characters of the species have been added by Ritchie and also by Bale, the latter author describing the gonosome. Previous to the publication of Bale's report on the "Endeavour" Hydroida, the gonosome had not been observed, and it is interesting to note the occurrence among the present specimens of a colony with gonangia. Bale's description reads as follows: "Gonothecæ large, urceolate, slightly narrowed upward and again expanding to the summit, margin circular, oblique, not contracted nor thickened; a stout transverse ridge inside the front a little below the margin; a large operculum the full width of the gonotheca, slightly convex in the middle, situated inside the margin and resting on the internal ridge in front; several large sarcothecæ (often five or six) surrounding the base."

*Dimensions.*—

Gonosome, length...	...	...	...	up to 1.6 mm.
Gonosome, maximum diameter...	...	0.70	–	0.71 ,,

*Locality.*—Off Thouin or Wineglass Bay, Freycinet Peninsula, Tasmania, 80 fathoms.

*Distribution.*—Previously recorded from Mers australes (Lamarck); Broughton Island, New South Wales, 25 fathoms (Bale); Station 48, off Wollongong, New South Wales, 55–56 fathoms (Ritchie); Bass Strait, 40 fathoms; Fifty miles south of Cape Wiles, South Australia, 75 fathoms (Bale).

## Genus NEMERTESIA, Lamouroux.

## NEMERTESIA CILIATA, Bale.

(Plate X, fig. 3.)

*Nemertesia ciliata*, Bale, Biological Results "Endeavour," II, 4, 1914, p. 170, pl. xxxvi, fig. 1.

There is a considerable amount of variation in the details of the structure of this species recently described by Bale from Oyster Bay, Tasmania. A single robust colony 213 mm. in height, was dredged in the neighbourhood of the type locality. The stem and main branches are polysiphonic and give off numerous small monosiphonic branchlets. These, as in Bale's specimens, are divided into internodes which support from one up to six or eight whorls of hydrocladia. Each whorl usually consists of three hydrocladia: in a few instances four were observed. There was no trace of gonosome. The colour of the colony is very dark brown. A specimen (locality unknown) in the Tasmanian Museum is similar to the type, being light brown in colour.

*Dimensions.*—

Hydroclade internode, hydrothecate, length	0.26	–	0.29 mm.
Hydroclade internode, intermediate, length	0.15	–	0.17 ,,
Hydroclade internode, diameter	...	...	0.05 – 0.06 ,,
Hydrotheca, depth	...	...	0.05 ,,
Hydrotheca, diameter at mouth	...	...	0.05 – 0.06 ,,

*Locality*.—Off Thouin or Wineglass Bay, Freycinet Peninsula, Tasmania, 80 fathoms.

*Distribution*.—Hitherto recorded only from Oyster Bay, Tasmania, 60 fathoms (Bale).

Genus KIRCHENPAUERIA, Jickeli.

KIRCHENPAUERIA MIRABILIS (Allman).

*Diplocheilus mirabilis*, Allman, Rep. Sci. Res. "Challenger" Exped., Zool., VII, Hydroida, pt. i, 1883, p. 49, pl. viii, figs. 4-7; *id.*, Stechow, Abh. K. Bayer. Akad. Wissensch., I, Suppl. Bd., 1909, p. 89; *id.*, Ritchie, Mem. Austr. Mus., IV, 16, 1911, p. 854.

*Kirchenpaueria mirabilis*, Bale, Proc. Roy. Soc. Vict., (n.s.), VI, 1894, p. 109, pl. vi, figs. 4-7; *id.*, Warren, Ann. Natal Govt. Mus., I, 1908, p. 321, fig. 15.

*Plumularia mirabilis*, Billard, Ann. Sci. Nat., Zool., (n.s.), XI, 1910, p. 37.

Many specimens of this species were obtained, which do not differ in any important particular from the type. The characteristic gonangia are present on several of the colonies.

*Dimensions*.—

Stem internode, length	...	...	...	0·87-1·13 mm.
Stem internode, diameter	...	...	...	0·17-0·19 "
Hydroclade internode, length	...	...	...	0·59-0·64 "
Hydrotheca, depth	...	...	...	0·28-0·31 "
Hydrotheca, diameter at mouth (side view)	...	...	...	0·28-0·33 "
Gonangium, length	...	...	...	up to 2·5 "
Gonangium, maximum diameter	...	...	...	0·87 "

*Localities*.—Storm Bay, Tasmania; D'Entrecasteaux Channel, Tasmania, 2-11 fathoms.

*Distribution*.—Previously recorded from Station 162, off Moncœur Island, Bass Strait, 38-40 fathoms (Allman);

Port Phillip and Griffith Point, Victoria (Bale); Scottburgh, Natal (Warren); Station 44, off Coogee, New South Wales, 49–50 fathoms (Ritchie).

Genus HALICORNOPSIS, Bale.

HALICORNOPSIS ELEGANS (Lamarck).

*Plumularia elegans*, Lamarck, Hist. Nat. Anim. sans Vertèbres, II, 1816, p. 129.

*Aglaophenia elegans*, Lamouroux, Hist. Polyp. Cor. Flex., 1816, p. 169; *id.*, Lamouroux, Encyclop. Méth. Zooph., 1824, p. 16.

*Aglaophenia avicularis*, Kirchenpauer, Abh. Nat. Ver. Hamburg, v, 1872, p. 33, pls. i and iii, fig. 3.

*Halicornopsis avicularis*, Bale, Journ. Micro. Soc. Vict., II, 1881, p. 26, pl. xiii, fig. 3; *id.*, Bale, Cat. Austr. Hydroid Zoophytes, 1884, p. 185, pl. x, figs. 1, 2, pl. xix, fig. 32; *id.*, Bale, Trans. and Proc. Roy. Soc. Vict., XXIII, 1887, pp. 90, 101; *id.*, Marktanner-Turneretscher, Ann. K. K. Hofmus. Wien, v, 1890, p. 279.

*Azygoplou rostratum*, Allman, Rep. Sci. Results "Challenger" Exped., Zool., VII, 1883, p. 54, pl. xix, figs. 1–3.

*Halicornopsis elegans*, Billard, Ann. Sci. Nat., Zool., (9), v, 1907, p. 323; *id.*, Billard, Comp. Rend., CXLVII, 1908, p. 940; *id.*, Billard, Ann. Sci. Nat., Zool., (9), IX, 1909, p. 329; *id.*, Billard, *Ibid.*, (9), XI, 1910, p. 44; *id.*, Ritchie, Mem. Austr. Mus., IV, 16, 1911, p. 855, pl. lxxxix, fig. 1; *id.*, Bale, Biological Results "Endeavour," II, 1, 1914, p. 56; *id.*, Briggs, Rec. Austr. Mus., X, 10, 1914, p. 296.

The colonies belonging to this species are mature, and bear well-developed gonangia, which spring from the bases of the hydrocladia at their junction with the stem. They are somewhat irregularly ovate bodies, thick-walled, without operculum or orifice, and are turned alternately to right and left, forming a row along the front of the stem. Here and there the gonangia have become detached leaving

only a shallow basin-shaped portion of the base, and Bale suggests that "it would seem probable therefore that the opening so formed may be the normal channel of exit of the contents."

*Dimensions.*—

mm.

Hydroclade-bearing internode (single one) length	0·61 – 0·73
Hydroclade-bearing internode (double one) length	0·97 – 1·38
Hydroclade-bearing internode, diameter	... 0·28 – 0·36
Hydroclade internode, length	... .. 0·42 – 0·45
Hydroclade internode, diameter	... .. 0·12 – 0·17
Hydrotheca, depth	... .. 0·29 – 0·31
Hydrotheca, diameter at mouth (lateral aspect)	0·26 – 0·28
Hydrotheca, diameter at mouth (frontal aspect)	0·36 – 0·40
Gonangium, length	... .. 1·31
Gonangium, greatest diameter	... .. 0·73 – 0·80

*Localities.*—D'Entrecasteaux Channel, Tasmania, 2 – 11 fathoms; Within Thouin or Wineglass Bay, Freycinet Peninsula, Tasmania, 11 fathoms; Off Thouin or Wineglass Bay, Freycinet Peninsula, Tasmania, 80 fathoms.

*Distribution.*—Previously recorded from Indian Ocean (Lamouroux); Hobart, Tasmania; Bass Strait (Kirchenpauer); Griffith Point, Portland, Queenscliff, Victoria (Bale); Station 161, off Port Phillip, Victoria, 38 fathoms (Allman); Victorian Coast (Marktanner-Turneretscher); Station 36, off Botany Bay, 23 – 20 fathoms; Station 48, off Wollongong, New South Wales, 55 – 56 fathoms (Ritchie); Great Australian Bight, 40 – 100 fathoms (Bale); Seven miles east of Cape Pillar, Tasmania, 100 fathoms (Briggs).

Genus HALICORNARIA, Busk.

HALICORNARIA FURCATA, Bale, var. INTERMEDIA, Bale.

*Halicornaria intermedia*, Bale, Biological Results "Endeavour," II, 1, 1914, p. 53, pl. v, fig. 2, pl. vii, figs. 3, 4. (Not *Halicornaria intermedia*, Billard, Les Hydroides de l'Expedition du Siboga, I, Plumulariidæ, 1913, p. 65, pl. iv, fig. 37).



*Halicornaria furcata*, Bale, var. *intermedia*, Bale, Biological Results "Endeavour," II, 1, 1914, Addendum, p. 1; *id.*, Briggs, Rec. Austr. Mus., x, 10, 1914, p. 298, pl. xxv, fig. 3.

Several monosiphonic, dichotomously branched colonies, the largest 285 mm. in height, are associated with *Aglaophenia tasmanica*, on which this variety always occurs as an epizoon. Bale first recorded it from Oyster Bay, Tasmania, where "a large colony of it was found accompanying *Aglaophenia tasmanica*, but whether it had commenced as a parasite on that species, after the fashion of so many of its congeners, it was impossible to determine, the stems being matted together with other growths." This variety was also found in association with specimens of *A. tasmanica* from 100 fathoms, seven miles east of Cape Pillar, Tasmania. The present specimens are quite similar to the colony originally described.

*Dimensions.*—

Hydroclade internode, length	...	...	0·39—0·42 mm.
Hydroclade internode, diameter	...	...	0·29—0·31 ,,
Hydrotheca, depth <sup>1</sup>	...	...	0·28—0·29 ,,
Hydrotheca, breadth <sup>2</sup>	...	...	0·20—0·21 ,,
Hydrotheca, length of free portion of mesial sarcotheca	...	...	0·07—0·09 ,,

*Locality.*—Off Thouin or Wineglass Bay, Freycinet Peninsula, Tasmania, 80 fathoms.

*Distribution.*—Previously recorded from Oyster Bay, Tasmania, 20 fathoms (Bale); Seven miles east of Cape Pillar, Tasmania, 100 fathoms (Briggs).

**HALICORNARIA LONGIROSTRIS (Kirchenpauer).**

*Aglaophenia longirostris*, Kirchenpauer, Abh. Nat. Ver. Hamburg, v, 1872, p. 42, pl. i, fig. 19, pl. v, fig. 20.

<sup>1</sup> Measured from aperture to base along long axis of hydrotheca.

<sup>2</sup> At right angles to depth.

*Aglaophenia Thompsoni*, Bale, Journ. Micro. Soc. Vict., II, 1881, p. 33, pl. xiv, figs. 1, 1a.

*Halicornaria longirostris*, Bale, Cat. Austr. Hydroid Zoophytes, 1884, p. 181, pl. xiii, fig. 7, pl. xvi, fig. 3, pl. xix, fig. 30; *id.*, Marktanner-Turneretscher, Ann. K. K. Hofmus. Wien, v, 1890, p. 279.

Four monosiphonic, unbranched, simple pinnate colonies, the largest 86 mm. in height, were found associated with *Aglaophenia divaricata*. The measurements of the trophosome agree very closely with those of Victorian specimens and with calculations made from Bale's figures. In one case the terminal aperture of the mesial sarcotheca is wanting, the nematophore being closed at the end. Such an arrangement, however, appears to be temporary or abnormal.

*Dimensions* —

Hydroclade-bearing internode, length	...	0.40—0.45	mm.
Hydroclade-bearing internode, diameter	...	0.35—0.36	,,
Hydroclade internode, length	... ..	0.24—0.26	,,
Hydroclade internode, diameter	... ..	0.14—0.15	,,
Hydrotheca, depth	... ..	0.19—0.21	,,
Hydrotheca, breadth	... ..	0.17—0.19	,,

*Locality*.—Storm Bay, Tasmania.

*Distribution*.—Previously recorded from Wilson's Promontory, Victoria (Kirchenpauer); Griffith Point; Portland; Queenscliff, Victoria; South Australia (Bale); Port Phillip Heads, Victoria; Bondi, New South Wales (Austr. Mus. Coll.).

HALICORNARIA SUPERBA (Bale).

*Aglaophenia superba*, Bale, Journ. Micro. Soc. Vict., II, 1881, pp. 31, 45, pl. xiii, figs. 4—4b.

*Halicornaria superba*, Bale, Cat. Austr. Hydroid Zoophytes, 1884, p. 175, pl. xiii, fig. 1, pl. xvi, fig. 4; *id.*, Bale, Proc. Roy.

Soc. Vict., (n.s.), vi, 1893, p. 107; *id.*, Marktanner-Turner-etscher, Ann. K. K. Hofmus. Wien., v, 1890, p. 279; *id.*, Bale, Proc. Roy. Soc. Vict., (n.s.), xxvi, 1913, p. 145.

A solitary colony, 87 mm. in height, alone represents this species originally described by Bale in 1881 under the name of *Aglaophenia superba*. Although the colonies are generally simple, specimens have been observed with one or two small branches very similar in structure to the proximal part of the stem. In the present specimen the lower portion of the stem is destitute of hydroclades. A branch originates at the side of the stem between two hydroclades, and occupies the whole of the space between the two. The branch, incomplete, is 11 mm. in length, and projects almost at right angles from the side of the stem; soon, however, it takes a characteristic upward curve, becoming erect, and finally incurved in the distal portion. The first four proximal internodes of the branch are devoid of hydroclades. The first branch-internode is very short and unarmed. The second is longer, cylindrical, and is furnished with a large sarcotheca in the middle. Then follow two internodes, each of which carries two large sarcothecæ abreast. The fifth supports a single hydroclade. The remainder are uniform, bearing two alternate hydroclades. As Bale's recent examination of the mode of branching in *H. superba* shows, there is a considerable amount of variation in the number of proximal internodes bearing sarcothecæ only.

*Dimensions.*—

Stem internode, length	...	...	...	0·56 – 0·77 mm.
Stem internode, diameter	...	...	...	up to 0·87 „
Hydroclade internode, length	...	...	...	0·28 – 0·31 „
Hydroclade internode, diameter	...	...	...	0·24 – 0·26 „
Hydrotheca, depth	...	...	...	0·24 – 0·26 „
Hydrotheca, breadth	...	...	...	0·17 – 0·19 „

*Locality.*—Storm Bay, Tasmania.

*Distribution.*—Previously recorded from Griffith Point; Queenscliff, Victoria; Dongarra Beach, Western Australia (Bale); Port Phillip Heads, Victoria (Austr. Mus. Coll.).

Genus *AGLAOPHENIA*, Lamouroux.

*AGLAOPHENIA ARMATA*, Bale.

(Plate X, fig. 2.)

*Aglaophenia armata*, Bale, Biological Results "Endeavour," II, 4, 1914, p. 175, pl. xxxviii, figs. 3, 4.

The occurrence of *Aglaophenia armata* in Tasmanian waters is of interest since this species has only within the last month been described by Bale from Queensland. Although my specimen is somewhat fragmentary and evidently the terminal portion of a branch, it is sufficient to confirm Bale's description of the long tubular hydrothecæ and the peculiar position of the intrathecal ridge, a character shared only by *Aglaophenia megalocarpa*, Bale. The specimen is extremely dark in colour, and in this respect presents a striking contrast to the type, which is light brown in colour. The gonosome was not observed.

*Dimensions.*—

Hydroclade-bearing internode, length	...	0·26—0·28	mm.
Hydroclade-bearing internode, diameter	...	0·22—0·24	,,
Hydroclade internode, length	... ..	0·28—0·31	,,
Hydroclade internode, diameter	... ..	0·24—0·26	,,
Hydrotheca, depth	... ..	0·38—0·40	,,
Hydrotheca, breadth at mouth	... ..	0·17—0·19	,,

*Locality.*—Off Thouin or Wineglass Bay, Freycinet Peninsula, Tasmania, 80 fathoms.

*Distribution.*—Hitherto recorded only from thirteen miles north-east of North Reef, 70—74 fathoms; Thirty-eight miles north-east of North Reef Lighthouse, Capricorn Group, off Port Curtis, Queensland, 74 fathoms (Bale).

## AGLAOPHENIA DECUMBENS, Bale.

*Aglaophenia decumbens*, Bale, Biological Results "Endeavour," II, 1, 1914, p. 48, pl. iv, fig. 4, pl. vi, fig. 6; *id.*, Briggs, Rec. Austr. Mus., x, 10, 1914, p. 300.

Bale instituted this species for a single specimen from Bass Strait, at the same time pointing out that "there is some doubt as to whether this species is identical with the *A. brevicaulis*, Kirchenpauer."

The largest colony is 84 mm. in height, and the minute characters of the hydrothecæ agree closely with Bale's diagnosis, except that the median anterior teeth of the hydrothecæ are without the characteristic outward bend.

*Dimensions.*—

Hydroclade-bearing internode, length	...	0·42—0·45	mm.
Hydroclade-bearing internode, diameter	...	0·19—0·21	„
Hydroclade internode, length	...	0·43—0·45	„
Hydroclade internode, diameter	...	0·08—0·10	„
Hydrotheca, depth	...	0·35—0·38	„
Hydrotheca, breadth at mouth	...	0·15—0·17	„

*Locality.*—Off Thouin or Wineglass Bay, Freycinet Peninsula, Tasmania, 80 fathoms.

*Distribution.*—Previously recorded from Bass Strait (Bale); Seven miles east of Cape Pillar, Tasmania, 100 fathoms (Briggs).

## AGLAOPHENIA DIVARICATA (Busk).

*Plumularia divaricata*, Busk, Voy. "Rattlesnake," I, 1852, p. 398.

*Plumularia ramosa*, Busk, *op. cit.*, p. 398.

*Aglaophenia ramosa*, Kirchenpauer, Abh. Nat. Ver. Hamburg, v, 1872, p. 38, pls. i, ii, fig. 17.

*Aglaophenia McCoyi*, Bale, Journ. Micro. Soc. Vict., II, 1882, p. 36, pl. xiv, fig. 2.

*Lytocarpus ramosus*, Allman, Journ. Linn. Soc., Zool., XIX, 1886, p. 154, pl. xxv, figs. 1—3.

*Aglaophenia divaricata*, Kirchenpauer, *op. cit.*, p. 26; *id.*, Bale, Cat. Austr. Hydroid Zoophytes, 1884, p. 162, pl. xv, figs. 7, 8, pl. xvii, figs. 6, 7; *id.*, Marktanner-Turneretscher, Ann. K.K. Hofmus. Wien, v, 1890, p. 267; *id.*, Billard, Comptes Rendu Acad. Sci., CXLVIII, 1909, p. 368; *id.*, Ritchie, Mem. Austr. Mus., iv, 16, 1911, p. 866.

Several specimens of *Aglaophenia divaricata*, Busk, do not differ in any important particular from those already described by Bale.

*Dimensions.*—

Hydroclade-bearing internode, length	...	0.29 – 0.33	mm.
Hydroclade-bearing internode, diameter	...	0.28 – 0.29	,,
Hydroclade internode, length	...	0.26 – 0.28	,,
Hydroclade internode, diameter	...	0.17 – 0.19	,,
Hydrotheca, depth	...	0.24 – 0.26	,,
Hydrotheca breadth at mouth	...	0.17 – 0.19	,,

*Localities.*—Storm Bay, Tasmania; Off Thouin or Wineglass Bay, Freycinet Peninsula, Tasmania, 80 fathoms.

*Distribution.*—Previously recorded from Bass Strait (Busk, Allman); Swan Island, Banks Strait (Busk); Wilson's Promontory, Victoria; Georgetown, Tasmania (Kirchenpauer); Portland; Griffith Point; Queenscliff; Williamstown, Victoria; Brighton, South Australia; Port Jackson, New South Wales (Bale); Victoria (Marktanner-Turneretscher); Station 54, within Jervis Bay, New South Wales, 10 – 11 fathoms (Ritchie).

AGLAOPHENIA TASMANICA, Bale.

*Aglaophenia tasmanica*, Bale, Biological Results "Endeavour," II, 1, 1914, p. 37, pl. iii, fig. 2, pl. vi, fig. 2; *id.*, Briggs, Rec. Austr. Mus., x, 10, 1914, p. 300, pl. xxvi.

Several examples with female corbulæ agree with Bale's description and with the proportions deduced from his figures (pl. iii, fig. 2, pl. vi, fig. 2). The stems bear branches

in opposite pairs, both series in one plane and all facing the same direction. Each branch commences with several internodes carrying median sarcothecæ only.

*Gonosome*.—Corbulæ (female) are present on several of the colonies, and agree in structure with those described by Bale.

*Dimensions*.—

Hydroclade-bearing internode, length	...	0·42–0·43	mm.
Hydroclade-bearing internode, diameter	...	0·40–0·42	,,
Hydroclade internode, length	...	0·38–0·43	,,
Hydroclade internode, diameter	...	0·19–0·22	,,
Hydrotheca, depth	...	0·36–0·38	,,
Hydrotheca, breadth at mouth	...	0·21–0·22	,,
Corbula, length	...	up to 12·5	,,
Corbula, diameter	...	2	,,

*Locality*.—Off Thouin or Wineglass Bay, Freycinet Peninsula, Tasmania, 80 fathoms.

*Distribution*.—Previously recorded from Oyster Bay, Tasmania, 20 fathoms (Bale); Seven miles east of Cape Pillar, Tasmania, 100 fathoms (Briggs).

AGLAOPHENIA TENUISSIMA, Bale.

(Plate XI, fig. 2.)

*Aglaophenia tenuissima*, Bale, Biological Results "Endeavour," II, 4, 1914, p. 179, pl. xxxvii, figs. 1, 2.

Several colonies, the largest 335 mm. in height, represent this extremely slender and flexuous species recently described by Bale from the Great Australian Bight. The gonosome was not observed. The specimens, however, agree in detail with the type, for the colonies are very light brown in colour, exhibit a slender habit, and have polysiphonic stems, 2 mm. in diameter at the base. From the flexures of the stem arise small and delicate alternate monosiphonic branches, the proximal portions of which

bear sarcothecæ only. No details have to be added to Bale's description of the characters of the species, the fasciculation, nor the mode of branching.

*Dimensions.*—

Hydroclade-bearing internode, length	...	0·54—0·78	mm.
Hydroclade-bearing internode, diameter	...	0·14—0·17	„
Hydroclade internode, length	... ..	0·45—0·47	„
Hydroclade internode, diameter	... ..	0·07—0·08	„
Hydrotheca, depth	... ..	0·33—0·35	„
Hydrotheca, breadth at mouth	... ..	0·18—0·19	„

*Locality.*—Off Thouin or Wineglass Bay, Freycinet Peninsula, Tasmania, 80 fathoms.

*Distribution.*—Hitherto recorded only from the Great Australian Bight, Long.  $126^{\circ} 45\frac{1}{4}'$  E., 190—320 fathoms; Long.  $130^{\circ} 40'$  E., 160 fathoms (Bale).

EXPLANATION OF PLATE X.

- Fig. 1. *Plumularia procumbens*, Spencer. Photograph of a specimen, 231 mm. in height, from off Thouin or Wineglass Bay, Freycinet Peninsula, Tasmania, 80 fathoms.
- Fig. 2. *Aglaophenia armata*, Bale. Photograph of co-type (in the Australian Museum, Sydney) 235 mm. in height, from thirty-eight miles north-east of North Reef Lighthouse, Capricorn Group, off Port Curtis, Queensland, 74 fathoms.
- Fig. 3. *Nemertesia ciliata*, Bale. Photograph of a specimen, 213 mm. in height, from off Thouin or Wineglass Bay, Freycinet Peninsula, Tasmania, 80 fathoms.

EXPLANATION OF PLATE XI.

- Fig. 1. *Plumularia sulcata*, Lamarck. Photograph of a specimen 203 mm. in height, from off Thouin or Wineglass Bay, Freycinet Peninsula, Tasmania, 80 fathoms.
- Fig. 2. *Aglaophenia tenuissima*, Bale. Photograph of a specimen, 227 mm. in height, from off Thouin or Wineglass Bay, Freycinet Peninsula, Tasmania, 80 fathoms.
-



## NOTES ON THE CATALASE REACTION OF MILK.

By H. B. TAYLOR, B.Sc.,

Science Research Scholar, University of Sydney.

(Communicated by Professor C. E. FAWSITT.)

[*Read before the Royal Society of N. S. Wales, October 7, 1914.*]

WHILE investigating some of the physico-chemical constants of milk<sup>1</sup> it was thought desirable to make some observations on the catalytic action of milk on certain chemical reactions. It is known that milk has the power of accelerating the decomposition of hydrogen peroxide and it is supposed that this is due to an enzyme, catalase, in the milk. Milk is further able to accelerate the rate of action of hydrogen peroxide on such substances as hydriodic acid and phenylenediamine hydrochloride, and the body causing these reactions is similar in many respects to the enzyme-peroxydase. The following investigations were undertaken in order to examine the catalase reaction more minutely.

**Catalase.**

The action of milk, and an active product obtained from it, on hydrogen peroxide were studied. There are various methods of following the rate of decomposition of the hydrogen peroxide. Two methods have been used here. The first, which is suitable for work with milk and hydrogen peroxide, consists in taking a definite volume of the mixture of milk and hydrogen peroxide at any stage of the reaction and running into sulphuric acid which serves to stop all action and to precipitate the caseinogen. The quantities used in these experiments were:—5 cc. of a mixture which originally contained 15 cc. of M/10 hydrogen peroxide and

---

<sup>1</sup> Taylor, this Journal, XLVII, 1913.

50 cc. of milk and 20 cc. of N/5 sulphuric acid. The solution is then filtered, and the filtrate analysed for its hydrogen peroxide content, by comparing the colour produced on adding excess of titanium sulphate with that obtained when the titanium solution is added to a standard solution containing a known amount of hydrogen peroxide. In the second method a purified solution of catalase was used.

Experiments were carried out at 25° C. with mixtures of 50 cc. of milk and 15 cc. of M/10 hydrogen peroxide, and the concentration of the hydrogen peroxide determined from time to time. In Table I are given values for  $K$ , the velocity constant, calculated as a first order reaction, from figures obtained by the method described above. In order to obtain the true catalytic action of the enzyme, it is assumed, in the calculation of  $K$ , that the concentration of the hydrogen peroxide at the end of the reaction is zero (*i.e.*, assuming that the enzyme catalyses the reaction as an ideal catalyst).

Table I.

$$\text{Temperature } 25^{\circ} \text{ C. } K = \frac{2.3}{t} \log \frac{a}{a-x}.$$

Concentration of hydrogen peroxide.	$t$	$a - x$	$K \times 10^4$
M/47	0	1.70	...
	30	1.38	69
	40	1.30	67
	84	.96	68
	121	.82	60
	1490	.40	...

Where  $a$  = initial concentration of hydrogen peroxide and  $a - x$  = concentration at time  $t$ . The hydrogen peroxide used had been previously purified by redistillation under reduced pressure.

Working with a number of different samples the velocity constants obtained were not by any means the same, even

when milks were examined under comparable conditions. This is shown in the following table.

Table II.

Temperature 25° C.

Time examined after milking.	Concentration of hydrogen peroxide.	$K \times 10^4$	Total $H_2O_2$ decomposed.
(1) 0 hrs. 17 min.	M/35	29	0.09
(2) 0 " 23 "	"	46	1.31
(3) 2 " 15 ;	"	56	1.25
(4) 2 " 15 "	M/47	121	0.70
(5) 4 " 25 "	"	21	0.60
(6) 5 " 40 "	"	42	0.78
(7) 2 " 50 "	M/29	97	2.42

The total amounts of hydrogen peroxide decomposed as given in the last column, are measured in cubic centimetres of the standard hydrogen peroxide solution (1 cc. = .00008 of a gram of hydrogen peroxide). It appears from a consideration of the above figures that the activity of the enzyme, measured by  $K$ , is not dependent on the stability of the enzyme. By stability is meant the power the enzyme has of resisting the action of the hydrogen peroxide, and this is probably measured by the total hydrogen peroxide decomposed. This will again be referred to when the action of potassium cyanide on the enzyme is considered.

The variation in the above figures might be accounted for in two ways:—(1) that the catalase is produced by bacteria in the milk while in the udder, (2) that varying amounts of catalase are secreted, together with the milk, by different cows.

In regard to (1) it has been shown by several workers that the milk when first drawn from the udder contains a considerable number of bacteria, and, since blood heat is

most favourable for their growth, it is quite possible that in the short time the milk is in the udder some catalase could be produced. To see whether it was possible for bacteria from the air to form catalase, some milk was boiled and divided into two parts, one being closed from the air by means of cotton wool, the other left open. In the course of two days at a temperature of 25° C. the one left open gave a value for  $K$  of .00323, while that kept closed did not decompose hydrogen peroxide at all. It was also noticed that in milk kept for some time the amount of catalase increased, as shown by the increased value of  $K$ ; this action could also be attributed to the action of bacteria.

Table III.  
Temperature 25° C.

Concentration of hydrogen peroxide.		Age of Milk.	$K \times 10^4$	Total $H_2O_2$ decomposed.
(1)	M/29	2 hrs. 52 min.	97	2.42
		27 " 53 "	...	1.36
(2)	M/35	0 " 17 "	29	.2
		2 " 35 "	...	1.07
		3 " 30 "	...	1.15
		22 " 10 "	141	1.68
(3)	M/35	2 " 15 "	56	1.25
		4 " 0 "	...	1.30
		23 " 6 "	340	1.70
		47 " 30 "	156	1.36
		50 " 25 "	...	.97
(4)	M/47	5 " 40 "	42	.78
		22 " 30 "	235	1.59
		27 " 7 "	186	1.39
		47 " 10 "	72	1.30
		51 " 25 "	89	1.21

Evidence of this increase is well shown by the foregoing figures, which show an increase for the value of  $K$ , and the total hydrogen peroxide decomposed, until the milk is 22 hours old: after this the value for  $K$  shows a decrease. This decrease being probably due to the inhibiting action of the lactic acid formed. The total decomposition is expressed in ccs. of standard hydrogen peroxide solution.

From these results it seems highly probable that there are ordinarily bacteria in the air which on gaining access to the milk are able to produce a substance having the power of catalysing the decomposition of hydrogen peroxide. In order to study the action of catalase in as pure a state as possible, the following method of purification was arrived at. To 500 ccs. of milk enough acetic acid, 5 E, was slowly added to precipitate the caseinogen; sodium hydrate was then added until the resulting solution was acid to phenolphthalein and alkaline to methyl red. This brought the milk back to its original acidity. The liquid was then filtered. To the resulting filtrate, which was quite clear, 800–900 ccs. of 90% alcohol were added until a precipitate was formed. This precipitate was filtered off, freed from alcohol by drying, in vacuo, and treated with water in the presence of chloroform. The resulting solution contained catalase, and readily decomposed hydrogen peroxide.

Table IV.  
Temperature 25° C.

Concentration of $H_2O_2$ in solution.	$t$ .	$a - x$	$K \times 10^4$
M/300	0	14.16	...
	20	10.00	189
	30	8.25	190
	40	7.20	177
	45	6.35	185
	50	5.80	184
	60	4.80	185

The values of  $K$  obtained for such a preparation of catalase are given on the preceding page.

A solution of catalase obtained in the manner described above was used for determining the effect of different concentrations of enzyme on the rate of decomposition of hydrogen peroxide. The method used to determine the concentration of hydrogen peroxide in the experiment was as follows:—the enzyme solution was mixed with hydrogen peroxide at a temperature of 25° C., so that the resulting concentration of hydrogen peroxide was M/300. From time to time 5 ccs. of this solution were added to 1 cc. of a saturated solution of mercuric chloride and filtered, the filter washed with water and the filtrate titrated with potassium permanganate solution of a concentration N/400. If the values of  $K$  are calculated as for a first order reaction, and compared with the concentration of the enzyme, the rate of decomposition is found to be proportional to the concentration of enzyme as shown below.

Table V.  
Temperature 25° C.

Concentration of hydrogen peroxide.	Concentration of enzyme.	$K \times 10^4$	$K/C_E$
M/300	10	15	1.50
	25	62	2.48
	50	126	2.52
	75	188	2.50
	100	256	2.56

This proportionality between the values of  $K$  and the concentration of the enzyme agrees with the result given by Senter<sup>1</sup> for blood-catalase.

**The effect of hydrogen peroxide on the velocity constant.**

The solution of catalase, used for the remainder of the experiments given in this paper, was obtained by dialysing

<sup>1</sup> Zeit. fur Physik. Chemie, 1903.

the previous solution through parchment paper, and gave no reaction for proteins. Since this solution does not contain proteins the use of mercuric chloride is not necessary.

If the decomposition of hydrogen peroxide by catalase proceeds as a typical first order reaction any increase in the concentration of the hydrogen peroxide should have no effect on the velocity constant. As will be seen from the figures in Table VI, the rate at which the reaction proceeds gradually diminishes with increase in hydrogen peroxide concentration, showing clearly that the hydrogen peroxide must have an inhibiting influence on the action of the enzyme.

Table VI.  
Temperature 25° C.

Concentration of enzyme.	Concentration of hydrogen peroxide.	$K \times 10^4$	$K \times \sqrt{\text{Conc. H}_2\text{O}_2}$
1	M/500	53	2.4
1	M/160	42	3.4
1	M/120	36	3.3
1	M/80	31	3.5

The values of  $K$  are calculated on the assumption that the reaction goes to an end. From the figures in the last column of the above table it will readily be seen that the inhibiting action of the hydrogen peroxide for the higher concentrations is proportional to the square root of the concentration of hydrogen peroxide. The rate at which the inhibiting action proceeds will be considered at a later stage.

#### Effect of temperature on the velocity constant.

As is the case with all catalytic actions, increase of temperature increases the velocity of the reaction. In the following table are given the temperatures at which the reaction took place and the value for the velocity constants  $K$  and  $K_1$  at that temperature. The enzyme solution was

in all cases kept at the required temperature five minutes before the hydrogen peroxide was added.

Table VII.

Concentration of hydrogen peroxide =  $M/300$ .  $K = \frac{2.3}{a-x} \log \frac{a}{a-x}$   
 Concentration of enzyme = 1.  $K_1 = \frac{2.3}{t} \log \frac{C_0 - C_\infty}{C_t - C_\infty}$

Temperature ° C.	$K \times 10^4$	$K_1 \times 10^4$	H <sub>2</sub> O <sub>2</sub> decomposed in thirty minutes.
0	22	41	1.2
15	39	80	2.0
26	66	152	2.4
35	51	482	2.05
50	42	842	1.30

It will be seen that as the temperature increases, a maximum figure is reached in the value of  $K$  showing that the optimum temperature, taken for one-third of the reaction, was in the vicinity of 25° C. When the end point of the reaction is taken into consideration the figures for the velocity constant  $K_1$  show no maximum, but increase in a regular way similar to that of a reaction catalysed by an inorganic catalyst, as shown in the last column of the above table. The reason why there is no maximum in the value of  $K_1$  is that the destruction of the enzyme is very greatly increased with rise of temperature, thus making the period of the reaction much less. By decreasing the period of the reaction and the total amount of hydrogen peroxide decomposed so that  $C_\infty$  becomes greater, the ratio  $C_0 - C_\infty : C_t - C_\infty$  in the formula

$$K_1 = \frac{2.3}{t} \log \frac{C_0 - C_\infty}{C_t - C_\infty}$$

becomes greater and consequently the values of  $K_1$  are greatly increased. This increase in the value of  $K_1$  is large enough to obscure the decrease owing to the inactivation of the enzyme.



**Temperature Coefficient.**

As the range of temperature between the different values of  $K$  is not, in all cases, equal to  $10^\circ \text{C.}$ , a formula was used by which the temperature coefficient for  $10^\circ \text{C.}$  can be calculated. This formula is as follows:

$$\log K_2 - \log K_1 = A (T_2 - T_1)$$

The temperature coefficient for  $10^\circ \text{C.}$  is given by  $K_{t+10}/K_t$  where  $K_{t+10}/K_t = 10^{10^A}$ .

The value for the temperature coefficient for  $10^\circ \text{C.}$  was calculated by the above formula from the values of  $K$  given in Table VII.

Table VIII.

Temperature $^\circ \text{C.}$	Temperature Coefficient $10^\circ \text{C.}$
0 - 15	1.47
0 - 25	1.55
15 - 25	1.68
25 - 35	.78
25 - 50	.83
35 - 50	.87

The value for the temperature coefficient for the range  $0^\circ - 15^\circ \text{C.}$  is 1.47 and agrees with that given by Senter,<sup>1</sup>  $0^\circ - 10^\circ \text{C.} = 1.5$ , for blood catalase.

**Inactivation of Catalase.**

In the experiments on the effect of varying the concentration of hydrogen peroxide and the temperature, for which the values of  $K$  are given in Tables VI and VII, the ratio  $a/a - x$  showed a decrease, indicating that both hydrogen peroxide and temperature have an inactivating effect on the enzyme.

Assuming that this inactivation proceeds as a first order reaction, Tamman<sup>2</sup> has derived a formula by which the

<sup>1</sup> Zeit. fur Physik Chemie, XLIV, 1903, p. 257.

<sup>2</sup> Zeit. fur Physik Chemie, XVIII, 1895, p. 436.

values of  $K_E$ , the rate of inactivation of the enzyme, can be calculated from the initial velocity  $K$ . This formula is as follows:—

$$\log \frac{a-x}{a} = \frac{K}{K_E} (1 - e^{-K_E t})$$

where  $a$  and  $a-x$  have the usual meanings, and  $E$  is the initial concentration of the enzyme.

If in this formula,  $t$  is put equal to  $\infty$ ,  $a-x$  becomes equal to the concentration of hydrogen peroxide at the end of the reaction, and the equation then takes the form,

$$\log \frac{a-x}{a} = \frac{K}{K_E} \quad E = 1$$

The values of  $K$  used for the calculation of  $K_E$  according to Tamman's formula must be those which are obtained by taking into consideration the end point of the reaction. The values for  $K$  are shown under  $K_1$  in Tables IX and X.

(1) *Effect of hydrogen peroxide on value of  $K_E$ .*

Since the rate of decomposition of hydrogen peroxide decreases with increase of hydrogen peroxide concentration as shown under  $K$  in Table VI, it would be expected that the rate of destruction of the enzyme  $K_E$  would increase as the values of  $K$  decrease. That this is the case is seen from Table IX.

Table IX.  
Temperature 25° C.

Concentration of enzyme.	Concentration of hyd. peroxide.	$K \times 10^4$	$K_1 \times 10^4$	$K_E \times 10^4$
1	M/500	53	122	446
	M/160	42	216	1893
	M/120	36	227	2465
	M/80	31	257	3609

(2) *Effect of Temperature.*

The rate of destruction of the enzyme, as will be seen from the following figures, is very greatly increased by the rise of temperature.

Table X.

Concentration of hydrogen peroxide.	Temperature ° C.	$K \times 10^4$	$K_1 \times 10^4$	$K_E \times 10^4$	Amount $H_2O_2$ decomp. $t = \infty$
M/300	0	22	41	103	9.40
	15	39	80	250	8.35
	25	66	152	552	7.35
	35	51	482	6,267	2.50
	50	42	842	21,260	1.35

From the above figures it will be seen that the rate of destruction at 50°C. is over 200 times as fast as it is at 0°C., and even as low as 15°C. it is two and a half times as fast as at 0°C. The amounts of hydrogen peroxide decomposed are measured in ccs. N/400 permanganate solution. The value for the temperature coefficients calculated in the same way as for the decomposition of hydrogen peroxide by the enzyme (Table VII), are given in the following table.

Table XI.

$K_E \times 10^4$	Temperature ° C.	Temp. Coefficient 10° C.
103	0	0 - 15 = 1.8
250	15	0 - 25 = 1.9
552	25	15 - 25 = 2.2
6267	35	25 - 35 = 11.4
21260	50	25 - 50 = 4.3
...	...	35 - 50 = 2.3

From the above it is seen that the temperature at which the greatest increase in the rate of destruction takes place corresponds with the temperature at which the velocity constant  $K$  begins to decrease.

*Effect of potassium cyanide on  $K$  and  $K_E$ .*

The catalase solution used in the following experiments was prepared by dialysing an aqueous solution of the

alcoholic precipitate through parchment for three days, and was kept active by the addition of some chloroform. The results obtained were as follows:—

Table XII.

Temperature 15.5° C. Concentration of hydrogen peroxide = M/300. Concentration of Enzyme = 1.

(1)

KCN = M/∞			KCN = M/∞		
<i>t</i>	<i>a-x</i>	<i>K</i>	<i>t</i>	<i>a-x</i>	<i>K</i>
0	13.6	...	0	13.4	...
10	13.0	.0045	10	12.9	.0037
20	12.8	.0030	20	12.45	.0036
30	12.4	.0031	30	12.1	.0034
50	11.65	.0031	50	11.8	.0025
60	11.4	.0029	1380	7.5	...
1140	7.2	...			
Mean .0033			Mean .0033		

(2)

KCN = M/100,000			KCN = M/10,000			KCN = M/1,000		
<i>t</i>	<i>a-x</i>	<i>K</i>	<i>t</i>	<i>a-x</i>	<i>K</i>	<i>t</i>	<i>a-x</i>	<i>K</i>
0	13.8	...	0	14.2	...	0	13.7	...
10	13.45	.0026	10	13.8	.0028	10	13.5	.0015
20	13.05	.0028	21	13.4	.0028	20	13.3	.0015
41	12.4	.0026	30	13.4	.0029	40	13.0	.0013
50	11.7	.0033	40	12.9	.0024	1020	5.6	...
60	11.3	.0033	60	12.3	.0024			
1140	7.2	...	1120	7.2	...			
Mean .0029			Mean .0026			Mean .0014		

(3)

HCN = M/100,000			HCN = M/10,000		
<i>t</i>	<i>a-x</i>	<i>K</i>	<i>t</i>	<i>a-x</i>	<i>K</i>
0	14.0	...	0	14.15	...
20	13.1	.0026	10	14.00	.0011
40	12.7	.0024	20	13.0	.0009
70	11.6	.0026	40	12.9	.0023
1080	7.4	...	70	12.4	.0019
			1080	7.6	...
Mean .0025			Mean .0015		

In (3) of the above tables the HCN was formed in the catalase solution by the addition of the requisite amount of HCl to the KCN. It will be noticed that the values for *K* decrease with the increasing concentration of potassium cyanide, and on comparing the values for hydrogen cyanide with those for potassium cyanide, that solutions of a strength M/100,000 and M/10,000 of hydrogen cyanide give approximately the same figures for *K* as solutions M/10,000 and M/1,000 of potassium cyanide. From this it would appear that hydrogen cyanide has ten times the effect of potassium cyanide.

It was at first thought that by calculating the values for the rate of destruction of the enzyme, figures would be obtained somewhat similar to those given in Tables IX and X for the effect of hydrogen peroxide and temperature, but this does not seem to be the case, as will be seen from the following table.

Table XIII.

Concentration of KCN.	$K \times 10^4$	$K_1$	$K_2$	Amount of hydrogen peroxide decomposed.
M/ $\infty$	33	76	275	6.4
M/100,000	29	66	232	6.6
M/10,000	26	57	192	7.0
M/1,000	14	22	57	8.1

The amounts of hydrogen peroxide decomposed are measured in ccs. of N/400 potassium permanganate solution.

The figures for the values of  $K_E$  show that, although the activity of the enzyme is decreased, as shown by the values for  $K$ , the destruction of the enzyme proceeds at a slower rate.

The addition of potassium cyanide and hydrogen cyanide, although they decrease the activity of the enzyme, have, therefore, the effect of causing the enzyme to decompose more hydrogen peroxide, (*i.e.*) increasing its stability. It might be said then that variations in the values for the velocity constants need not necessarily be followed by similar variations in the total amounts of hydrogen peroxide decomposed, although for temperature and increase in enzyme concentration, the amount of hydrogen peroxide decomposed decreased in one case and increased in the other along with corresponding changes in the values for  $K$ . From what has been said above there appears to be no doubt that the catalase of milk is analogous to the catalase obtained from blood.

---

## THE DEVELOPMENT AND DISTRIBUTION OF THE NATURAL ORDER LEGUMINOSÆ.<sup>1</sup>

By E. C. ANDREWS, B.A., F.G.S.

[*Read before the Royal Society of N. S. Wales, November 4, 1914.*]

General Notes and Summary.

Acknowledgments.

Classification.

Systematic Notes.

Geographical Distribution: General. Genera indigenous to temperate regions.

Geography during Cretaceous and Post-Cretaceous time.

The Age of Dicotyledons: Commenced probably in the lowest Cretaceous. Well differentiated during Upper Cretaceous. The futility of attempts to determine plant genera on the evidence of imperfect leaf remains only.

Principles of Geographical Distribution: Climate and soil studies indispensable in this connection. Isolation. The influence of marine transportation in populating lands.

Nature and Home of the Ancestral Forms.

The Differentiation of Leguminosæ.

Appendix.

Bibliography.

### **General Notes and Summary.**

In a previous paper (2), the writer indicated the significance, in part, of the distribution of the Myrtaceæ. In the present paper the significance of the geographical distribution of the Leguminosæ is considered.

The terms Leguminosæ and Myrtaceæ are practically interchangeable in the consideration of former land con-

---

<sup>1</sup> [Read before Section E. of the British Association for the Advancement of Science, August 21st, 1914.]

nections in the tropics, inasmuch as each appears to have descended individually from certain peculiar groups of uniform primary types which at one time were widely diffused throughout the tropics, and which show xerophytic modifications in varying directions in different extra-tropical regions such as Eurasia, South Africa, and Australia.

On the other hand, the study of these two great plant-groups would be of little or no use in a discussion as to any possible former land connections between Antarctica and the southern continents, inasmuch as Leguminosæ and Myrtaceæ appear to be of tropical origin, having accommodated themselves only in later geological time to temperate regions, and that with only a moderate amount of morphological change.

A study of the distribution of Compositæ,<sup>1</sup> however, would be exceedingly valuable in such a discussion because of the morphological similarity exhibited by certain groups of Compositæ which are clustered at the southern extremities of countries such as New Zealand, Australia, and South America.

For the sake of brevity it has been considered advisable to discuss only the main principles underlying plant distribution in space, and to describe the development, in brief, of a few of the twenty-four tribes recorded for Leguminosæ by the great systematist Bentham, reserving the genus *Acacia* for more detailed mention as indicating the general lines upon which leguminous development may have taken place.

In a problem such as that under consideration, the studies of geology, geography, and biology, are complementary, and no decided advance is to be expected without the cooperation of workers skilled in these branches of science.

---

<sup>1</sup> Bentham, (12) p. 504.



The case may, perhaps, be stated briefly in the form of a summary of the paper. The present distribution of plants and animals is the algebraic sum of the responses made by organisms to their changing environment during the whole of the known geological record, and the present adjustment of the activities involved has been obtained only after ages of development during various geographical changes. As such, an analysis of a great and widely-spread Natural Order, such as Leguminosæ, might be expected to throw light upon the nature of former land connections by reason of the peculiar similarities, and dissimilarities, of morphology, exhibited by the plants in countries at present separated from each other.

Leguminosæ contains many uniform types which are widely diffused throughout the tropics, and which, moreover, are in the main luxuriant in habit. In extra-tropical countries, such as Eurasia, South Africa, and Temperate Australia, these uniform tropical forms are represented by specialised types, which have developed along different directions in the different extra-tropical regions, while the primitive, or connecting forms, are to be found in the tropics. These specialised or secondary forms are mainly xerophytic.

Furthermore, many widely diffused types of the tropics have not entered Australia, while others have a wide distribution in America, and only occur rarely in Africa and Asia. Out of a total of nearly five hundred genera in Leguminosæ, only seven exist in New Zealand.

It would appear that the present great tropical lands were connected during one or more previous periods, and that a genial and moist climate extended far beyond the tropical and subtropical regions. In these lands a few uniform primary types of Leguminosæ had a wide distribution. New Zealand was separated from the tropical world

early in the differentiation of the Order, while Australia was cut off at a date considerably later.

A great differentiation of climate ensued about the date of the separation of Australia from Asia accompanied by a decided contraction of the genial and moist climate of earlier times. High mountains, large continents, and great deserts came into existence at the time of this shrinkage, and the uniform primary types of the Leguminosæ were called upon either to adapt themselves to the new conditions or to retreat to the tropics. Instead, however, of retreating, defeated, to the tropics, many of the uniform types of the legumes responded to their inhospitable environment in temperate regions by the development of large and important groups of xerophytes, such development being practically simultaneous in the various extra-tropical regions, but in different morphological directions.

A study of Myrtaceæ (2) leads to a conclusion almost identical with that stated in the previous paragraph, the evidence, however, not being nearly so weighty as in the case of the Leguminosæ. Before accepting such a conclusion, however, the reader would need to be convinced that a genus such as *Eucalyptus* had not existed in Europe and America in Cretaceous, Eocene, and Miocene times, inasmuch as systematists, such as Ettingshausen and Unger, have laid decided stress upon this supposed existence of *Eucalyptus* by reason of the evidence of certain fossil leaves of lanceolate, and somewhat falcate, appearance, in Cretaceous and Tertiary beds in the Northern Hemisphere. *Eucalyptus*, however, has only in late, or recent, geological time, acquired the petiolate and twisted leaf stage, whereas, previously to that, it possessed leaves either sessile, cordate, opposite, thin and horizontal, more suggestive of certain Myrtles and *Eugenias* of to-day, a leaf very different from the present xerophytic form of many adult *Eucalyptus*.

Furthermore, a consideration of the families Compositæ, Epacrideæ, Ericaceæ, Coniferæ, Goodeniaceæ, Casuarineæ, Rutaceæ, Proteaceæ, Candollaceæ, and Rubiaceæ, reveals other remarkable and additional evidence, partly supplementary, but never contradictory, to that yielded by a study of Leguminosæ and Myrtaceæ, the whole leading to the conclusion that the endemic vegetation of Australia has developed in that continent mainly as a result of the presence there of large areas of barren sandy soil, and very variable, therefore inhospitable, climate, and partly as a result of its isolation and freedom from competition. This vegetation such as Eucalyptus, Hakea, Banksia, and Persoonia, has *never* migrated far from the old home.

*Bibliography.*—The numbers against authors' names in the text, and in the footnotes, refer to the bibliographical list at the end of the paper.

#### Acknowledgments.

From Mr. R. H. Cambage the names of Australian plants were learned in the field, and by him also the writer was led to perceive the great influence of soil and climate upon the Australian plants. Without knowledge such as this, the present paper could not have been prepared. Seedlings of various Acacias were also grown by Mr. Cambage to enable the writer to reach a satisfactory conclusion concerning the priority in age of the Uninerves or Pleurinerves among the phyllodineous members of the genus.

To Mr. J. H. Maiden very cordial thanks are due for access, at all times, to the National Herbarium of Sydney, for permission, moreover, to use the unpublished Census of New South Wales Plants by Maiden and Betche, and also for helpful discussions on the Acacias described in his Forest Flora. The writer desires to call attention also to the great assistance derived in the preparation of this note

from the magnificent collection of plants in the National Herbarium due so largely to the unremitting efforts of Mr. Maiden.

To Mr. E. Cheel and Mr. A. A. Hamilton, of the National Herbarium, the writer is deeply indebted for help in the naming of specimens and for valuable references to literature dealing with Leguminosæ. It was also due to the kindness of Mr. Cheel that the writer was enabled to consult that rare book in Australia, namely, *Pflanzenfamilien* by Engler and Prantl.

#### Classification.

In the preparation of this paper, the classification of Bentham in "*Flora Australiensis*" has been followed, with the exception of that dealing with the tribes Sophoreæ and Podalyrieæ. The morphology and geographical distribution of these plants have suggested that Podalyrieæ should be included under Sophoreæ, the one flourishing mainly in the tropics and there maintaining its purity, the other representing a modification of Sophoreæ by adaptation to harsh, sub-arid, or cold surroundings, in very late or in Post-Cretaceous time.

#### Systematic Notes on the Natural Order Leguminosæ.

The subjoined notes are supplied for the help of the geographer, who may be unacquainted with the morphology of the plants belonging to this great order. Only the leading characteristics of the families and the principal tribes are supplied.

"LEGUMINOSÆ: Trees, shrubs, or herbs. Leaves alternate or rarely opposite, often compound. Stipules rarely wanting. Gynœcium free, consisting of a single<sup>1</sup>

---

<sup>1</sup> Sometimes double, as in *Swartzia*. The style is simple, with its inner angle, or ventral suture, facing the dorsal aspect of the flower (opposite the standard in *Papilionaceæ*). [E.C.A.]

excentric carpel with a terminal style, the ovules inserted along the upper or inner angle of the cavity. Albumen usually scanty or none.”—Bentham.

Family PAPILIONACEÆ: Flowers irregular, petals usually five, overlapping, the upper one outside. Stamens 10, rarely fewer. Radicle curved, rarely straight.

If the stamens be free, the plant belongs either to Sophoreæ or Podalyrieæ. The former usually has a luxuriant habit with plurijugate leaves, the latter a dwarfed appearance with leaves either simple, trifoliate, or wanting.

If the stamens be united and the leaves simple, digitately 3–5 foliolate and stipulate, pinnately trifoliate, verticillate, or absent, the tribe indicated is Genisteæ. In Australian Genisteæ the sheath enclosing the stamens is generally open along the upper side.

With leaves pinnately 3–5 foliolate and stipulate, and diadelphous stamens, the tribe Trifolieæ is suggested.

Phaseoleæ possesses pinnately trifoliate leaves and stems.

Galegeæ comprises non-twining herbs, tall trees, or woody climbers. Leaves pinnate, plurijugate. Upper stamen free, remainder in sheath.

Hedysareæ: Pod separates into one-seeded portions which do not split open.

Dalbergiæ are trees or woody climbers. Leaves pinnate, plurijugate, rarely simple. Stamens usually united or in two bundles each of five. Pod does not open.

Family CÆSALPINIÆ: Flowers, irregular to nearly regular. Petals, 5 or fewer, overlapping, the upper one inside, not outside, as in Papilionaceæ. Stamens

10 or fewer, or at times indefinite. Radicle straight. Seeds usually albuminous.

*Eucæsalpinieæ*: Leaves bipinnate. Petals usually 5, subequal. Stamens 10.

*Cassieæ*: Stamens usually 10, free. Leaves abruptly pinnate. Trees, shrubs or herbs.

Family MIMOSEÆ:—Flowers regular, small, in spikes or heads. Petals 5, 4, or rarely 3, overlapping or valvate. Stamens definite or indefinite in number. Leaves bipinnate. Radicle straight.

*Parkieæ*: Definite stamens. Petals slightly overlapping.

*Eumimoseæ*: Definite stamens.

*Acacieæ*: Indefinite free stamens.

*Ingeæ*: Indefinite stamens enclosed at base in ring.

#### **Geographical Distribution of Leguminosæ.**

In 1855, Alphonse De Candolle<sup>1</sup> indicated the tropics as the probable home of the Leguminosæ and, in support of this belief, he pointed out the gradual diminution in numbers of species as the tropics are left behind in both Northern and Southern Hemispheres. De Candolle made this announcement at a time when very few legumes had been recorded from South Africa and extra-tropical Australia; nevertheless, the known distribution of those plants in these two countries has not invalidated his conclusion.

The Mimoseæ and Cæsalpinieæ are more characteristic of the tropics than are the Papilionaceæ. The Mimoseæ with its vast genera *Acacia*, *Mimosa*, *Inga*, *Pithecolobium*, and *Calliandra*, possesses no indigenous representative in Europe, although *Prosopis* occurs in Cyprus. The Cæsalpinieæ, possessing about eighty genera—one genus alone

<sup>1</sup> (22) p. 1238 and onwards.

(Cassia) containing four hundred species—has only one representative, namely, *Cercis*, in Southern Europe. A few small genera of the family have representatives in the United States. This is strikingly analogous to the distribution of the Myrtaceæ in Europe and North America beyond Mexico, inasmuch as *Myrtus communis* is the only representative of the vast family in Europe and only a few species appear to occur in the United States. In the Southern Hemisphere, however, both Mimoseæ and Cæsalpinieæ extend to the southern portions of the three continents.

Of the three families, Papilionaceæ is characteristic of cooler rather than of tropical regions, and in both hemispheres its members extend, as rare stragglers, to the limits of Dicotyledonous vegetation. Thermopsis is an example of this in the Podalyrieæ, growing at an altitude of 17,000 feet above sea level in the Himalaya.

The accompanying table indicates the approximate distribution of the Order in the more important countries of the world. Spain and Russia have not been included, as the literature dealing with the Leguminosæ of these countries was not accessible to the writer.

*Table of Geographical Distribution of Leguminosæ.*

Country.	Number of Genera.	Number of Species.	Remarks and Authorities.
New Zealand... ..	7	29	Cheeseman, 1906.
Australia ... ..	97	1275	Bentham, <i>Flora Australiensis</i> , Vol. II, 1862; Maiden, <i>Federal Handbook</i> , 1914; Mueller, <i>Second Census of Australian Plants</i> , 1889.
South Africa... ..	82	800	Harvey and Sonder, 1862.
Tropical Africa ... ..	141	850	Baker, in <i>Oliver's Flora of Tropical Africa</i> , 1879.
British India... ..	132	800	Baker, in <i>Hooker's Flora of British India</i> , 1879.
Brazil ... ..	140	1500	Bentham, in <i>Flora Braziliensis</i> , 1859–1876.
Britain ... ..	20	69	Bentham and Hooker, 1887.
France ... ..	45	410	Acloque, 1894.

Table of Geographical Distribution of Leguminosæ—continued.<sup>1</sup>

Country.	Number of Genera.	Number of Species.	Remarks and Authorities.
Germany ... ..	31	131	Garcke, 1895.
Italy ... ..	42	410	Arcangeli, 1894.
North America (exclusive of Mexico)...	55	700	Britten and Brown, 1897.
Fiji ... ..	31	45	Seeman.
New Caledonia ... ..	43	100	A list quite incomplete, from Helmsley's Manuscript.
Queensland ... ..	95	470	Bailey, 1902.
New South Wales ... ..	59	385	Maiden and Betche. In Manuscript only.
Tasmania ... ..	20	59	Rodway.

<sup>1</sup> Lists only approximate. Some of the works consulted are not only from forty to fifty years old, but have not been brought up to date. It is highly probable that the actual numbers of species in Brazil, India, and Africa are much greater than as here recorded.

Various tribes and genera are characteristic of the tropics, for example, genera such as *Dalbergia*, *Machærium*, *Lonchocarpus*, *Indigofera*, *Bauhinia*, *Entada*, *Abrus*, *Afzelia*, *Mucuna*, *Æschynomene*, *Parkia*, *Calliandra*, *Albizzia*, *Pithecolobium*, *Inga*, *Mimosa*, and *Tephrosia*. Other genera again, such as *Acacia*, *Cassia*, and *Crotalaria*, appear to have their real homes in the tropics but occur, nevertheless, with few exceptions, as xerophytes in many warm temperate regions. The tropical forms of these genera, considered individually, bear a much greater resemblance to each other than to the xerophytic forms. Moreover, the xerophytes of these genera appear to have developed along divergent lines in different temperate regions. For example, the *Acacias* of South Africa vary considerably from those of Australia, so also the xerophytic *Cassias* of Australia are peculiar to that country. And in like manner the *Podalyriæ* and *Genistææ* of South Africa, Eurasia, and Australia, differ widely in these contrasted regions.

This may be stated another way: Thus various genera, such as *Cassia*, *Acacia*, *Crotalaria* and *Indigofera*, are widely diffused throughout the tropics apparently as uniform



primary types. Each temperate region adjoining tropical lands has its peculiar species of these genera, the species in each genus showing marked divergence in different directions in different temperate regions from the common or uniform types in the tropics, the endemic species as a whole of each temperate region exhibiting likenesses to the tropical types rather than to those of contrasted extra-tropical regions. Similar reasoning applies to the case of the various endemic genera in the various tribes.

In New Zealand, the endemic genera are three in number comprising twenty-two out of a total number of twenty-nine species of Leguminosæ in that country. This paucity of species appears remarkable at first sight, but its discussion is reserved for a subsequent chapter. It is sufficient, at this stage, to state that the three endemic genera are xerophytes, belonging to the tribe Galegeæ, which tribe, moreover, includes five out of the total of seven genera in the Island.

Australia contains ninety-seven genera of which thirty-five are endemic. These peculiar forms are decidedly vigorous and aggressive in the main, and, with the exception of a few genera, they are almost all xerophytes. Exceptions are to be found in the monotypic genera *Castanospermum*, *Podopetalum*, and *Barklya*. In the Podalyriæ there are twenty endemic genera comprising four hundred species. The genus *Pultenæa* alone contains about one hundred species. Genisteæ is also well represented by xerophytic types such as *Platylobium*, *Hovea*, *Bossiaea*, and *Templetonia*. *Labichea* and *Petalostyles*, also in Cassiæ, are xerophytes. Both the Australian Podalyriæ and Genisteæ form special subtribes.

South Africa, similarly to Australia, is rich in endemic genera, especially in peculiar subtribes belonging to Podalyriæ and Genisteæ. But whereas Australia is the strong-

hold in the world of Podalyrieæ, South Africa holds a similar proud position with respect to Genisteæ. Moreover, as with the Podalyrieæ of Australia, the South African endemic genera are very vigorous and aggressive and xerophytic in nature, flourishing alike in poor soils and severe climates. Whereas the Podalyrieæ of South Africa comprises only two genera with thirty species, the Genisteæ of that region contains nineteen genera and nearly four hundred species. One genus alone, *Aspalathus*, has one hundred and fifty species. Thus the hardy South African Genisteæ takes the place of the vigorous Australian Podalyrieæ.

Tropical Africa, Asia, America and Australia together (Australia, however, possesses only a few endemic tropical types) contain many endemic genera, but these almost all conform to the average type of the Leguminosæ, and are not suggestive of the aggressive xerophytes of either Australia, South Africa, Temperate Eurasia, or some portions of America.

Europe, in the Northern Hemisphere, is well supplied with genera and species of xerophytic Genisteæ, as for example *Ulex*, *Genista*, *Adenocarpus*, and *Cytisus*.

The Galegeæ and the related Hedysareæ have a great development in the temperate regions of the Northern Hemisphere. So also *Vicieæ*, *Trifolieæ*, and *Loteæ*, in common with the North Temperate Galegeæ, are almost absent from the Southern Hemisphere, except for a recent spilling, or creeping, from Northern Asia along the Andes and the high tablelands in America by way of British Columbia and the surrounding regions. Thus *Trifolium*, *Lupinus*, *Lathyrus*, *Vicia*, and *Astragalus* are absent from New Zealand and Australia, besides being absent, apparently, from South Africa, with the exception of one *Astragalus* and several species of *Trifolium*. Nevertheless these genera occur throughout the highlands from Cali-

fornia to Chili, the latter region containing many species of these genera.

It will be advisable at this stage to state the geographical distribution of a few important genera, and as a supplement to that to prepare a table showing the species of Leguminosæ in one region, such as tropical Africa, which are common to other continents or regions. The genera chosen in illustration of the first point are *Inga*, *Pithecolobium*, *Albizzia*, *Acacia*, *Mimosa*, *Calliandra*, *Piptadenia*, *Parkia*, *Cassia*, *Bauhinia*, *Eriosema*, *Dalbergia*, *Astragalus*, *Tephrosia*, *Indigofera*, *Crotalaria*, and *Lupinus*.

The analysis has been taken from *Pflanzenfamilien*, from the *Index Kewensis*, and from *Bentham's Flora Australiensis*, his *Revision of the Genus Cassia*, as well as from his *Mimoseæ*.

**INGA.**—About 150 species in five sections, all in Tropical America.

**PITHECOLOBIUM.**—About 120 species in seven sections. Five sections, containing 66 species, are endemic in America.

One Section, with 23 species, in Tropical Asia and Australia.

One section, with 28 species, four in Old World and twenty-four in America.

**ALBIZZIA.**—Three sections, namely, *Lophantha*, *Eualbizzia* and *Zygia*.

*Lophantha.*—India, Java, Malay, 20 species in a subsection in Tropical Asia and Africa, one in North America.

*Zygia.*—100 species in five subsections.

No. 1 Subsection, 20 species Tropical America and India.

No. 2 Subsection, 12 species West Indies, Mexico to Columbia.

No. 3 Subsection, 4 species in Brazil.

No. 4. Subsection, 60 species Old and New World (one Madagascar, one Ceylon).

No. 5 Subsection, 5 species in America.

This information regarding *Albizzia* has been taken from *Pflanzenfamilien*. According to the *Index Kewensis*, however, the genus *Albizzia* is not represented in America.

ACACIA.—About 700 species in six sections.

Gummiferæ.—In Tropical America, Africa, Asia, and Australia: also in Temperate regions.

The subsections *Summibracteatae* and *Medibracteatae* are widely diffused, but the subsection *Basibracteatae* in *Gummiferæ* is not represented in Australia.

Vulgares.—Abundant in America, Africa and Asia; absent from Australia.

Filicinæ.—Several species in America.

Botryocephalæ.—Large section. Endemic in Eastern Australia.

Pulchellæ.—Endemic in Western Australia.

Phyllodineæ.—About 400 species. Endemic in Australasia. A few waifs occur in neighbouring islands.

MIMOSA.—About 400 species in two sections, *Eumimosa* and *Habbasia*.

*Eumimosa*. + 140 species.

No. 1 Series in Tropical America.

No. 2 Series in Tropical America, with *M. pudica* as a cosmopolitan type.

*Habbasia*. + 160 species.

No. 1 Series in Tropical America.

No. 2 Series has two sub-series, one occurring in Tropical and Sub-tropical America, Africa and Asia; the other occurring in Tropical and Sub-tropical America, Africa and the Mascarenes.

CALLIANDRA.—100 species in five sections.

Macrophyllæ.—20 species, Tropical America, India.

Lactivirentes.—12 species, America, West Indies (*C. portoricensis*).

Pedicellatæ.—4 species, Brazil.

Nitidæ.—About 60 species, one subsection, America; one subsection, Ceylon and Madagascar.

Racemosæ.—5 species, Central America.

PIPTADENIA.—Three sections.

Eupiptadenia.—30 species, Brazil, Africa, Asia, Madagascar.

Pityrocarpa.—50 species, Tropical America.

Niopa.—5 species, four in Tropical America.

PARKIA.—19 species in two sections.

Euparkia.—6 species, Tropical Asia, 3 Tropical Africa, 3 species Brazil.

Paryphosphæra.—7 species, Tropical America.

CASSIA.—400 species in 3 subgenera, *Fistula*, *Senna*, *Lasiorrhæma*.

*Fistula*.—20 species, Cosmopolitan Tropics.

*Senna*.—

No. 1 Section.—2 species, Tropical Africa, 40 species American Tropics.

No. 2 Section.—15 species America; 1 of these in Asia and Australia.

No. 3 Section. + 70 species, majority in Tropical America. Well represented in Australia and Africa.

No. 4 Section.—20 species, Old World, especially Australia. Mostly xerophytes in Australia (E.C.A.)

*Lasiorhagma*.—160 species, especially in America. A few in Old World and Australia (*Chamæcrista*).

**BAUHINIA**.—150 species in eleven sections—three sections endemic in America, two sections endemic in Africa, two sections endemic in Asia, two sections in Africa and Asia, one small section in Tropical Australia and South-west Asia, one large section in Tropical America and Old World.

**ERIOSEMA**.—About 70 species, two sections.

*Simplicifolia*.—Tropical Africa, Brazil.

*Trifoliata*.—Brazil, Tropical Africa, Natal, The Cape, Asia, Australia.

**DALBERGIA**. + 80 species, four sections.

First Section.—15 species Old World, 4 species America.

Second Section. + 20 species Old World, + 15 species America.

Third Section. + 15 species Old World Tropics.

Fourth Section.—Cosmopolitan Tropics.

**ASTRAGALUS**.—About 1,250 species. (According to Bunge)—Nine sections in Europe, Asia and Africa, three sections in North America, three sections in South America, one section, namely, *Phaca*, has 250 species in Europe, Asia and Africa, many species also in North America, and 38 species in South America. Mostly cool to cold temperate types.

**TEPHROSIA**. + 130 species, four sections.

*Brissonia*.—50 species.

*Unifoliolatae*.—3 species, India, Tropical Africa.

Digitatæ.—2 species, Tropical Africa.

Pinnatæ.—40 species, Tropical Africa, of which *T. candida* occurs in India and Malay Islands, and *T. toxicaria* from Mexico to Brazil.

Reineria.—80 species.

Unifoliolatæ —4 species, Angola, India, Australia.

Heterophyllæ.—4 species, Tropical West Africa, Australia.

Pinnatæ. + 70 species, *T. purpuræ*, a cosmopolitan type.

Pognostigma.—1 species in Africa.

Requienia.—2 species, Tropical Africa.

INDIGOFERA.—About 300 species, four sections.

Euindigofera.—280 species. Endemic series and sub-series occur in Africa, Africo-Asia, Africo-Asiatico-Australia, or as cosmopolitan tropical types.

Amecarpus.—10 species, Africa and India.

Sphæridiophora.—48 species, India, Africa, Australia.

Æanthonotus.—Several species, India, Africa, Ceylon.

CROTALARIA.—250 species, three sections.

Simplicifoliæ.—One series out of seven occurs in Australia and India.

Unifoliolatæ.—4 species, one in Brazil, three in Australia.

Trifoliolatæ.—In all Tropics, especially Africa.

LUPINUS.—100 species, three sections.

Digitatæ gerontogææ.—12 species.

Digitatæ Neogææ + 60 species.

Simplicifoliæ.—12 species, Brazil, Eastern North America.

It will be helpful at this stage to supply a list<sup>1</sup> of the more important species of Leguminosæ in Tropical Africa, which occur either in other regions or which have closely-related species in other regions, so as the better to appreciate the nature of the relations existing between Tropical Africa and other lands. The list is not complete, as the analysis was only made on incomplete collections. Abbreviations used in this list are Trp. for Tropics, Eur. for Europe, Am. for America, Afr. for Africa, As. for Asia, Aust. for Australia, Cosmo. for Cosmopolitan, Ind. for India, W. Ind. for West Indies, Sp. for Species. By Afr. is meant Trp. Afr.

Genus and Species.	Countries in which Plants are Indigenous.	Remarks.
<i>Rothia</i> ... ..	One sp. Trp. Afr. ...	Other sp. very close in Ind. and Aust.
<i>Crotalaria retusa</i> ...	Ind. and Afr. ... ..	Possibly introduced to Afr.
„ <i>verrucosa</i> ...	Trp. Afr., Am., As., Mauritius.	
„ <i>calycina</i> ...	Trp. Afr., Ind., Aust.	
„ <i>orixensis</i> ...	Trp. Afr., Ind.	
„ <i>incana</i> ...	Cosmo., Trp. ... ..	Possibly introduced in Old World.
„ <i>striata</i> ...	Afr., Trp. As., Am., Natal.	
„ <i>latifolia</i> ...	Afr., W. Ind., Mauritius	(?)
<i>Argyrolobium virgatum</i> ...	Afr. ... ..	Very close to the Ind. type <i>A. flaccidum</i> .
<i>Parochetus communis</i> ...	Afr., Ind.	
<i>Trigonella hamosa</i> ...	Afr., Egypt, Cape, Ind.	
„ <i>occulta</i> ...	Afr., Ind.	
<i>Lotus corniculatus</i> ...	Afr., Eur., Jap., Aust.	
<i>Cyamopsis</i> ...	One sp. Afr., 1 sp. Ind.	
<i>Indigofera echinata</i> ...	Afr., Ind., Ceylon.	
„ <i>linifolia</i> ...	Afr., As., Aust.	
„ <i>cordifolia</i> ...	Afr., Ind., Malay, Ind.	
„ <i>viscosa</i> ...	Afr., East Ind., Aust.	
„ <i>pentayhylla</i> ...	Afr., East Ind.	
„ <i>parviflora</i> ...	Afr., As., Aust.	
„ <i>subulata</i> ...	Afr., As., W. Ind., Mexico	
„ <i>paucifolia</i> ...	Afr., As.	
„ <i>hirsuta</i> ...	Afr., Mediterranean, As., Aust.	

<sup>1</sup> Analysis of chapter on Leguminosæ by Baker, in Oliver's "Flora of Tropical Africa," Vol. II, 1879.



Genus and Species.	Countries in which Plants are Indigenous,	Remarks.
<i>Indigofera enneaphylla</i> ...	Afr., Ind.	
„ <i>anil</i> ...	Afr., Am.	
<i>Tephrosia villosa</i> ...	Afr., Ind.	
„ <i>incana</i> ...	Afr., Ind.	
„ <i>purpurea</i> ...	Cosmo. Trp.	
<i>Mundulea suberosa</i> ..	Afr., As.	
<i>Sesbania aegyptica</i> ..	Afr., As., Aust.	
„ <i>aculeata</i> ...	Afr., As., Aust.	
<i>Taverniera</i> ...	Egypt to N.W. Ind. ...	Small desert genus.
<i>Alhagi</i> ...	Egypt to N.W. Ind. ...	Small desert genus.
<i>Ormocarpum dennooides</i> ...	Afr., As., Aust... ..	Trp. Coasts.
<i>Aeschynomene sensitiva</i> ...	Afr., As.	
„ <i>indica</i> ..	Afr., Trp. As., Aust.	
<i>Smithia sensitiva</i> ...	Afr., Ind.	
<i>Stylosanthes viscosa</i> ...	Afr., Trp. Am.	
„ <i>mucronata</i> ...	Afr., As.	
<i>Zornia tetraphylla</i> ...	Afr., The Cape, N. and S. Am.	
<i>Desmodium umbellatum</i> ...	Afr., Medit., As.	
„ <i>spirale</i> ...	Afr., Polynesia, Am.	
„ <i>giganticum</i> ...	Afr., Ind., Malay.	
„ <i>lasiocarpum</i> ...	Afr., Ind., Malay.	
„ <i>ascendens</i> ...	Afr., Am.	
„ <i>incanum</i> ...	Afr., Aust., Am. ...	Trp. Coasts.
„ <i>scalpe</i> ...	Afr., Mascarens, Ind., Malay.	
„ <i>polycarpum</i> ...	Afr., Ind., Malay.	
<i>Uraria picta</i> ...	Afr., As., Aust.	
<i>Alysicarpus monilifer</i> ...	Afr., As.	
„ <i>vaginalis</i> ...	Cosmo. weed.	
„ <i>rugosus</i> ...	Afr., Cape, As., Aust.	
<i>Abrus precatorius</i> ...	Cosmo. Trp. ... ..	Trp. Coasts.
„ <i>pulchellus</i> ...	Afr., As., Malay, Natal.	
<i>Centrosema virginiana</i> ...	Afr., Am. ... ..	Trp. Coasts.
<i>Clitoria ternatea</i> ...	Cosmo. Trp. ... ..	Cultivated.
<i>Glycine javanica</i> ...	Af., Natal, As.	
<i>Mucuna urens</i> ...	Cosmo. Trp. ... ..	Trp. Coasts
„ <i>pruriens</i> ..	Cosmo. Trp. ... ..	Trp. Coasts
<i>Galactia tenuiflora</i> ...	Afr., Mascarenes, E. Ind.	Trp. Coasts.
<i>Dioclea reflexa</i> ..	Afr., As., Am. ... ..	Trp. Coasts.
<i>Canavalia obtusiflora</i> ...	Afr., As., Am., Aust. ...	Trp. Coasts.
„ <i>ensiformis</i> ...	Cosmo. Trp. ... ..	Stray from cultivation (?)
<i>Phaseolus lunatus</i> ...	Cosmo. Trp. ... ..	Not recorded from Aust. (E.C.A.)
„ <i>adenanthus</i> ...	Cosmo. Trp. ... ..	Not in Aust. (E.C.A.)
„ <i>trinervis</i> ...	Afr., Natal, As.	
„ <i>trilobus</i> ...	Afr., As.	
<i>Vigna vexillata</i> ...	Cosmo. Trp. ... ..	Trp. Coasts.
„ <i>luteola</i> ...	Afr., Cape, As., Am.	
„ <i>oblonga</i> ...	Afr., Am. ... ..	Trp. Coasts.
„ <i>lutea</i> ...	Cosmo. Trp. ... ..	Coastal form.
<i>Pachyrhizus</i> ...	2 sp. Afr., 1 sp. Mexico	3 sp. in genus.

Genus and Species.	Countries in which Plants are Indigenous.	Remarks.
<i>Dolichos biflorus</i> ...	Afr., As., Aust.	
" <i>axillaris</i>	Afr., Medit., Cape.	
" <i>uniflorus</i> ...	Afr., As.	
<i>Rhynchosia cyanosperma</i>	Afr., E. Ind. ...	} Coastal types.
" <i>minima</i> ...	Cosmo. Trp. ...	
" <i>caribæa</i> ...	Cape, Afr., Am.	
" <i>viscosa</i> ...	Af., Mascarenes, E. Ind.	
<i>Ecastaphyllum Brownii</i>	Af., Am. ...	(Dalbergia).
" <i>monetaria</i>	Af., Am.	"
<i>Drepanocarpus lunatus</i> ...	Af., Am	
<i>Derris uliginosa</i> ...	Afr., As., Aust... ..	Trp. Coasts.
<i>Sophora tomentosa</i> ...	Cosmo. Trp. ... ..	Coastal form.
<i>Casalpinia bonducella</i> ..	Cosmo. Trp. ... ..	Coastal form.
<i>Cassia occidentalis</i> ..	Cosmo. Trp. ... ..	Coastal form.
" <i>sophora</i> ... ..	Af., Nth. Afr., E. Ind. Archipelago.	Introduced (?).
" <i>lævigata</i> ... ..	Afr., Am., Aust. ... ..	Colonists (?).
" <i>tora</i> ... ..	Cosmo. Trp. ... ..	Not in Aust. (E.C.A.)
" <i>alata</i> ... ..	Cosmo. Trp. ... ..	Colonist (?).
" <i>absus</i> ... ..	Afr., As., Aust.	
" <i>nigricans</i> ... ..	Afr. ... ..	Very close to <i>C. patellaria</i> Trp. Am.
" <i>Kirkii</i> ... ..	Afr. ... ..	Very close to <i>C. chamæ-</i> <i>crista</i> , Am.
<i>Bauhinia tomentosa</i> ...	Afr., Natal, As.	
<i>Erythrophleum</i> ... ..	2 or 3 sp. Afr. ... ..	1 sp. Aust.
<i>Pentaclethra tomentosa</i> ..	Afr. (Coasts) ... ..	1 sp. in Trp. Am. closely allied.
<i>Parkia biglobosa</i> ... ..	Afr., Ind.	
<i>Entada scandens</i> ... ..	Afr., As., Aust., Am. ...	(Coastal).
<i>Adenanthera</i> ... ..	Afr., As., Aust.	Very small genus.
<i>Neptunia oleracea</i> ... ..	Cosmo. Trp. ... ..	Not in Aust. (E.C.A.)
<i>Mimosa pudica</i> ... ..	Cosmo. Trp. ... ..	Colonist.
" <i>asperata</i> ..	Afr., Am.	
<i>Schrankia leptocarpa</i>	Afr., Am. ... ..	Coastal form.
<i>Acacia catecha</i> ... ..	Afr., As.	
" <i>pennata</i> ... ..	Afr., As.	
" <i>Sieberiana</i> ... ..	Afr. ... ..	Near <i>A. macrantha</i> , Am.
" <i>Farnesiana</i>	Cosmo. Trp. ... ..	Near <i>A. Sieberiana</i> .
<i>Calliandra portoricensis</i>	Afr., Ind., Am... ..	Coastal form.
<i>Albizia julibrissin</i> ...	Afr., As.	
" <i>amara</i> ... ..	Afr., As.	
" <i>Lebbek</i> ... ..	Afr., As.	

Tropical Africa has at least 80 species of Leguminosæ common to Tropical Asia, 15 species common to Tropical Asia and Australia, 3 common to America and Asia, 1 common to America and Australia, 16 common to Tropical America, and 27 in common with the world-wide tropics; several of the last group, however, are absent from Australia.

Of these some may be found to fall in line either with proved colonists such as *Pithecolobium dulce*, *Mimosa pudica*, *Mimosa sepiaria*. *Luccæna glauca*, *Desmanthus virgatus*, or with plants transported by sea currents, such as *Entada scandens*, *Afzelia bijuga*, *Abrus precatorius*, and *Sophora tomentosa*.

Attention will be directed to this subject in a subsequent chapter.

If consideration be now given to the distribution of Leguminosæ in Australia, it will be seen that out of 39 genera in Australia which have almost cosmopolitan tropical range, and which possess 535 species in Australia, 73 species are common to Asia, 22 to Africa and 12 to Tropical America.

Facts such as these led Wallace,<sup>1</sup> the great exponent of geographical distribution, to the conclusion that the tropical flora of Australia was comparatively recent and derivative. Wallace also, from the distribution of the plants, proceeded to explain the origin of the endemic flora of New Zealand.<sup>2</sup>

The discussion of this point may be deferred until a later stage, but, in the meantime, it may be stated that the facts presented in this note indicate that Australia has been isolated from the rest of the world for a long period, and that, with the exception of certain species which appear to be colonists or waifs, those genera in Australia which are not endemic there have been in that continent for a long time.

Thus it will be seen that the following widely-spread genera have established themselves firmly in Australia, and have each produced from one to numerous endemic species: *Crotalaria*, *Trigonella*, *Lotus*, *Psoralea*, *Indigofera*,

---

<sup>1</sup> (62) p. 493. <sup>2</sup> *Ibid.*, p. 500.

Milletia, Clianthus, Swainsona, Glycyrrhiza, Desmodium, Uraria, Lespedeza, Glycine, Erythrina, Galactia, Vigna, Atylosia, Rhynchosia, Flemingia, Dalbergia, Lonchocarpus, Derris, Sophora, Mezoneurum, Pterolobium, Cassia, Bauhinia, Afzelia, Erythrophloeum, Adenantha, Neptunia, Acacia, Albizzia, and Pithecolobium.

From this list the systematist will note the absence of Eriosema, Smithia, Zornia, Mimosa, Calliandra, Inga, Dolichos, Æschynomene, and other well known and widely-spread genera. It would appear as if Australia had been isolated from the tropical world before the differentiation of these types, and that the species belonging to such forms as Æschynomene, Smithia and Zornia, now found in Australia, are either colonists or waifs.

It is possible also that the thirty-five genera enumerated above were established in Australia before the development of the thirty-five endemic genera of that continent, and that they are examples of arrested development, whereas the endemic forms are vigorous, but younger types, which only appear to be ancient and archaic by reason of their stunted and weather-beaten aspect.

This statement concerning the probable great age of the pantropical genera of Australia, and the relative youth of the endemic legumes of Australia, and South Africa, is not so remarkable as might appear upon first consideration, if a co-ordination be made of the principles upon which plant distribution and development depend. But before a discussion of these it will be advisable to mention the main features of the Cretaceous and Post-Cretaceous geography and climate. After a brief discussion has been presented in a later chapter of the principles of geographical distribution, the way will be open for a consideration of both the home and the nature of the primitive types, and some insight may thus be gained as to the lines along which the development of Leguminosæ appears to have taken place.

### **The Geography of the Cretaceous and Later Periods.**

It is always a matter of difficulty to determine the amount of reliance which can be placed upon geological evidence in the elucidation of problems dealing with the distribution of any particular angiospermous genus in former times. There are, however, several points upon which reliance may be placed in this inquiry, and these depend, in part, upon the relations of land and sea, and the general relief of the land, and, in part also, upon the general characters of any particular group of plants under consideration occurring in the fossil state. Thus, conclusions fairly definite may be reached as to the nature of the climate of a bygone period from a study of the plant remains as a whole from rocks of that age. Satisfactory results may also be obtained as to the order, the family, the genus, or even the species, to which a plant belongs, provided full and abundant material be available for examination. On the other hand it is extremely hazardous and quite unscientific to refer angiospermous forms of plants to genera, or even families, on the evidence of leaves alone, and this for the reason that the greatest systematic botanists need full material for the proper determination of *modern* plants.

The following general notes concerning Upper Cretaceous, Tertiary, and modern geography may be found helpful in a discussion of the distribution of the Angiosperms.

Modern geography is characterised by the presence of high mountains, great deserts, large continents, small inland seas, glaciated poles, and a strong differentiation of climate generally.

Upper Cretaceous geography, on the contrary, was characterised by the presence of low-lying lands, by large epicontinental seas, by an extension of mild and genial climate from the tropics to the polar regions. The fossil plants discovered in sediments of this age suggest, moreover, that the climate was moist as well as mild.

The general lack of relief in the Cretaceous continents appears to have been due to the action of long continued erosion, while the great epicontinental seas were caused by a general rise of the ocean levels, suggestive of a spilling over of the oceans basins on to the continents. North America was separated thus into two portions by a long and wide sea running north and south from the Gulf of Mexico to the Arctic Ocean. A great Mediterranean sea appears to have extended from the Mexican Gulf clean across South Europe, and Northern Africa, to the eastern portion of the Himalaya. Australia also was almost completely separated in two portions<sup>1</sup> by a long and wide sea extending southwards from the Gulf of Carpentaria. The continents of Asia and Africa also appear to have been isolated towards the close of the Cretaceous by the general rise of the water in the ocean basins.

A study of the fossil animals and plants, as also the sediments of the periods, indicates that the Cretaceous was a period of genial and moist climate, but that the latter became differentiated somewhat near its close.

The Eocene, or Earlier Tertiary, was ushered in by the formation of mountain chains in regions outside of Australia and Africa generally. The epicontinental seas were drained, in great measure, but the great Mediterranean sea already mentioned was a distinctive feature, as was also an offshoot thence from the Caspian Sea region establishing marine communication with the Arctic Ocean. The climate was generally mild and moist extending far to the north and south of the tropics.

Since that date the climate of the globe has been undergoing distinct, but oscillatory, differentiation throughout the Miocene and Pliocene Periods culminating in the

---

<sup>1</sup> (2) p. 526 - 538.

Great Ice Age of Post-Tertiary time. This period has just disappeared. Great mountain ranges were formed also, either during, or at the close of, both the Miocene and Pliocene Periods.

In Australia the land appears to have been worn down to a low-lying surface towards the close of the Cretaceous, and much of the area so worn down was of barren sandy, or hungry clay, nature. During the Tertiary the eastern side of the continent had been elevated by stages to its variable height, and the waste from the plateaus so formed was carried, in part, by the inland drainage to form the rich soils of the great plains of the interior. These inland plains are therefore relatively recent in age.

South Africa also, during later geological time, appears to have been elevated to form a great plateau. Southern New Zealand also, in the closing Tertiary, appears to have been elevated to form high plateaus.

The Pleistocene Ice Age arose from a general lowering of temperature throughout the world.

Messrs. David, Pittman, and Helms<sup>1</sup> have also demonstrated a Pleistocene glaciation for the Kosciusko Plateau of Australia.

*Summary.*—The geological records of Cretaceous and Post-Cretaceous time suggest that there was a luxuriant vegetation both in Upper Cretaceous and Eocene time, with xerophytic forms confined to barren, sandy and hungry dry areas relatively limited in extent. A gradual contraction of areas of moist and mild climate is indicated for the Post-Eocene, with a concomitant increase in the development of xerophytes in the world, especially in either exposed subarid, or sandy, areas such as Australia, South Africa, and the steppes of Eurasia. The Post-Tertiary

---

<sup>1</sup> (27).

Glacial Period connotes either rapid modification, or migration, of tertiary plant types respectively within, or from, any given district affected.

### **The Age of Dicotyledons,**

With notes on generic determinations of Angiosperms on the evidence of leaves alone.

In any discussion as to the age of a particular family or order of the Dicotyledons, it would be necessary in the first place to ascertain the morphological position occupied by such family, or order, in its subclass; and, in the second place, to ascertain if possible, the geological age of the subclass or class itself.

With regard to the first point, it would appear that the Leguminosæ are types which are highly developed, as compared with many families of the Dicotyledons, such as the Casuarinæ, the Juglandaceæ, the Salicinæ, the Cupuliferæ, the Ulmaceæ, and the Moraceæ. This suggests that the present families of the Leguminosæ had not been outlined until the earlier forms of the dicotyledons had been well established and differentiated.

With regard to the second point, it may be mentioned that no undoubted plant remains of dicotyledonous nature have been found in beds older than the lower Cretaceous. On the other hand they have been recorded from the oldest of these beds in the Atlantic Coast area of the United States, while from the younger beds of the Lower Cretaceous, Dicotyledons have been recorded throughout North America.<sup>1</sup>

“In Portugal primitive types of Angiosperms appear in the Lower Cretaceous, but apparently not so low down in the series as the Potomac of North America. . . . The view that seems best justified at the present stage of

---

<sup>1</sup> Chamberlain and Salisbury (24) pp. 130-133.



evidence is that the angiosperms developed on the old lands of the eastern part of North America, and that until the close of the Lower Cretaceous they had only spread westward as far as Kansas and the Black Hills, northward as far as Greenland, and eastward to the coast of Portugal, but not to Europe generally, nor to the western part of North America, for they do not appear in the Kootenay or the Shastan series. . . . In the most typical region on the Atlantic coast, nearly half the known 800 species of Comanchean age are angiosperms. They began in marked minority in the lowest Potomac (Lower Cretaceous) and increased to an overwhelming majority in the uppermost beds. The earliest forms are ancestral, but not really primitive, and throw little light on the derivation of the angiosperms. While some are undifferentiated, the majority bear resemblances to modern genera. . . . ” (p. 133).

Scott<sup>1</sup> refers to the great work of Wieland in describing the Bennettites found in the Upper Jurassic and Lower Cretaceous rocks of Western America. This group of plants appears to be intimately related to the modern Cycadaceæ and the Angiosperms are supposed to have descended through these Bennettites. The Dicotyledons are believed to be older than the Monocotyledons, the latter descending in turn through the Polycarpicæ<sup>2</sup> of the Dicotyledons.

Adverting to the question of the geographical distribution of the Dicotyledons as time progressed, it may be noted that by the close of the Upper Cretaceous they had spread over a great portion of the world and, moreover, by the close of that period, they had become highly differentiated.

It would appear, indeed, as though a new yet cosmopolitan set of geographic and organic conditions had

<sup>1</sup> The Evolution of Plants. Home University Library, p. 80.

<sup>2</sup> Strasburger. Text Book of Botany. 1912, p. 525.

characterised the Cretaceous Period, and that it had caused the rapid rise and differentiation of the angiosperms, together with their dispersal throughout the world. In this development insects possibly played a great part.

Inasmuch as the Leguminosæ, especially the Papilionaceæ, are highly developed members of the Dicotyledons, it would appear that they had no existence during the Lower Cretaceous.

Taubert,<sup>1</sup> in Pflanzenfamilien, records the existence of Leguminosæ remains, as fossils, from sediments of unknown age. It is thought the age may be Tertiary. It is difficult, however, to classify dicotyledonous fossils in the absence of full material. Reports have been made by Heer, Unger (61) and Ettingshausen (32), in which certain Upper Cretaceous and Tertiary fossils of dicotyledonous types have been referred to existing families, and even to living genera, from the evidence of leaves alone in the main. All such determinations should be treated with the utmost caution. It is very difficult to classify many modern dicotyledonous types, even with full and abundant material and a knowledge of the growing plants. For example, the genus *Krameria* is now placed in the Leguminosæ, nevertheless the great systematist, Bentham, referred it to the Polygalææ; Lindley was inclined to place it among the Sapindaceæ, because of its trifoliolate leaves, but Asa Grey pointed out that trifoliolate leaves were characteristic, also, of certain tribes of Leguminosæ. Other examples might also be quoted, such as the difficulty experienced by systematists in classifying Chamalauciæ and Lecythideæ, as also the genera *Trigonia*, *Podogonium*, and *Acicalyptus*. The leaves of *Hakea*, *Persoonia*, *Grevillea*, *Acacia* and *Eucalyptus* may also be cited as consisting of varied forms.

---

<sup>1</sup> (60) p. 385.

Nevertheless, on the evidence of leaves alone, in most cases, genera such as *Magnolia*, *Ficus*, *Eucalyptus*, *Hakea*, *Knightia*, *Lomatia*, *Banksia* and *Fagus* have been recorded from Upper Mesozoic and Tertiary beds in Europe and America, whereas all that could have been stated with any approach to certainty was that these leaves belonged to certain alliances, or large groups of orders, among the dicotyledons. Even leaves of the Polycarpicæ, within certain limits, might be mistaken for monocotyledons.

Clement Reid, in a letter to the writer, has drawn attention to the figured fossils supposed to be traces of *Eucalyptus* in "Die Tertiäre Flora von Häring" by Eittingshausen. In this figure may be seen fossil leaves bearing a general form analogous to a few modern *Eucalyptus* types, but certainly not at all similar to the leaf of the *Eucalypt* as it must have existed before the later Tertiary, if reliance is to be placed upon morphological characters. Around the leaves are arranged fruits somewhat suggestive of the forms of modern *Eucalypt* types, but apparently artificial in their geometrical arrangement on the slab. Even, however, were fossil buds with opercula, and flowers without petals in association with them, to be recorded from Europe and America, this would by no means prove that such plants were *Eucalyptus*. *Acicalyptus*, far removed from *Eucalyptus*, has a circumciss operculum. *Calyptranthes*, one of the *Myrtæ*, has a circumciss operculum, and in some species the petals are suppressed. *Marlieria* also has an operculum. No student of living *Eucalypts*, moreover, would mistake the fossil leaves assigned to *Eucalyptus* in the Northern Hemisphere for leaves of that genus. In this connection Mr. R. H. Cabbage has drawn my attention to an illustration<sup>1</sup> of a

---

<sup>1</sup> Taken from "Comprehensive Catalogue of Queensland Plants," p. 90, by F. Manson Bailey.

leaf of *Samadera Bidwilli* (Simarubææ), which the ordinary botanist, not well versed in *Eucalyptus* studies, might mistake for a leaf of that genus.

In a note shortly to be issued by Mr. Cambage and the writer, it may be seen that the evidence is overwhelming against the probability of any dicotyledonous genus which is endemic in Australasia, having existed in any other continent in either Cretaceous or Tertiary time. These endemic genera, such as those of the Australian Podalyriæ in Leguminosæ, as *Eucalyptus* and others in Myrtacæ, form peculiar groups, all evidencing a similar origin, as a response to a common geographical environment, and one which, during the Mesozoic, does not appear to have existed elsewhere during, or prior to, the isolation of Australia from the tropics. These endemic types are so numerous, both in genera and species, so full of vitality and endurance, that it would be impossible to believe in their annihilation, one and all in Europe, Asia, Africa and America, without leaving any closely related types had they existed in those countries in Tertiary time. In this connection it is of little use to call in the aid of the aggressiveness of the Scandinavian and Himalayan floras as a means of annihilation of the types under consideration in the Northern Hemisphere. In the first place the Australian types are mainly xerophytes, and would not enter into competition with luxuriant tropical vegetation inasmuch as they avoid such growths even in Australia.<sup>1</sup> But if forms such as *Eucalyptus*, *Hakea*, *Pultenæa*, the phylloclineous *Acacias*, *Styphelia*, *Boronia*, *Leptospermum*, *Banksia*, *Kunzea*, *Daviesia*, and *Persoonia*, had gained access either to South Africa or to the plains and rocky, sandy, or waste areas of Eurasia and America there would be little need to entertain any fears as to their ability to maintain themselves in such localities.

---

<sup>1</sup> (2), pp. 529 - 534.

Nevertheless, in spite of all these facts, the best geological text books to-day perpetuate these unscientific conclusions—conclusions based upon evidence which no systematist of note would endorse for living plants, and conclusions which appear to have given such an utterly false idea of plant development and of geography in Cretaceous and Tertiary time. No real advance may be expected with regard to the age and development of the dicotyledons, and, incidentally, of Leguminosæ and Myrtaceæ, unless unreliable determinations are to be discarded in dealing with matters of such importance. All lines of evidence must converge if truth is to be attained, and palæobotany should be submitted to the rigorous methods employed in modern angiospermous classification by systematists such as Hooker, Bentham, Lindley, Asa Grey, Engler, and even Ettingshausen himself.

#### **Some Principles of Geographical Distribution.**

The orders of plants considered in this chapter are Leguminosæ and Myrtaceæ.

The great genera of Leguminosæ occur, as a rule, in the open country, and they frequent the poorer, rather than the richer, soil. They are composed mainly also of herbs, undershrubs, shrubs or small trees, rarely forest trees. A careful study of Taubert's learned and comprehensive article on Leguminosæ, in "Pflanzenfamilien" would enlighten the reader on this point. As examples may be quoted *Astragalus*, with about 1,250 species, from the plains, steppes, and wastes, of temperate Eurasia, and America; *Acacia*, with about 700 species occupying subarid and open lands in most regions, although some species frequent thick forests. *Cassia*, *Crotalaria*, *Ononis*, *Lotononis*, *Genista*, *Ulex*, *Pultenæa*, *Dillwynia*, *Aspalathus*, *Daviesia*, *Tephrosia*, *Indigofera*, *Swainsona*, *Medicago*, *Rhynchosia*, *Psoralea*, and others, may be cited in this connection.

Moreover, most of these great genera are either xerophytic, or dwarfed, in nature. Supplementary evidence is also afforded by a study of Australian Myrtaceæ where the great genera *Eucalyptus*, *Melaleuca*, and *Leptospermum* are xerophytic in nature, with the exception of the types which have been developed recently, in the moist eastern portions of the continent.

In this connection it may be advisable to consider the environment of the plants. The Leguminosæ of the fertile tropics are subject to severe competition in the jungle, but there are limitations set to the struggle, and, moreover, such struggle proceeds along few lines. In the first place the climate is mild and equable, each plant protects the other in great measure from the storm and diurnal changes in temperature, and the competition resolves itself into a desperate struggle to reach the light and obtain food. With the plants of the open, sub-arid, or barren and sandy, plains or plateaus the struggle for existence is much more complicated. Great variation of conditions is ever to be expected. The food supply is scanty, the climate is torrid in summer and marked by cold desolating winds in the winter. The diurnal changes of temperature, moreover, are very great. Generally, also, the plants of these regions are more or less isolated, their foliage is not dense, and they are unable to protect each other from fierce and sudden climatic changes. The rain may fail to fall for months at a time, and the plants of such regions must develop special structures to minimise transpiration. Plants which can thrive under such hardships are possessed of wonderful powers of vitality.

It may seem strange that the hardy xerophyte, being possessed of enormous vitality and rich in species, should not in turn, over-run and oust the jungle growths, nevertheless a little reflection would supply the explanation.

The xerophytes with their phyllodes, cladodes, leaves hung vertically, woolly surfaces, bulbous rootstocks, and their leathery leaf cuticles, all calculated to diminish transpiration in barren sand, sub-alpine swamps, saline coastal soils or deserts, would be handicapped by such structures in regions of prolonged rainfall, abundant shelter and rich soil. Moreover, being lovers of the direct rays of the sun, and being of diminished height, they would be strangled and suffocated by the twining and towering canopy of the jungle. In the jungle, then, the struggle is for light and food and the tendency there for the Angiosperms is to produce tall trees or great climbing twiners, with abundance of luxuriant foliage as opposed to the tendency of xerophytes to become dwarfed, and with a limited food supply, to develop into numerous species and to exercise their strength in the production of abundance of fruit and seeds rather than magnificence of the individual.

This great vitality of xerophytes, within appropriate limits, is exemplified well in the distribution of Leguminosæ and Myrtaceæ, in both the subarid as well as the more barren and sandy portions of Australia, also in the distribution of Leguminosæ both in sub-arid South Africa and in the waste places of Europe and Asia. This has led the majority of botanists to consider the tropical Mimosæ, and Cæsalpinieæ, as of relatively recent development, while at the same time, it has led them to consider forms such as Eucalyptus, the Australian Podalyrieæ, the South African Genisteæ, and the extratropical Galegeæ, as of great age. Nevertheless, in a former chapter, it has been shown that the evidence both of the geographical distribution and the plant morphology suggests that types such as Acacia and Cassia were in existence before any of the existing Podalyrieæ, or Genisteæ, with the exception of the tropical Crotalaria, and before any of the xerophytic Galegeæ or

Hedysareæ. On the other hand a study of the seedlings of legumes suggests that the Mimoseæ are relatively young as compared with genera such as Cassia, Crotalaria, Rhynchosia, Psoralea, Dalbergia, Bauhinia, and Sophora. Still again, however, from a study of seedlings and from a study of allied families such as Rosaceæ, Connaraceæ, Saxifragaceæ, Passifloraceæ, and Crassulaceæ, it is evident that the Papilionaceæ are extremely modified plant types, and that free stamens and regular corollas characterised the more primitive types of the order. To this point reference will be made subsequently.

It is not here maintained that Mimoseæ and Cæsalpinieæ are older than Papilionaceæ, but on the other hand, it would be unscientific to assume that the Papilionaceæ are the older forms simply because the Mimoseæ and Cæsalpinieæ belong to the tropics, rather than to the temperate regions, and because the Papilionaceæ have spread from the tropics into the temperate regions.

In many genera there is a tendency to become fixed under peculiar conditions, while for certain elastic types a new geographical environment presents them with the opportunity to develop into new genera and species with great relative rapidity. A hasty consideration of Sophoreæ would suggest its youth as compared with that of Podalyrieæ, nevertheless, as may be shown later, the former appears to be an old, decadent tribe, while the latter is a vigorous offshoot from this vanishing tribe. Indeed, the geographical distribution and the morphology of Leguminosæ and Myrtaceæ suggest that small genera sporadically distributed over wide areas are decadent types, while local floras of peculiar type with large genera and numerous individuals are relatively young.

An example of this may be seen in the infrequent members of Dalbergia, Sophora, and other types, confined to



small patches of the fertile tropics in Australia, just as though they had been gathered from the world-wide tropics and carefully guarded from marked modification, while *Eucalyptus* and the phyllodineous *Acacias* have overrun Australia both in species and individuals. Nevertheless, outside Australia the *Eucalypt* and the leafless *Acacia* only occur as waifs or strays which have undergone but slight modification.

To understand the development of a genus the factors of evolutions must be considered. These comprise selection, heredity, environment, and variations. But traced backward far enough, geographical environment appears to be the key to evolution.

One genus may be endemic and yet appear to be ancient, another may be cosmopolitan and yet appear to be recent and derivative. Such a conclusion needs careful consideration since the operation of one principle must not be permitted to clash with that of another. A study of the next chapter will help the student in this connection.

For example, the *Eugenias*, as classified by Bentham, the *Myrtles*, *Erythrinas*, *Sophoras*, and *Dalbergias*, of Australia, flourish in the fertile tropical or subtropical forests or jungles; they present great similarities in general appearance to these genera in Asia, and other places, so much so that they appear recent and derivative. The *Eucalypts*, *Melaleucas*, the phyllodineous *Acacias*, the *Pultenæas*, *Dillwynias*, *Daviesias*, and *Jacksonias*, on the other hand are peculiar and have no close relations in other portions of the globe. The luxuriant types by their rich colouring and their delicate leaves give the impression of youth for these types, while the rusty, dilapidated, weather-beaten, tough, and stunted appearance of the majority of the endemic genera cited give the impression of great age.

Let it be assumed that the latter types which have overrun Australia, and which also have such a venerable and weatherbeaten aspect, are ancient, while the luxuriant types mentioned are of recent development. To maintain this claim it would be necessary to account for the fact that the species of types such as *Eugenia*, *Myrtus*, *Erythrina*, and *Sophora*, in Australia are endemic, with the exception of a few waifs transported from other continents by marine currents, while these same genera but with other endemic species, occur throughout the tropics, some also, as *Eugenia* and *Myrtus*, occur in New Zealand, while the phyllodineous *Acacias*, *Eucalyptus*, *Pultenæa*, and other genera in *Myrtaceæ* and *Leguminosæ*, are confined to Australia or its vicinity.

If then a bridge existed for the advance in recent time of *Myrtus*, *Eugenia* and *Sophora*, towards Australia, it should at the same time have permitted of the egress of the more ancient Australians within certain limits of soil and climate.

Again, it would be necessary, in such an assumption, to explain the fact that a study of the seedlings of *Eugenia*, *Myrtus*, *Sophora*, *Dalbergia*, and other types, indicate plants which have long since attained their general characters while the seedlings of *Eucalyptus*, the phyllodineous *Acacias*, *Bossiaea*, and other endemic Australian types, suggest that these plants have only, in relatively recent geological time, assumed the general leaf forms possessed by them at present, and that the types from which they have sprung are closely related to the widely spread tropical forms, such as *Eugenia* and *Myrtus* in the case of the *Eucalyptus*, and to the tropical *Acacias* in the case of the phyllodineous *Acacias*.

In the next place the luxuriant types have a very limited area within which to expand, even in the tropics of

Australia, while, on the other hand, the Eucalypts, the phyllodineous Acacias and other endemic plants have almost the whole of Australia in which to develop. Thus the luxuriant forms have but insignificant opportunities of developing fresh species.

From these considerations it would appear that the luxuriant types are much the older, while the xerophytes are by far the younger, forms in Australia.<sup>1</sup> This illustrates, in a measure, a few of the principles of Geographical Distribution, the main consideration being that all principles should be coördinated without clashing, thus excluding any hasty generalisation.

Another principle governing the distribution of plants is that occasioned by the combined influence of soil and climate. Cambage has done pioneer work in this connection in Eastern Australia. If this continent should be converted rapidly into an area of heavy and continued precipitation, and if the present poor sandy soils should be replaced by heavy ones, then the great bulk of the endemic vegetation of Australia would perish hopelessly. On the other hand, if the areas of heavy precipitation now supporting luxuriant vegetation in Australia should be supplied with a rainfall of less than 20 inches a year, and falling mostly in one season, then the types at present luxuriant would in turn vanish and the endemic genera would reign supreme.

It might be interesting also to enquire how *Edwardsia*, *Eugenia*, *Myrtus* and *Leptospermum*, could occur in New Zealand, while neither *Acacia*, *Cassia*, *Melaleuca*, *Dalbergia* nor *Erythrina* have been collected within that area.

---

<sup>1</sup> Since this report was written Mr. R. H. Cambage has drawn my attention to an article by Dr. Domin (31), in which the separation of Australia from Asia is supposed to have taken place at an early period, resulting in a great number of endemic species being developed in Australia.

It will be advisable in this case to make an assumption, namely, that all the Myrtaceæ and Leguminosæ, as known to-day, were in existence during certain assumed land conditions between Australia and the neighbouring lands as outlined herewith.

(1) That New Zealand was connected to Australia by a long strip of land viâ Antarctica,<sup>2</sup> while both countries were separated by a wide and deep sea to the north as at present.

(2) That New Zealand was connected directly with the south-eastern portion of the continent.

(3) That the two lands were connected by a relatively narrow tropical belt viâ New Guinea, the Solomon Islands, and the New Hebrides, as suggested by Hedley.

Under the first complex assumption there would be no migration of either Leguminosæ or Myrtaceæ, with the possible exception of certain species of *Leptospermum*, *Pultenæa*, *Bossiaea* and *Bæckea*, for climatic reasons. These genera are all represented at the present time in the colder parts of Tasmania. On the other hand, this would have afforded an excellent opportunity for the passage of types such as Ericaceæ, some Epacrideæ, Campanulaceæ, and many genera of Compositæ.

Under the second assumption New Zealand would be populated from Australia with *Eucalyptus*, phyllodineous types of *Acacia*, *Daviesia*, *Swainsona*, *Pultenæa*, *Dillwynia* and other forms, such as *Bæckea*, but not by forms such as *Sophora*, *Castanospermum*, *Dalbergia*, *Entada* and *Afzelia*.

Under the third assumption, let us suppose that the soil was sandy and barren in nature. The *Eucalyptus* of then Corymbosæ type, many phyllodineous *Acacias*, *Bæckea*,

---

<sup>2</sup> Hedley (39).

Leptospermum, Jacksonia, Melaleuca, Callistemon, and allied types, could have reached New Zealand. Let us suppose as an alternative to this that the soil was good, the shelter pronounced, and the rainfall long continued. This land connection, while being distinctly opposed to the distribution of xerophytes, would favour the passage of fertile tropical types, especially dense jungle growths. Nevertheless types such as Dalbergia, Castanospermum, and Afzelia, would be prevented from extending the whole way to New Zealand, because its station is far south of the tropics. Types such as Edwardsia, Sophora, and certain members of the Galegeæ, Hedysareæ and Phaseoleæ would find ready access to New Zealand, but Podalyriææ, Genisteæ, Viciææ, and some other types, such as Leptospermeæ and Trifolieæ, would be missing. Acacia, Cassia and some other members of Mimoseæ and Cæsalpinieæ, would not reach New Zealand, because of the lack of exposed situations, while Calliandra, Parkia, Copaiba and others would fail to extend so far South.

On the other hand, in Upper Cretaceous and early Tertiary time, when the climate appears to have been much more genial than at the present, it is evident that forms such as Dalbergia, Mimosa, Hæmatoxylon, Calliandra, Castanospermum and Entada, if existent, could have reached New Zealand by such a route.

Edwardsia appears to have entered New Zealand, and there established itself firmly, changing from a warmth-loving type to one flourishing in cold localities. Carmichælia, Corallospartium and Notospartium are endemic; Carmichælia, especially, is firmly established, and is evidently a xerophytic modification of some ancient warmth-loving member of the Galegeæ. Swainsona and Clianthus are indigenous, but appear to own their origin to Australian waifs in the first place, owing to the singular

absence of similar types and the monotypic nature in New Zealand of these genera. *Canavalia* is evidently a common maritime type.

The genera in New Zealand which may have arrived from the north west by a land connection between New Zealand and the tropical continents, are *Edwardsia* and *Carmichaelia*, with the monotypic *Notospartium* and *Coralospartium*. The two tribes represented are *Sophoreæ* and *Galegeæ*. It seems impossible from the evidence available to avoid the conclusion that New Zealand was isolated from the great tropical lands before the differentiation of *Leguminosæ* into *Mimoseæ*, *Cæsalpinieæ*, *Dalbergieæ*, *Trifolieæ* and similar tribes, but not necessarily before the development of *Sophoreæ* and *Galegeæ*.

Another point needing consideration is the possibility of the existence of soil or climate barriers. Thus neither *Castanospermum* nor *Entada* could cross a subarid sandy waste.

The next point to be considered is the factor of marine transportation. Throughout the tropics are many leguminous species, which are either identical within the various countries considered, or are so much alike that they are only separated systematically by their geographical station. In this connection the more striking examples of the African legumes have been cited in an earlier chapter. An analysis of Australian, Asiatic and Brazilian *Leguminosæ* reveals features equally startling in nature.

Guppy has made a long and careful study of the histories of strand plants and sea currents, and an analysis of his observations<sup>1</sup> suggests that these plants are best considered, not as examples of arrested development predating the separation of the great tropical land masses, but as

---

<sup>1</sup> Guppy (35 and 36).

examples of development in one region and transportation thence to other lands by sea currents in recent geological time.

In this connection it will be instructive to quote Guppy's summary of observations on *Afzelia bijuga*, as being typical of the origin of many other types in various countries, such as *Acacia Farnesiana*, *Tephrosia purpurea*, *Entada scandens*, and *Cæsalpinia Bonducella*.

“(1) Assuming that the genus has its home in the African continent, and that the species have frequently a riverside station, it is argued that the distribution of the genus on both sides of that continent can only be explained by its dispersal by rivers from a centre in the interior.

(2) *Afzelia bijuga*, a widely distributed shore tree of tropical Asia, occurs in Fiji, both at the coast and in the inland forests.

(3) This double station is associated *inter alia* with a different buoyant behaviour of the seeds, those of the coast trees floating for long periods, while those from inland generally sink.

(4) There can be no doubt that this widely ranging littoral tree has been dispersed by the currents, but the specific weight of the coast seeds is on the average, but slightly less than sea water; and it is to this fine adjustment, always liable to be disturbed by variations in the environment, that the irregularities in the distribution of the species are to be attributed.”

The slow distribution of certain genera across certain land blocks is also an important point to remember. A famous example is that of the endemic species and genera of West and East Australia, respectively. In each area here considered the species are numerous, nevertheless they are identical only in very rare cases. Certain genera

are even endemic in West Australia, nevertheless the two countries are in direct land connection by way of South Australia and the Northern Territory. The only barrier between the two countries is a sub-arid to arid tract of land south of the fifteenth parallel of south latitude. In this case the common types appear to have originated mainly in the north and later to have worked southwards around each side of the barrier, into West and East Australia. This slow migration of genera or species of plants across regions of barren soil, or of sub-arid to arid climates, must ever be kept in mind in dealing with problems such as that under consideration.

#### **Leguminosæ Indigenous to Various Countries.**

This section has been placed here instead of in the chapter on "Geographical Distribution," because it depends in part, for its understanding on the foregoing chapter.

#### **GENERA OF LEGUMINOSÆ INDIGENOUS IN NEW ZEALAND AND AUSTRALIA.**

New Zealand contains seven genera and twenty-nine species, while Australia contains ninety-seven genera and nearly 1,300 species of legumes.

In any attempt to ascertain how many of these genera and species are really indigenous in the lands under consideration, it would be necessary to exclude shore types, which may be believed reasonably to have been carried thither by means of animals, by sea currents, or by winds. In the case of sea currents, a study of Dr. Guppy's<sup>1</sup> work is invaluable.

The endemic genera such as *Corallospartium*, *Notospartium*, and *Carmichaelia* in New Zealand, and *Brachysema*, *Isotropis*, *Jansonia*, *Chorizema*, *Viminaria*, *Jacksonia*,

---

<sup>1</sup> Naturalist in the Pacific. Plant Dispersal, 1905.



Gastrolobium, Burtonia, Sphærolobium, Gompholobium, Goodia, Oxylobium, Pultenæa, Dillwynia, Eutaxia, Aotus, Phyllota, Daviesia, Mirbelia, Latrobea, Hovea, Templetonia, Bossiæa, Platylobium, Kennedyya, Hardenbergia, Pentadynamis, Lamprolobium, Podopetalum, Castanospermum, Barklya, Petalostyles, and Labichea in Australia, appear to have developed in these countries respectively, and never to have migrated therefrom.

In the second place there are others, such as *Clianthus* and *Swainsona*, which are practically confined to New Zealand and Australia, and these may be considered as strictly indigenous in each of the two countries, inasmuch as the species are endemic in each country considered. *Swainsona*, however, has many close relations in other continents and lands, for example: *Lessertia* in Africa, *Colutea* and *Astragalus* in the Northern Hemisphere, and another genus in the Malay Archipelago. The significance of this will be considered later.

In the third place, genera in Australia, such as *Crotalaria*, *Trigonella*, *Lotus*, *Psoralea*, *Indigofera*, *Tephrosia*, *Millettia*, *Sesbania*, *Desmodium*, *Glycyrrhiza*, *Glycine*, *Erythrina*, *Galactia*, *Vigna*, *Atylosia*, *Flemingia*, *Dalbergia*, *Derris*, *Sophora*, *Mezoneurum*, *Cassia*, *Bauhinia*, *Erythrophloeum*, *Adenantha*, *Neptunia*, *Acacia*, *Albizzia*, *Pithecolobium*, and *Archidendron*, are strictly indigenous, because these types, although common to the tropics and sub-tropics generally, and possessing some species in Australia, which are common to other countries, nevertheless possess endemic species in that country. A few of these genera, however, such as *Vigna*, *Derris*, *Trigonella*, and *Sesbania*, are doubtful. A significant fact is the absence of these genera from New Zealand.

There remain the genera *Edwardsia* and *Canavalia* in New Zealand, and the genera *Ormocarpum*, *Æschynomene*,

Smithia, Zornia, Pycnospora, Uraria, Alysicarpus, Lespedeza, Abrus, Clitoria, Uraria, Canavalia, Dolichos, Dunbaria, Rhynchosia, Eriosema, Pongamia, Cæsalpinia, Cynometra, and Entada, in Australia, all the species of which are either pan-tropical, or are so closely related to species in other continents as to suggest recent derivation thence.

In the previous chapter evidence has been adduced indicating the origin of these genera in Australia as waifs. Canavalia also is a waif in New Zealand, while Edwardsia appears to be a form indigenous to New Zealand, and one which has been carried thence to Chili, Hawaii, and Tahiti,<sup>1</sup> the presence of Edwardsia also in the Isle of Bourbon, and further India, suggests a home for this genus in the Old World tropics.

From what has just been stated it is evident that the number of genera really indigenous in Australia, and yet common to the tropical world, is decidedly limited, while Canavalia is the only pan-tropical genus represented in New Zealand. This gains an added significance from the fact that vast genera such as Inga, Calliandra, Mimosa, Astragalus, and Machærium, belonging to America, Africa, and Asia, as well as important genera such as Hæmatoxylon, Copaiba, Colutea, and Ulex, are absent entirely from these regions, except as colonists. Reference has been made already to this absence of pan-tropical genera from New Zealand in the chapter on "Principles of Geographical Distribution."

GENERA OF LEGUMINOSÆ ENDEMIC OR INDIGENOUS TO REGIONS  
OTHER THAN AUSTRALIA AND NEW ZEALAND.

*South Africa.*—This remarkable region has been adduced as a case analogous to that of Australia with respect to its

---

<sup>1</sup> (35). pp. 147–151.

indigenous genera. An examination of forms such as *Podalaria* and *Cyclopis*, in *Podalyriæ*, *Liparia*, *Priestlya*, *Amphythalea*, *Cælidium*, *Walspersia*, *Borbonia*, *Rafnia*, *Euchlora*, *Pleispora*, *Lotononis*, *Listia*, *Argyrobium*, *Dichilus*, *Melolobium*, *Hypocalyptus*, *Loddegesia*, *Lebeckia*, *Viborgia*, *Buchenrœdera*, and *Aspalathus* in *Genisteæ*, *Sutherlandia*, *Lessertia*, *Sylitra*, *Requienia*, *Hallia*, *Calpurnia*, *Schotia*, and *Burkea*, suggests decidedly that its possible direct land relations with Australia during the development of the endemic types herewith enumerated are to be sought by way of tropical Africa, India, and Malayasia rather than by a direct connection of South Africa with temperate Australia.

The study of New Zealand types, on the other hand, suggests isolation from the tropics before the *Papilionacæ* had been highly differentiated.

*Extratropical South America.*—The endemic types of this large land mass are strikingly few as compared with the very numerous types in both South Africa and Australia, regions which may be compared with it from a consideration of its position among the continents. *Patagonium* is the single noteworthy endemic genus with ninety species. It would appear as though this vast land had been isolated from the tropics during the great differentiation of *Leguminosæ*, and that it had been overrun with later types from the north following upon a recent land connection with the tropical portion of America.<sup>1</sup>

*Eurasia.*—This immense land block appears to have been the home of many important genera, xerophytic or herbaceous in the main. The vast genus *Astragalus*, as also *Adenocarpus*, *Ulex*, *Cytisus*, *Ononis*, *Genista*, *Trigonella*, *Medicago*, *Melilotus*, *Trifolium*, *Anthyllis*, *Dorycnium*,

---

<sup>1</sup> See also (38) and (39) in connection with animal distribution.

Lotus, Spartium, Sarothamnus, Caragana, Oxytropis, Coronilla, Hippocrepis, Hedysarum, Onobrychis, Ebenus, Stylosanthes, Cicer, Vicia, Lathyrus, and Pisum, appear to have developed mainly in open places or in waste lands after the Leguminosæ had been well differentiated.

The abundance of these types in North and South America and their absence from Australia and New Zealand is discussed in the chapter dealing with the differentiation of the Leguminosæ.

#### **Nature and Home of the Ancestral Forms.**

It is probable in the highest degree that the primitive types of the Leguminosæ may never be known except by inference. The important point to remember in this connection is that great changes have gone on progressively in both parallel and divergent directions in the dicotyledons subsequently to the early differentiation of the Leguminosæ. It is not that the various families which possess the greatest morphological affinities with the Leguminosæ have originated the one from the other, but rather that all have sprung from a few types, and have developed side by side into the families as they exist at present.

The evidence, in this connection, is to be sought in a study of both the geographical distribution of the families, the Cretaceous, and Post-Cretaceous geography, as well as the morphology of plants in allied families, and the youthful stages of both leaves and flowers of Leguminosæ.

*Geographical Distribution.*—Within the limits of each family of Leguminosæ the tropics are characterised by the wide diffusion of uniform or similar types.

In extratropical regions these uniform types have developed in different directions in different countries. Within the tropics the uniform types tend to luxuriant habit, while in extra-tropical regions the divergent types are mainly xerophytic.

*Cretaceous and Post-Cretaceous Geography.*—Low-lying lands, large epicontinental seas, and genial climate, marked the Cretaceous, while great continents, small epicontinental seas, high mountains, large deserts, glaciated poles, and a marked division of the climate into zones, are characteristic of the Post-Tertiary Period. The great land blocks of the tropics appear to have been separated from each other near the close of the Cretaceous Period. The early Tertiary climate was also mild and genial, but a marked differentiation of climate was gradually introduced in the later Tertiary. This differentiation has been attended with oscillations of climate, the algebraic sum of the changes tending to loss of heat and moisture.

*Comparative studies.*—Among the families which exhibit the greatest morphological resemblances to the Papilionaceæ, Cæsalpinieæ, and Mimoseæ, are the Connaraceæ, Rosaceæ, Bignoniaceæ, Saxifragaceæ, Crassulaceæ, Passifloraceæ, Rhamnaceæ, and Thymeleaceæ. In these, many of the genera possess indefinite and free stamens; in some again, the stamens are numerous as well as being free and indefinite. In the majority of the genera the corolla is regular and the petals are four or five in number.

Many of the genera, again, possess a great development of pinnate, although many also have digitate, or simple, leaves.

*Embryological.*<sup>1</sup>—The seedling leaves of all Mimoseæ are probably simply pinnate, although the leaves of the adult forms are bipinnate, as in *Acacia*, *Mimosa*, *Cassia*, *Calliandra*, *Adenantha*, *Albizzia*, and *Pithecolobium*.

The Cæsalpinieæ frequently possess pinnate leaves in the seedling stages, but in some genera and species the seedlings possess simple leaves.

---

<sup>1</sup> See Appendix to this report dealing with seedling leaves,

The Papilionaceæ present the most noticeable peculiarities in the order in this connection. Certain species of *Sophora*, *Dalbergia*, *Barklya*, *Crotalaria* and other genera, possess simple leaves in the adult stage; nevertheless the characteristic leaf of the Papilionaceæ is pinnate, trifoliolate, digitate or verticillate. In the seedling stage many genera of this family show simple leaves. Especially is this noticeable in *Podalyriæ*, *Sophoræ*, *Dalbergiæ* and *Genisteæ*. The seedling leaves of the French bean are interesting in this connection as being well known to everyone. The cotyledons themselves are thick and aërial, the first two leaves are simple and opposite, while the succeeding pairs are opposite and pinnately-trifoliolate.

The stamens of Papilionaceæ are also interesting. *Sophoræ*, with its offshoot *Podalyriæ*, has free stamens; but the remaining tribes possess stamens which are either monadelphous or diadelphous. In this connection the following notes by Bentham are of considerable interest: "In the staminal tube of monadelphous Leguminosæ at an early age the stamens are usually all quite free and distinct in a circle round the pistil, and they afterwards become monadelphous not by the union of any portion once free, but by the growth of a ring or tube under them, raising them above the receptacle."<sup>1</sup>

Combining these various lines of evidence it would appear that the home of the Leguminosæ was in the fertile tropics, and that its ancestral forms were trees, shrubs, undershrubs, and climbers of luxuriant habit. Leaves alternate, stipulate, mainly simple, in some cases digitate or trifoliolate, more rarely simply pinnate and possessing more than three leaflets. Corolla regular, the petals overlapping; petals five, rarely four. Stamens free, as many or twice as many as petals, rarely indefinite. Style of one carpel,

---

<sup>1</sup> *Myrtaceæ*, Journ. Linn. Soc., Lond. Botany, Vol. x, 1869, p. 109.

the ventral suture always directed to the dorsal aspect of the flower. Carpel unilocular and bearing ovules in either one or two rows on the ventral suture. Fruit, a pod or drupe. Seeds rarely albuminous.

### **The Differentiation of Leguminosæ.**

The ancestral forms of the legumes were such as to suggest great differentiation of the dicotyledons before the existence of the Order under consideration.

Several interesting inferences are suggested by the analysis supplied in the previous chapter. Thus the geographical distribution of the Leguminosæ indicates a much greater age for the Papilionaceæ than for either Cæsalpinieæ or Mimoseæ, while on the other hand, the corolla of Papilionaceæ is plainly aberrant in type, and of much more recent origin than the corolla of the ancestral form or forms. So also the leaves of Papilionaceæ suggest a much greater age for this family than the leaves of the Cæsalpinieæ and Mimoseæ suggest for these families, nevertheless the stamens of Papilionaceæ stamp it as an aberrant family among the legumes with the exception of Sophoreæ. From every viewpoint the Papilionaceæ appear to be a family much younger than the early forms of the legumes, nevertheless one which by its adaptability has outstripped all its allies in occupying the globe. Cæsalpinieæ and Mimoseæ are less elastic types which represent modifications of the ancestral forms mainly within the limits of the tropics and subtropics. It is perhaps legitimate to consider that the irregular flower of Papilionaceæ arose as an adaptation to fertilisation by insects. In Cæsalpinieæ, again, may be noted a slight amount of irregularity in the flower, nevertheless the æstivation is imbricate and ascending in this family, but descending and imbricate in Papilionaceæ, and the standard is outside in the latter but enclosed in Cæsalpinieæ. The pinnate leaves of Mimoseæ,

even in the most youthful stage, proclaim the relative youth of this family as compared with Cæsalpinieæ and Papilionaceæ, nevertheless it is the only family in which the corolla has been preserved in regular form, in which, moreover, the æstivation of the sepals and petals is valvate, and in which the stamens are almost always free. In all these points the family Mimoseæ conforms to the ancestral types as suggested by a study of the allied orders.

In the present chapter it has been deemed advisable to present brief notes only concerning a few of the tribes of the Leguminosæ, and to supplement these by a fuller description of the genus *Acacia* as illustrating the general trend of leguminous development in both Tertiary and Post-Tertiary time.

#### Family PAPILIONACEÆ.

**SOPHOREÆ.**—Among the Papilionaceæ the tribe of the Sophoreæ may be considered as a descendant of luxuriant tropical forms. The members of this tribe appear to have been established firmly in the old world prior to the separation of Australia from Asia and Africa. No necessity appears to exist for removing Podalyrieæ from Sophoreæ, inasmuch as in each case the stamens are free, and the former are generally woody undershrubs varying in their morphology in various countries, while the latter are often shrubs and trees. Thus the Sophoreæ, as a whole, remained in the fertile tropics and populated those lands only which possessed abundance of warmth and shelter. The tribe is old and decadent, as is suggested by the fact that it is widely-spread as very small genera over the tropical world, with stunted outliers in the temperate regions. It contains thirty-four genera but only one hundred and fifty-five species. Of these *Sophora* contains twenty-five, *Ormosia* twenty, and *Baphia* twelve species, the first two mentioned occurring throughout the warmer and fertile parts of the



earth. *Virgilia* and *Cladastris* are examples among others of *Sophoreæ* which have become acclimatised to harsh extratropical conditions.

*Sophora* itself has demonstrated its adaptability to environment by penetrating extratropical North America, Asia, and South Africa. A modification of the genus, as *Edwardsia*, appears in Bourbon Isle, New Zealand, Easter Island, Hawaii and Chili. In its early stages *Sophora* could travel only under conditions of warmth, shelter and moisture. Under the changed climate of the later Tertiary, the genus adapted itself, in part, to colder and less hospitable surroundings generally, and thus penetrated the temperate regions. In a slightly different form known as *Edwardsia* it reached New Zealand either by land connection or by marine currents.<sup>1</sup> Marine currents doubtless carried this *Edwardsia* to Chili from New Zealand and from Chili to Hawaii.

But both after the isolation of Australia from Asia and Africa and the great differentiation of climate in Post-Cretaceous time, as well as the draining of the Cretaceous epicontinental seas, great masses of sandy waste lands were produced, regions exhibiting great diurnal and annual variations in temperature. Prominent among these were the sandy regions of Australia and South Africa, as also the steppes and bleak open lands of Europe and Asia. Regions such as these, where the conditions of climate are severe, appeared to act as a spur to floral activity in the production of xerophytic types, provided that the rainfall did not fall below ten inches a year. The *Sophoreæ* made a grand response to these altered conditions, especially in Australia, where the development appears to have been rapid, but the handsome tree, or shrub, of the tropical regions has been reduced there either to undershrubs or

---

<sup>1</sup> Guppy (35).

smallshrubs. Both in Australia and South Africa the legumes were isolated from the aggressive Northern Hemisphere forms, and the Podalyrieæ were developed. In Australia they are represented by twenty genera and four hundred species, in South Africa by two genera and thirty species. The genus *Pultenæa*, in Australia, with about one hundred species, is a magnificent example of adaptation to environment. Closely allied to it are *Eutaxia*, *Latrobea*, *Phyllota*, *Dillwynia*, and *Aotus*. To accommodate themselves to their inhospitable surroundings these southern Podalyrieæ reduced their leaf-surfaces, wherever possible, either to trifoliolate, or simple leaves, or they dispensed with them altogether. Such leaves as were retained became modified so as to be protected against excessive transpiration. Involute, or revolute, terete, pungent, glossy, or thick, leaves are common. A process of general reduction in size was adopted also by the plant for the same reason.

As time progressed several of the Australian Podalyrieæ, such as *Pultenæa* and *Bossiaea* adapted themselves to cold conditions, and a few species established themselves even on the high plateaus of Eastern Australia and Tasmania.

The Podalyrieæ of South Africa and Australia belong to different subtribes, and they suggest common ancestors in tropical Africa and Asia, from which migrations were made south to lands not connected directly with each other, thus enabling them to develop in different directions.

The northern Podalyrieæ are peculiar, and appear to be decadent types. All are possessed of three leaflets, and they otherwise exhibit closer resemblances to the Sophoreæ than to the Podalyrieæ of the Southern Hemisphere, the general connection between all, however, lying in the free stamens.

The northern forms are all small plants, and they appear to have developed in Eurasia, and to have spread thence

east and west. *Anagyris* and *Piptanthus* are endemic in Eurasia. *Thermopsis* probably developed in Asia and spread through the Himalaya, China, Japan, Siberia, and to colder North America. This is a hardy type which possesses a dozen species, one of which grows at a height of 17,000 feet in the Himalaya. *Baptisia* and *Pickeringia* appear to be endemic in North America, probably as a modification of some form of *Sophoreæ*, which has disappeared.

No *Podalyrieæ* has been recorded from South America. The members of this tribe in Australia are more specialised than the genera of the tribe in other countries, and have succeeded admirably as xerophytes. Strange thus as it may seem, the *Podalyrieæ*, with its peculiar forms, its numerous genera and species, appears to be a group of the *Leguminosæ* which is relatively young, inasmuch as it has no tropical representative closer than the *Sophoreæ*; it has a great development in Australia but a very slight development outside that region, not even extending to South America; and, furthermore, its variability in different regions proclaims it in each case to be a local product of more recent origin than the widely-diffused tropical genera.

**GENISTEÆ.**—The centre of dispersion for this tribe was the tropics, as in the case of the *Sophoreæ*, and, as with the *Podalyrieæ*, the extratropical development was mainly in the Old World and in Australia. Tropical forms became adapted to the inhospitable environments of the lands mentioned in connection with *Podalyrieæ*, and there developed characters well adapted for protection. In Australia a response was made by certain tropical *Genisteæ* to the gigantic expanse of sand and harsh climate, which at the same time fostered species and genera so numerous and vigorous as those of the *Podalyrieæ*. Both the Australian and South African *Genisteæ* of the temperate regions

form endemic sub-tribes, and their mutual relations are to be sought in the tropics rather than in some sunken cistropical land block, which may be supposed to have connected the two countries directly during a previous period.

The Genisteeæ of the northern hemisphere present an appearance quite different from those of South Africa and their stamens differ considerably from the Australian types. Thus in the northern hemisphere the stamens are either monadelphous or diadelphous, whereas in Australia the sheath is generally open along the upper side.

The gorse, broom, and allied forms, of the north are xerophytes and often leafless. As with allied types which adopt devices to reduce transpiration, they are aggressive colonists in waste places in temperate regions.

After the great shrinkage of the vast Mediterranean Sea of the Cretaceous, Eocene, and Miocene periods, the main Eurasian types appear to have invaded Northern Africa. Genisteeæ also appears to have reached North America by the same route as Thermopsis, either during the late Tertiary or the Glacial Period. Among others, *Lupinus* passed southwards to Bolivia along the high plateaus extending from British Columbia.

*Adenocarpus*, *Ulex*, and *Cytisus*, may be either of younger age or of less vigorous nature than *Lupinus*.

*Anarthophyllum* and *Sellocharis* represent modifications of tropical Genisteeæ to meet the South American conditions.

In brief, the development of the temperate forms of Genisteeæ suggests a development parallel to that of Podalyrieæ, each being due to a change of climate of world-wide application whereby the widely-diffused and uniform original forms of the tropics became modified in extra-tropical regions to secondary types, each unconnected land block showing development along different lines, the rela-

tions of each group belonging to any temperate geographical station being found in the tropical types.

Neither Genisteeæ nor Podalyrieæ has entered New Zealand, and this may be explained partly by the fact that the primary tropical forms, such as *Crotalaria*, would not have found a congenial environment in the narrow land connection as postulated by Hedley (38) connecting New Zealand, and Fiji, or New Caledonia, and partly, because the temperate forms have been evolved in Australia and elsewhere later than the separation of Australia and New Zealand from some common land mass.

TRIFOLIEÆ and LOTEÆ.—These are important tribes which appear to be of similar age to the Podalyrieæ and the xerophytic Genisteeæ. Their home probably is to be sought in the temperate regions of the Northern Hemisphere, especially Eurasia. America was invaded from Asia.

GALEGEÆ.—A very old tribe, the members of which have had a remarkable history. Originally they appear to have possessed simple leaves in the main, but in common with other tribes, they branched from the ancestral forms subsequently to the development of pinnate leaves. In the tropics they were non-twining herbs, shrubs, woody climbers, or even trees. The evidence suggests that the tribe was well established during the tropical connection of America, Asia, Africa, and Australia, as also possibly New Zealand. Thus large genera such as *Indigofera*, *Psoralea*, *Tephrosia*, and *Sesbania*, are all divisible into several or more sections, and the majority of these sections even are widely diffused throughout the tropics. Great powers of adaptation to environment are exhibited even by these tropical genera, inasmuch as they are of uniform primary type in the tropics but are of variable secondary type in the temperate regions, the variations moving along similar lines in each distinct temperate region but in divergent directions in different temperate regions.

Like the *Genisteæ*, many endemic and vigorous genera of *Galegeæ* occur in extra-tropical regions, and such may be referred to later differentiation, being analogous to the *Podalyrieæ* and xerophytic *Genisteæ*. *Amorpha*, *Dalea*, *Kuhnistera*, and *Brogniartia* are American types some of which appear to have reached South America by migration along the high western plateaus.

An interesting and instructive history is that of the group comprising *Lessertia*, *Swainsona*, *Colutea*, *Astragalus*, *Caragana*, *Oxytropis*, *Clianthus*, *Streblorhiza*, *Carmichælia*, *Notospartium*, and *Corallospartium*.

All or most of these appear to have had a community of descent at a date later than the development of forms such as *Indigofera*, *Sesbania*, and *Tephrosia*, but nevertheless at a time while Australia was yet joined to Asia and Africa by way of the tropics. New Zealand may have been connected by land to the tropics, this is inferred from an analysis of the genera under consideration. The tropical ancestor, or ancestors, has, or have, disappeared, unless it be the form in Asia supposed to be *Swainsona*. One branch, however, of the tropical form became the *Lessertias* in Africa, one the *Coluteas* in the Northern Hemisphere, and one the *Swainsonas* in Australia and New Zealand. *Astragalus*, and *Caragana*, in the Northern Hemisphere, and *Carmichælia*, *Corallospartium*, and *Notospartium*, in New Zealand, are closely allied forms, as are also *Clianthus* in Australia and New Zealand and *Streblorhiza* in Lord Howe Island.

*Colutea*, *Lessertia*, and *Swainsona* are strikingly alike, and they are examples of types which have flourished apart, but have not changed perceptibly for ages. *Astragalus*, according to Bunge,<sup>1</sup> is a vast genus of about 1,200 species. Like the *Genisteæ*, it has spread from the Mediterranean

---

<sup>1</sup> Quoted from Taubert, (60).

and the Eurasian steppes to North America, and thence along the Andes to Chili. It does not occur in Australia, probably because of its origin in the extra-tropical regions of Eurasia, and its inability to reach Australia across the tropics by reason of the absence of plateaus. Like the phyllodineous Acacias of Australia, it is a grand example of a type which has become aggressive after its adaptation from a tropical form to an inhospitable environment.

*Carmichælia* is one of the few endemic genera of Leguminosæ in New Zealand. It is a modification of a form allied to *Sesbania*, which reached New Zealand either by a tropical land route, or as a sea waif. Originally it was probably a luxuriant type, but the subarid land formed by the uplift of the New Zealand Alps in late geographical time offered a fine field to potential xerophytes and the leafless *Notospartium* and *Corallospartium*, as also the practically leafless *Carmichælia*, appear thus to have originated.

According to Cheeseman (25) *Carmichælia* has twenty-one, *Corallospartium* one, and *Notospartium* two species. Had New Zealand been as large as Australia, with a similar climate and soil, it is probable that *Carmichælia* would have become a vast genus, comparable in size with the phyllodineous Acacias.

*Swainsona* and *Clianthus* have their home in Australia, but possess one endemic species each in New Zealand. *Streblohriza*, an allied genus, is found in Lord Howe Island. *Clianthus* appears to be a genus which commenced in the tropics and thence passed southwards. It is a decadent type which possesses only two species, one of these being a desert form in Australia.

Five, therefore, of the seven indigenous genera of Leguminosæ in New Zealand belong to the Galegeæ; another, namely, *Canavalia*, is a marine waif; and the seventh,

namely, *Edwardsia*, belongs to the old tribe *Sophoreæ*. One explanation of the presence of *Edwardsia*, *Carmichaelia* and its leafless allies, is that these forms entered New Zealand by a tropical land connection during a period when only the oldest tribes of the *Papilionaceæ* had been differentiated, although it is doubtful whether they may not have descended from ocean waifs, much in the same way as *Edwardsia* appears to have spread to Chili and Hawaii,<sup>1</sup> and as *Afzelia* has been carried to Fiji and other places. *Clanthus* and *Swainsona* are best explained as descendants of waifs from Australia, otherwise it is difficult to account for the absence of *Tephrosia*, *Indigofera*, and allied forms, from New Zealand. In a word, New Zealand appears to have been isolated from warmer Australia and the tropics before the *Papilionaceæ* had been highly differentiated.

**HEDYSAREÆ.**—These are *Papilionaceæ* whose pods separate into nondehiscent portions containing one seed apiece. The group might be distributed satisfactorily among the *Galegeæ*, *Phaseoleæ*, and other tribes. Some of the large tropical genera, such as *Æschynomene* and *Desmodium*, as also certain temperate-climate forms such as *Coronilla*, *Hippocrepis*, *Hedysarum*, *Onobrychis*, and *Ebenus*, appear to postdate the separation of tropical America, Africa, and Asia, from Australia. *Patagonium*, with ninety species in South America, is endemic there and apparently of recent vigorous origin.

The great number of small genera in the tropics suggests the decadent nature of many genera in *Galegeæ*.

**VICIEÆ.**—This is an important tribe which has tropical representatives, such as *Vouacapoua*, but whose main types are vigorous and aggressive specialised forms such as *Cicer*, *Vicia*, and *Lathyrus*, which appear to have been cradled in

---

<sup>1</sup> Guppy (35)



the old world about the time that the xerophytic Genisteæ and Podalyrieæ were being developed.

**PHASEOLEÆ.**—This in the main, is an old and tropical tribe which has not adapted itself readily to temperate climes and inhospitable surroundings. Genera such as *Rhynchosia*, *Eriosema*, *Phaseolus*, and *Erythrina*, exist in all tropical regions. None occur in New Zealand. Peculiar endemic genera of Phaseoleæ in Australia include *Hardenbergia* and *Kennedyia*.

**DALBERGIÆ.**—A tribe almost completely tropical, most of whose members are of luxuriant types, which is represented in Australia by an endemic species of *Dalbergia*. None occur in New Zealand. Several stragglers occur in South Africa. It is specially abundant in the American tropics.

It appears to be a tribe with specialised stamens and fruits which originated during a period considerably post-dating the development of the *Sophoræ*, the *Genisteæ*, and *Galegeæ*.

#### Families CAESALPINIÆ and MIMOSÆ.

*Cassia* and *Acacia* are types respectively of *Caesalpinieæ* and *Mimoseæ*. They are analogous to genera such as *Indigofera*, *Crotalaria*, *Pithecolobium*,<sup>1</sup> *Tephrosia*, and *Rhynchosia* in *Leguminosæ*, as also to *Myrtus* in *Myrtaceæ* in that the uniform, and less specialised types are widely diffused throughout the tropics, while the specialised or secondary types have been developed locally along variable lines in different regions outside the tropics. These specialised forms of divergent nature in contrasted regions are mainly xerophytic. It is proposed to mention a few of the characteristic features of *Acacia* as being typical of the development of the two families under consideration.

<sup>1</sup> The leaves of *Acacia* and *Pithecolobium*, however, suggest a more recent differentiation than forms such as *Crotalaria* and *Rhynchosia*.

Acacia is divided into six sections by Bentham. Of these, the Gummiferæ represents the uniform primary type diffused widely throughout the tropical world. Vulgares contains more species than Gummiferæ and occurs in America, Asia, and Africa, but not in Australia. Filicinæ occurs only in tropical America, and contains but several species. Botryocephalæ and Pulchellæ are both endemic in Australia, as also Phyllodineæ, the latter with rare outposts in the neighbouring islands. Of the seven hundred species recorded for the genus, Phyllodineæ contains over four hundred. Botryocephalæ and Pulchellæ are small sections, but Gummiferæ and Vulgares are both large. The former predominates in the old and the latter in the new world.

Gummiferæ possesses persistent spinescent stipules and the leaves are bipinnate. The section has been split again into three series by Bentham, namely, into Summibracteataæ, Medibracteataæ, and Basibracteataæ.

The first of these series possesses exterior bracts in an annular connate ring and the flowers are in globose heads. The types may be cosmopolitan as *A. Farnesiana*, others are endemic in America, Africa, or Asia.

The second possesses connate bracts in a ring round the involucre, toothed, and rarely absent. Flowers in globose heads, rarely ovoid. These occur throughout the tropical and subtropical world. *A. suberosa*, *A. Bidwilli*, and *A. pallida* are types endemic in Australia.

The third series has peduncles with small stipitate basal bracts. The flowers are in spikes which may be cylindrical or elongate, rarely globose. The species occur in America, Africa, and Asia, but have not been recorded from Australia.

The Vulgares are trees or shrubs with non-spinescent stipules. Prickles scattered to rare, or even absent.

Axillary peduncles and branching panicles. Leaves bipinnate. Flowers in spikes or heads.

This very numerous and important section is divided into the old world *Spicifloræ*, which is a large series, the American *Spicifloræ*, which is very large, the American *Capitulatæ*, which is very large, and the old world *Capitulatæ*, which is a small series.

The *Botryocephalæ* contain upwards of a dozen species, and are endemic in Eastern Australia. The leaves are bipinnate, the stipules small or absent, and the flowerheads globular, in axillary racemes or terminal clusters.

The *Pulchellæ* are endemic in Western Australia. The leaves are bipinnate, the stipules none or small, setaceous, not spinescent. Flowers globular or cylindrical, or simple, axillary, solitary, or in clustered peduncles.

*Phyllodineæ*. This series possesses leaves all or mostly reduced to flat, terete, or subulate, phyllodia, or minute scales, without leaflets. The species are endemic in Australia with the exception of a few types in the neighbouring islands, almost identical with certain north-eastern forms, and are divided into three well-defined types—firstly, those whose phyllodes possess one main nerve, the flower-heads being globose; secondly, those whose phyllodes possess several, or more, parallel nerves, the flowers being in globular heads; and thirdly, those whose phyllodes possess several, or more, parallel nerves, and whose flowers are in spikes.

Acacia is most abundant in Australia and America, less abundant in Africa, still less so in Asia, a very few in New Guinea, Fiji, and New Caledonia, and absent from New Zealand. The observations of Lubbock,<sup>1</sup> Strasburger,<sup>2</sup> Mueller,<sup>3</sup> Cambage,<sup>4</sup> and the writer, indicate a foliage

---

<sup>1</sup> (46). <sup>2</sup> (57), <sup>3</sup> (50). <sup>4</sup> (22).

simply pinnate, without numerous leaflets, as the immediate ancestor of the genus, and one which gradually developed into the complex bipinnate form, On the one hand the genus is closely related to the tribe Eumimoseæ, and on the other hand to the tribe Ingeæ. The ancestral forms may be conceived as trees or shrubs of luxuriant type, flourishing in moist warm climates, and possessing leaves simply pinnate, persistent stipular spines, flowers in heads or spikes, corolla regular, and stamens definite and free. During the mild and genial climate of the later Cretaceous this type was transformed gradually in one direction to plants with indefinite monadelphous stamens and bipinnate leaves, namely, Ingeæ, in another direction to plants with definite free stamens and bipinnate leaves, namely, Eumimoseæ, and in a third direction to plants with indefinite free stamens and bipinnate leaves, namely, Acacieæ. The principal genera in these tribes are Pithecolobium, Mimosa, and Acacia, respectively.

In Acacia, the section Gummiferæ is the type most uniform and most widely diffused, and from this fact, and the knowledge also that it is the form which exhibits the closest homology to the cognate genera, it is here considered as the most primitive form of Acacia in existence.

It may be noted that the members of the Gummiferæ are lovers of open land and are xerophytes, even in the tropics. This feature obtains in America, Africa, Asia, and Australia alike, and indicates that the Acacia had developed a xerophytic habit prior to the separation of the main tropical land masses from each other. If this period be considered as the late Cretaceous, it may be perceived that xerophytes among the dicotyledons had been established already in that period, either as a result of adaptation to the poor, sandy soil, or to a transient differentiation of climate, in the closing stages of the Cretaceous, or perchance to a combination of these influences.

Upon the separation of Australia from Asia and Africa, and the strong differentiation of climate either in Post-Cretaceous or Post-Eocene time, a marked change ensued in the morphology of the genus *Acacia*. Within the Americano-African tropics the *Vulgares* developed along parallel lines with the genera *Mimosa*, *Calliandra*, and *Inga*. None of these, however, reached Australia. In *Vulgares* the spinescent stipules of the primitive *Acacia* were suppressed in favour of the development of scattered prickles, while in this section, as also in *Gummiferæ*, a response was made to harsh climatic and soil environment by the reduction of the leaflet surfaces, as well as by other means, such as the secretion of gums. In this manner the genus was enabled to occupy the sub-arid and poor lands, both within and south of the shrunken megathermic area in Post-Cretaceous and Post-Eocene time.

It was in Australia, however, that the most successful adaptations to inhospitable surroundings were secured by the genus. The great morphological modifications which produced *Eucalyptus* and the phyllodineous *Acacias* appear to have been contemporaneous, and due to the same cause; the one being a local alteration of a uniform primary type without the development of a new genus, the other a modification so profound as to have given rise to a peculiar genus, famous throughout the world for its vitality and its economic value. In each case a vigorous and aggressive type was formed, the association of the two giving a distinct facies to the Australian forest proper, as well as to the scrub lands, but not to the jungle or brush growths, however, these being formed of types older, in the main, than either *Eucalyptus* or the endemic species of *Acacia*.

In Australia the *Gummiferæ* do not appear to have established themselves very securely, inasmuch as they appear there to be decadent. A great response was made,

however, to the inhospitality of the extensive wastes of sandy soil, and sub-arid climate, by the suppression of the bipinnate leaf in the adult stage and the adoption instead of the phyllode. The phyllodineous Acacias thus developed may be divided into two series, namely, those whose phyllodes possess one strong central nerve with reticulating venation, and those whose phyllodes possess two, or more, parallel nerves. To these Bentham gave the names Uninerves and Pleurinerves respectively. Both series possess flowers in globular heads. To those Acacias with pleuri-nerved phyllodes and flowers in cylindrical spikes, the same botanist gave the name Julifloræ. The geographical distribution suggests that Uninerves, Pleurinerves, and Julifloræ, alike, originated in North Australia and that the occupation of the temperate portions of Australia, and Tasmania, by these types took place at a later date. The Uninerves are most numerous in temperate, while the Pleurinerves and Julifloræ, especially the latter, are densest in tropical Australia. It is possible that the Uninerves and Pleurinerves originated independently of each other, the former favouring the southern, the latter the warmer portions of the continent, because the abolition of leaves, and the development of either phyllodes, cladodes or spines, is not uncommon in other Leguminosæ, such as *Cassia phyllodinea*, *C. circinata*, *Notospartium*, *Corallospartium*, *Carmichælia*, *Bossiæa*, *Daviesia*, *Jacksonia*, and *Viminaria*. With the idea of ascertaining the possible priority of either the Uninerves or the Pleurinerves, Mr. R. H. Cambage has grown several forms of Acacia. The results were inconclusive, nevertheless enough information was secured to indicate that the earlier phyllodes of these types were narrow, consisting of a slight flattening of the petiole and the development later, at least in *A. melanoxydon*, of lamina with the production of nerves slightly concave to the main nerve, being confluent also with the latter at each end of

the phyllode. With the object among other things, of settling this important point, namely, the priority of Uninerves or Pleurinerves, Mr. Cambage is preparing a paper descriptive of many species of *Acacia*, in the seedling stage.

In Eastern Australia, the phyllodineous *Acacias* usually occupy the sandy soils, especially in the moist and cool portions of the continent, while certain small subseries of the Pleurinerves and the Julifloræ, such as the Microneuræ in the Pleurinerves prefer the drier clay soils, as also the warmer, moist portions, on the outskirts of the jungle or "brush." Central Australia has formed a barrier to the migration of the majority of the types which grow in either West or East Australia, and the ancestral forms appear to have found paths down each side of the continent, developing many new forms in the South,

In the desert itself, and on much of the sandy barren soil, the phyllodes, in many instances, have been changed to needles, thorns, or to leathery or pungent forms, or to armed wing-like processes. These extreme types appear, in some cases, to be recent modifications of either Uninerves or Pleurinerves; in other examples, as in *A. juniperina*, they may be older than the desert.

The probable development of the subseries Racemosæ, Microneuræ, Nervosæ, Tetrameræ, and Falcatæ, may be considered here in brief as indicating the various lines along which modification proceeded in the Phyllodineæ.

Racemosæ.—These are Uninerves which, with few exceptions, grow in sandy soils. The phyllodia are generally broad, rarely pungent, and they possess veinlets, either reticulate, or diverging from the midrib. The flowers are in globular heads arranged in axillary racemes.

A few species are recorded from West Australia, but the majority occur in the south-eastern portion of the con-

continent, especially in the moist cool portions. A few outliers occur in the sub-arid areas of Eastern Australia.

During the gradual elevation of Eastern Australia in Tertiary time this hardy group of moisture-loving Acacias appears to have been developed in the south-eastern portion of the continent, which at this period extended both to Tasmania and beyond it to the south. The phyllodes were fairly broad, except in the cases of types such as *A. linifolia* and *A. suaveolens*, whose development took place in barren sandy soils.

With the formation of the plateaus of Eastern Australia at the close of the Tertiary, and at a period still later, namely, the Glacial Period, these types underwent great modifications and many of them journeyed north beyond Sydney and Brisbane. Among the younger types may be mentioned those species possessing large luxuriant phyllodes such as *A. falcata* and *A. penninervis*. Some, such as *A. decora*, adapted themselves to the sub-arid and stony wastes of the inland areas, while forms such as *A. salicina* and *A. myrtifolia* appear to have crept across to Western Australia, by way of sandy areas in the moister portions of Southern Australia. A variety of *A. salicina*, known as the Cooba, flourishes in the deep alluvium along the watercourses and appears to be a remarkable adaptation of a type which has evidently sprung from a species flourishing in barren sandy soil, and it is exceedingly interesting in this connection to know that a dwarfed and straggling form identified as *A. salicina* by Mr. J. H. Maiden, flourishes on the bare sandy ridges of the Cobar district. It is possible that this type is the ancestor of that which follows the watercourses. It may be interesting in this connection to note that *Eucalyptus rostrata* creeps along the watercourses, while a form, with similar fruits, but of dwarfed and straggling habit, *E. Bancrofti*, flourishes on the poor sandy soils.



Other Racemosæ again, such as *A. rubida*, *A. Ruppil*, J. H. Maiden, and *A. neriifolia*, appear to have revived the old bipinnate foliage in great measure, both retaining this form of leaf, in extreme cases, until the plant attains a height of ten feet. Cambage<sup>1</sup> records *A. rubida* fruiting during the bipinnate stage.

Microneuræ.—This subseries belongs to the Pleurinerves, with flowers in globular heads. Bentham records three of the species from West Australia, but the pods of two are unknown, and the pod of the third, *A. coriacea*, is not suggestive of the Eastern Australian types.

On the other hand it would be advisable perhaps to include *A. harpophylla* and *A. Cambagei* in this group, although Bentham places *A. harpophylla* in another group. *A. Cambagei* was unknown to the great systematist.

These, as well as many other allied forms, appear to have been developed on the inland plains formed by the waste brought down from the eastern highlands, and upon which the Racemosæ were being simultaneously developed. The soil chosen by the Microneuræ was a dense alluvium, generally reddish or blackish-grey in colour, especially in the cases of *A. pendula* (Myall or Boree), *A. homalophylla* (Yarran), and *A. harpophylla* (Brigalow). The nerves in the phyllodia are much obscured in most of the types because of the thickening of the phyllodes for the storing of moisture. A parallel among the Eucalypts is shown in the development of the "Boxes" on the alluvium, of which *Eucalyptus microtheca*, *E. bicolor*, *E. populifolia*, and *E. Woollsiana* are types. In each of these two vast genera a marvellous and contemporaneous response has been made to every peculiar form of Australian environment. Moreover, a study of these two contrasted types, growing side by side, furnishes a mute but eloquent testimony of the

---

<sup>1</sup> (22).

divergent paths followed by various organisms in their attempts to defend themselves against the same inorganic forces to which they are opposed.

*Nervosæ*.—*A. melanoxyton* and *A. implexa*, in the *Nervosæ*, are Pleurinerves with globular heads and phyllodes with strongly-marked and parallel nerves. Their history has been somewhat parallel to that of the *Racemosæ*, with the exception that the soil chosen was richer than the barren and sandy soil chosen by the *Racemosæ*. A wet and cool to cold climate was also chosen. *A. melanoxyton*, the Tasmanian blackwood, commonly grows into a large and handsome forest tree. In the youthful stage, up to a height of ten feet in certain cases, it possesses bipinnate foliage; and, as with the *Racemosæ*, both it and *A. implexa* probably migrated northwards along the late Tertiary highlands during the Glacial Period. Mr. R. H. Cambage, in a paper read before the Linnean Society of New South Wales in 1901, (see page 202 of the Proceedings for 1901) mentions the occurrence of outliers of *A. implexa* on hills in subarid New South Wales. These, in his opinion, suggest a contraction of habitat for this species, owing to climatic change. In this opinion I concur.

*Tetrameræ*.—These are Pleurinerves with flowers in cylindrical spikes. The corolla has four petals. Bentham includes *A. cochliocarpa* in *Tetrameræ*, evidently because of the tetramerous flowers; but the pod is distinctly unlike that of the other members, and the geographical station is against its inclusion in this sub-series. It would be advisable to exclude it from this group, which developed in the extreme south-eastern portion of Australia, and in common with *A. melanoxyton*, *A. implexa*, and other types, appears to have spread to South Queensland during the cosmopolitan Glacial Period of the Pleistocene. A local differentiation occurred in the Southern Alps, and this gave rise to forms

such as *A. alpina*, *A. phlebophylla*, and *A. Dallachiana*. The first-mentioned type is sub-alpine and xerophytic.

Falcatae.—These are Pleurinerves possessing slender spikes, with phyllodia usually large and long, more or less falcate and with numerous parallel nerves. Forms such as *A. Maideni* and *A. Cunninghamii* are included.

The group appears to be fairly recent, and one which originated in the moister portions of Northern and North-eastern Australia. The phyllodia are often thin, there being but little necessity for the storage of moisture. Many of the species become large and handsome trees. *A. doratoxylon* (Spearwood) is one of the types which has become xerophytic, working towards the sub-arid inland regions. *A. acuminata* may be a form of *A. doratoxylon* which has migrated across the desert. *A. stereophylla* and *A. signata* of Bentham were classified on imperfect material, and may have been wrongly placed by reason of their geographical station.

A study of Acacia and Eucalyptus indicates that in numerous instances a vigorous xerophyte may, under certain conditions, tend to develop species which are of luxuriant habit. Such an impelling condition was the development of the plateaus and sheltered gorges of Eastern Australia during late and Post-Tertiary time, whereby luxuriant forms of Eucalyptus such as *E. saligna*, *E. amygdalina*, and *E. regnans*, as also of Acacia such as *A. melanoxylon*, *A. Bakeri*, and *A. penninervis*, were developed. Another interesting point is that certain types of Eucalyptus and phyllodineous Acacias under such circumstances tended to revert to the ancestral forms.

A few of the phyllodineous Acacias appear to have reached New Caledonia, the New Hebrides, and Fiji. It is reasonable to explain this migration by marine transportation, owing to the absence of other genera, such as Eucalyptus, from these islands.

Contemporaneously with the development of the Phyllo-dineæ, the primitive type Gummiferæ was being modified in another direction to produce the important endemic sections, Botryocephalæ and Pulchellæ, of Bentham. The former is confined to eastern, the latter to western Australia. Pulchellæ and Botryocephalæ appear to be modifications of Gummiferæ in West and East Australia respectively, after the isolation of Australia from Asia and Africa, and during the development of the vast section Phyllo-dineæ.

In each section the persistent spinescent stipules of the Gummiferæ have been suppressed.

Many beautiful Acacias are included in Botryocephalæ, notably, *A. dealbata*, *A. decurrens*, *A. polybotrya*, *A. Baileyana*, *A. elata*, and *A. spectabilis*. The development of these types appears to have taken place in moist and cool south-eastern Australia, during the formation of the high plateaus, and the dissection of the same by stream action, in late geological time, while their distribution to the south of Queensland was due to the same activities which caused the northward journeyings of Tetrameræ, Racemosæ, and other sub-series. *A. elata* is suggestive of a later local development in the Blue Mountain District. *A. leptoclada*, *A. polybotrya*, *A. spectabilis*, and *A. cardiophylla*, are later developments in the northern districts, which have become adapted in part to the drier inland conditions. *A. discolor* is an adaptation to poor sandy soil, and is a very hardy type. *A. decurrens* is a hardy form, which, although one of the older Botryocephalæ like *A. discolor*, has been enabled to accommodate itself to sub-arid western conditions in Eastern Australia, as well as to the cooler and moister climate of Eastern Australia, either as the result of migrating west or by refusing to be driven out on the approach of sub-arid conditions in the

west. The presence of forms such as *A. decurrens* along dry watercourses within the Great Cobar Plain suggests that the climate of the interior has become drier in recent times. *A. Baileyana* is indigenous only<sup>1</sup> in the Cootamundra-Temora district, and both to Mr. R. H. Cambage and the writer, its appearance suggests a new type, probably allied to *A. decurrens*, on account of the peculiarity exhibited at times in the seedlings.

### Appendix.

The subjoined notes on the earliest leaves of seedling Leguminosæ are based, mainly, upon the work of Lubbock (46). So far as observations have been made upon seedlings of this Order the accompanying notes indicate the principal types of the earliest leaves belonging to the various tribes enumerated:—

**PAPILIONACEÆ.**—Adult leaves plurijugate, or trifoliolate, sometimes simple.

Sophoreæ.—Simple or pinnate, opposite or alternate.

Genistææ.—Simple or trifoliolate, opposite or alternate.

Trifolieæ.—Simple.

Galegeæ.—Simple or pinnately-trifoliolate, opposite or alternate.

Hedysareæ.—Simple or pinnate.

Phaseoleæ.—Simple and opposite.

Dalbergiææ.—Simple or pinnate, opposite.

**CÆSALPINIÆÆ.**—Adult leaves bipinnate or pinnate, rarely tripinnate or simple.

Eucæsalpinieæ.—Abruptly pinnate.

Cassiææ.—Abruptly pinnate.

Bauhinieæ.—Abruptly pinnate or simple.

Amherstieæ.—Abruptly pinnate and opposite.

Cynametrææ.—Abruptly pinnate.

---

<sup>1</sup> Cambage, R. H., Proc. Linn. Soc. N. S. Wales, 1902, p. 198,

MIMOSEÆ.—Adult leaves bipinnate, rarely tripinnate or pinnate.

Adenanthæræ.—Abruptly pinnate.

Eumimoseæ.—Abruptly pinnate.

Acaciææ.—Abruptly pinnate (*Acacia Burkittii*, recorded by Lubbock as bipinnate).

Ingeæ.—Abruptly pinnate.

### Bibliography.

1. Aclogue (A.)—Flore de France, 1894.
2. Andrews (E. C.)—Development of the Natural Order Myrtaceæ. Proc. Linn. Soc. N.S.W., 1913.
3. „ Geographical Unity of Eastern Australia in Late and Post-Tertiary time, with Applications to Biological Problems (see references therein). Journ. Roy. Soc. N.S.W. 1910, XLIV, pp. 420 - 479.
4. Arcangeli (Giovanni).—Flora Italiana, II Ed., 1894.
5. Bailey (F. Manson)—Queensland Flora. By Authority, Pt. II, 1900.
6. Bentham (G.)—Flora Australiensis, II, 1862.
7. „ Flora Braziliensis de Martius, xv, 1859-1876.
8. „ Mimoseæ. Trans. Linn. Soc. Lond., xxx, 1875.
9. „ Revision of the Genus Cassia. Trans. Linn. Soc., London, xxvii. 1869.
10. „ Dalbergiæ. Journ. Linn. Soc. Lond., iv.
11. „ Notes on Myrtaceæ. Journ. Linn. Soc., Lond., x, 1869.
12. „ Monograph on the Compositæ. Journ. Linn. Soc., Lond., xiii, 1873, pp. 335 - 577, pp. 101 - 166.
13. „ Presidential Address. Linn. Soc., London, 1870.
14. Bentham (G.) and (Hooker (Sir J.D.))—British Flora. 1887.
15. Baker (J. G.)—Article Leguminosæ, in Oliver's "Flora of Tropical Africa," II, 1879.

16. Baker (J. G.)—Article Leguminosæ, in Hooker's "Flora of British India," II, 1879.
17. Baker (R. T.) and Smith (H. G.)—Research on the Genus *Eucalyptus*, 1902, Chapter on Evolution of the Genus.
18. Britten and Brown—Flora of Northern United States and of Canada, II, 1897.
19. Cambage (R. H.)—Series of sixteen papers on the Geographical Distribution of the Plants of New South Wales. Proc. Linn. Soc., N.S. Wales, 1900–1913.
20. „ Climatic and Geological Influence on the Flora of New South Wales. Rept. Aust. Assoc. Adv. Sci., 1907, p. 473.
21. „ Development and Distribution of the Genus *Eucalyptus*. Presidential Address, Roy. Soc. N.S. Wales, 1913.
22. „ Dimorphic Foliage of *Acacia rubida* and Fructification during bipinnate Stage. Journ. Roy. Soc., N. S. Wales, 1914, p. 136.
23. Candolle (Alphonse de)—Geographie Botanique, 1855.
24. Chamberlin (T. C.) and Salisbury (R. D.)—Geology, 1906, III.
25. Cheeseman (T. F.)—Manual of the New Zealand Flora, 1906, pp. 107–123.
26. David (T. W. Edgeworth)—Geological Notes on Kosciusko, with special reference to evidence of Glacial Action. Proc. Linn. Soc., N.S. Wales, 1908, XXXIII, pp. 657–660.
27. David (T. W. E.) Pittman (E. F.) and Helms (R.)—Geological notes on Kosciusko, with special reference to evidences of Glacial Action. Proc. Linn. Soc. N.S. Wales, XXVI, 1901, p. 26, 27.
28. Deane (H.)—Presidential Address. Proc. Linn. Soc., N.S. Wales, 1895, pp. 638–667.

29. Deane (H.)—Presidential Address. Proc. Linn. Soc. N.S. Wales, 1896, pp. 821 – 859.
30. „ Observations on the Tertiary Flora of Australasia, with special reference to Ettingshausen's Theory of the Tertiary Cosmopolitan Flora. Proc. Linn. Soc. N.S. Wales, 1900, pp. 463 – 475.
31. Domin (K.)—Queensland's Plant Associations. Proc. Roy. Soc., Queensland, 1910.
32. Ettingshausen (Baron von)—Cosmopolitan Flora of Tertiary Australia. Mem. Geol. Soc. N.S.W., 1888.
33. „ Die Tertiärflora von Häring. Wien Abhandl.
34. Garcke (A.)—Illustrierte Flora von Deutschland, 1895.
35. Guppy (H. B.)—Observations of a Naturalist in the Pacific. Macmillan & Co., 1906.
36. „ Studies in seeds and fruits. Williams and Norgate, 1912.
37. Harvey and Sonder—Flora Capensis, II, 1862.
38. Hedley (C.)—A Zoögeographic Scheme for the Mid-Pacific. Proc. Linn. Soc., N.S. Wales. 1899.
39. „ Palæogeographical Relations of Antarctica. Proc. Linn. Soc., Lond., 1911-12, p. 80-90.
40. Hooker (Sir J. D.)—Introductory Essay to the Flora of Tasmania, 1859.
41. „ Index Kewensis and Supplements.
42. Jhering (von)—Trans. N.Z. Inst., xxiv, 1891, p. 431. Quoted from Hedley (38).
43. „ N. Jahrb. of Mineralogie, Sc. Beit. Bd., xxxii, 1911, p. 176, pl. v, quoted from Hedley (38).
44. Kirk (T.)—The Forest Flora of New Zealand. Wellington, By Authority, 1889.
45. Lindley (John)—The Vegetable Kingdom, 1853.
46. Lubbock (Sir John)—A Contribution to our knowledge of Seedlings. (Article Leguminosæ) I, 1896.



47. Maiden (J. H.)—Forest Flora of New South Wales. By Authority.
  48. „ Critical Revision of the Genus *Eucalyptus*, 26 parts prepared to date. By Authority.
  49. Maiden (J. H.) and Betche (E.)—Census of Plants of New South Wales. In Manuscript only.
  50. Mueller (Baron F. von)—Iconography of the Genus *Acacia*. 13 Decades.
  51. „ Second Census, Australian Plants, 1889.
  52. „ “*Eucalyptographia*.” By Authority, Victoria, 1879—1884.
  53. Newberry (J.)—Monograph xxvi, U.S. Geol. Surv., 1890.
  54. Rodway (L.)—Flora of Tasmania (Leguminosæ).
  55. Scott (D. A.)—Evolution of Plants. Home University Library, 1913. (Chapter on the origin of Dicotyledons).
  56. Spencer (Baldwin)—Summary, Horn Expedition, 1896, p. 160.
  57. Strasburger (Ed.)—Text Book of Botany, 1912.
  58. Tate (R.)—Influence of Physiographic Changes in the Distribution of Life in Australia. Rept. Aust. Assoc. Adv. Sci., i, pp. 312—325.
  59. „ Horn Expedition, Botany, 1896.
  60. Taubert—Naturlichen Pflanzenfamilien, III, Teil. (Engler and Prant). (Leguminosæ).
  61. Unger—New Holland in Europe. Journ. Botany, 1865. Translated by Seeman. Quoted from Deane (28).
  62. Wallace (A. R.)—Island Life, 1892.
-

## ON THE RECOVERY OF ACTINIUM AND IONIUM FROM THE OLARY ORES.

By S. RADCLIFF.

[*Read before the Royal Society of N. S. Wales, November 4, 1914.*]

A general account of the methods devised for extracting radium from the interesting ore complex occurring at Olary, South Australia, has already been given,<sup>1</sup> the present communication deals with the recovery of the ionium and actinium. Both ionium and actinium possess many of the properties of the rare earths, and separate out along with these in the course of treatment. It is necessary, therefore, to investigate the distribution of the rare earths in the various residues and precipitates produced in treating the ore, and to examine these chemically and also by means of the electroscope.

### **Ionium.**

As ionium appears to be chemically inseparable from thorium, the activity of the ionium preparation that can be separated from a given ore depends on the ratio of the uranium to the thorium in it.

The chemistry of thorium has been very fully worked out, and in order to obtain an active ionium preparation from an ore, all that is necessary is to extract the thorium and purify it by any of the well known methods. The uranium thorium ratio for the Olary ore is about 100 : 1. It is possible therefore to obtain from it ionium preparations of considerable activity.

### **Actinium.**

Our knowledge of the chemistry of actinium is very imperfect, none of its salts have yet been prepared in a

---

<sup>1</sup> Proc. Roy. Soc. N.S.W., XLVII, p. 145.

state approaching purity, and methods for its complete isolation remain to be devised; the progress of the separation can of course be followed by means of the electroscope. Unfortunately actinium preparations frequently show little or no activity initially, and it is necessary to keep them for some weeks in order to observe the characteristic rise of the activity with time.

The uranium concentrates as received for treatment contain between three and four per cent. of rare earths, the mixture having the composition:—

Thorium oxide	...	...	0·32 per cent.
Cerium oxide	...	...	27·60 „
La and Dy oxide	...	...	46·60 „
Yttrium oxide	...	...	25·30 „

These earths distribute themselves in three of the works' products. They are found:—

- (a) In the hydroxides of the elements of the iron group which are precipitated by carbonate of soda during the extraction of the uranium.
- (b) In the uranium oxide recovered.
- (c) In the mixture of impure sulphates of lead barium and radium recovered in the course of the extraction of the radium.

The uranium oxide contains only traces of rare earths, and as these are only very feebly radioactive, they have not been examined in detail.

The hydroxides (a) when washed and dried contain about 5% of a mixture of rare earths of the composition:—

Thorium oxide	...	...	7·5 per cent.
Cerium oxide	...	...	34·7 „
La and Dy oxide	...	...	26·3 „
Yttrium oxide	...	...	31·5 „

These rare earths appear to be actinium free.

The sulphate mixture (c) contains about 3% of rare earths of the composition:—

Thorium oxide	...	...	13·2 per cent.
Cerium oxide	...	...	44·0 „
La and Dy oxide	...	...	42·6 „
Yttrium oxide	...	...	trace

The activity of these rare earths increases at about the rate expected from the presence of actinium and almost the whole of the actinium in the ore appears to be carried down with the precipitated lead and barium sulphates.

This is in accord with the observation of Debiere,<sup>1</sup> who states that actinium can be removed from a solution by precipitating barium as sulphate in it.

As ten tons of concentrates yield only 40 kilos of sulphates, the concentration of the actinium is very considerable. The sulphates, which have the composition:—

Lead sulphate	...	...	69·24 per cent.
Barium sulphate	...	...	12·50 „
Ferric oxide	...	...	2·15 „
Silica	...	...	10·82 „
Titanic oxide	...	...	3·0 „
Rare earths	...	...	3·0 „

are treated as follows:—

1. They are fused in an iron crucible with excess of caustic soda containing some carbonate of soda; the melt is extracted repeatedly with hot water, and this removes the greater part of the lead.

2. The insoluble residue is digested under a steam pressure of 90 lbs. with an excess of carbonate of soda.

3. The carbonate residue after washing is treated with dilute hydrogen chloride and the solution evaporated to

<sup>1</sup> C.R., 129, p. 593.

dryness, the residue is taken up with water and the silica filtered off.

4. The solution is saturated with gaseous hydrogen chloride and the radium and barium quantitatively precipitated.

The solution contains the actiniferous rare earths. It is evaporated to dryness to expel the excess of hydrogen chloride, and the residue is then treated for the separation of the actinium.

It is hoped that ultimately sufficient material will be available to allow of pure salts of actinium being prepared.

The determination of both the atomic weight and the period of actinium is much to be desired, as a knowledge of these two constants would fix the position of actinium and its products in the disintegration series of the radioactive elements.

---

THE HÆMATOZOA OF AUSTRALIAN BATRACHIANS,  
No. 2.<sup>1</sup>

By J. BURTON CLELAND, M.D., CH.M.

[Read before the Royal Society of N. S. Wales, November 4, 1914.]

SINCE the publication in 1910 by Dr. Harvey Johnston and myself in the Journal and Proceedings of the Royal Society of New South Wales of a paper dealing with the Hæmatozoa of our Australian Batrachians, I have continued an examination of the blood of such specimens as have come my way, and this has been very materially supplemented by blood-films kindly forwarded by Dr. T. L. Bancroft of Eidsvold, Queensland. Blood-films from 54 individuals, comprising 18 species, have been examined. In only two of these were hæmatozoa detected, one being a film from *Hyla cœrulea* containing *Hæmogregarina (Lankesterella) hylæ* (previously described by us) forwarded by Dr. Bancroft, and the other being from *Limnodynastes tasmaniensis* caught on the Murray River, near Morgan, in South Australia, which contained trypanosomes. We have also previously described trypanosomes from this species at Eidsvold in Queensland.

It is of interest to note that in only one species of frog, *Hyla cœrulea*, have we so far found hæmogregarines, and that these may be found in this batrachian at such remotely separated places as Sydney and Eidsvold. Further, in only two species of frogs, *Limnodynastes tasmaniensis* and *L. ornatus*?, both nearly related, have trypanosomes been seen by us, and these again at such sundered places as Eidsvold in Queensland and near Morgan on the Murray

<sup>1</sup> Vide The Hæmatozoa of Australian Batrachians, No. 1, by J. B. Cleland and T. H. Johnston, this Journal, 1910, p. 252.

River in South Australia. In both instances the absence of widespread infestations of many species of frogs suggests either that these respective parasites are almost or quite confined to single species and are not capable of living in others, or else that some feature in the life-history of the infected species enables the intermediate host to transmit the parasite from individual to individual, this feature being absent in non-infected kinds.

HÆMOGREGARINA (LANKESTERELLA) HYLÆ, Cleland and Johnston.

In only one out of nine specimens of *Hyla cœrulea* examined was this hæmatozoon detected. This frog came from Eidsvold in Queensland, the range of the parasite being thus extended from Sydney to this part.

TRYPANOSOMA ROTATORIUM, Mayer (?)

In a specimen of *Limnodynastes tasmaniensis* obtained on the river Murray near Morgan, South Australia, in November, 1913, trypanosomes were present. We have previously recorded them from Queensland in this species and in *L. ornatus* (?) under the specific name of *Trypanosoma rotatorium*, Mayer (?). The trypanosomes in the river Murray frog were again very pleomorphic, some being very narrow and some broad, some almost unstained and very slender, some deeply stained and others coarsely longitudinally streaked. The sizes varied from  $20\mu$  long by  $2\cdot5\mu$  broad, up to  $52\mu$  long by  $8\cdot5\mu$  at the widest part in a deeply stained example.

The results of these further examinations may be tabulated as follows:—

List I.—*Species in which Hæmatozoa were found*:—

*Hyla cœrulea*, Sydney, October 1910, nil; November, 1910, nil; Eidsvold, Queensland, December, 1910, nil; Sydney (two sps.), February, 1911, nil; Liverpool, Sydney,

October, 1911, nil; Sydney, November, 1912, nil; Eidsvold (two sps.), February, 1913, *Hæmogregarina hylæ* in one.

*Limnodynastes tasmaniensis*, Eidsvold, Queensland, 1913, nil (? this species); Murray River, near Morgan, South Australia, November, 1913, *Trypanosoma rotatorium*(?)

List II.—*The following frogs have been examined for Hæmatozoa but with negative results:—*

*Limnodynastes peronii*, D. and B., Eidsvold, Q., November, 1910; Eidsvold, April, 1913.

*L. dorsalis*, Gray, Sydney (two sps.), November, 1910; Flinders Is., Bass Straits, November, 1912.

*L. ornatus* (?), Eidsvold, Q. (two sps.), November and December, 1911.

*L. fletcheri*, Cowra, N.S.W., (nine sps.), February, 1911.

*L. sp.*, Eidsvold, Queensland, June, 1911.

*Crinia signifera*, Kosciusko, December, 1910.

*Hperolia marmorata*, Eidsvold, Q., June, 1911.

*Pseudophryne bibronii*, Eidsvold, Q., June, 1911; Eidsvold, April, 1913.

*Phractops australis*, Eidsvold, Q., December, 1910, and April, 1913.

*Hyla peronii*, Eidsvold, Q., November, 1910.

*H. rubella*, Eidsvold, Q., June, 1911.

*H. ewingii*, D. and B., Flinders Island, Bass Straits, Nov., 1912.

*H. citropus*, Blackheath, N.S.W., November, 1910.

*H. aurea*, Hawkesbury River, (ten sps.); Sydney, Feb., 1913.

*H. lesueurii*, Eidsvold, Q., (two sps.), June, 1911.

Green frog like *H. aurea* but not a *Hyla*, Eidsvold, Q., (two sps.), 1913.

Small frog, Eidsvold, Q., June, 1911.

---



OBSERVATIONS ON SOME REPUTED NATURAL  
EUCALYPTUS HYBRIDS,

TOGETHER WITH DESCRIPTIONS OF TWO NEW SPECIES.

By J. H. MAIDEN, F.L.S., and R. H. CABBAGE, F.L.S.

[Read before the Royal Society of N.S. Wales, December 2, 1914.]

WE desire to invite attention to three interesting plants described by us some years ago<sup>1</sup> as suggestive of hybridism, and we offer some notes upon them. The direct evidence of hybridism in Eucalyptus is usually a matter of inference and not of direct experiment; it seems to us that in two of the plants referred to, it is desirable to attach names to them.

A. (*op. cit.*, p. 199). We have no further evidence to offer in this case, and consider that it is one for further investigation. We have since found a few additional trees belonging to this form, but they were only about a quarter of a mile from the original tree.

B. (*op. cit.*, p. 200). Many small mallee-like forms are very puzzling, partly because they are so small that certain characters are not obvious as in the case of large trees, and partly because the *Renantheræ*, to which class this particular plant belongs, present many points of resemblance.

As regards B. it appears to be identical with *E. hæmastoma*, Sm. var. *montana*, Deane and Maiden,<sup>2</sup> from Mount Victoria about four miles from Blackheath.

Since then, one of us has suggested<sup>3</sup> the close resemblance of the Mount Victorian specimens to *E. amygdalina*, Labill. var. *nitida*, Benth. (*E. nitida*, Hook. f.) of Tasmania.

<sup>1</sup> Proc. Linn. Soc. N.S.W., xxx, 199 (1905).

<sup>2</sup> Proc. Linn. Soc. N.S.W., xxvi, 125, (1901).

<sup>3</sup> "Critical Revision of the Genus Eucalyptus," i, 163.

The type of *E. nitida* is figured at Plate xxix of Hooker's Fl. Tas. (Botany of Tasmania). What Hooker says about it has been quoted at p. 158 of the "Critical Revision." Compare with p. 163.

We are of opinion that B. is conspecific with *E. nitida*, Hook. f., and that that species is sufficiently distinct from *E. amygdalina*, Labill. Thus *E. nitida* should be added to the flora of New South Wales (it will probably be found in Victoria); it is not exclusively a Tasmanian species.

Bentham, as already indicated, combined *E. amygdalina* and *E. nitida*, and Rodway<sup>1</sup> agreed with him. Messrs. Baker and Smith dissent,<sup>2</sup> but do not publish their evidence.

Mr. Cambage's No. 2004 from Kydra Trig. Station, Kybean, (4,030 feet), north-east by east of Nimitybelle, New South Wales, is from a locality connecting Blackheath with Tasmania. Here the plant is mallee-like and 6–8 feet high.

*Tasmanian specimens.*—Certain specimens quoted by Hooker are referred to in the "Critical Revision," p. 163, together with a specimen by Milligan, and the notes need not be reprinted. Comparing these specimens, and Hooker's figure, the leaves of the Tasmanian forms are longer and narrower than those of New South Wales, but we find the character not constant, since there are transition forms both in Tasmania and New South Wales.

Ten to fifteen feet high. Towards summit of Mount Bischoff, Waratah, West Tasmania (R. H. Cambage 4103).

Small stunted trees near summit of Mount Roland (3,700 feet) near Sheffield (R. H. Cambage Nos. 4097 and 4099).

---

<sup>1</sup> The Tasmanian Flora, p. 56.

<sup>2</sup> Research on the Eucalypts, p. 169.

C. (*op. cit.*, p. 201).

**EUCALYPTUS KYBEANENSIS, nov. sp.**

Arbor Mallee similis, 6 – 10' alta, caulibus lævibus viridibus, ligno pallido. Folia juvena lanceolata circiter 6 cm. longa, 1 cm. alta, non-glaucous, subtus pallidiore-virentia, margine crassata, costa media prominente, venis lateralibus prominentibus et fere pinnatis. Folia matura coriacea, lanceolata, circiter 6 – 8 cm. longa, 1.5 cm. alta. Alabastra operculis hemisphericis diametro circiter conoideo calycis tubo dimidio equilongis. Flores renantheri. Fructus sessiles, ad 7 in capito, fere hemispherici, diametro fere 1 cm., orificio leniter rotundati, valvarum apicibus orificio æquis.

Species cum *E. stricta* affinitate trahitur, fructibus autem maxime diversis et *E. capitellatæ*, Sm. similibus, qua magna "Stringybark" est.

Of mallee-like growth, six to ten feet high, with smooth, greenish stems one and a half inches in diameter. Timber pale coloured.

*Seedling leaves.* Lanceolate, about 6 cm. long by 1 cm. broad as the alternate stage is reached, very shortly petiolate, non-glaucous, of a brighter green on the underside. Margin thickened. Midrib prominent and raised, showing a depression on the upper page of the leaf, the lateral veins prominent and roughly pinnate, intramarginal vein well removed from the edge.

*Mature leaves* rather coriaceous, lanceolate, about 6 – 8 cm. long by 1.5 cm. broad, erect, shortly petiolate, equally green on both sides. Veins fairly prominent and spreading from the base; intramarginal vein a considerable distance from the edge.

*Buds.* Externally rough in texture, operculum hemispherical, the diameter about half the length of the conoid calyx-tube.

*Flowers.* Renantherous.

*Fruits.* Sessile, up to seven in the head. Nearly hemispherical, nearly 1 cm. in diameter, rim broad and reddish-brown, gently domed, tips of valves flush with the orifice.

The type grew on sandy conglomerate formation at Kybean, amongst *Casuarina nana*, Sieber, near the Kydra Trigonometrical Station, on the Great Dividing Range, 4,000 feet above sea-level, sixteen miles easterly from Nimitybelle. (Coll. R. H. Camage, 4th November, 1908).<sup>1</sup>

We are of opinion that it is not to be specifically separated from the plant we have indicated as C.<sup>2</sup> in another paper.

The seedling shows its close relationship with *E. virgata* Sieb. var. *stricta* (*E. stricta*, Sieb.), but the domed fruits of hemispherical shape separate them sharply from that species. They are reminiscent of those of *E. capitellata*, Sm., though not quite similar to those of that species, which is a tall Stringybark tree.

#### EUCALYPTUS BENTHAMI, nov. sp.

Arbor magna erecta, "White" vel "Flooded Gum" vocata, cortice basi plusve minusve secendente 3 – 4 ft. diametro, 60 – 100 ft. alta, ligno pallido et non duro, foliis juvenibus tenuissimis glaucis infra pallidioribus lanceolatis ad ovato-lanceolatis cordatis, foliis maturis sub-glaucis lanceolatis, alabastris ad 7 in umbella leniter urceolata, operculo acuminato, pedicellibus brevibus, umbella in pedunculo gracile circiter .5 cm. longo, fructibus immaturis urceolatusculis ad fere hemisphericis, margine distincto, fructibus maturis fere hemisphericis circiter .5 cm. diametro, valvarum apicibus leniter exsertis.

A large conspicuous White or Flooded Gum, rather erect in habit, with more or less rough-flaky bark at the butt; such bark may be almost wholly absent, or sometimes

<sup>1</sup> The plant referred to as No. 1980 in Proc. Linn. Soc. N.S.W., xxxiv, 327, (1909) is this species.

<sup>2</sup> Proc. Linn. Soc. N.S.W., xxx, 201, (1905).

extending to the first fork. The rough bark rather hard, but rarely almost fibrous, and terminating in short ribbons. Commonly three to four feet but sometimes six feet in diameter, and sixty to a hundred feet high. Timber pale pink when fresh and of medium hardness and fissility.

*Juvenile leaves* very thin, very glaucous when young, but drying nearly glabrous, paler on the underside, showing a profusion of oil-dots and distinct veins. Lanceolate to ovate-lanceolate, and cordate, amplexicaul, bluntly pointed or acute, up to 10 cm. long, by 4 cm. in greatest width.

*Mature leaves* slightly glaucous, lanceolate, petiolate, somewhat falcate. Midrib prominent, (sometimes pinkish), the lateral veins, which are irregularly pinnate, prominent, the intramarginal vein distinctly removed from the edge. Common dimensions are 14 cm. long, 1.5–2 cm. broad, with a petiole of 2 cm.

*Buds* usually glaucous, up to seven in the head, slightly urceolate, operculum pointed, about half the length of the calyx-tube, which gently tapers into a short pedicel, the umbel being supported by a slender peduncle of about .5 cm.

Expanded flowers not seen.

*Fruits.* In the half grown state glaucous, somewhat urceolate to nearly hemispherical, and with a well-defined raised rim. When ripe, nearly hemispherical, about .5 cm. in diameter, slightly domed; tips of the valves slightly exsert.

It is the "Flooded Gum of Camden," No. 108 of the New South Wales timbers contributed by Sir William Macarthur to the Paris Exhibition of 1855 and No. 28 of those of the London Exhibition of 1862).

Under 108, Sir William Macarthur notes in the Catalogue, "Flooded Gum of Camden, diameter 36–48 inches, 80–120 feet high. A fine-looking tree, with elegant pendant foli-

age; the timber not valued, being weak and perishable in comparison with many other of the common hardwoods."

Under No. 28 it is described by the same writer as "A fine looking but comparatively worthless sort; the timber weak and not durable." The diameter is given as the same, but the height is reduced to from 80 - 100 feet high.

It will be observed that under 108 the tree is described as of "elegant pendant foliage." Speaking generally, this is not a good description, although we have seen an odd tree to which it would apply. In the great majority of cases the trees and foliage are rather erect in habit.

In the "Flora Australiensis" (iii, 240) the specimen just mentioned (bearing the No. 108) is placed under *E. viminalis* and the record has always been accepted, e.g., Woolls' "Plants indigenous in the neighbourhood of Sydney" (1st and 2nd editions).

The Nepean River trees are quite close to Camden Park and it would be impossible for Sir William Macarthur not to be familiar with them, and no other local tree could be mistaken for them. We are of opinion that *E. viminalis*, Labill. should be removed from the flora of the County of Cumberland.

\* \* \* \* \*

In the Kew herbarium is a specimen labelled "No. 16. Southern district New South Wales, Macarthur and others. 'Flooded Gum.' From the London Exhibition of 1862," which appears to be referable to *E. Benthami*.

No. 16 in the official catalogue has the entry "Collected by Edward Hill, Esq., aboriginal name at Brisbane Water 'Thurambai,' vernacular name 'Flooded Gum,' a famous timber for ship-building and for house carpentry." This description can only apply to *E. saligna*, Sm., but the herbarium specimens are not of that species. It is proper to refer to a numbered specimen in the principal herbarium

of the world, but one cannot explain the label. To begin with, Brisbane Water is in the north, and not in the southern districts. The specimen may have been received as "Flooded Gum," and the description of a second Flooded Gum (*saligna*) other than *Benthami*, tacked on to it. The specimen was not exhibited in the previous or Paris Exhibition.

#### *Affinities.*

1. With *E. viminalis*, Labill. The new species has by most observers been confused with *E. viminalis* and being a White Gum with rough bark at butt, and growing on river flats and banks of rivers explain why this view has been so prevalent. But it is more erect in habit, *E. viminalis* having more pendulous branches and more distinctly ribbony bark.

The new species has broader juvenile leaves, the foliage is sub-glaucous, the flowers are smaller and never in threes, the fruits are of a different shape, with the valves never as exsert as those of *E. viminalis*.

2. With *E. Macarthuri*, Deane and Maiden. *E. Benthami* is a tall, rather erect tree with a somewhat thin canopy; *E. Macarthuri* is a smaller tree with a rather umbrageous head. The bark of *E. Macarthuri* is rough, somewhat box-like, but very woolly; that of *E. Benthami* being smooth in the upper portion (a White Gum) and flaky at the base. Sometimes it is wholly smooth.

The juvenile foliage and buds are sub-glaucous in *E. Benthami*; the buds of *E. Macarthuri* are often shining and slightly smaller than those of *E. Benthami*.

The trees referred to as *E. Macarthuri* at Werriberri Creek in Proc. Linn. Soc. N.S.W., xxxvi, 553, (1911) are *E. Benthami*.

Type from the banks of the Nepean River near Cobbitty, N. S. Wales (Camden district). J. H. Maiden and R. H. Camage, June, 1913.

The following specimens are either referable to the present species or are closely related thereto:—

(1) Seven miles east of Walcha, J. H. Maiden, Nov., 1897.

A tree with box-scaly or rough apple-like (*Angophora intermedia*) bark, rough, except the ultimate branchlets; suckers ovate-lanceolate, not glaucous, except the very young tips of the branchlets of the suckers.

(2) Guy Fawkes, Armidale district, J. L. Boorman, December, 1909.

A tall tree with a fibrous bark, and claret coloured tips to branches. Reputed locally to be a useful timber for building and fencing purposes.

---



NOTES ON EUCALYPTUS, (WITH A DESCRIPTION  
OF A NEW SPECIES) No. III.

By J. H. MAIDEN, F.L.S.

---

[Read before the Royal Society of N. S. Wales, December 2, 1914.]

---

## EUCALYPTUS PRÆCOX, nov. sp.

Arbor pumila, ramis dependentibus. Cortex lævis, maculata, secedens. Lignum pallidum et fragile. Folia juvena lato-ovata et crassa. Folia matura petiolata, lanceolata ad lato-lanceolata ad fere ovata, dilute virentia. Alabastra in umbellis glaucis, ovoidea in juventute. Operculum conicum et acuminatum, calycis tubo leniter brevior. Florit in ætate lato-foliata vel juvenile. Fructus fere hemisphærici, circiter 6 cm. diametro, margine lato et rotundato valvarum spicibus distincte exsertis.

A dwarf tree of drooping habit. Bark smooth, blotched and also ribbony.

Timber pale-coloured and brittle, showing a tinge of reddish-brown, and possessing kino veins.

*Juvenile leaves* broadly ovate, thick, coarse, venation very prominent, lateral veins at about an angle of 45° to the midrib, intramarginal vein far removed from the edge.

*Mature leaves* petiolate, from lanceolate to broadly lanceolate and nearly ovate, pale green, and the same colour on both sides, midrib prominent, lateral veins distinct but not prominent, intramarginal vein well removed from the edge.

*Buds* in glaucous umbels, ovoid when young, when riper operculum conical and pointed, a little shorter than the calyx-tube, which tapers gradually into a short, thickish pedicel, the whole on a peduncle of about 7 cm.

*Flowers* not seen fully expanded. Unripe anthers appear to be similar to those of *E. maculosa* of the same age.

*Fruits* nearly hemispherical, about '6 cm. in diameter, rather abruptly set on the short pedicels, rim broadish and domed, the tips of the valves distinctly exsert.

Type from Capertee, N.S.W., J. H. Maiden and J. L. Boorman, March, 1901.

This species possesses characters in common with *E. maculosa*, R. T. Baker and *E. rubida*, Deane and Maiden.

It has a closer and general resemblance to *E. maculosa*, but the fruits are rounded and the juvenile foliage is broad. That of *E. maculosa* is on the whole narrow, although exceptionally it may be broadish.

An outstanding character of the present species is that of the flowering, which may take place while the leaves are in the broad or juvenile stage, and the specific name is given in reference to this.

As regards New South Wales, the only truly homoblastic species, so far as we know, is the disappearing endemic *E. pulviger*, A. Cunn. There are, however, several species in which the vegetative form, or the foliage characteristic of juvenility, persists for a considerable time, the tree flowering frequently and indeed usually, in this stage. Indeed, the advent of the mature foliage is often so retarded that it may require careful search to find it, and from some individuals it may be absent altogether. We must of course bear in mind that the adult foliage may be found at the very top of a particular tree, and if the tree be of any size, it is quite easy to omit seeing it.

New South Wales species in which the juvenile foliage is very persistent include *E. parvifolia*, Cambage, and *E. cinerea*, F.v.M., *E. melanophloia*, F.v.M., and the one proposed as new in this paper is an addition to a short list.

I have referred to the subject in another paper<sup>1</sup> and have quoted a number of species which, so far as we know, are homoblastic (isoblastic) throughout life.

The ascertainment, during the last few years, that certain reputed homoblastic species are really heteroblastic, stimulates us to further enquiry in the same direction. Incidentally, it may be remarked that Dr. Diels has proposed the word *helicomorphy* to include the two leaf forms in heteroblastic species.

Following the cotyledon leaves, the ordinary sequence of leaves is from the sessile to the petiolate, but I exhibit an example (*E. macrocarpa*, Hook.) in which the reverse is the case.

**Following are notes on species already published.**

**1. EUCALYPTUS PLANCHONIANA, F.v.M.**

[Previous reference, this Journal, XLVII, 234, (1913).]

This not very well known species is also found at Glen Elgin, east of Glen Innes, and particulars of this locality will be found at p. 66, part 24 of my "Forest Flora of New South Wales."

It occurs with the Waratah (*Telopea speciosissima*) more or less over an area of one hundred square miles; *i.e.*, from Boundary Creek east to Pheasant Creek, north to Moojam, south to Tindale, and to the west following the Dividing Range.

It is known locally as Red Mahogany, because of the similarity of its bark to that of *E. resinifera*, but it has not a red timber like that tree; it is also known as Needle Bark, because it is prickly to rub down with the hand.

---

<sup>1</sup> "On two new Western Australian species of Eucalyptus," Journ. Nat. Hist. and Science Soc., W.A., Vol. III, No. 1.

The name Porcupine Stringybark is also applied to it for the same reason.

## 2. EUCALYPTUS KIRTONIANA, F.v.M.

[Syn. *E. patentinervis*, R. T. Baker.]

Following is the history of Mueller's species, beginning with the two published references made by him.

1. "In the Illawarra district occurs a tree which attracted great attention in India, not only because of its rapid growth, but also as it proved the best species there to cope with the moist tropical heat. This tree has been cultivated at Lucknow by Dr. Bonavia, who recorded that it attained in the best soil twelve feet in two years; it was there considered to belong to *E. resinifera*. It differs, however, from that species in having the leaves of equal colour on both sides with more prominent veins, the intramarginal veins more distant from the edge; thus in venation, as also in odour of foliage and fruit, the tree in question approaches *E. robusta*, but its fruit is certainly similar to that of *E. resinifera*, wanting, however, the broadish outer ring around its orifice characteristic of the typical *E. resinifera*, while the lateral veins of the leaves are not quite so transversely spreading as in either. If really specifically distinct, the tree might be named *E. Kirtoniana* in honour of its discoverer." (Mueller's "Eucalyptographia under *E. resinifera*.)

2. "A quick growing tree, rare in the Illawarra district, which at Lucknow attained a height of 45 feet in 10 years, and which as a species or variety I distinguished as *E. Kirtoniana*, is in flowers and fruit nearer to *E. resinifera* than to *E. robusta*, but has the leaves of almost equal colour on both sides, thus far, and also in shape, more resembling those of *E. tereticornis*, while the bark, unlike that of *E. saligna*, is persistent. The stomates of *E. Kirtoniana* vary on the upper side of the leaf between 33,000 and 43,000, and on the lower page from 95,000 to 166,000 on a square inch, this great fluctuation being attributable probably to the age of the tree. It is particularly noticeable on account of

its adaptability to a warm wet clime, and grew under Dr. Bonavia's care better than any other species in Oude ; the technic value of its timber remained unascertained." (*Op. cit.* under *E. robusta.*)

The first reference is in Part I of the "Eucalyptographia" (1879). Indeed, under *E. hæmastoma* in the same work, Mueller definitely gives the date 1879 for *E. Kirtoniana*. The second reference is in Part VII. Later on (in some editions of his "Select extra-tropical plants") Mueller obviously looked upon it as a form of *E. resinifera*.

The description is unsatisfactory as measured by modern standards, but it is backed by herbarium specimens, and so, whatever the opinions of botanists as to its relationships may be, we know precisely the plant to which Mueller referred.

The specimens seen by me are labelled as follows:—

1. "*E. punctata*, DC. (*E. Kirtoniana*, F.v.M.). Kirton, Illawarra." A piece from the Melbourne Herbarium, received from the late Mr. J. G. Luehmann.
2. "*E. punctata* (*E. Kirtoniana*, F.v.M.). Lucknow, India. (Cult.)"
3. "Lucknow. Comm. Dr. Brandis, July 1877."

Nos. 2 and 3 are identical. No. 2 was presented to the Sydney Herbarium by Mr. Luehmann, and No. 3, which bears the original label "*E. resinifera*," bears also the label in pencil "*E. Kirtoniana*, Müll, cf. *E. rudis*." No. 3 was presented by Kew to the Sydney Herbarium in April, 1901.

I exhibit all three specimens.

Owing to Mueller's recommendation of it as a species especially adapted for tropical cultivation, it has been extensively cultivated, particularly in Northern India, and to a less extent in North Africa.

The name of *E. Kirtoniana*, F.v.M. must stand unless it be synonymous with a name which has priority. We cannot say we do not clearly know what *E. Kirtoniana*, F.v.M. is, and therefore we cannot suppress it on that ground.

Mr. R. T. Baker redescribed<sup>1</sup> this tree under the name of *E. patentinervis*.

Mr. Henry Deane and I in a revision of *E. resinifera*, Sm. described<sup>2</sup> it as var. *Kirtoniana* of that species.

Messrs. Baker and Smith, under *E. patentinervis* later wrote:—<sup>3</sup>

“Since this species was described, we have seen a specimen in the National Herbarium, Melbourne, labelled “*E. Kirtoni*” (*sic*) by Baron von Mueller, which much resembles and may possibly be this species; but as no description of *E. Kirtoni* was ever published, we have decided to let our name stand, purely for the sake of scientific precision.”

I have suggested<sup>4</sup> that *E. Kirtoniana* may be a hybrid between *E. robusta* and *E. resinifera*.

### 3. EUCALYPTUS GLOBULUS, Labill.

Tall trees of 60–80 feet, thick straight stems of 20–40 feet up to the first branches, sound and of first class quality, are fairly plentiful in many of the gullies running down from the high table-lands south at Upper Meroo, between Hargraves and Mudgee (J. L. Boorman).

### 4. EUCALYPTUS PERRINIANA, F.v.M.

[Syn. *E. Gunnii*, Hook. f., var. *glauca*, Deane and Maiden (in part).]

The plant which was afterwards known as *E. Perriniana* was first shown in leaf only without fruits by the late Mr.

<sup>1</sup> Proc. Linn. Soc. N.S.W., xxiv, 602, (1899).

<sup>2</sup> *Op. cit.*, xxvi, 128, (1901).

<sup>3</sup> “Research on the Eucalypts,” p. 197, (1902).

<sup>4</sup> Proc. Linn. Soc. N.S.W. xxx, 501, (1905).

G. S. Perrin,<sup>1</sup> before the Australasian Association for the Advancement of Science. Although he surmised it might be a new species, he simply referred to it as 'Specimen No. 2,' and stated that the leaves are always perfoliate in young or old specimens (which was not correct as regards mature leaves if that is what he meant).

Soon after, the plant was named *E. Perriniana* by Mueller, as Mr. Perrin verbally informed me on more than one occasion. I believe the naming took the form of distributing the plant with written notes about it. Mueller was sometimes a law to himself in such matters.

Rodway, so far as I am aware, and doubtless with Mueller's sanction, first printed<sup>2</sup> the name *E. Perriniana*, F.v.M. The leaves are at first "all opposite, connate and orbicular," later they become "alternate, petioled and lanceolate."

Then we have *E. Gunnii*, Hook. f., var. *glauca*, Deane and Maiden.<sup>3</sup> This description includes specimens of *E. Perriniana* (Snowy Mountains) and at least one other species.

Deane and Maiden, *op. cit.*, xxvi, 135, (1901) state that var. *glauca* is identical with *E. Perriniana*, F.v.M., and quote Rodway (letter of 27th March, 1900) as stating that *E. Perriniana* is "a very luxuriant young growth of *E. Gunnii*."

*Op. cit.*, xxvi, 563, I observed that "variety *glauca* (of *Gunnii*) should not be maintained, and it and *E. Perriniana* should be simply placed under *E. Gunnii*, Hook. f., they being not sufficiently removed from the type.

---

<sup>1</sup> Rept. Aust. Assoc. Adv. Science, ii, 557, (1890).

<sup>2</sup> Pap. and Proc. Roy. Soc. Tas., p. 181, (1893). In his "Tasmanian Flora," p. 58, he distinctly states that Mueller suggested the name.

<sup>3</sup> Proc. Linn. Soc. N.S.W., xxiv, 464, (1899), with Plate xlii, figs. 5-7.

Messrs. Baker and Smith describe<sup>1</sup> *E. Perriniana*, F.v.M. and arrive at the conclusion that "Morphologically they (*E. Gunnii* and *E. Perriniana*) are distinct, whilst *E. Perriniana* is identical with the tree growing at Tingiringi Mountain, N.S.W."

In the following year Rodway<sup>2</sup> again speaks of *E. Perriniana* as growing into the typical *E. Gunnii*.

Baker and Smith<sup>3</sup> claim the species on the ground that it had not been described before they had done so in 1902. Rodway's account of it in 1893 is available to anybody, and if that first meritorious though not complete description be brushed aside, then the number of Eucalyptus descriptions which must also be abandoned on similar grounds would be very many. I have touched upon<sup>4</sup> this point already, which is one apart from the question as to whether *E. Perriniana* is a valid species or not, (I believe it is).

It is found in Tasmania, and in the highlands of north-eastern Victoria and south-eastern New South Wales.

I have received it from the following localities:—  
*Tasmania*.—The Hamilton-Ouse District (L. Rodway).

*New South Wales*.—Snowy Mountains, elevation of 5,000 feet (W. Bauerlen); Mount Kosciusko, on hill sides, elevation of about 6,000 feet. (J. H. M.)

\* \* \* \* \*

Following are some notes made by me in front of the trees in the month of February:—

Straggling small White Gum of 15–20 feet, with the usual lenticular patches on the bark. Not a Mallee.

Flowers in threes. Opercula hemispherical; the colour, which is very marked, is yellow to orange and red.

<sup>1</sup> "Research on the Eucalypts," 205, (1902).

<sup>2</sup> "The Tasmanian Flora," p. 58, (1903).

<sup>3</sup> Pap. and Proc. Roy. Soc. Tas., p. 163, 1911 (1912).

<sup>4</sup> *Op. cit.*, p. 26, (1914).



Juvenile leaves perfoliate.

It is no doubt often passed over as a small *E. coriacea*, A. Cunn., var. *alpina*, but the perfoliate juvenile leaves and the mature leaves at once separate them.

\* \* \* \* \*

As regards the leaf-base we have various stages of (1) the auriculate, and (2) amplexicaul, through the (3) connate to the (4) absolutely perfoliate.

All four forms are seen in *E. Perriniana*, and the first two forms in *E. Gunnii*, Hook. f. It remains to be seen if the last two forms (3) and (4) do not occur in *E. Gunnii*. So far I am not always able to separate specimens of *E. Perriniana* showing only (1) and (2) from *E. Gunnii*, but the immature bud of *E. Gunnii* has a peculiarly pointed operculum, and the line of demarcation with the calyx-tube a raised rim. The fruit of *E. Perriniana* appears to be smaller as a rule, and uniformly more hemispherical, and the rim thinner than that of *E. Gunnii*.

Figure 11, Plate 83 of my Critical Revision of the genus *Eucalyptus* exhibits the perfoliate leaves of *E. Perriniana* and not of *E. cordata* as stated. The record of the locality should be near Hamilton, Tasmania. Mr. L. Rodway informs me he was with the late Mr. R. D. Fitzgerald when he collected it.

##### 5. EUCALYPTUS MEGACARPA, F.V.M.

The pileiform operculum of *E. gomphocephala* is unique in the genus; the same character, to a greatly diminished extent, is evident, especially in drying, in *E. megacarpa*, and may indicate relationship to a species (*gomphocephala*) which has few recorded affinities.

The affinity of the two species has been suggested before, but not as regards this organ.

On p. 247, Part xviii. of my Critical Revision, I am in doubt about Maxwell's Mount Elphinstone. Mr. C. R. P. Andrews writes:—

“There is a hill of this name at the end of Princess Royal Harbour at Albany, just on the left of the railway as you leave the harbour in travelling away from Albany. I have not the slightest doubt that this is Maxwell's locality.”

6. *EUCALYPTUS HÆMATOXYLON*, Maiden.

[This Journal, XLVII., 218 (1913).]

The buds and flowers have not been previously described.

*Buds* in a large corymb consisting of individual umbels of 4 to 7. Each peduncle thin, flattened, ribbed, and about 2·5 cm. long; the pedicels similar but slenderer, and from 1 to 1·5 cm. long. The bud club-shaped, the operculum pointed, short, less than half as long as the calyx-tube, which is contracted at the orifice, and which does not taper gradually into the pedicel.

*Flowers.* Filaments cream-coloured, stamens inflected in the bud, the anthers all fertile, long and somewhat pale, opening in parallel slits, small gland at the top; versatile.

Style ribbed, the stigma hardly exceeding it in thickness.

The anthers, style and stigma appear to be identical with those of *E. corymbosa*.

---

## NOTES ON AUSTRALIAN FUNGI, No. I.

By J. BURTON CLELAND, M.D. (*Syd.*), and EDWIN CHEEL,  
Botanical Assistant, Botanic Gardens, Sydney.

[*Read before the Royal Society of N.S. Wales, December 2, 1914.*]

IN this, and we hope in further papers to follow, we propose to record from time to time notes on the larger Australian Fungi, more especially the various species of Basidiomycetes and the fleshy Ascomycetes. The notes will include new records and distributions, additions to old descriptions, detailed descriptions of new species and points of general and economic interest. The identification of specimens by means of the often highly imperfect descriptions given by many authors for Australian species is a matter of much difficulty, greatly added to by the evanescent character of so many of the fleshy Agarics. Even though the types from which these descriptions were prepared may in some cases still exist, their examination now can add few details of value. Patience, however, and the examination of much material will, we hope, bring some order into the present chaos and make the way easier for the identification of Australian species by local mycologists. We may here call attention to a detailed account of New South Wales Basidiomycetes appearing under our joint names in the "Agricultural Gazette of New South Wales." The first part appeared in the June issue for 1914, and the second in the October number, and others will follow from time to time.

## VOLVARIA.

*Volvaria speciosa*.—Specimens of this fungus have been collected in the Botanic Gardens, Sydney (March, 1899), Leura (February, 1911), Katoomba (March 1912), and Hill

Top (April, 1913)—(Grant, "Ann. Rep. Bot. Gdns., Syd.," 1902 (1903) and Cheel, *idem* 1911 and 1912). The spore measurements of these specimens were 12 to 18  $\times$  8 to 10 $\mu$ . We have also received specimens, apparently of the same species, taken in a garden at Adelaide in June 1914. The stem was up to 8 ins. long with a much swollen base. The crowded free gills were a deep cinnamon, and the spores, lightly tinted under the microscope, 13.5 to 15.5  $\times$  8.5 $\mu$ , obliquely oval with a slight apiculus, and granular. The volva was not evident in the dried specimens and the collector had made no note as to its presence. Cooke (No. 194) records the species only for Victoria.

#### PLUTEUS.

*Pluteus cervinus*.—We have met with this species, in all instances on the ground, though possibly attached to buried wood, on three occasions, viz., in brush forest at Bulli Pass (April, 1914) and at Mosman, Sydney (May and October, 1914). The salmon-pink spores were somewhat quadrilaterally oval, 5.2 to 7  $\times$  3.5 to 5 $\mu$ . Cooke and Massee both give slightly larger spore measurements, viz., 7 to 8  $\times$  5 to 6 $\mu$ . The pale brownish cystidia were of an elongated diamond shape, 60 to 80  $\times$  17 $\mu$ , the summit being flattened in rim form, the rim consisting of several spines. Cooke records the species for Tasmania and Victoria.

#### FLAMMULA.

*Flammula filicea*, Cooke.—We have obtained specimens agreeing exactly with the plate of this fungus given in Cooke's Illustrations of British Fungi, and with the description of the species as given by Massee. The latter author mentions that the species was found on old tree-fern stems, and was probably an introduced, not British, species. It is, therefore, quite possible that it was imported from Australia on tree-ferns. The species is not recorded for Australia and, as it is considerably variable, we were at

first inclined to place some specimens under *F. hybrida* or *F. sapinea*, both of which Cooke records for Australia, and with which dried specimens can be made to agree. The finding of typical specimens of *F. filicea*, however, has shown us that these other forms belong to the same species, and possibly the two Australian records above are mis-identifications. From our specimens, we would place *F. filicea* near *F. hybrida* and *F. sapinea* under the section *Sapinei* and not, as placed by Masee, under *Sericelli*.

Description.—Pileus convex, under 1 in. to 4 ins., warty squamulose, sometimes almost quite smooth, pale yellowish brown, the scales darker brown with a greenish tint, sometimes finely warty, sometimes broader and flat and the pileus cracking, more or less tanny usually when dry. Gills adnate, occasionally with a decurrent tooth in deformed specimens, moderately crowded, sulphur-coloured becoming a rich brilliant tanny or reddish-tan when dry, attenuated both ways, some very short. Flesh yellowish. Stem usually central, but sometimes eccentric or even lateral, according to the situation where growing; sometimes attenuated upwards, sometimes downwards, thin to stout, 1 in. to  $1\frac{1}{2}$  ins., whitish to reddish-brown, fibrously streaked, sometimes slightly hollow, sometimes with reddish remains of the ring just below the gills. Spores the colour of the dried gills, obliquely oval, very fine warts sometimes detected with one-twelfth inch lens, usually  $7 \times 5.2\mu$ , rarely  $6 \times 4.2\mu$ , in one specimen some spores recorded as  $11.5 \times 7\mu$ . More or less caespitose on fallen logs and rarely on the ground. Common in autumn at Neutral Bay (Sydney), Hawkesbury River, Terrigal, Mount Lofty (South Australia, June).

*F. purpureo-nitens*, Cooke and Masee.—On three occasions we have collected a small *Flammula* which seems referable to this species, although possibly only a form of

*F. filicea*. The cap is a dark brown,  $\frac{1}{2}$  in. to  $\frac{3}{4}$  in., the gills dry to the rich reddish-tan of *F. filicea*, and the stem is dark (not light as in *F. filicea*), with some whitish mycelium at the base. Spores very finely warty (oil-immersion lens), obliquely oval,  $7.5$  to  $9.5 \times 5.2$  to  $6$ . Somewhat gregarious on burnt fallen logs. Neutral Bay (Sydney), May 1913 and 1914.

#### NAUCORIA.

*Naucoria horizontalis*.—This species seems to be unrecorded for Australia. It is common on the bark of Eucalypts (*E. piperita*) round Sydney. It is usually smaller than the  $\frac{1}{2}$  -  $\frac{2}{3}$  in. given by Masee. Our specimens agree exactly with Cooke's illustration. Spores  $8$  to  $9 \times 5.5$  to  $6.5\mu$ , oval. Neutral Bay, May to July.

#### INOCYBE.

*Inocybe perlata*.—We have specimens, collected in Sydney, of an agaric agreeing with the descriptions of this species and Cooke's illustration, except that the spores, with an oil-immersion lens, are very finely warted. Their size is  $8.3$  to  $10 \times 5.8$  to  $6.5\mu$ . As without a high magnification the fine roughness of the spores would escape observation, our identification is probably correct, and this makes a new record for Australia.

#### CREPIDOTUS.

*Crepidotus mollis*.—This species has been recorded from Victoria and Western Australia. Specimens collected by us on a rotten stump in June, July and October, 1914, at Mosman, are pure white when young, and slightly striate when older and moist, thus apparently differing from typical *C. mollis*. The gills gradually pass from white to a pale watery brown. Pileus up to 1 in. in diameter. Spores pale brown,  $7$  to  $8.5 \times 4$  to  $5.2\mu$ .

## PSALLIOTA.

Cooke records five species of *Psalliota* for Australia, two of them (*P. arvensis* and *P. campestris*) for New South Wales. We have found, as well as these two species, what we take to be *P. sylvaticus* and *P. cretaceus*, as well as possibly still another species.

*Psalliota campestris*.—We have met with several varieties of *P. campestris*, from pure white forms to others with brownish scales. The spores have measured from  $6.3$  to  $9 \times 4.2$  to  $5.5\mu$ .

It is of interest to mention here the record of finding "mushrooms" (it is highly probable that they were *P. campestris*) by Mr. Wells, of Lindsay's Exploring Expedition (p. 66), east of the Murchison Goldfields in Western Australia in latitude  $27^{\circ} 34' 21''$  S., on March 3rd, 1892. This portion of country was at that time unexplored and beyond the bounds of civilisation. Owing to the easy dispersal by wind of the spores of agarics, this cannot be taken as certainly indicative of the common mushroom having preceded the white man in the colonisation of Australia. Perhaps other much earlier records of finding it in virgin country exist.

*P. arvensis*, Schaeff.—We have met with this species in April and May, 1913, on Milson Island in the Hawkesbury River and in 1914 at Cremorne, Sydney. It was usually found growing in clumps of very tall mushrooms, sometimes in hollows. Some specimens had a very strong smell of iodoform, so powerful that any one entering the room in which they were, enquired as to the iodoform odour. The Cremorne specimens, which gave a characteristic reddish tint when the stem was cut, were cooked, when the iodoform smell was less noticeable, and eaten. Spores measured  $5$  to  $6.3 \times 3.5\mu$ .

*P. silvaticus*, Schaeff.—In July 1912, specimens of a Psalliote were found by one of us near Lismore, N.S.W. These agree with the description of *P. silvaticus*, save that the stem, which was slightly hollow, had an elongated almost rooting slightly thickened base. The spores measured usually  $5.4$  to  $6 \times 4\mu$ , occasionally  $7.5 \times 4.5\mu$ .

*P. cretaceus*, Fr.—In June 1914, one of us (J.B.C.) found at Terrigal, N.S.W., a Psalliote, characterised by pale cream gills, a whitish plane or slightly depressed pileus, a distant ring, a stem slightly hollowed with the cavity stuffed with fibrils, and spores  $5.2 \times 3.5\mu$ . It agrees in description with *P. cretaceus*. A formalin specimen as well as a dried one has been preserved.

*P. sp.*—Another Psalliote, gibbous, with dark brown scales and spores  $4.4$  to  $5.2 \times 2.5$  to  $3\mu$ , is in our collection. It was collected as *P. campestris*, but the smaller size of the spores seems to negative this. It is at present unplaced.

#### HYPHLOMA.

*Hypholoma fascicularis*.—This agaric is common around Sydney at the base of old stumps, on half-buried wood, etc. Our spore measurements vary from  $6.5$  to  $8 \times 3.5$  to  $5.4\mu$ . Cooke records it only from Victoria, South Australia and Tasmania. He gives no species of this genus for New South Wales.

#### PSILOCYBE.

Cooke records six species of Psilocybe for Australia, none of them for New South Wales. We are able to record two European species as new for Australia.

*Psilocybe bullacea*, Bull.—This European species is common in and around Sydney on dung during the autumn and winter. The somewhat viscid dark brown striate cap distinguishes it when moist. We have also found it on dung at Adelaide in July. The spores of our specimens measure  $12$  to  $14 \times 7.5$  to  $8.5\mu$ .



*P. semilanceata*, Fr. var. *cærulescens*, Cooke.—We have found this British species amongst grass on the roadside at Neutral Bay, Sydney. As in some of the specimens the cap and stem became bluish-green, we have placed our species under the variety *cærulescens*, though Masee seems doubtful as to whether this is a valid variety. The spores measured  $10\cdot4$  to  $11 \times 5\cdot5$  to  $6\cdot8\mu$ .

#### PANÆOLUS.

Of nine species of *Panæolus* recorded for Australia, none are given by Cooke for New South Wales. We have met with three, perhaps four or five, species.

*Panæolus ovatus*.—Cooke records two white viscid species one, *P. ovatus*, for Victoria, and the other, *P. eburneus*, for Queensland. The only differences that appear to exist in the descriptions of these two are that the first is ovate, at length cracked and with a stuffed stem, and the last named is convex then campanulate with a hollow stem. The spore measurements are practically identical, and it seems probable that the plants are also. We have met with a white viscid species of *Panæolus* in three localities, the spores measuring  $14$  to  $19 \times 8\cdot5$  to  $12\mu$ . The pileus is intensely viscid and the whole plant pure white, later turning a pale brownish tint. The stem is solid and the gills greyish black, with a white, finely serrate edge. Milson Island, Hawkesbury River, April 1913; Berry, September 1913; Neutral Bay, Sydney, April 1914. Probably also Coonamble, August 1912. On dung or manure-heaps. From the solid stem, we place the species under *P. ovatus*.

*P. retirugis*.—Recorded by Cooke for Victoria. We have found it, with certainty, once, at The Oaks, N.S.W., in June 1914. Spores  $13\cdot5$  to  $15\cdot5 \times 7$  to  $8\cdot5\mu$ . On dung.

*P. sphinctrinus*.—This species is not recorded for Australia. We have found on dung occasional specimens

agreeing with Cooke's illustration of this species and possessing fragments of a white veil attached to the edge of the pileus and spores measuring  $14 \times 10.4 \mu$ . The description given by Masee, who does not give the spore measurements, also fits our specimens. Milson Island, Hawkesbury River, September 1914.

*P. campanulatus*.—Cooke records the species from Victoria. A very common *Panæolus* on cow and horse dung (the habitat showing that it is not an indigenous species) has given us much trouble in identification. When moist, it resembles Cooke's illustration of *P. sphinctrinus*, save that veil remnants are not to be seen, but when dry it is smooth and shining. The spores measure  $10.4$  to  $16 \times 7.2$  to  $9 \mu$  (Masee for *P. campanulatus* gives  $8$  to  $9 \times 6 \mu$ , and Cooke  $15$  to  $18 \times 9$  to  $13 \mu$ !). The smooth shining cap when dry, a more or less rufescent stem and a whitish edging to the gills incline us to place our specimens under *P. campanulatus*. We are, however, not at all sure that the specimen referred to by us under *P. sphinctrinus*, and which we think is probably a correct identification, is not the same species as that to which these specimens—or some of them—belong, more especially as our *P. sphinctrinus* and several of these others frequently show fine cob-web like dark fibrils on the cap, which Masee refers to as being sometimes found in *P. sphinctrinus*.

#### BOLETUS.

*Boletus granulatus*, L.—This glutinous species with yellow pores is recorded by Cooke for Victoria and Queensland, and one of us<sup>1</sup> has recorded it for New South Wales. It is quite common during the months from March to May in the Port Jackson district, and we have specimens also collected at Hill Top and Moss Vale on the Southern Line, and Leura and Mount Wilson on the Western Line. We

<sup>1</sup> (E.C.) Proc. Linn. Soc. N.S.W., 1910, p. 137.

also record it for Adelaide, South Australia, and Wellington, New Zealand. We have always met with it in close association with Pines. At Milson Island, young pines (*Pinus sylvestris*) were planted in virgin soil. Within four years, when the trees were only some ten feet or so high, this *Boletus* was found in the grass at their base, together with another pine-loving fungus, *Rhizopogon luteolus*. At Richmond (Hawkesbury Agricultural College) and at Adelaide, *B. granulatus* and *Thelephora sp.* are found under pines. These three species are probably all introductions brought to Australia associated with young pines. It is remarkable that we have as yet never found them not associated with species of Pine. The spores of Adelaide specimens were yellowish,  $8.5$  to  $10.4 \times 4.2\mu$ , those from N.S.W.  $9 \times 2.5$  to  $3\mu$ . Masee gives the size as  $12 \times 3$  to  $4\mu$ .

*Boletus lacunosus*, Cke. and Mass.—Previously recorded by Cooke for Queensland, and by one of us (E.C., *loc. cit.*) for Leura, N.S.W. Since found again at Cremorne, Sydney, and at Hill Top, Southern Line, in April, the description being as follows:—Cap very glutinous,  $4\frac{1}{2}$  in. diameter, caramel-tinted, pinker brown in places, convex, soft to the touch like cotton-wool, edge ragged from remains of veil. Pores large, tubes separating from the stem, almost salmon-coloured (salmon-brown), up to  $\frac{3}{4}$  inch deep. Stem up to 6 inches high, attenuated upwards, deeply fenestrated, pale brownish (specimen old), yellowish-green in places inside, spongy pith, substance white, unchanging. Spores pale brown, ends acuminate, spinulose,  $15$  to  $15.5 \times 7$  to  $7.5\mu$ . (Cooke gives  $15 \times 10\mu$ ).

#### HYMENOGASTRACEÆ.

Twenty-three British species of Hymenogastreae are recorded and ten Australian. We have met with four forms.

*Rhizopogon luteolus*.—We have found this species on several occasions always in close proximity to species of

*Pinus*. As these trees are not indigenous and this species of fungus is found in fir woods in England, it is almost certainly an introduction, probably with seedling pines. It is exceedingly remarkable that the *Rhizopogon* should require for its development some constituent derived from the pine, which apparently must be present in the soil in very small amount as the fungus may be found some little distance away. Spores elongated, almost colourless, often biguttulate,  $7.2$  to  $8.5 \times 2.7$  to  $3.4\mu$ . Hawkesbury River, June 1913; Leura, October 1914.

*Hymenogaster* ? sp.—We have a small reddish-brown species, pear-shaped and about  $\frac{1}{3}$  in. long, which has a well-marked sterile base and very finely warted (oil immersion lens) oval brown spores. These features seem to place it in the genus *Hymenogaster*. The substance is minutely cellular and of a pallid cinnamon tint, the peridium is quite smooth with no attached fibrils and the spores are oval,  $8.5$  to  $10.4 \times 7\mu$ , very finely warted. Sydney district.

*Hydnangium brisbanensis*.—We have taken this species on several occasions. The gleba is very pale, size up to  $\frac{3}{4}$  in. long, and the spores spherical or subspherical, almost colourless,  $7.2$  to  $10.4\mu$ , with an apiculus, and sometimes very distantly warted, sometimes more closely warted. Neutral Bay and Roseville, Sydney (June), Hawkesbury River (July), Terrigal (June, 1914).

*Hydnangium tasmanicum* (?)—Our specimen is placed doubtfully under this heading. There is no sterile base and the spores are warted. Our spores are oval, however, and the spores of *H. tasmanicum* are given in Cooke as globose. Specimen irregular, about  $\frac{1}{4}$  in. diameter, when fresh covered with a powdery whitish to brownish bloom, tending to split irregularly above, on section dark cinnamon, minutely areolate. Spores oval,  $14 \times 9\mu$ , brown,

flask-shaped, surrounded by a coarsely granular thick epispore (?) which appears to be easily removable. On the ground, Parramatta, July 1912.

## ASCOMYCETES.

*Morchella conica*.—Cambage<sup>1</sup> has recorded this morel for the Pinnacle Mountain, in the Forbes district of this State. He states that this and similar species of fungi were known to the natives by the name of 'merl,' which, if an Antochthonous word is strangely like the English 'morel.' Other New South Wales records are:—Tamworth (*loc. cit.*, 1896, p. 503), and near Grenfell and Coonabarabran (*loc. cit.*, 1909, p. 413). We have a specimen from Berowra Creek, Hawkesbury River (Darnell Smith), Sep. 1914. Asci  $260 \times 17.5\mu$ . Spores  $20.7$  to  $22.5 \times 12\mu$ .

---

<sup>1</sup> Proc. Linn. Soc. N.S.W., 1901, p. 691.

## A NEW CROTON FROM NEW SOUTH WALES.

By R. T. BAKER, F.L.S.,

Curator, Technological Museum, Sydney.

[Read before the Royal Society of N. S. Wales, December 2, 1914.]

## CROTON MAIDENI, sp. nov.

*Systematic*.—A bushy shrub from seven to nine feet high; diameter of largest known tree one and three-quarters to two inches, inflorescence and underside of the leaves silvery-white, with close stellate tomentum; terminal branchlets mostly quadchotomous, only occasionally trichotomous. Leaves alternate, only in a few instances opposite, small, narrow, lanceolate, one to one and a half, rarely two inches long, one-eighth to one-quarter of an inch wide, on a petiole mostly under two, rarely three lines long, occasionally with a few distant teeth, mostly entire, obtusely acuminate, shortly rounded and very slightly peltate; midrib on underside very prominent, veins quite obscured; glands at the top of the petiole very small; underside of leaf with a close silvery stellate tomentum, upper surface green with sparsely scattered, minute stellate hairs.

Racemes one to two inches long, flowers loosely disposed or distant, upper ones all males with one, two or three females at the base. Male calyx segments one line long, valvate, petals about the same length but half as broad; ciliate. Female calyx segments a little longer. Stamens nine to eleven. Styles three, divided into three or four branches of irregular length, and some bifurcated near the top. Capsule trilocular, rather larger than broad, about three lines long, with scattered stellate hairs. Seeds smooth or slightly muricate.

[Fruticosus 8' - 12' saltem, tenui, cortice laevi, aromaticissimo. Folia, lanceolata, longitudine 2 - 5 cm., latitudine 5 - 10 mm., varientia aut subcoriacea aut coriacea, supra glabrata pauca stellaripiti, ferrugina, subtus stellari-tomentella argentea; glandulae 2 basales sessiles minutissimae. Nerviae invisibilis. Ramuli tenues et petioli et rachis inflorescentiae, pilis stellaris. Calcyces, fem. accrescentes 1 - 3 in basi rachium, 5 lobae glabrae; ovarii parce stellari-pili; stylis 3 partitis lacinus gracilibus; capsulae 8 mm. longae 6 - 7 mm. latae tridymae, stellato-puberulae.]

*Habitat.*—The highest point between Angledool and Queensland border, known as "Guthrie's Mountain" (now Read's Mine). About twenty feet high above the black soil plains.

---

This *Croton* has quite a different facies from that of any described in the section given by Bentham in his "Flora Australiensis," VI, p. 124,—“leaves densely clothed on the underside with stellate silvery tomentosum.”

It differs amongst other points more especially from *C. Shultzii* and *C. insularis*, in its dwarf habit, stigmatic divisions and in its leaves. From *C. opponens* in the dispositions of its leaves, and from *C. phebalioides* in that it does not resemble a *Phebalium*. The leaves, bark and timber are quite distinct from that species, which now includes *C. stigmatosus*. It is a shrub and with whip-stick stem, as against the tree growth of that species. In *C. phebalioides* the basal glands of the leaf blade are much more prominent than in this species, which may be described as quite rudimentary, and only conspicuous with a pocket lens.

The leaf veins are quite obscured in the leaf texture and not penniveined as obtains in the two latter species, nor are the leaves membraneous. Systematically it might be placed between *C. phebalioides* and *C. opponens*.

A marked specific character is that the terminal branchlets are arranged quadrotomously, and occasionally trichotomously.

*Technology.*—(1) *Timber.* This is a very hard, close grained, even textured timber, of a very light colour, with a small dark or black ebony centre, otherwise it resembles “English Box,” *Buxus sempervirens*. It is a much harder wood than any Australian described *Croton*.

(2) *Bark.* This is the most aromatic portion of the tree, and “fresh specimens of wood with the bark on, when taken into a room, give a strong aromatic atmosphere, and odour approaching that of ‘chloroform,’ in fact almost overpowering if left in the room too long.”—A. Paddison. To me it is a far more pleasant odour than chloroform.

It is quite a distinct aroma from that of *C. phebalioides*. Mueller states, (Frag. IV, 14) that *C. phebalioides* exudes a resin, but diligent search amongst the known trees failed to discover any such substance in this tree.

In an aromatic classification of the whole genus, it might be placed with such exotic species as *C. aromaticus*, Linn., East Indies; *C. suaveolens*, Tarr., Mexico; *C. birmanicus*, Muell. Aug., Burma; three species containing an essential oil, out of about 450 species known for the Genus.

(3) *Leaves.*—These are also aromatic, and yield an essential oil with a pleasant odour. Mueller, (Fragmenta, IV, p. 140) records that *C. stigmatosus* now *C. phebalioides*, contains a pleasant aroma in its leaves, so that there are two species of this genus now in Australia possessing an essential oil in their leaves. Mr. H. G. Smith, who investigated the oil of this species, states:—The amount of leaves with branchlets was only 21 lbs., from which but three grams of oil were obtained, equal to 0·03 per cent. The crude oil was of an amber colour, had a terpene odour, with an indefinite secondary one. Cineol was not present.



The quantity of oil available was altogether too small to allow of a complete analysis but the following results were obtained with it :—

Specific gravity at 15° C. = 0·9291.

Rotation  $a_D = -15^\circ$

Refractive index at 24° = 1·4944

Insoluble in 10 volumes 80 per cent. alcohol, but soluble in 90 per cent. alcohol.

The absence of cineol, the slight solubility in alcohol, the high rotation and refractive index, suggest that the oil consists largely of non-oxygen bearing compounds, such as the terpenes and sesquiterpenes.

|| Mr. A. Paddison, who discovered this tree and had it under observation for many years, states :—“This is a very rare tree in the north-west of the State, or at least Angledool, and so far only seven trees have been seen. It is found growing in ‘Desert’ sandstone country . . . . . in circular depressions or ‘blows,’ (as they are known locally) on the tops or sides of our little ridges, carved out apparently by an explosion of gas in the sandstone. In fact, these are the only places in which I have found the tree growing. So far, I have not been able to obtain the aboriginal name of the tree.”

I am indebted to Professor Ewart for specimens of Mueller’s original *C. stigmatus*.

#### EXPLANATION OF PLATE XII.

1. Twig, showing inflorescence.
  2. Individual female (enlarged).
  3. Terminal branchlets with capsules.
-

## A NOTE ON DESERT SANDSTONE "BLOWS."

By A. PADDISON.

(Communicated by R. T. BAKER, F.L.S.)

---

[Read before the Royal Society of N. S. Wales, December 2, 1914.]

---

This peculiar geological formation known locally as "Blows" in the far north-west interior of New South Wales is described as follows by Mr. A. Paddison, who first noticed them in searching for precious opals.—[R.T.B.]

The 'Blows' usually occur around the 'brim' or edge of the flat-topped sandstone hills of the interior, although they are sometimes found down the slopes. I know a place near New Angledool, about four acres in extent, only about two feet above the surrounding level country literally covered with them. They are saucer-shaped, ranging from six to nine feet in diameter, the centre being about one foot below the level of the rim. The sandstone within and around them is always broken in fragments about the size of bricks. The edges being sharp, showing very little weathering.

A small shaft sunk in the centre of one of these 'Blows' revealed a small pipe or flue some four inches in diameter. The circumference of this flue was very smooth and as hard as a well-burnt brick. It was tolerably perpendicular and penetrated three feet six inches below the surface, where it joined a large fissure in the rock. The surface indicated plainly (in the writer's opinion) that a gaseous explosion had taken place in comparatively recent times, in a geological sense.

Opal of an exceptionally brilliant nature was found within a few feet of the pipe above described. The botanical species (*Croton Maidenii*, R.T.B.), only grows in such 'Blows.'

## EUDESMIN AND ITS DERIVATIVES, PART I.

By ROBERT ROBINSON, D.Sc.,

Professor of Organic Chemistry in the University of Sydney,  
and

HENRY G. SMITH, F.C.S.,

Assistant Curator of the Technological Museum.

---

[*Read before the Royal Society of N. S. Wales, December 2, 1914.*]

---

THE object of the present series of papers is to determine the constitution of naturally occurring substances of Australian origin, and eudesmin was chosen for the first investigation because it appeared to be a substance unlike any other which had been found in plants, and also because it may readily be prepared in considerable quantity. The compound was discovered by Maiden and Smith in 1895, (Proc. Roy. Soc. N.S.W.) during the course of an investigation on the kinos of the Eucalypts, and so far as has been determined, eudesmin occurs only in the kinos of trees belonging to the genus Eucalyptus. It does not, however, occur in the exudations of all the species, and certain regularities and correspondences with earlier classifications of these trees have been observed. The distribution of eudesmin in the kinos seems to follow roughly the predominant oil constituents, and, as these are connected with characteristic leaf venations, it may also be said that a connection exists between the leaf venation and the occurrence of eudesmin in the kino. The kinos of species of Eucalyptus which contain phellandrene as the predominant constituent in the oil, all give a violet colouration with ferric chloride in aqueous solution, and in none of them has eudesmin been detected. This group includes a large number of species growing in Eastern Australia, and may also be taken to include such species as *E. Risdoni*, in the oil of which cineol is a pronounced constituent but which

also contains abundance of phellandrene. Another group free from eudesmin comprises most of the pinene yielding species, which are, however, usually distinguished from the phellandrene group by the fact that their kinos contain aromadendrin. On the other hand eudesmin has been observed in many of the kinos of the cineol-pinene oil bearing species and probably occurs in all of them, but always in association with aromadendrin.

Probably not more than one-third of the known species of *Eucalyptus* growing in Eastern Australia have kinos which contain eudesmin, and in only a few of these does it occur in great amount. It is found in greatest abundance in the typical 'Boxes,' and the species employed for the preparation of the substance for the present research has been *Eucalyptus hemiphloia* which grows plentifully in the immediate neighbourhood of Sydney, and exudes a large amount of kino (sometimes in pieces the size of a hen's egg) which contains about 10 per cent. of eudesmin. The tannins of the group of kinos which contain eudesmin are catechol tannins, and eudesmin itself is a catechol derivative, whilst, on the other hand, the tannins of kinos not containing eudesmin are resorcinol or phloroglucin derivatives, and coupling together the above observations it appears that production of phellandrene in the oil is connected with production of metahydroxy phenols in the kino, whilst the cineol-pinene combination is associated with the production of catechol derivatives. On the very probable assumption that most of the constituents of plants are condensation, reduction, or oxidation products of carbohydrates, it may be stated with some confidence that the connection between the nature of the oil and the nature of the kino indicates some deep seated particular mode of condensation of the carbohydrate at an early stage, and, indeed, it is easy to see how stereochemical differences in aldohexoses could

give rise to the preferential production of either catechol or resorcin derivatives. This is an aspect of the chemistry of these trees which appeals to the authors as possessing great general significance, and we propose to follow up the investigation, and, to this end, a more detailed research into the constituents of Eucalyptus kinos is at present in progress.

#### **The Constitution of Eudesmin.**

The analytical data recorded in the experimental portion of the paper show that the substance is  $C_{22}H_{26}O_6$  and that it contains four methoxy groups. It is levo-rotatory and must, therefore, have one or more asymmetric carbon atoms. On treatment with nitric acid a dinitro-derivative is produced, and dichlor-, dibromo-, and diiodo eudesmins are as readily obtained by treating a glacial acetic acid solution of eudesmin with chlorine, bromine, and iodine monochloride respectively. These four substitution derivatives are all beautifully crystalline and their analyses confirm the formula assigned to eudesmin. The physical properties of these substances are similar to those of eudesmin, although, strange to say, the substitution of two hydrogen atoms in eudesmin by bromine, converts the levo-rotatory substance into a powerfully dextro-rotatory compound. On boiling with concentrated nitric acid eudesmin suffers simultaneous oxidation and nitration, and is converted into 4:5- dinitro-veratrol (I) a substance whose constitution has been completely proved. Moreover a quantitative determination showed that the amount of dinitroveratrol that can be obtained from a given quantity of eudesmin, is very much greater than that which is theoretically possible on the assumption that the molecule contains only one veratrol nucleus. Eudesmin contains, therefore, two veratrol nuclei, and the four methoxy groups are thus accounted for. The manner of connection of the veratrol nuclei to the rest of

the molecule follows from the following considerations:— In the first place the connection must be with carbon and not oxygen, for, otherwise, the production of dinitroveratrol would be impossible. This connection may involve either the position 4- or 4:5- (II), but dinitroveratrol would not be produced if carbon were attached to the position 3- (or 6-) of the veratrol ring. It is evident from the ready production of disubstitution derivatives that each nucleus is attached in one position only to carbon, and confirmation of this statement may be found in the production of 6- bromo- veratric acid, unmixed with any isomeride, by the oxidation of dibromo-eudesmin by means of potassium permanganate. It may also be pointed out that the constitution of dinitro-eudesmin is proved by its subsequent conversion to 4:5- dinitroveratrol on boiling with nitric acid. The veratrol nuclei both occur, therefore, in the state of combination indicated in (III).

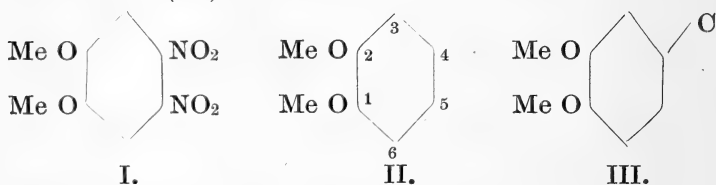

The formula of eudesmin may be written

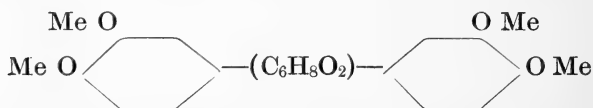

and its conversion to dinitroveratrol is represented in the scheme :

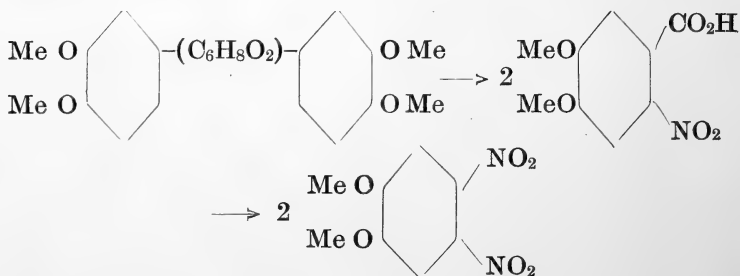

With regard to the central portion of the molecule the first point to notice is the function of the oxygen atoms. The negative experiments detailed in the experimental portion conclusively demonstrate the absence of hydroxyl or carbonyl groups. Both oxygen atoms have, therefore, ether function. The absence of ethylene linkages is also proved, and, if these conclusions be accepted as accurate, then an inspection of the above formula will show that this central portion of the molecule must contain two closed rings in order to account for the number of hydrogen atoms below the saturation capacity. Now there are six carbon atoms and two oxygen atoms, altogether eight atoms which could be members of a ring structure, and from this it follows that if the rings be separate the number of members in the two rings will be five and three or four and four—in either case a very improbable supposition. The rings are, therefore, fused as in naphthalene and the possible systems will then be seven fused with three, six with four, or five with five. The latter is clearly the most probable in view of the almost complete absence of three and four membered rings from natural products. The following formula indicates a probable constitution for eudesmin

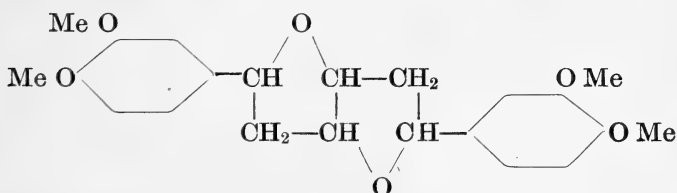

although there is no evidence for the position of the veratryl rests, and the following ring systems are alternatives to the one figured above:—

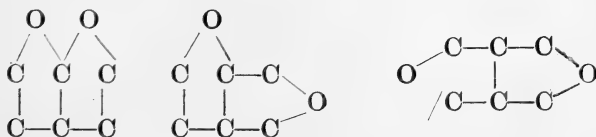





eudesmin quite readily, but in which aromadendrin is very sparingly soluble. The filtered chloroform solution was evaporated and the residue crystallised several times from methyl or ethyl alcohols or from ethyl acetate. The above process was adopted after many comparative experiments, and it is especially important to employ a thick aqueous solution of the kino for extraction. In this way the tannins are retained by the water and the formation of a troublesome emulsion, so readily produced by more dilute solutions, is avoided.

The following method of gravimetric determination of the eudesmin in eucalyptus kinos has been devised, and is now illustrated in the case of the kino of *Eucalyptus hemiphloia* :

The finely powdered kino (1 gram) was dissolved in 50 ccm. of water by heating, and the cooled solution extracted during several hours with chloroform (10 ccm.), the process being then repeated with another equal quantity of chloroform. After remaining during twenty-four hours the mixture had resolved itself into two layers; a colourless chloroform solution containing the eudesmin, and an aqueous liquid containing the tannins. At the junction of the two, a quantity of some insoluble substance was deposited. The chloroform was separated, and after removal of the solvent and heating to 105°, the weight of the residue was 0.1 gr. Since this residue consisted of almost pure eudesmin it is clear that the air dried kino of *Eucalyptus hemiphloia* (with 9.9% H<sub>2</sub>O) contains 10% eudesmin.

#### PROPERTIES OF EUDESMIN AND ANALYTICAL DATA.

Eudesmin is readily soluble in chloroform, benzene, acetic acid, and ethyl acetate, but sparingly so in cold methyl or ethyl alcohols and in ether. It also dissolves to some extent in boiling water and crystallises on cooling in slender needles. It is best crystallised from methyl alcohol and is

so obtained in colourless prismatic needles. When not quite pure, eudesmin occasionally crystallises in the form of leaflets. The melting point of pure eudesmin is  $107^\circ$  and although the molecule is large, small quantities of the substance may be distilled unchanged in vacuo. The substance is levo-rotatory and the following determinations have been made:—

1·3112 made up to 100 ccm. with chloroform at  $21^\circ$  gave

$$[a]_D = -64\cdot4^\circ$$

1·0022 made up to 10 ccm. with chloroform,

$$[a]_D = -64\cdot3^\circ$$

1·0834 made up to 10 ccm. with benzene,

$$[a]_D = -92\cdot3^\circ$$

1·0294 made up to 10 ccm. with acetic acid,

$$[a]_D = -73\cdot8^\circ$$

The first two determinations were made with distinct specimens of eudesmin and with different instruments, so that the rotation in chloroform is a physical constant, the determination of which will be of great value in proving the identity of eudesmin derived from different sources.

The following analyses of eudesmin have been performed: 0·1224 gave 0·3051  $\text{CO}_2$  and 0·0763  $\text{H}_2\text{O}$ . C = 68·0; H = 6·9. 0·1206 gave 0·3018  $\text{CO}_2$  and 0·0718  $\text{H}_2\text{O}$ . C = 68·2; H = 6·6. 0·1211 gave 0·3028  $\text{CO}_2$  and 0·0730  $\text{H}_2\text{O}$ . C = 68·2; H = 6·7.

1·1972 dissolved in 77·504 benzene gave a solution whose freezing point was  $193^\circ$  lower than that of benzene. Whence M.W. = 392.  $\text{C}_{22}\text{H}_{26}\text{O}_6$  requires C = 68·4, H = 6·7 per cent., and M.W. = 386.

The methoxy groups were determined by Zeisel's method: 0·1400 gave 0·3417 AgI. MeO = 32·2.  $\text{C}_{22}\text{H}_{26}\text{O}_6$  containing 4 MeO requires MeO = 32·1 per cent.

Eudesmin dissolves in sulphuric acid to a red solution which slowly becomes purple, this latter change is how-

ever prevented by the addition of veratrol and the colour obtained is then intense crimson lake. It is interesting to notice that a similar colour is produced when veratrol and glucose or cellulose are treated with concentrated sulphuric acid. With nitric acid eudesmin gives a pure yellow solution, from which, in course of time, a nitro derivative (dinitro. eudesmin, see below) separates in crystals. Since aromadendrin gives in nitric acid a fleeting green and then a red solution the progress of a separation of eudesmin and aromadendrin may be easily followed.

Eudesmin is unchanged by boiling alcoholic potash, by hydroxylamine, hydrazine and phenylhydrazine, and by semicarbazide in dilute acetic acid solution. It is also inactive towards acetylchloride, benzoyl chloride, phenyl isocyanate, and was recovered unchanged after being boiled during an hour with acetic anhydride and sodium acetate. It is clear, therefore, that it contains neither carbonyl nor hydroxyl. With an ethereal solution of magnesium methyl iodide a colourless precipitate is formed, but a few experiments showed that this is a common property of phenol ethers, and, for example, tetramethoxydihydroanthracene exhibits it almost in identically the same manner as eudesmin. It is more difficult to determine directly whether or not eudesmin contains ethylene linkages. It reduces potassium permanganate slowly in acetone solution, and is quickly attacked by bromine, but the reaction is one of substitution, and is accompanied by the production of hydrobromic acid, however little bromine is employed. The substitution derivatives described below are quite stable towards halogens, and eudesmin must, therefore, be saturated. Confirmation of this conclusion is obtained by studying the reduction of the substance since it was found that eudesmin is unchanged after treatment with a great excess of sodium amalgam in aqueous alcoholic solution, as also

by treatment with hydrogen in the presence of colloidal palladium. Eudesmin may be boiled with aniline without condensation and is recovered unchanged.

Cold aqueous hydrobromic acid dissolves it, but the solution soon clouds and an oil separates. At the same time a pink colour appears, and this is much increased if the liquid be heated. On the addition of water an almost colourless precipitate is obtained, but could not be crystallised. This substance contained bromine which was removed by means of alcoholic potash, without, however, altering the appearance of the substance. The bromine free product could also not be crystallised. When the aqueous hydrobromic acid solution was boiled and then diluted with water, the odour of guaiacol was very pronounced. On oxidation of eudesmin in the usual manner with potassium permanganate, a small quantity of veratric acid was isolated. There was also evidence of the presence of a phenyl glyoxylic acid, and when larger amounts of eudesmin are available, this oxidation will be studied in greater detail than has been possible hitherto.

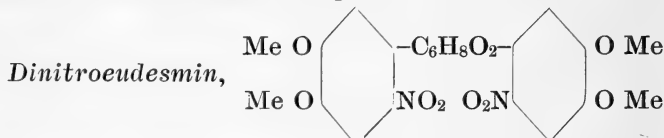

This nitro derivative is obtained by the action of nitric acid on eudesmin under almost any conditions in the cold. It is produced slowly when the reagent is 30% aqueous nitric acid, and is also the product obtained when cold concentrated nitric acid is allowed to react with eudesmin. The substance is a dinitro derivative but it was not found possible to prepare a mononitro or any higher nitro eudesmins by modifications of the conditions. The following method of preparation is most convenient:—

A solution of eudesmin (5 gr.) in acetic acid (25 ccm.) was carefully cooled under the tap and a mixture of nitric

acid ( $D = 1.42$ , 10 ccm.) and acetic acid (15 ccm.) gradually added. When all the nitric acid had been added, the nitro derivative crystallised from the solution, and, after five minutes, the mixture was diluted with water, the precipitate collected, washed with water, dried and crystallised first from acetic acid and then from ethyl acetate. The substance is, when freshly prepared, almost colourless and crystallises from all solvents in the form of extremely slender needles, which fill the whole solution. It melts without decomposition at  $214^{\circ}$ .

0.1275 gave 0.2608  $\text{CO}_2$  and 0.0582  $\text{H}_2\text{O}$ .  $C = 55.8$ ;  $H = 5.1$ .

0.1242 gave 5.9 ccm.  $\text{N}_2$  reduced to N.T.P.  $N = 6.0$ .

$\text{C}_{22}\text{H}_{24}\text{O}_6(\text{NO}_2)_2$  requires  $C = 55.5$ ,  $H = 5.0$ ,  $N = 5.9$  per cent.

Dinitroeldesmin turns yellow on exposure to light, and dissolves in sulphuric acid to a bright red solution. It is unchanged by treatment with nitric acid in the cold, and is perfectly stable to bromine in carbon disulphide solution. It is readily soluble in chloroform but sparingly so in other solvents, and remarkably sparingly soluble in alcohol. It may be easily reduced by means of tin and hydrochloric acid, but the corresponding amine is unstable and undergoes some decomposition in acid solution, which will be further investigated. The solution of the aminoeldesmin obtained by elimination of the tin with hydrogen sulphide gives a bright blue colour with ferric chloride, and exhibits the diazo reaction. The constitution of dinitroeldesmin as regards the position of the groups directly attached to the benzene nuclei is clearly proved by the experiment described in the next section.

SIMULTANEOUS OXIDATION AND NITRATION OF EUDESMIN;  
FORMATION OF 4:5—DINITROVERATROL.

Eudesmin (1 gr.) was boiled for ten minutes with ordinary concentrated nitric acid (10 ccm.) when the substance was oxidised and a large amount of nitrous fumes evolved. The

liquid was diluted with water and the precipitated solid crystalline substance separated and crystallised from methyl alcohol, and then again from ethyl alcohol. It was so obtained in pale yellow needles which melted at  $132^{\circ}$ , and at the same temperature when mixed with an equal quantity of 4:5-dinitroveratrol. The substance was further identified with 4:5-dinitroveratrol by a careful direct comparison, and by the preparation of a quinoxaline derivative by reduction and condensation with phenanthrenequinone in the usual manner. The nitric acid solution after separation of the dinitroveratrol was examined and found to contain oxalic acid.

This important experiment was performed quantitatively and it was found that the yield of dinitroveratrol was greater than the theoretical on the assumption that the molecule of eudesmin contains only one veratrol nucleus. It is, therefore, beyond question that eudesmin contains in its molecule two veratrol nuclei.

0.6451 gr. eudesmin gave by the above method 0.6926 gr. dinitroveratrol, perfectly dry but in the crude condition. This is a yield of 90 per cent. on the assumption that there are two veratrol nuclei. After crystallisation the amount of perfectly pure dinitroveratrol was 0.531 gr., a yield of 69 per cent.

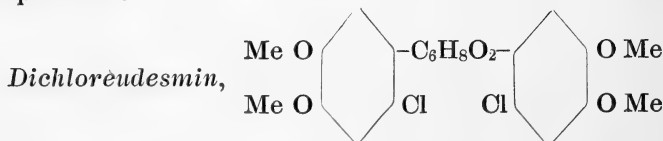

A slow stream of chlorine was passed through a well cooled solution of eudesmin (5 gr.) in acetic acid (50 ccm.) during half an hour. Hydrochloric acid was produced and a very sparingly soluble crystalline substance precipitated. After dilution with an equal volume of water, the solid was collected and crystallised, first from acetic acid

(needles), and then again from ethyl acetate until no change in the melting point could be observed. The colourless, rectangular plates melted at 163°.

0·1302 gave 0·0840 AgCl. Cl = 15·8

$C_{22}H_{24}O_6Cl_2$  requires Cl = 15·5 per cent.

This compound is stable to bromine in carbon disulphide solution, and dissolves in sulphuric acid to a red solution which very quickly becomes dirty brown red and then slowly dark green and green blue, finally the solution becomes almost colourless and a black precipitate is produced.

DIBROMEUDSMIN, (CONSTITUTION SIMILAR TO THAT SHOWN ABOVE FOR DICHLOREUDSMIN).

A solution of bromine (12 gr.) in acetic acid (55 ccm.) was added in the course of five minutes to eudesmin (5 gr.) in acetic acid (25 ccm.) any rise of temperature being checked by cooling in running water. After a further five minutes a dilute solution of sodium sulphite was added and the crystalline precipitate collected and recrystallised from ethyl acetate. Although this solvent was found to be the most satisfactory for the crystallisation of large amounts of this bromo derivative, yet, when it is used a slight pink tint of the crystals cannot be removed, and, for analysis, a portion was crystallised from glacial acetic acid and so obtained in the form of colourless prismatic needles which melt at 172°.

0·1778 gave 0·1233 AgBr. Br = 29·5

$C_{22}H_{24}O_6Br_2$  requires Br = 29·4 per cent.

This compound always crystallises in needles and is very sparingly soluble in most organic solvents, readily, however, in chloroform. Its specific rotation was accordingly determined in this solvent.

0·9182 made up to 25 ccm. with chloroform gave

$[a]_D^{22} = + 69·4^\circ$

The colour reaction with concentrated sulphuric acid was almost exactly the same as that described for dichlor-eudesmin (see above). Bromine in carbon disulphide solution leaves this substance unchanged under ordinary conditions, but, if a solution containing the bromo derivative and bromine is placed in a quartz vessel in the sunlight, reaction occurs and the bromine is very slowly absorbed. Even in this case, however, hydrobromic acid is produced and the action is evidently one of further substitution.

DIODOEUEDESMIN, (CONSTITUTION CORRESPONDING TO THAT OF DICHLOREUEDESMIN).

Iodine does not attack eudesmin, and in order to produce an iodo derivative, recourse was had to the action of iodine monochloride. The yield of this compound was, however, not so satisfactory as that of the chloro and bromo derivatives.

Eudesmin (5 gr.) dissolved in acetic acid (50 ccm.) was gradually treated with 50 ccm. of an acetic acid solution of iodine monochloride (containing 64 grs. ICl in 500 ccm. acetic acid) and the whole then heated on the steam bath during half an hour. The mixture was then treated with excess of aqueous sulphurous acid and the sticky residue dissolved in acetic acid. After standing overnight in the ice chest feathery needles were found to have separated, and these were collected and recrystallised from ethyl acetate. The colourless needles were sparingly soluble in organic solvents with the exception of chloroform and melted without decomposition at 175°.

0.1113 gave 0.0824 AgI. I = 40.0

$C_{22}H_{24}O_6I_2$  requires I = 39.8 per cent.

The substance is similar in most of its properties to the previously described bromo derivative, but, on treatment with nitric acid it loses its iodine as such. Iodine in the elementary condition is also observed as a momentarily



formed black precipitate on dissolving the diiodo derivative in concentrated sulphuric acid, when, however, a brown solution is quickly produced as the result of some further reaction.

OXIDATION OF DIBROMEUESMIN ; FORMATION OF 6-BROMO-  
VERATRIC ACID.

Dibromeudesmin (5 gr.) was dissolved in hot acetic acid and the solution poured into a large volume of cold water. The finely divided substance was collected, washed with water, and oxidised at about 50° with three per cent. aqueous potassium permanganate with continual shaking. The oxidation was very slow at first, but soon became more rapid, and was discontinued when the amount of unchanged substance became relatively small. This point was determined by means of tests made from time to time on a portion of the well stirred liquid, which was saturated with sulphur dioxide until the manganese precipitate dissolved. The excess of permanganate was destroyed by sulphurous acid and the liquid heated, filtered, concentrated to small bulk and acidified whilst hot with hydrochloric acid. On cooling, needles separated from the solution and these were recrystallised several times from hot water, the first solution being decolourised with the aid of animal charcoal. The colourless satiny needles melted at 184° and at the same temperature when mixed with an equal quantity of 6-bromoveratric acid which had been prepared by the hydrolysis of its methyl ester obtained by the bromination of methyl veratrate in acetic acid solution.

---

ON THE BUTYL ESTER OF BUTYRIC ACID OCCURRING  
IN SOME EUCALYPTUS OILS.

By HENRY G. SMITH, F.C.S.

Assistant Curator of the Technological Museum, Sydney.

---

[Read before the Royal Society of N. S. Wales, December 2, 1914.]

---

IN a paper by the Curator (Mr. R. T. Baker, F.L.S.) and myself, read before the British Association for the Advancement of Science when that body met in Sydney in August last, the announcement was made that a previously undescribed ester, with a low refractive index, occurred in some quantity in the oil of *Eucalyptus Perriniana*, collected both in Tasmania and in New South Wales, and that the presence of this ester in such quantity was one of the distinguishing features for this species when compared with the closely related one, *E. Gunnii*. Considerable work was done on these species with material collected at both localities, and it is evident from the results that these two Eucalypts are not identical.

It is the purpose of this paper to record the chemical results obtained with this ester, which is evidently a constant constituent in the oils of a certain class of Eucalypts, although in most cases occurring but in small amount. This is another instance of the peculiarity, so pronounced with chemical constituents in the genus *Eucalyptus*, namely a progressive increase throughout a whole series of closely agreeing forms until the maximum is reached in one of them. Not only is this the case with the oils, but with the exudations and other secretions also, the sequence running through a whole group being sometimes remarkably complete.

Butaldehyde, perhaps the parent substance of this ester, is present in most crude Eucalyptus oils, and is one of the constituents which give to unrectified oils a somewhat objectionable odour. The formation of the ester might perhaps be accounted for by a rearrangement in the aldehydic groups of two molecules of the butaldehyde. Normal butyric acid has already been identified as occurring in small quantity in several of these oils, and this acid was probably derived from the hydrolysis of the ester, because a corresponding change does take place when the oil of *E. Perriniana* has been stored for a sufficiently long time.

The material of *E. Perriniana* from which this oil was distilled, was collected at Tingiringi Mountain, southern New South Wales, in September, 1913. The crude oil was rich in eucalyptol, but phellandrene was not detected at this time of the year. The general characters of this oil agreed with those obtained with the material of the same species from Strickland, in Tasmania, collected July 1912. The analysis of the Tasmanian sample is recorded in a paper by Mr. Baker and myself, in Proc. Roy. Soc. Tasmania, October, 1912.

The abnormally low refractive index of the lower boiling fractions of the oil led to the determination of this ester, as so low a refractive index as 1.4538 at 16° C., in ordinary fractions, had not previously been detected in Eucalyptus oils.

#### Determination of the Acid.

The portion of 200 cc. of the crude oil distilling below 190° C., was boiled with aqueous potash under a reflex condenser for some hours. The aqueous portion was separated and distilled, but nothing came over below the boiling point of water, so that methyl, ethyl, and propyl alcohols were absent. The remainder was evaporated to dryness and the potassium salt decomposed by sulphuric acid and distilled

until all the volatile acid had come over. This had an odour of butyric acid strongly marked. The free acid in the distillate was exactly neutralised with barium hydrate solution, evaporated to dryness and heated in air bath to  $105^{\circ}$  C.

A molecular weight determination with this barium salt gave the following:—

0.3592 gram gave 0.2668 gram.  $\text{BaSO}_4 = 74.28$  per cent.

Barium butyrate gives theoretically 74.91 per cent.  $\text{BaSO}_4$ , so that most probably no other acid than butyric was present. The odour and other indications suggested the normal form for this acid, and the ethyl ester gave the characteristic pine-apple odour. To decide the point the calcium salt was prepared by decomposing the remainder of the barium salt with sulphuric acid, and distilling over the volatile acid. The distillate was exactly neutralised with freshly prepared and filtered lime water, using a trace of phenolphthalein as indicator. It was then carefully evaporated to a small bulk on the water bath until a portion of the solid salt separated, but this took up again when the liquid cooled. The precipitation was again brought about when heated in test tube, but this was also dissolved on cooling. It is thus apparent that the acid of this ester is normal butyric.

#### Determination of the Alcohol.

On distilling the oil separated after saponification, about 1.2 per cent. came over below  $150^{\circ}$  C. A trace of eucalyptol was present and perhaps a trace of pinene also. This portion was carefully oxidised with  $\text{K}_2\text{Cr}_2\text{O}_7 + \text{H}_2\text{SO}_4$ , by heating to boiling, and allowing to stand for twenty-four hours. A volatile acid with the odour of butyric was then readily detected, this was distilled over, filtered through wet paper, exactly neutralised with barium hydrate solution, and evaporated to dryness and heated in air oven.

The barium salt thus obtained was identical in odour and reactions with that from the acid of the ester. Although the amount of salt at disposal was small, yet, sufficient was obtained with which to make a quantitative determination for molecular weight.

0.0354 gram gave 0.0264 gram  $\text{BaSO}_4 = 74.58$  per cent.

Barium butyrate gives 74.91 per cent.  $\text{BaSO}_4$

It might reasonably be considered that as this ester is butyl-butyrate that both the alcohol and the acid are identical in form, and although sufficient acid from the alcohol was not available with which to prepare the calcium salt, yet, the odour of this acid, as well as that of its ethyl ester, was identical with those of the acid, and again corresponded with those given by pure normal butyric acid.

That the greater portion of the total ester in the oil of *E. Perriniana* is the low boiling butyl-butyrate is shown from the saponification results with the freshly distilled oil. The saponification number for the crude oil was 52.6, representing 13.52 per cent. of an ester having a molecular weight 144. The saponification number in the portion distilling below  $190^\circ\text{C}$ . (75 per cent.) was 57.2, representing 14.7 per cent. of ester in this fraction. The ester was not decomposed on direct distillation, no free acid being detected in the lower boiling fractions.

In future analyses of Eucalyptus oils from trees belonging to this class, it will be necessary to determine the ester value in the lower boiling fractions, particularly when the saponification number for the crude product is at all high.

When the identity of the ester in the oil of *E. Perriniana* from New South Wales had been determined, the amount of ester in the first fraction of the oil of this species from Tasmania was taken. This fraction—although investigated

over a year previously had fortunately been preserved—represented 18 per cent. of the crude oil distilling below 173° C. It contained, however, some free acid at this time, as a portion of the ester had hydrolysed. The saponification number for the ester and free acid in this fraction was 45·8. This result also shows the ester in the oil of *E. Perriniana* of Tasmania to be a low boiling one, and that the greater portion distilled over in the first fraction.

These chemical results support the botanical evidence that the trees growing both in Tasmania and on the mainland of Australia are the same species.

---

## NOTE ON THE ESTIMATION OF FAT IN FOOD FOR INFANTS.

By H. G. CHAPMAN, M.D.

(From the Laboratory of Physiology in the University of Sydney.)

[Read before the Royal Society of N. S. Wales, December 2, 1914.]

RECENTLY I analysed a food prepared for infants. The estimation of the fat led me into serious error. Special investigation was needed to obtain an accurate result. The composition of the food is indicated from the following data. It contained 2.25% of water. The quantity of nitrogen was 2.8% (2.79 and 2.81), of which 0.25% represented non-protein nitrogen. The percentage of ash was 3.55 (3.557 and 3.553). About 60% of the food consisted of carbohydrate of which about one-sixth was insoluble in alcohol (dextrins). At 45° C., 72.9% of the food dissolved in water and 67.6% was dissolved by boiling water so that 5.3% of protein was soluble at 45° C.

An attempt to estimate the fat was made by placing the dried powder in a thimble into a Soxhlet's apparatus and extracting it with dried ether free from alcohol. The results are given in Table I.

Table I.

No.	Weight of Dried Food in gms.	Weight of Fat extracted in gms.	Percentage of Fat in Food.
1	0.683	0.0514	7.40
2	0.7421	0.0575	7.57
3	0.829	0.0636	7.50
4	1.5198	0.1110	7.14

In order to be certain that the whole of the fat was extracted, the material was redried and again extracted

for twenty-four hours in the apparatus. Less than one milligram of fat was recovered. Later an extraction was made in a similar way of the contents of six different tins. The averaged result was 7.24% of fat, which agrees sufficiently with the averaged result of the figures in Table I, viz., 7.4%.

An estimation of the amount of fat extracted by petroleum ether was also made in the same way. The estimation gave 6.27% on the first extraction. Redried and extracted a second time, less than 0.02% of fat was obtained.

The fat was estimated also by the Röse-Gottlieb Method.<sup>1</sup>

The results are tabulated in Table II.

Table II.

No.	Weight of Food in gm.	Percentage of Fat.
1	1.4915	16.67
2	1.8895	16.75
3	1.9820	16.9
4	2.1660	17.0
5	2.6380	17.0

The figures show an averaged result of 16.85%. This figure is more than twice that obtained by the ordinarily employed method of extraction.

In order to determine whether the fats extracted by the two methods were identical, their saponification numbers were determined by Koettstorfer's process. The numbers obtained were 234 and 236 respectively. Both samples of fat contained a trace of nitrogen (under 0.1%) and yielded no weighable amount of ash on incineration.

To confirm the figures obtained by the wet process of Röse and Gottlieb, a weighed quantity of infants' food was

<sup>1</sup> Aberhalden, Arbeitsmethoden, Bd v., Abt. I, S. 432, Berlin u. Wien, 1911.



placed in a cylinder and mixed with 10 cc. water. The contents of the cylinder were washed on to filter paper, previously extracted with ether. The water was driven off at 90° C. The washing of the traces of undissolved food from the cylinder was a tedious process which occupied about two days. The dried filter paper was extracted with dry ether in a Soxhlet apparatus. The filter paper was redried and the extraction repeated. The results are recorded in Table III.

Table III.

No.	Weight of Food in gm.	Weight of Fat in gm.	Percentage of Fat.
1	0.7457	0.1310	17.5
2	1.4785	0.2152	14.5
3	4.368	0.3635	8.3

It will be seen that the fat is completely extracted when the quantity of food is less than 750 mg. Similar results were obtained by repeating the experiment. An attempt to vary the method by mixing the food with glass wool, moistening with water and drying, yielded only 9.87% of fat. The saponification number of the fat obtained by this method was 232. The fats obtained were thus all butter fats.

To elucidate the failure of the extraction by ether performed in the usual manner, two other foods for infants made by the same firm were subjected to analysis. Both these foods gave the same figures for fats by extraction with ether and by the process of Röse and Gottlieb.

The results are recorded in Table IV.

Table IV.

No.	Percentage of Fat on extraction.	Percentage of Fat, Röse-Gottlieb.
1	5.31	5.4
2	6.73	6.6

It is proposed to deal in a later paper with the physical cause of this peculiarity.

I beg to record my indebtedness to Professor Sir Thomas Anderson Stuart, in whose laboratory this research was undertaken, to W. M. Hamlet, Esq., for much valued criticism, to the Nestle and Anglo-Swiss Condensed Milk Company for the opportunity to make these investigations and to Mr. P. N. Woollett for much assistance in the conduct of these analyses.

---

STUDIES IN STATISTICAL REPRESENTATION, III.  
 CURVES, THEIR LOGARITHMIC HOMOLOGUES, AND ANTI-  
 LOGARITHMIC GENERATRICES; AS APPLIED TO  
 STATISTICAL DATA.

By G. H. KNIBBS, C.M.G., F.S.S., etc. and  
 F. W. BARFORD, M.A., A.I.A.

[*Read before the Royal Society of N. S. Wales, December 2, 1914.*]

SYNOPSIS.

1. Introduction.
2. Character of data.
3. Graphical Representation.
4. Principles governing adoption of particular curves.
5. Necessity for the adoption of equation with fractional indices.
6. The logarithmic homologue.
7. The antilogarithmic generatrix.
8. Logarithms of negative numbers.
9. Geometrical conventions for representing the logarithms of negative numbers.
10. Sine curves.
11. Parabolas and hyperbolas.
12. Exponential Curves.
13. Curves which are the product of parabolic or hyperbolic and exponential curves.
14. On a curve which is the sum of a series of parabolas, or of a series of hyperbolas, or both.
15. Graphs of Curves.

**1. Introduction.**—Physicists, engineers, actuaries and statisticians, frequently require to discover formulas which will represent, in the most simple and accurate way, groups of related facts. The work of Karl Pearson,<sup>1</sup> and W. Palin

---

<sup>1</sup> Phil. Trans. Biometrika and elsewhere.

Elderton<sup>1</sup> in statistical and actuarial fields, and of C. Runge<sup>2</sup> in connection with the application of the Fourier Series in physics, have done much to show how this task can be simplified. J. W. Mellor has given many valuable suggestions in his special work for students in chemistry and physics,<sup>3</sup> and elsewhere.

By way of further illustration it may also be pointed out that expressions of the type

$$y = a + bx + cx^2 + \text{etc} \dots \dots (1)$$

which have had an undue vogue in the formulae of physical chemistry, general physics, and engineering, are not always valid. Often a result could have been better represented by such an expression as

$$y = a + bx^n \dots \dots \dots (2)^4$$

where  $n$  is not necessarily, and generally is not, integral, and sometimes (2) will accurately represent a series of results and (1) will not.<sup>5</sup>

In such a case equation (1) is clearly inappropriate. For, forming new values of  $y$  by subtracting  $a$ , viz., the distance of the intersection of the curve with the axis of ordinates ( $x=0$ ) we have, through subtraction, a new series of values, viz.,  $y'$ , say, thus:— $y' = y - a = bx^n$

Hence, taking the logarithms of both sides

$$\log y' = \log b + n \log x \dots \dots \dots (3)$$

or,

$$\eta = \beta + n\xi \dots \dots \dots (4)$$

the *graph* of which, if  $\log y' (= \eta)$  be plotted as ordinates to the values of  $\log x (= \xi)$  as abscissae, is a *straight line* intersecting the  $\eta$ -axis at a point distant  $\beta (= \log b)$  from the origin, and making an angle with the  $\xi$ -axis whose tangent

<sup>1</sup> Frequency curves and correlation. <sup>2</sup> Zeitschrift für Mathematik and Physik, Bd. 48. <sup>3</sup> Higher Mathematics for Students of Chemistry and Physics. Longmans, London, 1905.

<sup>4</sup> For the solution of the constants of equations of this type see Section 10. hereinafter.

<sup>5</sup> As for example, the velocities of liquids flowing in pipes under different rates of fall in pressure.

is  $n$ , whereas the graph of

$$\log (y - a) = \log (bx + cx^2 + \text{etc.}) \dots\dots\dots(5)$$

is clearly *not* a straight line.<sup>1</sup>

For brevity  $\lambda$  may be used for log.

The data furnished by any series of observations whatsoever, susceptible of numerical expression, consist essentially of a series of quantities, the members of which stand in immediate relation to those of a series of other quantities. This relation may be expressed by

$$y = f(x, a, b, \text{etc.}) \dots\dots\dots(6)$$

The problems which arise will be (i) to ascertain the precise nature of the function through which  $y$  may be related to  $x$ , and (ii) the values of the associated constants  $a, b, \text{etc.}$  The independent variable is the *argument* of the function, the related dependent variable, the *value of the function* for that particular argument.

It will sometimes suffice to note merely that the points lie on some particular curve, *e.g.*, a straight line, circle, ellipse, parabola, a sine curve, a damped harmonic, etc.

**2. Character of Data**—The data for examination may be either *continuous*, as in the record of a self-registering gauge or apparatus (tide, barometric pressure, wind-velocity, automatic stress-strain, and indicator diagrams, may be cited as examples) in which case there is an *infinite* number of related values, or may be *discontinuous* viz., for a finite number of points only, as, where the values of  $y$  are observed for a *finite* number of values of the argument  $x$ . Or again, as frequently occurs in the field of statistic, the data may

---

<sup>1</sup> This was pointed out in an incidental way by St. Venant in 1850. Vide Comptes rendus, t. 31, pp. 283-286, 581, 583. He says:—On en acquiert facilement la conviction en prenant les logarithmes, ce qui donne  $(RI) = \log c + m \log U$  et en construisant deux suites des points . . . on voit que chacun de ces deux ensembles affecte une direction rectiligne . . . See also Prof. Karl Pearson, *Biometrika*, Vol. I, p. 266.

be *group-results*, that is to say, the ordinates may represent the total for a particular interval on the axis of abscissa, as for example the total number of persons in particular community between the ages of 0 and 5, 5 and 10, 10 and 15, etc. Strictly, in such cases, the results should be indicated graphically by rectangles standing upon these intervals of the abscissae as bases, though for special purposes they may be otherwise shewn. The form of the data may be numerical or graphical: the numerical may be convertible into graphical by drawing and the graphical into numerical by scaling.

**3. Graphical Representation.**—Since in a very large number of cases graphic methods are not only convenient but essential to the proper understanding of the possible precision of the relation, it will be indicated how numerical results can be graphically tested notwithstanding all difficulties as to the representation of large numbers on a limited scale. Poincaré's dictum that "It is unprofitable to require a greater degree of precision from calculated than from observed results, but one ought not to demand a less," may be accepted as a guiding principle.<sup>1</sup>

Graphic methods greatly facilitate the recognition of the type of function which best represents any given curve.

**4. Principle governing adoption of particular curves.**—Any curve represented graphically or indicated by a finite number of points, may be represented by an indefinitely large number of formulæ. The selection of a single formula should be guided by certain criteria which ordinarily depend upon two considerations, viz., (i) some rational view of the nature of the relation, *i.e.*, one independent of the mere mathematics of the question, and (ii) the method by which the relation may be most simply expressed mathematically. In regard to (ii), it may be remarked that critical values

---

<sup>1</sup> H. Poincaré, *Mécanique Celeste*, Paris, 1892.

such as the nature of the curve which represents  $f(x)$  when  $x = 0$  or  $\infty$ , etc., or when it is a maximum or minimum, will often decide its form. It may be evident, for example, from the nature of the case that  $y = 0$  for both  $x = 0$  and  $x = \infty$  for  $x = 0$ ; or again that  $y$  has some limiting value or values: in other words, that certain values of  $y$  cannot be exceeded, no matter what the value  $x$  may be. More succinctly we may say that a consideration of the value of  $y$  for critical values of the independent variable, and of the possibility of the existence of straight or curved asymptotes, will often afford the necessary guidance in the choice of the type of formula which would be found appropriate.

**5. Necessity for the adoption of equations with fractional indices.**—The unsatisfactory results arising from the use of inappropriate formulæ are, even yet, only imperfectly realised. Many expressions have been devised from time to time to meet particular cases and have had considerable vogue, notwithstanding that the results analysed could possibly have been more suitably and more accurately represented by a much simpler formula. This has been in the main owing to a somewhat remarkable habit of limiting rational algebraic expressions to forms containing only integral powers of the variable.

This limitation, self-imposed by mathematicians, arises merely from an inadequate conception of the synthesis of such expressions, seems entirely unnecessary, and in some cases to be illegitimate. For example, the expression  $x^{\frac{9}{10}}$  is usually considered as the tenth root of  $x^9$ , and thus the idea that only integral powers of  $x$  are quite admissible is implicitly maintained. That  $x^{\frac{9}{10}}$  may also represent, for example, a value through which the function  $x^n$  passes, as  $n$  increases continuously from 0 to 1, is often not sufficiently kept before the mind.

A simple geometrical illustration will shew even more clearly the inadequacy of an algebraic expression, from which fractional indices are rigidly excluded. Consider the family of curves  $y = x^n$  where  $n$  has different values. Suppose  $n$  to be positive and to have the values 0, 1, 2, 3. Then the graphs of the curves, following the *usual conventions*, are:—

$n = 0$ , a straight line parallel to and distant 1 from the axis of  $x$ , passing through 1st and 2nd quadrants.

$n = 1$ , a straight line bisecting the angle between the axes and passing through 1st and 3rd quadrants.

$n = 2$ , a parabola whose axis is the axis  $y$  and vertex the origin: passing through 1st and 2nd quadrants.

$n = 3$ , a cubic curve with a point of *inflexion* at the origin and passing through 1st and 3rd (not 2nd) quadrants. (The point of inflexion is also a minimum for one branch of the curve and a maximum for the other.)

The curves so obtained are thus wholly *dissimilar* when  $n$  is even and  $n$  is odd, that is, the graph region in the former case is quadrants 1 and 2, and in the latter quadrants 1 and 3. If, however,  $n$  be supposed to increase continuously from the value 0 and a series of curves be drawn,<sup>1</sup> which all pass through the origin, and also the point (1.1), a much clearer idea of the relationship of the curves of the family can be obtained. Thus in general we should expect the curves  $y = x^n$ ;  $= x^n + \delta^n$ ;  $= x^n + 2\delta^n$  = etc., when  $\delta n$  is very small, to occupy the same spatial positions approximately, that is to say  $x^{2.00001}$  and  $x^{2.00002}$  should be sensibly identical curves for all values of  $x$  positive or negative.

<sup>1</sup> See "Studies in Statistical Representation," by G. H. Knibbs, Journal Royal Soc., N.S.W., Vol. XLIV, p. 344, fig. 1.



**6. The logarithmic homologue.**—The analytic value of taking the logarithm of a quantity depends upon the fact that the operation converts the products of quantities into sums, and the powers of quantities into products. In general before the logarithm is taken the quantity to be operated on must be in the form of a product or a power. Thus if

$$y = B + Ce^{ax} \dots\dots\dots(7)$$

$B$  must if possible first be eliminated by some method other than mere subtraction of two values of  $y$  so that a new equation is obtained in the form,  $\lambda y'$  denoting  $\log y'$

$$y' = Ce^{\pm ax} \dots\dots\dots(8)$$

$$\lambda y' = \lambda C \pm ax, \text{ or say } \eta = \gamma \pm ax \dots\dots\dots(9)$$

since, using Napierian logarithms,  $\lambda e = 1$ . Thus the equation becomes linear: and this last expression may be said to be the logarithmic homologue of equation (8).

In some cases the expression of the form  $y = k \pm f(x)$  is manageable by approximation. Thus the above equation (7) may be written

$$y = Ce^{ax} (1 \pm \frac{B}{Ce^{ax}}) \dots\dots\dots(10)$$

hence 
$$\lambda y = \lambda (Ce^{ax}) + \lambda (1 \pm \frac{B}{Ce^{ax}}) \dots\dots\dots(11)$$

which may be quite satisfactory, if  $B$  be so small, that roughly approximate values of the denominator are sufficient, forasmuch as the expression is small. When the term in  $B$  is very small, it is sometimes convenient to calculate it by the formula

$$\lambda (1 \pm \beta) = \pm \beta - \frac{1}{2} \beta^2 + \frac{1}{3} \beta^3 - \text{etc.} \dots\dots\dots(12)$$

$\beta$  denoting  $B/Ce^{ax}$ .

Or yet again, when  $B$  has any value whatsoever, we may proceed in the following way:—

Take the values of  $y_1, y_2, y_3$ , corresponding to three points  $x, x + k$  and  $x + 2k$ : then we have identically, from (7)

$$\frac{y_3 - y_2}{y_2 - y_1} \equiv \frac{C [e^{a(x+2k)} - e^{a(x+k)}]}{C [e^{a(x+k)} - e^{ax}]} = e^{ak} \dots\dots\dots(13)$$

Hence, writing  $Y_{321}$  for the left-hand member and taking logarithms

$$ak \log_e e = \log_e Y_{321}, \text{ or } a = \frac{M \log_{10} Y_{321}}{k} \dots\dots\dots(14)$$

in which  $M$  is 2.30258509.....

When  $a$  is found the solutions for  $C$  and  $B$  are obvious. Should the left hand member of (13) be negative this curve is unsuitable.

It may be noted that, in general, if a quantity to be operated upon is not in the form of a product or a power it should be converted if possible into such a form. For example, in the equation

$$y^x = 8 \cos^4 a - 8 \cos^2 a + 1 = \cos 4a \dots\dots\dots(15)$$

the initial and final terms give

$$x = \frac{\log \cos 4a}{\log y} \dots\dots\dots(16)$$

though from the intermediate terms a solution cannot be directly obtained.

In expressions like (8)  $x$  may indifferently + or -, but in

$$y' = Ce^{\pm a \log x} \dots\dots\dots(17)$$

care has to be taken in respect to the interpretation of the logarithm of negative numbers; see §8 hereinafter.

**7. The antilogarithmic generatrix.**—What has been sometimes called the *antilogarithm* of a number, is that number the logarithm of which is the number in question. It is convenient, following the analogy of inverse trigonometric functions, to express this operation by prefixing  $\log^{-1}$  or  $\lambda^{-1}$  to the number. Thus, if  $\log y = \eta$ , then  $\log^{-1} \eta$  or  $\lambda^{-1} \eta = y$ . Thus, if  $\log f(x) = \eta$ , the curve  $y = f(x)$  may be called its *first anti-logarithmic generatrix*. For example, if

$$y = a + mx \dots\dots\dots(18)$$

these quantities actually being logarithms, then we have  $\lambda^{-1} y = \lambda^{-1}(a + mx) = (\lambda^{-1} a) (\lambda^{-1} mx) \equiv Y = AX^m = AM^x \dots (19)$  where  $\log Y = y$ ;  $\log A = a$ ;  $\log X = x$ ;  $\log M = m$ .

Again, if

$$Y' = AX^m + C = AM^x + C \dots\dots\dots(20)$$

$$\lambda^{-1}Y' = \lambda^{-1}(AX^m + C) = (\lambda^{-1}C)(\lambda^{-1}AX^m); \text{ etc.}$$

$$\equiv y = \mathfrak{C}e^{AX^m} = \mathfrak{C}e^{AM^x} = \mathfrak{C}\mathfrak{A}^{X^m} = \mathfrak{C}\mathfrak{A}^{M^x} \dots\dots\dots(21)$$

where  $\log y = Y'$ ; and  $\log \mathfrak{C} = C$ ,  $\log \mathfrak{A} = A$ ; etc.

This last curve may be called the *second anti-logarithmic generatrix* of  $y = a + mx$ , and if  $\mathfrak{C}$  be unity, the first anti-logarithmic generatrix of equation (20).

Provided its axes of reference are suitably determined, a curve therefore is the anti-logarithmic generatrix of its logarithmic homologue, and the logarithmic homologue of its anti-logarithmic generatrix.

It is important to observe that the logarithmic homologue depends not only upon the *form* of the curve, but also upon *its position with relation to the axes of reference*.

Similarly, if  $y = cx^a \dots\dots\dots(22)$

its anti-logarithmic generatrix is

$$Y = e^y = e^{cx^a} \dots\dots\dots(23)$$

where, therefore,  $\log Y = y$ : and so on.

**8. Logarithms of negative numbers.**—Since  $\log 0$ ,  $\log +1$ ,  $\log + \infty$  are respectively  $-\infty$ ,  $0$  and  $+\infty$ , the whole range of negative and positive real numbers is exhausted in expressing the logarithm of the numbers  $+0$  to  $+\infty$ . Moreover, with a positive number as base, no power, positive or negative, integral or fractional, can give a negative number. It is consequently usual to say that in general there can be no logarithm of a negative number. Any curve which may be represented by negative or positive numbers may therefore have an anti-logarithmic generatrix. We proceed to consider whether every curve can be said to have a logarithmic homologue.

Again, in order to follow out the matter a little more closely, consider the expressions

$$y = x^n; \text{ and } \log y = n \log x, \text{ or } \eta = n\xi.$$

For negative values of  $y$  it may be said that  $\log y$  or  $\eta$  is an impossible quantity, and therefore there can be no logarithmic homologue. Or again, if  $x$  be negative, there is similarly no logarithmic homologue since  $\log x$  or  $\xi$  is an impossible quantity. We can, however, conceive the matter thus:—Let us first suppose that the value of  $y$  is positive. Thus in Fig. 1 shewing  $\eta = n\xi$ , we have, if we plot the points  $P$  for various values of  $\xi$ ,  $n$  the tangent of  $\theta$ , or the angle of intersection of the line passing through the points and the axis  $Op^\infty$ . The point  $P$  of the logarithmic homologue corresponding to the value  $x$ , moves from  $P$

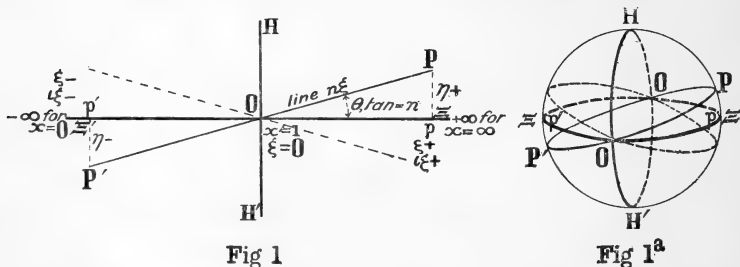

Fig 1

Fig 1<sup>a</sup>

to  $O$  as  $x$  changes from  $+\infty$  to  $+1$ ; from  $O$  to  $P'$  as  $x$  changes from  $+1$  to  $+0$ . As  $x$  changes from  $-0$  to  $-1$ ,  $P'$  moves on the inverted face of the same surface from  $P'$  to  $O$ , and finally as  $x$  changes from  $-1$  to  $-\infty$ ,  $P'$  moves on the inverted face of the line  $OP$ . Or representing the result on an infinitely great sphere—See Fig. 1a—we can call the face  $POP'$  the normal, and  $P'O'P$  the inverted face, (reaching the paradox that the logarithm of  $-\infty$  becomes the same as that of  $+\infty$ ) which is not only a matter of no moment but a difficulty that arises in other schemes of curve tracing.

Secondly, let us suppose that  $y$  is negative, that is, that  $-y = x^n$ . Then we have  $y = -(x^n)$  and the representation is as before. Or, again, we may suppose the representation to start at  $O'$  and it will be as shewn by fine dotted lines on Figs. 1 and 1a.

From what has been stated we see that as in the convention, by which so-called "imaginary" quantities can be represented as lying outside the space in which, for "real" quantities, the function in which they arise is representable, (e.g.,  $x\sqrt{-1}$  or  $xi$  represented as being at right angles to the  $x$  axis, or to an  $xy$ -plane, etc.) so can the logarithm of a negative number arising in an  $xy$ -plane be regarded as representable, say in the direction of the  $z$ -axis, or in some other way. This convention remains to be further examined.

Put  $z = -x$ , then  $y = z^n = (-x)^n$ ; and  $\log y = n \log z = n \log (-x)$ . We may also put, if necessary,  $\log -x = \log (-1) + \log (+x)$ . Similarly, if  $x = -0, -1$ , and  $-\infty$ , we may regard the logarithms as numerically equivalent to those of  $+0, +1$  and  $+\infty$  but spatially distinguishable therefrom by whatever may be implied by  $\log (-1)$ . It is possible to represent this spatial distribution by a bifacial line or surface, on which as a number passes through the values of  $0$  to  $-\infty$ , the corresponding values of the logarithms, of the number pass from  $-\infty$  to  $+\infty$  on one face, say the  $\iota$  face (inverted face); and when the number passes through the values  $0$  to  $+\infty$ , the logarithms of the number pass over the same range in the same manner, but on the normal face. Thus  $\log (-1) = \iota$  may be regarded as an operator inverting the line or surface on which the quantity is representable without numerically affecting it.<sup>1</sup> In this it is analogous to  $i = \sqrt{-1}$ .

We shall then have  $\log -1 = \iota \log 1$ ; and  $\iota (\log -1) = \iota \iota \log 1 = \log 1$ ; or putting a suffix to denote where the number of operations is even, viz.,  $p$  (*pair*), or odd  $i$  (*impair*),

$$\log_i (-1) = \iota \log 1; \log_p (-1) = \log 1 \dots \dots \dots (24)$$

<sup>1</sup> It would be well to retain the Greek letter  $\iota$  to denote this and analogous operators, and  $i$  to denote the operator  $\sqrt{-1}$ .

The values of logarithms, therefore, of negative numbers may be regarded as numerically equal to those of positive numbers, but *inverted* in reference to the space occupied by the positive numbers.<sup>1</sup> Hence the values, which may be differentiated by prefixing  $\iota$  thereto are not continuous with the logarithms of positive numbers, in an analogous way to that in which the values of  $y = \sqrt{x}$  are regarded as imaginary when the values of  $x$  are negative.

**9. Geometrical conventions for representing the logarithms of negative numbers.**—The matter may be looked at in two other ways. In Fig. 2 the “normal curve” represents the values of the logarithms of  $+x$ , and the “inverted curve” the values of the logarithms of  $-x$ . The latter may be regarded as an *inverted image* of the former.

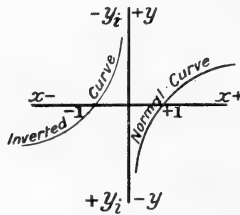

Fig 2

There is still another way of regarding the representation of  $\log -1$ .

Let  $\iota$  denote the operator which, when applied to  $\log 1$  converts it into  $\log -1$ . If the operator  $\iota$  is again applied to  $\log -1$ , we get  $\iota^2 \log -1$  or  $\iota^2 \log 1$ . If the nature of the operator  $\iota$  is such that  $\iota^2 = 1$  we are brought back again to our starting point which was  $\log 1$ .<sup>2</sup>

<sup>1</sup> Möbius was, we believe, the first to recognise that a simple type of surface can be *unifacial* and *unimarginal*. It has been suggested that the ordinary plane of projective geometry is *unifacial*. See Klein, *Math. Annalen*, Bd. VII, p. 549.

<sup>2</sup>  $\iota$  is not  $\iota^2$  but the operation of  $\iota$  upon  $\iota$ , that is the operation twice repeated.

Now, to convert the length 1 into  $-1$  a geometrical convention has been adopted that this may be done by two operations: the first being effected, it is in a position at right angles to the original position: the second operation again places it at right angles to the new position, and it is then in the negative direction as regards its first position: the first position is regarded as the geometrical representation of the operation denoted by  $i$  or  $\sqrt{-1}$ .<sup>1</sup>

This suggests the suitability of a similar convention for  $\log -1$ . Since  $\log 1 = 0$  we have to deal with a point instead of a straight line of unit length. Suppose a closed curve symmetrical with respect to the  $z$  axis, (a circle will do for simplicity) in a plane perpendicular to the  $xy$  plane, and with the origin as its lowest or highest point, according as the curve is above or below the plane. A point, moving round this closed curve from the origin, returns again to the origin after one complete circuit. The operator  $i$  signifies that it is in a new position, viz., that which it would have after passing through the angle  $\pi$ . This is consistent with the fact that  $i^2 = -1$ . As the origin represents  $\log 1$  we must have  $\log -1$  represented by the point attained in half a complete circuit: that is, it will be on the other extremity of the diameter, somewhere on the  $z$  axis.

Consequently, if  $\log 1$  be represented by the origin,  $\log -1$  may be represented by two points on the  $z$  axis equidistant from the  $xy$  plane, one above and one below. The convention may be extended so as to give the points a definite position. For, writing down the identity  $-1 = \cos \pi \pm i \sin \pi$  or  $-1 = e^{\pm \pi i}$  we see at once that the

<sup>1</sup> It is erroneous to say the operator  $i$  rotates a line through  $\frac{1}{2}\pi$ , because  $\frac{1}{2}i$  would be  $\frac{1}{4}\pi$  and  $2i$  would be  $\pi$ . Also, it may be argued that  $i^2$  is  $-1$ , not  $i^2$ , and therefore  $i$  is not really  $\sqrt{-1}$  except by a mere convention. The essence of the matter is that  $i$  is an operator, not a multiplier, and in the calculus of operations it is not established that  $\phi\phi$  is  $\phi^2$ , where  $\phi$  is any operation, though  $\phi^n$  may be used to denote  $\phi\phi\dots$  repeated to  $n$  times.

principal value of  $\text{Log } -1$  is  $\pm\pi i$ .  $\text{Log } -1$  is not, of course, the same as  $\log -1$ ,<sup>1</sup> but by analogy we may take along the  $z$  axis the two points whose distances from the  $xy$  plane are  $\pm\pi$ .

Lastly, since  $\log -x = \log x + \log -1$ , we see that if  $y = \log x$  represents a curve in the  $xy$ -plane then it follows that  $y = \log -x$  may be considered to be represented by one of two curves, homothetic with the first, lying in planes which are parallel to the  $xy$ -plane, and passing through the two points on the  $z$ -axis defined as above. This may be considered as a particular case of representation by means of a bi-facial surface already discussed. It is evident that, with care, the use of logarithms of negative numbers presents no insuperable difficulty.

**10. Sine curves.**—The simplest and most general form of the sine curve is

$$y = a_0 + a_1 \sin(x + \theta_1) + \dots + a_m \sin m(x + \theta_m) \dots \dots \dots (25)$$

Given a series of equidistant values of  $y$  the method of solving for the constants  $a_0, \dots, a_m$ , and for the epochal angles  $\theta_1, \dots, \theta_m$ , is dealt with in many mathematical treatises. Where *group-results* are given for successive equal stretches of the abscissæ, the necessary formulæ have been deduced and given in a paper on the "Statistical Applications of the Fourier Series."<sup>2</sup> Solutions are given for groups up to the number 12.

**11. Parabolas and hyperbolas.**—The general equation is

$$y = A + Bx^m \dots \dots \dots (26)$$

a parabola if  $m$  is positive, an hyperbola if  $m$  is negative.

The solution is obvious if  $A = 0$  for then

$$\log y = B + m \log x \dots \dots \dots (27)$$

<sup>1</sup> For the difference between  $\text{Log } -1$  and  $\log -1$  see Chrystal's Algebra, Part II, Ch. xxix.

<sup>2</sup> G. H. Knibbs, C.M.G., etc. Journ. Roy. Soc. N.S.W., Vol. XLV, pp. 76-110.



that is to say, if the equation be applicable to the representation of a series of points  $x_1, y_1, \dots, x_k, y_k$ , the logarithms of the coordinates will lie on a straight line.

If  $A$  be not zero the logarithmic homologue is not a straight line. To obtain the constants we must take three points on the curve the abscissæ of which are in geometrical ratio: that is, we must obtain the values of  $y_1, y_2, y_3$  for the abscissæ  $x_1, x_1k, x_1k^2$ .

Then we may write

$$\begin{aligned} y_1 &= a + bx^n = a + L \\ y_2 &= a + bx^n k^n = a + La, \text{ say, then} \\ y_3 &= a + bx^n k^{2n} = a + La^2. \end{aligned}$$

Consequently

$$\frac{y_3 - y_2}{y_2 - y_1} \equiv \frac{aL(a - 1)}{L(a - 1)} = a = k^n \dots\dots\dots(28)$$

that is,

$$n = \frac{\log(y_3 - y_2) - \log(y_2 - y_1)}{\log k} \dots\dots\dots(29)$$

When  $n$  is found, the constants  $a$  and  $b$  are readily determinable since  $x$  and  $k$  are also known.

For mean values we may proceed analogously to the method indicated in Section 12 hereinafter.

Equation (28) is unsuitable when the left hand member is negative. If not negative, then the curve is a parabola or hyperbola according as  $y_3 - y_2$  is greater or less than  $y_2 - y_1$ .

**12. Exponential curves.**—The general equation is

$$y = A + Be^{nx^p} \dots\dots\dots(30)$$

the logarithmic homologue of which, when  $A$  is 0, is

$$\log y = \log B + nx^p \log e \dots\dots\dots(31)$$

Hence if we take three ordinates whose abscissæ are in geometrical progression  $x, xk, xk^2$  ( $k$  being known) the following equation can be deduced:—

$$\frac{\log y_3 - \log y_2}{\log y_2 - \log y_1} = k^p \dots\dots\dots(32)$$

which determines  $p$  since  $k$  is known.

The constant  $n$  is determined by the equation

$$\log y_2 - y_1 = nx^p (k^p - 1) \log e \dots\dots\dots(33)$$

which gives  $n$  since all the other quantities are known.

Lastly  $B$  is obtained from the equation

$$\log B = \log y_1 - nx^p \log e \dots \dots\dots(34)$$

This is the solution when a single set of three points is taken. If it is required to approximately fit a large number of sets of points, the following method of obtaining the constants may be adopted.

Using  $Y_{21}$  as an abbreviation for  $\log y_2 - \log y_1$ , etc., we shall have

$$k^p = \frac{Y_{32}}{Y_{21}}$$

Calculating  $p$  from the geometric mean of  $s$  such sets of quantities the previous equation (32) becomes

$$k^{sp} = \frac{\prod_1^s Y_{32}}{\prod_1^s Y_{21}} \dots\dots\dots(35)$$

from which the mean value of  $p$  may be determined.

The value of  $n$  given by (33) may be written

$$n = \frac{Y_{21}}{x^p(k^p - 1) \log e} = \frac{Y_{32}}{x^p(k^{2p} - 1) \log e}$$

The mean value of  $n$  is consequently given by

$$n^s = \frac{\mu^s \prod_1^s Y_{21}}{\prod_1^s \{x^p(k^p - 1)\}} = \frac{\mu^s \prod_1^s Y_{32}}{\prod_1^s \{x^p(k^{2p} - 1)\}} \dots\dots\dots(36)^1$$

Lastly, the value of  $B$  was given by (34).

The mean value is given by

$$\log B = \frac{1}{3s} \left[ \sum_1^s \log (y_1 y_2 y_3) - Mn \sum_1^s \{x^p (k^{2p} + k^p + 1)\} \right] \dots\dots\dots(37)$$

In the case when  $A$ , however, is not 0, it will be necessary by graphic or difference methods to ascertain the value of  $y$  for the asymptotic line  $y = A$ . If this cannot be done the original equation is inappropriate.

<sup>1</sup>  $\mu$  is equal to unity for Napierian logarithms, and to 2.302585.....for common logarithms. The value of  $M$  in the last line is  $1/\mu$ .

**13. Curves which are the products of parabolic and exponential curves.**—The application and solution of a curve which is the product of the parabolic or hyperbolic and exponential curve, is dealt with in a paper entitled “On the Nature of the Curve

$$y = Ax^m e^{nx^p} \dots\dots\dots(38)^1$$

**14. On the curve which is the sum of a series of parabolas, or of a series of hyperbolas, or both.**—Consider the curve  $y = a + bx^p + cx^q + dx^r + \text{etc.}$ ....in which  $p, q, r, \text{etc.}$ , may be fractional. Since each term has greater fitting power than when restricted to an integral value of the index, it is obvious that the sum of several terms has also greater fitting power. Within the region of possibility if there be  $n$  indices, the curve will pass through  $2n + 1$  points, whereas if the indices are integers the curve will pass through  $n + 1$  points only.

It will be well to consider first the case where there are two terms in  $x$  only, that is, two indices  $p$  and  $q$  of which, let us suppose,  $q$  is the greater. By taking the origin on the curve the equation assumes the simpler form

$$y = bx^p + cx^q \dots\dots\dots(39)$$

and we shall primarily consider this case, viz., where  $a=0$ .

The determination of the constants may then be effected as follows:—Taking, as before, four ordinates whose abscissæ are in geometrical progression, viz.,  $x, xk, xk^2, xk^3$ , we have

$$\left. \begin{aligned} y_1 &= bx^p + cx^q & ; & \quad y_2 = bx^p \cdot k^p + cx^q \cdot k^q \\ y_3 &= bx^p \cdot k^{2p} + cx^q \cdot k^{2q} & ; & \quad y_4 = bx^p \cdot k^{3p} + cx^q \cdot k^{3q} \end{aligned} \right\} \dots\dots(40)$$

For  $bx^p$  write  $L$ ; and for  $cx^q$  write  $M$ : for  $k^p$  write  $\alpha$ ; and for  $k^q$  write  $\beta$ ; the four preceding equations (40) are then equivalent to

$$y_1 = L + M; \quad y_2 = L\alpha + M\beta; \quad y_3 = L\alpha^2 + M\beta^2; \quad y_4 = L\alpha^3 + M\beta^3 \dots(41)$$

---

<sup>1</sup> G. H. Knibbs, C.M.G., etc. Journ. Roy. Soc. N.S.W., Vol. XLIV, pp. 341-367.

The elimination of  $L$  and  $M$  from the first three of these last equations gives

$$\begin{vmatrix} 1 & 1 & y_1 \\ \alpha & \beta & y_2 \\ \alpha^2 & \beta^2 & y_3 \end{vmatrix} = 0 \dots\dots\dots(42)$$

And the elimination of  $L$  and  $M$  from the last three gives

$$\begin{vmatrix} \alpha & \beta & y_2 \\ \alpha^2 & \beta^2 & y_3 \\ \alpha^3 & \beta^3 & y_4 \end{vmatrix} = \begin{vmatrix} 1 & 1 & y_2 \\ \alpha & \beta & y_3 \\ \alpha^2 & \beta^2 & y_4 \end{vmatrix} = 0 \dots\dots\dots(43)$$

the second form being obtained by dividing the first column by  $\alpha$  and the second column by  $\beta$ .

From equation (42) is obtained the equation

$$y_3 - y_2(\alpha + \beta) + y_1\alpha\beta = 0 \dots\dots\dots(44)$$

and from equation (43) is obtained the equation

$$y_4 - y_3(\alpha + \beta) + y_2\alpha\beta = 0 \dots\dots\dots(45)$$

Also  $\alpha$  and  $\beta$  are the roots of

$$\xi^2 - \xi(\alpha + \beta) + \alpha\beta = 0 \dots\dots\dots(46)$$

Eliminating  $\alpha + \beta$  and  $\alpha\beta$  from (44), (45) and (46) it is evident that  $\alpha$  and  $\beta$  are the roots of the equation

$$\begin{vmatrix} 1 & y_1 & y_2 \\ \xi & y_2 & y_3 \\ \xi^2 & y_3 & y_4 \end{vmatrix} = 0 \dots\dots\dots(47)$$

Since  $\alpha$  and  $\beta$  are respectively  $k^p$  and  $k^q$ , this gives a formal solution for  $p$  and  $q$  since  $k$  is known. It must, however, be carefully examined. Since  $p$  and  $q$  are, in practical computations, restricted to real values, it follows that  $k^p$  and  $k^q$  must be real and positive. The equation (47) must therefore have real and positive roots. If written at length the equation takes the form

$$\xi^2(y_1y_3 - y_2^2) + \xi(y_2y_3 - y_1y_4) + (y_2y_4 - y_3^2) = 0 \dots\dots(47a)$$

The condition for real roots will be first investigated. The condition is

$$(y_2y_3 - y_1y_4)^2 - 4(y_1y_3 - y_2^2)(y_2y_4 - y_3^2) > 0; \text{ or } y_4^2y_1^2 - 6y_1y_2y_3y_4 - 3y_2^2y_3^2 + 4y_1y_3^3 + 4y_4y_2^3 > 0.$$

This may be written in the form

$$y_4^2y_1^2 - 2y_4y_2(3y_1y_3 - 2y_2^2) + y_3^2(4y_1y_3 - 3y_2^2) > 0$$

$$\text{or } \left\{ y_4 y_1 - \frac{y_2}{y_1} (3 y_1 y_3 - 2 y_2^2) \right\}^2 - \frac{4 (y_2^2 - y_1 y_3)^3}{y_1^2} > 0.$$

This condition will be fulfilled if  $y_2^2 < y_1 y_3$ , for then the left hand side will be essentially positive.

If, however,  $y_2^2 > y_1 y_3$  then we must have

$$\left\{ y_4 y_1 - \frac{y_2}{y_1} (3 y_1 y_3 - 2 y_2^2) \right\}^2 > \frac{4 (y_2^2 - y_1 y_3)^3}{y_1^2}$$

that is,  $y_4 y_1 - \frac{y_2}{y_1} (3 y_1 y_3 - 2 y_2^2) > \frac{2 (y_2^2 - y_1 y_3)^{\frac{3}{2}}}{y_1}$  numerically, or in other words  $y_4$  cannot be between the values

$$\frac{y_2 (3 y_1 y_3 - 2 y_2^2) \pm 2 (y_2^2 - y_1 y_3)^{\frac{3}{2}}}{y_1^2} \dots\dots\dots(48)$$

The condition for real roots shews, therefore, that if  $y_2^2 > y_1 y_3$  there is a certain portion of the straight line whose distance from the axis of  $y$  (to which it is parallel) is  $k^2 x$  which cannot be cut by a curve of the form  $y = bx^p + cx^q$  when  $p$  and  $q$  are real. In other words, there is what may be termed an "impossible region" about any point in which no curve of this form cutting three other points can lie.

Reverting to the equation (47a) it has been seen that the roots must be not only real but positive. Consequently  $y_1 y_3 - y_2^2$  must have the same sign as  $y_2 y_4 - y_3^2$  and the opposite sign from  $y_2 y_3 - y_1 y_4$ . This still further limits the possible values of  $y_4$ .

It is of interest to note what happens when  $y_2^2 = y_1 y_3$ . In this case (47a) degenerates from a quadratic to a linear equation

$$\xi (y_2 y_3 - y_1 y_4) + (y_2 y_4 - y_3^2) = 0$$

Consequently  $k^p = \frac{y_3^2 - y_2 y_4}{y_2 y_3 - y_1 y_4} = \frac{y_3^2 - \sqrt{y_1 y_3} y_4}{y_3 \sqrt{y_1 y_3} - y_1 y_4}$   
 $= \frac{\sqrt{y_3} (y_3 \sqrt{y_3} - y_4 \sqrt{y_1})}{\sqrt{y_1} (y_3 \sqrt{y_3} - y_4 \sqrt{y_1})} = \frac{\sqrt{y_3}}{\sqrt{y_1}}$   
 $= \frac{\sqrt{y_1 y_3}}{y_1} = \frac{y_2}{y_1} = \frac{y_3}{y}$

In this case the curve degenerates into the curve  $y = bx^p$  and there is only one possible value for  $y_4$ , viz., the fourth term of the geometrical progression of which  $y_1, y_2$  and  $y_3$  are the first three terms. [Since  $y_1, y_2, y_3, y_4$  are in geometrical progression the expression  $\frac{y_3^3 - y_2 y_4}{y_2 y_3 - y_1 y_4}$  assumes the form  $\frac{0}{0}$  whose limiting value has been proved to be  $\frac{y_2}{y_1}$  or  $\frac{y_3}{y_2}$ ]

This limitation of the possible values for  $y_4$  can be illustrated by an example. Suppose that three points are taken whose abscissae are 1, 2 and 4 (and consequently in geometrical progression) and whose ordinates are 13.7, 22.4 and 24.0. It is required to find the limits for  $y_4$  when  $x = 8$ .

In this example  $k = 2$ , and  $2^p, 2^q$  are the roots of the equation

$$\begin{vmatrix} 1 & 13.7 & 22.4 \\ \xi & 22.4 & 24.0 \\ \xi^2 & 24.0 & y_4 \end{vmatrix} = 0$$

which when expanded becomes

$$172.96 \xi^2 - \xi (537.6 - 13.7 y_4) + (576 - 22.4 y_4) = 0 \dots (49)$$

In this example  $y_1 = 13.7$ ;  $y_2 = 22.4$ ;  $y_3 = 24.0$ ; consequently, referring to condition (48) already established,  $y_4$  cannot lie between the values  $\frac{-381.1 \pm 4548.9}{187.7}$  or say 22.2 and  $-26.28$ .

Also, since the roots of (47a) must be positive, it follows that  $576 - 22.4 y_4$  must be positive. Consequently either  $y_4$  is negative, or, if positive, cannot be greater than  $\frac{576}{22.4}$  say 25.7.

From these conditions it is evident that the positive values of  $y_4$  are limited to the region between 22.2 and 25.7. All negative values are admissible which are numerically greater than 26.28.

We now proceed to investigate the curve of three terms, viz.:—

$$y = bx^p + cx + dx$$

three indices being taken instead of two. Subject to some limitation this may be made to pass through six points besides the origin.

For the determination of the constants it will be necessary to take the six points so that the values of the abscissae will be in geometrical ratio, as with the four points in the preceding case. This gives then six equations which, analogously to the previous case, may be written:—

$$\begin{aligned} y_1 &= L + M + N \\ y_2 &= L\alpha + M\beta + N\gamma \\ y_3 &= L\alpha^2 + M\beta^2 + N\gamma^2 \\ &\dots \dots \dots \\ y_6 &= L\alpha^5 + M\beta^5 + N\gamma^5 \end{aligned}$$

By reasoning similar to that in the preceding case, it may then be established that  $\alpha, \beta, \gamma$ , are the roots of the equation

$$\begin{vmatrix} 1 & y_1 & y_2 & y_3 \\ \xi & y & y_3 & y_4 \\ \xi^2 & y_3 & y_4 & y_5 \\ \xi^3 & y_4 & y_5 & y_6 \end{vmatrix} = 0 \dots \dots \dots (50)$$

which may be expanded in the form

$$A_1 \xi^3 - 3 A_2 \xi^2 + 3 A_3 \xi - A_4 = 0 \dots \dots \dots (50a)$$

where  $A_1, -3A_2, 3A_3$  and  $-A_4$  are the minors respectively of  $x^3, x^2, x$ , and 1 in the determinant. The roots of this equation must be real and positive.

The condition that the roots should be positive is that  $A_1, A_2, A_3, A_4$  should have the same sign.

To examine the equation for real roots it must first be deprived of its second term. It then becomes

$$X^3 + 3 X (A_1 A_3 - A_2^2) + 3 A_2 (A_1 A_3 - A_2^2) + A_2^3 - A_1^2 A_4 = 0 \dots \dots \dots (51)$$

The equation  $y^3 + qy + r = 0$  will have its roots real and unequal if  $\left(\frac{r}{2}\right)^2 + \left(\frac{q}{3}\right)^3$  is negative. The condition becomes in this case

$$\left\{ \frac{3 A_2 (A_1 A_3 - A_2^2) + A_2^3 - A_1^2 A_4}{2} \right\}^2 + (A_1 A_3 - A_2^2)^3 \text{ is negative.}$$

Since the first term is essentially positive, it follows that  $A_1A_3 - A_2^2$  must be negative; that is,  $A_2^2 > A_1A_3$ .

The condition above propounded may be written as follows:—

$$\{2 A_2(A_1A_3 - A_2^2) + A_1(A_2A_3 - A_1A_4)\}^2 + 4 (A_1A_3 - A_2^2)^3 \dots\dots(52)$$

must be negative.

Writing  $\lambda$  for  $A_1A_3 - A_2^2$  and  $\mu$  for  $A_2A_3 - A_1A_4$  the above condition becomes finally that

$$A_1\{A_1\mu^2 + 4 A_2\lambda\mu + 4 A_3\lambda^2\} \text{ must be negative.}$$

This is the “irreducible case” in Cardan’s solution of the cubic.

When the equation contains the constant  $a$  we must have five points given on the curve and the computation becomes more tedious. We then proceed as follows:—

Adopting the same notation we have for the general expression

$$y_{m+1} = a + La^m + M\beta^m \dots\dots\dots(53)$$

Hence, writing  $L'$  for  $L(a-1)$ , and  $M'$  for  $M(\beta-1)$ , the general expression becomes

$$y_{m+2} - y_{m+1} = L'a^m + M'\beta^m \dots\dots\dots(54)$$

Consequently, as before,  $a$  and  $\beta$  are the roots of

$$\begin{vmatrix} 1 & y_2 - y_1 & y_3 - y_2 \\ \xi & y_3 - y_2 & y_4 - y_3 \\ \xi^2 & y_4 - y_3 & y_5 - y_4 \end{vmatrix} = 0 \dots\dots\dots(55)$$

Similarly, if we have three indices, viz.,  $p, q$  and  $r$ , we shall have

$$y_{m+1} = a + La^m + M\beta^m + R\gamma^m \dots\dots\dots(56)$$

which by subtraction reduces to

$$y_{m+2} - y_{m+1} = L'a^m + M'\beta^m + R'\gamma^m \dots\dots\dots(57)$$

so that  $a, \beta$  and  $\gamma$  are the roots of

$$\begin{vmatrix} 1 & y_2 - y_1 & y_3 - y_2 & y_4 - y_3 \\ \xi & y_3 - y_2 & y_4 - y_3 & y_5 - y_4 \\ \xi^2 & y_4 - y_3 & y_5 - y_4 & y_6 - y_5 \\ \xi^3 & y_5 - y_4 & y_6 - y_5 & y_7 - y_6 \end{vmatrix} = 0 \dots\dots\dots(58)$$



In this case we must have given seven values of  $y$ . Writing  $y_3, y_2, y_1$  and  $y_0$  for the minors of  $\xi^3, \xi^2, \xi$  and 1 in this determinant, the equation becomes

$$\xi^3 y_3 - \xi^2 y_2 + \xi y_1 - y_0 = 0 \dots \dots \dots (59)$$

**15. Graphs of curves.**—The graphs of some of the curves  $\pm bx^{-1} \mp x^1; \mp x^{-1} \pm cx^1 \dots \dots \dots$  Fig. 3.

A,  $x^{\pm n}$ ; B,  $x^n + x^{-n}$ ; C,  $(x^n + x^{-n})^{-1} \dots \dots \dots$  Fig. 4.

A,  $bx^{-1} + x^1$ ; B,  $x^{-1} + cx^1$ ; C,  $(bx^{-1} + x^1)^{-1}$ ; D,  $(x^{-1} + cx^1)^{-1} \dots \dots$  Fig. 5.

These give a sufficient indication of curves with two indices only, and are sufficient to indicate the utility of such formulæ as have been considered. It is obvious that

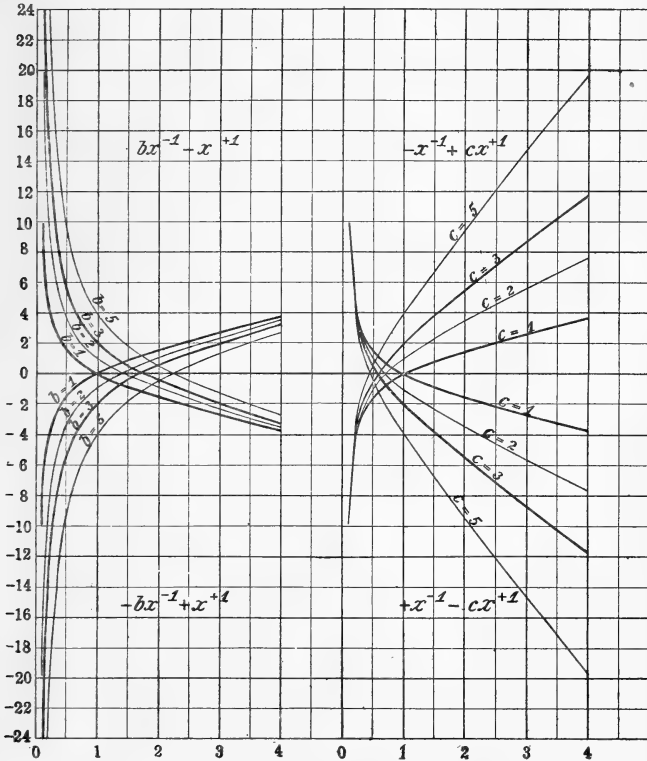

Fig. 3.

we may write equations which are the reciprocals of those considered, and by solving for values of  $1/y$  instead of  $y$ , obtain the required constants.

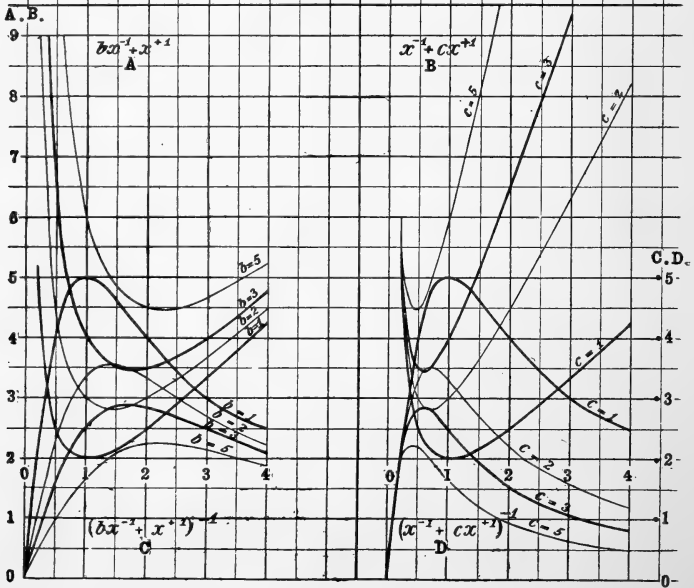
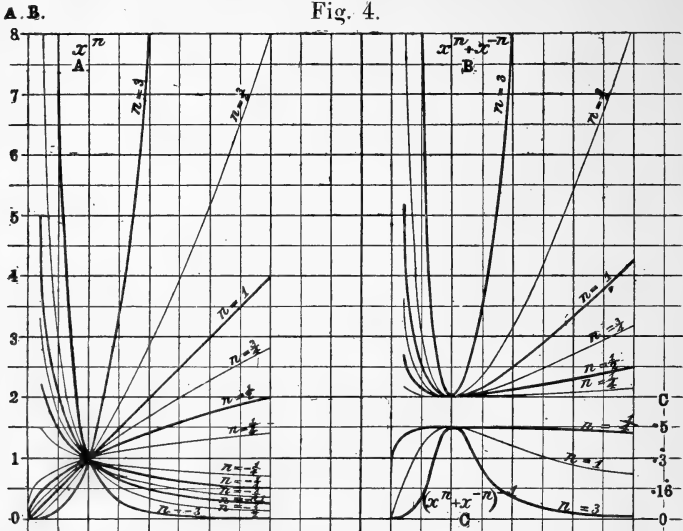

Fig. 5.

## THE DISTRIBUTION OF FRICTIONAL LOSSES IN INTERNAL COMBUSTION ENGINES.<sup>1</sup>

By E. P. TAYLOR, B.E.

(Communicated by Professor S. H. BARRACLOUGH.)

[*Read before the Royal Society of N. S. Wales, December 2, 1914.*]

1. *Introductory.*—Though a great deal has been published concerning the friction of steam engines, very little seems to have been written on the subject of Internal-Combustion Engine Friction. Apart from certain investigations carried out at the University of Sydney,<sup>2</sup> the writer could find no record of any attempt to separate the total friction of such an engine into its component parts; that is, the friction at the main bearings, connecting-rod bearings, piston, layshaft and valve gear, and the frictional resistance of the gas through the valves and passages.

An interesting account of experiments made on a 12 H.P. gas engine by Professor C. H. Robertson is given in the "Transactions of the American Society of Mechanical Engineers," 1902, Vol. xxiv. No attempt was made in this case to separate the component frictions, but from curves obtained it was shown how the total power lost in friction varied with different factors such as speed, power, tem-

---

<sup>1</sup> This research was carried out by the author in the Mechanical Engineering Laboratory of the University of Sydney during his tenure of Science Research Scholarship given by the Government of New South Wales, 1913-14. The author desires to record his great indebtedness to Professor S. H. Barraclough, for much valuable advice, and for the assistance rendered him by the Engineering Staff at the University, and particularly for the personal assistance of Mr. B. S. Dowling during part of the research.

<sup>2</sup> Report to the Engineering Seminar by Mr. W. J. Sachs, on the results of some experiments made on a 40 H.P. National Gas Engine.

perature, etc., and also how frictional resistance at the rubbing surfaces varied with the same factors.

The object of the present paper is to summarise the results of a series of experiments carried out on several internal combustion engines to determine the distribution of frictional losses in such engines under specified conditions; and further to describe certain useful modifications of methods and apparatus arrived at in the course of the investigation.

2. *The Retardation Method.*—To determine the distribution of friction in an engine the most convenient way, and, at the same time, one by which most accurate results can be obtained, is that known as the retardation method of determining engine friction.

This method was employed in the separation of friction losses in three engines at the P. N. Russell School of Engineering. The method is so generally known that only a brief description is necessary. When an engine is run up to speed, energy is stored up in the revolving masses. On removing the source of power the speed will gradually diminish owing to dissipation of the energy by a retarding torque set up by friction in the different sections of the machine.

The magnitude of this retarding torque can be determined when the negative acceleration and moment of inertia of the revolving masses are known.

Expressed algebraically

$$T_f = I \dot{\omega} = 2 \pi I n$$

where  $T_f$  = friction torque in lbs. ft.

$I$  = moment of inertia in lbs. ft. units.

$\dot{\omega}$  = retardation in radians per sec. per sec.

$n$  = retardation in revolutions per sec. per sec.

Measurement of the retardation may be made in a number of ways. The most suitable way for very accurate results is by means of a chronograph.

For these tests there was mounted on the main shaft of the engine, an electric contact maker of a special design, originally devised by Professors Dalby and Callender. Every revolution contact was made for an instant, this completed an electric circuit round a small electro-magnet actuating a stylus on the chronograph. A sheet of glazed paper wrapped round the cylinder of the chronograph, and smoked, served to take the record of the revolutions, as shown by a series of kicks in the line scratched on it by the stylus. The cylinder is made to revolve by clockwork at either of two speeds; a low speed which moves the paper at a peripheral speed of 1 cm. per sec., and a high speed of 10 cm. per sec. At the same time the stylus is fed along the cylinder at a pitch of about 8 mm. A retardation chart produced on this instrument shows a series of kicks at gradually and continuously-increasing intervals, as the speed of the engine falls.

In the appendix will be seen how velocity-time curves were obtained from these charts, and how from the curves, by drawing tangents at various points, the retardations in revolutions per second per second were obtained at speeds of the engine corresponding to the points on the curve at which the tangents were drawn. It was estimated that these retardations were measured with an accuracy of half per cent. when using the high speed of the chronograph, and between two and three per cent. when using the low speed.

3. *Determination of Moments of Inertia.*—To find the moment of inertia of the revolving masses was a serious difficulty in the early stages of the experiments, and a great deal of time was spent in developing a method of

making this determination with the degree of accuracy required.

Many methods of finding the moment of inertia of a body are available, but when the body is heavy and not readily removed from its bearings the number is practically narrowed down to the following.

Suppose a retardation test is run and from the chronograph there is obtained a certain value  $n_1$  for the retardation at a certain instant when the engine was revolving at  $N$  revolutions per second.

At this instant 
$$T_f = 2 \pi I n_1$$

Now if a second test be made, but this time with a known brake torque  $T_b$  applied to the engine shaft, the retardation at the instant when the speed is again  $N$  revolutions per second is greater than  $n_1$ , giving

$$T_f + T_b = 2 \pi I n_2$$

Assuming  $T_f$  to have remained unchanged, since both values are at the same speed, a combination of the two equations gives

$$T_b = 2 \pi I (n_2 - n_1)$$

or

$$I = \frac{T_b}{2 \pi (n_2 - n_1)}$$

All the values of the right-hand side of the equation are experimentally known; hence, the value of "I," the moment of inertia of the revolving masses, can be determined.

4. *Type of Brake employed.*—Too much stress cannot be laid on the necessity for a very carefully-designed brake by which this known brake torque is to be given to the engine. The tangential pull of the brake, and also the lever arm at which it acts on the shaft must each be capable of precise measurement. On this account brakes of the rope or band variety, which were at first tried, were

abandoned, and development took place in the use of an electro-magnetic shoe brake which attracted and attached itself to the rim of the flywheel.

Owing to the brake B, Fig. 1, being necessarily heavy, it was found best to balance its weight by a counterpoise C on the end of a lever L, so that a spring balance placed directly over the brake would show only the tangential wheel-pull on the brake. Increasing or decreasing the exciting current round the brake windings increased or decreased the pull on the brake.

Controlled by a spring balance in this manner, however, the brake was very irregular in its action, and values for "I" could not be obtained with a probable error of less than 16%. But advantage was taken of the electro-magnetic brake to arrange an automatic control. Instead of counteracting the pull on the brake by a spring balance, a constant known weight W was hung on the other end of the lever, as well as the counterpoise C already there. This weight W being at the same distance from the fulcrum of the lever L, as was the brake, gave directly the pull on the brake, and to keep the lever floating steadily in a horizontal position an electrode E was hung from the lever and dipped into water forming part of the electric circuit. Then, when the brake had a tendency to be pulled down, the other end of the lever would lift the electrode E so that less was immersed in the water; this weakened the excitation, and consequently the brake was allowed to rise again to the correct position. Another rheostat, operated by hand, was necessary in the circuit for preliminary adjustments, but during a run the automatic rheostat worked admirably. The brake pull by this means was able to be determined with an error of not more than one half per cent.

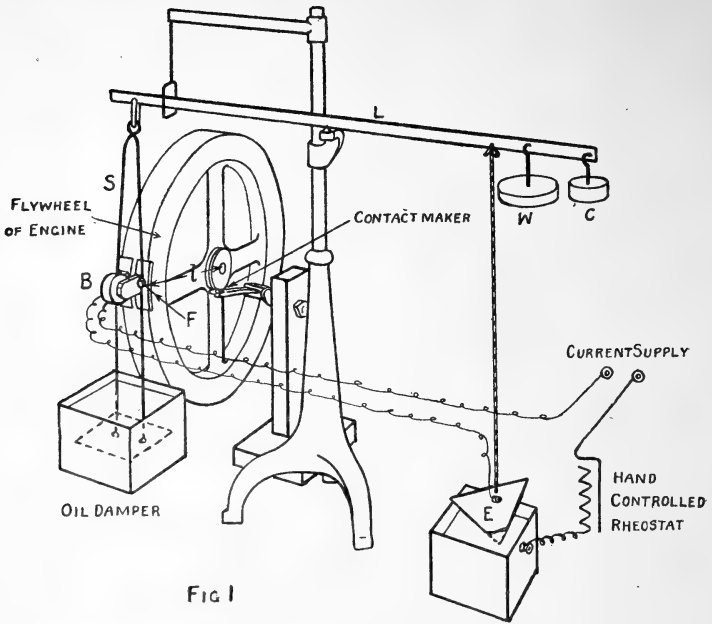

FIG 1

The pole faces of the shoe brake were curved to fit the rim of the wheel, and it was found necessary to connect the brake to the end of the lever by a suspension link S pivotted both at the lever and at F on the brake as close as possible to the centre of contact between the latter and the wheel. By this means it was ensured that the length  $l$  of the lever arm, at which the brake was producing a torque on the shaft, remained constant—provided the brake was allowed only a slight vertical movement. The height of the brake was, of course, so adjusted that the line joining the suspension pivot F and the centre of the shaft was horizontal. The lever arm length  $l$  was, therefore, equal to the radius of the wheel plus the distance from the periphery to the suspension F.

5. *Description of the Author's Method.*—The most important development in this brake retardation work was



the elimination of the necessity for assuming, as above, that  $T_f$  remains constant at the same speed in the two tests—the unbraked and the braked. Ordinarily in tests on engines where so many different places exist in which friction occurs,  $T_f$  was found to be far from constant, though every effort was made to run the tests under exactly the same conditions, and the resulting error in the determination of  $I$  was too large to be neglected.

Finally, the following scheme was arrived at. For the first part of a test a known brake torque was applied and a chronogram taken on the high-speed of the chronograph. After a sufficient interval the current was cut off the brake and for the remainder of the test the engine allowed to retard under its own friction alone. On drawing the corresponding velocity-time curve from this chart the curve was at first steep and then at the instant at which the brake was removed the curve became suddenly much less steep (Fig. 5, Appendix). Tangents drawn to the curve immediately on each side of this change point gave the retardations  $n_2$ , due to combined brake and friction torque, and  $n_1$ , due to friction torque alone, at obviously one and the same speed  $N$  at which the engine was revolving when the change was made, and equally certain is it that  $T_f$  had not changed. The estimated error in the value of  $I$  obtained in this way is from one to two per cent. This error was greatly reduced by taking the mean of many values of  $I$ .

6. *Distribution of the Friction Losses.*—Knowing “ $I$ ” for any one engine the amount of power lost in friction in the various parts of the engine can be determined by a process of elimination of the parts of the machine, a separate retardation test being run after each successive part is removed from the engine.

The general procedure was to run retardation tests when the engine was fully assembled at temperatures varying

from that of the atmosphere to figures above ordinary running temperatures. From these tests the total friction torque and friction horse-power were found at several speeds. Next, the big end of the connecting rod was disconnected so that a retardation test now would give a friction-power loss less than before by an amount equal to the power lost in friction of the piston, of both ends of the connecting rod and of the gas through ports. The flywheel, shaft and valve gear have in this case, of course, to be run up to speed by external means. Finally, the lay shaft was taken off so that now there remained only the main shaft in its bearings to cause any friction. The friction loss in this part of the engine was, therefore, got directly from the retardation test run when in this condition.

7. *Conditions of the Tests.*—It is convenient at this stage to call attention to what these friction losses actually represent, and to the conditions under which the results were obtained. All the tests were made under circumstances as nearly as possible representing usual running practice. This could be easily arranged as to temperature, lubrication and speed, but the circumstance of load on the rubbing surfaces could not be represented in the tests.

For instance, in the fully-assembled tests there necessarily could not be explosion pressure on the piston, with consequent increase in the piston thrust on the cylinder walls, and in the shaft and connecting-rod pressures. On this account the fully-assembled engine-friction-horse-power loss from a retardation test may not be the same as the no-load indicated horse-power as ordinarily obtained.

Again, after disconnecting the big end of the connecting rod the friction in the main-shaft bearings is no longer influenced by any pressure on the piston that would otherwise have been communicated to the shaft. Therefore, one cannot say that the friction measured at the main bearing is all that is generated there when fully assembled.

Further, two tests, in general, have to be made to determine the friction loss in any one part as, for instance, the valve gear. One test is made with the shaft and valve gear in place, and the other after the valve gear has been removed. The valve gear friction will be the difference between the friction losses found from the two tests, provided that the losses occurring in those parts that are present in both tests have remained altered. In order that this last condition be attained as nearly as possible, special care was taken to keep the lubrication of the engine constant. Separate tests made with varying rates of lubrication showed clearly how greatly the friction varied with the quantity of lubricant supplied to the different bearings.

Finally, the fact that the measurement of the friction loss of one part depends on the difference of two other measurements is in itself a possible source of error.

So much for the limitations of the retardation method as applied to measuring the distribution of friction in engines. In its favour there are several very striking points. From the fact of its being a retardation test, values of friction at any required speed may be obtained from one test.

The necessary apparatus is simple, easily applied and capable of performing highly accurate measurements for this class of work. It depends for none of its results on instruments needing previous calibration. There are no uncertain conditions to be allowed for, as there are for instance, in the case of a belt drive from a dynamometer. The engine, when run under the conditions ordinarily present in retardation tests, is left entirely to itself. An important advantage is the existence of a time-velocity curve drawn for each test. For the alteration in the slope of the curve shows at a glance how the coefficient of friction varies with the speed.

8. *Types of Engines tested.*—This research was carried out on three engines belonging to the Mechanical Engineering Laboratory plant. Most of the experiments were made on the smallest of the three—a 6-H.P. Victor Oil Engine of 6" bore and 8" stroke. There were two flywheels, one on each side of the engine, and the rotary mass had a moment of inertia of 17.6 feet lbs. units.

The engine was of the vertical enclosed-crankcase type with plain bush bearings lubricated by the splash in the crankcase running through holes in the upper part of the bearings. This crude method of oiling the bearings gave considerable trouble until it was decided to keep the bearings always flooded by hand feeding, giving a condition that could be repeated at any time. The necessary speed was attained by belt drive from an electric motor, the belt being simply run off the pulleys to commence a test. A record was kept of the temperatures of the main bearings and cylinder. This is an important point, for previous to this, tests made under apparently similar conditions often disagreed as to their results owing almost entirely to the temperature of the rubbing surfaces having altered.

The second engine to be tested was a 40-H.P. National Gas Engine of the usual horizontal four-stroke cycle type, —bore 11", stroke 19", and one large flywheel supported between one of the main bearings and an outside pedestal bearing. The moment of inertia of the rotating masses was 1940 ft. lbs. units. Directly coupled to the engine shaft by means of a leather-laced flexible coupling was a 25 K.W. generator.

The three engine main bearings and two generator bearings were normally well lubricated by ring lubricators; the piston and connecting rod by sight-feed drip lubricators. This method of oiling was found to give quite satisfactory service for the tests and so was retained unaltered. The

temperature of the cylinder only was observed as the bearings remained at practically the same temperature throughout.

For tests on the engine when fully assembled, the speed was attained by driving under gas in the ordinary way. After disconnecting the piston, etc., the generator was used as a motor to speed the engine up for the tests, though full speed could not quite be reached by this means.

By auxiliary tests on the generator alone, the friction loss in its bearings was determined and deducted from the results of the main tests.

Lastly, exactly similar experiments were made on a 30-H.P. Crossley Gas Engine of very much the same type as the National,—bore  $9\frac{1}{2}$ " stroke 18" and moment of inertia of flywheel, etc., 1070 ft. lb. units. Sight feed drip lubrication was relied on throughout.

The engine was arranged to drive a generator by means of a leather belt. This generator was used as a motor for driving the dismantled engine in a first series of tests made immediately after overhauling and reassembling. The friction of the main bearings came out extremely high, and so another series was made after a month or so of running in. In this later series the engine was run up to speed, when gas could not be used, by a friction drive from a small 3-H.P. electric motor acting directly on to the flywheel. A hand screw adjusted the friction pressure by moving the whole motor on a special sliding base.

9. *Procedure followed in each test.*—A somewhat detailed description of the work carried out on the National Gas engine will serve for the tests on all three engines.

- (a) Twelve runs were made with the engine when fully assembled—six of these were at different cylinder temperatures to find the effect of temperature on the friction of the piston.

- (b) The other six tests were made with a known brake torque applied to the flywheel for determination of the moment of inertia.
- (c) Six more runs were then made after removing the connecting rod and, consequently, the piston.
- (d) After the layshaft was removed, five more runs were made with the main bearings only left to produce friction.

And as each part was replaced on the engine, checking runs were made again.

The procedure in each test was to run the engine up above normal speed when possible, and then cut off the driving source, leaving the engine free to run down under only its own friction. This could be done only in the case of the Victor and Crossley engines. In the case of the National engine the relatively small extra friction due to the coupled generator was allowed for afterwards.

While the engine was slowing up, a contact maker on the engine shaft completed an electric circuit for an instant every revolution. In this circuit was a small electromagnetically-operated stylus which recorded on a smoked paper every revolution of the engine. The chart revolved at a regular rate so that the number of kicks in a certain length of chart gave a means of measuring the speed of the engine at any instant.

As a check, and also to facilitate the working out of the velocities, another stylus actuated every second from an independent clock, was caused to mark seconds just beside the revolution line. After fixing this smoked chart in a very weak solution of shellac, a velocity-time curve was drawn from it, and from this curve the retardation of the engine was determined at several speeds by drawing tangents at the points representing those speeds.

Having found the moment of inertia of the rotating masses by combined free and braked retardation tests, the torque producing retardation in the main tests, *i.e.*, the friction torque, was straight away calculated and also the friction loss at the given speeds.

The friction loss in Section (a) is the total loss in the whole engine and corresponds to the ordinary no-load losses of an engine, except for the special conditions stated in §7. Deducting from this the friction loss in Section (c) gave the loss due to the friction of the piston, both ends of the connecting rod and the gas friction through the ports, etc. These were separated by further tests, § 10.

On subtracting the results of (d) from (c) the friction loss of the valve gear becomes separated. Finally, the runs made under conditions (d) gave the main bearing friction directly.

10. *Measurement of Gas Friction.*—In order to isolate the friction losses due to piston, connecting rod and gas passage, some auxiliary experiments had to be performed, since the retardation method could not satisfactorily be used.

The best way to measure the power lost in forcing the gas through the valves and passages seemed to be by taking indicator cards. Accordingly cards were taken with the engine running under full compression, but not under power; *i.e.*, under exactly the same conditions as governed the retardation tests. The algebraic sum of the areas on the card enveloped during four strokes, or a complete cycle, will represent the net negative work. Such cards were taken at a range of speeds and the corresponding torque in each case was found. A curve was then drawn showing the variation of this equivalent torque with speed. By this means the results of the test were made comparable

with those of the retardation tests, and it was possible to isolate the value of the gas friction.

There remained, then, the separation of the friction at the connecting-rod bearings from the piston friction. For this purpose it was assumed that the proportion of the connecting-rod friction to the main-bearing friction would be as their respective areas. This assumption becomes more correct the nearer the lubrication of the surfaces becomes perfect.

11. *Statement of Results.*—A table of results shows this process of separation from first to last.

*Retardation Tests on 40 H.P. National Gas Engine.*

Ref. No.	Part of Machine.	R.P.S. N	Retardation n	Frict. Torque $T=2\pi In$	Frict. H.P. $=\frac{2\pi NT}{550}$	Distrib. of Friction per cent.
1	Engine fully assembled Full compression Cylinder temp. 125° F.	1	·0062			
		2	·0091			
		3	·0127			
2	Main bearings and valve gear (after unshipping con. rod) plus dynamo bearings.	1	·0014			
		2	·0021			
		3	·0027			
3	Main bearings and dynamo bearings.	1	·0013			
		2	·0019			
		3	·0025			
4	Dynamo bearings.	1	·0004			
		2	·0005			
		3	·0006			
5	Piston, connecting rod and "gas friction." (1) - (2)	1	·0048	58		
		2	·0070	85		
		3	·0100	122		
6	Main bearings only (3) - (4)	1	·0009	10	·114	15
		2	·0014	17	·39	16
		3	·0019	22	·75	15



*Retardation Tests on 40 H.P. National Gas Engine.—continued.*

Ref. No.	Part of Machine.	R.P.S. $N$	Retardation $n$	Frict. Torque $T=2\pi In$	Frict. H.P. $=\frac{2\pi}{550}NT$	Distrib. of Friction per cent.
7	Layshaft and valve gear (2) - (3)	1	·0001	1	·01	1
		2	·00015	2	·05	2
		3	·0002	3	·10	2
8	"Gas friction."	1	...	17	·20	25
		2	...	30	·67	39
		3	...	50	1·74	34
9	Connecting rod proportional to (6)	1	...	3	·03	4
		2	...	4	·10	4
		3	...	5	·20	4
10	Piston (5) - {(8) + (9)}	1	...	38	·40	55
		2	...	51	1·16	48
		3	...	67	2·30	45

The friction-horse-power losses are well shown by the curves drawn in Fig. 2. From these curves it is seen how rapidly the losses increase with increase in the speed of the engine. Especially is this so in the case of "Gas friction."

The equation of the total friction-horse-power curve may be taken as

$$F.H.P. = \cdot 8N^{\frac{5}{3}}$$

from which it is seen that the total horse-power lost at the the normal speed of the engine, 250 R.P.M., is 10·1 H.P.

Since the friction-horse-power depends on the two factors—resistance to motion and speed at which this resistance is overcome—the resistance must be proportional to  $N^{\frac{2}{3}}$ . This resistance is directly proportional to the coefficient of friction, since the pressure on the rubbing surfaces remains constant throughout the range of speeds. Therefore, the average coefficient of friction throughout the

whole machine varies as  $N^{\frac{2}{3}}$ .

The tests on the other two engines were carried out in very much the same manner, and therefore need no further description. A table comparing the per cent. distribution of friction in the three engines is given. Those values are compared in the table which were determined at the speed nearest to the normal running speed of each engine, though, as will be seen from the previous table, the relative distribution does not vary very much with variation in the speed.

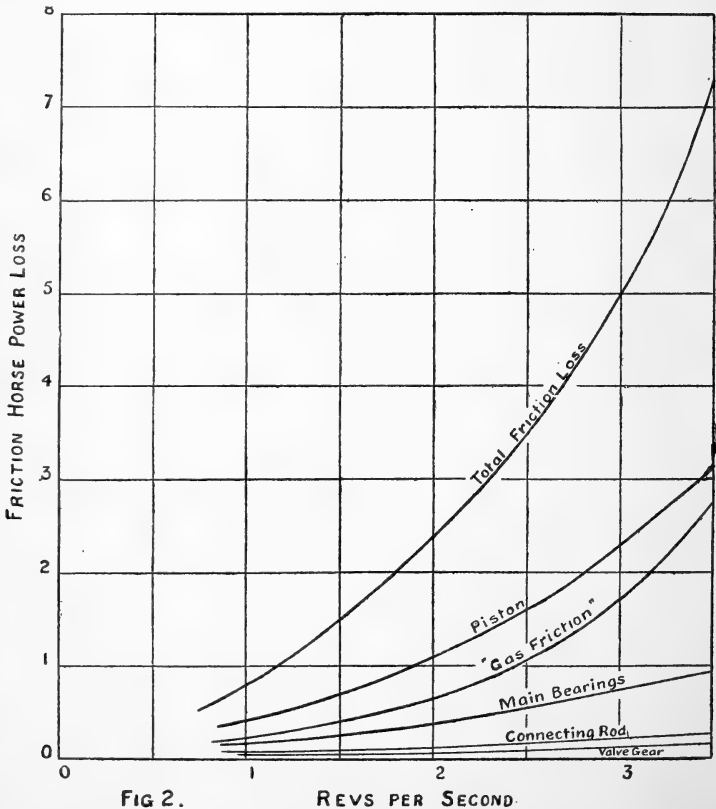

*Comparison of distribution of friction in three internal combustion engines.*

Part of Engine.	National 40 H.P.	Crossley 30 H.P.	Victor 6 H.P.
Main bearings ... * ...	15%	16%	11.5%
Lay shaft and valve gear ...	2	4	1.5
Gas friction ... ..	34	37	37
Connecting rod ... ..	4	3.5	5
Piston ... ..	45	40	45

From the last table it is seen that even with different types of engines there is such a general agreement in the percentage of friction allotted to each part of the engine that one is justified in drawing up a general table to show in round figures the average distribution of frictional losses in internal-combustion engines. Such a table is given below

*Distribution of friction in internal-combustion engines.*

Part of Engine.	Per Cent. Distribution.
Piston ... ..	45
Gas friction ... ..	35
Main bearings ... ..	14
Connecting rod ... ..	4
Lay shaft and valve gear ...	3

In concluding one might draw attention to the large loss under the title of "gas friction." From Fig. 2 is seen how rapidly this increases with the velocity of the engine, and conversely how greatly it is diminished by reducing the speed of the engine or, what comes to the same thing, the speed of the gas through the passages. It seems, therefore, that valves could, with advantage, be increased still more in size even at the risk of mechanical difficulties.

To sum up, the retardation method offers the advantages of accuracy and complete speed range with the disadvantage

that values of friction are obtained under special conditions. By careful attention to brake design and modification of the methods of running a brake retardation test, the probable error in a measurement of the moment of inertia was greatly reduced, and the final results are given in the form of a table showing approximately the relative distribution of friction in internal combustion engines.

### Appendix.

An idea of the kind of record produced on the chronograph, from which the retardations were calculated, may be gathered from Fig. 3. Each stylus when unexcited marks a straight line beside the other. But when the contact maker for an instant closes the circuit round one of them it is caused to move suddenly to one side and back again, thus making a "kick" in the line. These kicks were arranged to move across the other line in order the more conveniently to compare the intervals marked on one line with those on the other.

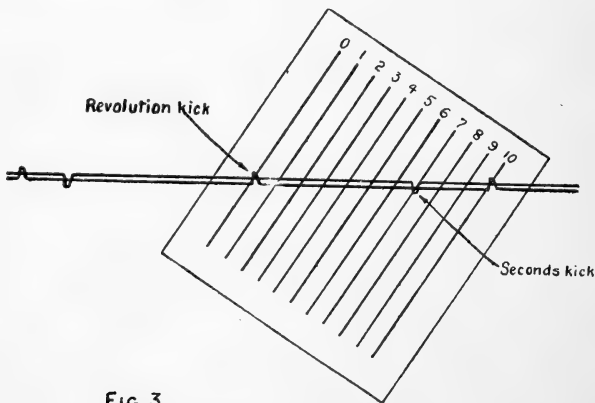

FIG 3.

When interpreting these records one of two methods was used, according to the length of the test. If the test lasted for more than about seven minutes, every thirtieth second was marked and the number of revolutions which occurred

during five seconds on each side of a mark was noted. One-tenth of this number was the revolutions per second at the time under consideration.

If the test took less than, say, seven minutes, the following procedure was adopted. The test was divided up into about twenty equal intervals—in the case of the brake runs this meant every two seconds—and the total revolutions up to each division noted. The velocity at the middle of interval was taken as the result of dividing by the number of the seconds the number of revolutions which occurred during the interval.

Very great accuracy in reading the records was required in the brake runs, and for the purpose of measuring the decimal parts of the revolutions use was made of the following simple device. A piece of unexposed but fixed photographic negative was marked by ten parallel equally-spaced lines. Placing this on the record in the manner shown in Fig. 3, it was easy to accurately read where the seconds mark divided the revolution space. In this way values of the angular velocity of the engine at certain intervals of time were obtained from the charts. These were shown graphically as a curve plotted to velocity and time co-ordinates.

A typical curve is shown in Fig. 4, drawn from one of the National engine test when fully assembled. Bearing in mind that coefficient of friction is proportional to frictional resistance—pressure remaining constant—and that resistance or friction torque is proportional to the retardation, it is evident that the behaviour of the coefficient of the engine friction may be seen at a glance from the slope of the curve in Fig. 4.

At high speeds the coefficient is comparatively great and decreases gradually as the speed falls, But when the speed becomes very low the coefficient rapidly increases

until at the instant of stopping it has increased to about ten times the value. This is evidently due to the lubricating film having broken down at these low speeds allowing an increasing degree of metallic contact.

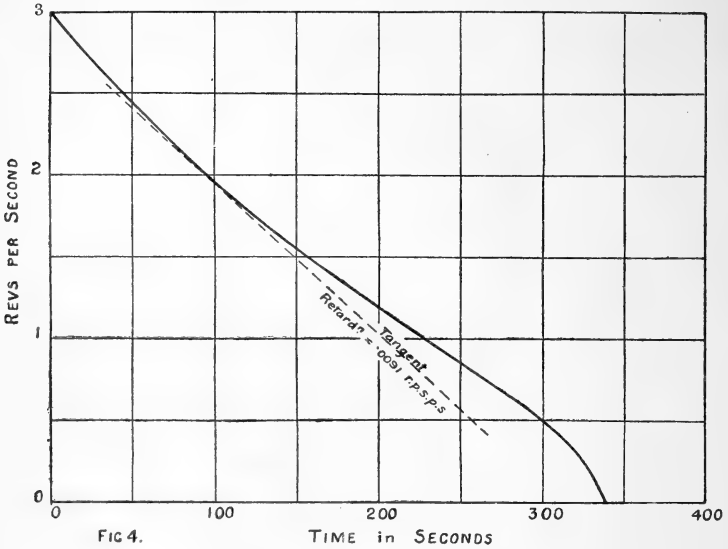

To find the negative acceleration or retardation at a particular instant, say, at a speed of two revolutions per second, a tangent, Fig. 4, was drawn to the velocity-time curve at this speed. The retardation was given by the value of the tangent expressed in the proper scale units; that is, the instantaneous change of velocity divided by the time during which the change took place.

As a description of calculating the moment of inertia of the engines, one case worked out for the National gas engine is here given. Fig. 5 shows one of the combined braked-free runs. This velocity-time curve was drawn from a chart taken with the high speed of the chronograph in gear. The scales of the curve are very open and consequently the curve is represented by two very-nearly straight lines.

The change in their slopes occurs at the instant the brake is released.

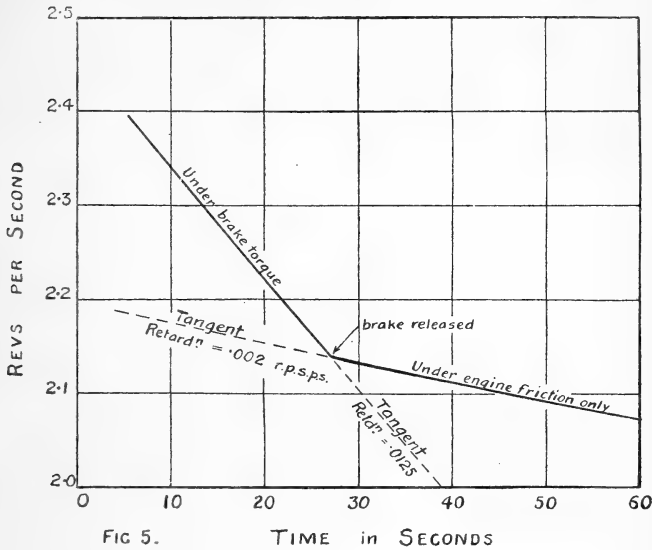

FIG 5. TIME in SECONDS

A tangent drawn to the upper curve at the change point gave a retardation of  $\cdot 0125$  revolutions per second per second, and another drawn to the lower curve made the retardation at the consecutive instant  $\cdot 002$ . The brake pull was  $33\cdot 6$  lbs. acting at a lever arm of  $3\cdot 8$  feet, therefore

$$I = \frac{33\cdot 6 \times 3\cdot 8}{2\pi (\cdot 0125 - \cdot 002)}$$

$$= 1950 \text{ ft. lb. units.}$$

## A NOTE ON THE PHENOLS OCCURRING IN SOME EUCALYPTUS OILS.

By ROBERT ROBINSON, D.Sc., and HENRY G. SMITH, F.C.S.

---

[Received January 19, 1915.]

---

So far as our knowledge goes phenolic bodies are absent in the greater portion of the essential oils of the various species of Eucalyptus, or, if occurring at all, are only present in very minute quantities, particularly in those usually found in commerce. In the oils of some species, however, phenols do occur, and it is the object of this note to record this fact. The chemistry of these bodies must be left for a subsequent paper.

In the oil of *E. linearis* of Tasmania a liquid phenol occurs in sufficient amount to enable its general characters to be determined, and as it does not appear to have been previously described we propose the name Tasmanol for it, as it appears to be most abundant in the oils of certain Tasmanian species, which, so far, are considered to be endemic in that island. Another species in which it occurs in fair amount is *E. Risdoni*.

The phenol was removed from the crude oil in the usual manner by shaking with aqueous sodium hydrate, washing the aqueous solution with ether to remove adhering oil, acidifying and extracting with ether. The residue, which contained a small amount of acetic and butyric acids, was washed with dilute sodium carbonate, extracted with ether, the ether removed and the phenol distilled. It boiled at 268 – 273° C. (uncor.) and at 175° under 25 mm. pressure. It was optically inactive, the specific gravity at 23° was 1.077, and the refractive index at 22° was 1.5269. Besides



being soluble in the alkalis the phenol is soluble in ammonia, partly soluble also in sodium carbonate but not in bi-carbonate. It also dissolves slightly in boiling water. The reaction with ferric chloride in alcoholic solution is characteristic, the deep red colour which is first formed remaining persistent for days, after the alcohol has evaporated. The odour reminds one somewhat of carvacrol under certain conditions. It contains one methoxy group and appears to have two phenolic groups in the para position to each other.

Tasmanol appears to be associated more with the cineol-phellandrene oils, but in the oils of certain species which do not contain phellandrene another phenol occurs, which, although probably allied with the other, is not identical with it, and may perhaps also be found to be a new substance. This phenol gives a green colour with ferric chloride in alcoholic solution, and is readily soluble in sodium carbonate, but not in bi-carbonate.

---





## CONTENTS.

	PAGE.
ART. XIII.—Continued ... ..	289
ART. XIV.—Notes on Tasmanian Hydrozoa. By E. A. BRIGGS, B.SC., Zoologist, Australian Museum, Sydney. (Communicated by C. HEDLEY, F.L.S., with the authority of the Trustees of the Australian Museum, Sydney.) [ <i>With Plates X, XI.</i> ] ...	302
ART. XV.—Notes on the Catalase Reaction of Milk. By H. B. TAYLOR, B.SC. (Communicated by Professor C. E. FAWSITT).	319
ART. XVI.—The Development and Distribution of the Natural Order Leguminosæ. By E. C. ANDREWS, B.A., F.G.S. ...	333
ART. XVII.—On the Recovery of Actinium and Ionium from the Olarly Ores. By S. RADCLIFF. ... ..	408
ART. XVIII.—The Hæmatozoa of Australian Batrachians, No. 2. By J. B. CLELAND, M.D. ( <i>Syd.</i> ) ... ..	412
ART. XIX.—Observations on some reputed Natural Eucalyptus Hybrids, together with descriptions of two new species. By J. H. MAIDEN, F.L.S. and R. H. CABBAGE, F.L.S. ... ..	415
ART. XX.—Notes on Eucalyptus, (with a description of a new species) No. 3. By J. H. MAIDEN, F.L.S. ... ..	423
ART. XXI.—Notes on Australian Fungi, No. 1. By J. B. CLELAND, M.D., ( <i>Syd.</i> ) and EDWIN CHEEL, Botanic Assistant, Botanic Gardens, Sydney... ..	433
ART. XXII.—A new Croton from N.S.W. By R. T. BAKER, F.L.S. [ <i>With Plate XII.</i> ] ... ..	444
ART. XXIII.—A Note on Desert Sandstone "Blows." By A. PADDISON. (Communicated by R. T. BAKER, F.L.S.) ... ..	448
ART. XXIV.—Eudesmin and its Derivatives, Part I. By Professor R. ROBINSON, D.SC., Professor of Organic Chemistry in the University of Sydney, and H. G. SMITH, F.C.S., Assistant Curator of the Technological Museum... ..	449
ART. XXV.—On the Butyl Ester of Butyric Acid occurring in some Eucalyptus Oils. By H. G. SMITH, F.C.S. ... ..	464
ART. XXVI.—Note on the Estimation of Fat in Food for Infants By H. G. CHAPMAN, M.D., M.S. ... ..	469
ART. XXVII.—Studies in Statistical Representation, III., Curves, their Logarithmic Homologues, and Anti-logarithmic Generatrices; as applied to Statistical Data. By G. H. KNIBBS, C.M.G., F.S.S., etc., and F. W. BARFORD, M.A., A.I.A... ..	473
ART. XXVIII.—The Distribution of Frictional Losses in Internal Combustion Engines. By E. P. TAYLOR, B.E. (Communi- cated by Prof. S. H. BARREACLOUGH) ... ..	497
ART. XXIX.—A note on the Phenols occurring in some Eucalyptus Oils. By R. ROBINSON, D.SC. and H. G. SMITH, F.C.S. ... ..	518

FINAL PART OF VOL. XLVIII.

ISSUED APRIL 19th, 1915.

Vol. XLVIII.

Part IV.

JOURNAL AND PROCEEDINGS

OF THE

ROYAL SOCIETY

OF

NEW SOUTH WALES

FOR

1914.

PART IV., (pp. (i) - (xxii), i - xxxiv.)

COMPLETING VOL. XLVIII.

Containing Abstract of Proceedings, Title Page, Contents,  
List of Publications, List of Members, etc., and Index.



SYDNEY:

PUBLISHED BY THE SOCIETY, 5 ELIZABETH STREET NORTH, SYDNEY.

LONDON AGENTS:

GEORGE ROBERTSON & Co., PROPRIETARY LIMITED,  
17 WARWICK SQUARE, PATERNOSTER ROW, LONDON, E.C.

1914.



---

---

# ABSTRACT OF PROCEEDINGS

---

---

НН—December 2, 1914.





ABSTRACT OF PROCEEDINGS  
OF THE  
**Royal Society of New South Wales.**

---

ABSTRACT OF PROCEEDINGS, MAY 6th, 1914.

The Annual Meeting, being the three hundred and sixty-fourth (364th) General Monthly Meeting of the Society, was held at the Society's House, 5 Elizabeth-street North, at 8 p.m.

Mr. H. G. SMITH, President, in the Chair.

Fifty-six members and three visitors were present.

The minutes of the General Monthly Meeting of the 3rd December, 1913, were read and confirmed.

The certificates of candidates for admission as ordinary members were read: two for the second, and four for the first time.

Dr. G. HARKER and Dr. C. ANDERSON, were appointed Scrutineers, and Mr. W. M. HAMLET deputed to preside at the Ballot Box.

The following gentlemen were duly elected ordinary members of the Society:—

ROBERT R. HOARE, Staff Paymaster, Royal Navy, Garden Island, Sydney.

JOHN SMITH PURDY, M.D., C.M., D.P.H., Metropolitan Medical Officer of Health, Town Hall, Sydney.

It was announced that the Council had awarded the Clarke Memorial Medal to ARTHUR SMITH WOODWARD, LL.D., F.R.S., Keeper of Geology, British Museum, (Natural History), London.

Professor W. H. BATESON, M.A., F.R.S., Director of the John Innes Horticultural Institution, England, and Professor J. P. HILL, D.Sc., F.R.S., Professor of Zoology, University College, London, were duly elected Honorary Members of the Society.

The receipt, during the recess, of 529 parts, 18 volumes, 21 reports, 8 maps and 2 catalogues was reported.

Letters were read from representatives of the late Mr. J. H. GOODLET and the late Dr. ALFRED RUSSEL WALLACE.

The President announced that a Special Meeting of the Society would be held on the evening of May 21st, when an address entitled "Napier and the Discovery of Logarithms" would be delivered by Professor H. S. CARSLAW.

It was also announced that a series of Popular Science Lectures would be delivered.

The Annual Financial Statement for the year ended 31st March, 1914, was submitted to members, and, on the motion of the Honorary Treasurer, Dr. H. G. CHAPMAN, seconded by Professor DAVID, was unanimously adopted:—

		RECEIPTS.			£ s. d.			£ s. d.		
To Cash in Bank on 1st April, 1913	...	...	...	...				77	3	8
„ Subscriptions	...	...	...	...	507	3	0			
„ Rents—										
Offices	...	...	...	276	15	0				
Hall and Library	...	...	...	350	12	0				
					627	7	0			
„ Sundry Receipts...	...	...	...	...	12	14	1			
								1147	4	1
„ Clarke Memorial Fund—										
Amount advanced to Building and Investment Fund	...	...	...	...	300	0	0			
Amount advanced to General Fund	...	...	...	...	155	0	0			
								455	0	0
„ Donation to Library (Dr. Quaife)	...	...	...	...				20	0	0
„ Building and Investment Fund Account— (Subscription for Life Membership)	...	...	...	...				21	0	0
„ Dr. Balance carried forward, viz:—										
Unpresented cheques	...	...	...	...	21	6	0			
Less:—Credit Balance at Bank	...	...	...	...	9	8	0			
								11	18	0
								£1732	5	9

ABSTRACT OF PROCEEDINGS.

v.

	PAYMENTS.	£	s.	d.	£	s.	d.
By Salaries and Wages—							
Office Salaries and Accountancy Fees ...	...	130	0	0			
Assistant Librarian... ..	...	121	0	0			
Caretaker ... ..	...	115	16	0			
					366	16	0
„ Printing, Stationery, Advertising, Stamps etc.							
Advertising ... ..	...	9	2	0			
Office Sundries ... ..	...	5	14	10			
Stamps and Telegrams ... ..	...	35	0	0			
Stationery ... ..	...	7	17	5			
					57	14	3
„ Rates, Taxes and Services—							
Electric Light ... ..	...	12	16	2			
Gas ... ..	...	6	7	8			
Insurance ... ..	...	18	7	1			
Rates ... ..	...	97	2	6			
Telephone ... ..	...	6	1	11			
					140	15	4
„ Printing and Publishing Society's Volume—							
Printing ... ..	...	163	2	3			
Blocks ... ..	...	2	3	9			
Freight, Charges and Packing ... ..	...	1	9	3			
					166	15	3
„ Library—							
Books and Periodicals ... ..	...	105	3	5			
Bookbinding... ..	...	62	2	7			
					167	6	0
By Sundry Expenses—							
Bank Charges and Exchange ... ..	...	0	11	6			
Repairs ... ..	...	8	15	9			
Lantern Operator ... ..	...	10	12	6			
Sundries ... ..	...	39	15	2			
					59	14	11
„ Interest on Mortgage ... ..	...	105	0	0			
Clarke Memorial Fund ... ..	...	13	4	0			
					118	4	0
„ Australasian Association for the Advancement of Science—On account of repayment of Loan					300	0	0
„ Clarke Memorial Fund—							
Instalment Refund to Building and Investment Fund ... ..	...	200	0	0			
Refund to General Fund ... ..	...	155	0	0			
					355	0	0
					<u>£1732</u>	<u>5</u>	<u>9</u>

Compiled from the books and accounts of the Royal Society of New South Wales and certified to be in accordance therewith.

(Signed) H. G. CHAPMAN, M.D., *Honorary Treasurer.*

W. PERCIVAL MINELL, F.C.P.A.

(*Auditor.*)

SYDNEY, 24TH APRIL, 1914.

## BUILDING AND INVESTMENT FUND.

					RECEIPTS.	£ s. d.				
To Loan on Mortgage from the A.A.A. Science—										
	Balance as at 31st March, 1913	...	...	...	2800	0	0			
„ General Fund—										
	Amount received to date	...	...	...	105	0	0			
	„ Amount received for Life Membership	...	...	...	21	0	0			
					<u>£2926</u>	<u>0</u>	<u>0</u>			
					PAYMENTS.			£ s. d.		
By A.A.A. Science—										
	Amount repaid to date	...	...	...	300	0	0			
„ Interest Account—										
	Amount paid to A.A.A. Science	...	...	...	105	0	0			
„ General Fund—										
	Amount paid to date	...	...	...	21	0	0			
	„ Balance owing on Loan to date	...	...	...	2500	0	0			
					<u>£2926</u>	<u>0</u>	<u>0</u>			

## CLARKE MEMORIAL FUND.

BALANCE SHEET, 31ST MARCH, 1914.

					LIABILITIES.					
					£	s.	d.	£	s.	d.
Accumulation Fund—										
	Amount at 31st March, 1913	...			551	10	4			
Additions during the year—										
	Interest Savings Bank	...	9	13	10					
	„ General Fund	...	13	4	0					
					<u>22</u>	<u>17</u>	<u>10</u>			
								<u>574</u>	<u>8</u>	<u>2</u>
					ASSETS.					
					£	s.	d.	£	s.	d.
Royal Society General Fund					...	...	...	400	0	0
Cash Deposited in Savings Bank of N. S. W.					164	6	0			
	„ Government Savings Bank				5	2	2			
	„ Commonwealth	„	„		5	0	0			
								<u>174</u>	<u>8</u>	<u>2</u>
								<u>£574</u>	<u>8</u>	<u>2</u>

STATEMENT OF RECEIPTS AND PAYMENTS, 31ST MARCH, 1914.

			RECEIPTS.			£	s.	d.	£	s.	d.
To Balance at 31st March, 1913—											
	Savings Bank of N.S.W.	... ..	211	2	11						
	Government Savings Bank	... ..	40	7	5						
			<hr/>						251	10	4
„ Interest to date—											
	Savings Bank of N.S.W.	... ..	9	13	10						
	Government Savings Bank	... ..	13	4	0						
			<hr/>						22	17	10
„ General Fund—											
	Amounts refunded to date...	... ..							355	0	0
									<hr/>		
									£629	8	2
									<hr/>		
			PAYMENTS.			£	s.	d.	£	s.	d.
By General Fund—											
	Advances to date	... ..							455	0	0
„ Balance at this date—											
	Savings Bank of N.S.W.	... ..	164	6	0						
	Government Savings Bank	... ..	5	2	2						
	Commonwealth Savings Bank	... ..	5	0	0						
			<hr/>						174	8	2
									<hr/>		
									£629	8	2
									<hr/>		

A report on the state of the Society's property and the following annual report of the Council were read:—

ANNUAL REPORT OF THE COUNCIL FOR THE YEAR 1913-14.  
(1st May to 30th April.)

The Council regrets to report the death of a very distinguished Honorary Member, ALFRED RUSSEL WALLACE, O.M., and the loss of seven ordinary members. Ten members have resigned. On the other hand, twenty-three new members have been elected during the year, which constitutes a record in the history of the Society.

To day (29th April, 1914) the roll of members stands at 313, and, considering the number of scientific and cognate societies in New South Wales, which meet special requirements, the number is a creditable one.

During the Society's year members have assembled as a body ten times.

There were eight monthly meetings, a meeting on the 17th of March to honour Dr. MAWSON on his return from Antarctica and the Annual Dinner at Farmer's Restaurant on the 24th of April, 1913. On this latter occasion the Society was honoured by the company of His Honour Sir W. P. CULLEN, K.C.M.G., LL.D., Chief Justice, and the Presidents of several Societies.

Eleven meetings of the Council were held.

Twenty-one papers were read at the ordinary monthly meetings and there were numerous exhibits.

Four Popular Science Lectures were given during the year, the titles being as follows:—

July 17—“*The Grand Cañon of Colorado and its Lessons*,”  
by Mr. E. C. ANDREWS, B.A., F.G.S.

August 21—“*The Evolution of Architectural Style*,” by Mr.  
JAMES NANGLE, F.R.A.S.

September 18—“*Alkali, Alkaloid, Alkohol*,” Mr. W. M.  
HAMLET, F.I.C., F.C.S.

October 16—“*Irrigation in India and in Egypt*,” by Pro-  
fessor W. H. WARREN, LL.D.

The President then delivered the Annual Address.

On the motion of Professor DAVID, seconded by Mr. HAMLET, a hearty vote of thanks was accorded to the retiring President for his valuable address.

Mr. SMITH briefly acknowledged the compliment.

There being no other nominations, the President declared the following gentlemen to be Officers and Council for the coming year:—

President :

C. HEDLEY, F.L.S.

Vice-Presidents :

F. H. QUAIFFE, M.A., M.D.

J. H. MAIDEN, F.L.S.

D. CARMENT, F.I.A., F.F.A.

HENRY G. SMITH, F.C.S.

Hon. Treasurer :

H. G. CHAPMAN, M.D.

**Hon. Secretaries:**

R. H. CAMBAGE, L.S., F.L.S. | Prof. POLLOCK, D.SC.

**Members of Council:**

J. B. CLELAND, M.D., CH.M.		W. M. HAMLET, F.I.C., F.C.S.
Prof. T. W. E. DAVID, C.M.G., B.A.,		T. H. HOUGHTON, M. INST. C.E.
W. S. DUN, [D.SC., F.R.S.]		J. NANGLE, F.R.A.S.
R. GREIG-SMITH, D.SC.		C. A. SUSSMILCH, F.G.S.
F. B. GUTHRIE, F.I.C., F.C.S.		H. D. WALSH, B.A.I., M. INST. C.E.

Mr. SMITH, the outgoing President, then installed Mr. HEDLEY as President for the ensuing year, and the latter briefly returned thanks.

---



---

**NAPIER COMMEMORATIVE LECTURE.**

A Special Meeting of the Royal Society of New South Wales was held at the Society's House, 5 Elizabeth-street North, on Thursday, May 21st at 8 p.m., in commemoration of the Tercentenary of the publication of the "Mirifici Logarithmorum Canonis Descriptio," when Professor H. S. CARSLAW, Sc. D., delivered an address on "Napier and the Discovery of Logarithms."

At the conclusion of the lecture a vote of thanks was passed to the lecturer on the proposal of His Excellency the Governor, Sir GERALD STRICKLAND, G.C.M.G., seconded by Professor DAVID, C.M.G.

---



---

**ABSTRACT OF PROCEEDINGS, JUNE 3rd, 1914.**

The three hundred and sixty-fifth (365th) General Monthly Meeting of the Royal Society of New South Wales was held at the Society's House, 5 Elizabeth-street North, at 8 p.m.

Mr. C. HEDLEY, President, in the Chair.

Thirty members and one visitor were present.

The minutes of the preceding meeting were read and confirmed.

The certificates of candidates for admission as ordinary members were read: four for the second, and two for the first time.

Mr. L. HARGRAVE and Mr. W. WELCH were appointed Scrutineers, and Dr. GREIG-SMITH deputed to preside at the Ballot Box.

The following gentlemen were duly elected ordinary members of the Society:—

ARTHUR GREIG, Assoc. M. I. Mech. E., Harbours Branch,  
Public Works Department.

WILLIAM E. KEMP, Assoc. M. Inst. C. E., Public Works,  
Department, Sydney.

Dr. G. H. STANDISH LIGHTOLLER, "Yetholm," New  
South Head Road, Darling Point.

Dr. F. G. N. STEPHENS, "Gleneugie," New South Head  
Road, Rose Bay.

On the motion of Dr. ANDERSON, seconded by Mr. HALLIGAN, Mr. W. P. MINELL was elected Auditor for the current year.

A letter was read from the Registrar of the University asking co-operation, by the provision of exhibits, in the *Conversazione* to be given during the visit of the British Association for the Advancement of Science in August. The Honorary Secretary stated that the Council of this Society had directed that members were to be notified of the date when the list of proposed exhibits was to be sent to the University.

Four volumes, 78 parts and 6 reports were laid upon the table.

THE FOLLOWING PAPERS WERE READ:

1. "On the Accuracy of Neumann's Method for the Estimation of Phosphorus," by H. S. H. WARDLAW, B.Sc.



2. *Hepaticæ Australes*," by Dr. FRANZ STEPHANI, and Rev. W. WALTER WATTS. (Communicated by Mr. J. H. MAIDEN).

Remarks were made by the President.

3. "Dimorphic Foliage of *Acacia rubida*, and Fructification during Bipinnate Stage," by R. H. CABBAGE, F.L.S.

Remarks were made by Dr. CLELAND and Mr. MAIDEN.

EXHIBITS:

1. A paraffin bath for preparation of microscopic sections, and a water bath for general laboratory purposes, by Professor CHAPMAN.

2. A collection of synthetic gem stones, rubies and sapphires, by Mr. H. G. SMITH.

3. Some rare earths containing ionium, by Mr. S. RADCLIFF.

---

ABSTRACT OF PROCEEDINGS, JULY 1st, 1914.

The three hundred and sixty-sixth (366th) General Monthly Meeting of the Royal Society of New South Wales was held at the Society's House, 5 Elizabeth-street North, at 8 p.m.

Mr. C. HEDLEY, President, in the Chair.

Thirty-one members and three visitors were present.

The minutes of the preceding meeting were read and confirmed.

The certificates of two candidates for admission as ordinary members were read for the second time.

Mr. L. HARGRAVE and Mr. J. E. CARNE were appointed Scrutineers, and Mr. C. A. SUSSMILCH deputed to preside at the Ballot Box.

The following gentlemen were duly elected ordinary members of the Society:—

ALEXANDER BURNETT HECTOR, Manufacturing Chemist,  
481 Kent-street, Sydney.

DAVID REID, General Manager in Australia of Orient  
Line of Royal Mail Steamers, "Holmsdale,"  
Pymble.

On the motion of Professor DAVID seconded by Mr. H. G. SMITH, it was unanimously decided that a very hearty message of congratulation from this Society be sent to Sir THOMAS ANDERSON STUART, a former President, and to Sir DOUGLAS MAWSON, in recognition of the honour of Knighthood having been conferred upon them by His Majesty the King.

Professor CHAPMAN brought under notice the desirability of intending members for the August Meeting of the British Association for the Advancement of Science enrolling as early as possible, so as to avoid congestion during the last week, and he expressed the hope that there would be a large enrolment.

Four volumes, 175 parts, 15 reports, and 1 map were laid upon the table.

THE FOLLOWING PAPERS WERE READ:

1. "The Australian Journal of Dr. W. STIMPSON, Zoologist," with an introduction by C. HEDLEY, F.L.S.
2. "On the Nature of the Deposit obtained from Milk by spinning in a centrifuge," (Preliminary Communication) by H. S. H. WARDLAW, B.Sc.
3. "The Geology of the Cooma District, N.S.W., Part I," by W. R. BROWNE, B.Sc.

Remarks were made by Professor DAVID, Mr. SUSSMILCH, Mr. CARNE, and Mr. BENSON.

4. "The Oxidation of Sucrose by Potassium Permanganate," by C. W. R. POWELL, Science Research Scholar, University of Sydney. (Communicated by Professor C. E. FAWSITT).

Remarks were made by Professor FAWSITT.

## EXHIBIT.

Mr. J. E. CARNE F.G.S., Assistant Government Geologist, exhibited polished specimens of nepheline-ægirine rock from about six miles N.E. of Lue railway station on the Mudgee railway line. Here, and in the neighbouring Barigan district, this rare and highly interesting rock occurs in huge dome-shaped masses or laccolites. The colour of the rock varies from pale mottled blue, greenish-grey and pinkish-grey with dark green feathery crystals of ægirine, to brown with red and green mottling.

---

---

**ABSTRACT OF PROCEEDINGS, AUGUST 5th, 1914.**

The three hundred and sixty-seventh (367th) General Monthly Meeting of the Royal Society of New South Wales was held at the Society's House, 5 Elizabeth-street North, at 8 p.m.

Mr. C. HEDLEY, President, in the Chair.

Thirty-one members and one visitor were present.

The minutes of the preceding meeting were read and confirmed.

The certificate of one candidate for admission as an ordinary member was read for the first time.

The President welcomed Professor W. M. DAVIS as a visitor from Harvard University, U.S.A.

Letters were read from Professor BATESON, who had been elected an Honorary Member of this Society: from Sir THOMAS ANDERSON STUART, who had been congratulated by the Society on receiving the honour of Knighthood: and from Dr. A. SMITH WOODWARD, who had been awarded the Clarke Memorial Medal by this Society.

The President urged the desirability of intending members for the coming meeting of the British Association for the Advancement of Science enrolling as early as possible.

Ten volumes, 233 parts, 2 maps and 2 reports were laid upon the table.

THE FOLLOWING PAPERS WERE READ :

1. "Pressure in relation to the solid components of the Earth's Crust," by E. J. STATHAM, Assoc. M. Inst. C.E.

*Abstract.*—A list of thirty test specimens of various rocks, as given in Molesworth's Pocket Book of Engineering formulæ, shows that the crushing strains per square inch vary from "Cheshire Red Sandstone" 2,185 lbs. per square inch to "Welsh Slate" 21,000 lbs. per square inch. A paper by FRANCIS FOX, C.E.,<sup>1</sup> dealing with the construction of the Simplon Tunnel through the Alps, gives interesting data in this connection. This great work penetrates to a depth of 7,005 feet beneath the slopes and crags of Mount Leone, the highest mountain of the Simplon Range, 11,684 feet above sea level: this is by far the greatest depth to which man has ever been below the surface of the earth. The rock consists chiefly of gneiss, mica schist, and on the Italian side of antigorio gneiss, but in some places limestone was encountered. Great pressures were experienced in places when the geological beds were horizontal, and much heavy timbering was required. The maximum temperature was 133° F. in proximity to the maximum depth of tunnel (7,005 feet). Formidable difficulties were encountered in unsound rock, which it is needless to detail, but the effect of pressure causing "creeping of the floor" is pertinent to the intent of this paper. The rising of the floor occurred in several places even in solid rock, and it became necessary to construct inverters for a very considerable distance; 5½ feet of granite blocks being used in some instances. Under-pinning with similar granite blocks was also necessary where side thrusts were met with. It will thus be seen that all but the

---

<sup>1</sup> Proc. Inst. C.E. Vol. cxviii, p. 61.

hardest gneiss is crushed under a pressure of 7,000 feet equal to 7,770 lbs. per square inch, whereas granite can stand a pressure of from 10,000 to 14,000 lbs. to the square inch before crushing. *Pari passu* the more resistant Welsh slate would require 18,918 feet of similar pressure to crush it, that is at a depth of a little more than  $3\frac{1}{2}$  miles. It is probable, therefore, that at a depth of 4 miles every description of rock would be crushed as at  $3\frac{1}{2}$  miles depth with an increment of  $67\cdot5^{\circ}$  F., the temperature would be  $280^{\circ}$  F., and at 4 miles, over  $301^{\circ}$  F.

2. "The composition of some lime-sulphur sprays made according to recognised formulæ," by A. A. RAMSAY. (Communicated by Mr. F. B. GUTHRIE.)

Remarks were made by Mr. HAMLET.

3. "On the diffusible phosphorus of Cow's Milk," by H. S. H. WARDLAW, B.Sc.

Remarks were made by Professor CHAPMAN, Dr. QUAIFFE and Mr. HAMLET.

#### EXHIBIT.

Mr. OLLE exhibited some examples of a condensation product of phenol. Remarks were made by Mr. CLUNIES ROSS.

---

#### ABSTRACT OF PROCEEDINGS, SEPTEMBER 2nd, 1914.

The three hundred and sixty-eighth (368th) General Monthly Meeting of the Royal Society of New South Wales was held at the Society's House, 5 Elizabeth-street North, at 8 p.m.

Mr. C. HEDLEY, President, in the Chair.

Thirty-four members and seven visitors were present.

The minutes of the preceding meeting were read and confirmed.

The President welcomed Professor MINCHIN, Professor GUIDO CORA, Mr. J. T. CUNNINGHAM and Dr. ARMITT, visiting members of the British Association for the Advancement of Science.

The certificates of candidates for admission as ordinary members were read: one for the second, and one for the first time.

Mr. L. HARGRAVE and Mr. E. C. ANDREWS were appointed Scrutineers, and Mr. W. M. HAMLET deputed to preside at the Ballot Box.

The following gentleman was duly elected an ordinary member of the Society:—

EDMUND F. BROAD, Timber and General Importer,  
“Cobbam,” Woolwich Road, Hunter’s Hill.

A letter was read from Professor J. P. HILL who had been elected an Honorary Member of this Society: and the Hon. Secretary conveyed an appreciative message from Sir DOUGLAS MAWSON who had been congratulated by the Society upon his having received the honour of Knighthood.

Six volumes, 308 parts, 11 reports, 2 catalogues and 3 maps were laid upon the table.

THE FOLLOWING PAPER WAS READ:

“Mountains of Eastern Australia and their effect on the Native Vegetation,” by R. H. CAMBAGE, F.L.S.

Remarks were made by Mr. R. T. BAKER, Mr. G. H. HALLIGAN, Mr. E. C. ANDREWS, Professor GUIDO CORA and Judge DOCKER.

Professor CORA and Professor MINCHIN, as visiting scientists, expressed their appreciation of the treatment received from fellow scientists, while in Australia.

## EXHIBITS.

1. Mr. E. F. PITTMAN sent a new geological map of New South Wales which had just been prepared under his supervision.

2. Mr. G. P. DARNELL SMITH exhibited a so-called bulb of the pest Prickly Pear, *Opuntia inermis*, and pointed out that in any device for destroying this plant it would be necessary to include a means of destroying this bulb.

3. Mr. SMITH exhibited the seed case of the Wooden Pear, *Xylomelum pyriforme*, which on being gathered had been immediately bound with copper wire. Such is the force with which the seed case gradually opens that the copper wire, if not broken, cuts into the seed case, which is of extraordinary hardness.

4. Specimens of a siliceous sponge *Purisiphonia Clarkei*, Bowerbank, from the Lower Cretaceous of Wollumbilla, Queensland, were exhibited by Mr. W. S. DUN.

---

---

ABSTRACT OF PROCEEDINGS, OCTOBER 7th, 1914.

The three hundred and sixty-ninth (369th) General Monthly Meeting of the Royal Society of New South Wales was held at the Society's House, 5 Elizabeth-street North, at 8 p.m.

Mr. C. HEDLEY, President, in the Chair.

Twenty-eight members and one visitor were present.

The minutes of the preceding meeting were read and confirmed.

The certificate of one candidate for admission as an ordinary member was read for the second time.

Mr. G. HOOPER and Mr. WELCH were appointed Scrutineers, and Dr. GREIG-SMITH deputed to preside at the Ballot Box.

The following gentleman was duly elected an ordinary member of the Society:—

Dr. A. E. FINCKH, Medical Practitioner, 227 Macquarie-street.

A communication was read from Dr. C. MACLAURIN expressing his appreciation of the message of sympathy which had been conveyed to him at the time of the death of his father, Sir NORMAND MACLAURIN.

Donations consisting of 317 parts, 1 volume, 15 reports and 1 catalogue were laid upon the table.

THE FOLLOWING PAPERS WERE READ:

1. "Description of a Limestone of Lower Miocene Age from Bootless Inlet, Papua," by FREDERICK CHAPMAN, A.L.S., F.R.M.S. (Communicated by Mr. W. S. DUN.)

Remarks were made by Professor DAVID.

2. "Note on the Catalase Reaction of Milk," by H. B. TAYLOR, B.Sc. (Communicated by Prof. C. E. FAWSITT).

Remarks were made by Professor FAWSITT and Professor CHAPMAN.

EXHIBITS:

1. Glaciated boulders from a newly discovered area of the Permo-Carboniferous Lochinvar Glacial beds, and also from a newly discovered glacial horizon from what appear to be the topmost beds of the Rhacopteris Series of the Lower Carboniferous beds at Seaham and Paterson in the Lower Hunter area, by Professor T. W. EDGEWORTH DAVID, F.R.S., and Mr. C. A. SUSSMILCH.

2. Mr. J. H. MAIDEN, F.L.S., exhibited living plants of:— (i.) *Myremecodia Muelleri*, Beccari, Papua. (ii.) *Hydnophyllum formicaruim*, Jack, var. *dubium*, Beccari, Malacca; both possess opinous tubers of great size, which are gal-leried by ants. (iii.) *Homalomena Wallisii*, Regel, Araceæ (*Homalaomeninæ*) from Colombia. (iv.) *Calmus ciliaris*,



Blume, Malaya. (v.) *Durio zibethinus*, DC., the Durian, Malaya.

---

#### ABSTRACT OF PROCEEDINGS, NOVEMBER 4th, 1914.

The three hundred and seventieth (370th) General Monthly Meeting of the Royal Society of New South Wales was held at the Society's House, 5 Elizabeth-street North, at 8 p.m.

Mr. C. HEDLEY, President, in the Chair.

Thirty-eight members and three visitors were present.

The minutes of the preceding meeting were read and confirmed.

The certificates of two candidates for admission as ordinary members were read for the first time.

Donations consisting of 4 volumes, 77 parts, 7 reports, 1 map and 2 calendars were laid upon the table.

#### THE FOLLOWING PAPERS WERE READ:

1. "Notes on Tasmanian Hydrozoa," by E. A. BRIGGS, B.Sc. (Communicated by Mr. C. HEDLEY, F.L.S.)

2. "The Development and Distribution of the Natural Order Leguminosæ," by E. C. ANDREWS, B.A., F.G.S.

Remarks were made by Mr. FREEMAN, Mr. MAIDEN, Mr. CABBAGE and Mr. CHEEL.

3. "On the Recovery of Actinium and Ionium from the Olay Ores," by S. RADCLIFF.

Remarks were made by Professor FAWSITT.

4. "The Hæmatozoa of Australian Batrachians, No. 2," by J. BURTON CLELAND, M.D., Ch.M.

#### EXHIBIT.

Professor FAWSITT exhibited an apparatus for the preparation of nitrogen from the air according to a method described by VAN BRUNT in the Journal of the American Chemical Society for July, 1914.

**ABSTRACT OF PROCEEDINGS, DECEMBER 2nd, 1914.**

The three hundred and seventy-first (371st) General Monthly Meeting of the Royal Society of New South Wales was held at the Society's House, 5 Elizabeth-street North, at 8 p.m.

Mr. C. HEDLEY, President, in the Chair.

Thirty-six members were present.

The minutes of the preceding meeting were read and confirmed.

The certificates of two candidates for admission as ordinary members were read for the second time.

Mr. R. T. BAKER and Mr. E. C. ANDREWS were appointed Scrutineers, and Dr. CLELAND deputed to preside at the Ballot Box.

The following gentlemen were duly elected ordinary members of the Society:—

HAROLD BURFIELD TAYLOR, B.Sc., "Ronsahl," Moruben Road, Mosman.

JOHN BISHOP, Publisher, 24 Bond-street, Sydney.

Letters were read from Mrs. M. CANTY and Mrs. W. J. CLUNIES ROSS, expressive of their appreciation of the sympathy of members which had been extended to them in their recent bereavements.

The President referred to the projected departure of the Antarctic Expedition, and on the motion of Professor DAVID seconded by His Honour Judge DOCKER, the following resolution was carried unanimously:—

"We the members of the Royal Society of New South Wales on this the eve of the departure for Antarctica of the S.Y. "Aurora" from Sydney, desire to convey our best wishes to Commander ÆNEAS MACKINTOSH, R.N.R., and all the members of the Imperial Transantarctic Expedition. It is

our pious hope that the leader of the Expedition, Sir ERNEST SHACKLETON, with his party from Weddell Sea may be spared to carry the Union Jack entrusted to him by His Majesty successfully and gloriously across the Antarctic Continent, and that Captain MACKINTOSH and his brave comrades may be able to join forces with those of the leader and share in this great journey for the honor of the Flag and for the Advancement of Science. Most heartily do we wish God-speed and a safe return to every member of the Expedition."

It was announced that donations consisting of 6 volumes, 84 parts and 2 reports, were laid upon the table.

THE FOLLOWING PAPERS WERE READ:

1. "Observations on some reputed natural Eucalyptus Hybrids, together with descriptions of two new species," by J. H. MAIDEN, F.L.S., and R. H. CABBAGE, F.L.S.
2. "Notes on Eucalyptus," No. 3, by J. H. MAIDEN, F.L.S.  
Remarks were made by Mr. E. C. ANDREWS.
3. "Notes on Australian Fungi," No. 1, by J. BURTON CLELAND, M.D., and EDWIN CHEEL.
4. "A new Croton from New South Wales., by R. T. BAKER, F.L.S.
5. "Eudesmin and its Derivatives" (part 1), by R. ROBINSON, D.Sc., and H. G. SMITH, F.C.S.  
Remarks were made by Mr. CHALLINOR.
6. "On the butyl ester of butyric acid occurring in some Eucalyptus Oils," by H. G. SMITH, F.C.S.
7. "Note on the Estimation of Fat in Food for Infants," by H. G. CHAPMAN, M.D., M.S.
8. "Studies in Statistical Representation, III: Curves, their Logarithmic Homologues, and Antilogarithmic Generatrices, as applied to Statistical Data," by G. H. KNIBBS, C.M.G., and F. W. BARFORD, M.A., A.I.A.

9. "The Distribution of Frictional Losses in Internal Combustion Engines," by E. P. TAYLOR, B.E. (Communicated by Professor S. H. BARRACLOUGH).

## EXHIBITS.

Mr. C. A. SUSSMILCH exhibited some remarkable examples of miniature rock folding from near Seaham.

Mr. E. CHEEL exhibited specimens and submitted notes on the following species of *Acacia* :—

*Acacia intertexta*, Sieb. in DC. Prodr. ii, p. 454 (1825); *A. obtusifolia*, A. Cunn., in Baron Field's N. S. Wales, p. 345 (1825). This species is included by Bentham under *A. longifolia*, Willd., c. *typica*. It may be distinguished from the latter species by the following characters :—*A. intertexta* flowers during the months of December and January, but rarely matures its pods and seeds. A few pods were obtained from plants at Mount York near Mount Victoria in December, 1900, and from plants collected on the Woronora River in October, 1901, and also from plants at Hill Top in November, 1914. Although the pods are only found on an occasional plant, the individual plants are very numerous on the Blue Mountains, and also in the neighbourhood of Hill Top, on the southern line. The ripe pods are more fleshy or pulpy than those of *A. longifolia*, Willd., the latter being much thinner in texture and are produced in abundance.

Although the plants of *A. intertexta* very rarely produce mature pods and seeds, it is found upon examination that the plants spread very rapidly by means of suckers. So far as I can ascertain, very few records have been made of *Acacias* reproducing themselves by means of suckers. R. T. Lowe in "A Manual Flora of Madeira etc.," p. 231 (1848) mentions that *Acacia dealbata*, Link. is cultivated in gardens in Madeira, and that "the roots run near the surface, throwing up suckers." In the Proc. Linn. N.S.W.,

Vol. xxxvi (1911), 158, I recorded the sucker producing habit of *Acacia pugioniformis*, Wendl. I have also noted that *Acacia salicina*, Lindl., produces suckers very freely under cultivation in the Sydney district, as will be seen by the specimens herewith exhibited.

*Acacia longifolia*, Wild.—This species has a very wide range, and specimens have been collected in flower during the months of May to August in the Sydney district, and in September at Hill Top and Bowral. The phyllodes are thinner in texture, with a very prominent gland near the base, and the pods are much thinner in texture and more or less constricted, and produced in abundance. The production of an abundance of seed accounts for the free cultivation of this latter species, and it is interesting to note that the figures quoted by Bentham in Bot. Mag. t. 1827, 2166; Bot. Reg. t. 362; Lodd. Bot. Cab. t. 678, are all from cultivated plants and agree with the plants commonly known as the "Sydney Golden Wattle," which is referable to *A. longifolia*.

In the Proc. Linn. Soc. N.S.W., Vol. xxx (1905), p. 213, Mr. R. H. CAMBAGE has drawn attention to another species of *Acacia* which produced suckers. In this paper Mr. CAMBAGE points out that in trying to ascertain why numbers of young Yarran (*Acacia homalophylla*) trees grew with one horizontal root instead of a system of lateral roots, he discovered that those with the horizontal roots were suckers, and were much more plentiful around a ring-barked Yarran or where one had been cut down, than around a growing tree. In one instance a sucker was traced by the root for a distance of twenty-seven feet from the parent tree. He infers that probably most of the old Yarran trees grew from seedlings, and that suckers have become more common since the advent of clearing and ringbarking operations.



---

---

GEOLOGICAL SECTION.

---

---





# ABSTRACT

OF

## PROCEEDINGS OF THE GEOLOGICAL SECTION.

---

*Monthly Meeting, 10th June, 1914.*

Prof. T. W. E. DAVID in the Chair.

Fifteen members and six visitors were present.

Professor W. M. DAVIS, Harvard University, Cambridge, U.S.A., was introduced by the Chairman and gave an address on the various theories used to explain the development of Coral Reefs.

The address was spoken to by Messrs. E. C. ANDREWS, HEDLEY, HALLIGAN and the Chairman.

*Monthly Meeting, 8th July, 1914.*

Prof. T. W. E. DAVID in the Chair.

Nine members and three visitors were present.

Dr. C. ANDERSON exhibited (a) Gold crystals from Darwin, N. T.; (b) Mimetite, from Mount Bonney, N.T.; (c) Willemitite, from Franklin, N. Jersey.

Mr. W. N. BENSON gave an account of his researches on the geology of the Serpentine Belt of New England, New South Wales.

The address was spoken to by Messrs. COTTON, HAMMOND, SUSSMILCH, CAMBAGE and the Chairman.

*Monthly Meeting, 14th October, 1914.*

Professor T. W. E. DAVID in the Chair.

Thirteen members and seven visitors were present.

1. Mr. E. C. ANDREWS exhibited numerous polished slices of ore and country rock from the Great Cobar Copper and the Mount Boppy Gold Mines, also specimens of ore from the Budgerygar and Tottenham Copper Mines. Large hand specimens of slate and sandstone from the Mount Boppy Gold Mine were also shown. The exhibits were selected from a collection of specimens obtained during the geological survey of the Cobar and Canbelego Mining Fields, and they illustrate in a striking manner, the great alteration which the rocks of the districts under consideration have undergone. The ores exhibited from the Great Cobar Copper Mine are massive copper pyrites, magnetic pyrites, magnetite, galena, zinc-blende, and iron silicate, in intimate association and which occur as lenses of enormous size in slate within a wide zone of faulting or crushing. The great lenses under consideration represent the replacement of slate by ore solutions. In other ore specimens exhibited from the siliceous deposits of Cobar, magnetite, magnetic pyrites, and iron silicate are almost completely absent. These siliceous ores, however, represent replacement by silica, iron sulphide and gold, solutions within long zones of faulting. The Budgerygar and Tottenham copper ores exhibited, illustrate the action of selective replacement in sandstone and slate which have been highly folded and puckered. Thin and puckered layers have been replaced by sulphides although intermediate layers exhibit slight replacement only, in the nature of iron pyrites as crystals scattered throughout such layers. Types of structure strikingly suggestive of miniature 'saddles' and 'inverted saddles' are common in the Tottenham mines. The specimens exhibited of the country rock from the Mount Boppy Gold Mine consist of crossbedded sandstone and slate which have been intensely puckered. Under a strong lens these puckered layers show faulting of overthrust nature.

2. Mr. PAINE—Devonian fossils from Quambaa, *Rhynchonella* cf. *pleurodon*, *Leptodomus*, *Grammysia* (?).

3. Mr. W. R. BROWNE—Granitic and other rocks from the Cooma district.

4. Mr. J. E. CARNE—Diallage from Solferino.

5. Mr. W. S. DUN—A new Palæasterid from the Permo-Carboniferous beds of Gympie, Queensland.

6. Professor T. W. E. DAVID—Glaciated boulders from Seaham.

\* Mr. L. F. HARPER read a note on the correlation of the coal seams occurring in the upper portion of the Upper Coal Measures as exhibited in the Southern, Liverpool, Sydney and Newcastle districts.

#### THE IDENTITY OF THE SYDNEY HARBOUR COLLIERIES COAL SEAM.

This coal seam has always been definitely correlated with No. 1 or the Bulli Seam of the Southern Coal Field. It is proposed in this note to bring forward certain points which in the writer's opinion, justify some doubts as to the exact horizon of the Sydney Harbour Collieries Coal Seam. The evidence obtained from the various bores put down between the Southern and Northern coal fields may first be reviewed: No. 1 Bore, Cremorne (Sydney Harbour) penetrated about 300 feet of Permo-Carboniferous strata, and it is interesting to compare this section with a similar thick-

Locality.	Number of Coal horizons.	Approx. total thickness of coal and bands.	Remarks.
Newcastle District ...	7	68	The two upper seams are being worked with a total thickness of 32 feet.
Hawkesbury River ...	7	18	None of the seams are workable.
Sydney ... ..	5	19	Only the top seam is workable, (from 5 to 10 feet)
Illawarra District (Southern Coal Field)	6	40	Practically all the coal is won from the top seam (from 4 ft. to 12 ft.) No. 2 seam worked to a small extent.

ness near Newcastle, in the Hawkesbury River Bore, and a natural section of similar strata in the Southern Coal Field near Wollongong.

A detail section of the lower portion of the Cremorne Bore as compared with a corresponding section in the Southern Coal Field may now be considered.

CREMORNE.				SOUTHERN COAL FIELD.			
		Ft.	In.			Ft.	In.
Top coal seam	...	8	9½	No. 1 Coal Seam	...	6	0
Strata	...	19	0	Strata	...	16 ft. to	26
Clayey calcined coal	...	1	1	No. 2 Coal Seam	...	4	0
Strata	...	71	1½	Strata	...	60 ft. to	100
Coal (dirty splint)	...	1	2	No. 3 Coal Seam	...	up to	18
Strata	...	42	0	Strata	...	40 ft. to	60
Inferior coal	...	5	0	No. 4 Coal Seam	...	6 ft. to	10
Strata	...	12	9	Strata	...	80	0
Coal (inferior in part)	...	2	4	No. 5 Coal Seam	...	5	0
Strata	...	7	6	Strata	...	30 ft. to	50
Coal and bands	...	1	4	No. 6 Coal Seam	...	5	0
Strata	...	24	11	Strata	...	80 ft. to	150
Coal and bands	...	0	5				
Strata	...	40	0				

The coal seams penetrated by this bore afford no reliable guide for correlation, for most of them are very thin and may represent splints. If the top seam pierced be excluded, there is no seam at all comparable to No. 3 of the Southern Coal Field, which is there the most persistent horizon, and at the southern end occupies the top of the measures, No. 1 and No. 2, having thinned out entirely. That such is the case may be seen beneath the Fitzroy and Belmore Falls. Attention is now called to the Liverpool Bore section, the lower portion of which is as follows:—

No. 1 Coal Seam	...	...	1 ft. 5 in.
Strata ..	...	...	12 ft. 7 in.
No. 2 Coal Seam	...	...	1 ft. 4 in.
Strata ...	...	...	74 ft. 8 in.
No. 3 Coal Seam	...	...	6 in. 6½ in.

Compare this with the upper portion of the Southern Coal Field exposures of Permo-Carboniferous strata and the similarity justifies their identification as given in the section, the differences in thick-

ness evidently being due to a normal thinning in that direction. This in the writer's opinion paves the way for a complete thinning out of the upper portion of the measures under Sydney. This possibility is again evidenced in the Mount Westmacott and Holt-Sutherland No. 3 Bores, in which No. 1 seam was proved to have diminished from 12 feet at Helensburgh to 4 ft. 8½ in. and 4 ft. 2 in. respectively. With regard to the southern extension of the Northern Coal Field, it may be again pointed out that no seams comparable in thickness with Nos. 1, 2 and 3 were proved by the Hawkesbury River Bore, so that a thinning from that end towards Sydney has been proved.

The second point brought forward is the pronounced split proved in the opening up of the Sydney Harbour Collieries coal seam. One of the features of the Bulli seam is that no split has ever yet been found in it where its identity is undoubted. Having regard to the origin of splits, it seems unlikely that one would occur in the central portion of the area of deposition and not in the peripheral portion.

A third item for consideration, and one more tangible than either of those already advanced, is the finding of *Glossopteris* impressions at least 4 feet 7½ in. above the roof of the seam in the Balmain shaft. Great importance is placed upon this fossil in determining the upward limits of the Permo-Carboniferous formations in New South Wales, and Professor DAVID has laid particular stress upon the fact that there is not a single instance on record of *Glossopteris* having been found above the top seam of the Northern coal field. Mr. J. E. CARNE, Assistant Government Geologist, had the same experience in the Western coal field, and was unable to record the presence of *Glossopteris* above the Katoomba seam, which he correlates with the Bulli seam.

During the geological survey of the Southern Coal Field particular attention was paid to this important question, but no specimen of *Glossopteris* was found overlying the Bulli seam. This evidence all serves to confirm the opinion held by our leading

geologists, that *Glossopteris* died out absolutely with the top coal seam of the New South Wales Permo-Carboniferous beds. Bearing this in mind, and in view of the conflicting evidence obtained in the Balmain shaft, we are compelled to accept one of two theories, either :

1. Conditions were favourable in the central portion of our Permo-Carboniferous basin for the survival of *Glossopteris* above the Bulli coal seam horizon.
2. The coal seam now being worked under Sydney Harbour is on a lower horizon, and is overlain by Permo-Carboniferous strata devoid of coal seams.

Any one of the points raised, if considered alone, may have no significance, but are we justified in ignoring the evidence as a whole? The writer is inclined to favour the possibility of the Sydney Harbour coal seam being on a lower horizon than the Bulli seam, possibly No. 2 or No. 3, and is of the opinion that whilst Permo-Carboniferous sedimentation continued in the central portion of the basin, conditions were not favourable for the formation of a coal seam during its closing phases.

The question was discussed by MESSRS. PITTMAN, ATKINSON, CARNE, DUN, and Professor DAVID, and replied to by Mr. HARPER.

*Monthly Meeting, 11th November, 1914.*

Prof. T. W. E. DAVID in the Chair.

Twelve members and six visitors were present.

Professor DAVID made some remarks in further discussion of Mr. L. F. HARPER's paper on the coal seams of the Southern Coal Field read at the previous meeting.

1. Mr. C. A. SUSSMILCH exhibited specimens of contorted strata from Seaham, associated with thin bedded acidic tuffs, dipping at 18°, the series being unfolded; a local occurrence.

Professor DAVID suggested that the specimens might possibly be explained as mud lavas of contemporaneous age.

Remarks were made by Messrs. W. N. BENSON and E. C. ANDREWS.

2. Mr. SUSSMILCH also exhibited a boulder from the glacial beds of Seaham.

3. The Mining Museum exhibited: (a) Natural glass from the Jukes, Darwin Range, Tasmania; (b) Moldavite from Bohemia; (c) White marble from Rockley and Newbridge.

4. Mr. W. S. DUN exhibited the type specimen of *Phialocrinus princeps*, Eth. fil., from Bow Wow, now in the possession of the Mining and Geological Museum—the gift of the Maitland Scientific Society.

5. Professor DAVID exhibited and made remarks on the Talgai skull, recently presented to the University of Sydney, and portion of the upper jaw of *Diprotodon* from King's Creek, Upper Condamine.

Professor DAVID, on behalf of the Section, welcomed Father PIGOT, S.J., on his return from Europe.

Captain du BATY gave an interesting lecture on Kerguelen Island, illustrated by a series of lantern slides.

Remarks were made by the Chairman, Messrs. HEDLEY, ANDREWS, BENSON, and DUN, and a vote of thanks was carried.

*Monthly Meeting, 9th December, 1914.*

Mr. R. H. CAMBAGE in the Chair.

Eight members were present.

Letter of apology for absence was received from Professor DAVID.

Mr. W. S. DUN exhibited fossil coniferous wood from the old Stockton Shaft, and also from the Grose Valley.

Mr. W. N. BENSON delivered a lecturette on Daly's Theory of the origin of Igneous Rocks.

It was discussed by Messrs. COTTON, BROWNE, and Dr. C. ANDERSON.

---





ACACIA RUBIDA.



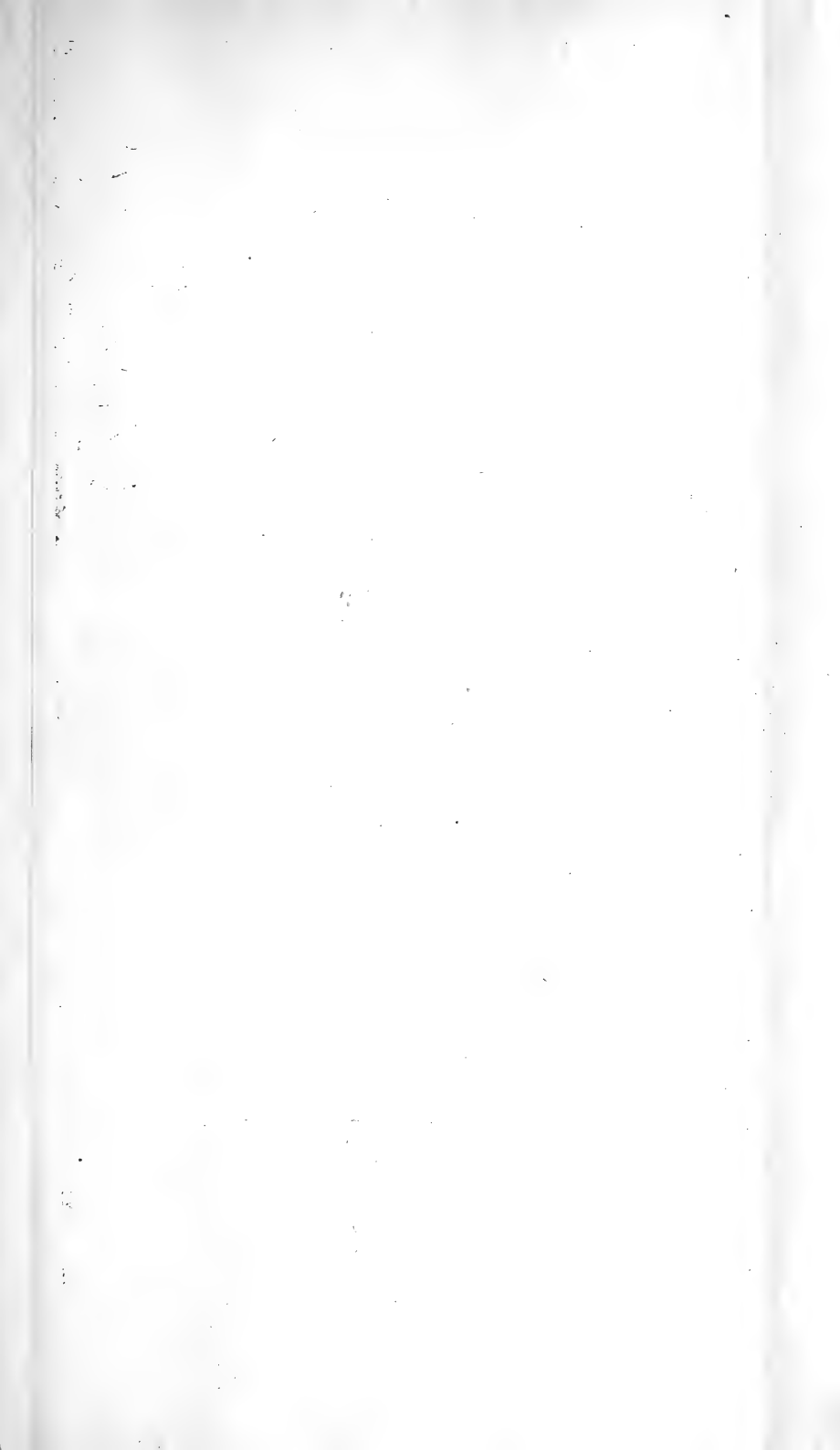







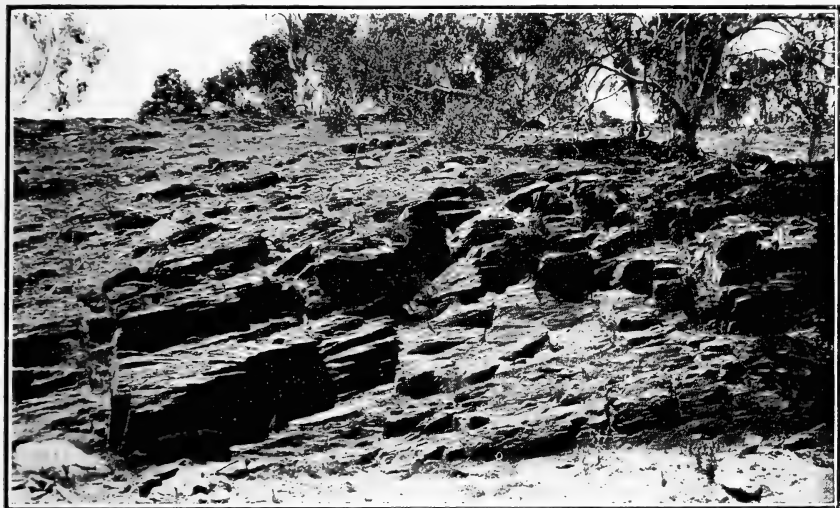

Fig. 1.



Fig. 2.







Fig. 3.



Fig. 4.



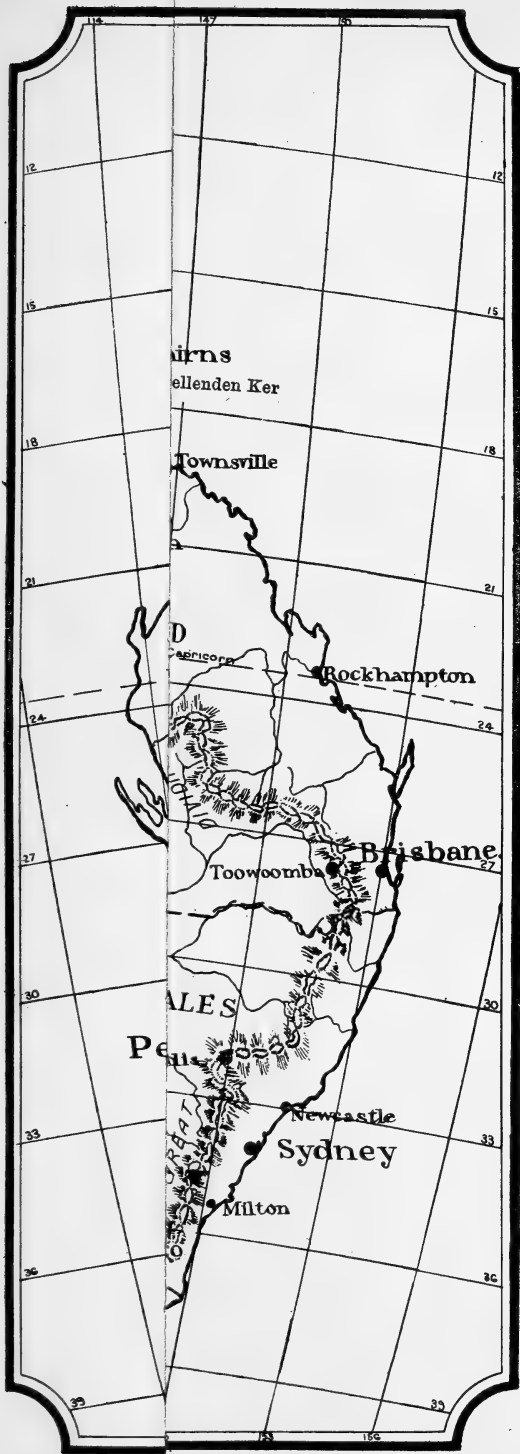

Fig. 5.



Fig. 6.









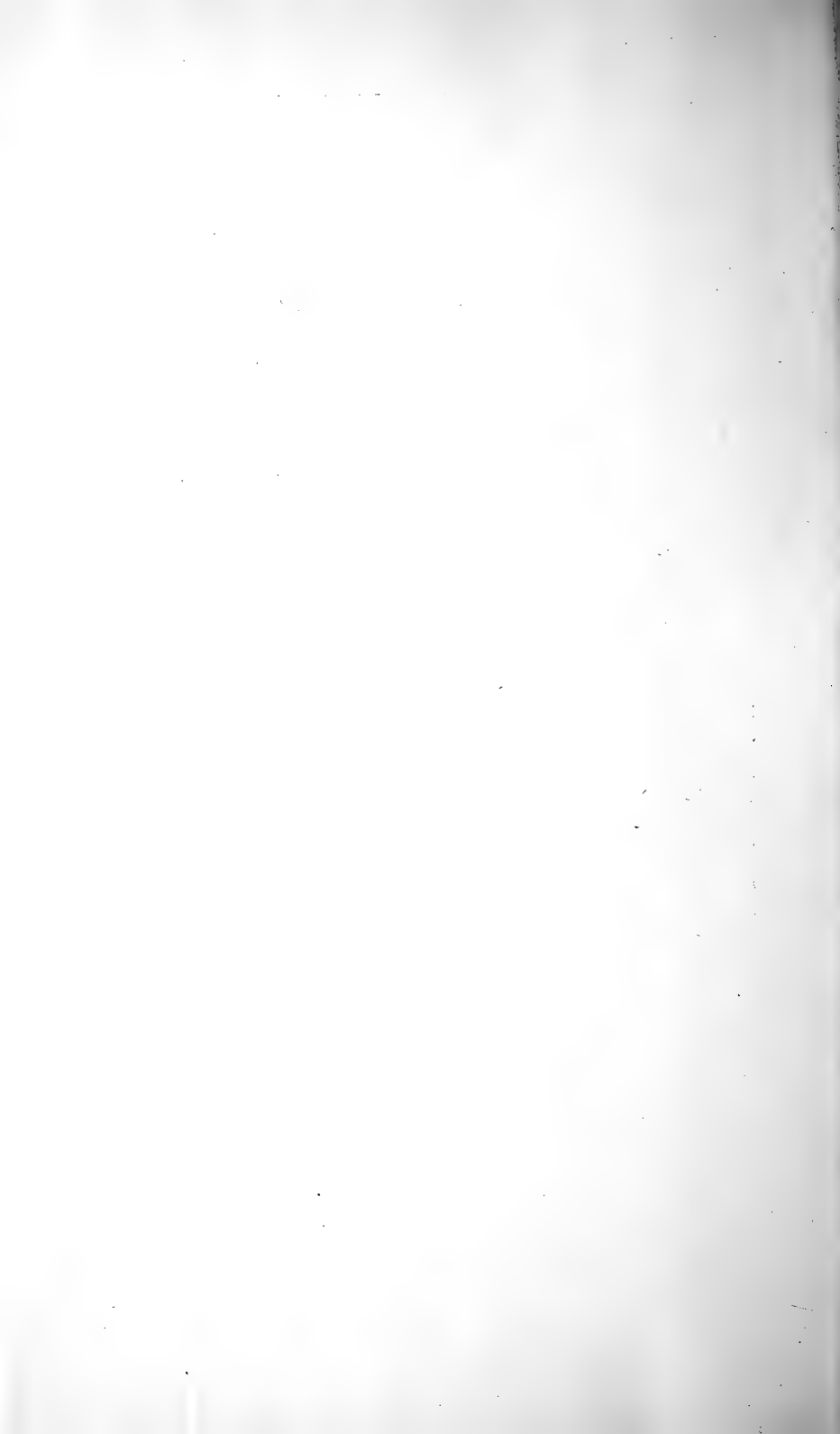



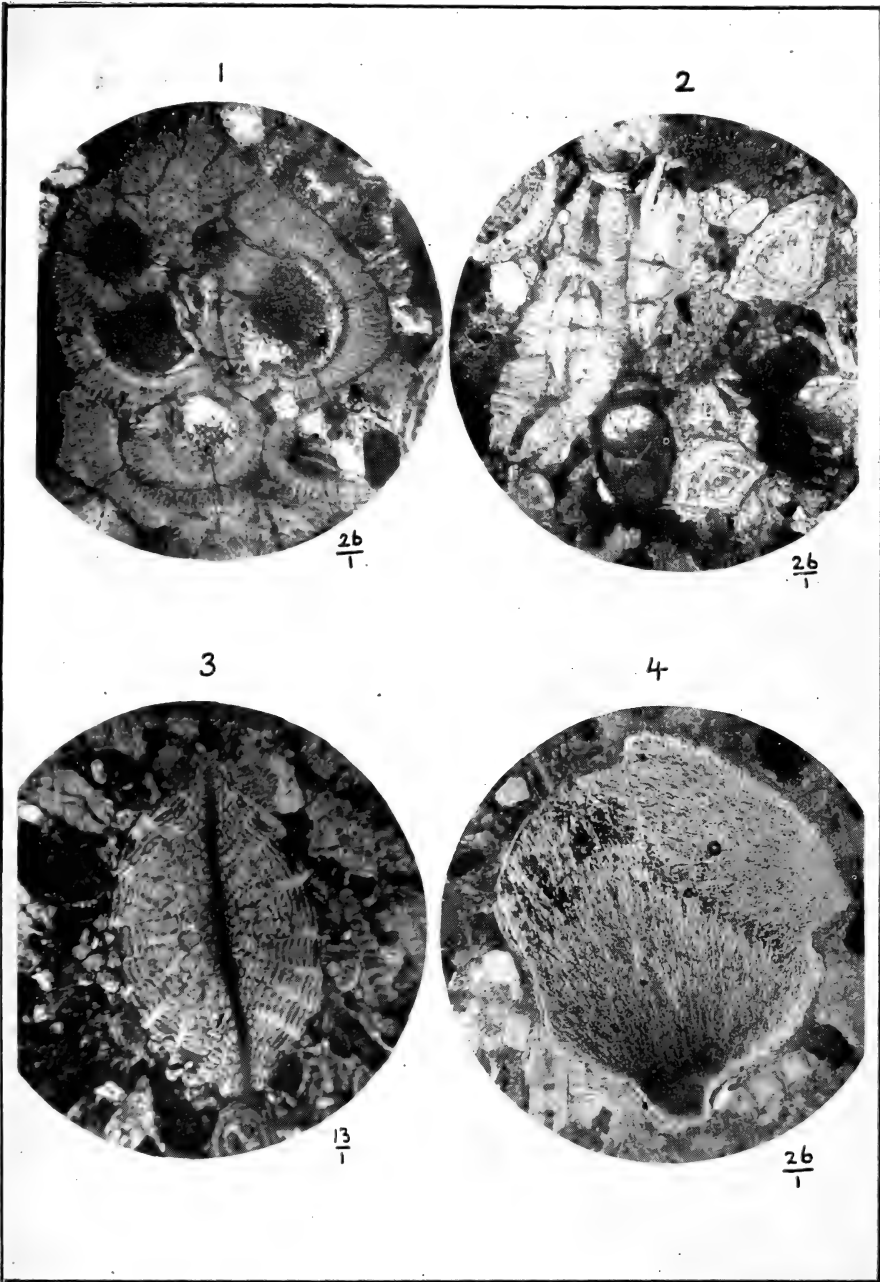

F. C., Photomicro.

FORAMINIFERA (*Carpenteria*, *Operculina*, *Amphistegina* and *Lepidocyclina*) AND FISH  
REMAINS. LOWER MIOCENE; PAPUA.



5



$\frac{8}{1}$

6

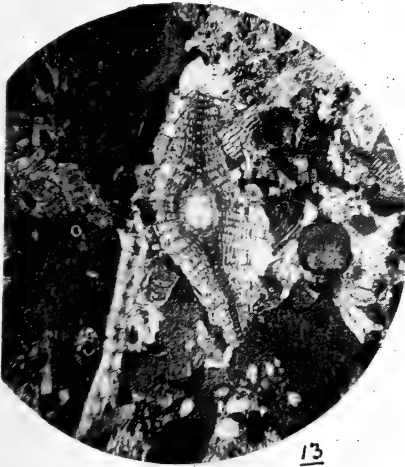

$\frac{13}{1}$

7

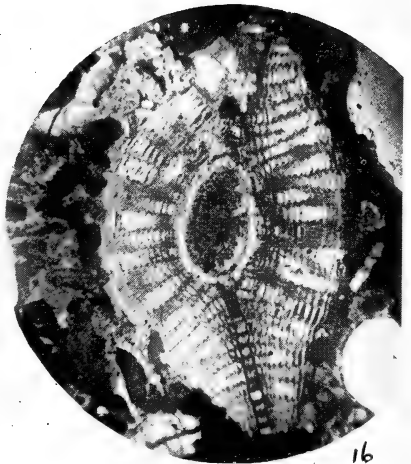

$\frac{16}{1}$

F. C., Photomier.

FORAMINIFERA (*Lepidocyclina*). LOWER MIOCENE: PAPUA.



8

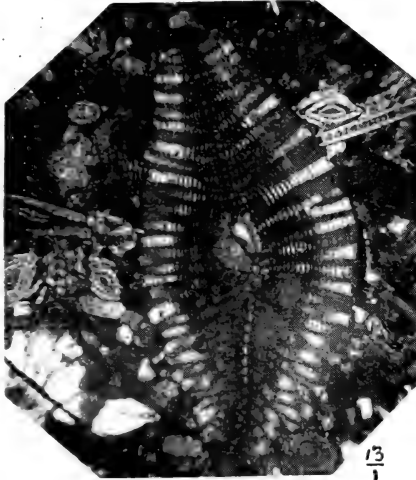

$\frac{13}{1}$

9



$\frac{26}{1}$

10

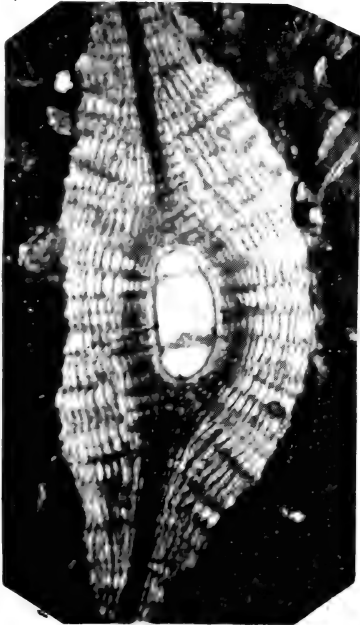

$\frac{17}{1}$

11



$\frac{19}{1}$

F. C., Photomicro.

FORAMINIFERA (*Lepidocyclina* and *Heterostegina*). LOWER MIOCENE: PAPUA.





3



2

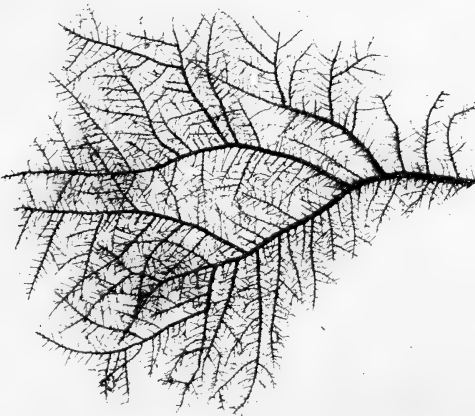

1

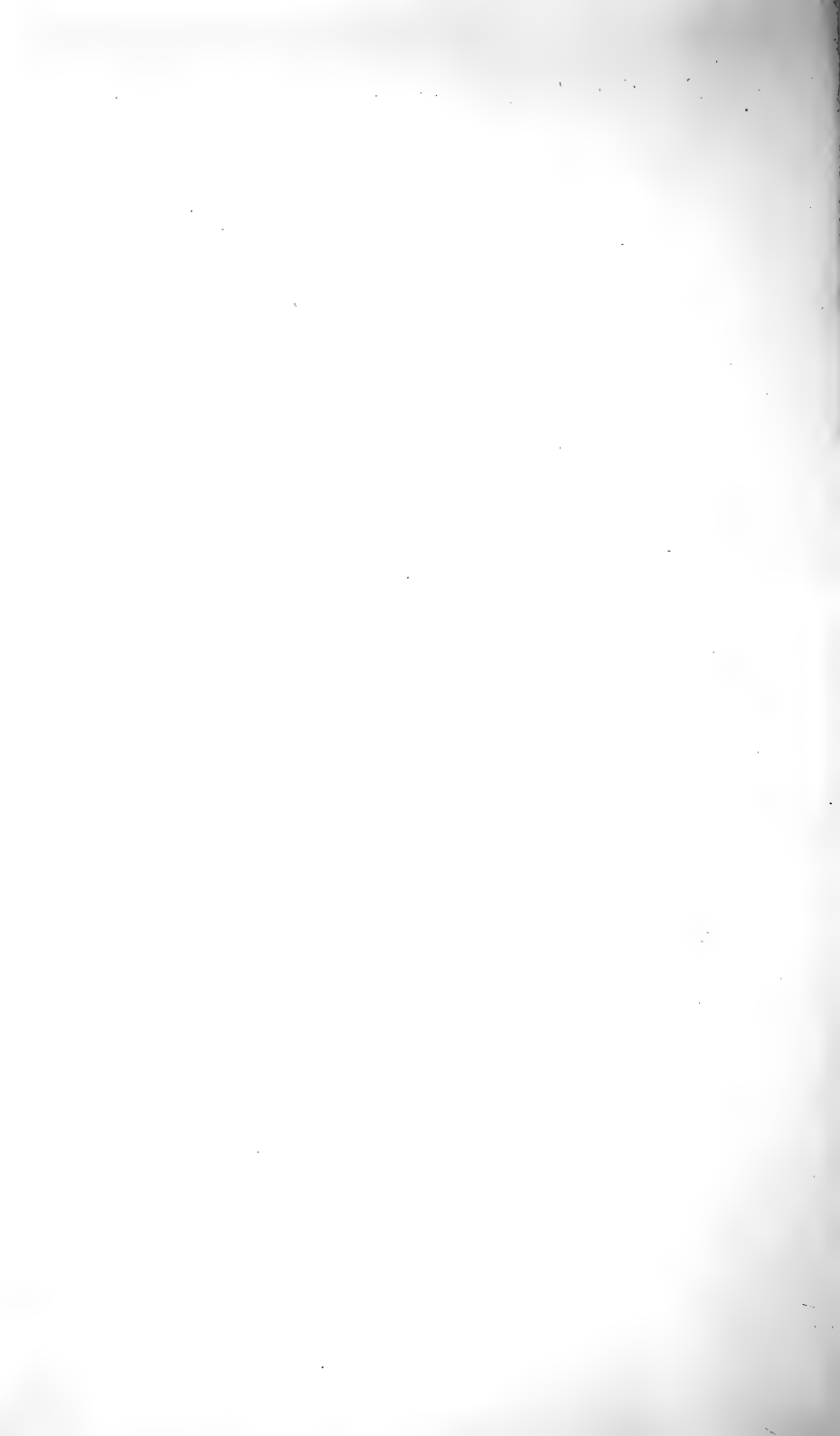



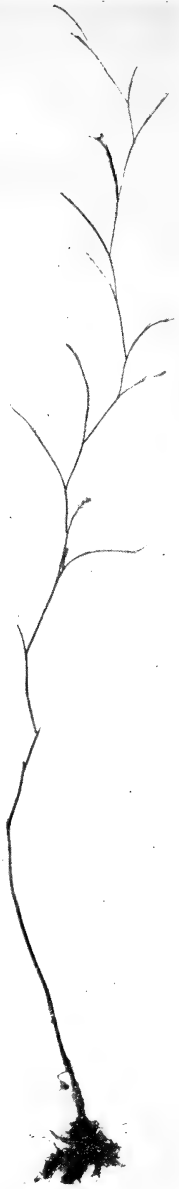

E. A Briggs, photo. 1

2





1

2

3

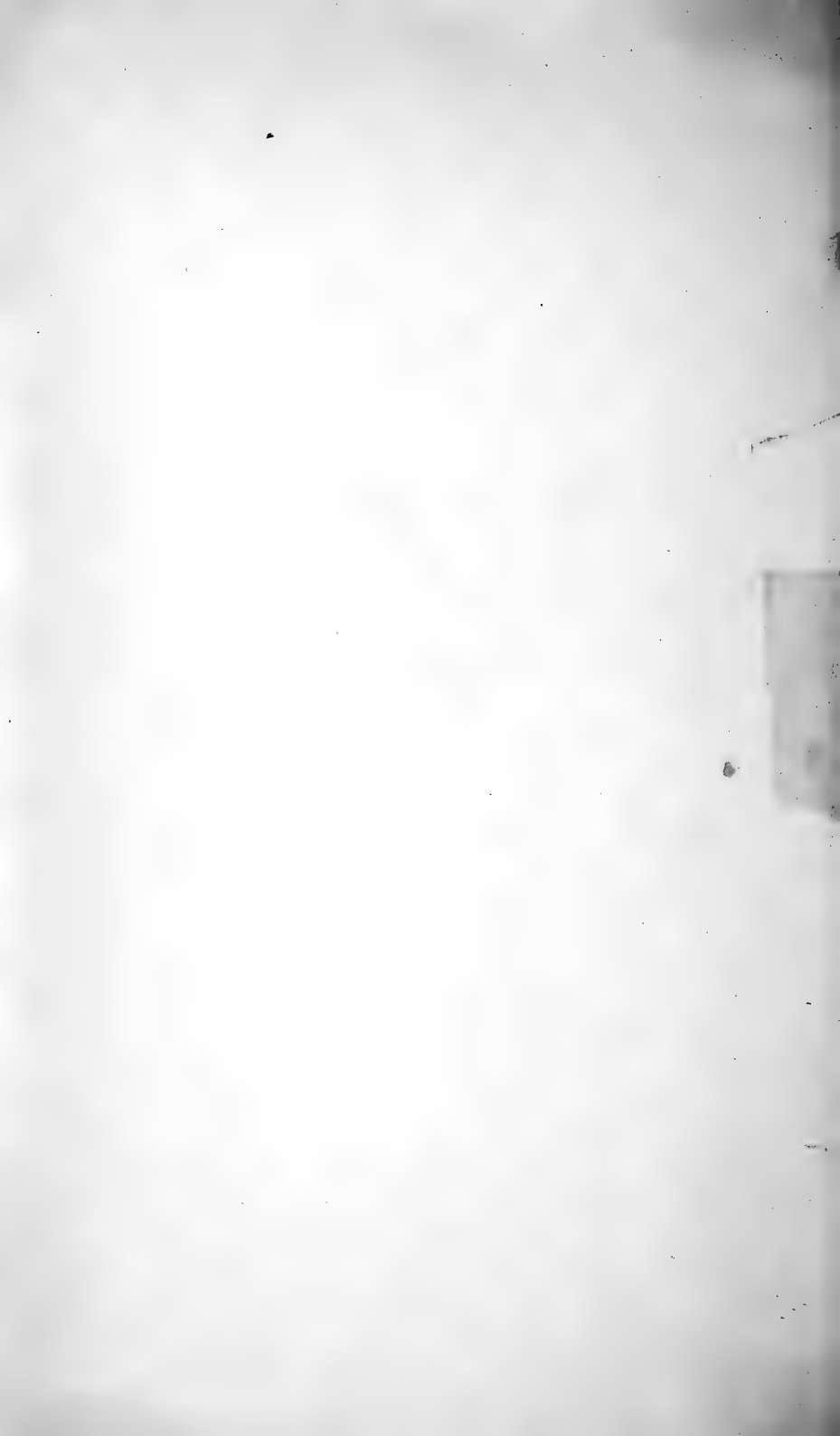



## CONTENTS.

	PAGE.
ABSTRACT OF PROCEEDINGS ... ..	i. - xxiv.
PROCEEDINGS OF THE GEOLOGICAL SECTION ... ..	...xxv - xxxiv.
TITLE PAGE, CONTENTS, PUBLICATIONS, NOTICES, ... ..	(i. - vi.)
OFFICERS FOR 1914-1915... ..	... (vii.)
LIST OF MEMBERS, &c. ... ..	... (ix.)
INDEX TO VOLUME XLVIII. ... ..	... xxxv.

R. ...

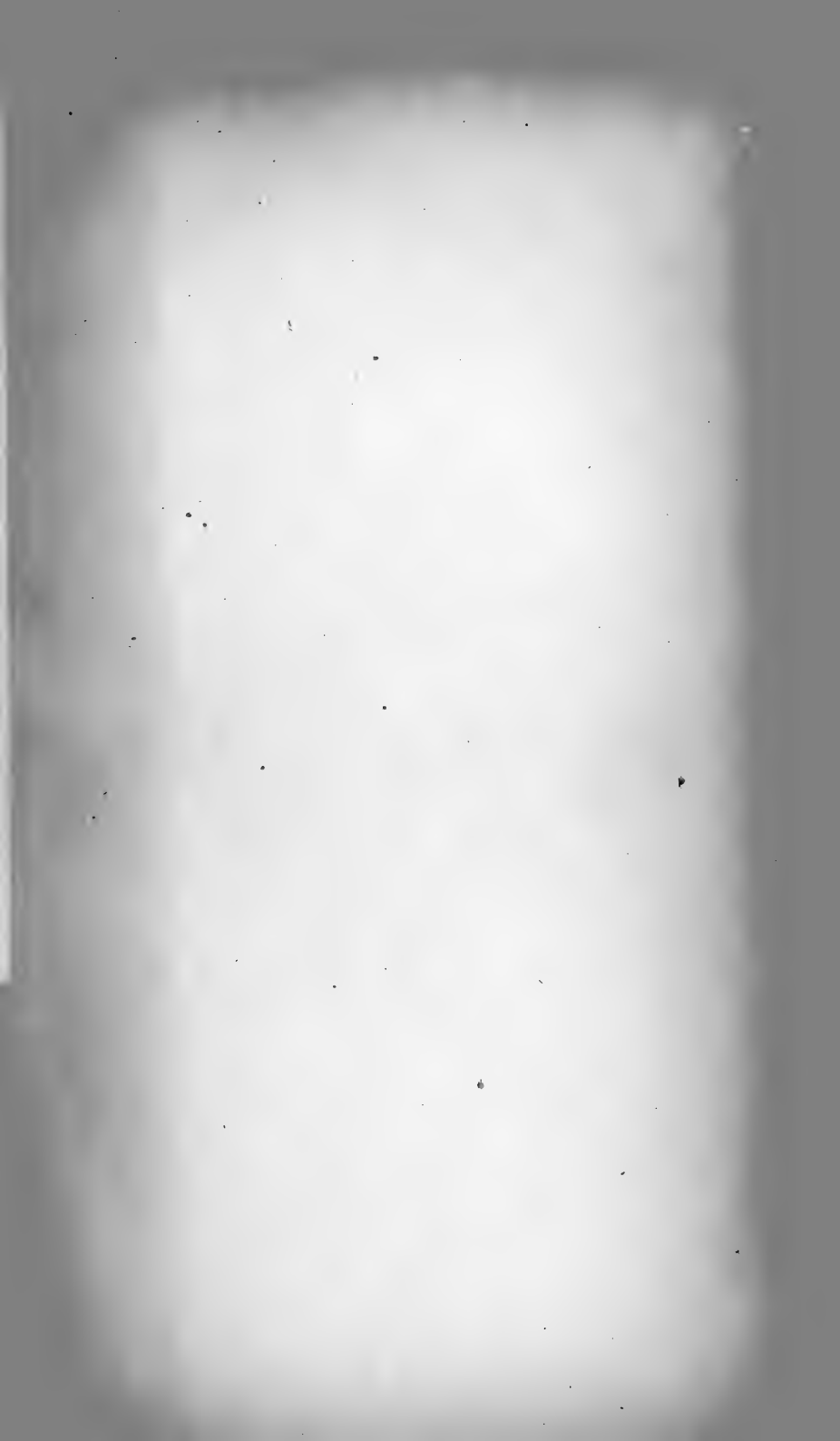

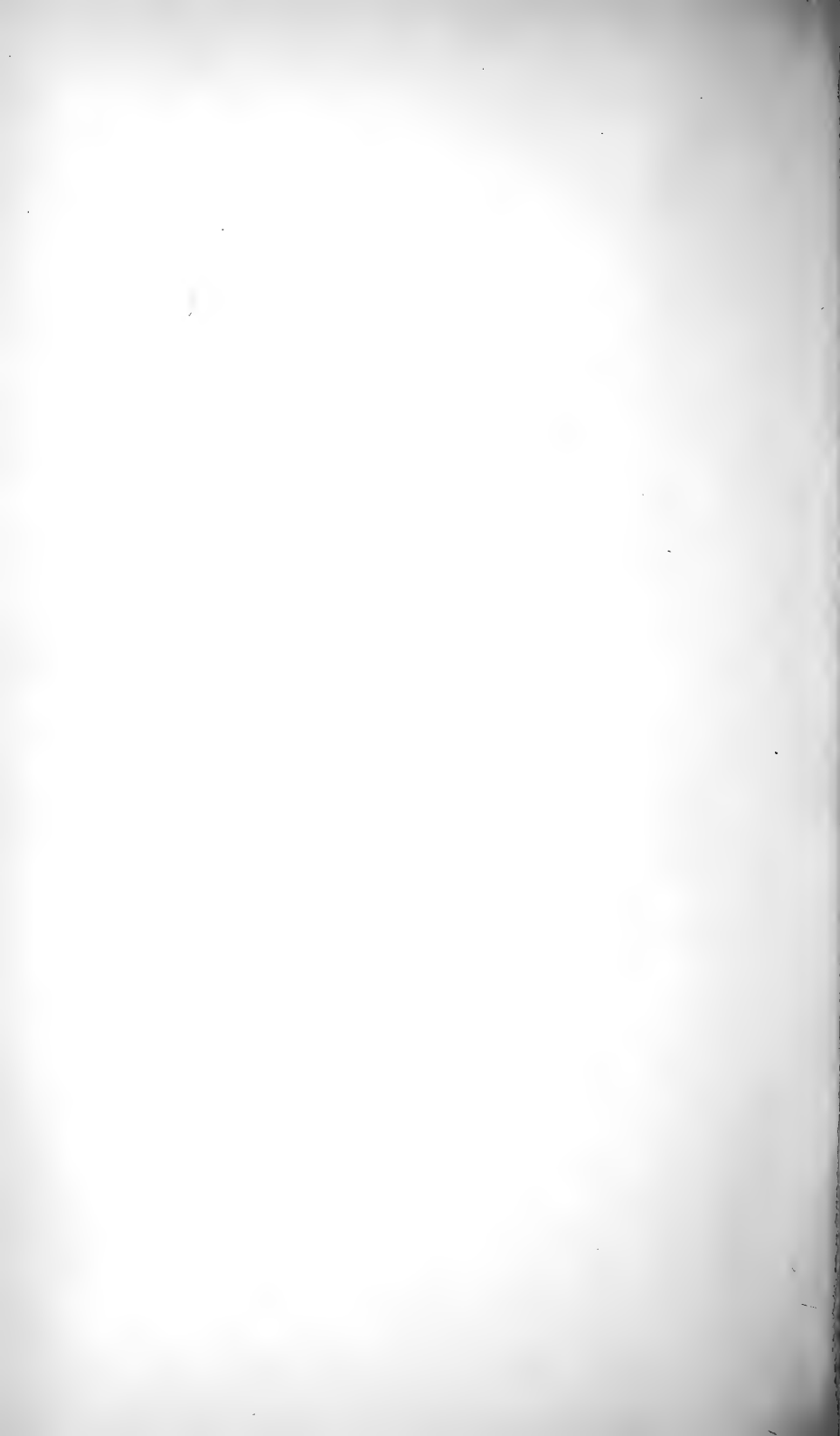



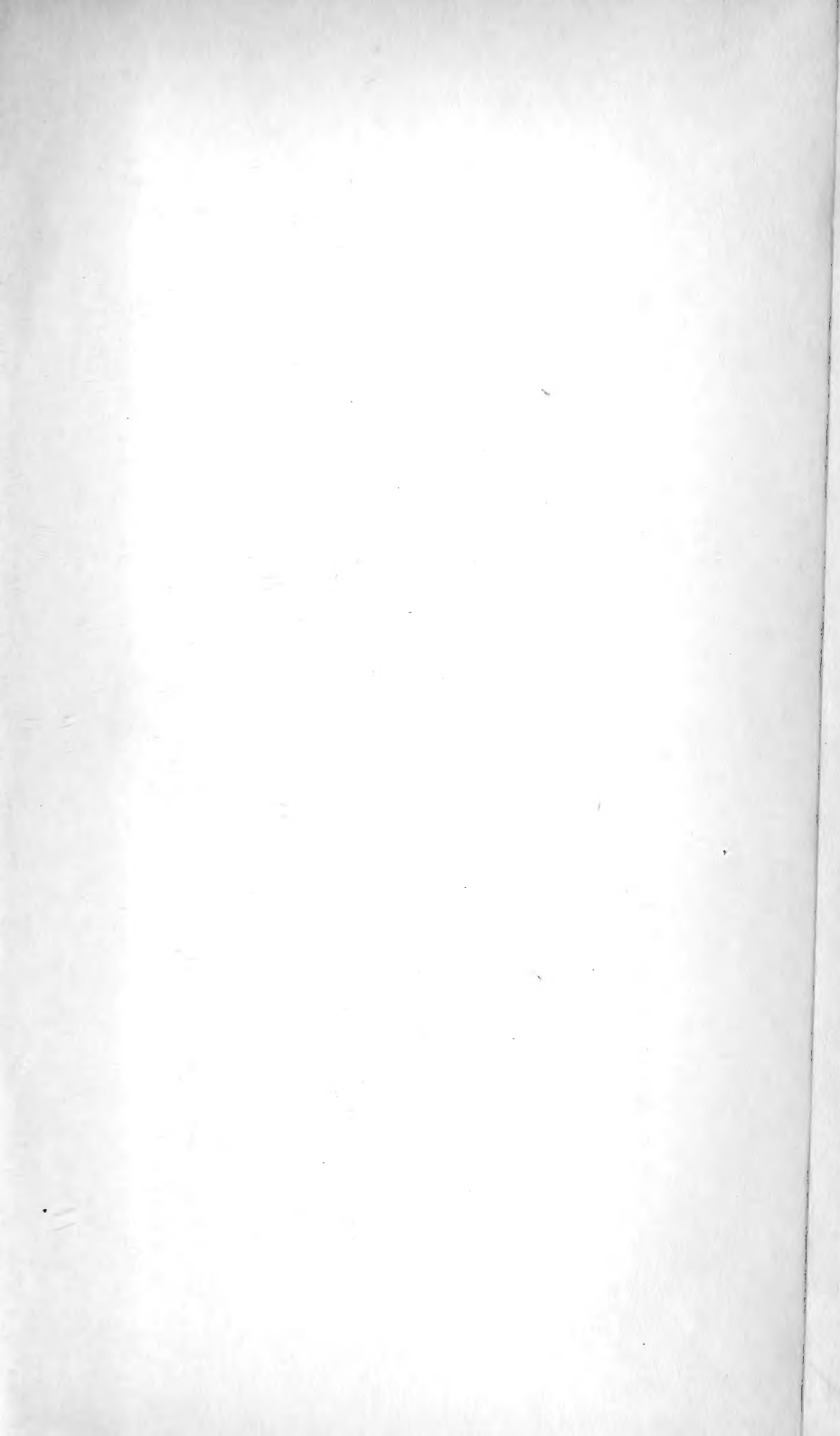





SMITHSONIAN INSTITUTION LIBRARIES



3 9088 01308 4421