



3 1761 07550856 4

WORKS OF
RALPH CLEMENT BRYANT

PUBLISHED BY
JOHN WILEY & SONS, INC.

Logging:

The principles and general methods of operation in the United States. Second Edition, Thoroughly Revised and Reset. xiii+556 pages, 6 by 9; 165 figures. Cloth, \$4.50 *net*.

Lumber: Its Manufacture and Distribution:

A forest school text and reference book for instructors and students in lumbering. xxi+539 pages, 6 by 9, 156 figures. Cloth, \$4.50 *net*.

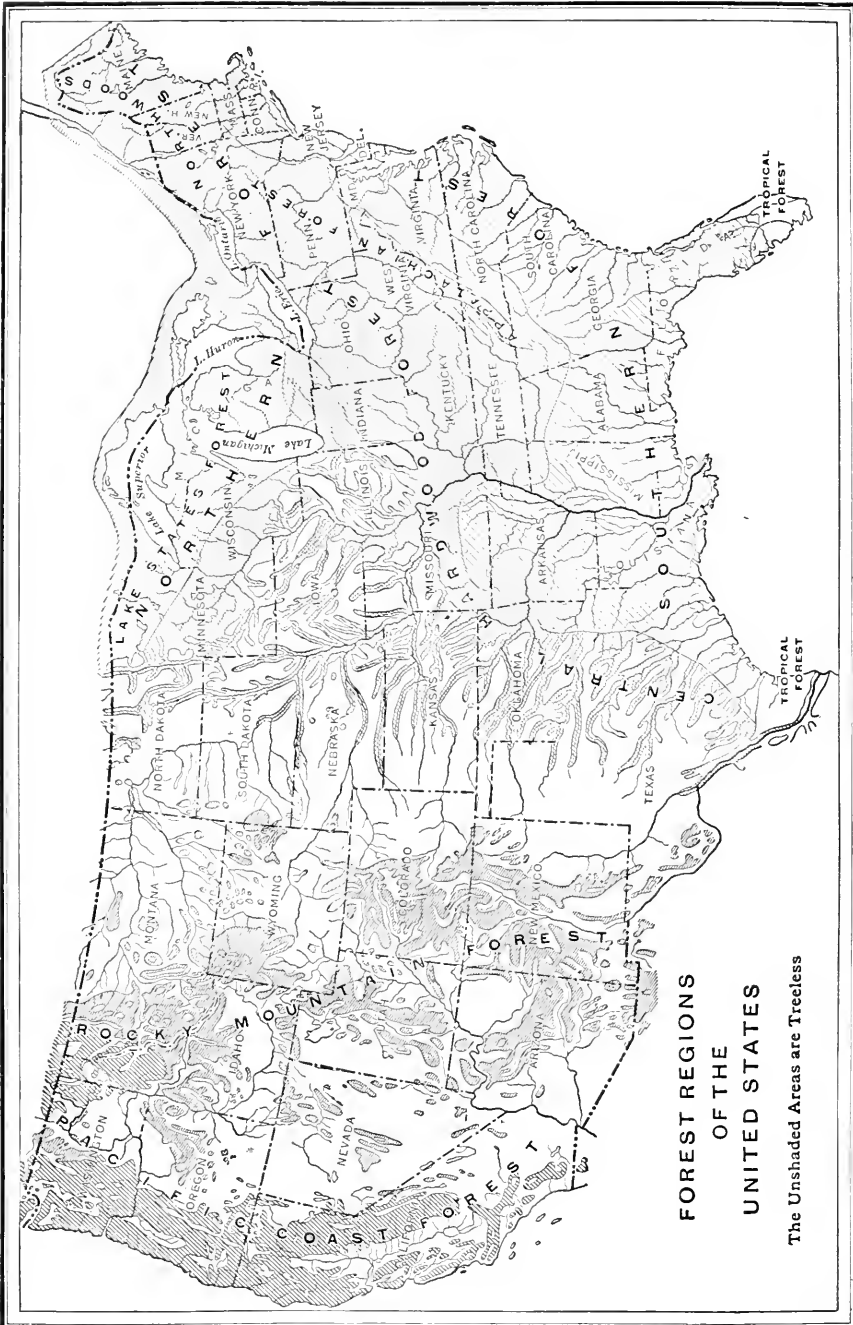

**FOREST REGIONS
OF THE
UNITED STATES**

The Unshaded Areas are Treeless

Fig. 1. — Map of the United States showing Natural Forest Regions. (U. S. Forest Service.)

LOGGING

THE
PRINCIPLES AND GENERAL METHODS
OF OPERATION IN THE
UNITED STATES

BY
RALPH CLEMENT BRYANT, F.E., M.A.

MANUFACTURERS' ASSOCIATION PROFESSOR OF LUMBERING
YALE UNIVERSITY

SECOND EDITION THOROUGHLY REVISED AND RESET

TOTAL ISSUE, SEVEN THOUSAND

NEW YORK
JOHN WILEY & SONS, INC.
LONDON: CHAPMAN & HALL, LIMITED
1923



COPYRIGHT, 1913, 1923,
BY
RALPH CLEMENT BRYANT

SD
522
B2
1923
- of 16

Stanbope Press
TECHNICAL COMPOSITION COMPANY
F. H. GILSON COMPANY
BOSTON, U. S. A.

TO
THE MEMBERS OF THE NATIONAL LUMBER MANUFACTURERS'
ASSOCIATION IN APPRECIATION OF THEIR INTEREST
IN FORESTRY EDUCATION

PREFACE TO THE SECOND EDITION

The marked development, during the past decade, in power logging machinery and methods has made it desirable to revise the first edition. A chapter has also been added on the use of crawler tractors in logging work because their rapid adaptation to the loggers' needs indicates the extensive adoption of this form of equipment. This chapter has been prepared by A. Koroleff, a Russian forest engineer, who has spent much time in studying the use of this kind of equipment on logging operations in the United States.

The subject matter has been rearranged, in part, to better meet the needs of the teacher and student and much of the text has been rewritten.

Acknowledgment is here made to those whose constructive criticisms and suggestions relating to the revision of the first edition have proved invaluable, and also to all others who have aided in the preparation of the text.

R. C. BRYANT

NEW HAVEN, CONN.
September, 1923.

PREFACE TO FIRST EDITION

This volume has been prepared as a text-book for use in Forest Schools. The subject is broad in scope and an attempt has been made to cover only the more important features of operation; hence the innumerable variations in equipment and method which are peculiar to different forest regions are not included. Of the many minor industries related to logging, only two of the more important are treated, turpentine orcharding and tan-bark harvesting.

One of the most difficult and costly features of a logging operation is the movement of the timber from the stump to the manufacturing plant and the chief facilities and methods for doing this are discussed at length, especially logging railroads. The greatest emphasis is laid on features about which there is not much written material available, while engineering subjects such as road surveys and the measurement of earth-work and rock-work are omitted because they are treated in numerous other text-books.

In preparing this volume the author has consulted freely many of the lumber trade journals, especially *The Timberman* and the *American Lumberman*; the various publications of the U. S. Forest Service; "Earthwork and Its Cost," by Gillette; articles in numerous periodicals, especially the *Forestry Quarterly*; and unpublished manuscripts.

Many of the photographs and drawings are original; the others have been secured from various sources and credit for them has been given whenever their origin was known. The data on timberland ownership are from a report on the Lumber Industry by the Bureau of Corporations of the Department of Commerce and Labor. The log rules in the Appendix were taken chiefly from the *Woodsman's Handbook*, by Graves; two tables of cubic contents are from the *Forestry Quarterly*, and one from the *Manual for Northern Woodsmen*, by Cary.

The author wishes to acknowledge his indebtedness to all who

have aided him in any way in the preparation of this volume, particularly to Prof. Samuel J. Record, who assisted in the correction of the manuscript.

R. C. BRYANT

NEW HAVEN, CONN.

April, 1913.

CONTENTS

PART I

GENERAL

	PAGE
CHAPTER I. FOREST RESOURCES.....	3
Forest Area of United States.....	3
Stand of Saw Timber in United States.....	4
Ownership of Saw Timber by Regions.....	4
Commercial Species.....	6
CHAPTER II. LOGGING METHODS.....	22
Summary of Logging Methods.....	24

PART II

PREPARING LOGS FOR TRANSPORT

CHAPTER III. FOREST LABOR.....	41
Length of Employment.....	41
Character.....	42
Methods of Employment and Payment.....	42
Payment for Services.....	49
Factors which influence Wages.....	50
Efficiency.....	51
Unions.....	53
Organization.....	56
Medical Attention.....	58
CHAPTER IV. CAMPS.....	60
Camp Location.....	60
Types of Camps.....	61
Boarding Department.....	71
Camp Hygiene.....	73
CHAPTER V. WOODWORKER'S TOOLS AND EQUIPMENT.....	82
Axes.....	82
Saws.....	83
Power Felling Machines.....	90
Power Log-making Machines.....	90
Wedges.....	91
Mauls and Sledges.....	92

	PAGE
Spring Boards	92
Killbig or Sampson	93
Tree Faller	94
Gun Stick	94
Measuring Sticks	95
Peavey	96
Cant Hook	96
Pickaroon	97
Undercutter	97
Use of Kerosene	97
CHAPTER VI. FELLING AND LOG-MAKING	98
Season	98
Deadening	100
Direction of Fall	100
Organization of Crews	101
Cutting Areas	104
Notching	105
Felling	106
Stump Heights	107
Log-making	108
Waste in Log-making	113
Barking or Rossing	116
Sniping	117
 PART III LAND TRANSPORT 	
CHAPTER VII. TRANSPORTATION	121
Secondary Transportation	123
Primary Transportation	126
CHAPTER VIII. ANIMAL DRAFT POWER	129
Oxen	129
Horses	131
Mules	132
Rations	132
Water Requirements	134
CHAPTER IX. SKIDWAYS AND STORAGE SITES	136
Log Storage in the Forest	136
CHAPTER X. HAND LOGGING AND ANIMAL SNAKING	144
Hand Logging	144
Snaking with Animals	145
Snaking Equipment	149
Crews and Daily Output	153

	PAGE
CHAPTER XI. SLEDS AND SLED-HAULING	157
The Go-devil	157
The Lizard	158
Yarding Sleds	158
The Bob	161
The Jumbo	161
The Two-sled	161
Sled Roads	164
Log Haulers	178
CHAPTER XII. WHEELED VEHICLES	184
Two-wheeled Vehicles	184
Wagons	189
Traction Engines for Wagon Haul	196
Motor Trucks	198
CHAPTER XIII. TRACTORS	204
CHAPTER XIV. POWER SKIDDING	214
Cableway or Overhead Skidding System	214
The Snaking System	229
The Slack-rope System	232
Swinging and Roding	245
Fuel Requirements	249
Spark Arresters	251
Electric Drive	252
CHAPTER XV. AERIAL TRAMWAYS	255
CHAPTER XVI. TIMBER SLIDES AND CHUTES	262
Types	262
Grades	271
Curves	272
Operation	273
CHAPTER XVII. FOREST RAILROADS	278
Pole Roads	278
Stringer Roads	281
Steel-rail Roads	283
Advantages of Railroad Transportation	283
Choice of Gauge	285
Rights-of-way	286
Location	287
CHAPTER XVIII. RAILROAD CONSTRUCTION	293
Clearing the Right-of-way	293
Fills and Cuts	294
Movement of Earth	297

	PAGE
Rock Excavation.....	304
Blasting.....	304
Explosives.....	306
Stump Blasting.....	311
Timber Work.....	313
Track Supplies.....	322
Steel Laying and Removal.....	326
 CHAPTER XIX. INCLINES.....	 334
 CHAPTER XX. MOTIVE POWER AND ROLLING STOCK.....	 341
Locomotives.....	341
Hauling Ability of Locomotives.....	346
Fuel for Locomotives.....	349
Spark Arresters.....	350
Water.....	352
Cars.....	352
Narrow Gauge.....	352
Broad Gauge.....	353
Rolling Stock and Motive Power Equipment.....	356
 CHAPTER XXI. LOADING AND UNLOADING CARS.....	 360
Loading Cars.....	360
Special Loading Devices.....	366
Unloading Log Cars.....	372

PART IV

WATER TRANSPORT

CHAPTER XXII. FLOATING AND RAFTING.....	383
Disadvantages.....	383
Requirements for a Driveable Stream.....	387
Dams.....	389
Sluice Gates.....	393
Log Carriers.....	398
Improvement of the Stream Bed and Banks.....	398
Storage and Sorting Facilities.....	402
The Drive.....	407
Log Marks and Brands.....	409
Species that float.....	412
Labor.....	413
Conduct of the Drive.....	414
Rafting on Streams.....	419
Ocean Rafting.....	427
Log Barges.....	430
Sunken Logs.....	430

CONTENTS

xiii

	PAGE
CHAPTER XXIII. FLUMES AND LOG SLICES.....	433
Type of Box.....	433
Trestles.....	438
Terminals.....	441
Location.....	442
Construction.....	445
Operation.....	447
APPENDIX	
Bibliography.....	455
Terms used in Logging.....	469
Logging Camp Kitchen Utensils.....	521
Animal Rations.....	525
Wolff-Lehmann Feeding Standards.....	525
Dry Matter and Digestible Food Ingredients.....	526
Rations fed to Animals.....	528
Weight of Feeding Stuffs.....	529
INDEX.....	531

PART I
GENERAL



LOGGING

CHAPTER I

FOREST RESOURCES

The original forested area of the United States was 822,238,000 acres and contained approximately 5,200 billion board feet of timber. The present area is about 463,461,000 acres and the total stand is estimated to be 2,215 billion board feet. The original and present areas, by regions, are shown in Table I and the present estimated volume of saw timber in each region is shown in Table II.

TABLE I
FOREST AREA OF THE UNITED STATES BY REGIONS¹

Region	Area			
	Original	Per cent of total	Present	Per cent of total
Total.....	822,238,000	100.00	463,461,000	100.00
New England.....	38,908,000	4.73	24,708,000	5.33
Middle Atlantic.....	69,610,000	8.46	28,678,000	6.20
Lake.....	103,680,000	12.60	57,100,000	12.32
Central.....	170,560,000	20.75	56,682,000	12.23
South Atlantic and East Gulf.....	170,240,000	20.75	99,000,000	21.36
Lower Mississippi.....	128,400,000	15.61	78,865,000	17.02
Rocky Mountain.....	63,720,000	7.75	60,842,000	13.12
Pacific Coast.....	77,120,000	9.35	57,586,000	12.42

¹ Based on data from "Timber Depletion, Lumber Prices, Lumber Exports, and Concentration of Timber Ownership." Report on Senate Resolution 311. Forest Service, U. S. Dept. of Agriculture, Washington, 1920.

The region west of the Great Plains has less than 26 per cent of the total forested area, yet it contains 61 per cent of the timber remaining in the United States. The New England and

Middle Atlantic regions, in which nearly one-third of the lumber produced in this country is consumed, contain only 4 per cent of the saw timber while the entire area east of the Rocky Moun-

TABLE II
STAND OF SAW TIMBER IN THE UNITED STATES BY REGIONS¹

Region	Saw timber area	Total saw timber		Softwoods	Hardwoods
	Thousands of acres	Million board feet	Per cent	Million board feet	Million board feet
Total.....	249,652	2,214,893	100	1,755,218	459,675
New England..	10,761	49,799	2	38,480	11,319
Middle Atlantic	11,455	44,857	2	15,353	29,504
Lake.....	24,030	110,110	5	40,760	69,350
Central.....	30,451	144,470	7	11,318	133,152
South Atlantic and East Gulf	46,200	220,577	10	136,827	83,750
Lower Mississippi.....	41,035	280,908	13	148,308	132,600
Rocky Mountain.....	41,059	223,141	10	223,141
Pacific Coast..	44,661	1,141,031	51	1,141,031

¹ Data from Senate Resolution 311.

tains, which consumes nearly 90 per cent of the lumber output of the country, has only 39 per cent of the saw timber.

The ownership of the saw timber is shown in Table III.

TABLE III
OWNERSHIP OF SAW TIMBER BY REGIONS (millions of board feet)¹

Region	Total	Federal		State and Municipal	Private
		Total	National Forest		
Eastern United States	850,721	8,184	4,184	10,000	832,537
Rocky Mountains.....	223,141	157,618	145,449	9,791	55,732
Pacific Coast	1,141,031	434,300	348,000	39,000	667,731
Total.....	2,214,893	600,102	497,633	58,791	1,556,000

¹ Based on data contained in Senate Resolution 311.

Private interests control 70.3 per cent of the total, the Federal

Government 27.1 per cent and states and municipalities 2.6 per cent. A Bureau of Corporation report¹ states that approximately 46 per cent of the private holdings are in the Pacific Northwest, 29.1 per cent in the southern pine region, 4.5 per cent in the Lake States and 20.4 per cent in other regions.

The ownership of the timber lands in the Pacific Northwest is concentrated in a comparatively few hands. Three interests in 1913, the date of the report, controlled 11 per cent, eight holders 15.6 per cent, twenty-two holders 20.8 per cent, and one hundred and ninety-five holders 38 per cent of the total privately owned stumpage in the United States.

In the South the holdings have not been so large because the stand of timber per acre is lower than on the Pacific Coast, and there have not been the large land grants which were common in the West; consequently the timber has been held by a greater number of companies. Twenty-nine interests owned 16 per cent of the total standing timber in the region; sixty-seven holders, 24 per cent; one hundred and fifty-nine owners, 33 per cent; and five hundred and fifty-eight holders, approximately 50 per cent. The sixty-seven largest interests controlled 39 per cent of the longleaf, 19 per cent of the loblolly and shortleaf, 29 per cent of the cypress and 11 per cent of the hardwood stumpage. In 1912 it was estimated that only 1,200,000 acres of yellow pine, containing 18,000,000,000 board feet were not held by manufacturers.²

In the Lake States, six interests controlled 54 per cent of the white and Norway pine stumpage, 16 per cent of other conifers and 2 per cent of the hardwoods, and thirty-three interests controlled 77 per cent of the white and Norway pine.

The timber in other regions is divided among many owners, controlling a limited acreage. Few holdings in the Northeast aggregate more than 100,000 acres.

The chief logging regions previous to 1870 were the New England and Middle Atlantic States, but about 1880 the Lake States showed a larger production than any other section. Although

¹ See *The Lumber Industry, Part I, Standing Timber*. Bureau of Corporations, Dept. of Commerce and Labor, Washington, 1913.

² Estimate by James D. Lacey and Co., Chicago, Illinois. See *Official Report Tenth Annual Convention National Lumber Manufacturers' Association*, May 7 and 8, 1912, p. 94.

they still ranked first in 1899 a rapid decline soon began and the center shifted to the southern states which have ranked first since that time, although the output on the Pacific Coast is rapidly approaching that in the South. Before the close of the next decade the center of production will move to the West Coast which contains the greater part of the reserve supply of saw timber in this country.

COMMERCIAL SPECIES

Softwoods comprise approximately 71 per cent of the total saw timber in the United States, 61 per cent of which is found in the Pacific Coast forests. Douglas fir represents the largest volume of softwoods, namely, 34 per cent, southern yellow pine 14.6 per cent, western yellow pines 14.2 per cent, western hemlock 5.4 per cent, the true firs 5.4 per cent and redwood 4.1 per cent. The remainder is represented by many species of which western white pine, sugar pine, western red cedar, lodgepole pine, western spruce, eastern spruce and eastern hemlock are the more important from the standpoint of volume.

The commercial hardwoods are all found in the eastern forests, and among them oak is the most important representing 33 per cent, birch, beech and maple 16.3 per cent, and red gum 9.6 per cent. The remainder includes many species among the more important of which are chestnut, hickory, cottonwood, ash and yellow poplar.

The stand by species and by regions is shown in Table IV.

SOFTWOODS

Douglas fir. — This species (*Pseudotsuga taxifolia*) also known as Oregon pine, is the most important tree on the Pacific Coast from which lumber is produced. The largest manufacturing plants are located on Puget Sound, the Columbia River and harbors along the Pacific Ocean in Washington and Oregon. A major part of the log supply for these mills is carried by railroads to tide water or to large streams where it is rafted and towed to the manufacturing plants. The lumber is marketed locally, in the prairie regions both west and east of the Mississippi River and an extensive market is being developed along the Atlantic Seaboard, shipments coming chiefly via the Panama Canal. The export trade also provides an outlet for a relatively large volume of lumber

TABLE IV
STAND OF SAW TIMBER BY SPECIES AND REGIONS (millions of board feet)¹

Species	Total	New England	Middle Atlantic	Lake States	Central	South Atlantic and East Gulf	Lower Mississippi	Rocky Mountains	Pacific Coast
Eastern Hardwoods.....	459,675	11,319	29,504	69,350	133,152	83,750	132,000		
Oak.....	157,372	1,510	5,500	8,301	64,712	27,889	49,460		
Birch, Beech and Maple.....	90,784	8,143	16,897	36,076	20,505	4,522	4,641		
Red Gum.....	44,222	176	3,728	13,400	26,918		
Chestnut.....	19,319	960	3,754	7,989	6,616		
Hickory.....	15,784	40	412	187	6,791	3,483	5,171		
Cottonwood and Aspen.....	10,824	374	13	999	2,131	1,340	5,967		
Ash.....	9,988	215	513	1,893	2,929	1,256	3,182		
Yellow Poplar.....	9,611	126	7	5,193	4,020	265		
Others.....	101,771	77	2,113	21,887	19,174	21,524	36,996		
Eastern Softwoods.....	391,046	38,480	15,353	40,760	11,318	136,827	148,308		
Southern yellow pine.....	257,691	365	121,412	135,884		
Hemlock.....	30,896	1,804	5,036	18,301	3,910	1,845		
Spruce and fir.....	31,572	23,971	2,948	3,772	881		
Cypress.....	22,921	11,208	11,713		
White and Norway pine.....	23,457	9,816	4,037	8,000	515	1,089		
Others.....	24,509	2,889	3,332*	10,687	6,528*	362	711		
Western Softwoods.....	1,364,172	223,141	1,141,031
Douglas fir.....	595,505	36,934	558,571
Western yellow pine and Jeffrey pine.....	249,578	66,125	183,453
Western hemlock.....	95,092	1,092	94,000
True firs.....	91,349	8,870	82,479
Redwood.....	72,208	72,208
Western white pine and sugar pine.....	57,071	18,586	38,485
Western red cedar.....	53,348	4,348	49,000
Lodgepole pine.....	43,919	39,353	4,566
Spruce.....	39,822	13,555	26,267
Others.....	66,280	21,366	44,914

* Includes small amounts of various species of yellow pine.

¹ Based on Senate Resolution 311.

which is shipped to Europe, Asia, the South Sea Islands and the western coast of South America.

Douglas fir grows in dense, almost pure stands in the Pacific Coast region yielding an average of from 35,000 to 60,000 board feet of merchantable timber per acre, with from 150,000 to 250,000 feet in the better stands. Single trees have scaled 60,000 feet. The maximum reported yield per acre of Douglas fir is 585,000 feet. This timber grew on the north shore of Puget Sound.

The cut of Douglas fir in 1920 was 6,960,000,000 board feet.

Southern Yellow Pine. — There are three species of yellow pine of commercial importance in the southern region; namely, longleaf (*Pinus palustris*), shortleaf (*P. echinata*), and loblolly (*P. taeda*). The lumber manufactured from them is often marketed under the trade name of southern yellow pine, although it is customary for manufacturers in the longleaf region to sell all species under the name of "longleaf," while in parts of Arkansas and Louisiana loblolly is marketed as "soft shortleaf." In the Coastal Plain region of Virginia and the Carolinas where loblolly predominates the product is sold under the trade name of "North Carolina Pine." In some of the large eastern markets like New York and Philadelphia southern yellow pine often is sold under the trade name of "longleaf," or of "shortleaf," the distinction being based on the physical character of the wood. The term longleaf is applied to timbers and lumber having narrow annual rings, while coarse-grained lumber is called shortleaf.

Longleaf is preferred for timbers and flooring when maximum strength or wearing quality is desired, while loblolly and shortleaf are used chiefly for finish and for general construction purposes.

The annual production of yellow pine reached its maximum in 1909. Operators estimate that many of the largest mills will be cut out during the next ten years.

The yellow pine forests are now the source of most of the lumber consumed in the South, and much of that used in the prairie regions of the Middle West. Southern yellow pine products are also shipped to New England, Canada, nearly all countries of Europe, to many parts of eastern South America and to the West Indies. They also have been the chief source of the railroad lumber supplies of the East and South.

The longleaf forests for many years have furnished a large part of the world's supply of naval stores.

The manufacture of by-products, such as pulp, and products of distillation from mill waste and forest refuse is growing in importance.

Longleaf grows chiefly in pure stands which run from 5000 to 25,000 board feet per acre; shortleaf which seldom exceeds 6000 feet per acre occurs with hardwoods on richer soils; virgin loblolly in southern Arkansas is associated with shortleaf in nearly pure pine forests ranging from 5000 to 30,000 feet per acre, the former comprising from 60 to 80 per cent of the total stand. The average stand over large areas does not exceed 10,000 feet. In the Coastal Plain region the second-growth forests of loblolly average from 5000 to 6000 feet per acre with a maximum of 15,000 feet. The choicest longleaf stumpage is found in Calcasieu Parish in southwestern Louisiana. Logging has become more intensive during recent years and loggers now get from three to five times more timber per acre than formerly.

The lumber cut in 1920 was 11,091,000,000 board feet.

Western Yellow Pine. — Western yellow pine (*Pinus ponderosa*) is one of the more important merchantable species in the Rocky Mountain region. Its market is chiefly confined to the territory in which it grows where it is used for general construction purposes and for mining timbers.

The stand in the Sierras, where it grows in mixture with sugar pine, Douglas fir, incense cedar and firs, ranges from 2000 to 22,000 board feet per acre with an average of about 8000 feet. In Arizona and New Mexico it ranges from 3500 to 15,000 feet per acre and in the Black Hills of North Dakota about 6,000 feet. Maximum stands of 40,000 feet per acre have been reported.

The cut of western yellow pine for 1920 was 2,290,000,000 board feet.

White Pine. — White pine (*Pinus strobus*) is of less importance in our lumber markets than formerly. Its manufacture is now chiefly confined to the state of Minnesota which contains the greater part of the remaining stumpage.

Intensive utilization is practised, because of the high value of the better grades of lumber and the extensive demand for low grades for box board material for which this species is especially adapted.

The virgin stands of white pine in Michigan averaged from 10,000 to 75,000 board feet per acre, although a yield of 25 000 feet was considered good.

The cut of eastern white pine is decreasing each year, the records for 1920 showing a total of 1,500,000,000 board feet.

Western white pine (*Pinus monticola*) grows in Idaho, Montana and Washington and is now being substituted in the markets for eastern white pine. This timber is sold largely outside of the home territory, because Douglas fir and other woods can undersell it in the local markets.

The tree rarely occurs in pure stands, but is associated with western larch (*Larix occidentalis*), western red cedar (*Thuja plicata*) and other firs (*Abies sp.*). It reaches its best development in Idaho, where in mixed stands of the above species ranging from 25,000 to 70,000 board feet per acre it comprises from 60 to 70 per cent of the total. An occasional acre contains 130,000 board feet. A single tree has yielded 29,800 board feet of lumber.

The lumber cut in 1919 was 297,421,000 board feet.

Hemlock. — There are two species now on the market known as eastern hemlock (*Tsuga canadensis*), and western hemlock (*T. heterophylla*).

It is only within the last thirty years that eastern hemlock has been regarded as of much value except for its bark, and even to-day the latter often commands as high a price as the timber.

Hemlock grows both in pure forests and associated with other conifers. In Pennsylvania pure stands run as high as 15,000 board feet per acre. The average in northern Michigan is 9000 feet. In West Virginia, where hemlock occurs in a mixed forest, the average is from 2000 to 3000 feet per acre. The heaviest stands in the Appalachians range between 25,000 and 40,000 feet per acre.

The lumber cut in 1919 was 1,415,238,000 board feet.

The western hemlock grows in the Pacific Coast forests, associated chiefly with Douglas fir and western red cedar. The lumber is superior to that of eastern hemlock. The bark is richer in tannin but it is not used extensively, because there are not many tanning establishments in the region and extract plants have not been developed because high freight rates to eastern points limit the available market. The timber is used for general construction purposes and, to a limited extent in Oregon, for the manufacture of paper pulp.

The yield per acre ranges from 7000 to 30,000 board feet.

The lumber cut for 1919 was approximately 339,760,000 board feet.

Redwood. — The redwood (*Sequoia sempervirens*) is confined to a narrow belt from 10 to 30 miles wide near the Pacific Coast, extending southward from southern Oregon to San Luis Obispo County in California. It is associated with Douglas fir, tanbark oak (*Quercus densiflora*), western red cedar and western hemlock. The chief commercial stands are in Humboldt and Del Norte Counties in the northern part of California.

The average yield per acre is from 60,000 to 75,000 board feet, although 100,000 feet per acre is not uncommon. Single acres are said to have yielded 1,500,000 feet of sawed lumber, and individual trees have contained 480,000 board feet of merchantable timber. The highest stand so far reported is 2,500,000 feet per acre, but the yield in merchantable material was reduced 40 per cent through breakage and other losses. The waste in logging redwood is enormous, because of the massive size of the trees and the brittle character of the timber.

The trees average 6 or 7 feet in diameter, although from 10 to 14 feet is not uncommon, with a maximum of about 20 feet. The clear length ranges from 100 to 200 feet.

The lumber is marketed along the Pacific Coast, in the Far East, and some high grade lumber is shipped to the central and eastern parts of the United States. It furnishes wide boards of excellent quality for panels and interior finish. In the West it is used extensively for tanks, flume boxes, house construction, fence posts, shingles and shakes.

There is very little redwood stumpage on the market, because the greater part of the timber is held by companies which are now exploiting it.

The lumber cut¹ in 1920 was approximately 476,500,000 feet.

Cypress. — The commercial range of cypress (*Taxodium distichum*) is confined to a narrow strip of swampy land extending along the Atlantic seaboard from North Carolina to Florida, along the Gulf Coast in Florida, Louisiana and western Mississippi, and up the Mississippi River to southern Arkansas.

The average stands range from 5000 to 8000 board feet per acre, the better ones containing from 15,000 to 20,000 feet while an occasional acre in Louisiana reaches a maximum of 100,000

¹ This includes the cut of the bigtree (*Sequoia Washingtonia*).

feet. It is a swamp species wherever it occurs in commercial quantities and its exploitation presents numerous problems not found in dry-land logging.

It has been stated that at least one-third of the standing cypress is affected with a fungous disease, which causes holes in the wood from $\frac{1}{4}$ to 1 inch wide and often several inches long. Timber so affected is called "pecky" or "peggy" cypress. The disease is caused by a species of *Daedalia* which also attacks the incense cedar of the Pacific Coast. Decay stops as soon as the tree is cut and manufactured into lumber. Cypress timber on knolls just above the level of the water is usually unsound and the trees are fewer in number than on the wet lands. Sound timber occurs in patches in the forest without apparent regularity. It is difficult to distinguish pecky trees before they are cut. The trees in the Atchafalaya River basin are of larger size and less defective than those in the Mississippi River bottoms.

Cypress is an extremely durable wood and is especially esteemed for greenhouse construction, certain forms of cooperage, silos, tanks, shingles, interior and exterior finish for buildings, and all purposes where resistance to decay is important.

The lumber cut in 1920 was approximately 625,000,000 feet.

Eastern Spruces. — There are three species which are found chiefly in Maine, northern New Hampshire, Vermont, New York, West Virginia and North Carolina. They are the white spruce (*Picea canadensis*), red spruce (*P. rubra*) and the black spruce (*P. mariana*). The present stand is estimated at 31 billion board feet, a large part of which is in New England and New York.

Spruce occurs in pure stands on the higher elevations, and in mixture with beech, birch, hard maple and eastern hemlock on the lower elevations. It reaches its best form in the mountains of West Virginia at an elevation of from 3000 to 4600 feet. Balsam fir (*Abies balsamea*) is associated with spruce in the northern part of its range and is now marketed with it for pulpwood, without distinction as to price.

Spruce is one of the most valuable species for the production of paper pulp and several million cords of Canadian and domestic spruce are consumed annually for this purpose. It also is used for house timbers, clapboards and general construction purposes although the production of spruce lumber has greatly declined

during recent years owing to the higher profits made from converting spruce stumpage into pulpwood.

The chief home markets are in New England and the Northern tide-water ports.

The following shows the approximate stands in the various states:

	Stands per acre	
	Average	Maximum
	Board feet	Board feet
New York.....	2000- 3000	15,000
Maine.....	3000- 4000	15,000-20,000
New Hampshire.....	3000- 4000	40,000
Vermont.....	3000- 4000	15,000
West Virginia.....	6000-10,000	60,000

The cut of lumber in 1919 was 534,685,000 board feet.

Western Cedars. — The cedars of the Pacific Coast which are of the greatest commercial importance are the western red cedar (*Thuja plicata*), the yellow cypress (*Chamaecyparis nootkatensis*) Port Orford cedar (*C. lawsoniana*) and the incense cedar (*Libocedrus decurrens*).

Western red cedar is the most important shingle wood in the United States, and is also cut extensively for telephone and telegraph poles. When cut into lumber it is used for car siding and roofing, weather-boarding, pattern-making, boat building, cabinet manufacture and a variety of other purposes where strength is not required.

It seldom occurs in pure stands, but is associated with Douglas fir, western hemlock, western larch (*Larix occidentalis*), several species of firs and redwood. The average stand per acre over large areas, is from 9000 to 10,000 board feet, with maximum stands of 40,000 feet.

Yellow cypress which is less widely known in the market, is used for boat building, cabinet work, cigar boxes, lead pencils and interior finish.

It is associated with Sitka spruce (*Picea sitchensis*), western hemlock, and other species of minor importance. It occurs singly, or in small groups and, in Alaska, runs from 500 to 2500 board feet per acre. Single acres are said to contain 40,000 feet.

Port Orford cedar is limited in amount and is not marketed extensively. It is a favorite wood for ship building, and is also used for interior finish, outside trim, match wood and cabinet work for which it is especially fitted. It is usually associated with western red cedar, Sitka spruce, western hemlock and Douglas fir. It occurs as single trees, rarely in groups.

Incense cedar is not cut into lumber to any extent, because of the excessive taper of the bole, and also because a large percentage of the timber is attacked by a fungus (*Daedalia vorax*) which excavates galleries throughout the wood similar in character to the "peck" in cypress. The timber is used chiefly for fence posts, laths, shingles, cigar boxes, pencil stock, and the best grade lumber for furniture and for mining and irrigation flumes.

It is associated with western yellow pine, sugar pine, Douglas fir, western white pine and white fir (*Abies concolor*). The stand per acre in California ranges from 500 to 2000 board feet per acre.

The lumber cut of western cedars in 1919 was 332,234,000 feet of lumber.

Sugar Pine. — Sugar pine (*Pinus lambertiana*) is found chiefly in southern Oregon and in California where it is an important commercial tree. It occurs in mixed stands associated with western yellow pine, incense cedar and Douglas fir on the lower limits of its range; and with white fir, red fir (*Abies magnifica*) and the bigtree on the higher elevations. The yield in the Sierras ranges from 2000 to 15,000 board feet per acre with a maximum of 60,000 feet. An occasional tree contains 54,000 feet.

Sugar pine is especially prized for the manufacture of "shakes" or split shingles, and is also extensively used for fruit boxes, match wood, sash, doors, and blinds, ship decking and interior trim. The lumber is often substituted for that of eastern white pine. The greater part is marketed locally, but it is also shipped as far East as New England.

The cut in 1919 was 133,658,000 feet.

Lodgepole Pine. — This tree (*Pinus contorta*) is found from Alaska to California and east to Colorado, and is used for mine timbers, fence posts, lumber and crossties. The timber is small and knotty and lumber sawed from it is suitable only for general

construction purposes. It is not in demand for interior finish except in the vicinity of the region where it is manufactured.

YIELD PER ACRE IN BOARD FEET, GALLATIN COUNTY,
MONTANA¹

(Cutting to a diameter breast high of 11 inches.)

Type	Lodgepole pine
	Board feet
Creek.....	5900
Eastern Slope.....	7200
Western Slope.....	3800
Northern Slope.....	7000

YIELD PER ACRE IN BOARD FEET, MEDICINE BOW
NATIONAL FOREST, WYOMING¹

(Cutting to a diameter breast high of 11 inches.)

Type	Lodgepole pine			Spruce lumber
	Ties, 6 inches by 8 inches by 8 feet	Props.	Lumber	
	Number	Linear feet	Board feet	Board feet
Pine forest:				
Quality I.....	200	1100	3000	1000
Quality II.....	130	600	1100	200
Quality III.....	50	240	550	60
Spruce forest.....	55	230	700	4700
Average for tract.....	108	500	1100	500

¹ From Forest Tables — Lodgepole Pine. Circular 126, U. S. Forest Service, 1907, pp. 23-24.

Lodgepole pine often occurs in dense pure stands in the Sierras. At high elevations it is frequently associated with Douglas fir, alpine fir (*Abies lasiocarpa*) and other firs.

Lodgepole in pure stands ranges between 4000 and 30,000 board feet per acre, the average over large areas being about 8000 feet.

The cut in 1919 was 16,281,000 board feet.

Western Spruce. — The spruces of importance in the western part of the United States are the Engelmann spruce (*Picea engelmanni*) and the Sitka spruce.

Engelmann spruce grows at high altitudes often in pure forests. It is frequently associated with alpine fir, western larch, lodgepole pine and western yellow pine.

The timber is sawed into lumber and dimension stock for local construction purposes.

On moist flats and along streams Engelmann spruce and lodgepole pine form stands containing from 40,000 to 50,000 board feet. On the Pike National Forest the maximum stands are 35,000 feet and the average stands 5000 feet. In the Sopris National Forest in Colorado, the stands of Engelmann spruce and associated species range from 4000 to 20,000 feet per acre from 35 to 75 per cent being Engelmann spruce.

Sitka spruce is the chief commercial species of Alaska and is also found in large quantities in Washington and Oregon. It is seldom found in pure stands, except on areas of from 1 to 3 acres on which the stand ranges from 10,000 to 90,000 board feet per acre. Individual trees have been reported which contain 25,000 feet. On the lower elevations which is the only place it grows to commercial size it is usually associated with western hemlock, western red cedar and yellow cypress.

The product from the West Coast forest is used for finish, siding, factory stock, box boards and laths. It is also highly prized for airplane construction. In Alaska it is used chiefly for box shooks for the salmon industry and for building material.

The lumber cut of the western spruces in 1919 was approximately 445,283,000 feet, the greater part of which came from Washington and Oregon.

Other Conifers. — Among the conifers cut in small quantities are the eastern larch (*Larix americana*) now often sold with Norway and white pine, and also made into crossties, posts and poles; the western larch (*L. occidentalis*) manufactured into dimension lumber, ties and posts; eastern red cedar (*Juniperus virginiana*) used chiefly for pencil wood, posts and poles; and a number of pines found in the western part of the country which are of local importance only.

HARDWOODS

The hardwood forests extend south from northern New York through the Appalachian Mountains and from central Wisconsin and Michigan through the valleys of the Mississippi and

Ohio Rivers to central Louisiana, Mississippi and Alabama, and west to the Great Plains. The chief commercial species are the oaks, sugar maple, yellow poplar, red gum, chestnut, beech, birch, basswood, hickory, elm, ash and cottonwood.

The lumber cut in 1919 of the above hardwoods was 6,872,576,000 board feet or 20.3 per cent of the total lumber cut of the country.

Yellow Poplar. — One of the more valuable hardwoods is the yellow poplar (*Liriodendron tulipifera*) which occurs, chiefly, in the rich hardwood forests of Virginia, West Virginia, Tennessee, North Carolina and Kentucky. It is used chiefly for weatherboarding, interior finish, furniture, bodies of automobiles and carriages, wagon boxes, woodenware, box boards and paper pulp. Wide boards command a high price for panels and shelving.

The average stand per acre is seldom more than 2000 board feet.

The cut in 1920 was 350,000,000 board feet.

Oaks. — White oak (*Quercus alba*) is the most valuable of the numerous oaks and the best timber comes from the Appalachian region. The wood is used chiefly for high grade furniture, cooperage stock, car frame material, flooring, interior finish, agricultural implements, and crossties for railroads.

Several species belonging to the white oak group are now marketed as white oak, although but few show the fine radial markings of *Quercus alba*.

The red and black oaks are indigenous to the same region as the white oaks and are now used extensively for cooperage, interior finish, car frame material, furniture and many other uses where strength is essential. They are not as durable as the white oaks but large quantities are treated with preservatives and used for crossties.

The cut of oak lumber of all kinds in 1920 was 2,500,000,000 board feet.

Maple. — Lumber is manufactured from several species, namely, the hard maple (*Acer saccharum*), the black maple (*A. nigrum*), the red maple (*A. rubrum*), the silver maple (*A. saccharinum*) and the Oregon maple (*A. macrophyllum*). The hard and the black maples produce the most valuable lumber, which is cut chiefly in Pennsylvania, the Lake States, New York, West Virginia, Ohio, Indiana and some of the southern and New

England States. The lumber is prized for flooring and furniture and is also used for woodenware and gunstocks. Large quantities of the rough wood are utilized in destructive distillation.

The lumber cut of maple in 1920 was 875,000,000 feet.

Red Gum. — The red gum (*Liquidambar styraciflua*) is largely a tree of the lowlands and is found in the best form and in the heaviest stands along the Mississippi river bottoms in Arkansas, Mississippi, Missouri, Tennessee and Kentucky.

Missouri virgin bottom lands contain about 5500 board feet per acre of merchantable timber and those in South Carolina 4000 feet, but second-growth bottom land stands run as high as 13,000 feet per acre. The maximum stands in the Mississippi river bottoms seldom exceed 15,000 board feet per acre.

Red gum has become an important factor in the hardwood market and it is used extensively for furniture, tobacco boxes, fruit packages, and slack cooperage and other forms of containers.

The lumber cut in 1920 was 850,000,000 board feet.

Chestnut. — Chestnut (*Castanea dentata*) is widely distributed over the Central hardwood region, although 62 per cent of the 1919 cut was manufactured in West Virginia, Pennsylvania, North Carolina and Virginia. The wood is extensively used for furniture, interior finish, shingles, fencing, telephone poles, veneer backing, slack cooperage and for the production of tannin extract.

Chestnut grows in mixed forests of oak and other hardwoods but the sprout forests are largely pure. The stand per acre is extremely variable, averaging from 2000 to 6000 board feet.

During the year 1920 475,000,000 feet of lumber was manufactured from this species.

Beech. — Beech (*Fagus americana*) is found chiefly in the northern and Appalachian forests associated with maple and birch. The centers of lumber production are in Indiana, Michigan, Pennsylvania, New York, Ohio and Kentucky.

The chief uses of beech are for tool handles, clothes pins, flooring, slack cooperage, veneers and woodenware. Large quantities of rough wood are used for the production of wood alcohol and other products of distillation.

The lumber cut in 1920 was 325,000,000 feet.

Birch. — The commercial distribution of birch is largely confined to the states of Wisconsin, Michigan, New York, Vermont and Maine where it is associated chiefly with maple and beech, in

stands running from 3000 to 8000 feet per acre. Paper birch (*Betula papyrifera*) in Maine averages about two cords, with a maximum of fifty cords per acre.

The yellow birch (*B. lutea*) and sweet birch (*B. lenta*) are used chiefly for furniture, vehicle hubs, tool handles, flooring, interior finish, veneers, cooperage, spool stock and novelties. The paper birch of Maine is used chiefly for spool stock, shoe pegs and shanks, toothpicks and novelty work.

The lumber cut of birch in 1920 was 405,000,000 board feet.

Basswood. — This tree (*Tilia americana*) is associated with hemlock and other hardwoods in the northern and Appalachian forests. It is manufactured extensively into siding, rotary-cut veneer, car lining, heading, excelsior, baskets, slack cooperage, furniture backs, carriage bodies, and pulpwood. Although not durable it is one of the more valuable hardwoods because of its light weight, and the odorless character of the wood.

The lumber cut in 1920 was 195,000,000 feet. The chief center of manufacture is Wisconsin where nearly 40 per cent of the total output is produced.

Hickory. — The present commercial stands of hickory are found in the Appalachian and the Mississippi river regions. There are four species of commercial importance, namely, the big shellbark (*Hicoria laciniosa*), the shagbark (*H. ovata*), the pignut (*H. glabra*) and the mockernut (*H. alba*). The strongest and toughest one is the pignut, although the shagbark is but slightly inferior to it. The big shellbark is of medium quality only, while the mockernut is lacking in toughness, although it is strong.

The manufacture of hickory lumber centers in Arkansas, Tennessee, Kentucky, West Virginia, Indiana and Mississippi. These States now produce about 72 per cent of the total cut.

Hickory occurs singly among other hardwoods. The stands over large areas frequently range from 200 to 400 board feet per acre.

About 65 per cent of the hickory cut is used for vehicle stock, 10 per cent for tool handles, 9 per cent for heavy wagons, 8 per cent for agricultural implements, and the remainder for novelties of various kinds. About 1,000,000 cords are used annually for fuel. Saplings are sometimes split into barrel hoops, but this practice is less common than formerly.

The lumber cut in 1919 was 170,013,000 feet.

Elm. — There are three elms commercially important in the United States, the rock elm (*Ulmus racemosa*), slippery or red elm (*U. pubescens*) and the white elm (*U. americana*), all of which grow in the rich bottom lands along streams. Over one-half of the output is from the States of Wisconsin, Michigan and Indiana. Elm wood is used for hubs, bicycle rims, slack cooperage, coiled hoops, basket splints and other purposes where an elastic wood is essential.

The cut in 1920 was 225,000,000 feet.

Ash. — There are several species of ash in the United States, but about 60 per cent of the lumber cut is white ash (*Fraxinus americana*), and 30 per cent black ash (*F. nigra*). The greater part of the lumber output is manufactured in the states bordering on the Ohio and Mississippi rivers. More than one-half of the output is produced in Arkansas, Louisiana, Wisconsin, Indiana and Tennessee.

It is especially adapted for poles and shafts of wagons and carriages, sporting goods, agricultural implements, hoops and staves for pork barrels, packages and tool handles.

In the lower Mississippi bottoms the stand ranges from 2000 to 5000 board feet per acre.

The lumber cut in 1919 was 154,931,000 feet.

Cottonwood. — Several species (*Populus sp.*) are found in abundance and of large size in the bottom lands of the Mississippi River. The greater part of the annual production comes from the States of Arkansas, Minnesota and Mississippi. It is in demand for boxes, wood pulp, lining for refrigerator cars, excelsior, woodenware and cheap furniture.

The cut in 1919 was 143,730,000 board feet which is the lowest reported output.

Other Hardwoods. — There are many other hardwoods placed on the market among them tupelo or bay poplar (*Nyssa aquatica*), which is manufactured into flooring, interior finish, planking, and box boards in Louisiana and other Southern States; the cucumber tree (*Magnolia acuminata*) sold largely as yellow poplar; the buckeye (*Æsculus glabra*) manufactured into pulp, interior finish and woodenware; sycamore (*Platanus occidentalis*) used for furniture and plug tobacco boxes; black walnut (*Juglans nigra*); cherry (*Prunus serotina*) and other valuable

cabinet woods. The above species, with the exception of tupelo, are common to the South Central and Appalachian regions and are associated with the other hardwoods.

BIBLIOGRAPHICAL NOTE TO CHAPTER I

- ALLEN, E. T.: The Western Hemlock. Bul. No. 33, U. S. Bur. For., 1903.
- BETTS, H. S.: Properties and Uses of Southern Pine. Cir. 164, U. S. Forest Service, 1909.
- BOISEN, Anton T., and NEWLIN, J. A.: The Commercial Hickories. Bul. 80, U. S. For. Ser., 1910.
- BUREAU OF CENSUS, Dept. of Commerce: Lumber, Lath, and Shingles. Fourteenth Census of the United States. Forest Products: 1919. Washington, 1922.
- CHITTENDEN, Alfred K., and HATT, W. Kendrick: The Red Gum. Bul. 58, U. S. Bur. For., 1905.
- DANA, S. T.: Paper Birch in the Northeast. Cir. 163, U. S. For. Ser., 1909.
- FISHER, Richard T.: The Redwood. Bul. No. 38, U. S. Bur. For., 1903.
- FOREST SERVICE, U. S. Dept. of Agriculture: Timber Depletion, Lumber Prices, Lumber Exports, and Concentration of Timber Ownership. Report on Senate Resolution 311, Washington, 1920.
- FOSTER, H. D., and ASHE, W. W.: Chestnut Oak in the Appalachians. Cir. 135, U. S. For. Ser., 1907.
- FROTHINGHAM, E. H.: Douglas Fir; A Study of the Pacific Coast and Rocky Mountain Form. Cir. 150, U. S. For. Ser., 1909.
- FROTHINGHAM, Earl H.: Second-growth Hardwoods in Connecticut. Bul. 96, U. S. For. Ser., Washington, D. C., 1912, pp. 24-29.
- GREELEY, W. B., and ASHE, W. W.: White Oak in the Southern Appalachians. Cir. 105, U. S. For. Ser., 1907.
- HALL, William L., and MAXWELL, Hu: Uses of Commercial Woods of the United States; II. Pines. Bul. 99, U. S. For. Ser., 1911.
- HALL, William L., and MAXWELL, Hu: Uses of Commercial Woods of the United States; I. Cedars, Cypresses and Sequoias, Bul. 95, U. S. For. Ser., 1911.
- HOFFMAN, Bruce E.: Sitka Spruce of Alaska. Proc. of the Society of American Foresters, Vol. VII, No. 2., pp. 226-238.
- MOHR, Charles: The Timber Pines of the Southern United States. Bul. No. 13, U. S. Div. of For., Washington, D. C., 1897.
- RECORD, Samuel J.: Suggestions to Woodlot Owners in the Ohio Valley Region. Cir. 138, U. S. For. Service, p. 9, Washington, D. C., 1908.
- SPAULDING, V. M.: The White Pine. Bul. No. 22, U. S. Div. of For., Washington, D. C., 1899.
- THE LUMBER INDUSTRY. Report of the Bureau of Corporations, Department of Commerce and Labor. The American Lumberman, Chicago, Illinois, February 18, 1911.
- THE AMERICAN LUMBER INDUSTRY. Official Report Tenth Annual Meeting National Lumber Manufacturers Association, Chicago, Illinois, 1912.

CHAPTER II

LOGGING METHODS

The logging industry comprises both the preparation of the wood products of the forest for the manufacturing plant and their transportation to it or to market. The products of the logging industry are saw logs, pulpwood, acid-wood, stave and shingle bolts which are re-manufactured after they are removed from the forest, and hewed crossties, rived shingles, shakes, poles, posts, and piling which are marketed by the logger ready for use.

The work of preparing a given class of products for removal from the forest is similar in all regions, although there may be some minor differences in technique which have come into local use. The form in which the raw material is taken from the forest depends not only on the purpose for which it is ultimately to be used, but also upon the size of the bole and the method of transportation. Thus an adequate number of logs must be at least long enough to make the maximum board lengths desired, but if the form of transportation permits, the logs may be double or triple the board lengths or the entire merchantable bole may be moved in one piece. Saw log and pulpwood operators often do not remove other forest products but confine their operations to one class of material. The various by-products, therefore, may be removed by others.

The early logging operations were carried on near settlements on areas where the topographic conditions were most favorable for easy logging and from which the haul to the mill was comparatively short. The work was done largely by settlers who cut a limited number of logs during the late fall and winter, when agricultural activities were slack, and hauled the timber to the mill or to some stream down which the logs could be floated to destination. The equipment required was limited and required but little financial outlay. Logging became a distinct industry to which individuals devoted a large part or all of their time, only when lumber manufacture assumed a national character.

There has been but little change, since the early days, in logging technique in the Northeastern part of the United States where the winters are favorable for sled transportation and there are many streams down which coniferous timber may be floated; however, marked engineering skill has been displayed in the improvement of streams for log floating purposes and the perfection of sleds and sled roads for the movement of heavy loads. The power log hauler, either gasoline or steam, has replaced animal draft on some operations and flumes and log slides have been used to some extent but the original plan of operation has not been greatly modified. Individual logging units are, in general, limited in output. The aggregate cut of some pulpwood companies in this region is as great as that of large operators elsewhere, but it is the product of many medium- or small-sized operations rather than of one large one.

The early development of logging practice in Pennsylvania and the Lake States was based upon the methods of the Northeast because climatic and other conditions were similar and the pioneer loggers were from the New England section. The most important improvements in logging technique were developed in the Lake States in order to overcome adverse conditions. For example, logging railroads were introduced in the Lake States in the late "seventies" by a logger who was unable to haul his timber on sleds to water transportation, owing to the absence of sufficient snow. Power skidding methods also were first devised in this region in the early "eighties" to get logs out of glacial "pot holes" which could not be profitably brought out by animals. There is no indication, however, that railroad transportation gained an important place in logging in the Lake States until many years later, and power logging has never been used to any great extent to yard logs in that region.

The development of the modern systems of power logging and the adaptation on a large scale of the railroad to logging purposes came with the shifting of the center of lumber manufacture from the Lake States to the South and to the West. The inability to use animals in the cypress forests was one of the main factors which led to the improvement of power logging systems which were early recognized by southern yellow pine and West Coast operators as applicable to dry land conditions. The need for a large continuous output early indicated the use of some form

of logging railroad, and this form of transportation has reached a high state of development in every region except the Northeast.

Logging and lumber manufacture have developed as a single enterprise in most forest regions. However, in certain parts of the Pacific Northwest especially in the regions tributary to Puget Sound, and the Columbia River, logging has been conducted as a business apart from lumber manufacture, the log output being placed on the general market or sold under contract to manufacturers who have no logging facilities. The tendency in this region, however, is towards a consolidation of logging and lumber manufacturing interests.

Contract logging is practiced to some extent in every region but it has not proved a satisfactory method on many of the largest operations in the South and the Northwest because the extensive transportation improvements which are needed to take logs from the stump to the mill or to market require the investment of a large amount of capital and there are relatively few logging contractors who are able to finance a large enterprise.

The major part of the log output of the country is now produced by the professional logger, yet small operations still constitute a large per cent of the total number. They are most common in the forest regions east of the Cascade Mountains, especially in sections culled by large operators, where they serve a most useful purpose in the utilization of stands which the large logger cannot harvest profitably. Even in the Northwest nearly 60 per cent of the manufacturing plants have an annual output of one-half million board feet or less.

SUMMARY OF LOGGING METHODS IN SPECIFIC REGIONS

A. PORTABLE MILL OPERATIONS

The annual cut of a portable mill ranges from several hundred thousand to a few million board feet, however, the industry is of importance because of the large number of plants in operation many of which handle timber in regions where large mills are not feasible.

Portable operations in New England are conducted as a side line by men engaged in the retail lumber business; by contractors who can use their idle teams during the winter season; by men who engage in lumbering as a speculation when an opportunity

presents itself; by small wood-working plants which are able to secure occasional stands of timber suitable for their needs; and also by those who engage more or less continuously in logging and manufacture. There has been a tendency in recent years towards more specialization and larger annual output on the part both of individuals and firms, since the mill products can be marketed to better advantage. Contract work both in logging and manufacture is common and the product is sold to railroad companies in the form of crossties and structural timbers; to retail lumbermen in the form of lumber; to telephone and telegraph companies in the form of poles; and to various wood-working industries. The business is more active during the fall and winter months when agricultural and other outdoor occupations are slack, because labor and teams are more plentiful and a snow bottom reduces the logging expense, especially for skidding.

On the National Forests of the West the tendency is for portable mill operators to conduct their operations more or less continuously, except for interruptions due to climatic conditions. These operations are chiefly in virgin forests often several miles from a railroad and under conditions that are unfavorable for the development of large plants. The products of these mills are used locally by settlers, and by mines and other industrial enterprises.

Portable plants are common in the southern yellow pine region. They are sometimes located on small isolated tracts of virgin timber but, as a rule, they follow large plants operating on the lightly-culled lands, and old-field stands. Although a portion of the product is marketed locally, large quantities are sold through the larger operators, or through wholesalers and commission men.

LOGGING METHODS — NEW ENGLAND¹

The operations in New England are conducted chiefly on woodlots containing from fifty to several hundred thousand board feet. An operation may be confined to manufacturing the stumpage on a contract basis for the owner, or a sawmill man may buy the timber outright.

¹ See "Second Growth Hardwoods in Connecticut," by Earle H. Frothingham. Bul. 96, U. S. Forest Service.

A common practice in logging virgin timber is to go over the tract several times, removing certain products at a given cutting. Telephone, telegraph and electric light poles are taken out first. Piles are often cut from the tops of pole timber, if there is a market for this class of material. If there is large oak, ship timbers are next removed, being cut in long logs which are later sawed into flitches at the mill. The remaining timber is then converted into saw logs, the trees being utilized down to a 6-inch top diameter.

Crossties, which are cut in 8-foot lengths in the woods and sawed into squared and pole ties, are made in large quantities from short-bodied trees and large limbs.

The cutting of cordwood follows the removal of the saw log material. The residue, down to limbs $1\frac{1}{2}$ inches in diameter, may then be cut up into material for charcoal manufacture. Practically all of the wood is utilized, except small branches, when favorable markets are close at hand.

The sawmill plant is set up in the immediate vicinity of the operation where an open space can be secured for log and lumber storage and where a water supply for the boiler is convenient. Camps are seldom established.

The felling crews, which work several days in advance of skidding, are composed chiefly of foreigners and from one to two saw crews of three men each are required. A three-man crew consists of a spotter and two fallers. The spotter selects the trees to be felled and notches them, lays off lengths on the felled timber, and aids the fallers in swamping. Saws and axes are used for felling. A three-man crew will fell from 4000 to 5000 board feet daily.

Pole cutting may be done by contract at a given price per running foot for felling and peeling. Peeling can be done more readily in summer and pole-cutting contracts can be let at that season for about 25 per cent less than at other periods of the year. Some buyers, however, refuse to take summer-cut timber because of the greater liability of insect attack.

Hewed ties are seldom made because of the waste in manufacture. Cordwood is cut and piled by contract.

The logs are snaked on steep slopes, and then hauled on a log-boat, or on a "scoot" to the mill. These are used on short hauls even when there is no snow on the ground. A log-boat is

about 6 feet long, 3 feet wide, and has a flat bottom made of heavy planks which are upturned in front. A bunk is placed about 4 feet from the front and on this the fore end of the log is loaded and bound with chains, while the rear drags on the ground. The horses are hitched to a chain which passes through the upturned nose and is attached to the bunk. A tongue is not used. The scoot is a sled having two runners about 12 feet long, with a 4-foot gauge, a forward and rear bunk, and a standard length tongue. It is especially serviceable for short logs which are loaded on the sled. Wagons are not used to transport logs to the mill unless the haul is greater than $\frac{1}{3}$ -mile.

The usual log requirements of a portable mill are from 5000 to 7000 board feet daily and on short hauls two teams can bring in this amount. The average day's work on an $\frac{1}{3}$ -mile haul is about 3500 board feet per team.

COLORADO

The portable mill operations in this state are taken as a type of small operations on the National Forests. The mills are often several miles from a village at rather high elevations in the forests where the topography is rugged and the snow is deep during the winter season.

The stand is chiefly small-sized timber, with logs averaging from 10 to 12 inches in diameter at the small end, and from three to four and one-half 16-foot logs per tree, when cut to a top diameter of 6 inches.

The closeness of utilization depends largely on the local markets, and the purpose for which the timber is used. When waney-edge boards can be used for packing cases and other rough work there is very little waste, but when the demand is for lumber only, the mill waste is large.

The logging season depends upon the climatic conditions and the character of bottom. Felling and skidding usually begin sometime between the middle of June and the first of August and continue until the first or the middle of January when snow becomes too deep for profitable work. Hauling on some operations begins at the time of felling, the logs being handled on wagons, carts or go-devils up to the time snow falls, and after that sleds are used until the end of March or the middle of April. On other operations logs are hauled only in winter.

Camps are of log or board construction and comprise a cook shanty, a bunk house, and a stable. Labor is chiefly local.

Felling and Log-making. — The methods employed are similar to those in other regions, the ax being used to notch the timber and the saw for felling. The work is done both by day labor and by contract. Efficient crews of two men cut about 5000 board feet daily. When the fallers work singly at felling and bucking each may average from 2000 to 2500 board feet daily.

Swamping is usually done by a member of the skidding crew, one man being assigned to each team. The cost of brush disposal on small operations depends chiefly on the species, the depth of snow, the amount of dead material and young growth, the steepness of the slopes and the character of the bottom. Timber with many limbs such as Engelmann spruce and lodgepole pine necessitate more cutting and handling than most other species, hence brush disposal is more expensive. Snow from 18 to 24 inches deep makes brush disposal difficult, and seriously hampers the work. Where dead material occurs among young growth the piles must be made where reproduction will not be injured during brush burning and where down timber will not be ignited. Men are hampered in getting around on steep slopes and rough ground and brush disposal is more costly under these conditions. The swamping and piling during the summer and fall is sometimes done by the fallers.

Skidding. — The movement of the logs from the stump to the mill is performed either in one or two operations. On good bottom and short hauls the logs are either skidded directly to the mill or else hauled on sleds or carts over inexpensive roads. About 500 board feet constitute a load under the latter condition. The choice of methods depends on the season of the year. In rough sections and for distances greater than $\frac{1}{4}$ -mile the logs usually are yarded to skidways and then hauled on wagons or sleds to the mill. On rough and steep places a single horse is used for skidding, while on favorable bottoms two horses are employed.

B. NORTHEAST

Period of Logging. — Operations are usually confined to a period of from twenty-six to thirty-two weeks, beginning in the late summer and closing during the early spring. Where railroad transport is used summer logging is practiced.

Labor. — The labor is composed chiefly of French Canadians and Europeans. The men generally are employed by the month and are furnished board and lodging for which a charge is made. Some operators employ men on the day basis. The average camp crew on the larger operations comprises about sixty men. Operators frequently contract for their log input, in whole or in part, with "jobbers" who maintain independent camps. Contract operations are often of much smaller size than company camps.

Camps. — The buildings are log or board structures the largest camps housing from fifty to sixty men, and from twenty-five to forty horses. They are used for two or three seasons and then abandoned or else used as storehouses. Board camps are used chiefly on railroad operations. Supplies are hauled in on sleds or wagons where rail transport is not available. Workmen do not bring their families into camp.

Topography and Bottom. — The topography of the region ranges from rolling to rough, and the bottom often is covered with a heavy growth of underbrush. The steep slopes are rocky. The rolling land provides a good bottom for animals. Swamps are common in the region and are logged during the winter season.

Climate. — The winters are long and severe with a minimum temperature of from 25 to 40 degrees F. below zero. There are relatively long periods when thaws are uncommon. The average snowfall throughout the region varies from 60 to 90 inches. Winter conditions are ideal for the maintenance of snow and iced roads for sled hauling.

Felling and Log-making. — The practice is to fell the timber with the saw and ax. The boles are cut into standard lengths for saw logs, and into long logs when the timber is to be manufactured into pulpwood, although occasionally pulpwood timber is cut into 2- or 4-foot lengths for ease in handling. The fallers work in crews of two or three men and cut and make into logs from 5000 to 8000 board feet of timber, daily. Spruce pulpwood is sometimes peeled in the forest.

Skidding. — Animal logging predominates in the region, although a few cableway skidders have been used in New England on difficult logging chances. Snaking machines have been employed to a very limited extent in the mountains of northern

New York. Yarding, on operations where a sled haul is used, begins in the late summer or early fall and continues until the snow gets too deep for profitable felling, which is usually during the latter part of December. Logs are decked on skidways along two-sled roads and are either dragged to the yard by a single animal or a team, or else hauled on a yarding sled. A skidding and a felling crew of seven men can cut and skid from 5000 to 7000 board feet daily on a $\frac{1}{2}$ -mile haul when a team and yarding sled are employed for moving the timber.

Chutes and log slides are occasionally installed to bring logs down steep slopes.

Transportation. — Logs are transported from the skidways to a landing on a stream on a two-sled drawn by two or four horses, or on a yarding sled when the haul does not exceed $1\frac{1}{2}$ miles. Steam or gasoline log haulers are frequently substituted for animal draft on long hauls. The logs are floated out of the small streams during the early spring freshets and are driven down the large streams during the summer.

Railroad operations are not common but where rail transport is used logs are yarded and hauled on sleds to the railroad during the winter months, and yarded directly to the railroad during the summer.

Flumes have been used in a few instances for bringing pulpwood from the forest to a stream down which it is driven.

The common form of transporting logs to the mill is by floating. Rafting is practiced only after the logs are assorted on the lower stretches of the stream. Drives are conducted largely by incorporated companies.

C. LAKE STATES — WHITE PINE

Period of Logging. — Railroad operations are conducted throughout the year unless suspended on account of snow. When logs are transported on sleds to streams down which they are driven, the season is from thirty to thirty-six weeks long, beginning in the late summer and ending with the termination of hauling.

Labor. — The laborers are chiefly Swedes, Norwegians, Finns, Austrians and Poles. Foremen are often native-born Americans. The wage basis of payment is common.

Camps. — On railroad operations camps often are board

structures although log buildings are also used. The latter are employed almost exclusively on operations where the logs are hauled on sleds and floated down streams. Workmen are boarded and housed by the operator.

Topography and Bottom.—The topography varies throughout the region. In some sections the land is flat, more often it is rolling and "pot holes," which present difficult logging problems, are common. The brush is often dense in the forest where the pine is mixed with hardwoods, while in pure stands of pine the undergrowth is usually scanty.

Climate.—The winter season is long with low temperatures and abundant snowfall throughout most parts of the region. Conditions are favorable for sled transportation to streams, although logging operations in some sections have now been pushed back into regions where log driving is impracticable.

Felling and Log-making.—This work is performed by a crew of two or three men who operate under the direction of a saw boss. Low stumps are cut and the bole is taken to a top diameter of about 4 inches. Logs are generally cut into standard lengths. The daily output of a crew of two men is from 6000 to 10,000 board feet, depending on the size of the timber.

Skidding.—Animal logging is predominant. Several methods are used for bringing logs to the skidway which is either along a railroad or a sled road. For small logs and for distances of from 300 to 400 feet snaking is common while for large logs and rough bottom go-devils are used. Logs are snaked for 500 or 600 feet on snow bottom. High wheeled carts are used by some operators for logging to a railroad in summer, when hauling for distances from $\frac{1}{4}$ - to $\frac{1}{2}$ -mile. On winter logging swamps are crossed and often hauls of $\frac{1}{2}$ -mile are made by means of a jumbo dray, the logs being snaked out to the roads and then hauled directly to the skidway along the railroad. Steel-spar cableway skidders are now used on some hardwood and hemlock operations.

Transportation.—Railroads are the chief form of transport. During the spring, summer and fall the logs required daily are yarded directly to the railroad and loaded on cars. The winter supply of logs is either decked along the railroad or else yarded at more remote spots and then hauled to the railroad on two-sleds. There are only minor interruptions of railroad traffic

due to snowfall. The use of two-sleds for hauling logs to a stream down which they are floated is less common than formerly, because of the high value of the white pine stumpage and the large amounts of heavy hardwoods which are now being logged.

Steam and gasoline log haulers are common in the Lake States on sled hauls, sometimes bringing the logs directly to the mill.

D. SOUTHERN YELLOW PINE

Period of Logging. — The year round.

Labor. — White and colored. The former provide the more skilled labor and the latter the unskilled, although colored laborers occasionally occupy positions of responsibility. On some operations in the northern part of the region, whites are employed exclusively.

Camps. — They are chiefly portable houses in which the loggers and their families reside. A general store, church, Y. M. C. A., and school house are often provided. Car camps may be used when families are not furnished accommodations.

Topography and Bottom. — In the southern part of the region the country is flat or rolling, while on the northern edge it is usually broken. The bottom in the longleaf forests is generally free from brush, while in the loblolly and shortleaf forests there is often a heavy undergrowth.

Climate. — A period of heavy rainfall occurs during the winter months which often causes the cessation of logging operations due to bad bottom. Snowfall is very scanty or lacking. Freezing temperatures occur in the northern part of the region for short periods.

Felling and Log-making. — This is customarily done by a two-man crew who use the saw and ax. The daily output is from 7500 to 15,000 board feet, depending on the size of the timber and the stand per acre. Contract work prevails. Where animal skidding is used logs are cut in standard lengths, while where power skidding is employed they are cut in lengths ranging from 24 to 48 feet. Sometimes the entire bole is brought to the mill and there cut into logs.

Skidding. — Animal logging is still used throughout the region, although the power snaking system is common in the flat pineries, and the rehaul system in brushy sections. Occasionally a cable-

way skidder is used. The favorite method of animal logging is to "snake" the timber for short distances, and to move distant logs with bummers, high carts, or wagons. When standard length logs are handled bummers are a favorite vehicle for the shorter distances, and 4-, 6-, or 8-wheeled wagons for long distances. High-wheeled carts are preferred for long logs, and are often used for short ones on hauls of 800 feet or less.

Transport. — The almost universal form of long distance transport of logs from the forest to the mill is by railroad, because of the continuous operation of the plant, lack of suitable streams for driving, and the heavy weight of the timber. Where streams are available, floating is practiced to a limited extent by small operators; however, the loss from sunken timber is from 25 to 33 per cent.

E. CYPRESS

Period of Logging. — The year round.

Labor. — The unskilled labor is composed of negroes, creoles, and Mexicans, and the skilled labor of whites. Contract work prevails.

Camps. — Floating camps built on scows are used on pullboat operations, and permanent board camps on railroad operations.

Character of Bottom. — The bottom on many of the swamps is covered with water during a portion of the year, although there are many "islands" and other extensive areas which are seldom, if ever, submerged, where railroad camps may be located. The timber grows both on the wet ground and on the higher elevations. The bottom is too soft for animal logging.

Felling and Log-making. — The timber which is girdled or deadened some weeks or months in advance of felling and log-making is felled and made into logs with the ax and saw. Workmen are paid by the log, tree, or thousand board feet cut. A crew of two men will fell and make into logs from 7500 to 10,000 feet of timber, daily. Timber is cut to a minimum diameter of 8 inches in the top.

Skidding. — Two methods are used.

(1) *Pullboat Logging.* — A slack-rope skidding device is mounted on a scow and moored in a canal, bayou, or lake to which logs are dragged for distances of from 3500 to 5000 feet.

They are then rafted and towed to the mill. The daily output is from fifty to seventy-five logs.

(2) *Cableway Skidding and Rail Transport.* — A cableway skidder is placed by the side of a spur or main line track and logs are yarded to the railroad from distances of 600 or 800 feet. They are then loaded upon cars and transported to the mill. The daily output is from 30,000 to 40,000 board feet per skidder.

Transport. — Floating and railroading are the two methods used.

(1) *Floating.* — The logs are made into cigar-shaped units about 125 feet long and several of them are joined together into a raft and towed to a mill.

(2) *Railroad.* — Main lines in the swamps are usually built on piling. Spur roads, which are located approximately $\frac{1}{4}$ -mile apart are "dunnage" roads. Light-weight engines and skeleton cars are employed. Logs are loaded on cars by a special device on the skidder.

F. NORTHWEST

Period of Logging. — The year round.

Labor. — Logging is highly specialized and requires a relatively large number of skilled men among whom are found natives, Swedes, Norwegians and other foreigners. Unskilled labor is foreign and consists of the nationalities mentioned and also men from southern Europe.

Camps. — Either car camps, board camps, or portable houses are used to shelter the men. Families seldom reside in camp. Laborers are housed and boarded by the logger.

Topography and Bottom. — The region ranges from rolling to rugged and in many sections difficult logging problems are encountered. Underbrush is heavy in the coast forests where rainfall is abundant.

Felling and Log-making. — Felling and log-making are done by separate crews. Fallers who work in crews of two may or may not do the notching. Two log buckers who work alone are required for each crew of fallers. Logs are cut in lengths of 26 feet or longer.

Yarding. — Power logging is now almost universal, the slack-rope system being the predominant form although many cableway skidders are in operation for handling small- and medium-

sized timber and for "swinging" logs from the yarding engines to the railroad.

Animal logging is found only on small operations where the "chance" is favorable and the output limited.

Transport. (1) *Road Engine.*—A road engine sometimes takes logs from the yarding engine to a stream or railroad. This practice is less common than formerly.

(2) *Railroad.*—The yarding engines are placed at points accessible to the logging railroad. Intermediate transportation such as swing donkeys or road engines, however, may be installed between the yarding engine and the railroad. Logs are loaded on flat or skeleton cars or log trucks and hauled to the mill, to a driveable stream, or to tide-water. When yarding engines are used cars are loaded with a gin-pole, or some overhead loading system, and when the cableway skidder is used the logs are loaded with a guy line or swinging-boom device provided for that purpose. Cars are unloaded by hand methods, log dumps, or other special unloading devices.

(3) *Rafting.*—Logs brought to tide-water are rafted and towed to the mill.

(4) *Flumes.*—These are frequently used for bringing logs from the forest to the railroad or some stream.

(5) *Chutes.*—Chutes and slides are used in some sections for bringing logs down steep slopes and for handling logs on bottoms that cut up badly in dry weather. Three-pole and five-pole chutes are in most common use.

(6) *Aerial Tramways.*—These are used to bring logs from high elevations to lower ones, especially on very rough ground.

(7) *Motor Trucks.*—The timber from small or isolated tracts is often hauled to the sawmill on heavy motor trucks.

G. MOUNTAIN LOGGING IN WEST VIRGINIA¹

Period of Logging.—The year round.

Labor.—The foremen are usually Americans, and the remaining laborers are chiefly foreigners, such as Italians, Austrians, Poles, and Hungarians with a small percentage of other nationalities.

Camps.—The camps are chiefly board structures built along

¹ See *Cost of Mountain Logging in West Virginia*, by Henry H. Farquhar. *Forestry Quarterly*, Vol. VII, pp. 255–269.

the logging railroad. They accommodate from fifty to seventy-five men and from twenty-five to thirty-five horses. Board and lodging are provided by the operator. Families seldom reside in camp.

Topography and Bottom. — The region in which extensive operations are now conducted is rugged with narrow valleys and steep slopes, covered in many places with massive boulders that are a hinderance to logging. Mountain laurel is abundant throughout the forest and necessitates heavy swamping.

Felling and Log-making. — On operations where hemlock bark and logs are utilized the bark peelers fell, bark, and cut the boles into logs during the months of May to August, inclusive. During the remainder of the year the felling crews, each having a chopper and two sawyers, go through the forest felling and cutting the remaining spruce and hemlock trees into logs. The hardwoods are cut after the softwoods to avoid the loss through breakage which would occur if all of the timber were felled at one time. Trees are cut to a stump diameter of 10 inches and the boles to a top diameter of 8 inches for saw logs, and 4 inches for pulp wood. A crew of two men will fell and make into logs from 15,000 to 20,000 board feet of spruce and hemlock, daily. Two knot cutters are often members of the felling crew. Their duty is to snipe the ends of the logs and to remove the limbs from them.

Skidding. — Skidding is done chiefly with animals. Roads or trails are cut from the valleys up to the tops of the ridges and the logs are dragged down in tows either over skipper roads or pole slides. A team on a skipper road will handle from 5000 to 6000 board feet daily on a haul of $\frac{1}{4}$ -mile. Slides are common in some sections and are built from a few hundred feet to 1 mile or more in length.

The cableway system of power logging is in occasional use on rough chances and on some operations single-line snaking machines are employed for dragging logs for distances as great as 2500 feet.

Transportation. — On many operations the logs are hauled to the mill on narrow- or standard-gauge railroads. The narrow-gauge roads are sometimes of the stringer type. The railroad is usually built up the main "draws" or valleys. Spurs are seldom constructed because of the heavy expense.

Inclines are common and occasionally aerial trams are employed.

Logs are loaded both by hand and with power loaders of several types.

Water transport is used in regions where suitable streams are available. The logs are hauled to the stream and placed in the channel awaiting a freshet to carry them down stream.

PART II
PREPARING LOGS FOR TRANSPORT

CHAPTER III

FOREST LABOR

The successful conduct of forest operations depends in a large measure on the character, supply and efficiency of labor, factors which are influenced by the economic conditions of the country. In prosperous times work is abundant and capable men are not attracted by the average wage paid for forest work. This means a restless woods force, a portion of which constantly shifts from camp to camp. Business depression is quickly felt in the lumber industry because in hard times railroad companies and other large consumers of forest products reduce their purchases of lumber, crossties and other material. The dull market prompts the lumberman to cut down expenses, and one of the first steps taken is to reduce the labor charge since this is one of the chief items in the cost of lumber production.

The agricultural interests of different regions also may have a decided influence on labor supply during certain seasons. This is illustrated in the cypress region of Louisiana, where sugar production is an important industry and where creoles and negroes prefer to work in the fields and sugar mills during the cane-harvesting season.

LENGTH OF EMPLOYMENT

The length of time forest laborers are required each year is governed by the character of the operation. In the northeastern part of the United States, in some parts of the Lake States and in the Inland Empire there is a demand for the maximum number of laborers only from eight to nine months of the year; in the southern pine, cypress and Pacific Coast forests, where railroading replaces sled haul and water transport, loggers operate the year round.

CHARACTER

During the early years of the industry, the woods force in the North and East was recruited chiefly from the native agricultural element, but to-day only 40 per cent of the loggers in New England and 15 per cent of those in the Lake States are Americans. The remainder include French Canadians, Finns, Swedes, Poles, and natives of Southern Europe. French Canadians come across the border during the fall and winter months to secure a "stake," and return when the logging season is over. Many Swedes and Norwegians, who are among the best woods workers from Europe, are employed in the Lake States and also on the Pacific Coast. Finns and Poles work chiefly in the Lake States. In all these sections, native whites generally occupy the more responsible positions.

About 60 per cent of the forest labor in the Pacific Northwest is American, the remainder consisting of Scandinavians, Canadians, Finns, Austrians, Germans and a few Japanese. Americans comprise about 28 per cent of the forest labor in northern Idaho and western Montana, 31 per cent in the California redwood region, and 50 per cent in the California pine region, and native whites and negroes 100 per cent in most parts of the southern yellow pine region.

The labor in the Appalachians consists largely of natives, some of whom combine agriculture with logging while others follow logging as their sole occupation.

Creoles and Mexicans are common in the Louisiana cypress swamps, and many Mexicans are employed in Texas, especially around the mills and on railroad construction work. The Southern whites often are agriculturists who work at logging only for a portion of the year, while the negroes, except in the sugar country, follow the industry the year round with frequent shifts from one camp to another. Owing chiefly to the climate, the laborers are, on the whole, less energetic than those in northern regions. The color line usually is drawn on logging operations and mixed crews are not the rule. Creoles and Mexicans work with colored laborers, although Mexicans are inclined to be clannish.

METHODS OF EMPLOYMENT AND PAYMENT

The usual methods of paying labor on logging operations are:

- (1) A straight hour, day, or monthly wage basis;
- (2) piece-work basis;
- (3) contract basis.

Wage basis: — The wage basis prevailed for many years in all parts of the country and is still in common use to-day in the Northeast, the Lake States, the Appalachians, the South, the Inland Empire and on the Pacific Coast, although the piece-work and the contract basis have been extensively introduced in recent years. Formerly the wage included board, but in most regions laborers are now charged for board and in some cases for lodgings when superior accommodations are offered. Workmen are now seldom paid for lost time that is due to bad weather or to sickness. The straight wage system has come into disfavor because it tends toward inefficiency and waste, since there is little incentive for the average laborer to do more than is necessary to hold his job. Where it is still in use, the hour system is the more common, only skilled employees being hired by the month. Various substitutes for the straight wage system have been devised, in order that workmen may be paid on the basis of the amount of work actually and satisfactorily performed.

Piece work: — This method of paying employees has been extensively adopted by the lumber industry in all parts of the United States. In logging work it has been applied to felling and log-making, skidding and yarding, hauling, and laying and taking up steel on logging railroads. A form of bonus or premium plan has been introduced into the piece-work system in some parts of the country, especially in the Pacific Northwest. The most common application of this principle has been to yarding, although some firms apply it to nearly all forms of logging work. Most of these schemes have been founded on the general basis of a guaranteed minimum wage for a specified amount of work performed, called the "base," and the payment of a premium or bonus for all work over and above the base.

In some camps the bonus plan is applied only to a few employees who are acting in a supervisory capacity. While this tends to make those to whom the bonus is offered more diligent in their efforts to increase output and reduce operating costs, it neglects the necessary stimulus to those who are ineligible. Such a system, therefore, seldom appeals to the workmen, because the ultimate aim is to secure more work from them without any pecuniary benefit.

One bonus system¹ which has been used for several years is

¹ Known as the Brown's Bay System because it was first advocated on the West Coast by the Brown's Bay Logging Co. of Seattle, Washington.

based on the establishment of a monthly (26 days) base output for each yarding crew, for which a guaranteed wage is paid. The crew then receive a bonus, per thousand board feet, for each 50,000 board feet logged over and above the base during the 26-day period. This bonus is distributed among the members of the yarding crew in the proportion that each worker's guaranteed wage bears to the guaranteed wage of the entire crew. In some cases the bonus takes the form of payment of so many cents per thousand feet, log scale. The general scheme of distribution is shown in the following table:

BROWN'S BAY BONUS SYSTEM¹

(Yarding Crew of 14 men.)

Per mo. of 26 days	Total bonus at 75c per M	Total monthly pay of crew incl.	Cost per M incl. bonus	5 men at \$2.25 per day, 6 per cent	2 men at \$2.50 per day, 6½ per cent	4 men at \$2.75 per day, 7½ per cent	1 man at \$3.00 per day, 8 per cent	2 men at \$3.50 per day, 9½ per cent
800 M	\$968 50	\$1 210
850 M	\$37 50	1006 00	1 183	\$2 25 ²	\$2 44	\$2 81	\$3 00	\$3 56
900 M	75 00	1043 50	1 159	4 50	4 88	5 62	6 00	7 12
950 M	112.50	1081 00	1 138	6 75	7 32	8 43	9 00	10 68
1000 M	150.00	1118 50	1 118	9 00	9 76	11 24	12 00	14 24

¹ If the guaranteed work of the crew of 14 men for a twenty-six-day period and an 800,000 board foot base is \$968.50, then the wage of a man receiving \$2.25 per day is 6 per cent; that of one receiving \$2.50 per day 6½ per cent.

² This represents the bonus for the twenty-six-day period to which a workman receiving \$2.25 per day was entitled.

The criticism of this system is that it applies only to a portion of the logging crew, although in practice the greater efficiency secured from the yarding crew and the efforts made by them to earn a bonus affected nearly every man in the camp. Cooks have more lunches to put up, pump men must put in extra hours, and train crews are called on to handle additional tonnage. This method of applying a bonus is also subject to criticism unless the base is changed for each new set of conditions, because the topography, stand of timber, and general operating conditions often vary widely in different logging "chances," and a crew might find it difficult to log even the base if adverse conditions were encountered on a given "show." This difficulty has been overcome by a modification of this system, introduced by some western operators, in which a standard output, or base, is determined for each rollway which is logged. Each "show" is ex-

amed separately by the superintendent, foreman, and the hooktender, who write on a slip of paper their judgment as to what the base should be for that particular rollway. These figures are then averaged to determine the base. For all output over and above this base, each member of the yarding crew receives a bonus, payable at the end of the month, subject to certain general rules previously established. The rules of one company governing the payment of a bonus are as follows:

GENERAL RULES

1. "No employee will receive a premium for a fractional month's work.
2. "The daily wage received when you enter our employ will be your wages for the year.
3. "The scale of logs will be according to the scale rule we have used here in the past. The logs will be scaled by our scaler, but the employees have the right to call in a scaler if not satisfied. If these two cannot agree, they can select the third man whose decision must be final. The expense of the last two men must be borne by the employees. Any lost loads along our railroad will not be counted.
4. "Allowance will be made for lost time for delays beyond our control when they exceed one-half a day but no credit will be given for any short delays that occur in any logging operations; * * * .
5. "No premium on overtime will be allowed except when yarder is in actual operation; the amount of overtime to be allowed is at the option of the foreman.
6. "The crews must go out when ordered by the foreman; if not the day will be charged up against them as a yarding day.
7. "The premium will apply to all men handling logs from the time the logs are hitched to in the woods until they are dumped in the water to be shipped to market. It will not apply to construction men, shop men or any men that are not connected with the yarding or train crews. A different system of premiums will be applied to fallers and buckers.

STANDARD OF PREMIUMS¹

"Men receiving the following pay per day will receive the premium per thousand feet opposite the respective amount.

"\$5.00 per day9c	per thousand feet
"\$4.75	"8½c	" "
"\$4.50	"8c	" "
"\$4.00	"7c	" "

¹ This method of distributing premiums is based on a principle similar to that used in the Brown's Bay System. The chief difference is that the premium paid is stated in cents per thousand feet, log scale, while the Brown's Bay System allots the premium on the basis of percentages.

"\$3.75	"	6½c	per thousand feet
"\$3.50	"6c	" "
"\$3.25	"	5½c	" "
"\$3.00	"5c	" "
"\$2.75	"	4½c	" "
"\$2.50	"4c	" "
"\$2.25	"3½c	" "
"\$2.00	"3c	" "

"To illustrate: If the standard for yarder No. 1 is 1500 thousand feet for the month of April and this yarder puts in 1700 thousand feet, then all of the men who have complied with the above requirements will receive in addition to their wages the premium on 200 thousand feet of logs, or, for instance, if a man receives \$3.00 per day, he will get \$10 premium in addition to his wages.

"The train crews will receive their premiums on the above basis of one yarder; if they haul for two yarders their proportion will be one-half of the above scale; if for three yarders, one-third, etc., * * * ."

Some bonus plans used by the logging industry determine the volume on which the premium shall be paid in much the same manner as above, but instead of paying a bonus of a certain number of cents per thousand feet log scale for all timber over the base, the premium is determined by increasing the guaranteed daily wage 1 per cent for each 10,000 feet log scale, monthly average, above the base. Thus, if the daily average of the crew during the month was 20,000 feet log scale above the base, then an employee would receive a 2 per cent bonus on his daily wage. Thus a workman whose daily guaranteed wage was \$5 would receive a total of \$5.10 per day.

When the bonus system has been fairly applied it has produced results which, in general, have been satisfactory to the employer and the employees, because the former has secured greater output from a given amount of equipment at a reduced cost and the latter has been able to earn a higher wage than was possible under the hour or day basis. One firm reported an increase of 40 per cent in the output of yarding crews after the introduction of a bonus system with an average bonus to workmen of 20 per cent of their wage. One drawback to the system which was apparent on some operations was that the workmen, in their zeal to earn a high bonus, put in long hours and within a period of a few months were forced to lay off in order to recuperate. This disrupted the crews, since the best men were the ones who were forced to cease work. This objection possibly may be overcome by setting a

maximum standard for a day's work, above which a bonus will not be paid. In this manner the workmen will be encouraged to do a good day's work, but will not have an incentive to overtax themselves physically.

Felling and log-making bonus systems on the Pacific Coast have been developed along lines quite different from those for yarding and transporting logs. One system has taken as a base for daily output a given number of square feet cross-section of cuts made. This method is more equitable than payment on the basis of the number of feet log scale cut, since it eliminates the lengths of logs into which the bole is divided. The general procedure is to establish a certain number of square feet of end area as a day's work, for which a standard wage is paid, and to pay for all output above this base at a rate per square foot equal to one-half that paid for the base output. Thus, if the daily base is 70 square feet, the daily guaranteed wage \$2.80, and the daily average output 85 square feet, the faller or backer would receive $\frac{(85 - 70) \times .04}{2}$ or 30 cents per day bonus. The work of

each crew or man is scaled daily and the output, in square feet, calculated from the data obtained. The results have proved satisfactory, since inefficient workmen who cannot earn a bonus soon leave, greater output per man or crew is secured, and the workmen make a higher wage than is possible under a straight day system.

Objections to a bonus system for felling timber have been raised, because there is a tendency towards increased speed which often causes more breakage and waste, since output, rather than quality, is the goal.¹

The common form of payment for certain forms of logging work, such as felling and log-making, in some parts of the country, especially in the South, is on the basis of the thousand feet, log scale. Where this method is not used the basis may be the log,

¹ A novel suggestion for the elimination of the waste due to breakage and other causes is the payment of a bonus to the fallers for all timber saved over and above the average amount. For example, if the average felling loss due to breakage is 10 per cent of the merchantable volume of the stand, the felling crew will be paid 1 per cent of the stumpage value for all stumpage saved below the base. Thus, if a crew had 5 per cent loss only, their bonus would be 5 per cent of the stumpage value of the timber saved. See Canada Lumberman and Wood Worker, Toronto, Ontario, Jan. 1, 1916, page 36.

tree, number of saw cuts made, or the "task." These methods do not stimulate close utilization, because quantity rather than quality is the goal. There may be a conscious effort to avoid cutting rough top logs which require much swamping, and often tops may be broken in felling in order to obviate the necessity of cutting top logs of small diameter, especially when the log scale used penalizes the workman by giving him too low values for small logs. The remedies for this condition are close supervision and the establishment of the felling and log-making both on a quantity and a quality basis.

The so-called "task" system is applied to certain forms of logging work, such as laying and taking up steel on logging railroads. The principle of this system is the payment of a given wage for a given amount of work, at the conclusion of which the workmen are free to use their time as they see fit. For work other than the standard, the workmen receive additional pay. Other forms of work which are sometimes done by the task system are skidding with animals, and loading logs upon cars, for which weekly standards of work are established. The workmen then have such free time at the end of the week as remains after their task is completed.

*Contract basis.*¹ Contract work is common in many parts of the country, especially east of the Rocky Mountains. It is a satisfactory method where labor is inefficient or where liability laws are unfavorable to the employer. The system in some regions covers the entire field of mill stocking, although usually it is applied only to felling and log-making, skidding, hauling, and railroad grade construction. The last is almost invariably a single contract, but the others may be handled together. For instance, one contractor may agree to deliver the logs along a railroad or on the banks of some stream or other body of water. The common basis of payment for contract work is the thousand feet, log scale. Lumbermen may furnish the contractors with tools, supplies and all facilities needed, although this is not a common practice. Log-cutting by contract is rarely satisfactory for forests under management, since the log-cutters will not go into the tops because of the swamping required and also because

¹ For legal decisions which have reference to logging contracts see *The Essentials of American Timber Law*, by J. P. Kinney. John Wiley & Sons, Inc., New York, 1917.

the small top logs give a low scale when measured by most log rules.

Minor contracts are usually verbal, but those involving an extensive amount of work are in written form. A certain per cent of the contract price often is withheld until the work is satisfactorily completed.

A form of contracting which has become more or less common during recent years in the Inland Empire is known as "Gipo" logging. A crew of from four to eight men contract to put logs on the skidway on the thousand foot log scale basis. This method has proved a success, especially during periods when labor is scarce and wages high, since the output per man is often nearly twice as great as that of men working on day-wage basis.

Loggers who contract the major part of their work often find it advantageous to maintain small crews of their own, in order that they may have a basis for determining what is a fair contract price for logging under their conditions. Company crews also tend to prevent the arbitrary dictation of prices by contractors, since the company is prepared to do a portion of its work, and has the nucleus of a logging organization which may be expanded readily, if necessary.

A written contract stating the exact conditions of labor, especially with reference to terms of employment, hours of labor, wages, pay days, charges for board and medical attention, and the equipment furnished, have proved desirable in some cases.

PAYMENT FOR SERVICES

Many lumber companies operate commissaries or general stores in connection with their logging work. Since it is to their advantage to have the trade of their employees, cash usually is disbursed only on specified pay days. Meanwhile, employees may obtain metal trading checks or coupon books, usually the latter, to the value of their credit, which are accepted at face value at the company store. Checks or coupons are rarely honored when presented by those who are not employees or members of their families, the company in this manner preventing the acceptance of the coupons by other merchants.

Weekly or semi-monthly payments are the rule in most regions¹,

¹ During the war, when labor was scarce, some companies solicited labor on the basis of "everyday a pay day"; that is, any employee might draw, daily, the full amount due him for wages.

for many states have passed laws specifying the period which may elapse between pay days. In some regions where logging operations are remote from settlements, payment of wages due may be deferred until the close of the season or until the workman leaves the employ of the company. Settlement is then made by check or by order on the head office or on some store or bank located at the nearest accessible point to the operation¹.

FACTORS WHICH INFLUENCE WAGES

The wage paid for forest work depends largely on the following factors:

(1) The amount of labor available. As in all industries, the labor cost fluctuates with the abundance or scarcity of labor. Although some features of logging require workmen with a special knowledge of their trade, the demand is chiefly for more or less unskilled labor. In any case, loggers, both skilled and unskilled, easily adjust themselves to various other forms of industrial work; therefore, the logging industry, in times of a general labor shortage, finds it necessary to raise its wage standards in line with that of other industries.

(2) The degree of skill required. There is marked difference in the degree of skill required of loggers in the various forest regions, depending chiefly upon the extent to which machinery is used to move the timber from the stump to the main transportation system which carries it to market. Where animal logging prevails, a high degree of mechanical skill is not required, while on operations where machinery is used, skilled mechanics are necessary to operate and maintain the machines, and a reasonable degree of mechanical skill is essential for the members of the yarding crew. Consequently, the average wage commanded by power loggers often is greater than that received by those who are employed on operations where machinery is not used extensively.

(3) The conditions under which labor is performed. Laborers

¹ The laws of many states include statutes giving a lien on logs to those who may perform labor in connection with the preparation, and the transportation to market, of forest products. These so-called statutory liens do not imply possession of the logs at the time labor was performed, but do necessitate the attachment of the property before the lien can be enforced. For a comprehensive discussion of this question see *The Essentials of American Timber Law*, by J. P. Kinney. John Wiley & Sons, Inc., New York, 1917.

prefer to work near settlements, and may demand higher wages on remote operations, and also where low stumps, brush disposal and other restrictions demand the exercise of greater care and effort than usual.

(4) The perquisites offered. A better class of labor can be secured, with a minimum of turnover, when camp conditions and surroundings are made attractive for the laborers and their families, and when adequate hospital, accident insurance, school, church, and amusement facilities are provided. High-grade workmen seek permanent employment under attractive conditions, in preference to a higher wage gained by working where the physical welfare of employees is neglected.

EFFICIENCY

The efficiency of labor is measured by the number of one-man hours taken to perform a given task. The conditions under which logging is carried on are so diverse that there is a wide range in the labor requirements even in a given region; consequently, there is no standard for the industry as a whole.

Among the factors influencing the labor required are the following:

(1) Topography. The more unfavorable the ground conditions under which men must perform their labor, the greater the labor expended in accomplishing a given task, other things being equal. A level or gently rolling country, with a smooth solid bottom free from underbrush and windfalls, offers the most advantageous condition. Swampy or rough bottom, heavy underbrush, and rugged topography necessitate added labor to perform a given task.

(2) Climatic conditions. Extremes of heat or cold and an undue precipitation of rain and snow reduce the output of forest laborers, and thus increase the amount of one-man hours required to perform a given task.

(3) Stand of timber per acre and size of timber. Light stands of timber often require more labor, to harvest a unit of timber, than stands running from medium to heavy, because less timber can be logged in a given time by a given crew. The labor cost of primary transportation also may be greater, because of the limited amount of timber available to a given set of improvements.

(4) Size of the timber. Small timber is more expensive to

log than medium-sized or large timber, since a greater number of pieces are required to scale one thousand board feet, and various operations connected with the preparation of the logs and their movement to the primary transportation system are functions of the piece, rather than of volume.

Studies made in California showed that on the operations investigated "it costs three times as much per M. B. M. to make logs from 18-inch as from 48-inch trees, and that below that diameter the costs undoubtedly rise rapidly with each further decrease in size."¹ Studies made in the Appalachian region indicate that the time required to skid logs with animals for a distance of 1000 feet, increases very rapidly with a decrease in the log size. Thus, to skid 6-inch logs requires 5.5 times, and 12-inch logs 2.5 times as many hours per thousand feet log scale as 24-inch logs.²

Very large logs cannot be handled by an operator equipped to move medium-sized timber, except at an additional cost for labor, since the size of such logs often necessitates the loss of much time in adjusting the equipment to do the work.

(5) Form of the trees. Short boles and heavy tops require extra labor in log-making, because it may only be possible to secure one log as a result of the felling operation, and the labor involved in swamping limbs often is equal in amount to that expended on a tree of longer bole from which several logs could be cut.

(6) Conservative logging requirements. The enforcement of low stump, top lopping, brush piling, brush burning, and other conservative logging regulations may cause an increase in the amount of labor required to produce one thousand board feet of logs. There are conditions, however, in which brush disposal in dense stands of white pine has facilitated the skidding operations, so that the cost of the brush disposal has been more than offset by cheaper skidding.

Studies of the productivity of labor in the logging industry were made in 1915, covering supervision and general expense, felling and log-making, skidding, yarding and loading, transpor-

¹ See *The Relative Cost of Making Logs from Small and Large Timber*, by Donald Bruce. Bul. 339, College of Agriculture, Agricultural Experiment Station, Berkeley, California, 1922.

² See *Cost of Cutting Large and Small Timber*, by W. W. Ashe. *Southern Lumberman*, Dec. 16, 1916, p. 91.

tation and unloading, and maintenance of transportation.¹ For the items mentioned there was a variation among different operations ranging from 5.9 one-man hours on a white pine operation to 25.24 hours on a hardwood operation. The distribution of total time by processes, on individual operations, showed minor differences only. In other words, the amount of total time required from tree to pond may vary within wide limits in various operations, and in the different regions, yet each process requires about the same proportion of the total time expended.

On eleven operations, an average of 68 per cent of the total time was devoted to the movement of the logs from stump to pond, including skidding, yarding, loading, unloading, and maintenance of transportation. Mixed hardwoods showed the lowest percentage, namely 58.8, of time devoted to this work, while for mixed pine and hardwoods the percentage was the highest, namely 81.9. Felling and log-making operations were lowest in Douglas fir, 18 per cent, highest in redwood, 42.2 per cent, with an average for the eleven operations of 28.49 per cent. Supervision ranged from 1.8 per cent in shortleaf pine to 5.1 per cent in mixed pine and hardwoods, with an average for all of 3.05.

The data for operations in various regions, weighted on the basis of the log scale production, is shown in Table V.

Since the exact conditions under which the data were secured are not stated, the figures in the table may be taken as suggestive only, but they are of value as indicating in a relative way the varying conditions in the several regions and the proportion of the time usually devoted to each process.

The marked differences in the time required are due to various factors, outside of the efficiency of the labor employed, among which are the size, character, and stand of timber, and the topography, all of which vary widely with the species shown in the table.

UNIONS²

The chief center of organized labor in the logging industry is

¹ See *Wages and Hours of Labor in the Lumber, Millwork, and Furniture Industries, 1915*. U. S. Dept. of Labor, Bureau of Labor Statistics, Bul. No. 225, 1918.

² See *Lumber: Its Manufacture and Distribution*, by Ralph C. Bryant. John Wiley & Sons, Inc., New York, for a more comprehensive discussion of labor unions in the lumber industry.

TABLE V
ONE-MAN HOURS REQUIRED — TREE TO POND¹

(Weighted on Basis of Log Production)
SPECIES

Occupation	White pine		Shortleaf pine		Douglas fir		Redwood		White pine, fir and larch		Cypress and gum		Mixed pine (shortleaf) and hardwoods		Mixed hardwoods		Average	
	No.	%	No.	%	No.	%	No.	%	No.	%	No.	%	No.	%	No.	%	No.	%
Supervision.....	0 1998	3 380	0 1431	1 843	0 2650	3 050	0 2902	2 582	0 4613	3 642	0 5708	3 260	0 9574	5 115	0 5715	2 263	0 2846	3 652
Felling and log-making.....	1 6692	28 238	2 2442	28 887	1 5330	18 040	4 7455	42 211	2 5381	20 004	3 7932	21 645	2 4622	12 915	9 8043	38 834	2 6570	28 492
Skidding, Yarding and Loading.....	3 4751	58 789	3 7723	48 556	4 2001	49 420	4 0969	36 441	8 4705	66 881	6 7596	38 575	6 6243	34 740	8 6305	34 185	4 6124	49 459
Transportation and unloading.....	0 2977	5 037	0 8841	11 380	0 5089	6 750	0 8960	7 970	0 7958	6 283	1 7677	10 090	4 1869	21 955	3 0621	12 128	0 7054	7 564
Maintenance of Transportation.....	0 2683	4 566	0 7252	9 334	1 9824	22 740	1 2138	10 796	0 3992	3 152	4 6310	26 430	4 8194	25 275	3 1785	12 590	1 0062	11 433
Total.....	5 911	100 000	7 7689	100 000	8 4994	100 000	11 2424	100 000	12 6649	100 000	17 5243	100 000	19 0682	100 000	25 2469	100 000	9 3256	100 000

¹ Based on data contained in Wages and Hours of Labor in the Lumber, Millwork and Furniture Industries, 1915. U. S. Dept. of Labor, Bureau of Labor Statistics, Bul. 225, 1918.

Organization of a Pacific coast logging operation.

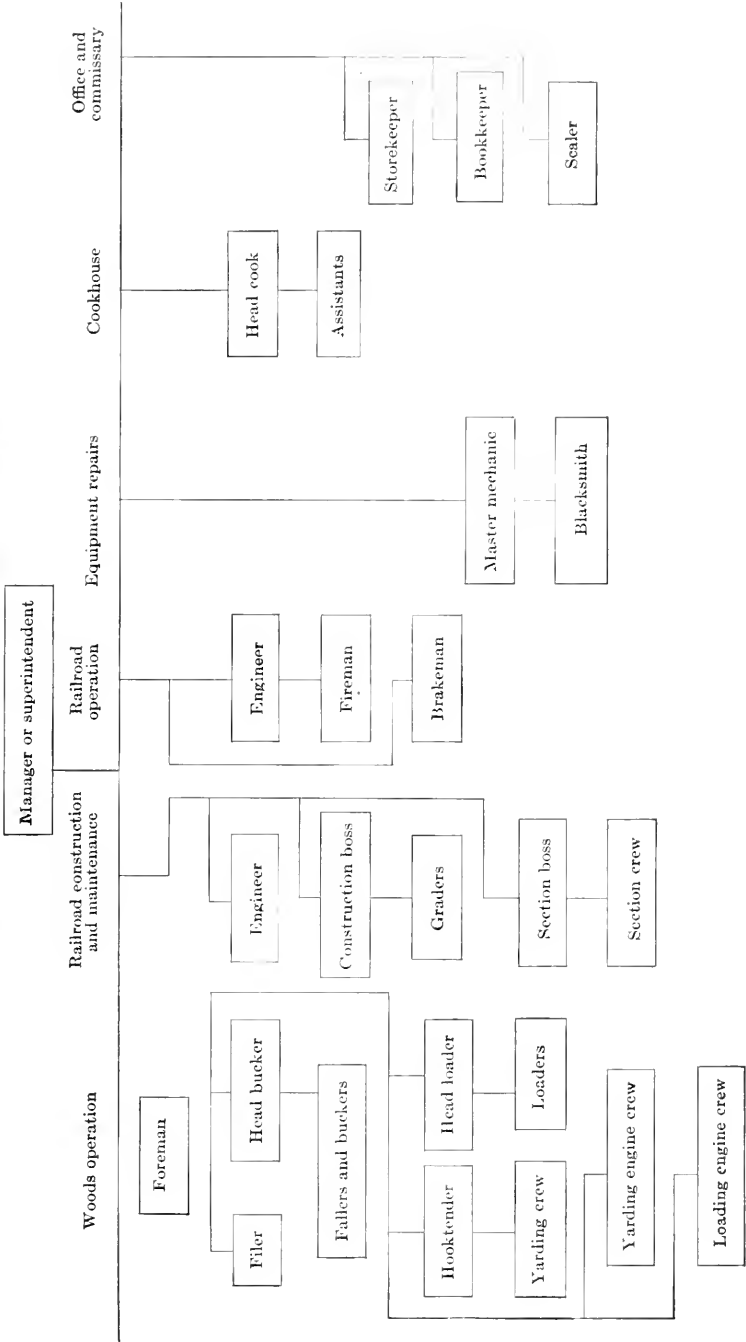

in the territory west of the Rocky Mountains, especially in the Inland Empire and in the Northwest. Various sporadic efforts to unionize loggers in other sections have been unsuccessful. The Loyal Legion of Loggers and Lumbermen (4 L's), first organized in 1917, is the dominating labor organization in the logging industry on the Pacific Coast and in the Inland Empire.

ORGANIZATION

The division of responsibility on a typical logging operation on the Pacific Coast is shown on page 55, that for a southern yellow pine railroad operation on page 56, and for an operation in the Northeast on page 56. Various modifications of the above may be found on individual operations, but in general the scheme of organization is as outlined.

ORGANIZATION OF A SOUTHERN RAILROAD LOGGING OPERATION

General Manager	Location engineer (main line railroad) Woods foreman	Grading contractors	Laborers
		Team boss	{Teamsters Swampers Woods sawyers
Train master		Felling contractor	
		Camp blacksmith	
		Barn man	
		Grading boss (spurs)	Laborers
		Loader foreman and engineer	Loader crew
		Steel crew foreman	Steel crew
		Train conductors	Train crews
Section boss	Section crews		
		Shop foreman (mill)	Shop crew

ORGANIZATION OF A NORTHERN LOGGING OPERATION

General Manager	Woods foreman	Scaler and clerk	Sawyers
		Saw boss	
Drive foreman		Saw filer	
		Road foreman	
		Toters	
		Cook	Flunkies
		Skidding foreman	{Teamsters Swampers Skidwaymen Barn man
		Road repair crew	
		Landing boss	Landing crew
		Log drivers (small streams)	

WORKMEN'S COMPENSATION ACTS

For many years the responsibility of compensating laborers injured in the performance of their work was regulated by Employers' Liability Laws. These held the employer liable for accidents which occurred by reason of his failure to conform to the laws. Lawsuits were frequent and usually proved expensive to all concerned, often resulting, on the one hand, in a denial by the courts of compensation to parties to whom it was due, and on the other, in granting heavy damages to those who were not entitled to them.

The employers protected their interests through liability insurance companies, but a great waste of money resulted since only from 29 to 50 per cent of the premiums paid reached the injured employees or their dependents and fully 40 per cent of this was expended by the injured party for attorneys' fees.

Compensation through liability laws has tended to create an antagonistic feeling between employer and employee, and for many years this method of settlement was regarded as unsatisfactory.

Many states have abolished the liability laws and have passed Workmen's Compensation Acts, which provide, without trial by court or jury, for the payment of specified sums for injuries received. The injured workman secures a definite compensation without legal expense and without regard to the cause of the accident, provided his injury was not self-inflicted. In return, he waives all rights to the common law defences of "contributory negligence," "assumption of risk," and the "fellow servant rule," which were prominent features in litigation under the liability laws.

A further advance in accident prevention has been the passage, by some states, of State Safety Laws, which provide for the establishment of standards for the various industries, such as, (1) a safe place in which the employee may work, (2) the proper safeguarding of machinery, (3) the education of the employee by safety engineers in order that laborers may be fully aware of the dangers incident to their occupation.

The importance of the educational feature has received much attention in recent years. It is stated by some authorities on accident prevention, that three-fourths of all deaths and serious injuries in industry are preventable, but that more than one-half of this

reduction must be accomplished through other than mechanical means, chiefly through organization and education.

There has been a marked advance, in recent years, in "First Aid" facilities in all forest regions. This has taken the form of training one or more men in each crew in first aid procedure and in giving general instruction to all workmen at occasional intervals. "First aid" medical kits also are provided on most operations, and an injured employee now receives some form of simple surgical treatment pending his transfer to a point where skilled help may be secured.

MEDICAL ATTENTION

Many logging companies now provide medical service for their employees and, in some cases, hospital facilities, especially when the logging operations are within reach of the manufacturing plant. The latter practice is quite universal where the operator is both a logger and manufacturer, and controls the town in which the manufacturing plant is located.

The medical service is supported wholly or partially by fees which are collected from the employees. These fees provide medical attention for the workman and his family for ordinary ailments and for accidents. As a rule, a hospital fee designed to cover the cost of board is charged for those who use its services.

The medical department also supervises camp sanitation, in addition to its regular duties.

BIBLIOGRAPHICAL NOTE TO CHAPTER III

- INDUSTRIAL ACCIDENT COMMISSION, California: Logging and Sawmill Safety Orders, effective March 15, 1917. *The Timberman*, Feb. 1917, pp. 48T to 48X.
- INDUSTRIAL INSURANCE DEPARTMENT, State of Washington: First Annual Report, for the twelve months ending September 30, 1912. Olympia, Washington.
- PRATT, C. S.: Washington Workmen's Compensation Act is Successful in its Operation. *The Timberman*, August, 1912, pp. 74-77.
- SPARKS, J. E. and FOREST, E. H. T.: Lumbermen's Safety First—First Aid Manual. Pub. for Industrial Dept., International Comm. of Y. M. C. A., Association Press, New York.
- STATE SAFETY BOARD OF WASHINGTON: Safety Standards for Logging. *The Timberman*, April, 1920, p. 45 to 48.
- U. S. DEPT. OF LABOR, Bureau of Labor Statistics: Workmen's Compensation Laws of the United States and Foreign Countries, Bul. No. 126, Washington, Dec. 23, 1913.

- U. S. DEPT. OF LABOR: Descriptions of Occupations, Logging Camps and Sawmills. Washington, 1918.
- U. S. DEPT. OF LABOR, Bureau of Labor Statistics: Wages and Hours of Labor in the Lumber, Millwork, and Furniture Industries, 1915. Bul. No. 225. Washington, Feb. 1918.
- U. S. DEPT. OF LABOR, Bureau of Labor Statistics: Industrial Survey in Selected Industries in the United States, 1919, Bul. No. 265, Washington, May, 1920, pp. 348 to 356.
- U. S. DEPT. OF LABOR, Bureau of Labor Statistics: Workmen's Compensation Legislation of the United States and Canada, Bul. No. 272. Washington, Jan. 1921.

CHAPTER IV

CAMPS

The early logging camps had crude buildings with no modern conveniences, and the men were given very plain fare. Present-day loggers no longer crowd the workers in small, unsanitary structures and feed them upon poorly cooked food, because workmen demand better living conditions. Many states and also various provinces in Canada have passed laws which are designed to improve sanitary conditions in industrial camps and which require the employer to observe standards which will conserve public health.

CAMP LOCATION

The general requirements for a suitable camp depend upon the type of logging operation and upon the character of labor employed.

The chief requirements for a camp for *snow logging* are:

(1) A central location with reference to a large tract. It is not considered profitable to walk men more than $1\frac{1}{2}$ miles from camp to work, or from one watershed to another, because they consume too much time and energy. It is cheaper to construct new camps if there is a large amount of timber, or a secondary camp if the quantity is small. The camp should be located so that the main-haul or two-sled road will run through the camp lot on its way to the landing. Teamsters then lose no time in getting to work in the morning, returning to feed animals, and getting them to the stable at night after a hard day's work. During the hauling season, time is an important factor, and where long hours are observed every precaution should be taken to husband the strength of animals and men.

(2) A level, well-drained camp site from 1 to 2 acres in extent.

(3) A stream of pure running water near at hand (for drinking, cooking, laundry purposes and stock watering) and so located that it will not be contaminated by the camp sewage.

(4) Accessibility to the source of supplies. This is an impor-

tant factor, although secondary to proper location with reference to the timber and main haul.

The requirements for a camp site for a *railroad operation* are as follows:

(1) A well-drained site, with no swamps or other mosquito-breeding spots in the vicinity, because railroad camps are operated during the warm season when there is the greatest danger from malaria.

(2) Location with reference to a natural supply of pure water is secondary to good drainage, since drinking water is either hauled to the camp in tank cars, or can be obtained by driving wells at the camp site. It is desirable, however, to have a running stream in the vicinity from which water for the stock and for laundry purposes may be secured.

(3) Accessibility to the operation is essential, unless the men can be transported to and from their labor. In the southern pineries, a large percentage of the workmen on logging operations are married, and there is an increasing tendency to establish more or less permanent camps, in order that more conveniences may be provided for the loggers' families. The woods crews are then hauled to and from work by train.

(4) A sufficient area of level ground to permit the construction of the spur tracks required for moving the houses, set-out switches for log cars, and a railroad "Y."

Floating camps are placed in bayous and canals in proximity to the operation. Pure drinking water cannot be secured from these streams and provision must be made for a boiled or distilled supply. Camp location under such circumstances is governed almost wholly by accessibility.

TYPES OF CAMPS

Log Camps. — Typical buildings are usually one-storied and are constructed crib-fashion of logs, preferably of conifers with the slightest taper obtainable. These are notched at the corners to hold them together and to reduce the chink space, which is filled with moss and clay, or mortar. The floors in the living rooms are made of hewed timbers or rough lumber, and the roofs are covered with "shakes" or prepared roofing. The doors are made from rough boards, and a few windows furnish light and aid

in ventilation. Occasionally a framework on which logs are fastened upright is substituted for the crib-work.

Log camps in the North generally comprise the following buildings:

(1) An office and store, sometimes called a "van," which is the headquarters and the sleeping place of the foreman, camp clerk and log scaler. The equipment of the room consists of bunks for the men, a few shelves on which goods are displayed,



FIG. 2. — A Logging Camp in the Northeast. The buildings from left to right are the cook shanty, bunk house, blacksmith shop, and stable. Maine.

and a rough counter over which they are sold, two or three homemade chairs, and a box stove. The store carries supplies required by the woodsmen, such as shoes, clothing, tobacco and a few drugs. Occasionally the office is in one of the main buildings.

(2) A cook shanty which houses the kitchen and dining department. The former usually is placed in one end of the building, and the remaining space is devoted to dining tables running lengthwise or crosswise of the building. Benches are provided for seats. A small sleeping room is partitioned off for the cook.

(3) A bunk house which provides lounging and sleeping quarters for the men. Double bunks, two stories high, are built along the side wall and often across the ends of the building. Each bunk accommodates two men. Straw or hay may be supplied in lieu of mattresses. Blankets may or may not be furnished by the camp.

Long wooden benches, called "deacon seats," are placed alongside of the bunks. A large sink for washing, one or two heating stoves, and a grindstone are also part of the equipment. Wires for drying clothing are suspended over the stove.

Ventilation often is secured by placing a barrel in a hole in the roof and fitting it with a hinged head that may be opened and closed; if this is not used, some other crude arrangement is adopted.

Cook shanties and bunk houses generally are separate buildings, although in the Northeast they often are only from 6 to 10 feet apart, and the gap is covered with a roof, boarded up in the rear and used as a storage place, called a "dingle."

Two-storied camps, having the kitchen and dining-room on the lower floor and the sleeping quarters on the second floor, are sometimes used in the Adirondack mountains, although the general practice is to use one-storied buildings.

(4) Stables or hovels — rough buildings with a good roof and fairly tight sides — are constructed to afford proper protection to animals. They are equipped with stalls, feed boxes, harness racks and grain bins. Each animal usually is allowed a stall space of 5 by 10 feet. When a large number are kept in one camp, the stalls are arranged on opposite sides of the building with an alleyway in the middle in which grain and hay are stored. A 6-foot runway is left behind the animals to facilitate cleaning the barn and to afford a passage for the animals to and from their stalls.

(5) A storehouse, where surplus supplies are kept. This may be a detached building, or a room in the cook shanty set aside for this purpose.

(6) A storage or root cellar which is an underground place where vegetables are kept. It must be frost-proof and yet cool enough to prevent the produce from spoiling.

(7) A blacksmith shop where horses are shod, and sleds and other equipment made and repaired. If a variety of work is performed there must a set of iron- and wood-working tools.

The chief tools required in a first-class camp shop are:

1 forge, complete, including bellows	12 tongs, assorted
1 anvil	1 brace and an assortment of bits
3 augers, 1½-, 2- and 3-inch	1 drill machine and an assortment of bits
1 thread cutter and an assortment of dies	1 bolt clipper
4 hammers	1 striking hammer
1 vise	2 monkey wrenches
1 broadax	2 two-inch iron squares
2 rasps	1 set of horse-shoeing tools
1 coal shovel	1 iron heating stove



Photograph by H. DeForest.

FIG. 3. — A Two-storied Logging Camp. The dining room, lounging room and office are on the ground floor, and the sleeping quarters are on the upper floor. Northern New York.

In addition, a general assortment of cold chisels, drawing knives, and pinchers, and an assortment of files are kept on hand.

(8) Sled storehouses to shelter sleds and other equipment during the summer months.

An average crew for the northern woods is about sixty men, with from twenty-five to thirty-five horses. A camp to accommodate a crew of sixty men and thirty horses would be composed of buildings of the following approximate sizes:

Office and store.....	16 by 20 feet
Cook shanty.....	35 by 37 feet
Bunk house.....	35 by 37 feet

Stables (2).....	40 by 40 feet
Storehouse.....	16 by 16 feet
Blacksmith shop.....	27 by 27 feet
Storage cellar.....	8 by 12 feet
Sled storehouse.....	10 by 15 feet

Although there is variation in the area of the ground floor of all buildings used in northern camps, an average of several gives from 65 to 80 square feet per man. The construction of such camps requires one day's manual labor for each 15 square feet of floor space and one day's horse labor for each 100 square feet of floor space.

In some parts of the North, especially where logging railroads are used or where lumber can easily be secured, log buildings have been replaced by board camps covered with tar paper. Buildings of this character are torn down when a camp site is abandoned and the lumber is used for buildings on a new site.

Portable-house Camps.—The buildings are used indefinitely and are moved from place to place as logging progresses, being placed on skids along the main line or a spur of the logging railroad. Two or three buildings grouped together may form a dwelling for a family, or singly they may be fitted up as bunk houses to shelter two or more men. Large camps in the South may have 100 or more houses and shelter from 200 to 400 persons, of whom only 30 to 50 per cent may be laborers in the employ of the logging company.

Camps of this character constitute small villages which have a school and church, and sometimes a Y. M. C. A., for the benefit of the loggers and their families. Other buildings include quarters for the superintendent, sometimes a boarding-house for single men, barns for the stock, a machine shop, storage houses, coal supply bins for the locomotives and a commissary or store. The store is an important feature in isolated camps for not only the families in camp but also many of the local inhabitants secure their supplies from this source. Stores of this character often carry a large stock of goods and sell, monthly, several thousand dollars' worth of merchandise, groceries and feed.

When families do not live in camps the number of buildings is limited and may include, besides the bunk houses, an office and a cook shanty. The latter because of its large size frequently is not portable. A small "van" is maintained from which the

men can secure such supplies as they need. Camps of this character are found in the Northwest.

Portable houses must be of a size that can be loaded and transported on log cars. Strength in construction is an important factor, because of the frequent handling to which they are subjected.

The buildings vary in size and in mode of construction. In the South they often are 12 by 14 or 10 by 20 feet, with a door at each end and a window on each side. The framework on which the

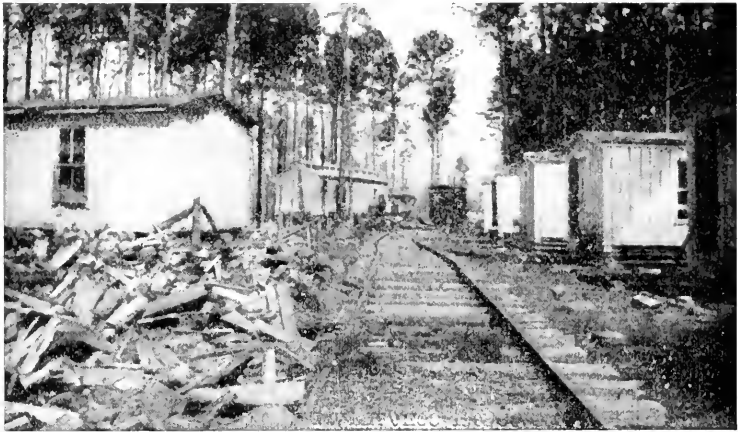

FIG. 4. — A Portable-house Logging Camp. The large building in the rear is the camp store. Arkansas.

floor joists rest is made of heavy timbers, and the side bracing, floor joists and rafters of 2- by 4-inch material. The siding may be 4-inch dressed and matched material, and the interiors of the better houses are ceiled with $\frac{3}{4}$ -inch coiling. A cheap grade of flooring is used. The roof is covered with sheet iron or some patent roofing material.

A house of this character 10 by 20 feet in size requires approximately 2200 feet of lumber, 230 square feet of roofing, 4 window sashes, 4 pairs of hinges, 2 doors and 2 door knobs. It can be built by four carpenters in two days. If kept in good repair and painted at intervals it will last for many years.

Portable houses are loaded on log cars either by animals or log loaders. In loading a house with the aid of animals, the log

cars are "spotted" on the railroad track opposite the house to be loaded, and skids are placed from the house to the car. One end of a cable is attached to the house, the other end being passed over the car and through a block and fall fastened to a tree or stump on the opposite side of the track. A team is attached to the free end of the cable and the house is dragged slowly up the skids and upon the car bunks.

A house can be handled most expeditiously with power log loaders, in which case there must be a heavy 6-inch by 12-inch timber running lengthwise or crosswise under the center of the building. An iron rod, $1\frac{1}{2}$ inches in diameter, having a large eye at one end and a screw thread at the other, is run through the center of the house from the peak of the roof down through the heavy floor beam and made fast with a nut. An empty log car and the log loader having been placed on the track opposite the house, the loader cable is fastened to the eye of the rod, and the whole structure is raised clear of the foundation, then swung around in position and lowered upon the car. It is unloaded by a reversal of the process. In some cases the rods are fixed permanently to two corners of the house, diagonally opposite, and a bridle on the loading cable is fastened to them when the house is to be moved. The moving of the house does not necessitate the removal of the household effects.

Barns for animals at portable logging camps may be either semi-permanent board structures, tents, or specially constructed cars.

Board barns are advantageous in a region where the winter weather is severe, since they can be made tight and afford ample shelter and comfort for the animals. They are built of cheap lumber with a board roof battened, or covered with prepared roofing. Such structures are expensive when camp is moved frequently, because some lumber is destroyed each time the building is torn down, and the cost of erection is considerable.

A form of tent barn 32 feet wide with 14-foot center poles and 7-foot side poles, is recommended by some loggers for temporary camps. Double stalls are made 10 by 10 feet with 6-foot alleys at the rear. A barn of this character made from 12-ounce duck will be serviceable for about two years.

Car barns are used in some parts of the South. A type used in Arkansas has a flat car $10\frac{1}{2}$ by 40 feet in size, with standard

freight trucks on which is built a superstructure 9 feet from the floor to the eaves, with a gradually sloping peaked roof covered with tar paper. A passageway $6\frac{1}{2}$ feet wide runs through the center of the car which provides a place for the storage of hay and

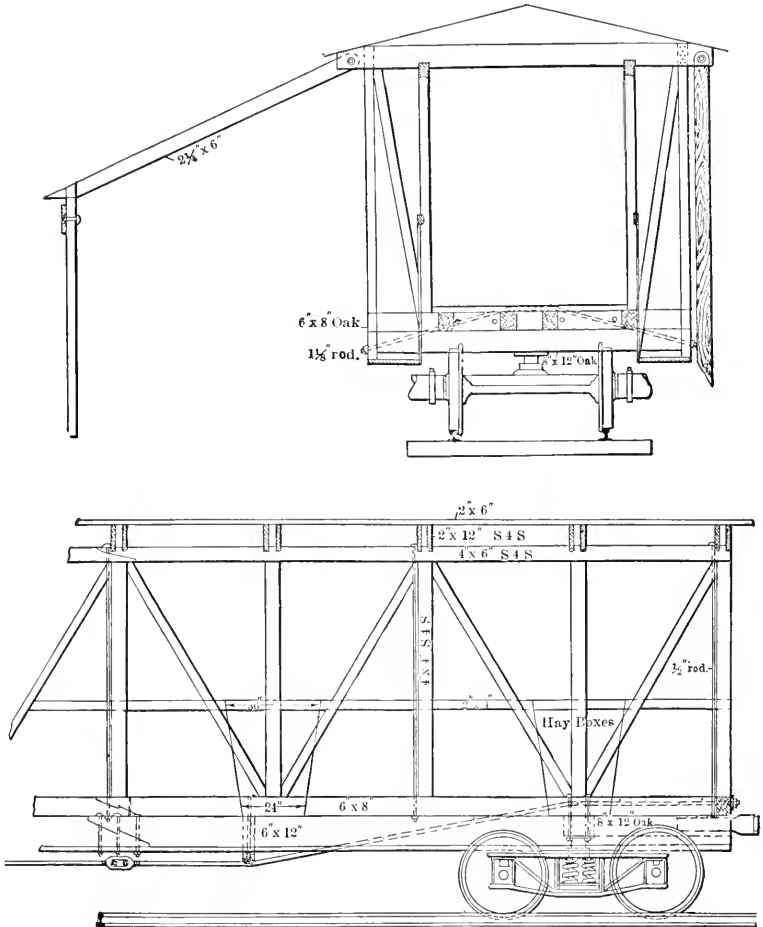

FIG. 5. — An End and Side View of the Framework of a Car Barn.

grain, and on each side of it feed and hay boxes are arranged. A drop roof, supported on 3- by 6-inch by 8-foot scantlings, covers stall space 10 feet wide beyond which an extension roof covers an alley. Four double stalls are arranged on each side of the car

separated by board partitions wired to supports on the car and under the outer edge of the drop roof. The stable floor is filled in with earth to give drainage. No protection other than the short extension roof is provided at the rear. The car is left on a temporary track and in one hour can be dismantled ready to move.

A car of this character is serviceable where frequent changes of site are necessary especially where permanent camps are used, and the animals are stabled near the logging operation. It is not suitable for a region in which the weather is severe during the winter months, although with a little additional labor it would be possible to enclose it on the sides and ends. Corrals are enclosed with panels five boards high and 16 feet long, which are wired to posts set at proper intervals. The only labor required in moving to a new site is to cut the wire and load the panels on flat cars.

Car Camps.—Logging camps sometimes consist of specially designed cars fitted up as sleeping quarters, kitchen and dining room, bath and drying rooms, reading room, office, commissary, blacksmith shop and warehouse. This type of camp has been most highly developed in the Northwest. Although the first cost of construction is higher than for a stationary board camp, car camps are ultimately cheaper. The chief merits of the car camp on wheels are as follows:¹

(1) The camps may be moved quickly to a new site in case of danger from forest fires.

(2) The annual depreciation charge, including maintenance, is rarely more than 10 per cent, which is lower than for stationary camps.

(3) There is a marked saving in wages when camp is moved, since only a few men are required for the operation. The logging crew need not be called away from work for this purpose.

(4) Modern, sanitary car camps attract the best grade of workmen, which insures a steady and reliable crew.

(5) Camps may be moved frequently and the men housed near their work.

(6) A smaller site is necessary and, therefore, the expense of preparing a new camp ground is reduced.

¹ See *Logging in the Douglas Fir Region*, by William H. Gibbons, U. S. Dept. of Agriculture, Bul. No. 711, Washington, 1918, pp. 11 and 12.

Camp cars are rarely used where families must be housed, since the initial investment is too great.

In one Oregon camp the units are built on 34-foot flat cars which have a superstructure 46 feet long, 14 feet wide and $8\frac{1}{2}$ feet high from floor to eaves. Ten cars provide accommodations for eighty men, five cars being used for bunk houses, and one



FIG. 6. — A Floating Camp on a Cypress Operation. The dining room and office are on the ground floor and the sleeping quarters are in the upper story. The building on the left is the camp store. Louisiana.

each for kitchen, store room, dining hall, headquarters and commissary, and power and baths.

Each bunk car accommodates sixteen men and is fitted up with two-storied single bunks provided with springs and mattresses. The cars are steam-heated and electric-lighted and afford comfortable quarters for the men.

A unique departure is the power and bath car which is fitted up with a tub and four shower baths. These are available for the use of the men, under suitable regulations. A power plant placed in this car furnishes light for the camp and a boiler furnishes steam heat for the buildings.

The office, commissary, and foreman's and storekeeper's quarters are placed in a single car, while a storage car holds supplies for the commissary and package goods for the kitchen.

Running water is provided for the camp whenever a gravity supply is available.

Floating Camps. — The camps used in the cypress region on pullboat operations are built on scows, and are usually two-storied buildings in which the entire camp is fed and housed. A portion or all of the lower floor may be devoted to the kitchen, dining room and foreman's quarters, while the upper floor is used for a barrack to house the men and is generally divided into two sections to accommodate white and colored laborers.

A store building is moored close to the main camp and the two connected by a gangplank.

Floating camps are tied up along the banks of bayous or of canals near the logging operation, and the men go to and from work in dug-out canoes called "pirogues," or in flat boats.

BOARDING DEPARTMENT

The establishment of a commissary department for feeding forest workers is necessary whenever the employees do not have their families in camp. This is true in all regions except the southern yellow pine, and often in camps in this region, boarding facilities must be provided for the bachelor members of the crew.

The subsistence department is in charge of a head cook, who has helpers called flunkies or cookees, who wait on table, peel potatoes, wash dishes and perform odd jobs around the kitchen. One or more assistant cooks may be employed in large camps, for the preparation of meats and pastry. A high-grade cook is considered essential, because the season's success usually depends on a constant supply of labor, which cannot be retained unless a variety of wholesome food is provided. A weekly charge may be made for board or the cost of it may be included in the wage paid to a workman.

One flunkie to every twenty-five men is sufficient. All camps also have one or more chore boys who clean up the men's quarters, cut firewood for the kitchen and bunk houses, carry water for bunk house use, and sometimes clean the stables. A launderer or laundress also is employed in some camps.

The kitchen equipment consists of one or more cook stoves, and the necessary utensils required in the preparation of food for large numbers of men. Some of the modern camps now use electric dish-washers and have small refrigerating plants or special underground cold storage facilities for keeping meats and perishable foods.

The kitchen utensils may be of iron, tin, or granite ware. Dining plates and serving vessels often are of granite or agate ware, although heavy china is considered preferable because there is danger of the enamel chipping off granite ware. Cutlery is of steel with plain wooden handles.

Rations. — In preparing bills of fare for camp purposes, the cook is dependent not only on the supplies on hand but also on the regularity with which they are delivered at the camp. This varies with the distance from the source of supplies and the weather conditions. There cannot be a well-defined system of bills of fare in camps where the cook must rely upon wagon or sled transport for bringing in the foodstuffs. When the camp is located on a logging railroad, the problem is more simple, since regularity in delivery is practicable. Cooks are expected to vary the daily bill of fare as much as possible, in order that the workmen may not tire of their food. The average logger's ration is about double that of the United States army on garrison duty and may reach, on an average, between 6,000 and 7,000 calories daily for workers in the colder portions of the country. An investigation of logger's rations¹ made in the Northwest in 1918, disclosed the fact that the unnecessary and avoidable waste in feeding men in logging camps was from 20 to 30 per cent, due to (a) incompetent buyers and to lack of system in making purchases, (b) storage waste through deterioration of perishable foods and to damage by rats and other vermin, (c) table waste, the greatest single factor, caused by serving too great a variety and the preparation of too large quantities of each variety, (d) plate waste, caused by individuals taking more food than they desired. These various wastes were attributed chiefly to serving too large portions of meat and similar foods, greed, food sabotage, and unpalatability. The chief remedy suggested was a reduction in size of portions served, personal appeals to the men to avoid waste, and more careful preparation of food in order that all of it might be palatable.

¹ Made by the Signal Corps, U. S. Army, Spruce Production Division.

Much attention has been given to the elimination of these wastes in recent years, owing to the high price of foodstuffs. Many logging camps now serve excellent meals.

Bills of fare for logging camps have been published in lumber trade journals at various times, in an effort to encourage a varied diet in logging camps menus, because it is a recognized fact that well-cooked, appetizing, and nourishing food tends to increased efficiency on the part of the workmen.¹

Recipes for the preparation of foodstuffs in logging camps have rarely been especially prepared, since the procedure does not differ from that applicable in any industrial camp in which large numbers of men are fed.²

The ration lists given in Table VI are suggestive merely, indicating the general class of foods furnished in logging camps in the Pacific Northwest³ and in the Northeast.

The amount of animal feed required is approximately 30 pounds of hay and 20 pounds of grain daily per animal.

The total weight of animal feed and foodstuffs required to log one million feet, log scale, of timber in the Northeast is approximately 200 tons. Data for other regions are not available.

Commissary supplies and animal feed are usually hauled into northern camps during the late fall and early winter on tote sleds. Where there are good roads, supplies are occasionally wagoned in during the summer. A two-horse team will haul about 1500 pounds of supplies daily for a distance of 20 miles on a sled, while a team of four horses will seldom haul more than 1000 pounds on a wagon. Supplies for railroad camps are brought in, as needed, by rail.

•CAMP HYGIENE

Early logging camps had no system of medical supervision, and occasionally there were serious epidemics in camps, especially in those parts of the country where logging was carried on during the warmer months of the year. They were of rarer occurrence

¹ See West Coast Lumberman, Seattle, Washington, Nov. 15, 1915, p. 20.

² Recipes for the preparation of foodstuffs for a 50-man camp in the Northeast were published in the proceedings of the First Annual Conference of the Woods Department, Berlin Mills Co., et al, held Nov. 25 and 26, 1913, Berlin, New Hampshire.

³ See Investigation of Feeding Operations, Timberman, October, 1918, pp. 65 to 68.

TABLE VI
LOGGING CAMP RATIONS¹
(Pounds per man for one day.)

Commodity	(²)	(³)
Meat, fresh.....	1.25	0.89
Bacon or salt pork.....	0.36
Eggs.....	0.156
Lard substitutes.....	0.080	0.18
Butter and substitutes.....	0.150	.029
Cheese.....	0.050
Milk, canned(⁴).....	0.250
Milk, fresh(⁴).....	1.000
Beans.....	0.125	0.35(⁵)
Potatoes.....	1.000	1.62(⁶)
Canned vegetables.....	0.362
Fresh vegetables.....	0.125	(⁶)
Sugar.....	0.200	0.34
Syrup and molasses.....	0.250	0.067
Jams and jellies.....	0.031
Flour (all kinds).....	0.900	1.30
Cereals.....	0.100
Corn meal.....	0.020	0.082
Corn starch.....	0.020
Rice and barley.....	0.020	(⁵)
Dried and canned fruits.....	0.250
Fresh fruit, etc.....	0.250	0.137
Tea.....	0.010	0.028(⁷)
Coffee.....	0.071	.020
Salt.....065
Pepper.....

(¹) Weights of food as purchased.

(²) Pacific Coast conditions. Prepared by the Signal Corps, U. S. Army. Spruce Production Division.

(³) Maine logging camp.

(⁴) When fresh milk is available, canned milk is not used and vice versa.

(⁵) Includes rice.

(⁶) Includes potatoes and other fresh vegetables.

(⁷) Includes cocoa.

in northern camps because logging was confined chiefly to the colder months of the year when there was less danger of contagious diseases due to unsanitary surroundings.

Most loggers now take every possible precaution to prevent disease. This is due to a realization that the highest labor efficiency can be secured only in camps where a high sanitary standard is maintained, and to the passage of State laws which are designed to protect public health in industrial camps.

State regulations chiefly govern the subjects of water pollution, disposal of camp refuse of all kinds, and ventilation. Bowl

troubles are one of the more common ailments in camps during the warm months, and are often due to poorly cooked or tainted food, and polluted water. Such diseases may be guarded against by supplying pure drinking water, by burning or burying all kitchen and stable refuse,¹ by providing tight latrines, so that flies cannot infect the food supply, and by making provision for adequate ventilation and suitable bathing facilities.

The essentials of camp sanitation are:

(1) A pure water supply. This can be provided only when the camp buildings are so located with reference to the water supply that there is no possibility of contamination from camp sewage. When drinking water is taken from streams, care must be taken to see that the supply is not contaminated at any point on the stream above the camp.²

(2) Adequate disposal of garbage, manure, and all forms of human excrement. Garbage and manure should be burned, buried or treated with some preparation which will keep flies away from it, since they are a common means of spreading disease. Incinerators for garbage and manure can be built cheaply and are an admirable method of disposal.³

Tin cans should be collected daily during warm weather and placed in deep earthen pits and covered with earth, or else they should be placed in a pile, covered with oil and burned over. During the winter months, garbage and tin cans may be stored safely at a distance of 200 feet from camp, provided they are hauled away or otherwise disposed of before the fly season.

In warm weather, waste water from the kitchen, wash and bunk houses, and baths should be carried in closed trenches to

¹ Kerosene sprinkled on barn manure and garbage will keep away flies, but lessens the value of the manure for fertilizing purposes. Borax 0.62 pounds, or crude calcium borax 0.75 pounds per eight bushels of garbage or manure will keep away flies and will not injure the fertilizer value. Two ounces of either of the above chemicals are sufficient to keep flies out of garbage cans.

² A simple test for water purity is as follows: To one glass of water add one-fifth grain of permanganate of potash. This will turn the water a wine color. If organic matter is present the water will turn a muddy brown color, It should not be used for drinking purposes unless, on chemical analysis, the water is pronounced potable.

³ Specifications for industrial camp garbage incinerators may be found in Advisory Pamphlet on Camp Sanitation and Housing, Commission of Immigration and Housing of California, San Francisco, 1914.

a covered cesspool located at a safe distance from the water supply. In case open ditches are used, quicklime should be liberally applied at frequent intervals; otherwise the organic matter will decompose and furnish a breeding place for flies.

The use of fly-proof latrines by men in camp should be obligatory, since typhoid in camp is due chiefly to the infection of food by flies and rarely to polluted water. About 3 per cent of those who have had typhoid fever are "carriers," and to the unsuspected presence of such men in camps, most of the typhoid epidemics may be traced. A daily application of 5 pounds of quicklime to the latrine pit will keep it in a sanitary condition.

(3) Fly-proof sleeping, kitchen, and eating quarters and latrines. Food infection cannot be prevented unless care is taken to carefully screen not only the living and eating quarters but also the chief sources of infection. Such protection is easy to secure and should be obligatory in every industrial camp.

(4) Adequate air space and ventilation. The air-space requirements of various states for industrial camps is not uniform, but the best standards require not less than 500 cubic feet of air space per man, combined with adequate ventilation.¹

(5) Adequate bathing facilities. Many camps are not provided with shower baths or other bathing facilities for the workmen, although they are quite common in the camps of the Pacific Northwest. Bathing facilities have proved an important factor in reducing wound infection and, therefore, are very desirable. Compulsory camp laundry service is also an aid to the prevention of wound infection. Experience has shown that woods workers in most sections of the country appreciate such facilities and use them freely. The problem of providing bathing facilities in northern camps is more difficult than in the South and West, because of temperature conditions, and they are seldom furnished.

(6) Cleanliness in the kitchen and dining room. The degree of cleanliness found in camp kitchens and dining rooms is extremely variable unless properly supervised by the management

¹ The Camp Sanitation Rules formulated in 1914 by the Wisconsin State Board of Health call for 225 cubic feet of air space per man; the standard for the Loyal Legion of Loggers and Lumbermen is 500 cubic feet per man; the Province of Ontario, Canada 400 cubic feet per man. Wisconsin requires a ventilation duct in the roof equivalent to 4 square feet per 500 square feet of floor space or fraction thereof. The 4 L's specify 14 square feet of window space per man, a small window for each bunk being preferable to larger ones.

or by some representative of the State Board of Health. State regulations usually provide that the kitchen and dining room shall be scrubbed at least bi-weekly and swept daily.¹

(7) Adequate drainage of the camp site. This is essential in order to prevent the pollution of the water supply and to eliminate mosquito breeding holes.

Ideal sanitary regulations of the Loyal Legion of Loggers and Lumbermen, formulated in 1919 by the sanitary inspector and adopted by the Board of Directors of that organization, are as follows:

WATER

“Adequate supply of pure drinking water with some satisfactory type of drinking fountain. (The use of a common drinking cup is not allowed.) Water supply must be protected from contamination from source to points of distribution.

CAMP SITE AND GROUNDS

“Whenever possible a well drained camp site shall be selected. The grounds in the immediate vicinity of buildings shall be kept free from rubbish, garbage and all other unsightly or unsanitary matter. All buildings should be connected by serviceable walks of boards or other suitable material.

BUNK HOUSES

“Bunk house should be raised from ground at least 2 feet, and in damp situations more. Any design best fitted for the locality in which camp is situated may be used. Preferences should be given to the smaller type — none should house more than 25 men. Good substantial walks of plank or other suitable material should connect all bunk houses with all other buildings in the camp.

“Bunk house should have suitable roof ventilation and should be large enough to provide a minimum of 500 cubic feet of air space per man. Four square feet per man window space should be provided, numerous small windows (one for each bunk) are preferable to a lesser number of large windows.

“Bunk houses should be adequately heated by steam, hot water or stoves. Roof, walls and floors should be weather tight. Iron

¹ “Dry Sweeping” is prohibited in public camps in most states.

post bunks with wire springs should be used exclusively. Bunk house floors should be swept daily, and scrubbed once each week, or oiled every two weeks. Bunk houses should be thoroughly aired daily.

“Bedding should be cleaned and aired frequently.

“Every camp (except the very small ones) should have one able-bodied man whose sole duty should be to clean up the camp. All cuspidors, spit boxes or other receptacles used for a like purpose should be throughly cleaned daily.

BATH HOUSES

“There should be a minimum of one shower head for each twenty men. Bath house should be centrally located so as to be easily accessible from bunk houses, and should be well ventilated, lighted and water tight.

“Drainage from shower compartments should be carefully constructed and lead, through covered drain, to cesspool or other proper place of disposal. The hot water heater should be of sufficient capacity to insure an adequate supply of hot water for bathing, washing and laundry purposes. Separate control for hot water and cold water should be installed.

“Bath rooms must be kept scrupulously clean. The use of individual towel and soap should be insisted upon in bath and wash room.

DRY ROOMS

“Dry rooms are not required east of the Cascades. In other districts they should be well heated, well ventilated, separate from living and sleeping quarters and should contain ample space so that each individual's clothes can be placed without coming in contact with others.

LATRINES

“Latrines should be located at a point where they will not contaminate water supply, or be a nuisance to camp on account of odors. They should always be placed on opposite side of camp from kitchen and not less than 150 feet from bunk houses. They should be easily accessible from camp, connected to it by a substantial board walk, and should have a light over the doorway at night.

“Latrines should be sufficiently large to afford one seat for each eight persons, should not contain open cracks or knotholes, and should be fly-tight around the bottom of the shelter. All openings should be screened with No. 16 or 18 wire mesh.

“Holes should be large and fitted with self-closing covers. The interior aspect of the box should be protected on the inside by a tin or iron urine shield. Toilets should contain a non-leakable urine trough connected by tight drain to earth vault.

“The earth vault should not be less than 8 feet in depth. Exereta should be covered weekly with oil or live lime. Some type of vent should connect the vault with the open air. This vent must be screened. Floors must be swept daily, seats weekly, and urinal trough mopped daily with crude oil. Floors should be oiled once each week. An ample supply of paper must be constantly kept on hand.

MESS HALLS

“The mess hall should be located not less than 250 feet from the latrines. Mess halls should be adequately lighted, heated and ventilated, and should be sufficiently well constructed so as to leave no open cracks in floors, walls or ceiling.

“Mess halls should be made fly-proof, should provide sufficient table space to allow a minimum of 22 inches per man at table.

“The tables should be washed after each meal. Floors should be scrubbed twice each week, or oiled once a week, and swept with care daily. Avoid dry sweeping. Condiment bottles and containers should be scalded with hot water and wiped carefully each day. All dishes and cutlery should be thoroughly washed in hot water and soap and rinsed in boiling water before drying.

MEAT HOUSE

“The meat house should be very carefully constructed, and should be absolutely free from cracks and knot holes. It should be set high off the ground and present at least three sides to the air. It should be perfectly screened with a fine mesh wire netting. Walls and ceiling should be ceiled with seasoned matched ceiling, and painted white or light slate. Floor should be well-made of matched lumber, and either oiled or painted. Meat hangers should be so placed that meat will not come in contact with the

walls. The meat block should be round and smooth, and either painted or varnished on all surfaces except top. Doors should fit tight, and be self-closing.

“The meat house interior and all tools, furniture and utensils should be kept scrupulously clean.

KITCHENS

“The kitchen should be well lighted and ventilated. It should be either in the same building as the mess hall, or connected to it by a fly-proof enclosed passageway. All openings should be screened and all doors should have some automatic closing device attached.

“All drainage should be of the covered drain type. Dish water and other liquid waste should be conveyed to a cesspool or sullage pit through covered drains. All kitchen garbage should be kept in metal fly-proof, covered containers, until permanently disposed of.

“Kitchens should be thoroughly cleaned at least once each week, and swept daily. Dry sweeping should not be permitted. No persons afflicted with a communicable disease should be allowed in the kitchen or mess hall. Absolute cleanliness of persons and clothes of cooks, helpers, and waiters should be demanded, and particular attention should be given to hands and nails. Failure to observe this rule should cause dismissal.

“All perishable food should be protected from putrefaction and contamination by dust or insects. An ample supply of hot and cold running water should be supplied at all times. The kitchen should be kept free from flies, roaches, mice and other vermin. Cats, dogs and other pets should be excluded. All persons not actively engaged in the preparation of the food should be kept out of the kitchen.

SANITARY SERVICE

“The camp superintendent should be held strictly responsible for the sanitation of the camp. He should oversee and direct the camp janitor in the performance of his duties. It should be the duty of the camp janitor to clean up and keep clean the entire camp, including all bunk houses, reading rooms, toilets and the camp grounds. (The kitchen and mess halls are entirely

within the province of the cook and his helpers.) The camp janitor should see to the proper disposal of all garbage and refuse and should daily inspect all buildings under his care. He should note all damage and defects in any doors, windows, ventilators, screening, and all apparatus or fixtures connected with the heating, lighting or bathing and washing facilities of the camp, and repair or cause them to be repaired at once.

“Garbage and refuse from cook houses should be placed in covered, water-tight garbage cans. Cans should never be left uncovered and should be emptied and cleaned inside and out daily.

“A stand to hold garbage cans should be constructed just outside the kitchen door. The stand and surrounding ground and wall should be treated with crude oil frequently, to repel flies.

“Kitchen waste or garbage should be disposed of by burning, burying or feeding to hogs. (Hogs should never be allowed to roam at large, but should be kept in a hog-tight enclosure. This should never be less than 500 feet from the camp; same rule applies to stables. Manure pile should not be allowed to accumulate in vicinity of camp.)

“Fly-tight boxes or other receptacles should be placed at convenient points in the immediate vicinity of the living and sleeping quarters. In these should be placed all sweepings, waste paper, discarded clothing, and other refuse of the camp. These should be emptied and contents disposed of by incineration as the occasion may demand.”

BIBLIOGRAPHICAL NOTE TO CHAPTER IV

- BEIN, F. L.: Refrigerating System for the Cook-house. The Timberman, April, 1920, p. 32P and October, 1920, pp. 59, and 60.
- JAFFA, M. E.: The Uses and Values of Foods. The Timberman, Nov. 1915, pp. 60 to 62.
- LIPSCOMB, Dr. W. N.: Logging Camp Sanitation. The Timberman, Nov. 1917, pp. 64G to 64H.
- RUEGNITZ, W. C.: Eliminating Waste in the Boarding House. The Timberman, Sept. 1917, p. 36 and Nov. 1917, pp. 63 and 64.
- RUEGNITZ, W. C.: Standard System of Management of Mess Houses. The Timberman, Nov. 1921, pp. 34 to 38 incl.
- SPRUCE PRODUCTION DIVISION, Bureau of Aircraft Production: Construction of Camp Kitchens and Mess Halls. The Timberman, Sept. 1918, p. 33.
- THARALDSEN, THORFINN: Investigation of Feeding Operations. The Timberman, Oct., 1918, pp. 65 to 68.

CHAPTER V
WOODWORKERS' TOOLS AND EQUIPMENT

AXES

An ax head consists of two parts: namely, the bit or cutting edge and the head or poll. The latter has an eye into which is fitted the helve or handle. There are several types of axes, chief among which are the falling ax, the broadax and the turpentine ax.

Falling Ax. — This is used for felling, log-making, swamping and other chopping work. The head is made in a variety of patterns and of several weights. It tapers from the poll to the bit and has either smooth, slightly concave or beveled sides. The eye is oval-shaped and has a larger diameter on the side opposite the handle in order that a wedge may be inserted in the handle head. The head may have one or two cutting edges. The former is known as a single-bitted and the latter as a double-bitted ax. A single-bit is in common use where a light ax is required, where a single cutting blade is needed, or where the ax is to be used for striking. A double-bitted ax is serviceable where a woodsman has need of a sharp cutting edge, and at times must cut dry knots and other material that quickly dull the tool. It is a favorite with swampers and some sawyers prefer it for driving wedges.

Bits are made of steel and are either straight or curved. They must be properly tempered, for if too soft the edge will turn and if too hard it will break.

The weight of the head depends on the character of work that is to be performed and the personal ideas of the laborer.

In the Northeast fallers prefer an ax head weighing from $3\frac{1}{4}$ to 4 pounds, while the western loggers prefer one weighing from $3\frac{1}{2}$ to $4\frac{1}{2}$ pounds.

Swampers and others who cut limbs and brush, snipe logs and perform similar work use an ax head weighing from 4 to 5 pounds.

The handles for single-bitted axes are either curved or straight, the choice being chiefly one of individual preference. Handles

are preferably made of second-growth hickory, but camp blacksmiths often use hard maple for them. In the eastern part of the United States loggers generally prefer a 36-inch handle, while on the Pacific Coast handle lengths range between 38 and 40 inches for average-sized timber and up to 44 inches for redwoods. Handles for double-bitted axes are straight in order that either bit may be used. They are made in the same lengths as those for single-bitted axes.

Broadax. — The broad ax is used for hewing timbers, cross-ties, and work of a similar character. The more common form has a reversible bit, $11\frac{1}{2}$ or 12 inches long, a heavy square poll and a flat inner face. It may be used either right-handed or left-handed. The outer side has a slightly concave face and a cutting bevel $\frac{3}{4}$ -inch wide on the bit. The usual weight of the head is 6 or 7 pounds. Handles are from 26 to 36 inches long with a slight upward curve immediately behind the eye which enables the workman to assume a more upright position and still maintain a correct cutting angle for the blade.

Turpentine Ax. — A special form of ax is used in southern pine forests for cutting the "boxes" or receptacles in the bases of the trees in which the crude turpentine is collected.

It is made in two patterns, namely, the square poll and the round poll, the type used being a matter of personal choice. A turpentine ax has a long, narrow bit so that a deep, narrow incision may be made. The usual dimensions are: length, $11\frac{1}{2}$ or 12 inches; width of blade, $3\frac{1}{2}$ inches. The average weight is $5\frac{1}{2}$ or 6 pounds. Straight hickory handles 36 inches in length are considered best.

SAWS

Saws are made in a variety of lengths and widths of blade, and in numerous shapes and patterns of teeth to meet special requirements and to conform to the preferences of certain localities.

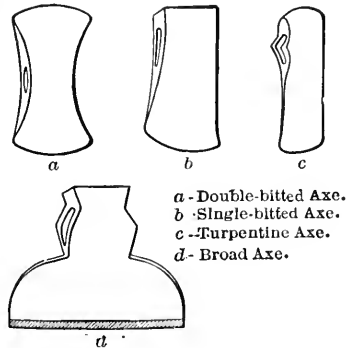

FIG. 7. — Characteristic Types of Ax Heads.

The Blade. — In small- and medium-sized timber a $5\frac{1}{2}$ - to $6\frac{1}{2}$ -foot blade is used, while for the fir timber of the Pacific Coast the saws range in length from $7\frac{1}{2}$ to 10 feet, with a maximum length of 18 feet in the redwood region. The width varies with the pattern of the saw, and ranges from 4 to $8\frac{1}{2}$ inches.

A slightly curved saw blade is most frequently used because it affords a larger space for sawdust. This makes it run with less friction and the work is less fatiguing. Saws are made thinner at the back than at the cutting edge, in order further to reduce friction. Saws for felling large Pacific Coast timber are more limber than those used for log-making, because the latter are

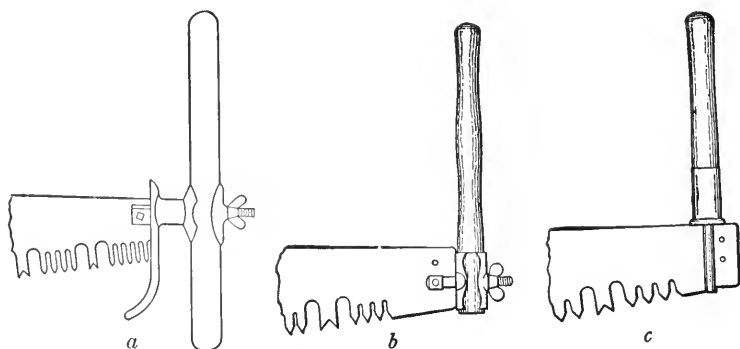

FIG. 8. — Common Types of Cross-cut Saw Handles. *a.* Reversible saw handle used in the Pacific Coast Forests. *b.* Climax pattern saw handle. *c.* Loop handle.

operated by one man and a stiff saw is needed to prevent the blade from buckling on the forward stroke. Felling saws usually are 17 gauge on the back and 13 gauge on the cutting edge, sometimes 18 and 14 gauge respectively, while bucking saws for western use often are 18 gauge on the back and 13 gauge on the toothed edge.¹

Handles. — The handles used on cross-cut saws are round, about $1\frac{1}{2}$ inches in diameter, and range in length from 12 to 18 inches. They are fastened either by clasps which fit into holes in the ends of the saw, or by loops which fit over the ends of the saw. The upper part of the loop is threaded and the handle

¹ The standard gauge used for the measurement of thickness in the United States is the Stubbs or Birmingham wire gauge. The value, expressed in fractional parts of an inch, for 18 gauge is $\frac{3}{64}$ full; for 17 gauge $\frac{1}{16}$ scant; for 14 gauge $\frac{5}{64}$ full; and for 13 gauge $\frac{3}{32}$ full.

is tightened by screwing it down firmly against the back of the sawblade. Either type permits the ready removal of the handle from the blade.

Teeth. — The teeth on a cross-cut saw are arranged in pairs, trios or quadruplets, each set of which is separated by a cleaner or raker for removing the sawdust. Where skilful filers are not available a saw without rakers may be used, the sawdust being carried out of the cut by the teeth. The forms of teeth preferred

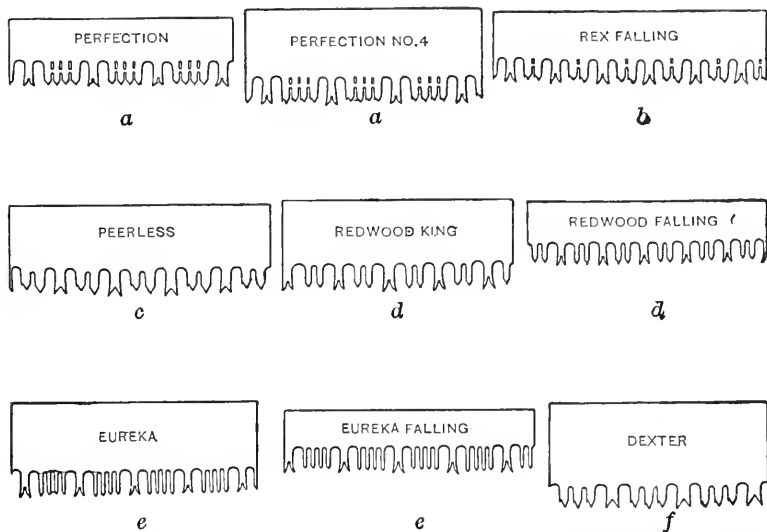

FIG. 9. — Saw Teeth Patterns. *a.* Often used for sawing southern yellow pine, cypress and spruce. *b.* For sawing white pine, hemlock and cedar. *c.* For sawing yellow poplar and cottonwood. *d.* For sawing redwood. *e.* For sawing Douglas fir. *f.* For sawing white oak.

are as follows: yellow pine, cypress and spruce — perforated lance teeth, arranged in sets of four (Fig. 9a); white pine, hemlock and cedar — broad teeth in sets of two (Fig. 9b); poplar and cottonwood — heavy solid teeth in twos (Fig. 9c); redwood — solid lance teeth in twos (Fig. 9d); Douglas fir — solid lance teeth of fours (Fig. 9e); white oak — solid teeth in sets of three (Fig. 9f).

The cutting teeth constitute a series of knives which strike the fibres at right angles and sever them on either side of the cut. The cleaners or rakers free the severed fibres which are then

carried out in the cavities of the teeth in the form of sawdust, occupying about six times as much space as the fibres did previous to cutting. Long, stringy sawdust denotes a well-fitted saw.

Loose-textured and long-fibered woods are the most difficult to saw because the teeth tear rather than cut the fibres, a larger quantity of sawdust is produced, and the rough character of the walls of the cut offers resistance to the saw. Coniferous wood is more readily sawed than hardwood, because of its simple anatomical structure and fine medullary rays.

Experiments made by Gayer¹ show the resistance to the saw across the fibres of green timber to be as follows, the resistance to beech being assumed as 1.

	Resistance to saw.
Scotch pine, silver fir and spruce..	0.50-0.60
Maple, larch, alder.....	0.75-0.90
Beech.....	1.00
Oak.....	1.03
Aspen and birch.....	1.30-1.40
Willow and poplar.....	1.80

Saw-fitting. — The cutting edges of the teeth are beveled to a fine point, the degree of bevel depending on the character and condition of the wood.

The filing and care of saw teeth is called “saw-fitting,” and requires skill and experience.

The tools that comprise a complete saw-fitting set for cross-cut saws are as follows:

1 combined tooth gauge, jointer and side file.

1 saw set.

1 tooth set gauge.

1 swage, or 1 set-hammer.

Several flat files.²

The characteristics of a well-fitted saw are:

(1) All cutting teeth must be the same length so that each will do its share of the work.

¹ Gayer, Karl: Forest Utilization (Vol. V, Schlich's Manual of Forestry; trans. from the German by W. R. Fisher; 2nd ed.). London; Bradbury, Agnew and Company, 1908.

² Flat files from 6 to 8 inches long are preferred by saw fitters. The life of a file depends on its quality; as a rule one good file will fit from 3 to 6 saws.

(2) The rakers or cleaners should be not less than $\frac{1}{64}$ of an inch nor more than $\frac{1}{40}$ of an inch shorter than the teeth.

(3) The form of tooth bevel depends on the character of timber that is being sawed. It should not be too flat for sawing frozen timber, very hard timber or wood that has many tough knots.

(4) All teeth should be filed to a sharp point.

(5) Saws require a certain amount of "set," which is given by springing out alternate teeth in one direction and the remainder in the opposite direction so that the saw will cut a kerf somewhat greater than the thickness of the blade. Dense-fibered and frozen hardwoods require the least set, while pitchy pine and soft broadleaf trees require the maximum. Only the minimum set required should be given because the greater the set the more power required to pull the saw. Some operators recommend a set equal to one-fourth the thickness of the blade for hardwoods such as maple, birch, beech, and oak, and one-third the blade thickness for softwoods such as hemlock, pine and spruce.

The art of successful saw fitting consists in securing the proper balance between the length of the tooth points and that of the rakers. In hardwood sawing, the scoring teeth do not sink as deep at each stroke as in softwood, and the bevel of the cutting points is less acute. Longer rakers can be used with hardwoods than with softwoods due to the more shallow scoring by the teeth. The raker length should be such that clean-cut shavings and not fine dust are produced. When fibers, known as "whiskers" adhere to the edge of shavings it is an indication that the rakers are cutting below the depth at which the teeth have scored the wood, and the rakers, therefore, should be shortened. As a general rule, rakers for hardwoods should be about $\frac{1}{64}$ inch shorter than the teeth points. For softwoods, they should be from $\frac{1}{40}$ to $\frac{1}{32}$ inch shorter.

Rakers usually are swaged or given a slight bevel on the point, since this tends to plane the wood out of the cut rather than to drag it out. When sawing hard maple, however, the rakers are not swaged because the long strings of sawdust tend to curl up in the gullets of the saw and do not readily fall out when the saw leaves the cut.

Successful saw filers often find it necessary to adjust their filing practice to the class of labor which is to use the saws. For

example, Yankee sawyers take a quick, light stroke, while Scandinavians take a slower stroke, and "ride" the saw harder. Saws for the latter class of workmen should have shorter rakers than for the former.

Saw-fitting may be done by a member of the saw crew or by a regular filer who works either in the forest or at the camp. In the former case, the filer usually makes a saw stand by cutting off a 3- or 4-inch sapling at a convenient working height and then sawing a slot about 3 inches deep in the top of it in which the back of the saw is placed. Post supports are driven in the ground at a distance of from 24 to 30 inches on either side of the sapling in order to support the saw ends. The saw is then shifted along the supports, as the filing proceeds, the actual work being done at the point where the saw blade rests in the slot in the sapling. Some convenient stump is used as a base for the setting block, if a "stump set" is used.

Filing in camps is done in a specially equipped shop provided with a permanent saw stand, and in some cases with a power-driven emery wheel which is used to grind down the gullets of the saw. The latter practice is not followed when saws are filed in the forest.

The steps in saw-fittings are as follows:

(1) Joint the teeth. This consists in running a file over the tooth points in order to make all of them a uniform length. The dull tooth points must later be sharpened.

(2) Adjusting the length of the rakers. If they are to be swaged they are left the same length as the teeth. If they are to remain unswaged they are cut down by placing the raker gauge over the raker and filing down to the required length. Rakers are filed to a keen, sharp edge which should be exactly at right angles to the saw blade. If the teeth are to be swaged they are struck lightly on the point with a hammer and the point turned down.

(3) File the teeth. The harder the wood the less the bevel required. Having chosen the style of tooth point to be used (Fig. 10) file each tooth, taking care not to reduce its length. A beginner is inclined to file too heavily and thus wear down the teeth too rapidly. Start at the heel of the bevel and run the file towards the point using a rather light free stroke.

(4) Set the teeth. This may be done either with a setting

block and hammer or with an anvil and hammer.¹ The teeth are bent slightly away from the line of the saw blade, the beveled face always being on the inside. Uniformity in set is secured by the use of the tooth set-gauge or "spider" the point of the upper arm in contact with the tooth point being short to give the re-

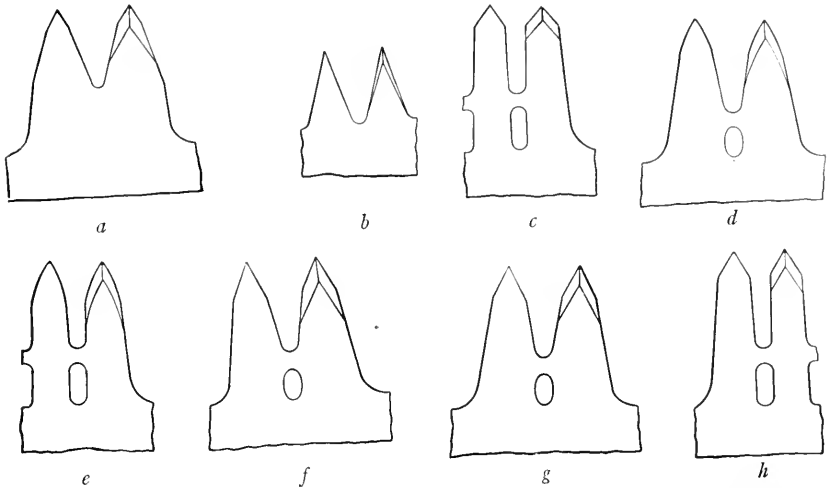

FIG. 10. — The Forms of Bevel used on Cross-cut Saws. *a*. Diamond point bevel, easy to maintain, and the point holds well. *b*. Bevel for a tooth where there are no rakers, the teeth cleaning out the sawdust. *c*. Bevel for knots and frozen timber where strength is needed in the extreme point — not adapted for fast-sawing. *d*. Round point for fast, smooth sawing, in knotty timber. *e*. Bevel for fast, smooth sawing — teeth strong. *f*. Flat, thin bevel for soft wood and fast sawing — point is not as strong as that shown in *e*. *g*. Bevel adapted for general work. *h*. Bevel adapted for general work.

quired set. When the tooth is spread to the required distance all four legs of the tooth set-gauge will rest firmly against the saw.

(5) Side dress the teeth. If there are any feather edges on the teeth they are removed by the use of the side file or an emery stone.

This completes the operation of saw fitting. An expert filer fits daily from twelve to fifteen saws of average length. A saw will cut from 400,000 to 500,000 board feet before the teeth become so short that it is discarded.

¹ See page 87 for the amount of set given cross-cut saws.

When the felling crew does the log-making, one sharp saw is provided each day, otherwise a sharp saw is furnished every other day.

Saws filed daily are serviceable for a period of from two to four months and are then turned over to road-making crews and other laborers who do not require high-grade tools.

POWER FELLING MACHINES

There has not been a satisfactory power-driven tree-felling machine placed on the market. Machines of various types have been patented and offered for sale but they have not proved of practical value.

Devices such as drag, circular and endless-chain saws operated by steam, electricity, compressed-air or gasoline power have been devised, but they have all been too heavy and bulky for transportation in the forest. Their weight is not only a handicap in getting the machine around through brushy woods and over rough bottom, but also prevents their rapid removal from the vicinity of falling timber where they are continually subject to damage.

POWER LOG-MAKING MACHINES

On comparatively level land in an open forest composed of large trees, drag saws, called "steam dagos" driven by compressed air have been used successfully for "bucking" logs.

The equipment consists of a traction engine with an air compressor and an air storage tank. The saw, which may be attached readily to a log of any size, is driven by a piston working in a small cylinder, mounted on a metal frame weighing from 60 to 75 pounds. The cylinder is connected with the air chamber on the engine by a line of hose of sufficient length to give a working radius of 300 feet. Three frames and one saw are the usual equipment for an outfit.

Drag saws mounted on skids and driven by a small gasoline engine¹ or by steam power are used extensively in the West to buck logs into fire-wood lengths for logging engine use. The maximum capacity is approximately 25 cords daily. Gasoline-driven saws also have been used successfully in the South

¹ Usually from 3 to 4 horse power.

for felling timber along logging railroad rights-of-way when it was necessary to cut trees at or near the ground level.

WEDGES

Fallers and log-makers require wedges to aid them in directing the fall of trees and to prevent the binding of the saw in the cut. They are made either of metal or of hardwood. Iron or steel wedges may be made by the camp blacksmith, or purchased from dealers in loggers supplies.

The size and weight of metal wedges vary with the work for which they are used, and the pattern is largely a matter of in-

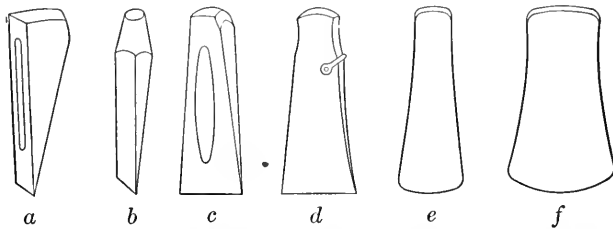

FIG. 11. — Some Types of Wedges used by Loggers. *a* and *b*. Wood chopper's wedges. *c*. Tie maker's and faller's wedge. *d*. Faller's wedge. *e*. Log maker's wedge, Pacific Coast. *f*. Faller's wedge, Pacific Coast.

dividual preference. Felling wedges, especially when used in large timber, are longer than those used for log-making. A common form of metal wedge used on the Pacific Coast by fallers is made from 1-inch steel and is about 13 inches long and 3 inches wide at the point and weighs from 6 to 8 pounds. In Maine the felling wedges are shorter and may be shaped somewhat like a hatchet head. They are 6 or 7 inches long, 3 inches wide at the base, and $1\frac{1}{2}$ inches wide and 1 inch thick at the top. On the Pacific Coast the buckers often use a wedge similar to the one shown in Fig. 11e. In most regions fallers and log-makers use the same type of wedge.

Since smooth-faced metal wedges are likely to rebound, shallow grooves often are made on the faces so that when driven into a cut the pressure causes the wood to partially fill the groove and prevents any backward movement. The faces are sometimes roughened slightly with a cold chisel to accomplish the same purpose.

Hardwood wedges of hickory, hard maple, beech, ironwood, dogwood and persimmon are frequently used in the southern pine region when local timber for their manufacture is accessible. They are preferred because they are inexpensive and hold well in a cut. They may be made by the sawyers as needed or by contract. They are ordinarily 6 or 8 inches long, $2\frac{1}{2}$ or $3\frac{1}{2}$ inches wide and 1 inch in thickness at the head.

Felling crews in the Northwest usually carry two long and three short wedges and log-makers, five bucking wedges. In other regions where the timber is of medium size the sawyers use from two to four wedges. From four to five wooden wedges per day are required by a saw crew of two men.

Metal wedges are either carried by the fallers in a small canvas sack slung over the shoulder, or one is fastened at each end of a piece of hay wire, 3 or 4 feet long. Wooden wedges are carried in the hip pockets of the workmen.

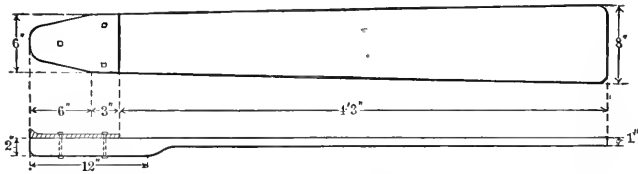

FIG. 12. — A Spring Board used by Fallers in the Northwest.

MAULS AND SLEDGES

Iron wedges may be driven with a wooden maul made by the camp blacksmith from hard maple, yellow birch or any tough wood. A common form used in Maine is made from a round tree section, 6 inches in diameter and from 26 to 30 inches long. An 8-inch head is left on one end of the section and the remainder is trimmed down to a diameter of 2 inches to form a handle. The head may or may not be bound with iron hoops to prevent splitting. Steel sledge hammers of 8 or 10 pounds' weight are used in the Northwest for driving metal wedges. Wooden wedges are driven either with an ax or a sledge.

SPRING BOARDS

These are used only in the Northwest, and serve as platforms on which notchers and fallers stand when performing their work. The spring board with the spur uppermost is thrust

into a horizontal notch cut into the tree. When the faller's weight is applied to the outer end of the board the spur is forced into the wood, preventing the board from slipping and allowing it to be swung around, the spur acting as a hinge. Spring boards usually are made in the camp blacksmith shop.

KILHIG OR SAMPSON

This tool is used as a lever to aid in directing the fall of a tree. It consists of a pole 3 or 4 inches in diameter and from 8 to 16

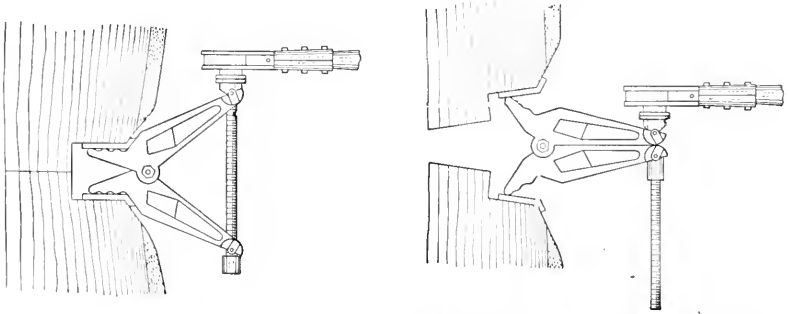

FIG. 13. — A Kilhig or Sampson used in directing the Fall of a Tree.

feet long, either sharpened, or armed on one end with a spike. The pointed end of the pole is placed in a notch in the tree trunk from 5 to 8 feet above ground, the free end projecting downward to a point 10 or 12 inches above the ground where it is supported on a peavey handle or a pole the lower end of which is firmly planted in the ground. A laborer grasps the free end of the peavey handle and by pressing forward is able to exert a strong pressure against the bole of the tree. Kilhigs are frequently made as needed by the saw crew since it is easier to cut a pole than it is to carry one. This tool is in common use in the Northeast. There are several patent tools of similar character used in European forests but they have not met with favor in this country.

TREE FALLER

The tree faller or jack (Fig. 14) has been introduced on the Pacific Coast to enable fallers to throw trees in any direction regardless of lean. It consists of two lever-arms which are spread by means of a lever-actuated screw. The arms rest on an oscillating plate, which serves to increase the bearing surface. The



From Bul. 711, U. S. Dept. of Agriculture.

FIG. 14. — A Patent Tree Faller, showing the Manner of Insertion in the Notch (left), and the Position of the Jaws when the Cut has been opened about Seven Inches.

opening between jaws, when fully extended, is 7 inches. The weight of the tree faller is 166 pounds, and is so constructed that it may be separated into two loads of nearly equal weight for ease in moving it from one tree to another. It has proved of especial service in throwing timber which is heavy when it has been necessary to change the normal direction of fall because of danger of excessive breakage due to bad ground conditions.

GUN STICK

Fallers in the redwood region sometimes use a gun stick to determine the direction of fall of a tree that has been undercut. The usual length of a gun stick is 8 feet overall, although 10-foot sticks are sometimes used when very large timber is being felled. Two types are in common use, Fig. 15a being preferred by some because the wood on the "diamond" on Fig. 15b sometimes swells during wet weather and does not work easily. A faller standing between the extended legs of the gun stick, which he grasps about 3 feet from the ends, places a leg at each outer corner of the undercut. Holding the stick firmly against the

tree, he stoops down until he can sight from the bolt to the rivet, which line of sight indicates the direction in which the tree will fall provided it stands straight and the undercut has been made properly. If the direction of fall is to be altered, one leg of the gun stick is slipped around the tree, until the desired direction of sight is attained. The point on the tree at which the shifted leg touches indicates the outer edge of the revised undercut.

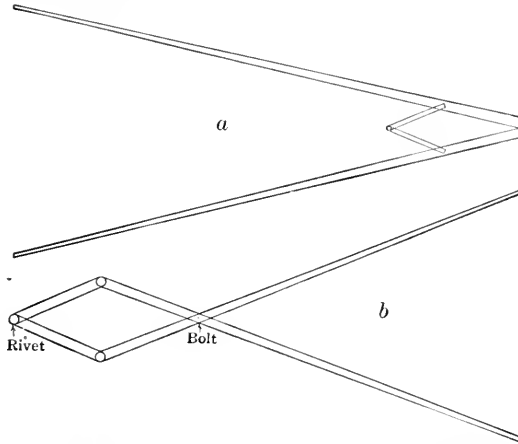

FIG. 15 — Two Types of Gun Sticks used by Redwood Fallers.

MEASURING STICKS

The measuring sticks carried by log-makers usually are 8 feet long, where logs 24 feet and under are being cut. In the Northwest they often are 10 feet long. They may be made by the sawyers from a straight sapling with little taper, or by the camp blacksmith from squared sticks which are cut to exact length and on which marks are placed at two-foot intervals. Unless wooden measuring sticks are metal-tipped, or have a nail driven in each end, the buckers are apt to chop off one end when marking off log lengths on the bole. Sticks shortened in this manner are often the cause of logs being cut to improper lengths. It can be corrected by allowing buckers to use only those sticks which are furnished by the company and the length of which is frequently checked by the saw boss. A measuring stick made from 1/4 inch round iron is an excellent substitute for the wooden ones. It is light in weight, cannot be shortened by carelessly chopping off the ends, and when not in use may be stuck upright in the ground near at hand.

PEAVEY

The peavey is used as a lever to handle logs, and is an indispensable part of a logger's equipment. The standard maple or ash handle is 5, 5½ or 6 feet long, but it may be made in special lengths from 4½ to 8 feet. There are two types, namely, the socket peavey and the clip peavey.

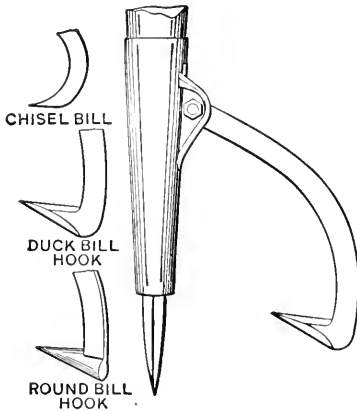

FIG. 16. — A Socket Peavey.

The handle of the first is fitted into a socket, which is armed on the lower end with a pike, and on the upper end of the socket is a clasp to which the hook is bolted.

The second has a pike driven into the end of the handle, which is bound with a metal band to prevent the wood from splitting. The hook is attached to a clip or clasp independent of the pike.

The hooks are of three types, namely, "round bill," "duck bill" and "chisel." The round bill is preferred for summer work because it does not stick in the log; the duck bill is best for frozen timber as it will penetrate the wood more readily than the other forms; the chisel point is in limited use.

CANT HOOKS

Cant hooks are used for purposes similar to the peavey, although they are employed more around mills and in handling sawed timber than in handling logs. Standard handles are 4½, 5 and 5½ feet in length. They are shod on the end with a heavy band of iron, carrying on its under side a "toe" which replaces the pike on the peavey. A hook of the same character as that on the peavey is fastened to the handle by a clasp.

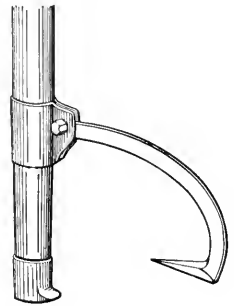

FIG. 17.—A Cant Hook.

PICKAROON

Laborers engaged in bringing crossties, stave bolts and other timber down steep slopes often use a pickaroon, which has a handle 36 or 38 inches long on the end of which is attached a head with a recurved pike. These heads are frequently made from worn-out ax heads by removing a portion of the cutting edge.

UNDERCUTTERS

The undercutter is a tool used by the "bucker" or log-maker in the Northwest. It serves as a support for the saw when making an undercut on a fallen tree.

It is a round or flat rod of iron about 2 feet long with a head on one end and single or double claws on the other. These claws are sharp and are driven into the side of the bole. Sliding on this rod is a block carrying a milled wheel which can be raised or lowered to accommodate the depth of cut, and on this the back of the saw rests. Buckers frequently dispense with undercutters because of the annoyance of carrying them and insert the bit of an ax in the bole in such a way that the ax handle serves as a base on which the back of the saw may ride.

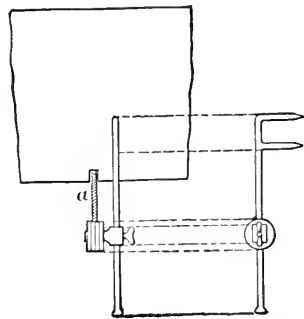

FIG. 18. — A Type of Undercutter used in the Pacific Coast Forests. *a* is the saw blade resting on the milled wheel.

USE OF KEROSENE

In felling coniferous woods, resin collects on the saw and soon causes it to bind. This is remedied by the use of kerosene. Fallers and log-makers in the pine forests of the South carry a pint bottle of kerosene, fitted with a stopper made from green pine needles. The crew usually keeps a gallon can near at hand from which to replenish its supply. At frequent intervals the saw is sprinkled on both sides with the oil. A crew cutting from 12,000 to 15,000 feet log scale, daily, will use from one and one-half to three pints of kerosene. Four gallons per week is regarded as a liberal allowance.

CHAPTER VI

FELLING AND LOG-MAKING

SEASON

The period of the year in which felling is done is governed by climatic conditions and by the method of logging followed.

Where loggers rely on a heavy snowfall to furnish a bottom for transporting logs, felling begins in the late summer or early fall and continues until the snow becomes too deep for profitable skidding, which is about the middle or latter part of December.

On railroad operations in the Northern States, felling is carried on throughout the greater part of the year, ceasing only when the snow becomes too deep for operation, or when deemed advisable because of market conditions.

In the coniferous forests of the South and in the Northwest, felling is carried on the year round as weather conditions seldom interfere seriously with logging.

Hardwood felling may continue throughout the year. Owing to the fact that the sapwood of species such as hickory is subject to insect damage¹ if cut during the summer months, the season of felling may be restricted to the resting period of the tree, although hardwoods can be cut safely at any season if they are manufactured in a short time and the lumber well piled and seasoned. The galleries made in sap wood by insects afford an entrance

¹ Certain species of ambrosia beetles, "sawyers" and timber worms are very destructive to the sapwood of felled hardwood and coniferous timber during a portion of the year. The danger of attack is greatest in timber cut during the fall and winter and left on the ground or in close piles, during the early spring and summer; also to trees cut during the warm season. The presence of bark is necessary for infestation by most of these insects and the danger can be largely avoided by not allowing the logs to accumulate during the danger season, or by barking such as cannot be removed within a few weeks. (A detailed discussion of these problems may be found in various publications of the U. S. Bureau of Entomology.)

for the spores of certain fungi¹ which cause a discoloration. The fungi develop most rapidly during warm, sultry weather. Summer-felled timber may be very seriously damaged by insects and fungi in from two to four weeks.

The felling time of trees, such as oak, is sometimes restricted to the late summer and early fall if the timber is to be transported by water because heavy species cut at this season and allowed to dry for from sixty to ninety days become more buoyant.

The logging of hemlock often is restricted to the period between May and August, during which time the bark will peel.² As it is a valuable by-product, used for tanning purposes, the logger seldom cuts the timber without saving the bark.

Tanbarks are also secured from chestnut oak (*Quercus prinus*) and from the tanbark oak of California (*Quercus densiflora*). The season for peeling chestnut oak is from early April until the end of June, and for tanbark oak, from the middle of May to the middle of July. The timber in both cases is now used for commercial purposes, although the bark often is the more valuable product.

Coppice fellings should be made during the winter and early spring because the sprouts are then more thrifty than those from trees cut during the growing period.³ Late winter felling is preferred because there is less chance for the bark to be loosened from the stool by the collection and freezing of moisture.

The season of the year in which timber is cut does not, so far as known, influence its strength, although it may affect its durability. Hardwoods are more complex in structure and are more easily damaged in seasoning than are softwoods. Winter-felled hardwood timber air dries more satisfactorily than summer-felled timber because the water content evaporates slowly and the

¹ There are several genera of fungi which attack the sapwood of deciduous and coniferous woods, causing a bluish, blackish or reddish discoloration. The infection takes place largely through spores carried into the galleries made by ambrosia beetles, sawyers and other borers.

² Bark from hemlock logs cut in December or later may be successfully peeled from May to July inclusive, provided they are properly decked. The quality of bark is said to be equal to that peeled in the usual manner during the summer months. Bark from logs that have been in the water is valueless. See American Lumberman, July 21, 1900, p. 18; Dec. 30, 1916, p. 31.

³ See Chestnut in Southern Maryland, by Raphael Zon. Bulletin No. 53, U. S. Bureau of Forestry, 1903, pp. 14-17.

woody structure adapts itself to the gradual shrinkage with a minimum amount of checking. Some loggers apply a coat of thick whitewash to hardwood logs to prevent end checking. Others use a preparation composed of one part lamp black to sixty parts of rosin. The mixture should be heated but not boiled, then thoroughly stirred, and a coat 1/8 inch thick applied.

These preparations should not be applied until the moisture has ceased to ooze from the log.

DEADENING

Deadening or girdling consists in cutting a ring around the tree deep enough to penetrate to the heartwood. This ring is made just above the root swelling, approximately at the sawing point.

The deadening of trees reduces the water content of the boles and renders them lighter in weight. It is seldom resorted to with most species, because those which cannot be floated when cut in the ordinary way are either left standing or are hauled by rail to the mill. Green cypress timber does not float well, hence deadening or girdling is universal when timber is floated to the mill. Even when cypress timber is railroaded it is usually girdled because (1) the logs will then float in the mill pond, (2) the sapwood is rendered somewhat tougher and skidding tongs do not pull out so readily, and (3) the heartwood in green timber swells during cutting and binds the saw.

Logging in cypress swamps is carried on throughout the year and some girdle timber at any convenient time, although the sapwood is more subject to insect attacks at certain seasons. The greatest damage occurs during the months from May to September, inclusive¹. Girdling precedes felling from a few weeks to several months and generally is done by contract for a given sum per tree. One man will girdle about twenty-five trees per day.

DIRECTION OF FALL

This should be governed by the following factors:

(1) The lean of the tree. A straight or slightly leaning tree may be sawed to fall in any direction by the use of wedges. Heavily leaning trees can be thrown by the same means in any

¹ Hopkins, A. D.: Pinhole Injury to Girdled Cypress in the South Atlantic States. U. S. Bureau of Entomology, Cir. No. 82, 1907.

one of three directions, namely, as it leans or to either side. Where a tree leans only slightly and its inclination cannot be determined readily by the eye, an ax handle held suspended like a plumb line between the line of sight and the tree will serve as an indicator.

In determining the direction of fall the choice is influenced by the shape of the crown. Very few crowns are symmetrical, one side often being heavier than the other, because of better light conditions. This preponderance of weight on one side acts as a powerful lever and, therefore, must be considered by the faller.

(2) The avoidance of lodging one tree in another.

(3) The selection of a spot where the bole will not be broken on stumps, rocks or other objects. This requires special attention in handling large or brittle timber. In yellow pine the loss from this source may be 1 per cent of the total, while in western red cedar it is often from 15 to 20 per cent, and in redwood even higher. Boles of the latter are sometimes so badly damaged in felling that they are worthless. A bed for redwood is frequently made by leveling the ground and covering it with brush.

(4) The simplification of skidding work. In brushy regions it is desirable to fell trees parallel to the skidding trail, since this aids the teamster in getting out the logs. Timber cut for snaking with power skidders should be felled away from or toward the direction of haul, especially if long timber is being handled, because it is difficult to drag out logs that are placed otherwise. Timber on slopes should be felled either up or down according to the location of the nearest accessible skidding trail. Trees felled up steep slopes are less subject to breakage because the distance of fall is less. It is, however, a more dangerous method because the trees may shoot down the slope.

ORGANIZATION OF CREWS

The organization of crews for felling and log-making differs in the various forest regions. Sawyers in the Lake States often work in crews of two under the direct supervision of a saw boss, who keeps a close check on the work, assigns each crew to a given territory, specifies the lengths of logs and sees that waste does not occur in cutting.

In southern pine operations a similar plan may be followed.

the sawyers being responsible to the logging boss or to a contractor instead of a saw boss; or two or three saw crews may be in charge of a sub-foreman, called a "chipper and notcher," who notches trees for felling, marks off the log lengths, and keeps a record of the amount cut by each crew. The duty of the sawyers is to fell the timber and to cut it up into logs.

In Maine, felling often is in charge of a sub-foreman called the "head chopper" who is the boss of a yarding crew, which

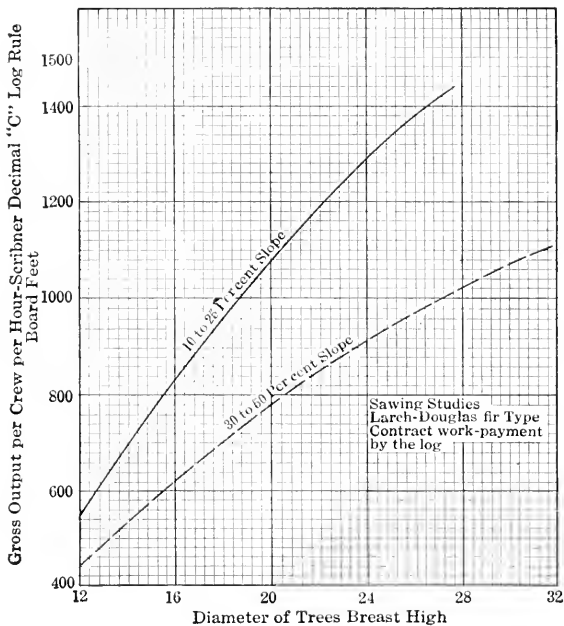

By permission U. S. Forest Service.

FIG. 19. — Graph showing the Effect of Slope on the Output of Felling Crews. Inland Empire.

includes two fallers, the swampers, teamster, sled tender and skidway man. The head chopper notches the trees, lays off the log lengths and directs the work of the yarding crew.

On the Pacific Coast notching, felling and log-making may be performed by separate crews. A notcher, who selects the trees to be felled and makes the undercut, is assigned to each yarding crew. Two fallers then cut the timber and the notcher marks off the log lengths for the guidance of the buckers who follow. The latter work singly, and two or three are required for each

falling crew. On some operations a notchman is not employed, the undercut being made by the fallers. This is now considered the best method.

The output per falling crew or falling and bucking crew is influenced by the character of the topography, the amount of brush and windfall, the size of the timber, the season of the year, the method of payment, and the effective time put in by the crew. The steeper the slope or the rougher the bottom, the lower the output per crew because of the greater difficulty of getting around and the greater care which must be exercised in felling the timber to prevent breakage. The effect of slope upon output is shown graphically in Fig. 19. Heavy brush and windfall also reduce the output of a crew because of the greater amount of swamping required before a tree can be felled and because greater care must be exercised to prevent breakage. Sawing studies made in the Inland Empire show that the output per crew increases with an increase in the diameter breast high of the tree, until diameters of 34 or 36 inches are reached, at which point the output begins to decline. This is probably due to the greater amount of rest required when the larger trees are felled. Average-sized trees can be felled without stopping to rest, while the larger ones require one or more resting periods in which the fallers can "catch their breath." See Figs. 19 and 20. Timber cuts more easily in the summer than in the winter, because frozen timber is harder to cut; also, workmen's muscles are more supple during the warm months than during the cold because they do not become chilled during the resting period. Fallers and buckers working on a contract basis will do more work than those who are paid a stated wage.¹ The effective time put in by a crew is determined not only by the recognized hours of labor, but also by the distance which the workmen must walk from camp to the job, since if the distance is 1 mile or more, from 10 to 20 per cent of the working day may be consumed in going to and returning from the job.

The average day's work for two men felling, bucking and swamping lodgepole and other small timber, running from fifteen to sixteen logs per thousand board feet is from 4000 to 5000 board feet; in small yellow pine timber, running from twelve to fifteen logs per thousand, from 7000 to 7500 feet, and where logs run from six to ten per thousand, from 10,000 to 15,000 feet. Two

¹ See Fig. 20.

fallers will average about 5000 feet, log scale, daily, in eastern spruce, about 10,000 feet in southern hardwoods, and from 25,000 to 30,000 feet in Douglas fir. Buckers on the Pacific Coast average from 12,000 to 15,000 feet each, per day.

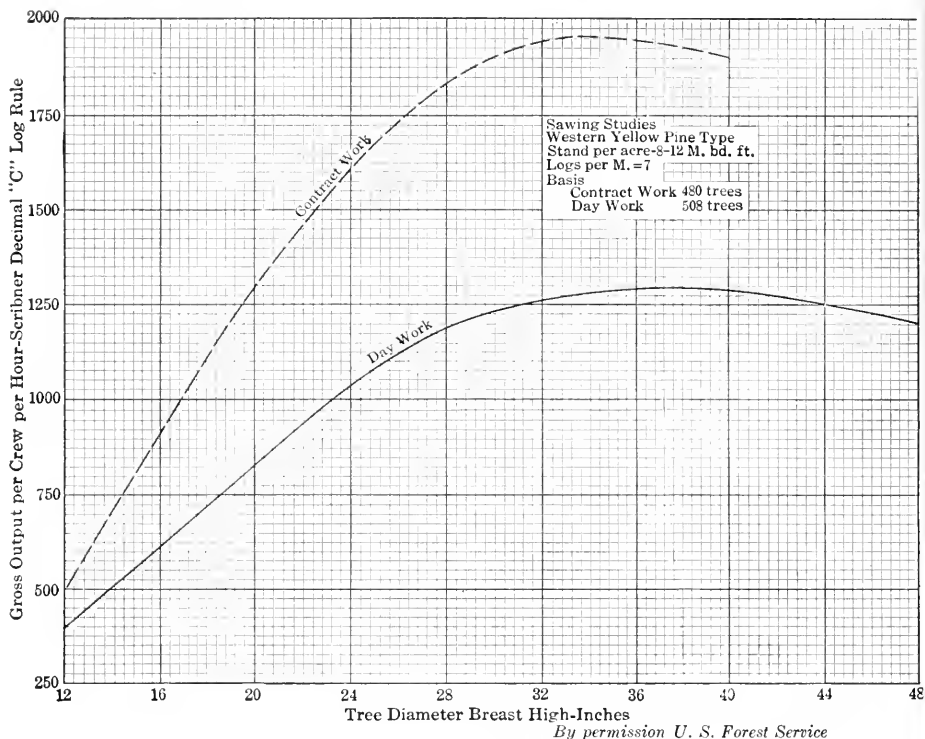

FIG. 20. — Graph showing the Influence of Method of Payment on the Output of Felling and Log-making Crews. Inland Empire.

CUTTING AREAS

Sawyers working on a wage basis may not be assigned to specific bounds, but cut where the foreman of the camp or the saw boss direct. When the work is done by contract, fallers are assigned to definite bounds in order to facilitate the measurement of the cut timber and to insure the felling of all merchantable timber; otherwise the workmen may leave trees which are difficult to cut or which would entail so much labor that their daily earnings would be reduced.

NOTCHING

A wedge-shaped notch or undercut is made on the trunk in the direction of fall, to guide the tree and to prevent the bole from splitting before it is completely severed from the stump. It has a horizontal base extending slightly past the center of the tree if felling is done with the ax, and from one-fifth to one-fourth of the diameter when felling is done with the saw. The undercut on trees that lean heavily in the felling direction is



FIG. 21. — The Undercut on a Douglas Fir Tree. The fallers are standing on spring boards to enable them to make the cut above the root swelling. Washington.

made deeper than usual in order to insure a clean break. On those that lean away from the felling direction a small notch is cut because it gives the wedges greater power. In felling large redwood the sloping face of the undercut is sometimes made below the horizontal cut instead of above it in order to avoid the waste of timber which would occur if the usual method were followed.

The notch is placed from 2 to 4 inches below the point at which the felling cut is started on the opposite side. Its height above ground is determined entirely by the policy of the logger

regarding stump heights. Notches may be cut with the ax, but the horizontal cut usually is made with a saw and the notch completed with an ax.

Hardwood timber, if improperly notched, pulls long splinters from the heartwood. This may be overcome by continuing the center of the undercut into the heart of the tree. When the tree is severed on the opposite side a clean break will result.

On small- and medium-sized timber the notch can readily be cut by a workman standing on the ground. A form of scaffold must be provided for notching and felling large timber and for this purpose spring boards are used. When trees of very large size such as redwoods are cut the spring board may be replaced by a scaffold supported either on spring boards or on timbers.

FELLING

With the Ax. — The ax was used almost exclusively as a felling tool during the early period of logging in the United States and is still used for small trees. In felling with an ax, the operation begins by cutting a wedge-shaped notch opposite and slightly higher than the undercut. This cut is continued towards the center of the bole until the tree falls. Wedges cannot be used in felling with the ax, therefore, it is more difficult to throw a tree in any direction except that in which it leans. It is estimated that from 10 to 20 board feet per tree of spruce is lost when the ax is used exclusively for felling and log-making.

With the Ax and Saw. — This method is now universally used for medium- and large-sized timber because a loss both of time and wood occurs in using the ax alone. The use of a cross-cut saw increases by about 10 per cent the number of trees a given saw crew can fell in a day.

When the bark contains sand or other gritty substances it is customary to remove it from the base of the tree at the point where the saw cut is to be made. The saw cut is then started on a level with or slightly above, and opposite the undercut. When the saw has buried itself, wooden or iron wedges are driven in behind it to prevent binding. As sawing proceeds the wedge point is made to follow the back of the saw by occasional blows from an ax or a sledge. Sawing in a direction parallel with the undercut progresses until the tree begins to fall, whereupon one sawyer withdraws the saw and both seek a place of safety.

On very large timber, fallers first saw deeply on both sides of the undercut, then saw around the tree, making the last cut on the back side of the bole parallel to the undercut.

Trees with rotten hearts require different treatment from sound ones because the decayed bole is apt to give way before it is severed from the stump. A cut a few inches deep is made around the tree and then the bole is severed from the rear as in felling sound timber. Even if the bole gives way before the cut is completed it seldom splits badly. Felling during high winds is accomplished in the same manner. The direction of fall under either of the above circumstances often cannot be determined accurately, and the work is considered hazardous.

When timber is felled in a direction other than that in which it leans the faller leaves the most wood between the saw cut and the undercut on the side opposite to that in which the tree leans. This tends to pull the tree in the desired direction.

STUMP HEIGHTS

There is no rule other than a commercial one regulating stump heights in different sections of the country. Loggers in early days cut very high stumps in order to avoid root swellings, pitchy butts and other defects.

The greatest waste from this source occurred in the Pacific Coast forests where stumps sometimes from 15 to 18 feet high were left by the early logging operators. Twelve thousand board feet of merchantable timber per acre was not an excessive amount to be wasted in this manner. At the present time sound stumps seldom exceed 3 or 4 feet in height. Coniferous species, like western larch, often are so pitchy in the butt that from 4 to 6 feet must be left in the stump when the timber is to be transported by water. In the yellow pine forests of the South the stumps are cut from 16 to 24 inches high; in the spruce region of the Northeast they often are from 10 to 12 inches.

The tendency in all sections is to reduce the height of stumps on sound timber to the lowest point practicable. It is not profitable to cut a low stump on most species when the butt is rotten, because a large portion of it may be trimmed off and thrown away during the process of manufacture. Saws cannot be kept as sharp on very low stumps as on those of medium height since

grit dulls the saw, especially in a sandy soil. Sawyers cutting very low stumps cannot cut as much timber per day because the work is more fatiguing, consequently the decrease in the cut of a saw crew due to low stumps may reach 15 per cent in medium-sized timber.

The general rule on the National Forests is that the stumps shall not exceed 18 inches in height. Lower stumps may be required at the discretion of the inspectors. The stump height on slopes should be determined at the contour line.

LOG-MAKING

Utilization of the Tree. — The bole usually is the most valuable portion of the tree, however, the curly stumps of black walnut and other species are highly esteemed for cabinet work. In many localities, rough tops and limbs are cut to a diameter of from 2 to 4 inches for firewood, pulpwood, charcoal burning and destructive distillation. Faggots are not utilized in this country.

The portion of the bole which is removed from the forest is influenced by the location of the timber with reference both to the manufacturing plant and to markets. The lumberman with accessible timber may be able to handle low-grade logs which an operator with a less favorable location could not bring out profitably.

The transportation charge for carrying lumber to markets is also a powerful factor in determining the extent of utilization, inasmuch as all grades of a given species pay the same freight rate and when the latter is high, low grades cannot be shipped at a profit. An interesting example is that of the shortleaf and longleaf pines of the South. Both species usually are sold at the same price f.o.b. at a given mill, but since longleaf weighs more per thousand feet, in some cases 300 pounds on a given item, the freight charge to market is greater and hence shortleaf can be shipped to more distant markets, or a lower average grade can be manufactured and the same profits secured as in the case of longleaf.

Crooks, knots, pitch, worm holes and other defects are factors that influence the amount of bole taken. The extent and character of the defects that a log may contain and still be mer-

chantable is governed by the species and the use to which the timber is to be put. Chestnut lumber containing many "pin-worm holes," has a market value both for veneer backing and for the manufacture of tanning extract if the timber is otherwise sound. On the other hand, oak with similar defects brings a low price because its physical properties do not fit it for many purposes. Defective logs of white pine, yellow poplar and other woods suitable for the manufacture of box material may be utilized because the lumber is cut into short lengths and the unsound portions eliminated, while logs of yellow pine with similar or fewer defects are frequently valueless for this purpose because the wood is heavy, making higher freight charges on the package, and southern yellow pine crates, when placed in cold storage, taint dairy products, eggs and certain other foodstuffs.

The amount of bole taken depends on the ultimate use of the timber. This is well illustrated in cutting white oak for rived stave bolts which are split along the line of the medullary rays. Since the timber must be straight-grained and free from knots, only the choicest cuts are taken and a large part of the bole often is left in the forest.

Market conditions are a potent factor in regulating the minimum size and character of timber that can be handled profitably. High-grade logs produce a sufficient percentage of low-grade lumber to supply a dull market, while a brisk demand enables the logger to bring out a large per cent of his inferior material because it can be sold for enough to cover the cost of manufacture and yield a small profit. Close utilization will not be general until the public is prepared to pay higher prices for lumber.

Log Lengths. — Builders consider even lengths of from 10 to 24 feet most advantageous and these have come to be recognized in lumber markets as standard. Mills handling small- and medium-sized timber which is skidded by animals, cut their logs into the above lengths in the forest, while those manufacturing long timbers or using power skidding machines either bring in logs varying from 24 to 60 feet in length or the entire bole to a top diameter of from 4 to 6 inches. These logs may be cut into shorter lengths at the railroad or landing but delivery at the mill of long logs is considered preferable for crooked or defective timber since the loss from improper division of the boles can be reduced. An experienced man at the mill can cut the boles into

log lengths more rapidly and economically with a power machine than can the buckler in the woods, and special orders for unusual lengths can be filled without loss of time.

Logs to be rafted down large streams should be cut into long lengths, because the raft can be built stronger and cheaper.

The transportation of long logs out of the forest is destructive to young growth because their length requires considerable swamping for animal transportation, and when a ground system of power skidding is used a large amount of young growth is broken or bruised before the log reaches the run down which it passes to the machine.

The "board" mills in the yellow pine region cut logs into standard lengths a large percentage being 12, 14 and 16 feet. The "timber" mills cut longer logs to meet their special requirements.

Cypress operators who railroad their timber to the mill cut logs into standard lengths between 10 and 20 feet. On pull-boat operations where logs are floated to the mill the whole trunk or 30- to 50-foot logs are skidded.

Hardwood logs rafted down the Ohio river and other large streams are cut into lengths of from 40 to 60 feet, while on small streams and on railroad operations standard-length logs are the rule.

In the Adirondack mountains spruce logs which are to be manufactured into lumber are cut chiefly into lengths of 10, 12, 13, 14 and 16 feet, and those for pulp manufacture into even lengths of 14 feet or more. In Maine spruce is cut either into standard lengths, or the butt cut is made from 30 to 40 feet long and the remainder left in a top log which is taken to a diameter of 4 or 5 inches.

White pine is largely cut into standard lengths.

Douglas fir on the Pacific Coast is cut into logs ranging in length from 26 to 60 feet and sometimes longer. The customary lengths range up to 40 feet with a high percentage of 32-foot logs.

In the redwood region about one-fourth of the logs are cut 16 feet long. The remainder are cut into lengths of 18, 20, 24, 32 and 40 feet. The longer lengths are cut from the smaller trees.

Method. — The first step in log-making is to cut the limbs from that portion of the bole which is to be utilized. This is

done with an ax by a member of the saw crew or by a special man called a swamper, knotter or limber. The bole is then laid off into log lengths either by the head sawyer or by the "chipper" who uses an 8- or 10- foot measuring stick.

In log-making there are several problems which the workmen must solve depending on the position of the felled tree.

(1) When the tree lies flat on the ground, bucking-up is a simple matter as the sawyers start their cut on the lower or upper part of the bole at the marked point and continue until the log is severed from the bole. When the saw begins to bind wedges are driven into the cut and made to follow the saw by an occasional blow from an ax or maul. Binding often is overcome by felling the tree across a log.

(2) When the bole is supported at one end, care must be exercised to avoid splitting slabs from the under side. This is accomplished by making a cut 2 or 3 inches deep on the under side of the bole. In addition the log may have its free end supported by a false work of logs, or by a heavy stick placed in a vertical position directly under it. The saw cut is then started on the upper face and continued until the log breaks off from its own weight.

(3) When the bole is supported at both ends the cut is usually started on the under side and continued until it extends one-half or two-thirds of the distance through the log. A cut is then started on the upper side of the bole and continued until the log is severed. The bole is often supported by heavy sticks placed in a vertical position under both sides of the cut.

(4) When the bole is sprung between trees or stumps the general practice is to make a deep cut on the concave face and then to saw or chop on the outer face. Caution is required where trees are badly strained because they may break with considerable force and injure workmen.

In small- and medium-sized timber it is generally the duty of the felling crew to cut the bole into logs as soon as the tree has been felled. An exception to this occurs where the bark of trees such as hemlock, chestnut oak and tanbark oak are sought for tanning purposes. In this case the felling of the trees and the stripping of the bark are done by a crew whose work may precede the actual logging operation by several weeks. Log-making under these circumstances often is done by a separate crew.

Log-making in the large timber of the Pacific Coast has been developed along special lines. The large size of the timber prevents the use of a two-man crew unless a scaffold is constructed on which the men can stand. This is not necessary because one man with a 7- to 9-foot single-handled saw can cut logs to advantage by standing on the ground. He starts his cut with the saw at an angle and gradually brings it towards the horizontal as it nears the bottom of the log. Thick-barked timber requires special preparation before bucking-up because the bark is a great hindrance to the bucker. The practice in redwood forests is to remove the bark from the log and when the refuse is dry to burn over the area. Bucking-up is then carried on by one man as described. The bark on Douglas fir logs tends to dull the saw and is removed along the line of the saw cut.

Wedges are used to keep the saw from binding and kerosene is applied to the saw blade when necessary to free it from pitch.

The equipment used for felling and log-making in small- to medium-sized timber consists of a cross-cut saw from $5\frac{1}{2}$ to $6\frac{1}{2}$ feet long with two detachable handles; a double-bitted or single-bitted ax; two or more wooden or iron wedges; a measuring stick; a bottle of kerosene; and possibly a wooden maul or a sledge for driving wedges.

Similar equipment is used for large timber but the saws range in length from 8 to 18 feet. Spring boards also are required where high stumps are cut.

Power Bucking. — In the sugar pine forests of California, hand bucking is sometimes supplemented by the use of the power-driven steam dago.¹ The engine is moved under its own power to the vicinity of felled trees which are to be cut into logs. A saw frame and saw are adjusted at the cutting point on the bole, the saw is then started and left to work automatically while two other frames are being adjusted at other cuts. Saws are run at about 150 strokes per minute.

A swamping crew precedes the saw crew and trims the felled trees, throwing the brush to one side to give room for the machines. There is a decided economy both of time and labor in the use of the compressed-air machine. Nine men are required to operate it and the daily capacity is from 125,000 to 140,000 board feet, with a maximum output under favorable circum-

¹ See page 90.

stances of 160,000 feet. From fifteen to seventeen men would be required to secure the same output with hand labor, and the labor charge would considerably exceed the cost of operation and maintenance of the machine. Some difficulty is experienced in operating during cold weather because the moisture freezes on the cylinder and piston and interferes with the action of the latter.

An endless chain saw is used to cut logs into shingle-bolt lengths in the redwood forest region and also to cross-cut logs at the mill. It is especially adapted for the former work, where very large timber is to be cut into short lengths, because several cuts can be made at each set-up of the machine.

WASTE IN LOG-MAKING¹

Inefficient saw crews under improper supervision often cause a waste of timber by careless selection of log lengths.

Crook or Sweep. — Waste nearly always occurs in the division of a bole having crook or sweep. It is more serious in small than in large timber because the percentage of loss in slabbing at the mill is much greater. Pronounced sweeps should be cut from the bole and left in the woods and when it is not deep it should be left on the end of the log where there will be the minimum loss in manufacture. Logs with crook or sweep are more expensive to handle both in the forest and at the mill than straight logs of the same diameter and length because more time is required to skid, to load on to the log cars and to handle them in the mill. The actual yield of lumber is from 12 to 75 per cent less depending upon the per cent relation between the depth of sweep or crook and the diameter of the log.²

Forked Trees. — Another source of waste is the cutting up of forked trees. The chief faults of the sawyers in this regard are:

(1) Felling the tree so that the lower fork is either imbedded in the ground or so placed that it is difficult to saw it properly. The line of least resistance is followed and the lower fork is left or a portion of it sacrificed. (Fig. 22.)

¹ See *Prolonging the Cut of Southern Pine*, by H. H. Chapman and R. C. Bryant. Yale University Press, New Haven, Conn., 1913.

² See *Forest Mensuration*, by H. H. Chapman. John Wiley and Sons, Inc., New York, 1921.

(2) Cutting too far below the fork, thereby wasting merchantable material.

(3) Cutting too far above the crotch as shown in Fig. 22. The bole should have been cut close up on both sides of the crotch and the short section left in the woods.

It is unprofitable to bring logs with large forks to a mill because the yield of lumber from them is not in proportion to the cost



FIG. 22. — A Forked Tree cut in a Wasteful Manner.

of production. Forked logs require from two to fifteen times longer to get into the mill and to be sawed into lumber than do straight logs of the same diameter and length and the yield from them is often from 20 to 50 per cent less. A further loss is occasioned by the reduction of the mill output because of the additional time spent on sawing such logs.

Improper Trimming Lengths.— Insufficient attention is given to the lengths into which logs are cut. They should be a few inches longer than the implied log lengths because in bucking large logs it may be impracticable for the sawyers to cut exactly at right angles to the length and, further, logs often are damaged on the ends in skidding and in transit to the mill. This extra length is trimmed off in the mill and gives a straight, bright end on each board. Three inches are regarded as sufficient for a

log 16 inches and under in diameter and 4 inches for those of greater diameter.

Workmen become careless and often do not cut 50 per cent of the logs the proper length. Where less than 2 inches are left for trimming length, the board is usually reduced 2 feet in length at the mill, while on those that are several inches too long the loss is also great. Inaccuracy in measurements is due to careless measurement with the stick and to the use of one shortened by accidentally clipping off the end with the marker's ax.

The result of measuring 1000 logs on the skidway of a southern yellow pine operation showed that only 426 logs were of the proper length, while 240 were too short and 333 were from 1 to 11 inches too long. The excess on the ends of several logs was often sufficient to have secured an additional 2 feet of merchantable material had the bole been carefully divided.

Disregard of Quality. — Log-makers frequently do not give sufficient attention to securing quality as well as quantity. Where timber has large limbs the general practice is to leave the greater part of the tops in the woods because lumber of low grade only can be secured from them. Log-makers frequently exercise poor judgment in cutting trees into logs and often fail to apportion the bole so that the best portion and the knotty portion are kept in separate logs. It is not uncommon to find from 6 to 10 feet of clear bole put into a log with several linear feet of knotty material. This policy is costly because the value of the log is chiefly determined by its poorest section. The universal rule should be to divide the bole so that the clear material will be kept separate from the rough and defective. It may often prove more profitable to waste a few feet of rough log if by so doing the amount of high-grade lumber can be increased.

Waste. — One form of waste commonly observed is shown in Fig. 23. Log-makers seldom go above points where one or more large limbs project out on one side (see X). If the log is 15 or more inches in diameter and one side is free from knots, the cut should be extended 2 or 4 feet further up the tree, say to "Y", if that distance gives the proper log length. The lower side will yield clear lumber free from knots and cannot in any way depreciate the value of the log content, while the lumberman secures the additional material on the good half of the log which otherwise would be wasted. If necessary, the portion

containing the large knots can be cut off in the mill at the trimmer.

A loss usually occurs in cutting broken timber into logs by making the saw-cut too far below the break. Where the break is not square across it is often possible to obtain added material by cutting the log so as to include a portion of the broken end. This should always be done on large timber where the extra section that can be secured is at least equal to one-half the diameter of the log.

One of the most extensive wastes occurs in the tops when all of the merchantable material below the larger limbs has not been

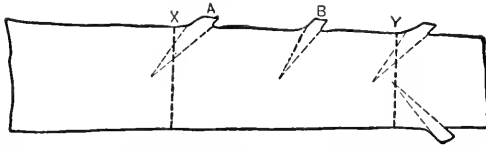

FIG. 23. — Waste in a Top resulting from an Improper Selection of Log Lengths.

utilized. Sections of good timber from one to several feet in length and of a quality equal to that taken are often left, because the log-makers did not exercise judgment in dividing the bole into the most economical log lengths. The loss from this source often runs from 3.5 to 5 per cent of the total merchantable stand and the annual loss on large operations amounts to thousands of dollars, although it could be corrected by proper supervision.

Close utilization of the kind mentioned does not require the operator to take material that he does not consider merchantable. A system by which timber is cut for quality as well as quantity means an increase in the percentage of the higher grades, more timber per acre and prolonged life to the operation.

BARKING OR ROSSING

When logs of large size are skidded on dry ground, the bark on the lower side is frequently removed to reduce friction. This is termed "barking" or "rossing." During a wet season or when power is used for skidding rossing frequently is omitted.

In the Northeast the ends of long logs that are being yarded on drag sleds are sometimes rossed on the under side when the road is either level or upgrade, or the dragging hard.

In other sections of the country only the largest logs are rossed. The work is generally done with an ax by a member of the swamping crew. On heavy timber the barker not only removes the bark but also straightens slight crooks by cutting off sufficient wood to flatten the log so that when dragged, it will remain in proper position.

Spruce logs intended for pulp manufacture are sometimes peeled in the forest because there is less wood wasted than when the work is done by machinery at the mill and the shipping weight is reduced by this means.

Redwood logs are rossed in the forest before the boles are made into logs because the thickness of the bark and its rough character not only impede log-making but are also a hindrance in transportation.

SNIPING

Previous to skidding, the forward end of a large log may be "sniped" or "nosed" that is, rounded off on the under side so that it will not catch on obstructions. Where the ground is rough and the log is likely to roll over, the entire front end is sniped. This work may be done by a sniper or by one of the swampers. The sniper generally prefers an ax with a 5- or 6-pound head.

BIBLIOGRAPHICAL NOTE TO CHAPTER VI

- BRANIFF, Edward A.: Grades and Amounts of Lumber Sawed from Yellow Poplar, Yellow Birch, Sugar Maple and Beech. Bul. No. 73, U. S. For. Ser., Washington, D. C., 1906, pp. 20-21.
- BRUCE, Donald: The Relative Cost of Making Logs from Small and Large Timber. Coll. of Agriculture, Agricultural Ex. Sta., Bul. 339, Berkeley, Cal., Jan. 1922.
- CARY, Austin: Practical Forestry on a Spruce Tract in Maine. Cir. 131, U. S. Forest Service.
- CHAPMAN, H. H., and BRYANT, R. C.: Prolonging the Cut of Southern Pine. Yale University Press, Bul. 2, Yale Forest School, New Haven, Conn., 1913.
- CLAPP, Earle H.: Conservative Logging. Report of the National Conservation Commission with accompanying papers, 1909, pp. 512-516.
- GIRARD, James W.: Inland Empire Sawing and Skidding Studies. The Timberman, Sept., 1920, pp. 36-38.
- GRAVES, Henry S.: Practical Forestry in the Adirondacks. Bul. No. 26, U. S. Div. of For., Washington, D. C., 1899, pp. 57-60.
- HEDGECOCK, George Grant: Studies upon some Chromogenic Fungi which

- discolor Wood. Missouri Botanical Garden, Seventeenth Annual Report, St. Louis, Mo., 1906, pp. 59-114.
- HOPKINS, A. D.: Practical Information on the Scolytid Beetles of North American Forests. I. Barkbeetles of the Genus *Dendroctonus*. Bul. No. 83, Part I, U. S. Bureau of Entomology, 1909.
- HOPKINS, A. D.: Insect Injuries to Forest Products. U. S. Department of Agriculture, Yearbook, 1904, pp. 381-398.
- HOPKINS, A. D. : Pinhole Injury to Girdled Cypress in the South Atlantic and Gulf States. Cir. 82, U. S. Bureau of Entomology, 1907.
- PETERS, J. Girvin: Waste in Logging Southern Yellow Pine. Yearbook of U. S. Department of Agriculture, 1905, pp. 483-494.
- VON SCHRENK, Hermann: The Bluing and Red Rot of the Western Yellow Pine with special reference to the Black Hills Forest Reserve. Bul. No. 36, U. S. Bureau of Plant Industry, 1903.

PART III
LAND TRANSPORT

CHAPTER VII

TRANSPORTATION

Transportation represents a large per cent of the total cost of delivering raw wood material at the mill or market,¹ hence it is the loggers' most important problem and the success or failure of the operation usually depends upon the manner in which it is solved. Differences in wages or efficiency of labor, character and size of timber (hardwoods or softwoods), the physical conditions under which the work is done and the topography of the region may cause some variation in log-making costs, yet on efficient operations the difference between the highest and lowest costs is relatively small. On the other hand, transportation expenditures in a given region may vary within wide limits because of the different topographic conditions under which the work is carried on and also because of inefficiency on the part of the management, due to the choice of unsuitable methods or improper application of suitable ones.

The correct solution of the transportation problems of the logging industry calls for great resourcefulness on the part of the logger and is made more difficult because of the pioneer conditions under which the work must be done. The tonnage may comprise logs or other products cut from trees ranging from small second-growth timber a few inches in diameter and yielding units weighing but a fraction of a ton to massive trees such as the Douglas fir and the redwood of the West Coast, single log units of which may weigh many tons; the topography may vary from a flat, swampy condition to a rugged mountainous one in which deep canyons and steep slopes are encountered; and the climatic conditions may range from the mild climate of the southern part of this country to that of the northern and eastern part of

¹ The transportation of forest products to mill or market represents 75 per cent or more of the total delivered cost of raw material, exclusive of the stumpage value.

the United States where the winters are long and cold and are accompanied by a heavy fall of snow.

The conditions under which logging is carried on vary so widely in the different forest regions of the country that loggers must specialize in the practice applicable to a given region. In the Northeast, he must be an expert on stream improvements and on sled transportation; in the South he must be familiar with the methods of moving medium-sized timber on swampy, flat, and rolling lands, and understand the use of power skidding machinery, and steam railroads; while in the Far West he must move heavy log units often under unfavorable topographic conditions.

The logger utilizes in his work almost every form of equipment which has been devised for moving materials among which are sleds, carts, wagons, railroads, aerial trams, slides, flumes, steam and electric skidders, tractors, power log loaders, steam and gasoline tugs, barges, and power log haulers.

There is no uniformity in the procedure followed in the selection of the transportation methods on logging operations. Many operators have not prepared a detailed preliminary plan of operation for their tract in advance of logging. The general methods in use in the region have been adopted as the standard and modified as conditions made such a step necessary. The applications of these methods to field conditions was left to the logging superintendent or foreman whose engineering ability was based chiefly on practical experience. This method proved satisfactory when a high degree of technical knowledge was not needed. The depletion of the accessible timber stands on favorable topography has forced loggers into regions, distant from markets, where the development of transportation requires a degree of engineering skill not possessed by the average foreman. It also has made it necessary to plan the operations for some years in advance in order that costly improvements may be located so that they will serve to bring out the maximum amount of timber. The greatest advance along these lines has been made in the Appalachian mountain region in which some of the largest operations are being carried on in a very mountainous section, and on the Pacific Coast where massive machinery is required for skidding and expensive railroad construction is necessary to move the heavy timber. A new branch of the engineering profession has grown up to meet the needs of the logger in these regions, especially in the

West, namely, logging engineering which calls into play a knowledge of the civil, mechanical and electrical phases of the profession especially adapted to the loggers' needs.

Transportation on a logging operation may be classified under two main heads, namely, secondary or short-distance, and primary or long-distance.

Secondary transportation. — This is used to bring the raw material from the stump to some central point or points from which it is taken by the primary transportation to the mill or market. It varies widely in character and the work may be done solely by manual labor, although animal draft or mechanical power is most frequently used. In general the choice of methods is based on some or all of the following factors:

(1) The size of the timber, the stand per acre, and the length of logs desired. Very large timber such as redwood and Douglas fir can best be handled by some form of mechanical power, owing to the great weight which must be moved, hence power skidding or yarding machinery is used.

Light stands of timber, unless the trees are of large size, can be logged cheaper by some form of animal draft than by mechanical power because the use of the latter usually necessitates the construction of an extensive mileage of logging railroad spurs, the unit cost of which is excessive when the stand per acre is low. Tractors have been introduced successfully on some operations in recent years as a substitute for animal draft in logging light stands. They have proved useful on long hauls and also on slopes, especially during the warm weather when steep ascending grades reduce the efficiency both of teamsters and animals.

(2) The character of bottom and undergrowth and degree of slope. When the bottom is smooth and free from underbrush, animals can be successfully used for moving small- to medium-sized timber, but animals are not satisfactory when the bottom is swampy or there is a heavy undergrowth present, because in the first case the animals mire badly, and in the second case an excessive amount of swamping is necessary in making trails and roads. Slopes in excess of 30 degrees are hard to log with animals because of the difficulty of controlling logs as they are yarded to the lower levels, and also due to the great exertion required on the part of the animal when it ascends the slopes on the return journey. Power skidding is more satisfactory under such conditions.

(3) The distance. Animal draft is used both for short and for long distances. The efficiency of this form of draft decreases rapidly with the distance hauled on level ground and on large operations it is seldom profitable to skid or yard logs for distances greater than from 600 to 800 feet. However, logs from scattered bodies of timber or light stands may be hauled for much greater distances on some form of wheeled vehicle when the volume of timber is so small that it is not profitable to bring the main transportation within a few hundred feet of it. In a rolling region, the profitable skidding or hauling distance for animals may be much increased because of the greater volume of timber which can be moved down grade at one time. In such cases logs may be dragged for distances of $3/4$ or 1 mile.

Ground power skidding methods are rarely adapted to distances greater than from 600 to 1000 feet, and overhead systems from 800 to 1500 feet. However, in very rough regions the latter type of equipment has been used for distances as great as from 3500 to 4500 feet. The choice between the two methods is based largely on the volume of timber to be moved, the size of the units to be handled, the character of bottom over which the timber must be carried, and the form of primary transportation available both for moving logs and skidding equipment.

(4) The form of primary transportation. Animal draft may be used with rail, motor truck or water transport but, in general, only two forms of power equipment have proved satisfactory when railroads are not available, namely, pullboat logging in cypress and tractor logging.¹ Logs skidded by pullboats are floated to destination while those logged by tractor may be floated or else hauled on motor trucks. The latter practice is followed in tractor logging only on relatively small operations.

(5) The annual or seasonal output. Some form of animal-draft is always used when the annual or seasonal output is small, because the investment in logging equipment is less and the animals may be diverted to other work when logging is not in progress. Power skidding machinery represents a large initial investment and the capacity of such machines is too great for small operations. Few power skidding machines can be operated

¹ In some cases in the Pacific Northwest, power skidding is used without rail transportation, the logs being dragged to water transportation by road engines.

profitably on a daily output which is less than 30,000 board feet per unit and some have an average daily capacity of 100,000 board feet or more. Hence, the daily output far exceeds the requirements of small mills, and during idle periods the carrying charges on the machinery are excessive.

(6) The forestry policy to be pursued. Power logging has been extensively introduced on large operations in many parts of the country, especially in the southern yellow pine, the Appalachian mountain, the Central Hardwood (chiefly in the Mississippi Valley section), the Inland Empire, California, and the Pacific Northwest regions. It has not gained any appreciable foothold in the Northeast and in the Lake States where there is a long winter season with a relatively heavy snowfall. The tendency in power logging in recent years has been to increase the amount of power in individual machines and the speed of the skidding lines in order to increase the output per unit and thus keep down the costs of logging which have a more or less constant tendency to rise with the advance in the cost of labor and supplies. All forms of power logging are more destructive to reproduction and seed trees than animal logging, and the ratio of destruction increases rapidly with the increase in the speed of the skidding lines. It is doubtful if skidding-line speeds in excess of 600 feet per minute are compatible with any form of forest management other than clear cutting. The so-called high-lead system used chiefly in the West has proved to be the most destructive because of the damage not only to the base but also to the tops of trees which may be left in the forest. The extent of damage by any system of power logging is directly proportional to the area covered by the runs since, on such areas, all volunteer growth and seed trees are destroyed.

All forms of animal logging have proved to be less destructive than power logging because the chief damage results only to those trees which are cut to make roads or trails over which to move the logs, and to the seedling growth which is on the right of way. Since swamping must be done by manual labor, the amount of timber cut is reduced to a minimum. Although an occasional seed tree may be scarred by contact with the wheels of skidding or hauling equipment, this damage usually is slight and the tree readily recovers. The damage to seedlings and saplings along the trails and roads often is more or less complete but such areas

are less in extent than the runs for power logging and, therefore, the total damage is reduced. Forest policy, therefore, has an influence on the choice of secondary transportation on areas where a sustained yield is sought.¹

Primary Transportation. — This includes the movement of the products from some central point or points in the forest to mill or market and represents one of the major costs incident to logging. Primary transportation may be on land or water or both, since forest products often are hauled for considerable distances on land and then floated or rafted to destination or to some point where they are again taken out of the water and moved on land to the mill or to market. Among the factors governing the choice of primary transportation are the following:

(1) The topography. Wheeled transport is not adapted to regions where the topography is very rough because steep adverse grades reduce to a minimum the size of loads which can be hauled and the cost of constructing a roadbed is high. In such cases flumes, aerial trams and slides may be used. On the other hand, a flat or rolling country with a solid bottom is well adapted to the use of some form of wheeled transport. A region with many streams and ample water storage reservoir sites is adapted to water transport while the reverse may be true of a flat or gently rolling country because of the sluggish character of the streams and the high cost of stream improvements necessary to confine logs to the channels at flood stage. Rough regions also are chiefly non-agricultural in character and a greater mileage of railroad usually must be constructed to tap outside existing transport systems than is necessary in flat or rolling regions which often are more densely populated and, therefore, have better existing transportation facilities.

(2) Climate. Temperature and precipitation often have a marked bearing on the form of transportation chosen. Heavy snowfall and low temperatures during the winter months are found in some regions where conifers are the more common forest trees. Such areas usually are well watered with streams of a size suitable for floating logs. Also in such forest regions rail transportation is seldom well developed and it may be necessary to move forest

¹ The Forest Service of the U. S. Dept. of Agriculture already has placed certain restrictions on power logging on some of the National Forests in the West.

products many miles to reach a suitable point for manufacture. Sled transportation to a stream down which the logs are floated is common in such regions, provided the temperature conditions are such that a snow or ice bottom can be relied upon for a period of from seventy to eighty days. This is the case in many parts of the Northeastern spruce region and in many parts of the Lake States. In the Inland Empire the amount of snowfall is adequate for sled-hauling but temperature conditions are so unstable that the logger cannot rely upon a continuous period of cold weather of sufficient length to enable him to place his logs on the landing. As a consequence, sled transportation is not used to the same extent that it is in other regions of equal or lesser snowfall. In the southern and far western forests some form of wheeled transport must be used to move the products from the forest, either for the entire distance or to some body of water on which the logs may be moved to destination. In the southern pineries, rail transport is in common use because the timber does not float well and trunk-line railroads can be reached with a comparatively short mileage of logging railroad. On the Pacific Coast a large volume of timber is hauled by rail to tidewater or to some large stream and then rafted and towed to the mills. The timber floats better than southern pine, but its large size and the long lengths in which it is cut in the forest make it impracticable to float the timber down the relatively small, short streams which drain the territory between the Cascade Mountains and the sea.

(3) Size, character and length of logs. Large-sized timber usually must be hauled on some form of wheeled transport, especially when cut near the headwaters of drainage systems, since the streams are too small to float logs of large dimensions. Pulpwood may be cut in lengths as short as 2 feet in order to move it down small streams, and stave and shingle bolts, and crossties often are floated down streams that are too small for saw logs. Very large logs cannot be moved successfully by animal power, hence some form of rail or motor truck transport usually is employed.

The weight of logs may be the factor determining the choice of land or water transport. The heavier hardwoods cannot be floated successfully for long distances and some form of land transport must be installed or the timber left standing.

The lengths in which it is desired to bring out logs may deter-

mine the choice because logs in excess of 32 feet in length usually can not be handled profitably by animal draft. An exception may be noted in the case of piles and other products, for which special facilities must be provided. Long logs usually can be handled best by some form of rail transport on which a long wheel base may be used to support the load.

(4) Character of skidding equipment. Heavy machinery and power logging equipment can best be moved by rail and in most parts of the country such form of transport is used. A logging railroad also furnishes a quick and efficient means of moving logs or other products to some point not tributary to the watershed on which the timber stands. Motor trucks may be successfully substituted for a railroad on small operations where both animal and power logging equipment is in use.

When logs are skidded by animal power, the choice of primary transportation may be a logging railroad if a large volume of timber is to be moved; wagons or carts for a small volume moved a comparatively short distance; sled hauling and water transport when climatic conditions and character of timber permit; and sled hauling with animal or tractor draft when water transport is not available or the logs will not float.

(5) Size of operation. Simple inexpensive equipment which can be used in the form of several independent units is the only type adapted to small capacity operations, since the volume of timber to be moved is limited and a heavy expense for equipment is not justified. On the other hand, operations which are to continue for many years and which move many millions of board feet of timber per year must have some form of transport on which reliance can be placed for steady and continuous delivery of large quantities of timber in a given time. The initial expense for transportation can be distributed over a long period of years and the unit costs kept at a reasonable figure. It is necessary to strike a balance between investment, operating charges and maintenance, because the logger with a limited output cannot incur heavier transportation costs than his larger competitors, if he is to be successful. The success of any system of primary transportation depends largely upon the skill displayed in analyzing the conditions found on any particular area and upon the efficiency of the supervising force in installing and operating the chosen system.

CHAPTER VIII

ANIMAL DRAFT POWER

For many years animals constituted the only draft power used in logging operations in the United States. They are still used extensively in the spruce region of the Northeast, the Appalachians, the yellow pine forests of the South, the Lake States, the Inland Empire and portions of California. In all of these regions machinery has replaced them for many purposes, yet animal logging is still extensively practiced.

Animals are now seldom used to move heavy timber, or for swamp logging or work on very rough ground and very steep slopes. Power-driven machinery has supplanted them in the redwood belt of California, the fir forests of the Northwest, the cypress swamps of the South and in some of the other rough mountainous portions of the United States.

They still remain the favorite form of draft when the timber is of medium size, where the stand per acre is less than 5000 board feet and when topography and bottom afford a good footing.

The chief uses for animals in logging are to transport timber and other forest products from the stump to a collecting point along a logging railroad, a landing on some stream or to a saw-mill. In addition they often supply the power for decking logs on skidways, and loading logs on sleds, wagons and log cars. Even when machinery is used for skidding logs, animals may be required to return the cable to the woods and to haul wood and water for the engines.

Oxen. — Oxen were the only animals owned by many of the pioneer lumbermen, and even after horses were available, loggers operating in remote sections found the ox more desirable because it could live on coarser feed, stand rougher treatment and required an inexpensive harness which could be made in camp.

Conditions have now changed, and the higher cost of labor and supplies has led many loggers to use either horses or mules

because they are more active than oxen. The latter are now used chiefly in the hardwood regions of the Appalachians and in the yellow pine region of the South, where they are frequently supplemented by horses or mules.

The following conditions are those under which oxen may be used to the best advantage:

(1) On swampy ground, because they do not mire as badly as the smaller-footed horse or mule.

(2) For skidding on brushy ground, as they require little swamping.

(3) On slopes, especially if the ground is rough and the underbrush abundant, because they are not excitable in difficult situations.

One advantage is that eight or ten animals can be handled by one teamster, while only four or five horses or mules can be worked by one man. Oxen stand heavy pulling day after day better than other draft animals and also require a minimum of attention because only one feed per day is necessary if the animals are turned out to graze at night.

They are slow on short hauls but they can be loaded more heavily and thus partially offset the greater speed of horses and mules, although they are not as serviceable as mules on hot, dusty roads because they suffer from continual exposure to the direct rays of the sun, and on very warm days, may be easily killed by over-exertion due to careless driving. They can be used in cold regions without danger. Under average conditions an ox will travel about 1 mile per hour when pulling a load.

Oxen are harnessed with a yoke. The driver controls them by the voice and by a heavy rawhide whip. They are worked in teams of from three to five yoke. In a team of five yoke, the front pair are called "leaders," the next two pairs are "in the swing," the fourth pair are "point cattle" and the rear pair are called "wheelers." The leaders are the best trained, while the wheelers are the heaviest yoke of the team.

The training begins when the animals reach the age of one and one-half or two years, but they do not attain their best development until their fifth or sixth year. They are serviceable, under average conditions, until they reach the age of ten or twelve years.

In the South oxen for logging purposes weigh from 1000 to

1200 pounds each and are generally purchased from farmers near the logging operation. They usually are light weight when purchased and require a year or more of proper feeding before they attain their average efficiency. Heavy or well trained animals may bring as high as \$200 per yoke.

Horses. — Horses are used in the Appalachians, southern pine region, Lake States, Inland Empire and the Northeast. They stand cold weather well, are active and are moderate eaters. They are best adapted for logging on smooth or rolling ground, and with good care will remain efficient for from four to seven years. Horses which have reached the age of fifteen years are seldom profitable on a logging operation.

Horses should not be used for logging purposes until they are from four to six years of age and when first put at work should be broken in gradually. In the South, new animals should not be put at hard work during the hot summer months, but should preferably be purchased in the fall and gradually broken in as the weather becomes cooler.

In northern Alabama, when well cared for, they are as satisfactory as mules, but farther south the climate is not so favorable for them. When improperly housed and fed they are less efficient than mules and oxen.

Horses for skidding purposes should weigh from 1200 to 1600 pounds each. Those weighing from 1200 to 1400 pounds are best adapted for handling small logs, and for rough conditions because they are more agile than heavier animals. Those weighing from 1400 to 1600 pounds are preferred for work in a flat or rolling region and for large logs. Weights ranging from 1500 to 1700 pounds usually are selected for wagon and two-sled hauling. Such animals are not sufficiently active for use on rough ground or steep slopes. The weights preferred for hauling skidder lines in the South range from 1000 to 1400 pounds.

The general type of horse preferred for logging purposes is one with high withers, and broad loins and chest, and should have legs which are free from all blemishes. Old scratches or other wounds are easily injured in working around brush or in mud or hard snow, and often the animal must be relieved from work. Large hoofs are an important factor in selecting horses for work in rocky places, since there is less liability of the foot slipping into holes between rocks.

Horses for logging purposes may be purchased from dealers who make a specialty of draft animals, or from farmers in the prairie regions.

Mules. — Mules are used more extensively in the South than in any other section.

The chief points of advantage are:

(1) They will stand more heat than an ox or a horse and are, therefore, better adapted for long or hard hauls during summer months or in a hot climate.

(2) They will stand rougher treatment and perform more labor on poor feed than a horse.

(3) They are less excitable than horses and, therefore, are well suited for use in operations where colored teamsters are employed.

(4) They are more agile than horses on rough ground.

(5) They eat less than horses and seldom overfeed.

Mules have not proved a success in the North where low temperatures prevail during the winter.

Under favorable conditions there is little difference in the amount of work performed daily by mules and horses.

Mules for logging purposes range in weight from 1100 pounds for leaders to 1400 pounds for wheelers. Southern loggers usually purchase their mules in the St. Louis and Kansas City markets or from farmers in Kansas and nearby states. The best mules are raised in Missouri, Kentucky and Kansas.

RATIONS

The rations given to animals vary greatly because of the difference in the character of feed available and the diversified opinions of feeders.

A draft animal at hard work requires a certain amount of concentrated food containing protein, carbohydrates and fats which is fed in the form of grains, such as corn, oats and barley; mill products, including corn meal, ground corn and oats, and similar combinations; and the by-products, cottonseed meal, cottonseed hulls and linseed meal. In addition, animals require rough material, such as hay of various kinds, corn fodder, corn husks and like feeds to give bulk to the ration. If no rough fodder or hay is given, an animal will consume more concentrated food than is necessary to keep it in working condition. On the

other hand, heavily-worked animals cannot subsist on roughage alone because the digestible nutrients are so small that they cannot consume a sufficient bulk to secure the proper amount of nourishment.

In preparing rations for animals, horses and mules require different treatment from oxen because they have smaller stomachs. As they have less power to digest foods, they must be fed less at one time and at more frequent intervals.

The degree of digestibility is dependent on two factors; namely, the length of time the food remains in the digestive tract, and on the fineness of the division of the food. Mastication is less in horses and mules than in oxen because the former must do all the chewing before the food is swallowed while ruminants, such as the ox, regurgitate their food and chew it at will.

Students of animal nutrition have prepared tables showing the amounts of the various constituents required for animals of a standard weight of 1000 pounds, performing a given kind of labor.¹ Other weights are in proportion. Such tables are known as feeding standards and are an approximate statement of the amounts of the different nutrients required by animals and may be used as a guide by feeders.

In general, a horse or a mule requires from 2.3 to 2.5 pounds of dry matter containing $1\frac{2}{3}$ pounds of digestible matter for each 100 pounds weight. Oxen require about 2.6 pounds of dry material, containing the same weight of digestible matter as required for horses and mules.

In calculating rations according to feeding tables, it is only essential that the quantities of carbohydrates and fats correspond approximately, because they both serve practically the same purpose and an excess of one may be offset by a deficiency of the other.

The test of the fitness of a ration for a draft animal is the ability of the animal to maintain an even weight. Generally, if a healthy animal loses weight, it is an indication of insufficient food, while an increase denotes an excessive ration. This does not refer to minor changes in weight from day to day but to changes observed over a period of several weeks.

Oats are generally preferred to corn for logging horses and mules, especially during hot weather, while cracked corn and

¹ The Wolff-Lehmann Feeding Standards are given in the Appendix.

cottonseed products often are an important part of an ox ration. Timothy hay is preferred for horses and mules, and "prairie" or wild hay for oxen.

The dry matter and digestible food ingredients for various classes of feeding stuffs are given in the Appendix¹ and by the use of this data and the feeding standards² a balanced ration may be prepared, or an existing unsatisfactory ration modified. Since grains and by-products like bran vary considerably in weight for a given volume of feed, the use of dry measure in determining quantities is not recommended.

Rations fed to horses and mules doing various classes of work, including logging are given in the Appendix.³ Those for logging animals show a rather wide variation and indicate the absence of reliable feeding standards.

Horses and mules should be fed three times daily giving about one-half of the ration at night. The morning and noon feed should consist largely of concentrated feeds, giving the bulk of the "roughage" at night. The practice of one or two feedings per day for horses and mules is not considered advisable, because it is a departure from the normal feeding habits of such animals and may induce stomach or intestinal disorders. Animals are inclined to over-eat when the interval between feeding periods is long. Oxen, however, may be fed once a day only and still keep in good condition, owing to their greater stomach capacity and their ability to regurgitate and later chew their food.

WATER REQUIREMENTS

The amount of water required by horses depends largely upon the season of the year, the temperature of the air, the character of the feed, the individual peculiarities of the horse and the amount and character of the work performed. The water requirements increase with a rise in temperature and with the amount of work performed since both factors induce perspiration.

Less water is required when concentrated or green succulent foods are fed than when the bulk of the ration consists of coarse fodder or of dry food. A horse under average conditions will drink from 50 to 65 pounds of water daily, while under heavy

¹ Page 526. ² Page 525. ³ Pages 528 and 259

work or during warm weather from 85 to 110 pounds will be consumed. Mules in Oklahoma, during hot summer weather, consumed 113 pounds of water daily with a minimum of 107 pounds and a maximum of 175.¹ The ration was composed of grain and hay.

Experiments conducted in the British Army showed that horses, when allowed to drink at will, consumed about one-fourth of their daily allowance in the morning, about three-eighths at noon and the remainder at night.

European experiments indicate that the time of drinking has no appreciable effect on the digestibility of the food. Animals may be watered either before or after feeding with equally good results, but it is desirable to always observe the same practice since some animals do not feed well if watered after feeding, when they are accustomed to being watered before. However, animals should not be watered when they are hot, since it may induce colic or other similar ailments.

BIBLIOGRAPHICAL NOTE TO CHAPTER VIII

ALLEN, E. W.: The feeding of Farm Animals. U. S. Dept. of Agriculture, Farmers' Bull. No. 22, Washington, 1901.

DALRYMPLE, DR. W. H.: Economic Feeding of Work Animals used in Logging Operations. Lumber Trade Journal, Nov. 1, 1914, pp. 27 and 28.

DALRYMPLE, DR. W. H.: Feeding Work Horses and Mules. Lumber Trade Journal, July 1, 1914, p. 15.

LANGWORTHY, C. F.: Principles of Horse Feeding. U. S. Dept. of Agriculture, Farmers' Bull. No. 170, Washington, 1903.

¹ See Principles of Horse Feeding, by C. F. Langworthy. Farmers' Bulletin, No. 170, U. S. Department of Agriculture.

CHAPTER IX

SKIDWAYS AND STORAGE SITES

The transport of timber from the stump to the manufacturing plant generally comprises two distinct operations.¹

(1) Assembling the logs at depots, called skidways or yards, usually near the point of felling. This is termed skidding or yarding, and may be accomplished by manual labor; by animal power with or without the use of vehicles; by power-driven machinery; or by log slides and chutes.

(2) The transport of the assembled logs to a stream or to the manufacturing plant. This is termed hauling and may be done with some form of cart, wagon, sled, railroad, flume, aerial tram, or log slide.

Skidding and hauling may be conducted simultaneously, as in the South and West where rail transport is used, or at different seasons, as in the spruce forests of New England where hauling is done on sleds.

LOG STORAGE IN THE FOREST

The character and location of the storage points depend on the manner in which the timber is to be hauled and on the topography.

For Sled Haul. — Skidways for sled haul are built along the main or secondary two-sled roads and are constructed in the following manner. A log called a head block, 12 or 14 feet long is placed parallel with the road and from 2 to 8 feet away from it. On top of the head block, two skids 10 or 12 inches in diameter are placed at right angles to the road the forward end resting in notches 3 or 4 inches deep which are cut into the head block. The skids are spaced about 8 feet apart for standard-length logs. When the skidway extends back for some distance from the road,

¹ On small operations the logs may be taken direct from the stump to the mill.

the skids are supported at intermediate points by blocks or logs. The rear ends of the skids are sunk into the ground so that logs may be dragged over them by the skidding team. Each skid is notched just over the head block, and in this notch a block is placed which prevents the logs from rolling off of the front of the skidway.

Another scheme for holding logs on the skids uses two poles about 10 feet long and 6 or 7 inches in diameter which are placed



FIG. 24. — Decking Logs with a Crosshaul, the Block being fastened at the Front End of the Skidway. New York.

upright between the head block and a pole which extends across the skidway from skid to skid and which rests in notches cut in the head block. This method makes it possible to deck the logs square in front and, therefore, more logs can be put on a given skidway. It is more difficult, however, to load sleds from such a skidway since the poles must be removed before loading begins, and the logs may roll down when the poles are cut away.

Skidways for long logs may have three or more skids, the number depending upon the length of timber being decked. Those for sled hauling should be placed on the same side of the stream as the timber which is being skidded and the road also should

have a slight down grade in order to facilitate starting the sleds.

Logs may be decked on level ground to a height of from 20 to 30 feet. They are elevated by means of the crosshaul, operated by animals. A "decking" crew may comprise four or five men and one team. The equipment comprises four cant hooks, two pole skids 6 inches in diameter and from 8 to 10 feet long, and a $\frac{3}{8}$ -inch crosshaul chain about 40 feet long with a grab hook on one end. The logs are brought to the rear of the skidway and are then rolled by a "tailer-in" to the base of the logs already decked. The end of the chain carrying the hook is then thrown over and under the center of the log to be decked, after which the hook is fastened to one of the decked logs just below the spot where it is desired to place the new log. The free end of the chain passes over the skidway and, if the pull is to be straight away, is attached to a hook on the double-tree. After adjusting the chain, skids are placed against the decked logs, and the team is started. Two "ground loaders" guide the log straight up the skids using cant hooks for this purpose. Logs with taper, crooks, large knots and similar defects seldom roll straight and the ground loaders must be on their guard continually. A "top-loader" who stands on top of the pile of logs directs the log to its place, frees the grab hook if necessary and also directs the teamster. The direction of pull may be modified to meet special conditions. For instance, instead of attaching the chain directly to the double-tree it may be passed through a block fastened to a tree directly behind the skidway. This enables the team to pull at right angles to the direction in which the log is traveling and is of especial advantage when brush, boggy ground or other obstacles prevent a straight-away pull. The chain may also be passed through a block and brought forward over the skidway so that the horses pull on the same side on which the logs are being decked.¹ This may be desirable where there is a bad bottom or other physical hindrances to the usual method of operating.

Decking also may be done with the skidding horse or team in the following manner. A block is rigged on a tree at the front of the skidway along the main road and another block on a tree along the skid road. The decking line passes through these blocks, one end being attached to the parbuckle, and the other

¹ See Fig. 24.

end serving as a point of attachment for the draft animal. The team brings the log to the rear of the skidway. The yardman places the parbuckle around the log and attaches the decking chain to it, and as the team returns for another log, the teamster hooks one prong of his skidding grab into a link of the chain and the log is pulled up the skids and upon the skidway. The chain is detached by the teamster who then proceeds on his way, the chain being again fixed in position by the yardman.

Large skidways can be filled most economically when they are built in tiers on slopes. The logs are then delivered above



FIG. 25. — Skidways along a Two-sled Road. Montana.

the skidway and rolled to the levels below. Large side hill skidways may contain from 100,000 to 500,000 feet log scale.

During hauling time skidways may be places of transfer from skidding to hauling equipment in which event they are known as "hot skidways."

When sleds are used for hauling, the skidways are located at convenient points along the logging roads which lead to a landing or storage yard on a stream down which the logs are to be floated. The sites for skidways should be selected by the logging foreman at the time the sled roads are laid out, and the routes of the latter

should be chosen with reference to good skidway sites as well as desirable grades. Provision should be made for a down-hill haul from the stump to the storage point. Skidding cannot be carried on profitably for long distances on level ground, consequently a flat country requires the greatest number of skidways. Large skidways are preferable because there is less snow to be shoveled off at loading time, and the construction and maintenance of a minimum mileage of road is required.

Landings. — Temporary storage grounds called landings may be made along the banks of driveable streams or on the edges



FIG. 26. — A Rough and Tumble Skidway at the End of a Trailing Log Slide. New York.

of lakes, when the logs are to be floated to the mill or to market. The logs may be brought to the landing on sleds, or by slides, flumes, or railways. The type of landing will depend upon the character of the stream and the number of logs to be handled. When the stream is small and the storage area limited, sled- and rail-hauled logs may be decked from 15 to 30 feet high in the stream bed parallel to the banks. If the banks are high the logs may be brought to the edge and rolled down into the stream bed in a more or less rough-and-tumble manner. The landings at the ends of slides and flumes are always of this character, since it is impracticable to deck logs brought down by such forms of transportation.

Logs placed on frozen streams or lakes usually are scattered over a wide area in order to save the labor of decking and to prevent the weight of the logs from breaking through the ice.

For Wagon Haul. — Skidways are seldom made for wagon hauling. The logs are bunched in the forest in a place accessible to the wagons and are loaded with the crosshaul and taken to a skidway along the railroad or direct to the mill.

For Railroad Haul. — These vary in character depending on whether the logs are loaded on cars by animals or by power.

Skidway sites for animal loading with the crosshaul should not be lower than the track because it is too difficult to handle



FIG. 27. — A Skidway or Loading Dock along a Logging Railroad in West Virginia. The logs in the structure are later loaded and hauled away.

the logs. A straight "get-away" of 40 feet should be provided on the side of the track opposite the skidway where the loading team can travel back and forth. An area several hundred feet in length along the track may be cleared for storage, especially if the stand of timber is heavy and hauling precedes rail transport by some weeks in which case the skidway can then be used but once. When hauling is simultaneous with rail transport, skidways are filled repeatedly and less storage space is required.

With animal loading it is essential that the logs be carefully decked parallel to the railroad track.¹ The skidways have two continuous rows of poles placed about 8 feet apart and ex-

¹ See Figs. 55 and 121.

tending at right angles to the track for a maximum distance of 100 feet. The logs usually are brought to the rear of the skidway and rolled toward the track, leaving a clearance of approximately 10 feet between the first log and the rail. Logs are seldom decked more than four high as it is more economical to place new skids than to spend time in decking.

A form of skidway for transferring logs from skidding devices to railroad cars is shown in Fig. 27. The skidway is built crib-fashion of merchantable logs which are loaded and hauled away when the job is completed. The skidway should be high enough so that the top of the load on the car does not come above the level of the skids, thus facilitating hand loading. The skidway is made long enough to permit several cars to be loaded at once.

Where power loaders are used, skidways often are merely areas along the track from which the brush and débris have been removed so that the teams can deliver the logs. In a flat region where plenty of space is available the logs are seldom decked. It is unnecessary to have logs arranged parallel to the track or placed on skids since the loader can pick them up readily at distances not exceeding 100 feet.¹ If there are steep slopes near the railroad, logs are often hauled to the edge and rolled down by gravity, forming a "rough and tumble" skidway. This provides a large storage area and reduces labor in handling the logs. Since power loaders can readily pick up logs several feet below the level of the track the logger can locate his railroad without reference to loading sites.²

Special landings or yards are not necessary on many operations where power skidders are used. Thus, power skidders having a loading device, load logs as they are brought to the railroad, and the only improvement necessary for loading is a cleared space around the machine which will enable the loaderman to manipulate the loading boom. Overhead and snaking systems often are of this character. When the logs are not loaded by the skidder, they are decked up in piles along the track parallel to the roadbed, no special base being prepared. Such a procedure is followed with some types of snaking and slack-rope skidders.

On the Pacific Coast logs formerly were loaded chiefly by means of the "gin-pole" which required the construction of a landing built along the railroad track on which the logs were placed

¹ See Fig. 105. ² See Figs. 26 and 102.

by the yarding or road engine. Such landings were relatively expensive to construct and in recent years the gin-pole method, and the landing have been superseded by some overhead loading device¹ which does not require a landing, and which is faster than the gin-pole method, also permitting some choice in the order in which logs are loaded on the cars.

¹ See page 367.

CHAPTER X

HAND LOGGING AND ANIMAL SNAKING

HAND LOGGING

The movement of logs by hand from the stump to a point where they can be reached by animals is commonly practiced in the Appalachian mountains and is known as "brutting." Trails are cleared down the steep slopes and the logs are rolled to a stream bed or flat where hand labor is replaced by animal labor. Hewed cross-ties frequently are made in rough mountain regions and dragged down the slopes to streams or to accessible points.

Hand logging also is practiced in the white cedar (*Chamaecyparis thyoides*) forests of the Coastal Plain region. The trees are felled, cut into sections and carried by men or carted on wheelbarrows over plank runs to a light tram road where they are loaded on small cars and pushed to a point available to a steam tram road.

Some operators in the cypress swamps of this region cut swaths, called "creeks," at half-mile intervals through the forests locating them with reference to the current when the swamp is flooded. These are made during a dry season and are cut from 50 to 150 feet wide according to the number of logs that are to be floated down them. The trees which have been girdled for about a year are felled and cut into logs during a dry period and left on the ground until flood waters cover the swamp to a depth of 5 or 6 feet. Negro laborers are then taken to the swamp in boats and they pole the logs, sometimes for a quarter of a mile, to the nearest "creek," down which they are floated to the rafting ground, where they are made into rafts, and then towed to a mill.

Hand logging was common on the Pacific Coast for many years before the industry reached its present development. The timber was felled on slopes close to tidewater or some driveable stream, the logs were rolled into the water, made into rafts and

sold to other loggers or manufacturers who transported them to market. Often the stumpage was not the property of the logger who cut it and the timber was sold at a price slightly above the cost of the labor expended upon it. The increase in the value of stumpage and the greater care given to timber properties by the owners has largely eliminated this class of loggers in the United States. In British Columbia hand logging is still practiced to a limited extent by virtue of "hand logger's" permits issued by the Provincial Government.

The introduction of modern machinery for logging has given a wider meaning on the Pacific Coast to the term "hand logging," and it is now applied to loggers who operate on a small scale with animals.

SNAKING WITH ANIMALS

The transportation of logs with animals without the use of vehicles is practiced in many parts of the country to take logs from the stump to a skidway, stream, railroad, chute or other form of transport.

It usually is a short-distance method and the logs are taken out over crude trails from which only such obstructions have been removed as are necessary to make snaking feasible. The usual distance for snaking on the level or on gentle slopes does not exceed 500 feet. However, logs may be dragged 1000 or more feet from the stump to the skidway, but such long distances are not considered advisable except where there is a steep downgrade, or where there is not enough timber to warrant the construction of a road nearer to it.

Horses and mules, singly or in teams, and oxen in single, double or triple yokes may be used for short-distance skidding. The number of animals is governed by the weight of the timber handled, the character of bottom and the grade of the skidding trail. In the spruce region of the Northeast, two animals are used to yard timber, when logs are cut in long lengths, while in northern New York single animals are preferred because the timber is cut into short lengths. The usual practice in other regions is to use two or more animals. Single animals have been tried for skidding small second-growth loblolly pine in the Coastal Plain Region, but because of the weight of the wood and the enervating climate the practice has not proved satisfactory.

Although the detailed methods followed in snaking vary in the different regions, the general procedure is about as follows. Swampers begin at each end of the skidway and cut out a main trail from 5 to 7 feet wide which runs to the back end of the strip to be logged. Brush, roots, and windfalls are removed and wet spots corduroyed. The swamper also cuts the limbs from the logs, snipes them on the forward end, if necessary, and cuts a "ride" on the bottom of the logs which are large or which may

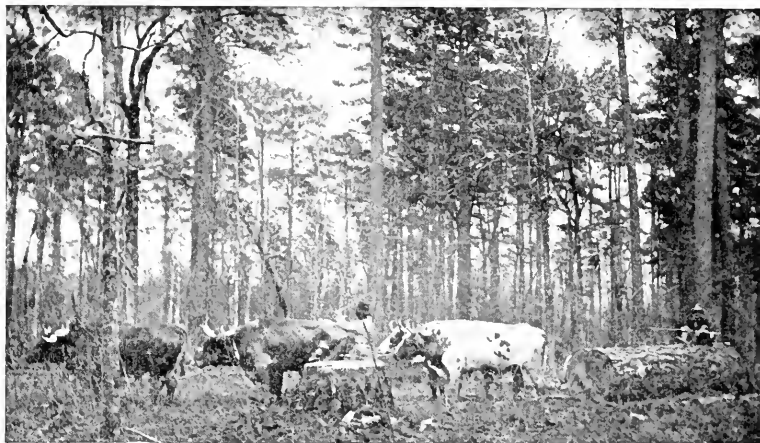

FIG. 28. — Oxen skidding a Southern Yellow Pine Log containing 1200 Board Feet. Arkansas.

have to be pulled up-grade. The teamsters draw the merchantable logs to the skidway, working back to the far end of the main road before logs nearby, but off from the main road, are dragged in. Branch trails are built out from the main ones so that logs from any part of the area have to be dragged only a few feet before reaching a cleared runway. It sometimes is necessary to use a block and tackle to get large logs out of difficult places, but this method is seldom used until all usual methods have failed.

Skidding for long distances is common in the rougher sections of the Appalachian mountains and in Pennsylvania where horses may be used to drag logs for distances not exceeding 1 mile. The logs are brought down trails which are sometimes so steep that the animals must be returned to the woods by a more circuitous route. The skidway is placed along the railroad in the valley and a trail is built from each end to the top of the

slope.¹ The trail is made 6 or 8 feet wide, cleared of obstructions and, when necessary, banked on the outer edge with skids to prevent logs from leaving it. Swamps are corduroyed, streams bridged and rough places covered with "skippers." These are timbers 8 or 10 inches in diameter and 12 feet long which are either placed zigzag across the road, the angle between skippers being about 60 degrees, or the poles are placed directly across the trail



FIG. 29. — Skidding Trails leading down to a Skidway along the Logging Railroad. West Virginia.

at intervals of from 4 to 6 feet. Logs drag over zigzag skippers more easily than over those placed directly across the trail. Rough chutes are sometimes built in the stream beds to cover rocks and other obstructions, when it is necessary to divert the trail from the slopes to the stream bed. Short-radius curves are undesirable because they decrease the draft power of the animals, and make it hard to keep a long turn of logs in the trail. Logs are brought down in "turns" made up of several logs fastened in single file. Eight men can build a mile of skidding trail in one day when there is only a limited amount of bridge and other timber work to do. On level stretches a two-pole

¹ See Fig. 29.

chute is sometimes built to facilitate dragging¹. They are occasionally used on gentle slopes if the bottom is rough.

On the Pacific Coast animal logging has been replaced by power skidders except for short hauls on some small operations. Skid roads formerly used for animal snaking in the Northwest were carefully located, stumps were removed, cuts and fills made and the roadbed leveled so that a desirable grade was secured. Skids



FIG. 30. — A Skipper Road on a West Virginia Operation.

10 feet long and from 10 to 14 inches in diameter were laid across the completed grade at 10-foot intervals, and were partly buried in the ground so that the horses could step over them easily. Wet places in the roadbed were covered with puncheons, split from western red cedar, to provide a footing for animals. A "saddle" was adzed out of the center of each skid and in this the log rode. On curves the skids were longer and were either elevated on the inner side of the curve to prevent the tow of logs from crowding into the bank or the skids were laid flat and the elevation was secured by placing small sloping skids on the inside of the curve. The latter was regarded as the better method since the small

¹ See page 264.

skids could be more easily placed and, if necessary, the angle of inclination could be readily changed. On level stretches the saddles were greased to reduce friction. Logs were fastened together by means of "grabs" into long tows, each one averaging 1000 board feet per horse. A team on a road of this character formerly comprised from eight to ten yokes of oxen but they were later replaced by horses, from four to fourteen animals constituting one team.

Drumming. — A primitive form of skidding, called "drumming," is sometimes used by small operators in the Appalachian mountains where the slopes are too steep for animal skidding, too rough for cheap road construction, and where the size of the operation does not warrant the use of power skidders.

A large drum, hung on a vertical axis, is placed close to the edge of the plateau. A long horizontal lever arm to which a team of mules is hitched is fastened to the barrel of the drum. A short, stout pole is fastened by one end to this lever arm and the other end drags on the ground in the rear, and acts as a brake when the drum is in operation. A manila cable from 1500 to 2000 feet long is attached to the drum underneath the draft pole and is carried down the slope by men and fastened to a log with grab hooks. The mules, attached to the draft pole, are started and, as the drum revolves, the cable is wound around it and the log gradually dragged up the slope. Logs are drawn over an escarpment, and other rough places in a chute made of logs. Trails are not cut out for the logs.

SNAKING EQUIPMENT

A strong leather harness for horses and mules, and suitable yokes for cattle are essential for snaking logs. Horses and mules when worked in teams require a set of double-trees or a spreader, and two single-trees.

Double-trees are preferred for flat ground and easy slopes, while spreaders, because of their lighter weight, are used on steep slopes, since they do not injure the horses by striking them on the fetlock joints or other parts of their hind legs.

For single animals a spreader only is required. When several teams are hitched one in front of the other a $\frac{1}{2}$ -inch draft chain is required to which each double-tree is fastened. The draft chains for oxen are attached to rings on the yokes. Various

devices, such as chokers, tongs and grabs, are used to attach the log to the draft chain.

Chokers. — A choker is a chain from 12 to 16 feet long made from $\frac{3}{8}$ -inch iron with or without a choker-hook on one end. When a choker-hook is used, the end carrying it is thrown around the forward part of a log to be skidded and the chain caught in the throat of the hook (Fig. 32a).

When the chain has no attachments, one end is thrown around the forward end of the log, looped around that part of the chain

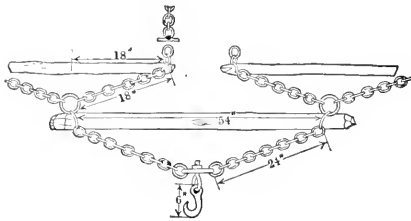

FIG. 31. — A Common Type of Spreader used in skidding on Slopes and Rough Ground.

which is to be attached to the draft, after which is it wrapped several times around the chain encircling the log. When power is applied to the draft end of the chain the noose around the log tightens and prevents it from slipping. The choker, which is readily adjustable to any size

of log, may be used for single logs, or several small logs may be bound together in a cluster with one chain.

The draft end of the chain may be attached by a hook to a ring in the yoke of the rear pair of oxen, or to a ring on the double-tree or spreader when other animals are used. If the chain is not supplied with a hook, the ring on the double-tree to which the chain is attached is made with a narrow throat in which a link of the chain is caught and held securely. The ring is often replaced by a grab hook in which the chain is caught. The two latter forms of attachment are preferred because the chain may be lengthened or shortened at will.

Tongs. — Tongs which may replace chokers for handling medium-sized logs are made from round or octagon steel $1\frac{1}{2}$ or $1\frac{1}{2}$ inches in diameter, and have a spread of from 24 to 36 inches (Fig. 32b). A $\frac{1}{2}$ -inch chain link is attached to each short arm of the tongs and these links are connected by a 5-inch steel ring which is caught in a hook attached to the double-tree. Sometimes a hook is attached to the ring on the skidding tongs, in which case the hook on the double-tree is replaced by a ring.

Grabs. — These are of several forms. The common skidding

grab (Fig. 32c), has two hooks each one of which is attached to a short $\frac{3}{8}$ -inch chain which in turn is fastened to a ring made of the same sized material. The hooks are driven into the wood on either side of the forward end of the log and grip it like a pair of tongs. The grab ring is attached directly to the spreader

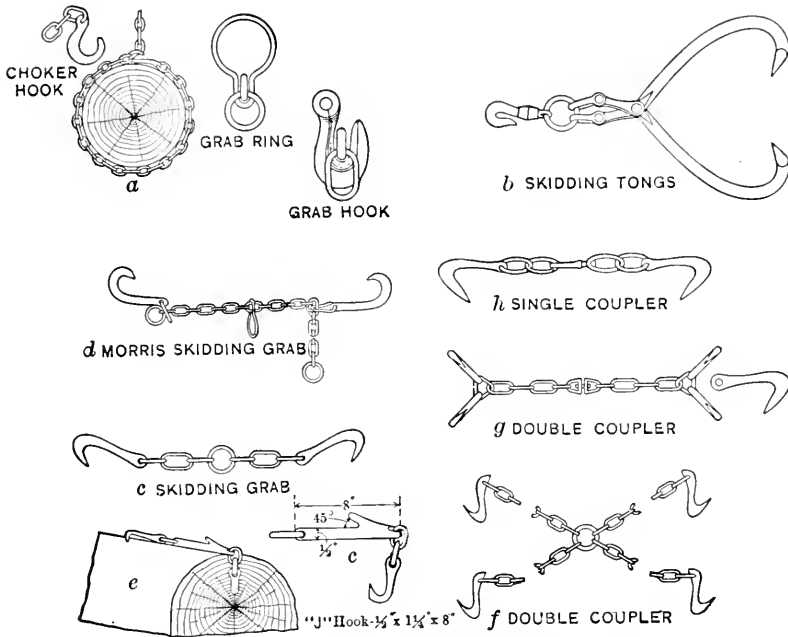

FIG. 32. — Various Forms of Equipment used in Snaking Logs. *a*, A chain choker. *b*, Skidding tongs. *c*, A common form of skidding grab. *d*, A patent skidding grab. *e*, The "J" hook used to attach the tow chain to a turn of logs. *f* and *g*, Two forms of double grabs or couplers. *h*, A single grab or coupler.

by means of a hook. The Morris patent skidding grab (Fig. 32*d*) has a chain with a large ring at each end. The grab hooks are attached to the chain by narrow-throated links which may be set at any point in order to make the distance between grabs conform to the size of the log. The draft power is attached to another narrow-throated ring which can be placed midway between the grabs and thus equalize the power. On steep slopes where logs are apt to run, a form of grab shown in Fig. 32*e* may be used. The spreader ring is attached to the "J" hook and when

logs gain too great headway and threaten to run into the horses, the latter may be turned to one side, whereupon the tow of logs



FIG. 33. — A Turn of Logs at the Dump along a Skipper Road. The logs are fastened together with "single coupler" grabs. West Virginia.

is uncoupled automatically. Grabs are also used to couple logs together in turns for transportation down skidding roads.

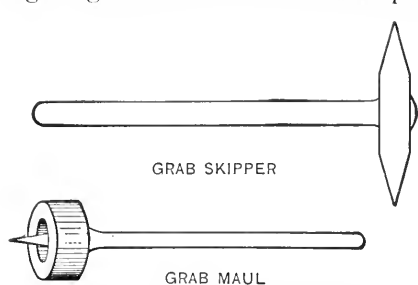

FIG. 34. — A Type of Grab Skipper and a Grab Maul used on a West Virginia Logging Operation.

There are several different patterns, including two forms of double grabs or couplers (Fig. 32*f* and *g*) used for the forward logs where the strain is greatest, and a single grab or coupler (Fig. 32*h*), for the rear logs.

A metal-banded wooden maul, a metal maul or a sledge hammer is used for driving grabs and a pointed sledge hammer, called a "skipper," for removing them.

CREWS AND DAILY OUTPUT

In the northern forests a crew usually has two or three teamsters, one or more swampers and one skidway man. One or more animals are driven by each teamster.

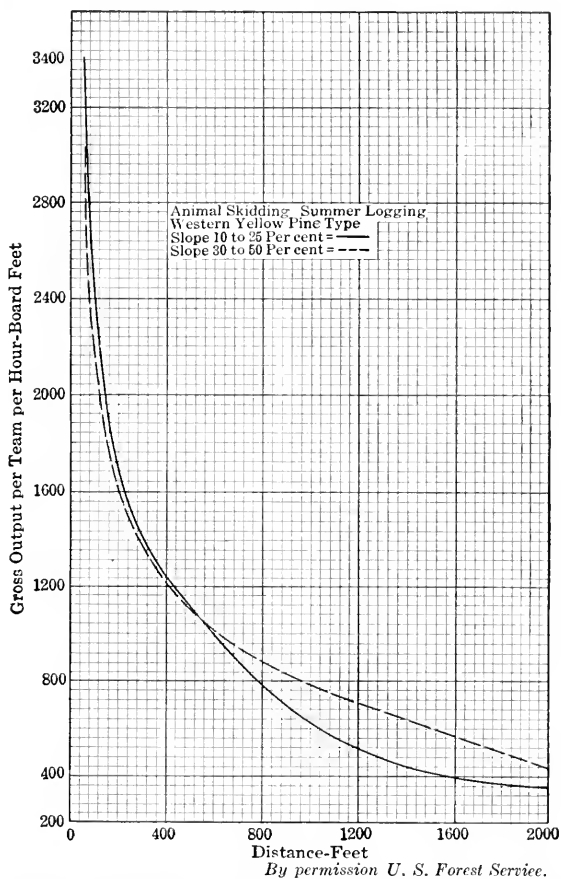

FIG. 35. — Graph showing the Influence of Slope on the Skidding Output, Animal Logging. Inland Empire.

In the open pine forests of the South where there is a minimum of trail building, one or more teamsters may work alone, doing their own swamping and skidway work. The usual practice, however, is to have a swamper prepare the logs.

In West Virginia a skidding crew often has two teamsters, one grab driver, one road monkey, and two skidway men. Each teamster drives two horses.

The daily amount of work, measured in thousand board feet, performed by a team depends on the size of logs, the length of haul, the character of bottom and the grade. The size of log is an important factor because small logs show a low log scale in

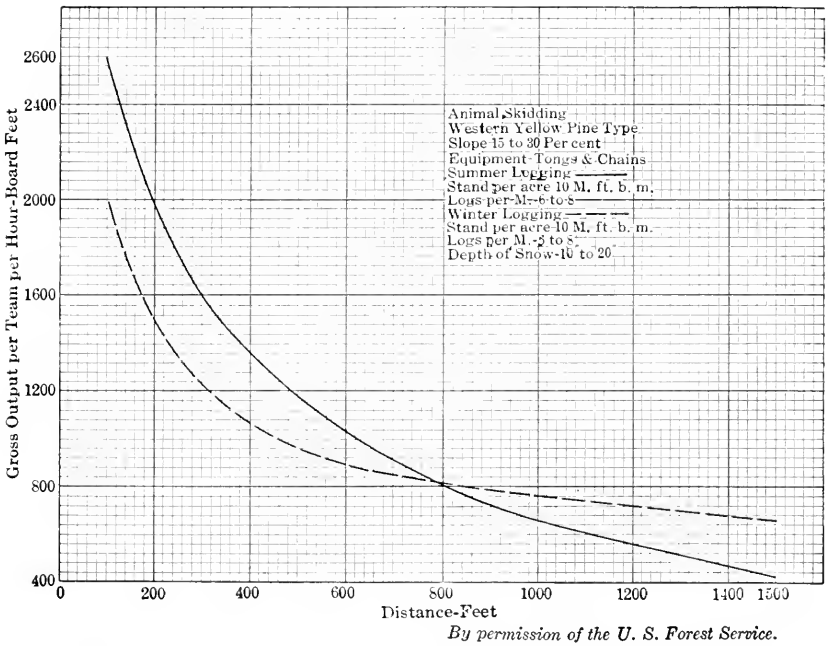

Fig. 36. — Graph showing the Influence on Skidding Output, Animal Logging, of Summer and Winter Conditions. Inland Empire.

comparison to their weight and while several may be skidded at one time, their total scale may be considerably below that of a single log that can be handled as readily and in less time.

The number of logs skidded in a given time is not in proportion to the distance. Animals when once in motion will consume less time traveling the second 100 feet than they did the first, provided the log is not so heavy as to require stops every few feet. The time saved on the shorter haul may be lost very easily at the skidway or at the stump. A soft or rough bottom or one covered with large roots, stumps and other obstructions is pro-

hibitive of speed and cuts down the daily output. Steep grades increase the number of logs and the volume which can be handled at one time for relatively long distances. This is shown in Fig. 35 in which a comparison is made of the gross output per hour for a horse team on slopes ranging from 10 to 25 per cent, and on slopes ranging from 30 to 50 per cent.¹ The graph indicates that the output per hour is greater on the gentler slopes for distances not exceeding 500 feet, and less for greater distances. This is due to the ability of the horses to traverse the distance from stump

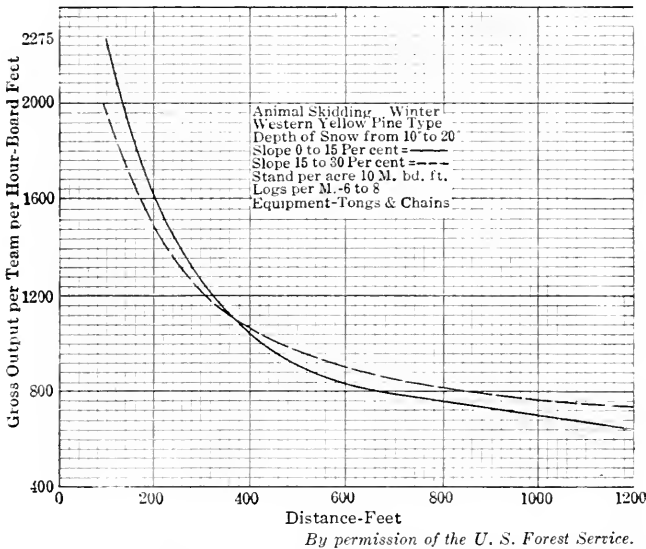

FIG. 37. — Graph showing the Effect of Slope on Skidding Output, Animal Logging, under Winter Conditions. Inland Empire.

to skidway on the more gentle slopes in a shorter time than on the steep slopes, and also to the tendency to skid maximum loads on steep slopes only for the longer distances. Teamsters are not inclined to make up maximum loads for short distances and on the operations at which these data were taken the average load for the gentler slopes exceeded those on the steep slope up to a distance of 500 feet.

The influence of the character of the bottom on the skidding output is shown in Fig. 36 for slopes ranging from 15 to 30 per

¹ From data contained in Inland Empire Sawing and Skidding Studies, by James W. Girard. Timberman, Sept. 1920, pp. 36 to 38.

cent. The graph indicates that the gross hour output on bare ground in summer is greater than on a snow bottom of from 10 to 20 inches for distances of a few hundred feet, while for long distances a snow bottom is more efficient. Undoubtedly this is due to the greater effort required to break out snow trails for the short distances and the tendency to take maximum loads only on the longer hauls.

The effect of gradient on the output when skidding is done on a snow bottom is shown in Fig. 37. This graph indicates that the gradient has less influence on output on snow bottom than on earth bottom, although the tendencies are similar. The greater efficiency on the steeper slopes begins at about the same distance as for summer logging, but on the long hauls the effect of grade on output is less with snow bottom than with earth bottom.¹

When skidding with two animals, either horses or mules, and handling timber that averages from six to nine logs per thousand board feet, a day's work, ten hours, ranges between 10,000 and 15,000 board feet for distances up to 500 feet. A daily average of 10,000 board feet during a month is considered good. For a distance of 750 feet the average ranges between 8000 and 12,000 board feet and for 1000 feet, from 3000 to 4500 board feet log scale. A two-yoke team of oxen will average approximately the same number of board feet per day as a pair of mules or horses.

BIBLIOGRAPHICAL NOTE TO CHAPTER X

GIRARD, James W.: *Inland Empire Sawing and Skidding Studies*. Timberman, Sept. 1920, pp. 36 to 38.

GRAINGER, M. A.: *Woodsmen of the West*. London, E. Arnold, 1908.

MARGOLIN, Louis: *The Hand Loggers of British Columbia*. *Forestry Quarterly*, Vol. IX, No. 4, pp. 562-567.

¹ See Fig. 35.

CHAPTER XI
SLEDS AND SLED-HAULING

THE GO-DEVIL

A sled known as a go-devil, travois or crotch is used in the eastern part of the United States during the summer and early fall and sometimes in the winter to supplement snaking.

The go-devil is made in the camp blacksmith shop and is

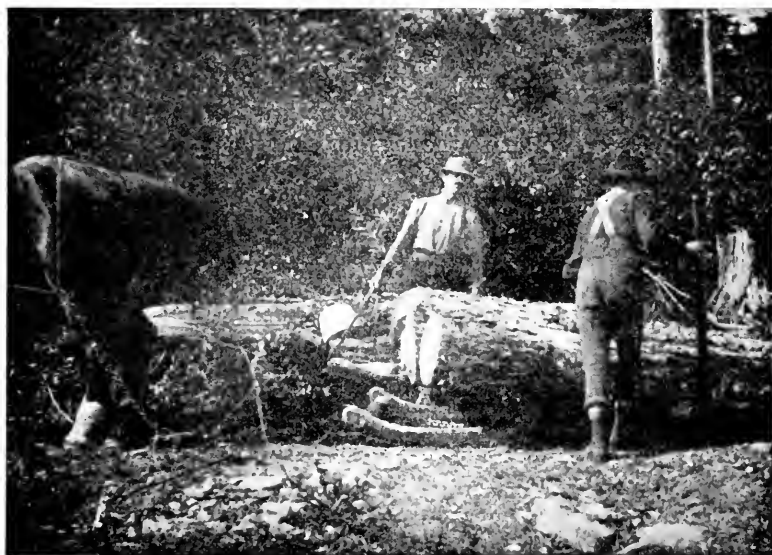

FIG. 38. — A Go-devil loaded with Hardwood Logs. Michigan.

a rough sled having two unshod hardwood runners, preferably of yellow birch, hard maple or beech, selected from timbers having a natural crook. The usual type of runner is from 6 to $7\frac{1}{2}$ feet long, 6 inches wide, and from 3 to 5 inches thick. A 6- by 6-inch by 4- or 5-foot bunk is fastened to each runner by a bolt. The bunk is placed from 2 to $2\frac{1}{2}$ feet from the rear end of

the runners. A ring is attached to the center of this bunk and the logs are bound on the latter by a chain passing around the logs and bunk and through the ring. The curved, forward ends of the runners are connected by a roller which has a short chain at each end that passes through a hole in the forward end of the runner and is fastened several inches back on it. Since the go-devil has no tongue it can be turned around in a small space. The draft rigging consists of chains fastened to either side of the bunk or to the runners. The chains are brought forward and joined directly in front of the roller by a ring to which the hook on the double-tree is attached. Go-devils are loosely constructed to permit a backward and forward play to the runners so that if one of them becomes obstructed the other moves ahead and starts it.

They are seldom used for distances less than 300 feet, except under adverse snaking conditions. They may be used for a $\frac{1}{4}$ -mile haul on snow but are not as economical as larger sleds for this distance. Trails are required and these are cut by the swampers as they prepare the logs for skidding.

THE LIZARD

A crude form of sled called a lizard is sometimes used in the pine forests of the South when the ground becomes too soft for wheels. They are not serviceable on very muddy ground because the nose digs too deeply into the soil.

The lizard is made from the natural fork of an oak, hewed flat on the upper and lower sides, with an upward sweep on the forward end so that it can slide over obstructions easily. About two-thirds of the distance from the front end the two prongs are spanned by a bunk bolted solidly to them. The draft chain is fastened to this bunk and also passes around the log and through a hole in the upturned nose. Lizards are made in the camp blacksmith shop.

YARDING SLEDS

It is often desirable to yard or skid logs for distances over $\frac{1}{4}$ -mile, especially when the amount of timber does not warrant the construction of a two-sled road, or the haul from the stump to the landing or to the railroad does not exceed $1\frac{1}{2}$ miles and the grade is favorable.

Snaking methods and go-devils are replaced in such cases by yarding sleds or drays in the Northeast and by a "jumbo dray" or a "bob" in the Lake States and the Adirondaek mountains.

The yarding sled is made by the camp blacksmith and has a pair of yellow birch or maple runners, 7 feet long, 3 inches wide shod with $\frac{3}{8}$ -inch steel shoes. The forward ends are curved upward. The runners are held together by a bunk 8



FIG. 39. — A Yarding Sled used in the Northeast.

inches square and 4 or 5 feet long, placed about 3 feet from the rear end of the sled. In order to facilitate handling the sled the bunk is made in two parts; namely, a lower stationary bar fastened securely to the runners by pins, called "starts," and braced by heavy iron straps or "raves," and an upper bar which is temporarily removed when the sled is turned around in the woods. The upper bunk has grooves cut on the ends or on the sides, and these grooves fit around the starts, which are mortised in the lower bunk and fastened to the runners.

Several logs with the forward ends supported on the bunk and the rear ends dragging on the ground can be hauled on a yarding sled.

Two $\frac{3}{8}$ -inch chains 18 or 20 feet long are used to fasten the logs

to the bunk of the sled. Each chain has a grab hook on one end and a bunk hook on the other. The use of chains in binding logs is shown in Fig. 40. A third chain is sometimes used to bind the rear end of the load.

Two horses are used for hauling yarding sleds, except on long hauls or unfavorable grades, when four may be required.¹

An average load is five large logs, or seven or eight small ones, the total averaging from 700 to 1000 board feet. Five thousand board feet is an average day's work for a team and sled on a $\frac{1}{2}$ -mile haul.

A system of re-yarding is sometimes followed on very steep slopes up which it is difficult to haul empty yarding sleds, and

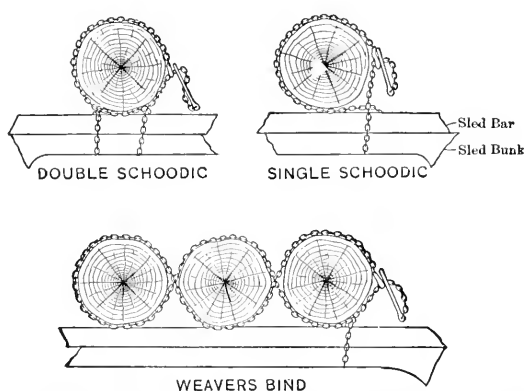

FIG. 40. — Methods of fastening Logs to the Bunk of a Yarding Sled.

down which it is difficult to control loaded ones. The logs are snaked to the foot of steep slopes and hauled to the main skidways or landings on yarding sleds. A skidding team is equipped with 150 feet of 1-inch manila rope to one end of which a grab hook is fastened. The logs are bunched by the team and several of them are bound together at one end with a chain and the draft rig attached to it. The hook on the rope is caught in the binding chain and given two or three turns around a nearby tree or stump, and the team started down hill. The teamster handles the snubbing line and controls the team by voice only. Horses soon learn that the snubbing line will hold back the load and they

¹ On steep down grades one horse is sometimes used because the trails can be made narrower and less swamping is necessary.

will go down a very steep grade without a driver. The advantages of this method, as compared to the use of yarding sleds, are that poorer roads may be used, less care has to be exercised in felling, difficult "chances" can be easily logged without a heavy strain on the horses, and the output per crew can be increased from 50 to 100 per cent over that possible when yarding sleds are used under similar conditions.

THE BOB

In the Lake States and in the Adirondacks a "bob" is used in the place of a yarding sled. It has the front runners of a "two-sled," equipped with chains for binding on the logs. It is adapted for hauls under $\frac{3}{4}$ mile when the distance is too great for snaking. From ten to sixteen logs may be hauled at one time on favorable grades.

THE "JUMBO"

The jumbo, a modification of the go-devil, is used on a snow haul in the Lake States, for distances not exceeding $\frac{1}{2}$ -mile, where the conditions do not warrant the use of heavy sleds. They are often used to haul timber out of swamps on roughly built, snow roads. When necessary the wettest places are corduroyed with hemlock or balsam brush. Jumbo sleds have the same loose jack-knife construction as go-devils. The runners, however, are 8 feet long and have a gauge of $6\frac{1}{2}$ or 7 feet. The forward and rear sleds are joined together by cross chains fastened to the bunks, which are spaced from 8 to 9 feet apart. The average load for a jumbo ranges from 1000 to 1200 board feet, from 5 to 20 logs being carried at one time. The sleds are loaded by means of a crosshaul. Roads must be cut out, stumps removed and swamps corduroyed, but the cost of road construction is much less than for two-sleds.

THE TWO-SLED

The transportation of logs from the skidway to a landing on streams, to a railroad or to a mill often is effected by means of a heavy sled called the "two-sled," "twin-sled" or "wagon-sled." There is no standard type of two-sled even in a given region. Many sleds are made in the blacksmith shop of the logging camp in accordance with the ideas of the logging foreman. The gauge of sleds varies from $3\frac{1}{2}$ feet on some operations in

Eastern Canada to 8 feet on others in the Lake States. The choice appears to rest on the size of loads to be hauled, the form of draft power used, and the preferences of the foreman in charge.

Wide-gauge sleds are used exclusively when some form of power draft is used, since the sleds are made larger and heavier in order to carry maximum loads. Many loggers also prefer a wide-



Photograph by E. B. Mason.

FIG. 41. — A Loaded Two-sled showing the Binding Chains and a Potter (on the left). New Hampshire.

gauge sled when animals are used for sled hauling because the animals then do not travel in the sled runner tracks and, therefore, do not deposit manure on it, a matter of great importance on an iced road, since manure will cause the ice to melt rapidly on bright days. More road-monkey work is required on a narrow-gauge sled road to keep the track clean, than on a wide gauge, since the manure must be shoveled off.

The length of runners varies from $8\frac{1}{2}$ to 12 feet and the width from 4 to 6 inches. Some runners are made square and others rectangular and they may be shod either with a rectangular-shaped steel shoe or with the more common type of semi-circular

one. Bunks range in length from 8 feet, on small sleds, to 16 feet on the widest gauge ones, although 10 feet is the average length in use in the Northeast and 12 feet in the Lake States.

A sled used on a Maine operation had runners $10\frac{1}{2}$ feet long, 4 inches broad, 7 inches high, which were shod with flat 4-inch steel shoes. The gauge was $5\frac{1}{2}$ feet. The runners were braced near the center by a transverse timber called a bar, which was fastened to them by a wrought-iron casting, called a "dexter" or "sled knee." A 10-foot bunk was placed over the bar on the rear runners and a 10-foot rocker on the bar of the forward sled. This rocker turned around a king-pin that passed through it and the bar. The forward runners also were strengthened by a flat roller rounded on the ends and fitted in circular holes in the sled noses. To this roller the sled tongue was mortised. When two teams were used for hauling a sled, a false tongue was slung on rings under the main pole, projecting ahead far enough to accommodate the forward pair of horses. This pole enabled the lead team to assist in steering the sled. The rear runners were similar to the forward pair, with the omission of the tongue and rocker. Two-sleds are made from well-seasoned oak, maple or birch. The woodwork on a sled lasts from three to four seasons but the runner shoes must be renewed annually or biennially.

The front and rear sleds are often joined by two $\frac{1}{2}$ - or $\frac{7}{8}$ -inch chains attached to the back side of the forward bunk, directly over the runners, then crossed and attached to the noses of the rear runners. The length of the chains is adjustable so as to adapt the distance between the forward and rear bunks to the length of logs being hauled. On rough roads, when light sleds are used, and when logs of medium and fairly uniform length are being hauled, the cross chains may be replaced by a "goose-neck," which is a V-shaped pair of thills. They have a hook on the apex by which they are attached to a ring on the back side of the forward bunk and the divergent ends of the goose-neck are fastened to the roller ends of the rear sled. The length of the goose-neck is from 16 to 18 feet, which gives a distance of 21 or 23 feet between the rear bunk and the forward rocker. When the empty sled is ready to return from the landing to the skidway, it is customary to unhook the goose-neck, turn it back on the rear pair of runners and couple the sleds closely together by means of cross chains.

SLED ROADS

Yarding Sled Roads. — Roads for yarding sleds are laid out by the camp foreman. Several main roads diverge from the skidways generally going up the slopes and, from these, branch roads are built directly to the logs.

Main roads are built 5 or 6 feet wide, stumps are cut level with the grade and all brush, fallen timber and boulders cleared away. The road is roughly graded, holes and depressions are filled with brush or dirt, streams are spanned with crib bridges, swamps are



FIG. 42. — Yarding-sled Trails leading down to a Skidway on a Two-sled Road. Maine.

corduroyed and, if necessary, cross-skids are placed across the road at intervals of from 10 to 20 feet to prevent the runners from cutting up the road. Side-skids also may be placed along the lower side of the road to prevent the sleds from leaving it. On side slopes, the outer edge of the road may be built up by laying skids parallel to the road and then placing short skids, 2 or 3 feet apart across them. This crowds the sled towards the bank.

Main yarding roads are built by a special road crew. The secondary roads are laid out and constructed by the swampers while preparing the logs for skidding. Easy grades are desirable both for main and secondary roads, but are not essential

because the speed of loaded sleds can be checked on steep pitches by a "snub-line"¹ or a "bridle."

A bridle is a chain passed around a runner in front of the bunk. It is put on and removed as circumstances demand. A clevis attached under the forward part of a runner sometimes replaces it. Bridles can only be used on smooth ground, otherwise the chains catch on roots and other obstructions and stop the sled. Tail chains, which bind together the rear end of the load, also act as impediments and assist in the control of the sleds. Aided by any of these devices, teams can go down slopes loaded, up which they cannot return with an empty sled.²

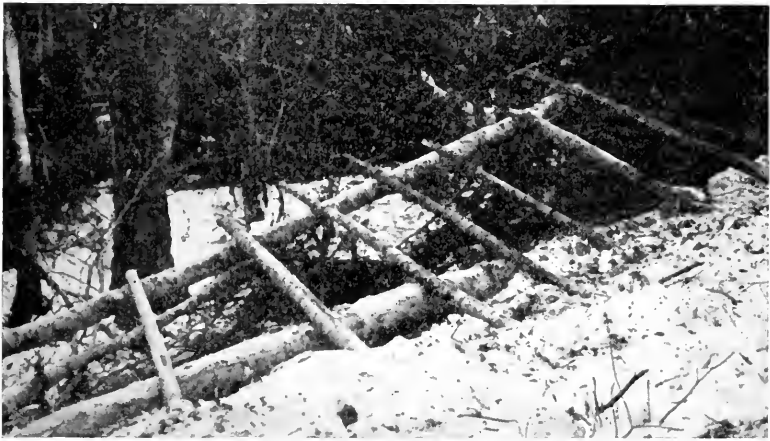

FIG. 43. — A Yarding-sled Road built up on a Curve to prevent the Sleds from leaving the Road. Maine.

Two-sled Roads. — The road system for an operation on which the logs are to be transported on two-sleds, comprises a main road over which all the traffic passes to the landing, and secondary roads which radiate from it to the skidways. The roads are laid out by the camp foreman often without the aid of surveying instruments, although in recent years, progressive woodsmen have adopted a hand level for the determination of grades.

The main road location is the more important because it is the route over which fully loaded sleds pass. These roads often

¹ See Fig. 4S.

² The general scheme of roads is shown in Fig. 42.

follow the valley of some stream from the woods operation to the landing, crossing and re-crossing the water-course as often as necessary to maintain the desired grade. A minimum number of bridges is desirable because they are expensive to construct and to maintain. In order that logs can be hauled on a down grade from the secondary roads to the main road, the latter should be located on the lower levels of the tract.

A main road of easy descending grades is preferred because on grades in excess of 5 per cent, heavy loads gain too much headway and it is necessary to place hay, straw, gravel, sand or brush on the road to check the speed. It is more satisfactory and often cheaper in the end to make cuts or to detour ascending grades rather than to return by them.

Dead-level pulls should be avoided because more power is required to move loads on such places than on gently descending grades. Sharp curves are especially dangerous at the foot of steep pitches because the load cannot be held in check by the animals and the sled is apt to leave the road under the momentum attained.

Turnouts are provided at the end of long, straight stretches on low-grade roads, while on steep mountain roads a "go-back" road is built over which the empty sleds return.

Secondary roads are inferior in construction to the main ones because they may be used for one season only, and a small amount of timber is brought out over them. They are seldom iced and, therefore, the bottom does not have to be made as smooth as for rut roads.

Fewer roads can be used in a rough or rolling region than in a flat country because the downgrade permits skidding for longer distances.

Two-sled roads should be built during the summer or early fall before the ground freezes and snow falls. The days are then long and the unfrozen earth can be handled to best advantage. On new operations, road work follows camp construction, while on other operations the roadmen come in a short time in advance of the regular camp crew, or simultaneous with it. It often is necessary, however, to construct a tote road, from the base of supplies to the camp site, previous to the construction of the camp. Roadmen are chosen from the less efficient workers in camp, because in such work little skill is required.

The right-of-way having been blazed out by the camp foreman, the "road-monkeys," as the men are called, proceed to fell a strip of timber from 20 to 30 feet wide along the proposed route. The merchantable timber is cut into saw logs which may be left at one side of the road, or skidded to the nearest skidway site. If the road is to have a snow bottom, the depressions are filled with rotten logs and sound non-merchantable species. The latter are also used for corduroy, bridge construction and skids. Large stumps are sawed level with the ground; boulders are removed or the road level around them raised by skids; and



FIG. 44. — A Two-sled Road, showing the Method of building up the Grade on Slide Slopes.

cuts are made to reduce heavy grades. Snow roads often present a rough appearance before snow falls, because of the uneven nature of the roadbed, but the first heavy snow fills the depressions and smoothes off the road making a solid bed over which the sleds may pass.

Swamps containing live springs are a source of annoyance when the road must pass over them, because they are the last part of the road to freeze over in the fall and the first part to thaw in the early spring, and should be avoided when practicable. When the road crosses low marshy ground or swamps, corduroy is used which gives a broad bearing surface to the road and prevents

the sled runners from sinking into the mud. An average day's work for one man is to cut poles for and build from 6 to 8 rods of corduroy.

When roads are built on side slopes, the upper side is cut down and the lower side raised, by laying long skids parallel to the outer edge of the road and placing short transverse skids on them. The space between the skids may be filled with brush, or left vacant and snow allowed to fill the interstices. On roads where the traffic is heavy the slope is either cut down enough to make a solid roadway, or else an abutment of logs is built on the low side.

Roads which are to be iced must be more carefully graded than snow roads because a solid base is required to support the ice coating, otherwise it will break up under heavy loads. Stumps, rocks, and other obstructions in the line of ruts, also interfere with the operation of the rut cutter. An iced road, therefore, must be carefully graded, stumps grubbed or blasted, rocks removed and low spots filled with earth. The appearance of the roadbed previous to the fall of snow should be comparatively smooth. The additional cost of the roadbed for an iced road as compared to a snow road may be 100 per cent or more. However they are more efficient on long hauls since heavier loads can be moved than on snow roads. Two general types of iced roads are used, namely, the rut road and the trough road. The former represents the earliest type of iced road used in the United States, and it was probably first developed in the Lake States. On the early roads the ruts were cut with an ax, but this method was soon abandoned since a rut cutter¹ makes a smoother channel and the cost of the road is less.

The advantages of a rut road over a snow road is that the frictional resistance is reduced and the rut serves to hold the sled in place on the road, thus preventing the runners from sluing. Rut roads require more attention for maintenance than snow roads because they must be kept free from manure; sprinkled at frequent intervals, often daily; and the ruts may have to be cut out two or more times per week. In the Lake States ruts often are cut in the soil, which gives a solid bed. It cannot be done successfully in stony soil, however, so that in many regions the ruts are cut in the snow and later built up with ice. The first

¹ See Fig. 46.

mentioned practice gives the best results, since the ruts will stand up under heavier loads. Ruts are cut from 3 to 6 inches deep and are made somewhat wider than the thickness of the runner. The bottom of the rut may be square or concave depending on the shape of the runner shoe. The trough road has a smooth ice bottom with sloping ice wings. It is built up to a depth of several inches by frequent applications of water and it is then sheared off with a steel snow plow which gives a level ice bottom without ruts. The advantages claimed for this type of road are that it provides easier draft on short hauls, and that the solid ice bed makes a more permanent road during the warm winter weather which may occur near the close of the hauling season. These merits are not conceded by all loggers, however. Trough roads usually are made for a gauge of 6 feet or less. This necessitates the use of a narrow-gauge sled, with overhanging bunks which are more troublesome at landings than those on broader gauge sleds. Further disadvantages of the trough road are that the horses travel on ice and in the runner track, which necessitates the constant removal of manure; the road, unless plowed frequently, is built up and then tends to break down on the sides under heavy loads; much more water is required than for rut roads; more labor is required for maintenance; and on long hauls the capacity is no greater than for a rut road.

Streams and dry watercourses are bridged with structures made from round timbers. Bridges are the first part of a sled road to weaken. They should be built on a slight downgrade, if possible, in order to facilitate the passage of loaded sleds. The usual type is one the floor of which is supported on parallel stringers, from 12 to 15 inches in diameter resting on abutments and piers which are made of logs from 12 to 18 inches in diameter, built in crib-fashion. The piers are 10 or 12 feet square and are commonly placed from 12 to 16 feet apart, and filled with stone to give them stability. The floor is made of skids from 6 to 10 inches in diameter, placed across the stringers close enough to form a solid roadbed, and on these a thick covering of bark is spread to hold the snow, and prevent the sled track from breaking up when the load passes over it. The skids are held in place by stringers which are laid on top of them, one on each side of the bridge.

Piers are not adapted to use in a stream bed, because freshets

are apt to carry them away. Under such circumstances or where the bridge crosses a wide stream the cribs are placed from 20 to 25 feet apart and the stringers are supported between them by piles driven to bed rock at intervals of 8 or 10 feet.

When the stream is too wide for a single span, the cribs may be built in the water, heavily loaded with stone and provided with a "rake" on the up-stream face to divert refuse and ice to

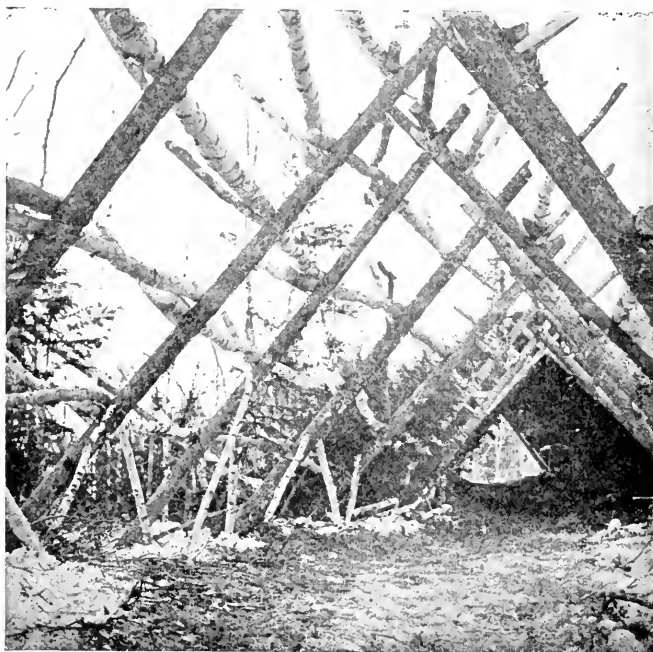

Photograph by D. N. Rogers.

FIG. 45. — A Snow Shed on a Two-sled Road. Coniferous brush is placed against the framework to prevent the entrance of snow. Maine.

either side of the crib. When there are long spans it is customary to use five stringers. Deep depressions often are filled with cribbing built up to grade level.

On roads where the snow drifts badly snowsheds are occasionally built in order to keep the road open with a minimum of hand shoveling. They also are used on steep pitches to keep the ground free from snow, so that the speed of sleds can be controlled. Snowsheds are built in several different forms one

of which is shown in Fig. 45. The framework is constructed of poles 6 or 8 inches in diameter and heavy brush is placed on the sides and roof to prevent the entrance of snow. The height and width of the sheds is dependent on the size of the sleds and the maximum height of loads hauled.

Screens built from tops and limbs sometimes are placed along the windward side of a road to protect it against drifting snow. A fringe of trees also may be left along exposed portions of the road, this timber being cut during the last season the road is used.

Two-sled snow roads require at least from 8 to 12 inches of snow for successful operation and in the Lake States and the Northeast conditions are seldom favorable for their use until the middle or latter part of December. Hauling begins at this time and continues without interruption until all of the logs are on the landing, or until the season breaks up and the snow leaves the roads.

Snowplows play an important part in the maintenance of a main two-sled road. They are frequently made by the camp blacksmith, but also are sold by dealers in logging supplies.

Plows are used after each snowfall to clear a right-of-way along the road wide enough to permit loaded sleds to pass. They are built in several patterns, a common one having V-shaped flaring sides from 2 to 4 feet high, which are bolted to a heavy pair of runners. The plow is drawn by from six to sixteen horses, depending on the depth of snow and the width of road being cleared. Plows also are made from two split logs or heavy sawed timbers about 16 feet long which are joined together at the apex of the triangle by means of a chain which passes through holes in the forward end of the logs at which point the draft power is attached. The angle between the sides may be regulated by means of cross bars, which are fitted into notches cut into the inner face of the logs or timbers. Such snowplows are made reversible in order to facilitate a change in the direction of travel. The chain holding together the forward ends of the logs at the apex of the triangle is removed, the rear ends of the logs are then brought together and fastened with the chain, and the point of draft attachment is then reversed. This scheme is especially useful since it often is difficult to turn around such a snow plow, owing to its unwieldy character. Special care is necessary when roads cross lakes or

ponds that have become covered with a blanket of snow before the ice has reached a thickness to hold up heavy loads. It is the custom to plow the snow from the ice for a distance of 40 or 50 feet on either side of the main road and to keep the ice uncovered until it has reached a satisfactory depth. If this is not done the road may remain in a dangerous condition throughout the winter.

The maintenance of iced roads requires rut cutters and sprinklers, in addition to snow plows. The rutter is a machine mounted on a heavy set of runners which has two chisel-like cutting blades, either flat or concave, which may be raised or lowered so that a

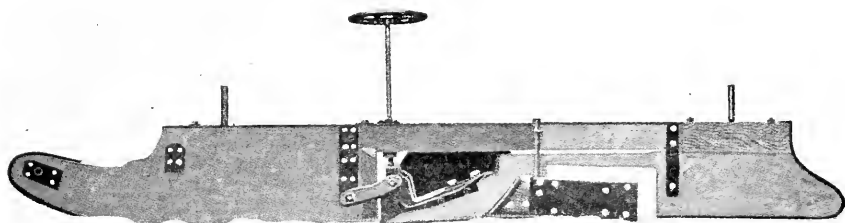

FIG. 46. — The Badger Rut Cutter (side view).

rut of any desired depth can be secured. Snowplows and rut cutters often are combined in one machine especially in those patterns offered by logging supply houses.

Long hauls, ascending grades and long, level stretches are iced so that larger loads can be hauled. A road on which four or more trips can be made daily is seldom iced unless a large amount of timber is to be hauled over it. Descending grades and secondary roads are not iced.

The sprinkler is a rectangular tank built of dressed and matched plank, and mounted on a heavy pair of sleds. It holds from 30 to 80 barrels of water, which will sprinkle from $\frac{1}{4}$ to $\frac{3}{4}$ of a mile of road. In one type a short piece of 1-inch iron pipe is fitted into each of the rear lower corners of the tank directly over the sled ruts. An overhanging piece of sheet iron is attached so that it hangs over the opening in the pipes and, when the wooden plugs are pulled out of the latter, the water plays on this sheet and throws a spray over the rut, which on freezing makes a solid ice coating. Another type of sprinkler has the openings in the

bottom of the tank in front of the rear sled runners. This is considered a better method since the runner tends to shape the rut and prevents water from collecting in low spots and filling up the ruts with solid ice. A scheme tried some twenty years ago as a substitute for the sprinkler, was a steam boiler mounted on a sled, with pipes which discharged steam in the runners, thus melting the snow and ice which on freezing would coat the rut with ice. So far as known this system was not adopted, although it was tried out both in the Lake States and in the Northeast. A water heater, a round wrought steel tube 18 inches in diameter equipped with a smoke and a fire door, is sometimes placed in the tank. A fire built in it prevents the water from freezing. Sprinklers may be filled by gravity from a spring or brook, by water drawn up in a barrel by means of a cable and horse draft, or by a steam pump.

The rutting and sprinkling are done by a special crew who usually operate at night and whose sole duty is to keep the road in shape for hauling. Under ordinary circumstances, in addition to such men as are required continually at points where grades must be sanded, or snubbing devices operated, one man can keep 2 miles of main road in repair. One four-horse team and two men can operate the sprinkler on from 4 to 6 miles of road. Shoveling out deep drifts after storms; banking and skidding up roads on side hills, where the sleds slue to one side; keeping a snow covering on bridges; shaping ruts on iced roads by cutting them out with an ax; filling in low spots on the road with snow, brush or other material; and shoveling manure off of the iced roads may be necessary to maintain a two-sled road.

After one season's work a road requires a general overhauling to prepare it for the next winter's use. This work is done early in the fall at the time road building begins. Bridges are strengthened when necessary, the roadbed built up on slopes where weaknesses have become apparent, sags occasioned by the last winter's haul are filled, and any general improvements made that the previous season's work have shown to be advisable, such as the elimination of undesirable curves and grades.

Operation. — The practice followed in preparing a main two-sled road for hauling varies on different operations. Preparation of a snow road often begins two or three weeks previous to hauling, when a crew goes over the road filling in soft places and cut-

ting out windfalls which may have dropped across the road. A forward pair of two-sled runners is then loaded with two small logs whose rear ends are allowed to drag on the road where the horses travel. Several loads of this character are hauled to the landing, followed by heavier loads again dragged on the same sled. When the road is thoroughly packed, a few light two-sled loads are hauled over the road after each snowfall.

Previous to hauling, the roads past the skidways are broken out by a snowplow and if necessary by shoveling. Then an empty or lightly loaded sled is drawn over the road to break a track. The snow on the skidways is shoveled off and the empty sleds drawn by two or four horses are ranged alongside for loading. Logs are sometimes frozen so solidly that they cannot be loosened by hand and a small charge of dynamite must be exploded in the pile. On steep mountain roads it is customary to place partial loads on the sleds at the upper skidways and "top-out" the loads from skidways on the lower levels.

Sleds may be loaded by hand, by the crosshaul or by power loaders. Hand loading is used where the logs are not large. It is a common method in the spruce forests of the Northeast. Two skids are placed so that they span the interval between the cribwork of the skidway and the sled bunks and the logs are rolled over the skids by the loaders. As the load is built up, the skids are raised and placed on top of each succeeding tier of logs. Large logs are loaded with a team and crosshaul unless the skidways are higher than the sled bunks.

Horse loaders or "jammers" are frequently used in the Lake States. These have a derrick and swinging boom mounted on a heavy sled, equipped with hoisting blocks and tackle. The jammer is drawn from one skidway to another by a team, and is placed directly behind the sleds to be loaded with the boom so placed that logs may be gripped on the skidway with tackle, elevated and transferred to the sleds. Power for hoisting is furnished by the team which transports the jammer.

Power loaders are occasionally used in the Lake States. They are mounted on sleds and have a stiff boom and a hoisting engine driven either by steam or gasoline. They are transported from one skidway to another by animals.

Logs are bound on the sleds by chains. For high loads, operators use a set of ten chains. Four $\frac{1}{2}$ -inch short bunk or corner

bind chains are used to bind the two outer logs of the bottom tier to the rear bunk and the rocker. Four $\frac{3}{8}$ -inch "deck chains" are used to bind the load, one pair being used to hold the load after the second tier of logs has been put on, and the other pair, after the fourth tier has been loaded. Each deck chain has two parts, one part being 24 feet long with one end fastened to a ring on one side of the rocker or bunk, and the other part being 2 feet in length and attached to the rocker or bunk on the end opposite the long chain. The short chain has a ring on the end and a secondary chain with a grab hook attached is fastened to



Photograph by H. De Forest.

FIG. 47. — A Sprinkler being filled with Water from a Brook. Adirondacks.

it. Two $\frac{3}{8}$ -inch wrapper chains each about 40 feet long, which have a ring or bunk hook on one end and a grab hook on the other, are passed around the completed load, but are not attached to the sled.

When large loads are hauled, a "potter" is sometimes used as an aid in loading. This is a round stick 3 or 4 inches in diameter and $2\frac{1}{2}$ or 3 feet long, around the center of which is fitted an iron clasp to which is fastened a short piece of chain with a hook on the free end. When two pairs of deck chains are used, eight potters may be employed, four on each side of the load. After the deck chains are placed on the first two tiers, the hooks on the potters are caught in links on each deck chain. The potters on the far side are held in a vertical posi-

tion by a log rolled against them, while those nearest the skidway may be turned down until the sled is loaded, in order not to offer interference.

It is not practicable to attempt to take animal-drawn sleds up even occasional grades of 5 per cent or more, unless some hoisting device is used to pull up the sleds. This may comprise a steam boiler and engine driving drums on which a cable is wound that is attached to the forward part of the sled. The team usually

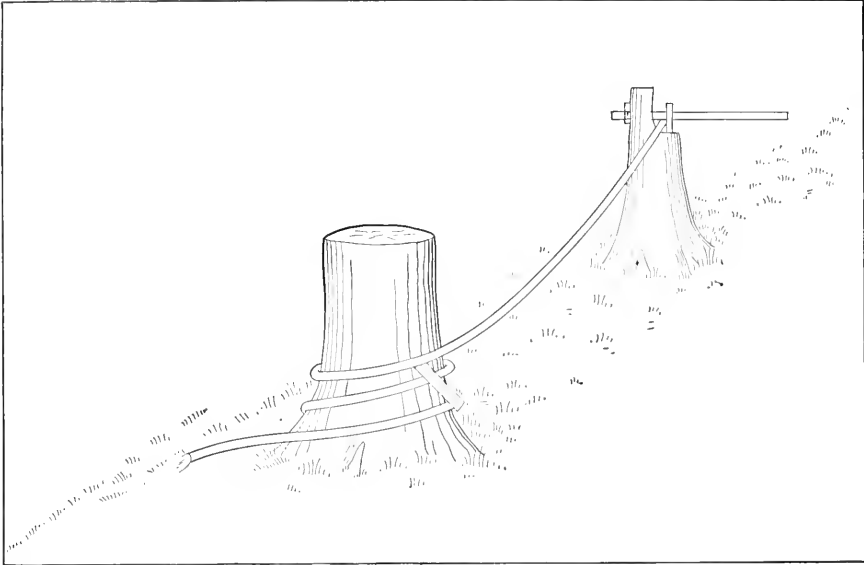

FIG. 48. — A Snubbing Device for controlling the speed of Loaded Sleds on Steep Grades. The free end of the rope in the foreground is attached to the sled.

is detached before the load starts. In some cases the sleds are returned to the foot of the incline by means of a re-haul.

The problem of lowering sleds down steep inclines is solved by the use of some form of snubbing device. The most simple type has a 1-inch or larger manila rope one end of which is fastened to the rear of the sled. The rope is then passed three or four times around a stump at the top of the grade. As the sled descends its speed is controlled by means of the rope, which is allowed to run around the stump as fast as desired. The operator controls the rope speed by means of a lever as shown in Fig. 48.

The rope usually is from 50 to 100 feet longer than the slope so that a descending sled pulls the free end of the rope up the grade, and causes it to change ends when a sled load descends.

A patent snubbing device is shown in Fig. 49. This system is adapted for any distance up to 2500 feet and, by the use of rollers, may be used on any degree of curvature under 90° . The brake, which is snubbed to a stump at the top of the grade, has a heavy timber frame, mounted on steel-shod runners, which is faced on top with a $\frac{5}{8}$ -inch steel plate. Four or six friction

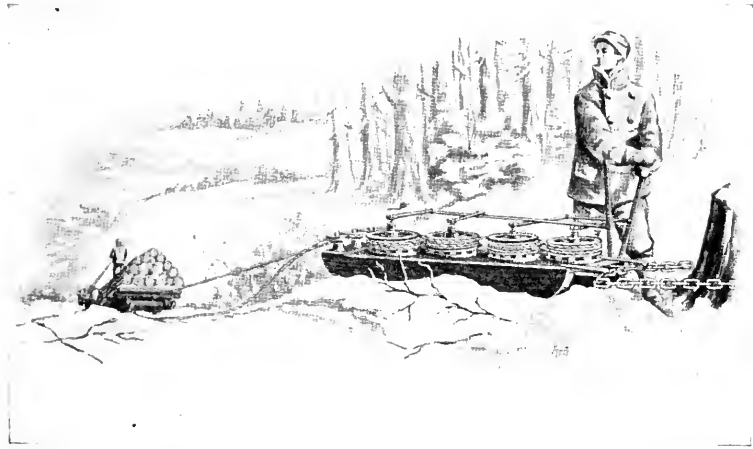

FIG. 49. — The Barienger Snubbing Device used to control the Speed of Sleds on Descending Grades.

bases with hard maple faces are fastened to the steel plate. A cast-iron grooved wheel with a smooth friction face on the under side is mounted on a vertical steel post above each hard maple face. A steel spring holds the wheels above the maple blocks when the cable is running free. A control lever is provided for each two wheels by means of which they can be forced against the maple friction face and the speed retarded or the load stopped. On low grades one set of friction wheels may be adequate, while on steep grades all may be required. The lowering cable is $\frac{5}{8}$ -inch plow steel and should be 100 feet longer than the grade. It is fastened to a wire cable sling which passes around the load.

On well-maintained roads having favorable descending grades, four horses can haul from 5000 to 8000 board feet per load, while

two horses can haul from 2500 to 4000 feet. On unfavorable grades the capacity of four horses may be from 2000 to 3000 board feet, and of two horses from 1250 to 1500 feet.

The number of daily trips made by teams for given distances is influenced by the weight and condition of the animals, the character of the road and the time required to load and unload the sleds. Horses tire on long hauls with heavy loads, consequently more timber can be hauled with lighter loads because of the greater speed possible. Horses cannot travel more than 24 miles daily for long periods, and this should be cut down to 20 miles when possible. The number of round-trips for a given length of haul is approximately as follows:

6-mile haul	2 round-trips
5-mile haul	2 round-trips
4-mile haul	2-3 round-trips
3-mile haul	3 round-trips
2-mile haul	4-5 round-trips
1-mile haul	6-8 round-trips
$\frac{1}{2}$ - to $\frac{3}{4}$ -mile haul	10-12 round-trips

Log Haulers. — As early as 1885 the attention of loggers was directed to the problem of introducing some form of mechanical traction to replace horses on long sled hauls, but it was some years before a satisfactory machine was placed on the market.

In 1889, Geo. T. Glover placed four log haulers on operations in Michigan. These were probably the first machines used for this purpose and, although they were not a success, they were the forerunners of the more recent ones that have proved to be of great value.

The first successful steam log hauler was patented by O. A. Lombard of Waterville, Maine, who adopted the general principles of the driving gear on geared locomotives, substituting for driving wheels a special form of heavy traction device.

The hauler has a locomotive-type boiler mounted on a heavy reinforced channel-iron frame, which also supports the cab and coal tender at the rear. The machine is supported in front on a narrow tread sled, which is so constructed that it may be run either forward or backward. A pilot, who sits on the front of the machine, steers the hauler by means of a hand wheel which turns the sled.

The weight of the machine rests chiefly upon two special trac-

tion devices placed under the rear end of the boiler. Each has a heavy steel runner, hung on a $4\frac{1}{2}$ -inch shaft and equipped on each end with a heavy box in which an iron shaft carrying a heavy steel sprocket wheel runs. Each set of sprocket wheels meshes into and carries an endless tread chain 12 inches wide and 14 feet long, which is armed with calks and furnishes the traction surface. The weight of the engine is distributed over the surface of the tread chain by two tool steel roller chains, which

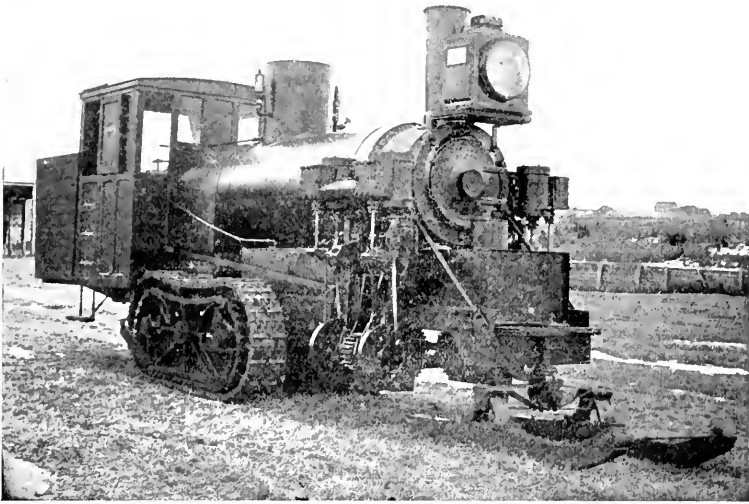

Fig. 50. — A Lombard Steam Log Hauler.

run in a tool steel channel attached to the underside of the steel runner inside of the tread chain. A bearing surface of approximately $4\frac{1}{2}$ square feet is given to each tread chain which is sufficient for tractive purposes and does not tear up the road.

The boiler, which is equipped with locomotive boiler attachments, is 15 feet long, 36 inches in diameter and is built for a working pressure of 200 pounds. The water tank is placed under the boiler directly in front of the fire box and has a capacity of ten barrels, which will run the hauler for 5 miles.

The engine has four vertical $6\frac{1}{2}$ - by 8-inch cylinders which transmit power by a series of gears to the rear sprocket wheel on each runner. Two cylinders are placed on each side of the

forward part of the boiler. The log hauler weighs from 17 to 22 tons when loaded with fuel and water.

Steam log haulers are used extensively in the Lake States, in the Northeast and in Canada.

Some advantages possessed by the machine are that the annual depreciation¹ and repairs are less than the depreciation on an equivalent number of animals, the necessity of bringing in large quantities of feed is obviated, and the machine can be operated day and night by employing two crews. Hauls exceeding 4 miles generally can be made cheaper with a log hauler than with animals.

Under average conditions a cord of 2-foot fairly dry wood will run a hauler approximately 8 miles, while a ton of soft coal will run it about 24 miles. Watering places must be provided along the road at intervals of from 3 to 5 miles.

The operation of a steam log hauler requires a crew of from three to five men; namely, one engineer, one fireman, one pilot and when from ten to twelve sleds are hauled one or two trainmen.

The average speed, with loaded sleds, is $4\frac{1}{2}$ miles per hour, and with a train of empty sleds the speed is about 6 miles per hour.

Gasoline caterpillar tractors² of several types have been introduced for sled hauling within the last few years and are rapidly replacing the steam driven ones since they weigh less, have their center of gravity lower and, therefore, are more difficult to upset; require a very small amount of water daily; have a more simple fuel problem because sufficient gasoline can be taken on at one time to run the machine for a day; they have no boiler flues to burn out on steep grades; and one-third less labor is required for the operation of a machine because a fireman and pilot are not needed.

The cost of road construction for both types of log haulers is greater than for animals because stronger bridges must be built, steep down-grades side-banked and timbered, all curves strongly side-skidded to prevent the sleighs leaving the road, and a "go-back" road built so that the haulers can return with empty sleds at full speed. Sharp curves should be avoided because it is difficult to keep a train of sleds in the road.

¹ The average annual depreciation is 15 per cent.

² See Chapter XIII.

On long, level hauls it is customary to rut and ice the roads to increase the hauling capacity. This may be done daily on the last return trip from the landing, the rutter and sprinkler being attached to the rear of the train. As a rule, however, the road is maintained by a separate crew.

Sleds are made stronger than for animal haul because they not only bear a heavier load but are subject to severe strain in stopping and starting. The gauge usually is about 8 feet in order that the hauler may travel inside of the ruts.

Where the road has steep ascending or descending grades three or four sleds compose a "turn" because in the first instance the



FIG. 51. — Type of Sled used with a Steam Log Hauler.

machine cannot pull loads of much greater weight and in the second, sleds have a tendency to "jackknife" and run out of the rut.

In mountain regions, steam log haulers are used on the main road only because the cost of constructing suitable secondary roads is too great. Sleds are hauled by horses to a central point on the main road and there made into turns for the log hauler. In a flat region the hauler may operate direct from the skidway to the landing, because of cheap road construction.

Landings should be arranged so that sleds can be run along the side of the rollways and unloaded without respotting. The hauler then need not remain during unloading but can at once start on the return trip to the skidways with the empties from the preceding turn. This method of operation necessitates the use of three sets of sleds; namely, one at the skidways, one on the road and one at the landing. The increased cost of equipment is more than offset by the greater capacity of the hauler and the decreased labor cost at the landing.

Haulers in the Adirondaek mountains have carried fifteen cords of spruce pulpwood over roads having 10 and 11 per cent grades. Distance records of 84 miles in twenty-four hours have been reported. The heaviest loads have been hauled in the Lake States on iced roads. A single steam log hauler in Wisconsin has hauled fourteen sled loads of hardwood in one train, each sled bearing from 6000 to 7000 board feet, making three or four trips daily on a round-trip of 12 miles. In Minnesota, trains of nine sleds, each bearing 12,000 board feet of white and Norway pine, have been transported by one hauler. A steam hauler in Ontario made three turns daily on a road between 7 and 8 miles long hauling from nine to twelve sleds per trip, an average of thirty loads. Each sled carried eighty logs, or a total daily haul of 2400 logs. The company estimated that the hauler did the work of twenty teams.¹

A record² of one machine for a season's haul in Stetson Town, Franklin County, Maine, from January 11 to March 6, 1907, running day and night shifts, is shown in the following:

Length of haul.....	7.5 miles
Total miles traveled.....	2850
Actual speed.....	4 to 6 miles per hour
Sleds hauled.....	551
Largest number of sleds in 1 turn	5
Total sleds used daily.....	21
Fuel used.....	350 cords of 2-foot hardwood
Elapsed time.....	65 days
Running time.....	53 days, 19 hours, 45 minutes
Lost time.....	6 days, 4 hours, 15 minutes
Total log scale.....	3,403,332 feet log scale
Scale per sled.....	6225 feet log scale.
Scale per turn.....	18,052 feet log scale
Largest train.....	37,710 feet log scale

Sixty-two horses would have been required to haul the same amount of timber.

¹ See *Logging by Steam in Ontario Forests*. Canada Lumberman, Toronto, Ontario, Canada, September, 1911, p. 77.

² From the *Mechanical Traction of Sleds*, by Asa S. Williams. *Forestry Quarterly*, Vol. VI, 1908, p. 361.

BIBLIOGRAPHICAL NOTE TO CHAPTER XI

- BROWN, Simmons: Mechanical Log Haulers and their Development. Report of Third Annual Conference of the Woods Dept., Berlin Mills Co. et al, Berlin, New Hampshire, Nov., 1915., pp. 22 to 26.
- INNES, J. S.: Tractor Haulage. Canada Lumberman and Woodworker, July 15, 1922. pp. 45 and 46.
- SISSON, Stanley H.: Use of Tractors in Winter Log-hauling. Empire State Forest Products Asso., Bul. No. 12, Albany, N. Y., Dec., 1921, pp. 26-29.

CHAPTER XII

WHEELED VEHICLES

Wheeled vehicles may be used where snow is not available as a bottom on which to move logs. They are employed for summer logging in the Lake States and the Inland Empire, and for year-round logging in the South, Southwest, and the sugar pine region of California.

TWO-WHEELED VEHICLES

Bummers. — A low truck, called a bumper or self-loading skidder is extensively used in the flat and rolling hardwood and in the yellow pine forests of the South, especially in Arkansas and Louisiana. A similar vehicle also is used in some places in the Inland Empire. In the South bummers often are made by the camp blacksmith and have solid black gum wheels with 14-inch faces and a diameter of from 18 to 21 inches. Those offered by manufacturers of logging supplies have a skeleton wheel 24 inches in diameter with a 6-inch tire. The solid wheel is usually preferred because it gives a greater bearing surface on soft ground.

Heavy steel axles support a wooden bunk from $2\frac{1}{2}$ to $3\frac{1}{2}$ feet in length which is slightly concave on its upper surface. A tongue $5\frac{1}{2}$ feet long is attached to the bunk and serves both as a loading lever and as a point of attachment for the draft power. Small logs are held on the bunk with chains and large logs with tongs attached to the front face of the bunk or to a breastplate on the tongue.

In loading, a bumper is driven up to a log and backed around against it near the end. The tongue is then brought to a perpendicular position which permits the attachment of the tongs 3 or 4 feet from the end of the log (Fig. 52). The team is then hitched to a chain on the end of the tongue and driven forward until the tongue has been brought to a horizontal position, which brings the log on top of the wheels. The trucks are turned by

the horses until the log drops on the bunk. The load is then ready to start for the skidway.

Unloading may be accomplished by a reversal of the process, or by disengaging the tong points by a blow from a cant hook or maul and dragging the bumper from under the log.

When several small logs are handled at one time, tongs are replaced with chains and loading is done from a rough skidway consisting of a single skid stick with one end raised high enough from the ground to enable the logs to be rolled on the bunks with cant hooks.

Bummers may be used to advantage only in a region fairly free from brush, where the bottom is smooth and hard enough to prevent the low wheels from miring, and where gentle grades to the skidway can be secured. They are seldom used for distances exceeding 40 rods. Bummers are less serviceable than high wheels on ascending grades, since they pull harder.

In ten hours a bumper will handle from 8500 to 14,000 board feet of yellow pine for a distance of 200 yards, and from 4000 to 6000 board feet for a distance of 450 yards.

Log Carts. — In all types of carts the logs are swung beneath the wheels with the rear ends dragging on the ground. The height of wheels ranges from 5 to 12 feet with a corresponding variation in gauge.

High-wheeled log carts are not adapted to hauling on descending grades in excess of 25 per cent because of the difficulty of holding back the load. They are most efficient on a level or gently rolling bottom.

A cart used in the Coastal Plain region has an arched axle and wheels $4\frac{1}{2}$ or $5\frac{1}{2}$ feet high. The hounds of the cart are fastened

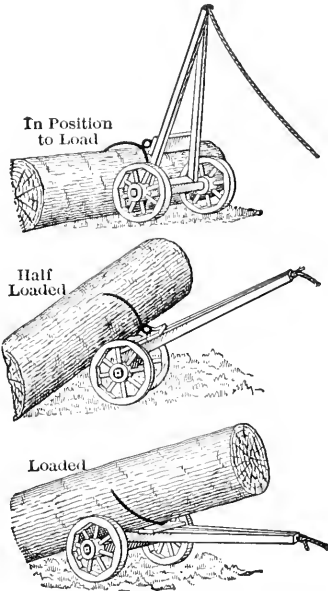

FIG. 52. — The Method of loading Logs on a Bumper.

on either side of the tongue by a heavy bolt. A bunk rests on top of the axle and carries two upright guides between which the tongue fits. The latter is held in place by a spring latch. When the cart is to be loaded it is driven up to one end of a log, then backed until the axle is directly over that part of the log to which the chains or grapples are to be attached. The latch on the guides is then released, the team is backed for a step or two and the hounds are forced into a position nearly vertical which turns the bunk through a quarter circle and brings it near enough to the ground to permit the grapples or chains to be attached. The elevation of the log is accomplished by driving the team forward, which brings the hounds and tongue to a horizontal position.

Wheels of this character may be used in a region where it would not be possible to snake, or to use bummers without swamping out trails. They can be driven readily over light standing brush or in down timber with a minimum of swamping. It is not customary to cut trails for them. The capacity of the wheels is one large, or from three to four small logs. Two horses or two mules draw each cart.

Carts with larger wheels than those mentioned are in extensive use in the South, Southwest, Lake States, sugar pine region of California and, to a limited extent, in the Inland Empire. They formerly were used by small operators on the Pacific Coast. The wheels are from 7 to 12 feet in diameter and have tires from 5 to 10 inches wide. When one or two logs are handled they are suspended with grapples, and when several constitute a load chains are used. The chief distinction between the several patterns of carts is in the mechanism for raising the logs from the ground.

One type of high-wheeled log cart has a heavy wooden bunk and a tongue from 12 to 16 feet long. A chain is attached to the front side of and passes over the top of the bunk, ending in a ring to which the grapple hooks are fastened. In loading the cart is backed over the log or logs and the tongue raised to a position nearly vertical, by means of a pole 10 or 12 feet long which is fastened on the upper side of the tongue, 3 or 4 feet in front of the bunk. This pole also serves to hold the tongue in position during loading. The elevation of the tongue lowers the grapples to the ground so that they can be attached to the log. A team then pulls the tongue to a horizontal position, which raises

the front end of the log clear of the ground. The tongue is then chained to the log, the horses attached to the front end of it and the load is ready to move. By using chains, several logs may be handled at one time.

Carts of this character are used for hauling short hardwood



FIG. 53. — A Slip-tongue Log Cart, showing the Position of the Load during Transit. The short lever arm above the main tongue is attached to the rotating bunk to which the timber grabs are fastened. It automatically assumes a nearly vertical position, when the cart tongue is pushed to the rear. Texas.

logs in the Lake States, sugar pine in California and yellow pine in the South.

A type known as the "slip tongue" cart has now largely superseded the older forms. It has a tongue 28 or 30 feet long, which slides between the hounds of the cart. It is weighted on the rear end so as to lighten the load on the necks of the wheel animals. There is a roller directly over the axle, to which the grapples are attached by chains.¹ Fastened to this roller is a short lever arm which is connected to the sliding tongue by means of a chain. The cart is driven over a log, a catch holding the slip tongue and the lever arm, is loosened, the team backed up and the tongue

¹ See Figs. 53 and 54.

slipped to the rear. The roller is so weighted that it revolves in a quarter circle, carrying the lever arm to a nearly vertical position. The grapples are then fastened to the logs, and the team is started. The tongue slips forward, pulling the lever arm to a horizontal position, and raises the front end of the log from the ground. When the short lever arm reaches the catch on the



FIG. 54. — A Two-wheeled Slip-Tongue Log Cart hauling Long Logs. Note the rotating bunk above the cart axle, to which the grab chains are attached. Texas.

tongue it is automatically locked. The team then starts for the skidway with the load.

High wheels are especially adapted to a flat and rolling country with a firm, smooth bottom and an absence of heavy underbrush. They are most frequently used on hauls not exceeding $\frac{1}{2}$ mile but occasionally they are used for distances of 2 or $2\frac{1}{2}$ miles. In the pine forests of the extreme South they may be used for distances which do not exceed 100 feet. When used as a skidding rig in the southern pine forests the only road construction required is swamping out a trail through the slash along which the teams

can pass. The practice prevails in some regions of felling the timber in strips, beginning at the back side of the skidding area where a strip from 100 to 200 feet wide is cut parallel to the railroad and then skidded. The work continues in this manner until the railroad is reached. This permits the teamsters to haul the greater part of the time through standing timber free from slash, which facilitates the work. Some loggers claim that the efficiency of a crew is increased 25 per cent by this method.

Roads are made and roughly graded in the hardwood forests of the Lake States where brush is abundant. Since short logs only are handled the roads need not be straight and boulders and stumps can be passed by a detour.

From two to six animals are used to haul log carts, depending on the character of the roadbed and the size and amount of timber hauled. Mules are preferred in the South, and horses in the North and West.

A crew in the southern pine forests often consists of three teamsters, one or two "bunch" teamsters, one or two swamper and one skidway man. The "bunch" teams yard the logs along the roads at places convenient to the log carts.

In the Lake States, two pairs of wheels and two bunch teams are used by a crew. The brushy nature of the country requires about four men for the swamping and other men with cant hooks to roll the bunched logs together into loads for each log cart.

In the southern yellow pine region log carts drawn by two mules haul from 200 to 500 board feet of long logs at one load. When four mules are used, from 800 to 1000 board feet may be handled, but six mules are required for more than this volume.

In the Lake States the load for four horses ranges between 1000 and 1200 feet log scale, with a maximum of 1800 feet. In the sugar pine region of California, from six to seven carts, drawn by four horses each weighing from 1500 to 1800 pounds are used in one camp and will put in an average of from 100,000 to 125,000 board feet daily.

WAGONS

Wagons are a desirable form of vehicle for stocking small saw-mill plants, transporting timber to the railroad on large operations where the haul exceeds 600 feet, and for logging isolated tracts on which there is not sufficient timber to warrant the con-

struction of a logging railroad. They may be used to transport logs direct from the stump to the mill for distances of from 2 to 4 miles, although they are most extensively used to haul logs from the stump to a railroad, stream or chute. The average length of haul in the flat and rolling pine lands of the South is from $\frac{1}{4}$ to $\frac{1}{2}$ mile.

Mule Carts. — In the Coastal Plain region, a type of 4-wheeled wagon called the "mule cart" is used on the uplands for hauling logs to the railroad. It has two pairs of trucks, the wheels of the forward pair being 4 feet, and the rear pair 6 feet, in diameter. The forward trucks have a straight axle and are equipped with a tongue of the usual length for a wagon, while the rear pair has an arched axle and bunk to which a tongue is attached which replaces the reach in an ordinary wagon. When the mule cart is loaded this tongue is chained down to a ring on the bunk of the forward pair of wheels. The logs are swung under the rear pair of wheels and only the forward ends of the logs are raised from the ground. The forward pair of trucks may be detached and used for skidding purposes, in which case the log is suspended under the axle by means of grabs, or tongs. Mule carts do not possess any special advantages over a wagon, but are preferred because laborers are familiar with their use.

The usual maximum length of haul is 500 yards, but it is sometimes extended to 1 mile or more in scattered timber.

The average load per cart varies between 200 and 400 board feet, with a daily output of from 3500 to 5000 feet for $\frac{1}{4}$ mile haul.

Four-wheeled Wagons. — These are strongly constructed, with from 32- to 38-inch front wheels and from 34- to 40-inch rear wheels of wood or steel, from 3- to 6-inch tires,¹ extension reach for handling logs of various lengths, heavy bolsters with adjustable blocks, stiff tongues for oxen and drop tongues for horses and mules, and cast or steel skeins, or steel axles. They have a rated carrying capacity of from 5000 to 15,000 pounds and range in weight from 1300 to 2000 pounds. Spikes are used on the back bolster to prevent the logs from sliding forward when hauling in a hilly region. Steel axles are not as popular as skeins, because of the difficulty of repairing them in the camp blacksmith shop.

Log wagon wheels are sometimes boxed with boards to keep

¹ Some loggers prefer from 3- to 3½-inch tires for two animals, and from 4- to 5-inch tires for four animals.

mud from accumulating on the spokes. The box is constructed of rough boards nailed to the rims and closely fitted around the hub.

From two to five mules or horses, and from six to ten oxen are used for draft purposes, although heavy wagons are sometimes drawn by traction engines or tractors.

In some parts of the Inland Empire very heavy wagons are used for hauling logs from storage yards or skidways to the logging



FIG. 55. — A Four-wheeled Log Wagon unloading at a Skidway along a Logging Railroad Spur. The graded right-of-way is being used as a road and, therefore, the logs are being decked from the front of the skidway, instead of from the rear as is the usual custom. Missouri.

railroad. Those on an operation in Montana had standard height wheels with 6-inch tires, and bunks 6 feet long and 10 feet apart, with the outer ends fitted with sway bars for the attachment of binding chains. The rear trucks were equipped with heavy hand brakes operated by a man who traveled on foot behind the load. From 2500 to 4000 board feet were loaded on the wagons by gravity from elevated skidways at the terminus of a log slide. The road was 1 mile long and mostly downgrade, with some pitches of 6 and 8 per cent. Four horses were used for draft and each team averaged five round-trips per day between the

railroad and the log chute and handled from 15,000 to 18,000 board feet.

In the sugar pine region of California very heavy 4-wheeled trucks of 12 tons' capacity are used for log transportation when a traction engine is employed for draft power. These wagons have 54-inch solid or skeleton wheels, 20-inch tires, a short coupling tongue, and are equipped with hand brakes and binding chains. From 5000 to 7500 board feet may be loaded on one wagon.

Six-wheeled Wagons. — Wagons with six wheels were placed on the market in the South some years ago but they have not proved as satisfactory as the eight-wheeled ones. The rear trucks, which carry from 60 to 70 per cent of the load, have a rigid frame bearing two axles and four wheels arranged in the same manner as in the 8-wheeled type. The rear truck is connected to the forward one by the usual form of wagon reach. They are designed to carry heavier loads than 4-wheeled wagons, and to eliminate the heavy draft and difficulty in backing and turning in a short compass which are common to the 8-wheeled wagons.

Eight-wheeled Wagons. — Eight-wheeled wagons are in extensive use in the southern pine forests, and in the hardwood forests of the Mississippi bottoms.

They are a heavy draft vehicle, more difficult to turn and to back than a 4-wheeled wagon but are capable of carrying a much heavier load because of the wide tires and the distribution of the load over eight wheels. They can be used on a dirt road in a shorter time after a rain than 4-wheeled wagons, and often a road will improve under 8-wheeled traffic where it would deteriorate under that of four wheels. The bunks also are lower than on 4-wheelers and the wagon can be loaded more readily.

On short hauls four or five mules are frequently used with 8-wheeled wagons, but on long hauls they are not desirable for this type of wagon because of its heavy draft, oxen being the best, especially for heavy loads and on unfavorable bottom. From three to five yoke constitute a team.

Eight-wheeled wagons are successfully used with traction engine draft, three or four wagons each holding from 1000 to 1500 board feet constituting a train.

The distinctive features of an 8-wheeled wagon are the forward and rear trucks which on some types are rigid, consequently

sharp turns cannot be made without dragging some or all of the wheels. Others have the front trucks so arranged that the two sets of wheels can turn independently, thus reducing the resistance. All wheels are of the same diameter, varying in different vehicles from 30 to 36 inches in height.

The log bunks, with adjustable blocks, are supported midway between the wheels of each truck and project slightly above the



FIG. 56. — An Eight-wheeled Log Wagon at the Skidway. Louisiana.

wheels. A short reach is attached to the forward and rear trucks by flexible joints.

Eight-wheelers have an estimated capacity, on good roads, of from 9000 to 20,000 pounds weight. They weigh from 1200 to 1800 pounds.

Wagon Equipment. — The equipment used with log wagons on southern pine operations is as follows:

- 1 ax.
- 1 cant hook.
- 1 five-sixteenth-inch chain, 30 feet long, the ends of which are bolted to the bunks of the forward and rear trucks.
- 1 one-half-inch chain, 12 feet long, with a grab hook on one end and a loading hook on the other. This chain and the one above form the crosshaul used in loading.
- 2 hardwood skids about 7 feet long and 4 inches in diameter.
- 1 hickory binding pole.

Roads. — On short hauls the only preparation made for roads is to cut out a right-of-way through the brush. If the bottom becomes heavy for travel a new route is selected. When a

large number of logs must pass over a single route, a good dirt road is essential. It should be built on high ground, the streams bridged, wet places corduroyed and sufficient repair work done to maintain it in good condition.

The best season for hauling is during the summer months when the ground is dry and hard, for maximum loads can then be handled on logging trucks with the least amount of trouble. In swampy sections and on bottom-land logging often has to be suspended during the rainy period.

Hauling. — A common practice among companies who own their equipment and do their own logging is to work several wagons to a crew. The logs, after being swamped, are skidded with a bunch team to some place convenient to the wagons. The wagon teamsters then are concerned only with loading and hauling the logs. On small operations and where small contractors may be operating, each wagon teamster does his own swamping, bunching and loading. The former method is considered the more efficient.¹

On a haul of $\frac{1}{4}$ mile, one bunch team can skid logs for two or three wagons, and for greater distances it can serve more teams because of the fewer number of trips made. Each wagon carries a pair of skidding tongs and, if the bunch team gets behind, the wagon teamster unhooks his leaders or the pole team and brings in a few logs. The number of swampers required depends on the character of the timber and the under-brush.

Wagons are loaded by the teamsters, who use a crosshaul rig.

On short hauls, large logs are not bound to the wagon, but on long hauls or when the load is made up of small logs, it is customary to pass a binding chain around the load and under the reach. This chain is tightened by a hickory binding pole. The loading chains are wrapped loosely around the logs, the loading skids are placed on the reach, and the wagon is ready to start for the skidway. Logs are unloaded by removing the binding chains, placing skids in position and rolling the logs off the wagon by means of cant hooks or peavies.

Hauling should be in charge of a team boss, who selects and

¹ The secret of successful logging with cattle is to keep them going continuously at their slow gait. Therefore, much depends on the swamper's skill in keeping ahead of the hauling team so that the latter will not have to wait for loads.

directs the preparation of skidways and logging roads, determines the best methods and equipment for hauling timber from particular sections, allots given crews to specified work, and sees that all men and animals are employed to best advantage. Skidways should be selected and prepared some days in advance of actual use so that the hauling teams will not be delayed by lack of storage space.

On good bottom and level ground two horses or mules should handle from 400 to 600 board feet per load and from 6000 to 10,000



FIG. 57. — Loading a Log Wagon by means of the Cross-haul. The teamster is doing his own loading. Missouri.

feet daily; four animals should handle from 600 to 800 feet per load, and from 8000 to 12,000 feet daily. Five yokes of oxen will handle from 600 to 1000 feet of logs per trip, depending on the kind of bottom and the size of the timber.

The average number of trips daily for two horses or mules is approximately as follows:

$\frac{1}{4}$ mile and less.....	12 to 15 trips
$\frac{1}{4}$ to $\frac{1}{2}$ mile.....	10 trips
$\frac{1}{2}$ to $\frac{3}{4}$ mile.....	7 trips
$\frac{3}{4}$ to $1\frac{1}{4}$ miles.....	5 trips
$1\frac{1}{4}$ to $1\frac{3}{4}$ miles.....	4-5 trips

TRACTION ENGINES FOR WAGON HAUL

Traction engines are sometimes used for transporting logs from the woods to the mill when the amount of timber to be hauled is not great enough to warrant the construction of a railroad, when the grades are unfavorable for the use of animals and when timber of large size and great weight must be handled. They are rapidly being supplanted by motor trucks which are faster and more efficient.

A traction engine to give the best results requires a good stone road but it works well on solid earth bottom. The ordinary 4-wheeled type is not successful in swampy places, on rough roads or on dirt bottom during rainy periods because the traction wheels soon render the road impassable.

Four-wheeled. — This traction engine has a locomotive-type boiler carrying about 165 pounds' steam pressure, and is equipped to burn either coal, wood or oil. The boiler and other parts of the engine are mainly supported on two traction wheels running on axles attached on opposite sides of the fire box. The diameter of these wheels is ordinarily between 5 and 6 feet. The width of tire is governed by the character of bottom over which the engine is to travel. On ordinary roads from 20- to 24-inch tires are adequate even for the largest machines.

The forward part of the engine is supported on a pair of wheels $3\frac{1}{2}$ or 4 feet in diameter with from 6- to 10-inch tires. These wheels carry only a small proportion of the total weight, their chief function being to aid in steering. This is done by means of a hand wheel placed at the rear of the engine in close reach of the engineer.

The engine which develops from 20 to 30-horse-power is of the single cylinder type with a heavy flywheel.

The daily fuel requirements range between $1\frac{1}{2}$ and $2\frac{1}{2}$ cords of hardwood, or between 1 and $1\frac{1}{2}$ tons of coal. About 2500 gallons of water are needed for the above amount of fuel.

On a Washington operation a 30-horse-power traction engine has made a daily round trip of 30 miles, hauling 20,000 board feet of green lumber up 15 per cent grades, and down 30 per cent grades. This is probably the maximum capacity of an engine of this type.

Holt Three-wheeled. — This type was developed chiefly for use in logging on the Pacific Coast and has a return-tube water-

leg horizontal boiler supported on an I-beam frame. Almost the entire weight of the machine rests on the rear traction wheels, each $7\frac{1}{2}$ feet in diameter with a 24-inch tire. The fore part of the engine is supported by a single 4-foot wheel used for steering. Provision is made for the operation of the steering gear both by hand and by power. A single cylinder 11- by 12-inch balanced



FIG. 58. — A Holt Three-wheeled Traction Engine hauling Sugar Pine Logs. California.

valve engine is placed on top of the boiler, and at 165 pounds' steam pressure develops 60 horse power. Power is transmitted to the traction wheels by chains, and either wheel may be driven independently of the other. This is especially advantageous in making sharp turns. A radius of 25 feet is practicable in operating a train of five cars.

Water tanks with a capacity of from 400 to 700 gallons are carried on the frame directly in front of the boiler. The average water requirement per day of ten hours is from 2500 to 3000 gallons. From $1\frac{1}{2}$ to 3 cords of hardwood fuel, 1 to $2\frac{1}{2}$ tons of steam coal or from 200 to 300 gallons of fuel oil are required.

A special type of 3-wheeled wagon is sometimes employed for hauling logs and lumber with this engine. The front wheel is $3\frac{1}{3}$ feet in diameter, has a 12-inch tire and supports about one-fourth of the load. The remainder of the weight is borne on two rear wheels each $4\frac{1}{2}$ feet high and with 16-inch tires. The load is borne on a frame built to carry from 10 to 12 tons.

The manufacturers claim that a 60-horse-power engine will haul a load of from 40 to 60 tons at a speed of from 2 to 3 miles per hour, ascending grades as high as 10 per cent. Thirty thousand board feet of green lumber loaded on three trucks have been hauled up a 10 per cent grade, and 15,000 feet of logs have been hauled on two four-wheeled wagons over a rough log road down a 17 per cent grade. An engine hauling empty wagons travels 3 or 4 miles per hour.

MOTOR TRUCKS

The use of motor trucks for logging purposes has grown rapidly during recent years, especially in the Central Hardwood Region and in the Pacific Northwest. Their chief use is for hauling logs from the forest to the sawmill but they also are used for hauling camp supplies, pulling sleds loaded with logs, dragging timber over roads with steep grades and, when equipped with flanged wheels, as motive power for pulling cars on wooden- or steel-rail logging roads.

Motor trucks have proved a satisfactory form of transportation for moving logs from scattered areas containing from 500,000 to 40,000,000 feet log scale, when the maximum-sized logs do not exceed 5000 board feet, and the average logs are not more than 1000 board feet each and not more than 40 feet in length. When the timber is of larger size and the area contains more stumpage than the above mentioned maximum, a logging railroad would be more economical.

There is a recognized limit to the length of profitable motor truck haul for general logging purposes, although loggers are not agreed as to what is the maximum. Some state that it is about 10 miles, while others claim that a 15-mile haul may be profitable under favorable circumstances. The character of roadbed, and value of the logs are important factors in determining this question because the roadbed governs the size of load which can be hauled and the time required to make a round trip, and more

expense is warranted in hauling valuable logs than those of average quality. For example, veneer mills in the Central Hardwood Region have hauled logs on round trips of 85 miles, with average loads of from 900 to 1000 feet log scale and the service was stated to be as cheap as railroad transportation and much quicker.

Three general types of trucks are used, namely, light trucks, medium trucks with a rated capacity of from 3 to 4 tons, and heavy trucks rated at 5 tons or more. The light truck represents the lowest initial investment but owing to its limited capacity and less rugged construction, it is not adapted to heavy or steady log-hauling work. The medium-weight truck is adapted to conditions where the size of the load is limited by state or county road regulations. Many operators rely upon public roads for their main lines and build side roads from them to the timber. Limits have been set to the amount of timber which may be carried over public roads on one unit, in those sections in which hauling by motor trucks has become extensive. This limit varies from 2400 to 3000 board feet in different counties in the Douglas fir region. The heavy trucks are preferred on operations on which private roads, only, are used since maximum loads, ranging from 3000 to 5000 board feet, can be carried on each trip.

Many makes of trucks are used, including four-wheeled drive, and both chain and gear rear-wheel drive. Loggers prefer a machine with a wheel base of from 160 to 170 inches, since this gives a good balance to the load, and a truck so built can be handled on turns and at the loading places easier than one which is longer. The frames of trucks with larger wheel bases may give trouble, when overloaded, by tending to buckle. A motor truck for log hauling should have stronger springs, gears and bearings than are placed on ordinary commercial vehicles of the same size, because of the severe usage to which the machine is subject. Solid, single-tread rubber tires, 12 or 14 inches wide, are used on the rear wheels of practically all logging trucks and on trailers and are safe for use on dry pole or plank roads having 9 per cent grades. They will skid on a wet road on grades in excess of 7 per cent unless the tires are wrapped with $\frac{1}{2}$ -inch wire cable, or similar cable is fastened crosswise on the traction surface. On good roads and favorable grades, logging trucks travel from 10 to 12 miles per hour.

Trailers are now in extensive use with motor trucks since they add greatly to the average load capacity, because all trucks have a hauling ability greater than the volume of round timber which they can carry. Rubber-tired trailers, with two 40- to 44-inch wheels are recognized as the best type, and when operating on grades exceeding 9 per cent they should be equipped with brakes.

They often have double bunks, from 7 to 9 feet long, usually 8 feet, one being plain and the other having adjustable chock blocks. The rated capacity of trailers varies from 5 to 10 tons, and usually they carry about 60 per cent of the total load. They are connected to the truck by a wooden extension reach which is considered more satisfactory than one made from iron pipe because the latter bends and breaks more readily and is more expensive to repair or replace.

Success in truck logging is largely dependent on good roads, which should be so constructed that they will stand up under weights of 20 to 25 tons during all kinds of weather. Trucks cannot be operated successfully on dirt or gravel roads during wet weather, and dirt roads soon develop chuck holes during dry weather unless they are watered.¹

Various types of plank and pole roads have been developed by loggers who have endeavored to improve the traction surface in the forest over which they are hauling, especially if the bottom is soft or liable to severe wearing.

Plank roads on tangents have two traction surfaces from 20 to 30 inches wide which comprise the base on which the truck travels. The traction surface should be at least 24 inches wide on curves since the trailer has a tendency to cut across the curve and to displace the guard rail unless there is ample clearance. The stringers comprising the traction surface should not be less than 6 inches in thickness, and from 10 to 16 inches in width. Two or more pieces form a single stringer, and they are drift bolted to crossties spaced about $2\frac{1}{2}$ feet center to center. These planks are bedded in the ground surface so that they rest on a solid foundation. On grades that exceed 8 per cent, the planks forming the traction surface are laid crosswise on a substantial base of timbers, the spacing between planks being about 1 inch. This form of track is more expensive to construct than

¹ During dry weather, a dirt road usually can be kept in condition by the application, daily, of 1000 gallons of water per mile.

the longitudinal stringer road, but provides a better traction surface. Guard rails may be placed either inside or outside of the stringers, except on curves of 10 degrees or more when they are placed on both sides. The inside tread gauge both of the front and rear wheels is the same, which is not true of the outside measurements of front and rear tires. For this reason, inside guard rails are preferred since trucks steer more readily and trailers follow more easily. Inside guard rails should be not less than 4 inches in height but must not be so high that they interfere with the brake drums or driving gear. The guard rails are made from small poles spiked both to the cross-ties and to the stringers and when inside ones are used they are braced by small poles which are placed between them, about three to a pole length. Roads of this character should have the stumps removed from the right-of-way and have a 12-foot crown, ditched on both sides, and if necessary in the center, water from the latter being drawn away at least every 50 feet. Such a road requires from 80,000 to 100,000 board feet of stringers per mile, 11,000 linear feet of 8-inch poles for guard rails, 2300 linear feet of 6-inch poles for cross braces, and about 2000 pounds of spikes and drift bolts.

The maintenance cost of such a road is about one-half that for a logging railroad.

Several forms of pole roads have been used, among them small hewn poles called puncheons placed crosswise; two or three small hewed poles laid lengthwise without cross-ties; and the so-called fore-and-aft road which has a surface made from hewed stringers placed on cross-ties. The last type is the most satisfactory, the puncheon road having too much vibration and the small pole road providing an irregular surface.

The fore-and-aft road may have the traction surface under each wheel made from a single large pole, with a hewed face having a flat surface of 16 or more inches, or it may be made from two or three smaller poles, the timbers in all cases being supported on cross-ties. The single pole road is considered superior to the two- or three-pole one unless the faces of the poles are hewed so that they fit closely together because the weight of the load comes on the inside edges of the poles, and has a tendency to cause them to turn downward, thus loosening the spikes and spreading the poles. There also is a loss in traction surface on the two- and three-pole road due to the space between the timbers. Un-

less the poles are on the same level, the tires will not travel on a flat surface and excessive tire wear results.

On the one-pole road, timbers 18 inches or more in diameter are used with a hewed upper face 16 or more inches wide. These are laid on crossties spaced from 6 to 10 feet apart, depending on the solidity of the bottom and the weight of the load. Where two poles join, the under side of each is hewed flat for a distance of 4 feet on either side of the joint and an 8-foot timber placed under it. The stringers also are notched where they rest on the crossties and are drift-bolted to them. The timbers are bedded for about one-half their diameter and the center and sides of the grade are ditched and ample cross ditches must be provided to carry the water away from the grade. Either inside or outside guard rails may be used, and these are spiked to the poles. Concrete roads have been suggested as a substitute for pole and plank roads, but their high cost has deterred operators from using them. The life both of plank and fore-and-aft roads is from three to four years.

Motor truck loading is done either with a crosshaul and animal draft, or with a loading donkey and a gin-pole. The latter method is preferred on extensive operations because the load can be placed in from five to ten minutes. Since the maximum daily output per truck can be secured only when the loading and unloading time is kept at a minimum a rapid loading rig is necessary. Winches operated by the truck engine have been put on the market but have not been extensively adopted by loggers.

The most common unloading method is to elevate the outer side of the roadbed at the rollway from 18 to 24 inches which is sufficient to cause most of the logs to roll from the truck when the chock blocks are removed.

The maximum practical grades for motor truck work do not exceed 6 per cent in the loaded direction and 12 per cent empty. Trucks have been operated on grades as high as 35 per cent by the use of a power snubbing device which lowers the loaded trucks down the incline and pulls the empty trucks to the top.

The daily capacity of trucks is dependent on the size of truck, road regulations, grades, distance, and size of timber. A 5-ton truck with an 8½-ton trailer operating over private roads will haul an average load of 4000 board feet. The same truck on

public roads in Washington will be restricted to from 2400 to 3000 board feet, depending on locality. The average loading time ranges from 10 to 15 minutes, the unloading time 10 minutes, and the average time required per mile, 10 minutes. The time required for a round trip on a haul of 1 mile, therefore, is from 30 to 35 minutes.

BIBLIOGRAPHICAL NOTE TO CHAPTER XII

- DRISSEN, J. P.: Time Study of Motor Truck Logging of Yellow Pine. *The Timberman*, August, 1921, p. 97.
- KNAPP, F. M.: Motor Truck Logging Methods. Bul. No. 12, Univ. of Washington, Engineering Experiment Station, Seattle, April, 1921.
- MASON, Fred R.: Study of Daily Production of Big Wheels. *The Timberman*, April, 1921, p. 39.
- MEIKLEJOHN, E. N.: Truck Logging. *The Timberman*, Oct. 1920, pp. 85 and 86.
- VAN ORSDEL, John P.: Plans for Motor Truck Logging. *The Timberman*, July, 1921, pp. 97, 100, and 102.

CHAPTER XIII¹

TRACTORS

Tractors are used by the logging industry as a substitute for animal draft for skidding, for hauling logs loaded on wagons and trailers, and also for trailing logs in slides. Comparatively small and isolated tracts of timber, which do not justify the building of a railroad often present an opportunity for tractor logging; also stands which are too light for profitable logging by steam machinery, especially if the timber is not too small and the character of topography or bottom are unsuited to animal logging. Logging by tractors is more destructive to the timber left on the area after cutting and to reproduction than animal logging, but it is less destructive than power logging machinery.

The limited knowledge of tractors and their proper use has retarded the success of this type of equipment on many logging operations. Many breakdowns could be eliminated if competent drivers only were hired and they were made financially interested in the continuous productive run of the machines.

The crawler type² of tractor has proved to be better adapted to logging work than the wheeled type, because the latter often is useless on sandy, soft or loose forest soils, on wet clay, and on snow and ice, since it has a tendency to mire on soft and to slip on hard road surfaces, while the former gives satisfactory results when operated on such bottoms, due chiefly to the large area of traction contact with the ground surface. Tractors are not adapted to very rough topography, but in some cases they have been operated successfully on adverse grades as high as 15 per cent or more, and hence they may be substituted for logging

¹ Prepared by A. Koroleff.

² Crawler tractors also are known under the names of "track-layers" or "caterpillars" but these names may lead to misunderstanding because "caterpillar" is an exclusive trade name for tractors made by the Holt Manufacturing Co., while "track-layer" also is a term used to designate a machine used in the laying of railroad tracks.

railroad spur lines on up-grade hauls which are too steep for a railroad.

Prior to the World War crawler tractors were rarely used for logging purposes, but at the present time, especially in the hardwood and pine regions, there are 2000 or more of these machines in use. Crawler tractors were first used only for hauling timber,

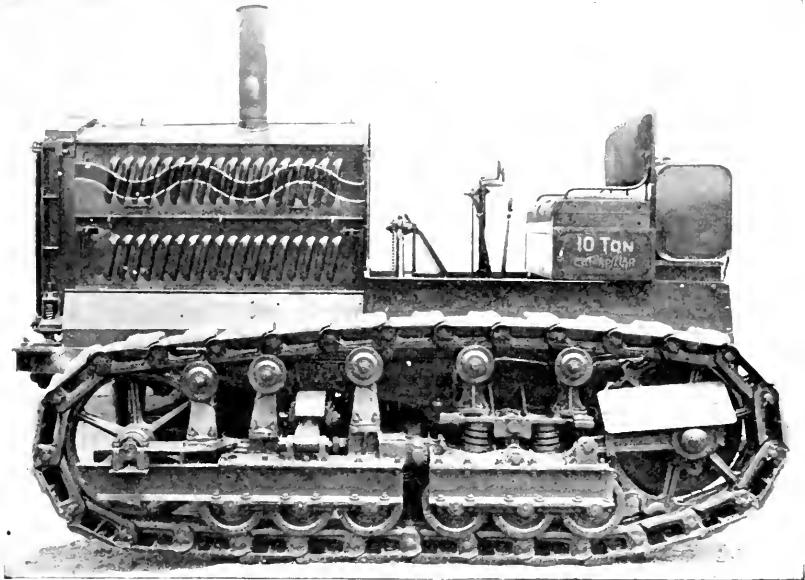

FIG. 59. — A Holt 10-ton Caterpillar Tractor showing the General Features of one of the Traction Members.

but they are now employed for skidding and yarding, for construction work on logging roads, and in other auxiliary work.

The principle of the crawler device was invented in England about 150 years ago, but its successful application to tractors was made in America about the beginning of the present century, when a steam log hauler was built for work on snow and iced roads. The crawler traction device was later improved and successfully used on tractors with internal combustion motors. At present there are about twenty American models of crawler tractors which are used by loggers.

The modern traction device of a crawler-type tractor has steel links or shoes pivoted together by steel pins in an endless belt or

track which rotates around the idler, the rollers, and the sprocket driven by engine power. This endless, flexible belt corresponds to the rim of a wheel but its inner face serves as a track on which the machine itself travels like a locomotive on a rack-and-pinion railroad. Its weight is carried on flanged rollers, and a positive drive is provided by the meshing of the driving sprocket teeth with the pins of the track. On some tractors the frames of the crawler members are built in one piece and are rigid, while in others the frames are made in two sections so pivoted together that the traction members are somewhat flexible in order that the traction device may better adhere to an uneven road surface.

The chief features of a crawler tractor are:

(1) A larger area of ground contact than is available under any other principle of construction. Modern 5- and 10-ton machines of full crawler type, i. e., without front steering wheels, have traction members from 10 to 12 inches wide and the length of track in contact with the ground may be as great as 7 feet.

(2) The ground pressure of a crawler tractor is extremely low, ordinarily from 4 to 9 pounds per square inch. This is many times less than the pressure of wheeled tractors, from two to five times less than the ground pressure of a horse, and about the same as the pressure of a man's foot. With "swamp special" shoes, much wider than the standard size, the ground pressure of crawler tractors may be decreased to 2 or 3 pounds per square inch, and the tractor then can go over soft and swampy places where animals could not be used.

(3) The long crawler members enable a tractor to bridge uneven areas, which results in a great economy of power and makes possible the successful use of such a tractor on broken ground, even where there are ditches and deep holes. Wheeled tractors are useless under such conditions.

(4) The ease of steering. Many tractors which are mounted only on two crawler devices may be turned as sharply as desired and turned around almost within their own length. This is done by the application of the driving power forward or backward to one of the traction members while the other one is slowed down by braking, released, or completely stopped.

(5) Crawler tractors, due to their better contact with the ground, deliver a larger per cent of motor power to the draw-bar than wheeled tractors. The difference in favor of the crawler

type increases as the road surface becomes worse. The somewhat complicated construction of the crawler traction device is its only disadvantage as compared to wheeled tractors.

Modern crawler-type tractors are driven by internal combustion motors, and those used in logging may be divided into two groups, namely, the "full crawler tractors" or those mounted only on two traction members, and those having the front part of the machine supported on a pair of sleds for snow and iced roads or on steering wheels.¹

The tractors of the last group require fairly good logging roads; hence they are not practical for skidding purposes. They often are used by loggers in the Northeast, both for hauling timber and for carrying supplies to the camps. Crawler tractors with steering wheels or sleds, have approximately 40 H. P. on the draw-bar, a speed ranging from 2 to 6 miles per hour, and weigh about 10 tons. Although they are used chiefly for draw-bar work they also have a platform about $5\frac{1}{2}$ by 9 feet in size on which a portion of the load may be carried. In New England and eastern Canada these machines have largely superseded steam log haulers which had about 100 draw-bar H. P., a working speed of about $4\frac{1}{2}$ miles per hour, and a weight of approximately 18 tons.

"Full crawler tractors" are the type best adapted to logging because they are not handicapped by front wheels or sleds, and they are suitable for work both on very poor roads and on the forest floor. The great flexibility of these machines, which is important for work on uneven surfaces, is provided by an independent, though limited, vertical oscillation of the traction members, and also by the "three point" suspension of the body, the front part of which is pivoted to the middle of the cross equalizing bar, the ends of which rest on the frames of the crawler members. Spiral springs are commonly used for better cushion.

Obstacles, such as stumps and stones, from 12 to 18 inches high, may be readily overcome by crawler tractors.

Full crawler tractors may be divided into three classes, according to size, typical machines for each group having the following power:

¹ The crawler tractor with a single steering wheel is not adapted for logging though formerly it was occasionally used.

2-ton tractors	20	rated brake H. P.	12	rated draw-bar H. P.
5-ton	“	30-40	“	18-25
10-ton	“	60	“	40

The motors have four four-cycle vertical cylinders, which have a normal speed ranging from 700 to 900 R. P. M. Many tractors have three speeds, low from 1 to 2 miles, medium from $2\frac{1}{2}$ to $3\frac{1}{2}$, and high speed from 4 to 6 miles per hour. Speed is varied in much the same way that it is on motor-trucks. Full crawler tractors have no differential. Two steering clutches of multiple disc, dry-plate type, provide independent and positive control of each traction member.

The consumption of gasoline in logging operations, per working day of 10 hours, averages from 8 to 11 gallons for a 2-ton, from 15 to 25 gallons for a 5-ton, and from 25 to 35 gallons for a 10-ton tractor. Gasoline is used as a fuel in most cases, since it is often impractical to burn cheaper liquid fuel, even in tractors which could use it, because the life of the motor is decreased and cylinder oil costs are greater.

The lubricant expense usually does not exceed from \$1.50 to \$2 daily for a 5- or 10-ton tractor. Anti-friction bearings are extensively used in these machines. Crawler members are well adapted for work in mud, and their flexible track requires no lubrication.

The useful life of a tractor on a logging operation is from 3 to 5 years when it is used continuously. The depreciation and maintenance charges vary widely with the conditions and character of work, the care received and the make of the tractor. Repair bills may be from \$2 to \$4 a day, especially when a crawler tractor on a logging job is operated by a man who is not sufficiently skilled to handle intricate machinery. The care of tractors at the camp and minor repairs often are made by the drivers, but when there are three or more machines at one camp, an expert should be employed to do this work.

Skidding in open forests may be done with crawler tractors without any preparation of the roads. In dense forests the roads are of the same type as those required for animal logging. Timber is skidded by tractors often in long logs or in tree lengths and are cross-cut at the landing because the efficiency of skidding as well as of cross-cutting is increased. Skidding in tree lengths may be facilitated also, to some extent, by felling trees with the tops

in the direction of skidding in case they are to be dragged on the ground, or in the opposite direction if long logs are skidded with the front end resting on some form of a log carrier. Dragging is rarely practiced for distances exceeding $\frac{1}{4}$ or $\frac{1}{2}$ mile. However, in the Appalachian and other mountainous regions, a number of logs may be coupled together in a "turn" and dragged by tractors for long distances on skidding roads.

Log carriers supporting only the front ends of the logs, and



Photograph by A. Koroleff.

FIG. 60. — A 10-Ton Holt Caterpillar Tractor drawing Logs loaded on a Caterpillar Bummer. Idaho.

having a capacity of from 2000 to 4000 board feet are used in tractor skidding to suit different conditions and seasons of the year. Various types of bummers, dollies, trailers, go-devils, and big wheels, which differ from those used in animal logging chiefly in their stronger construction and larger capacity, also are used. Bummers of the crawler type are preferred when hauling on soft or swampy bottom, or when hauling very heavy loads on bad roads. They usually are of all-steel construction and have two free-running crawler-type members of comparatively simple construction, and a single or double bunk. The usual

capacity is from 10 to 15 tons, and the weight from 2 to 3 tons. When timber is moved for comparatively long distances the logs usually are loaded on wagons of greater capacity and strength than those used for animal draft. Several wagons constitute a load or train for one tractor.

Although cable skidding by tractors has not passed the experimental stage, some machines are provided with a winch attachment



Photograph by A. Koroleff.

FIG. 61.— Loaded 4-wheeled Log Wagons pulled by a 10-Ton Holt Tractor (left), and a Tractor with Empty Wagons returning to the Skidway (right). Idaho.

for bringing logs out of hollows and swamps, and for other conditions where better work can be done with a cable than with a direct draw-bar tractor pull. Some crawler tractors have a two-drum winch in order to make possible the mechanical out-haul of the skidding cable. The speed of the cable, when skidding, is from 100 to 200 feet per minute, the larger drums having a maximum capacity of 800 feet of $\frac{3}{8}$ -inch cable. The winch on a tractor also may be used for loading timber, for clearing and scraping work in road construction and for stump-pulling.

When logs are loaded from a yard, a gin-pole may be used, while logs that have not been assembled at one place often are loaded by means of a crosshaul or by rolling them by hand methods upon the vehicle over skids. Animal power is used chiefly for operating the gin-pole and crosshaul, although some tractors are provided with a loading winch. The use of a tractor for loading is seldom as profitable as some other method because the greatest efficiency is secured from the machine when it is kept running continuously over the roads.

The rolling resistance of a given road varies widely with its quality and condition and the load which the tractor can move may be influenced greatly by the type of vehicle, if any, which is used to support the logs. Thus on smooth hard roads, a tractor can haul two or three times more volume of logs on wagons than it can drag on the ground, while the reverse may be true on an uneven or wet bottom because of the inequalities of the ground surface and the sinking of the wheels in the earth.

There are so many types of tractors used by loggers and the period for which they have been used has been so comparatively short that reliable standards of average output are not available. The following table, however, will give an approximate idea of the maximum loads in tons which tractors can move under given conditions.

The average speed of crawler tractors when hauling timber, is approximately 3 miles per hour while the speed without a load is from 4 to 6 miles. On long hauls tractors may cover from 35 to 40 miles in 10 hours when not delayed at the yard landing. The daily mileage of tractors on short hauls, especially in skidding, is much less than on long hauls due to the increase in the time lost at the loading and discharging points.

The relative efficiency of tractors as compared to animals depends on many factors.¹ Other conditions being equal, the horse has advantages over the tractor in work which is not tiresome and which only occasionally requires a short and powerful effort, while the opposite is true on long hauls and on continuous adverse grades. As compared to a tractor, animals are handi-

¹ See *Tractor Skidding in the Inland Empire* by Frank J. Klobucher, *The Timberman*, July, 1922, pp. 114, 116, and 118; also *Tractor and Horse Skidding in the Inland Empire* by James W. Girard, *The Timberman*, Nov., 1922, pp. 66, 68, 70 and 72.

TABLE VII
APPROXIMATE MAXIMUM TRACTIVE POWER OF CRAWLER
TRACTORS¹

Character of road surface	Average rolling resistance of level road in lbs. per ton	Approximate gross load in tons which a 5-ton crawler tractor with actual draw-bar H. P. 25, can move at low speed — 2 miles per hour				Approximate gross load in tons which a 10-ton crawler tractor with actual draw-bar H. P. 40, can move at low speed — 2 miles per hour			
		Adverse grade, per cent							
		Level	5	10	20	Level	5	10	20
Earth road..	150	31	17	11	5	49	25	15	6½
Deep sand or wet clay	350	13	9	7	3½	21	14	10	4¾

¹ These values are computed in the following manner, and the same method may be used in approximating the tractive power for speeds other than 2 miles.

Example: Type of bottom, earth road. Grade 10 per cent. Resistance per ton; rolling 150 pounds, axle 4 pounds, grade $20 \times 10 = 200$ pounds, total 354 pounds. Grade resistance of a 10-ton tractor on a 10 per cent grade, $20 \times 10 \times 10 = 2000$ pounds. Draw-bar pull (pounds) of a 40 horse power tractor = $\frac{40 \times 375}{2} = 7500$. (The value 375 is obtained as follows:

$$\frac{33,000 \times 60}{5280} = 375$$

in which 33,000 represents foot pounds per minute per horse power; 60 equals minutes per hour, and 5280 equals feet per mile.) The net draw-bar pull of a 40 h. p. tractor at a speed of 2 miles per hour equals 7500 — 2000 or 5500 pounds. The gross load in tons equals $5500 \div 354$ or $15\frac{1}{2}$ tons. If vehicles weighing 2 tons each are used with tractors in hauling timber weighing 5 pounds per board foot, then on a 10 per cent grade a 40 horse power tractor can haul 4600 board feet on two vehicles, $\left(\frac{31,000 - 8000}{5} = 4600\right)$.

capped where they cannot get proper footing, such as on loose ground and in swamps, and also in heavy work when several animals must be used together, since much energy is then wasted, due to lack of simultaneous action. The expense of feeding animals when idle, their lower average speed, limited working period, and the necessity for hiring animal drivers, also are disadvantages connected with the use of animal draft. Studies of logging operations where horses and tractors work under identical conditions indicate that the ratio between the efficiency of horses and tractors varies within wide limits, although in most cases, in hauling, one horse is equivalent to two or three tractor draw-bar H. P. This is due chiefly to the ability of a horse to

increase its pull for a very short distance and for a very brief period from three to four times its normal for continuous work, while the margin between the rated draw-bar H. P. and actual maximum for tractors is comparatively insignificant.¹ On the other hand, a tractor develops its normal power for any length of time while animals, especially under adverse conditions, become fatigued, and then decrease their pull below normal in addition to utilizing a part of the working time for rest.

Large tractors are preferred to small ones, provided they can be worked to capacity, because one driver has control over more power, and the wage cost per thousand board feet is less. However, there are about as many 5-ton as 10-ton tractors used in logging and some loggers believe they are more efficient for comparatively short distances. The 2-ton crawler tractors, though sometimes used in the forest, are too small for most kinds of logging work.

BIBLIOGRAPHICAL NOTE TO CHAPTER XIII

BRIGHAM, E. J.: Tractor Logging. *The Timberman*, Oct. 1920, pp. 86 and 87.

GIRARD, James W.: Tractor and Horse Skidding in Inland Empire. *The Timberman*, Nov., 1922, pp. 66, 68, 70 and 72.

KLOBUCHER, Frank J.: Tractor Skidding Studies in the Inland Empire. *The Timberman*, July, 1922, pp. 114, 116, and 118.

¹ A test of tractors at the University of Nebraska showed that some of the best crawler tractors may be overloaded 30 per cent; in actual work, however, crawler tractors will not develop much more than their rated power, and in any case this margin is very small as compared to a possible 300 per cent increase of pull by a horse.

CHAPTER XIV

POWER SKIDDING¹

The first patent on power skidding machinery in the United States was granted on November 13, 1883, to Horace Butters of Ludington, Michigan, and covered an overhead cableway designed to get logs out of "pot holes" and swampy places in the white pine forests. The power for operating the machine was supplied by a 8 $\frac{1}{4}$ -by 10-inch 3-drum pile driver, and the cables were of manila rope. Perceiving the feasibility of using a machine of this type in the cypress forests of North Carolina, the inventor built a machine which had the spar and other equipment mounted on a scow which was floated in the bayous and sloughs. It did not completely solve the loggers' problems since it was limited to a range of from 700 to 800 feet and consequently could not reach much of the timber.

In 1889, William Baptist put a ground system in operation in a Louisiana swamp. It consisted of two large drums and an engine and boiler mounted on a scow, from which an endless cable passed out into the forest for a distance of $\frac{1}{2}$ mile. This was later developed into the modern "slack-rope" system now used on pullboats.

A third method called the "snaking system" was a later development in the pine forests of the South.

CABLEWAY OR OVERHEAD SKIDDING EQUIPMENT

Overhead logging systems have been used in the eastern part of the United States for many years and are now extensively used in the Northwest, both for yarding and as a transportation system for bringing logs from the yarding engine to the railroad. In the latter capacity it functions as an aerial tram. The railroad mileage can be reduced by using this method of intermediate

¹ See Logging in the Douglas Fir Region, by W. H. Gibbons, U. S. Dept. of Agriculture, Bul. No. 711, Washington, 1918.

transportation which is of special importance in regions of rough topography where grade construction is costly.

The cableway system is especially adapted for logging in swampy regions where the bottom is too soft for animals; in very brushy sections; on steep and rocky slopes; in taking timber across canyons and gorges, or in bringing it up out of a canyon to a plateau or lowering it into a valley; and in handling dense stands

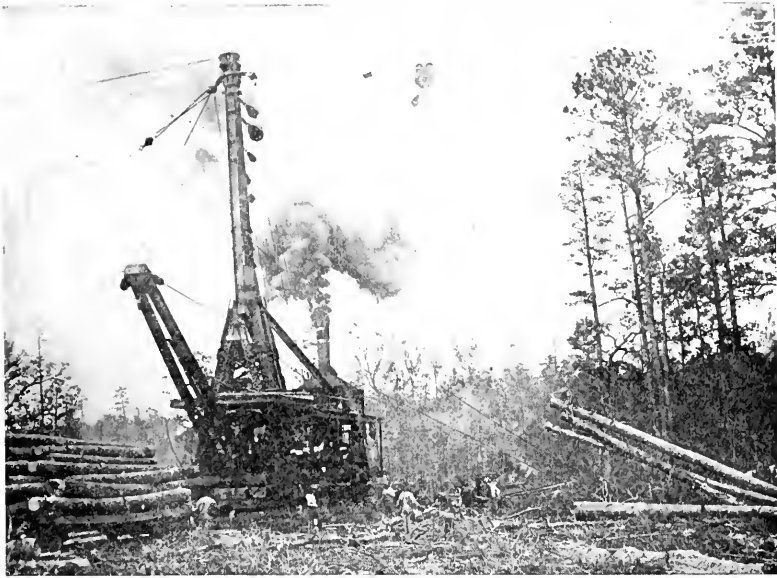

FIG. 62. — A Steel-spar Cableway Skidder operating in Southern Yellow Pine. The loading boom is shown at the left. Texas.

of small- or medium-sized timber, especially when the physical conditions render ground systems difficult and expensive to operate. It is operated to best advantage when the topography is such that logging railroads can be laid out at regular intervals, but it is also used in very rough regions where the railroad must be placed in the valley or at the head of the slope.

Lidgerwood System. — The pioneer overhead system was the Lidgerwood which is the type used chiefly in the East. Western loggers use this method but they also have developed numerous others. This type is built both for short-distance and for long-distance skidding, and may use a tree for a head spar or a steel

boom which may be lowered when the machine is moved from one set-up to another. Some types also are built to operate two overhead lines from one spar. The one which uses a tree for a head spar and which skids for comparatively short distances has a main cable from 1 to $1\frac{1}{4}$ inches in diameter suspended between two supports known as the "head spar" and the "tail spar." These usually are from 600 to 750 feet apart, although spans of 5200 feet have been used in mountainous country. Head spar trees are located along the railroad at intervals of approximately 1000 feet. They are selected by the foreman before felling operations begin, must be straight and sound, and should have a minimum diameter of 18 inches at 60 feet above ground. In order to make the spar more stable the trees are topped before the rigging is placed.

A heavy steel spar mounted on the skidder car now often replaces the head spar tree required by the earlier type and is so constructed that it can be lowered to facilitate moving the skidder from one set-up to another. This spar, for relatively short-distance skidding, is about 75 feet high and is so adjusted that it can be lowered upon the end of the loading boom when the machine is moved from one set-up to another.¹ The machines used in skidding for distances of several thousand feet usually are of a different type. The booms are either cylindrical or square in cross section and the base rests upon the framework of the skidder. When the machine is moved the spar is lowered upon an empty car placed in front. The placement of the blocks, the guying of the steel spar and the adjustment of the main cable after it has been placed on the ground ready for connecting up, requires from 15 to 30 minutes, while a day is needed to take down the tackle, move the skidder, and adjust the blocks on a head spar tree. The great weight of the steel spar skidder makes it unsuitable for use on a light or poorly constructed logging railroad.

Tail trees are selected before felling begins, and should be from 150 to 250 feet apart and at least 18 inches in diameter at 30 feet above ground.

One end of the main cable is passed around the tail tree at a height of 25 or 30 feet and is then carried to a stump or tree in the rear to which it is made fast. The tail tree is braced with

¹ See Fig. 62.

this cable and also with an additional guy rope. The other end of the main cable terminates in an eye near the head spar tree and is connected, by means of a clevis, to an extension cable which passes through a block attached to the head spar tree. The extension cable is fastened to a stump in the rear by a "block and fall" attachment, by which, with the aid of a drum on the engine, the main cable is tightened.

The head spar tree is also braced by cables as shown in Fig. 64.

The trolley which travels back and forth on the main cable is operated by an outhaul rope and a skidding line. The outhaul rope is $\frac{5}{8}$ - or $\frac{3}{4}$ -inch in diameter and passes from a drum on the engine, through a block on the head spar tree, through the trolley and also through a block on the tail tree, after which it is brought back and attached to the rear of the trolley. It serves to draw the trolley out along the main cable. The $\frac{3}{4}$ - or $\frac{7}{8}$ -inch skidding line passes from a drum on the engine, through a block on the head spar tree, then through a block on the trolley. It serves as a point of attachment for tongs or other log-holding devices. The logs are dragged up to the main cable by this line, which

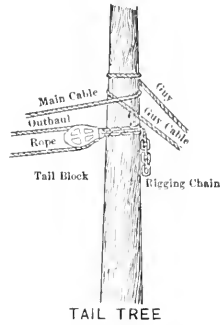
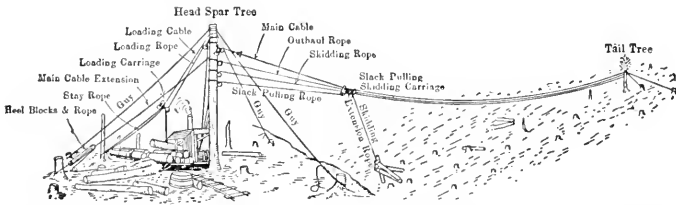

FIG. 63. — A Tail Tree showing the Method of attaching the Blocks to the Tree; also the Arrangement of the Guy Lines.



By permission of the Lidgerwood Mfg. Co.

FIG. 64. — A Cableway Skidder, showing the Arrangement of the Lines for Skidding and Loading.

also suspends them and serves to return the trolley to the head spar tree.

When the trolley is run out from the head spar tree, the skidding line sags between the two points of support and its weight

pulls the tongs against the trolley. The line is run out by means of a $\frac{3}{8}$ -inch slack-pulling line which passes from a drum on the skidder through a block on the head spar tree, thence around a small sheave in the trolley and back in the direction of the head



FIG. 65. — Cutting the Top from a Head Spar on which is placed the Main Cable Rigging for a Cableway Skidder. Cypress Forest, Louisiana.

spar.¹ The free end of the line is attached to a swivel, through which the skidding line passes. A button is fastened on the skidding line between the swivel and the carriage block. When slack is desired, the slack-pulling line is drawn in, which pulls the swivel against the button and draws the skidding line towards the trolley and thus lowers the end of the line to the ground. The distance of the button from the end of the skidding line may be adjusted to give any amount of slack desired. This equipment has replaced the five or six men who were required for pulling slack in the earlier types.

¹ See Fig. 66.

Power for operating the cableway system is provided by a vertical, high-pressure boiler and a pair of engines mounted on a steel frame which is supported on two sets of trucks, each of which is pivoted. The machine is moved from one set-up to another by means of a locomotive. On arrival at the location where it is to be used, the frame is elevated above the rails by hydraulic jacks, the trucks turned in a quarter circle, and a short span of track placed under each truck. The machine is then lowered and shunted off to one side of the railroad by the

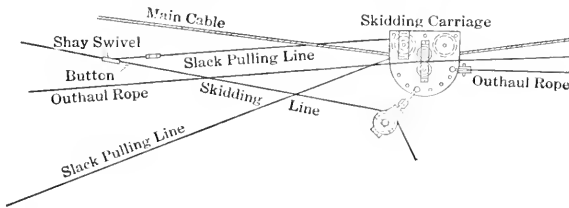

FIG. 66. — The Lidgerwood Skidding Carriage, and the Arrangement of Operating Cables and Slack-pulling Line.

side of the head spar tree, where it is blocked up and remains until the next move is made. This leaves the main railroad track clear for the operation of logging trains.

Some steel spar machines move about under their own power while others are moved on flat cars of special design by a locomotive. In the first case the machine is side-tracked at the set-up so as to leave the main line clear, while in the second case the machine remains on the main line and is elevated above the track by means of hydraulic jacks and each corner is supported on blocks. When the skidder has been adjusted in position, the carrying cars are pushed to the rear of the machine so that empty log cars can be spotted under the loading boom.

The three main drums on the skidder are arranged in a row in front of the boiler. The forward drum handles the slack pulling cable, the middle one the outhaul rope and the rear one the skidding line.

In operation, the outhaul and skidding drums are interlocked, and when the outhaul rope is wound on its drum, the trolley is drawn out towards the tail tree, carrying with it the skidding line and the slack-pulling line. The speed of the outhaul line usually is from 1200 to 1800 feet, although it sometimes is as

high as 3000 feet per minute. When the trolley reaches the point at which logs are to be secured the drums are stopped and the interlocking device freed. When the slack-pulling line is wound on its drum it operates the slack puller which runs out the slack for the skidding line. The latter is then carried to a log, or logs, which are attached to it by tongs or chokers. Logs can be drawn in a distance of from 60 to 75 feet on either side of the main cable by the attachment of short extensions to the main skidding line. When the logs have been pulled in near the main cable the short lines are detached and the logs coupled directly

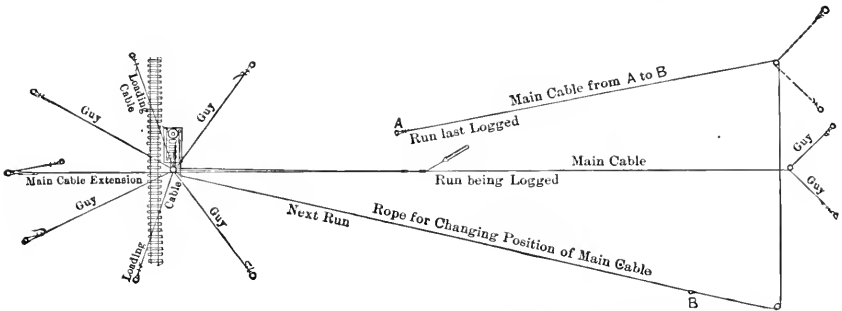

By permission of the Lidgerwood Mfg. Co.

FIG. 67. — Method of Shifting the Main Cable from One Run to Another.

by tongs or chokers to the skidding line, which is then wound in, and the log elevated wholly or partially from the ground. This is accomplished by holding the outhaul in a fixed position by a friction brake, until the log is in the position desired. The skidding and outhaul drums are then interlocked and as the skidding line is hauled in, the outhaul rope runs out, and the log is held suspended. On arrival at the railroad the logs are dropped in reach of a loading cable, and the trolley again returned for another load.

Logging rotates around the head spar tree and from 18 to 22 tail trees are required for each set-up, an area of from 25 to 40 acres being logged from one spot.

When the steel spar skidder is used it is not feasible to log in a complete circle because of the difficulty of operating lines on the rear side of the machine. As a rule, an arc of from 275 to 300 degrees is covered.

In order to prevent the fouling of the cables in very brushy regions it is sometimes necessary to cut runs 5 or 6 feet wide,

extending from the head spar to each tail tree. This work is done a short time in advance of skidding. One man can cut the runs when the brush is of medium size.

Two main cables are used on spans less than 2500 feet. This saves the cable since its ends are reversed at each set up, but when the spans may vary several hundred feet in length, the difficulty of taking care of the surplus cable on the shorter hauls is a drawback. While one main cable is in use, the rigging crew, three men, is at work preparing the new tail tree and placing the extra main cable in position on the next run. When the timber available to one run is skidded, the main cable is dropped to the ground and disconnected from the main cable extension; the trolley is placed on the new cable, which is then connected to the cable extension, and the whole drawn taut for operation. It requires from 15 to 30 minutes to make this change. The rigging crew then proceeds to transfer the extra main cable to the next run. A block is placed on the new tail tree and a $\frac{3}{8}$ -inch cable is dragged from the engine out over the new run, either by hand or by a horse. It is then passed through the block on the new tail tree, and finally through a block on the tail tree just abandoned. The end of the small cable is attached to the main cable and by winding the former on a drum of the engine, the main cable is dragged around into the new run, having reversed ends. It is then made ready for use by attaching it to the tail tree.

A different procedure is followed in mountainous regions in which the length of span may vary greatly. One main cable only is used and this is carried on a reel drum on the skidder. This drum is actuated by a special compound-gearred tensioning engine having two speeds, high for pulling in the main cable when runs are changed and low for tightening and tensioning the main cable. The drum capacity on the longest range machines is 5200 feet of $1\frac{1}{2}$ main cable, when a relay system or a support-passing trolley is used. The relay method was introduced about ten years ago in the Appalachian region to log hollows and other places which were not accessible with single spans and to reach which would require a prohibitive cost of railroad construction. An intermediate tree spar was selected on the ridge top that was to be crossed, or at some convenient point in the cove that was to be logged.¹ The main cable and

¹ See Fig. 68.

the skidding lines were then run from the skidder to the tail tree, the former being supported on the intermediate spar tree. The carriage was placed on the main cable between the tail tree and the intermediate spar and the logs were then skidded to the latter. When the area between these two supports had been logged, the trolley was shifted to the skidder side of the intermediate spar and the logs then brought to the railroad. Timber beyond the reach of the tail tree sometimes was skidded to it



FIG. 68. — A Logging Chance showing the Use of an Overhead Cableway System in bringing Timber over a Ridge by relaying

by animals and the range of the machine thus greatly increased.

A special type of trolley which can automatically pass the support on the intermediate spar has been put on the market and does away with the necessity of relaying the logs. The trolley has two track sheaves which ride on the main cable. Under each main sheave below the cable there is a smaller and wider sheave which is mounted on a pivoted arm which, by tension, holds the lower sheaves directly under the carrying sheaves. This prevents the trolley from leaving the cable. The support at the intermediate spar is triangular in shape, the base of the

triangle being attached to the under side of the cable and the support being attached to the side of the triangle next to the spar. When the trolley reaches the intermediate support, the lower sheave follows along the side of the triangle to the apex and in so doing widens the distance between the upper and lower sheave so that the trolley will pass the hanger. As soon as the latter is passed the two sheaves come together and close the gap. Since the trolley is longer than the cable support on the intermediate spar, both top sheaves are not on the support at one time and, therefore, it is impossible for the trolley to leave the cable.

The crew for operating a cableway skidder with a slack pulling device consists of 13 or 14 men, as follows:

1 skidder leverman	1 head rigger
1 fireman	2 rigging helpers
1 tong hooker	1 tong unhooker
1 or 2 helpers	1 run cutter
1 signal man	1 loading leverman
1 top loader	1 ground loader

The daily output of the Lidgerwood type of skidder in the cypress region is from 35,000 to 40,000 feet, in the Northwest from 50,000 to 80,000 feet, in the mountains of West Virginia on long spans from 30,000 to 35,000 feet, and when used as a relay system from 25,000 to 30,000 board feet. These figures are averages only, since the output is influenced to a marked degree by the size and density of timber, the length of span, and the topography of the country.

*MacFarlane System.*¹— This was developed in the West primarily for logging steep slopes, up or down which logs could not be successfully taken by the ground methods in general use. It has been used successfully for yarding when the span was 2500 feet. It is also now used for logging in rolling country and to move logs from the ground and high-lead yarders to the railroad, a process known as "swinging."²

This system uses a $1\frac{1}{4}$ - to $1\frac{3}{4}$ -inch main cable which passes from a drum on the engine up to and through a block in the head spar, thence to and through a block on the tail spar tree, the end

¹ See *Logging in the Douglas Fir Region*, by W. H. Gibbons. U. S. Dept. of Agriculture, Bul. No. 711, and *The Timberman*, April, 1911, p. 49, and May 1912, p. 27.

² See page 245.

being fastened to a stump at the rear. Both the head spar and tail spar tree are guyed with four lines.

The trolley or carriage is triangular in shape with two 16- by 3-inch sheaves; with a clevis at the apex to which chokers are attached; and also with a clevis on each edge of the block to which the haul-back and haul-in lines are attached. The trolley is drawn towards the head spar by means of a haul-in line which passes from a drum on the engine up to and through a block

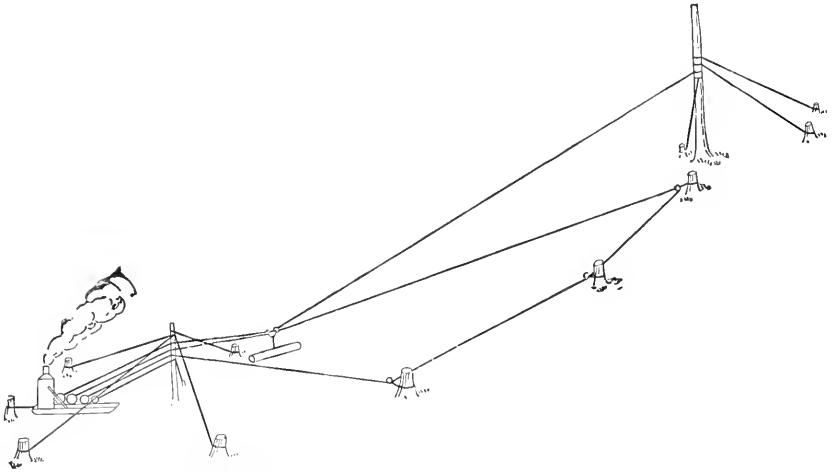

FIG. 69. — The MacFarlane Skyline System of Overhead Power Logging.

on the head spar and is then fastened to a clevis on the side of the trolley next to the spar tree. The trolley is drawn out towards the tail tree by means of a haul-back line which leads from a drum on the engine, through blocks placed at one side of the run, to a block on the tail tree or to some other convenient point of attachment, and is then brought back and fastened to a clevis on the side of the trolley next to the tail spar tree.

When skidding is in progress the main cable is pulled taut, and the trolley drawn out to the desired point by means of the haul-back line. The main cable is then slacked off until the trolley is lowered to the ground. The trolley and main cable are then dragged to the log if it is at one side of the center of the run. When the log has been fastened to the trolley by means of chokers, the main line is tightened and held in place by powerful drum brakes and the log brought to the head spar tree by the haul-in

line, where the log is lowered to the ground by slackening the main cable. As logging progresses the outer block through which the haul-back line passes is changed so that the trolley and main cable always can be pulled away from the center of the run. Logs may be successfully side-lined for 150 feet.

More power is needed to elevate the logs than is required in some other overhead systems, since both the weight of the main cable

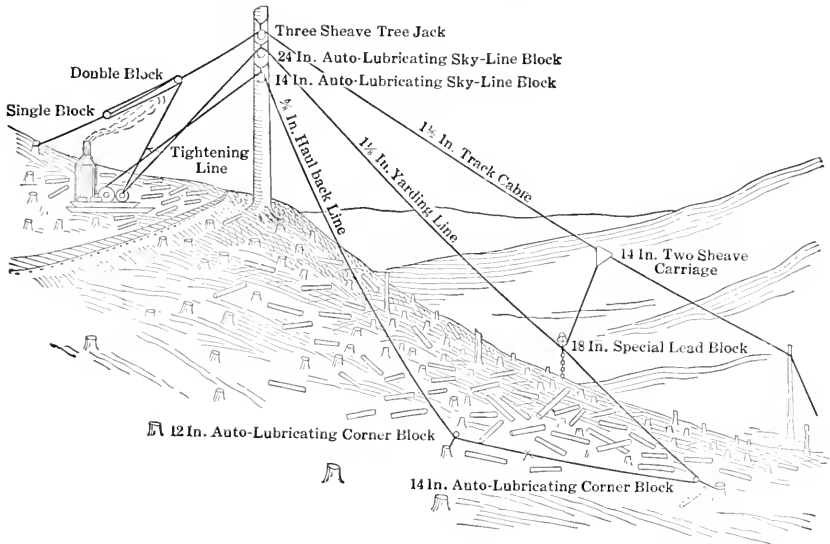

From Bul. 711, U. S. Dept. of Agriculture.

FIG. 70. — The North Bend System of Overhead Logging.

and of the logs must be raised. The daily capacity of a machine of this type is from 50,000 to 100,000 board feet, depending upon slope conditions, log size, and length of span.

Previous to a change in runs, the tail tree spar in the next run to be logged is chosen and properly guyed. When logging on one run is completed the main cable is pulled to the head-spar tree. One end of the haul-back line is then attached to a small cable, called a straw line, which has previously been pulled out over the new run and when the straw line is pulled in, the haul-back line is drawn out through a block on the tail spar tree and back to the head spar.

*North Bend System.*¹ — This is used both for yarding and for

¹ See Fig. 70.

swinging. The standing line either is stretched between a head spar and a tail tree with the ends anchored to stumps, or it leads from a drum on the engine to a block on the head spar and thence to the tail tree, behind which it is anchored to a stump. When the latter method of supporting the standing line is used, a block purchase is needed to relieve the strain on the engine.

The standing line ranges in size from $1\frac{1}{4}$ to $1\frac{1}{2}$ inches, depending on the length of span and the maximum size of the logs handled. A $1\frac{1}{4}$ -inch line has proved large enough for spans of 1500 feet and for logs containing 2000 board feet.

The trolley has two 14-inch sheaves, with a clevis on the lower end to which the skidding line is attached. This line usually is $1\frac{1}{8}$ inches in diameter and its length is dependent both on the length of span between the head spar and the tail tree, and on the distance logs are yarded on either side of the standing line, which may be from 150 to 200 feet.

The haul-back or trip line is $\frac{5}{8}$ - or $\frac{3}{4}$ -inch in diameter and passes from the drum on the engine, through a block on the head spar, then through blocks placed on the edge of the skidding area to a corner block near the logs which are being yarded, thence to a fall block placed in a bight of the skidding line. The corner block is so placed that the fall block, to which both the haul-back line and the butt chain are attached, can be drawn to any point where a log is to be secured.

The engine used most successfully with this system is similar to that for the MacFarlane. The usual capacity of the skidding line drum is 2700 feet and that of the haul-back line drum 3500 feet. The yarding speed is 600 feet and the return speed for the haul-back line about 1500 feet per minute.

*Duplex Aerial System.*¹ — This is used both for yarding and for swinging. Two separate engines, mounted tandem and combined in one unit furnish the power. The forward engine operates the skidding, haul-back and straw-line drums, and the rear engine operates two sky-line drums on which the ends of the overhead line are reeled. The sky-line and skidding drums have two speeds which can be changed instantly and the haul-back line also is geared to a high speed so that the machine can be operated faster than ground systems.

The sky-line consists of a double cable on which the trolley

¹ See Figures 71 and 72.

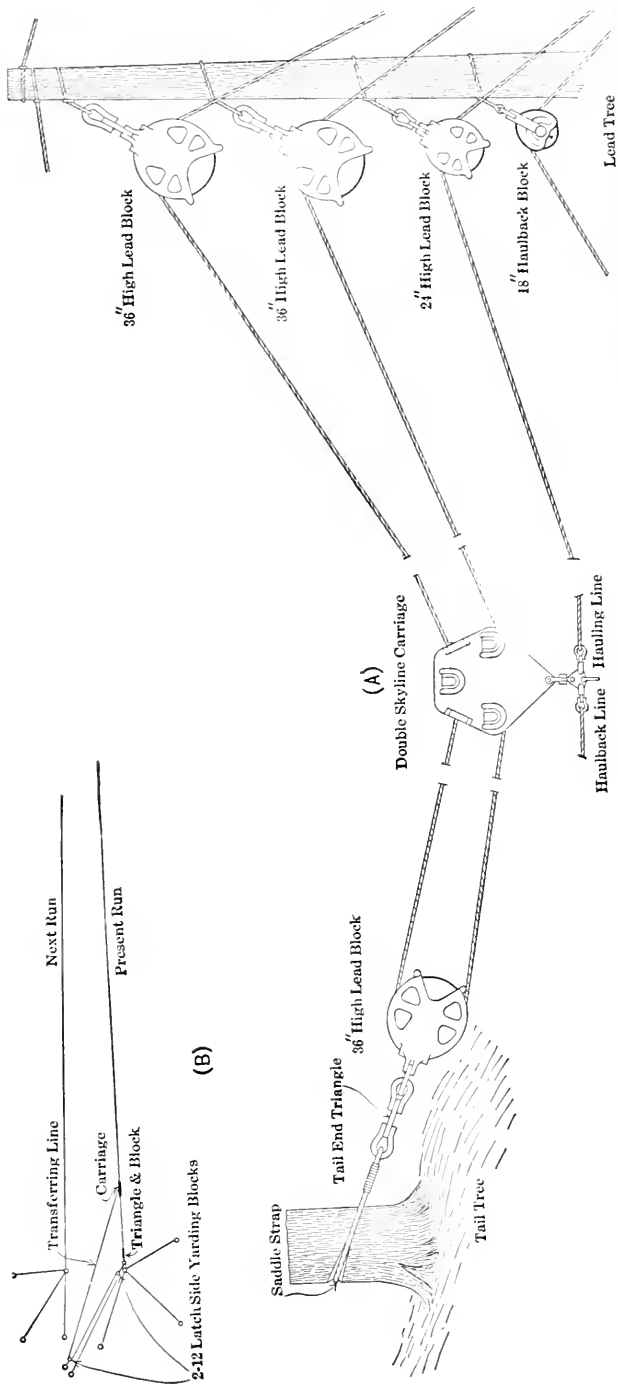

By permission of the Washington Iron Works.

Fig. 71. The Arrangement of the Blocks and a Method of Changing Runs for the Duplex Aerial Yarding System.

travels. One end of the line is fastened to one of the drums and then passes up to and through a block on the spar tree, thence to and through a block at the end of the run, thence back to and through another block on the head spar tree and then down to the other sky-line drum (Fig. 71A). The tail block is fastened to the tail spar tree as shown in Fig. 71A. When used as a yarding machine on uphill or downhill pulls or on level ground the

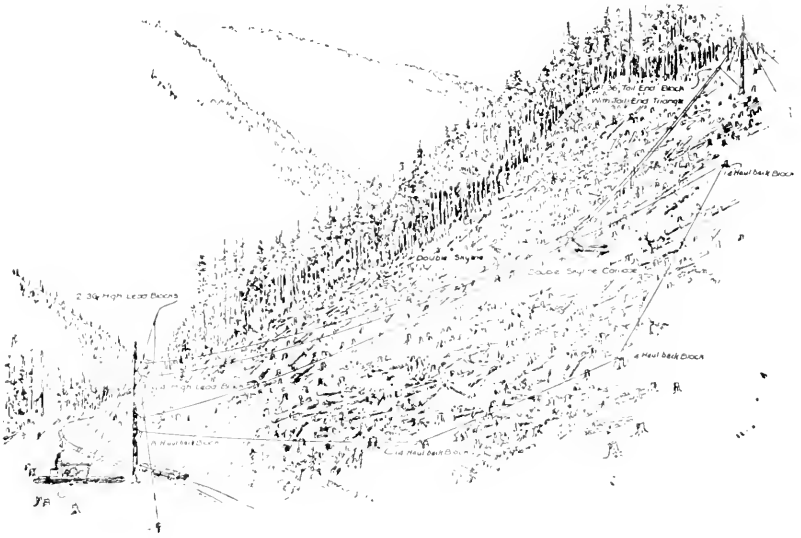

FIG. 72. — A Duplex Aerial Yarder logging a Steep Slope from a Setting in the Valley.

haul-back line block is fastened to a stump near the logs to be skidded, the line serving as a slack-pulling device when the sky-line is lowered. When yarding in deep canyons, the haul-back block is placed near the tail spar and the trolley is run out to the desired spot, the sky-line lowered and the chokers attached to the trolley. The general scheme of arrangement of cables for side-hill logging is shown in Fig. 72.

This system may be used for spans from 700 to 5000 feet. The longer distances may be used when crossing canyons where a suitable cable deflection may be secured. The output per day may be as high as 100,000 board feet.

*Other Systems.*¹—There are numerous other systems of overhead skidding which have been developed in the Northwest, which differ only in minor details from each other. Some are used for yarding purposes and others for “swinging” or “roading” logs. They were first developed to solve some particular logging problem of an individual operator and the early types were designed to utilize available ground-yarding power for their operation. Later improvements have led in some cases to the use of a special design of power and certain other working parts which have made the systems more efficient.

THE SNAKING SYSTEM

This is a ground system in which the cables are taken to the logs by animals.

It has a vertical, high-pressure boiler with two, three or four independent skidding drums mounted either on a heavy steel frame and trucks or on a steel frame which is supported at the corners on legs or “spuds.” The first type is transported under its own power by a chain drive, and the latter type during transit rests on a flat car which is drawn by a locomotive.

The machine has a heavy pulling boom at one or both ends of the frame, from the peak of which blocks are suspended through which the skidding lines pass. The pulling booms are guyed on either side to give them rigidity.

Self-propelling snaking machines are not equipped with a loading device but are supplied with a decking cable by means of which logs may be piled up along the track ready for a special loading crew.

When the snaking machine is not transported on its own trucks, it is equipped with a loading boom and the logs are loaded on cars as they are skidded. The machine is elevated above the flat car by means of hydraulic jacks and then the corners are blocked up. The log cars are run under the skidder when they are brought to the woods and are pulled forward under the loading boom by means of a “spotting” cable as required for loading. The skidding cables are single lines which are carried

¹ See *Logging in the Douglas Fir Region*, by W. H. Gibbons, U. S. Dept. of Agriculture, Bul. No. 711 for a description of some of these systems. Some overhead equipment, used chiefly or solely for swinging, is described in Chapter XIV.

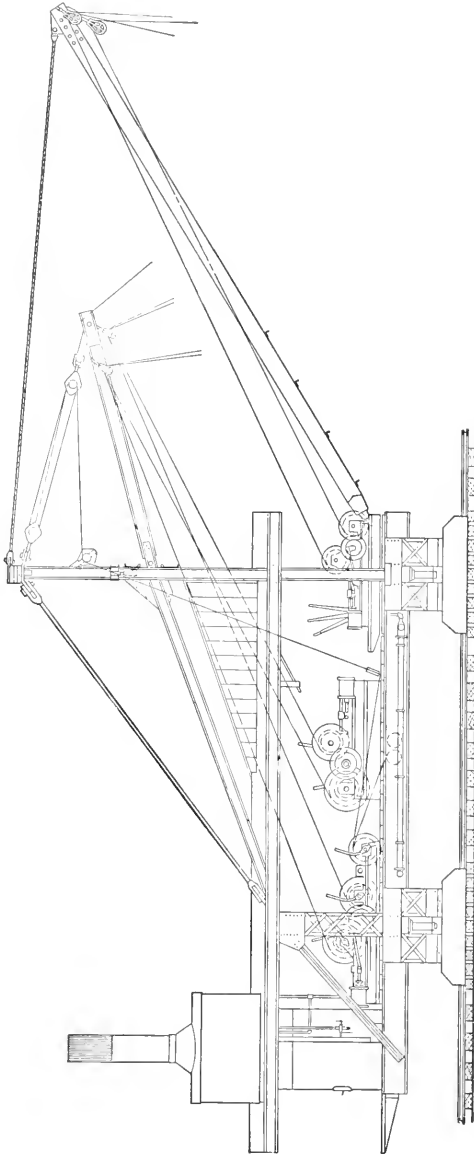

FIG. 73. — A Four-line Lidgerwood Ground Skidder and Loader.

by a mule or horse to the log to which they are attached by a pair of tongs or a choker and then drawn in. The animal is ridden back to the machine and after the cable has been detached

from the log, returns the line for another log. Runs or trails are not cut.

The railroads are laid out in more or less parallel lines from 1200 to 1400 feet apart and the timber is logged halfway back from each side of the track. The road often is placed on the higher ground because a better drained track can be secured and the timber can be pulled up hill as readily as down.

A practice sometimes followed is to fell the timber in two strips beginning on the back edge of the area and cutting a section from 300 to 400 feet wide. This is skidded before the timber on the next strip is cut. The ground is thus kept free from débris and the timber can be drawn in easier than where there is slash to interfere. Trees are seldom felled with reference to the location of the railroad track although skidding of long logs is simplified if they are thrown away from the direction in which they are to be pulled, because the top then offers the least interference. The necessary swamping is done by the sawyers at the time the timber is felled.

A crew of seventeen or nineteen men and nine animals, either horses or mules, is necessary for a four-line machine.

1 foreman	2 levermen
1 fireman	2-4 tong unhookers
4 tong hookers	4 riders
1 wood chopper	1 wood hauler
1 night watchman	

The foreman of the crew has general supervision of the operation and often acts as the leverman on the loading engine, when the skidder is equipped with one. Each leverman operates two drums on the skidder. The fireman performs the usual duties. The tong unhookers are stationed at the machine and detach the tongs or chokers from the logs as they are dragged in, and attach the cable to the single-tree for hauling back to the next log; they also may act as signalmen, transmitting orders from the tong hookers at the stump to the levermen. The tong hookers attach the tongs or chokers to the logs, swamp an occasional limb when necessary, and control the speed of the log by signals to the leverman. The riders, usually negro boys, ride the animals from the machine to the next log. The animals drag the cable to the desired point and then are brought back to the machine to repeat the process. The wood choppers and haulers cut and

supply fuel for the boiler. The night watchman guards the machine at night, cleans up, and raises steam in the morning ready for the crew.

If the skidder is equipped with a loader boom and engine the following extra men are required:

- 1 loader leverman, usually the crew foreman
- 1 top loader
- 1 ground loader

The top loader chooses the logs to be loaded and, standing on the car, directs their proper placement on the load. The ground loader places the loading tongs on the logs to be loaded, acting under the orders of the top loader.

Eight animals are used for skidding, four being worked from one to two and one-half hours and then allowed to rest while the others are in use. The ninth animal is used to haul the wood cart which transports fuel for the engine.

The daily capacity of each line is about 35,000 board feet, with a daily average of 125,000 feet for a 4-line machine, where logs up to 40 feet in length are handled. Daily records of 4-line machines, bringing in whole trees, have run as high as 295,000 feet. This amount, however, cannot be approximated as an average even under favorable circumstances.

Snaking machines are adapted to logging open stands in fairly level or rolling country, free from swamps, rocks, gullies and heavy underbrush. The heavy slash which results from dense stands and unfavorable ground conditions interfere with the return of the lines from the machine to the stump by animals

THE SLACK-ROPE SYSTEM

This was developed chiefly in the cypress swamps of the South, where extensive areas of forest could not be logged with animals, and where railroad construction was not practicable. It is also extensively used on the Pacific Coast and in the southern pineries and to a limited extent in some other regions.

The system uses a heavy pulling cable, and a lighter one for returning the main cable from the skidder to the point from which the logs are to be dragged.

The power for the slack-rope system consists of an upright boiler, and two or more large drums driven by one or more pairs of engines.

Pullboats. — In the cypress forests, the slack-rope skidder is mounted on a scow, and the machine complete, consisting of an upright, high-pressure boiler of from 60 to 80 horse-power with two engines operating two main drums and usually a third small drum, is called a pullboat. The large drums are placed tandem, one having a capacity of from 3000 to 4000 feet of from $\frac{7}{8}$ - to $1\frac{1}{8}$ -inch main cable, and the other at least twice as much $\frac{5}{8}$ -inch messenger cable. An equal amount of $\frac{3}{8}$ -inch line is wound on the small drum and is used to pull out the messenger cable when runs are changed. Four rings are spliced at 50-foot intervals to the main cable near the outer end and to these the chain and cables holding the logs are coupled.

Pullboats are anchored in canals, bayous or lakes and the roads radiate or "fantail" in a half circle for a distance of from 3000 to 3500 feet, although some of the larger machines can be operated for 4500 feet. Distances in excess of 3500 feet are not desirable because breaks in the cable are more or less frequent and on very long hauls the loss of time in locating and repairing them is excessive.

The canals, dug by large dredges, are from 40 to 50 feet wide, and about 6 feet deep and often are several miles in length. Although at first intended solely for logging purposes, some canals in recent years have been built with the idea of ultimately using them for drainage purposes. The early operators had difficulty because they started to use the canals from the mill end, and so much débris and mud was drawn into the water, that frequent dredging was necessary to keep the channel open. The practice now is to dig the canal and then to begin logging at the far end, working toward the mill. Log barriers also are used, which prevent most of the refuse from falling into the canals.

Pullboats operated from the shores of lakes or from wide bayous are moored to nests of piling driven off-shore, and the timber usually is pulled in straight lines.

In laying out a pullboat job it is necessary to locate and cut out main and secondary roads down which the logs are dragged to the canal or bayou. The foreman may locate the main and secondary roads on a map in the office before going to the field, and determine the points on the boundary at which roads will terminate, and the angle at which they should run toward the pullboat. The far end of the cable passes through a sheave

block fastened to a tail tree. These are 150 feet or less apart because logs cannot readily be side-lined for distances greater than 75 feet. After determining on the map the approximate location of the tail trees the foreman starts at some known point along the boundary, paces off 50 yards, selects the nearest suitable tail tree, and blazes it so that it will not be cut by fallers. He thus proceeds entirely around the tract. After the tail trees are

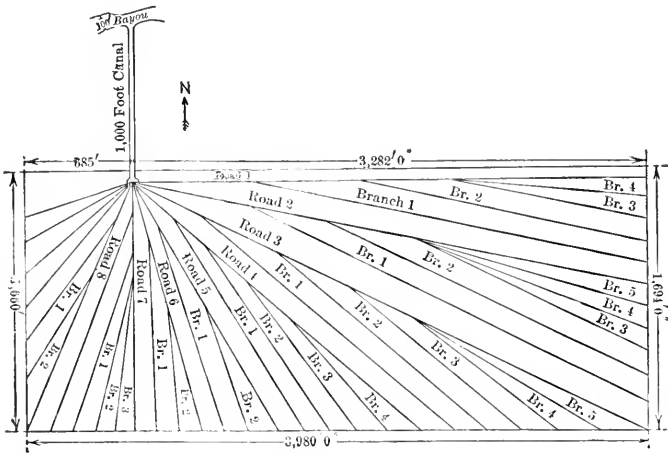

FIG. 74. — The Arrangement of the Roads down which Logs are dragged to the Pullboat. This system is known as fantailing. The figure is adapted from an actual operation in a Louisiana cypress swamp.

spotted, the route of the roads is blazed out from the boundary towards the pullboat. On the completion of the work the roads will radiate out from the skidding center in the manner shown in Fig. 74.

The advantage of this system over the "every road a main road" method is that it greatly reduces the mileage of runs and is, therefore, much cheaper. The roads must be well cleared out, otherwise the logs will catch on stumps and other obstructions and cause numerous delays. They are usually cut by contract at a stated price per 100 feet of road, with a further payment for each merchantable tree felled and cut into logs. One man will cut from 60 to 500 feet of road daily, depending on the number of trees to be cut, number of stumps to be removed, and the amount of rubbish on the ground. Workmen regard

road building as one of the more profitable forms of work in the eypress forest.

After the roads have been cut and the timber felled, the logs are prepared for pulling by a "sniping" crew, which may work by the day or by contract. The duty of this crew is to "snipe" the forward ends of the logs, bore two opposite 2-inch holes about one foot from the forward end of the log, and swamp out a trail



FIG. 75. — A Sheave Block attached to a Tail Tree on a Pullboat Operation. Note the method of supporting the block; also the cross on the tree which denotes its selection as a tail tree.

so that the log can be dragged to the main road. A four-man crew will prepare from 75 to 100 logs daily.

A pullboat having moved to a skidding site, the main and messenger cables are run out. A sheave block is adjusted at the far end of the road and two $\frac{3}{8}$ -inch cables are carried from the pullboat to the sheave block; one end of the cable is passed through it and the two sections are then joined together. At the pullboat one end of the $\frac{3}{8}$ -inch cable is attached to the messenger

cable and the other end is reeled in on the small drum. This drags the messenger cable out over the road, through the sheave block and back to the skidder. The small cable is then detached and the end of the main cable fastened to the messenger. The pullboat is now ready for operation. When one road has been pulled, it is customary to change only the main cable, leaving the messenger in the first run logged until the distance between the sheave blocks becomes several hundred feet. It then does not get in the way of logs coming down the main road, is less subject to damage, and less time is required in changing runs. In changing from one run to another, the sheave block is left at the head of the first road and another is placed at the head of the next road to be pulled. The $\frac{3}{8}$ -inch cable is carried from the pullboat out over the new road, through the sheave block and then across to the first run where the main cable is detached from the messenger cable, and the latter connected to the $\frac{3}{8}$ -inch line. The main cable is drawn to the machine and, by reeling in the small cable, the messenger cable is pulled over into the new run and along it to the pullboat. The messenger and main cables are again coupled together and the equipment is ready to log the new run. A piece of telephone wire fastened to the whistle on the pullboat is strung along the outer edge of the run and signals are given to the engineer by pulling on the wire. The sheave blocks are usually placed by a special crew before the change is made and the $\frac{3}{8}$ -inch cable is run out by this crew unless the distance is long, when the entire pullboat crew is required. Ten or twelve men can string out 2600 feet of $\frac{3}{8}$ -inch cable in about three hours.

The logs are prepared for skidding by the insertion of plugs or "puppies" in the holes previously bored by the sniping crew. Cylindrical plugs 2 inches in diameter and 12 inches long are connected in pairs by two sections of $\frac{1}{2}$ -inch chain 24 inches long fastened to a 6-inch ring. The plugs are driven into the log and the ring on the plugs is fastened by a short chain to the main cable. The log is now ready to be hauled out to the main road. This requires some maneuvering if there are stumps, logs or trees in the line of the log being hauled. When once the log is dragged into the main run, it is left there until a tow of four logs is secured. Each log is fastened by a short chain or cable to one of the rings on the outer end of the main cable. The boss

then gives the order to go ahead, which the whistle boy transmits to the skidder and the logs start down the road.

During the early periods of modern pullboating a device called the Baptist cone was placed over the ends of logs to enable them to slip over and under obstructions. These cones were made of steel but were too heavy to handle, when made strong enough to withstand the rough treatment and they were abandoned, in favor of sniping. Tongs are not satisfactory because they lose their grip as soon as the draft on the cable is lessened. When a tow that is being dragged down a main road is stopped, as it frequently must be, the tongs drop off and a man must be sent to readjust them. For this reason, plugs or puppies are preferred.

The crew of a pullboat is divided into two sections, one of which attaches the logs to the main cable and the other operates the machinery and rafts the logs.

The woods crew of seven men consists chiefly of negroes as follows:

1 foreman	3 side-line men
1 plug setter	1 whistle boy
1 head hooker	

The plug setter adjusts the plugs or puppies. The side-line men carry the skidding lines from the main run to the logs and connect them with the puppies. The head hooker's duty is to attach the logs to the main cable by short chains. The whistle boy transmits the orders of the boss to the engineer by means of a code of whistle blasts.

The crew at the pullboat consists of five men, as follows:

1 engineer	1 wood-passer
1 fireman	1 deck man
1 rafter	

The engineer and the fireman perform the usual duties. The deck man uncouples the logs as they are brought up to the pullboat, removes the plugs and chains, and poles the logs around to the rafter at the rear. He also attaches the removed chains and plugs to the main cable by which they are returned to the woods crew. The rafter makes the logs up into cigar-shaped raft units about 125 feet long. The wood-passer supplies the pullboat with fuel wood which has been previously cut and piled along the banks of the bayou. A flat boat is used for this purpose. About three cords daily are required for a single boiler.

An average day's work for a pullboat crew is from fifty to seventy-five logs; the output is often less, however, because of cable breakage.

Re-haul skidder. — The slack-rope system has been extensively introduced into the southern pine region in recent years to log timber standing on a bottom unfavorable for the use of animals, such as swampy areas; to log dense stands where the slash is heavy; and also to log open stands in which there is a heavy growth of underbrush. This method is most commonly used in the shortleaf pine region. One common type of re-haul skidder, the Clyde, is self-propelling and is mounted on a special design of steel car. Heavy semi-rigid booms project from each end of the car and from the outer ends of these booms blocks are suspended through which run the various lines needed in the operation of the skidder. Some machines are designed to operate one line from each boom, while others are so equipped that two lines may be operated from each end of the skidder. In some cases, operators convert a four-line snaking system into a two-line re-haul by using one-half of the skidding lines for out-haul lines. Each set of lines requires two drums, one for the main skidding line and one for the out-haul, and if two lines are operated from each end, a double set of drums must be provided. In addition a drum for a straw line, one for a decking line and small drums or thimbles for tightening the boom stays are necessary. The capacity of the drum carrying the skidding line is about 1000 feet of $\frac{7}{8}$ -inch cable, and that of the out-haul drum, about 2500 feet of $\frac{5}{8}$ -inch cable. The straw line drum carries from 2500 to 3000 feet of $\frac{3}{8}$ -inch cable which is used in running out the out-haul line when logging is shifted from one run to another. The decking line is $\frac{5}{8}$ -inch and about 150 feet long and is used to deck or pile the logs parallel to the railroad. One end of each boom stay is fastened to a stump or tree at one side of the track and passes through a block on the end of the boom and to a small drum on the machine, which is used to tighten the stay when it has been adjusted.

Re-haul skidders do not have loading equipment and this work must be done at some later time by an independent loading unit. The usual skidding distance for machines of this type is from 600 to 800 feet. Railroads, therefore, are located approximately one-fourth of a mile apart.

Operators using this method frequently log only one or two runs from each line at a given set-up, pulling at approximately right angles to the track. The distance between set-ups along the track is about 200 feet when the above practice is followed and the machine, therefore, skids from 5 to 7½ acres before moving. A self-propelling machine can be moved from one set-up to another and the lines readjusted, when the stand is fairly open, in about twenty minutes. When the brush is dense and the straw line must be pulled out by hand instead of by a horse, it may require one-half hour. The crew for operating a 4-line re-haul skidder consists of from seventeen to eighteen men, and in addition one horse for pulling the straw line out to the ends of the runs when lines are being placed in position.

The daily capacity of a re-haul skidder in southern yellow pine forests ranges from 100 to 125 logs, 25,000 to 35,000 board feet, per line.

Ground yarding. — This method, in which the lines follow the general ground level from the yarding machine to the tail blocks, is in use chiefly in the Northwest and in the Inland Empire. Ground yarders are used both for yarding logs direct from the stump to the railroad and also as an intermediate system of transportation between the yarding engine and the railroad where it is not practicable to place the railroad within reach of the initial yarding unit. In some cases the logs may be relayed two or more times before they reach the loading point.

Yarding engines are mounted on a steel frame and have a vertical high-pressure boiler which ranges in size from 48 by 96 inches to 80 by 153 inches; a two-cylinder engine ranging in size from 9 by 10, to 13 by 13 inches; and three drums driven by compound gears. The skidding line drum has a capacity of 1500 feet of cable, the haul-back line drum from 3300 to 3500 feet, and the straw line drum about 3500 feet. The machine, with a water tank at the rear, usually is mounted on a sled which has two runners about 3 feet in diameter and from 35 to 60 feet in length.¹ The machine is moved for short distances under its own power, being dragged over the ground on the sled by means of cables which run from the machine to trees or stumps in the line of proposed travel. When long moves are made it is placed on a

¹ Yarding engines often must be moved up or down slopes and over a bad bottom. A sled provides an admirable base for this purpose.

car and hauled by rail to the new set-up. Some loggers now mount their machines on cars instead of sleds.

The yarder is set up at one end of a landing along a logging railroad or at some intermediate point between the stump and the railroad if a "swing" machine is to be used at the landing.

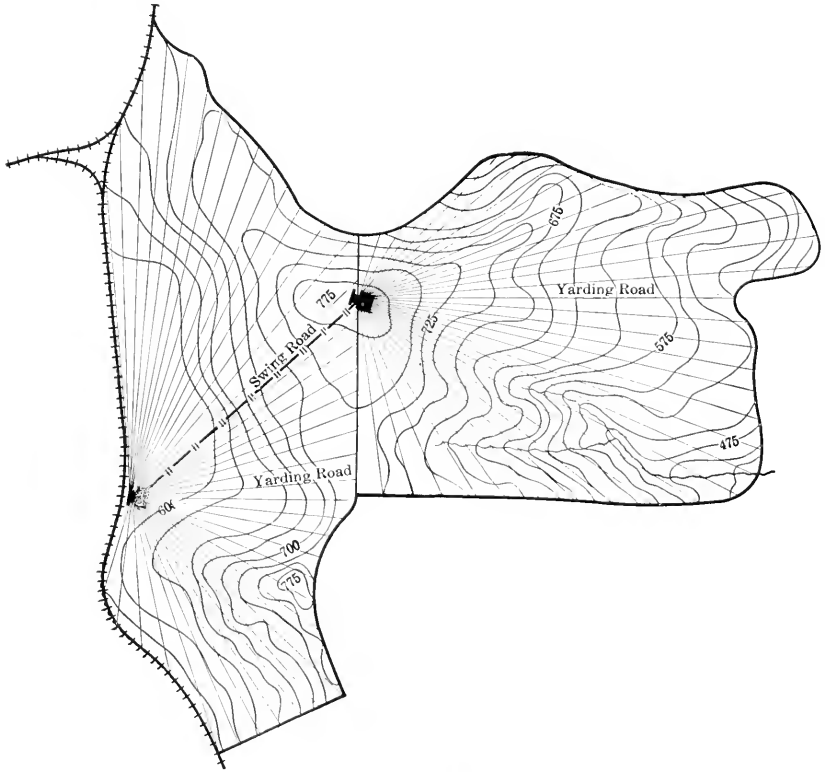

From Bul. 711, U. S. Dept. of Agriculture.

FIG. 76. — A Logging Chance showing the Location of the Ground Yarding Roads, Pacific Coast Forests.

The area logged from one set-up is determined chiefly by topography and stand of timber per acre. It is often irregular in shape, due to topography, being delimited by ridges, gullies, or the practical yarding range. The latter may be as short as 500 feet when conditions for railroad construction are very favorable. As a rule, the average distance is from 600 to 900 feet but in some cases logs are skidded for distances as great as 1500 feet.

The yarding engine location is carefully chosen in advance of logging, sometimes before the railroad is located because a good setting for a yarder may be more important than the best railroad location. When the yarding engine has been moved to the logging site, the crew runs out the yarding lines. The strip first logged is often parallel to the railroad. The first step is to drag the straw line by hand from the machine out over the first run to be logged, at the end of which it is passed through a tail block. It is then carried along the back side of the setting for a distance of about 300 feet where it is again passed through another block and then pulled back to the machine, thus enclosing a fan-shaped area. The trip line is then fastened to the end of the straw line, and the latter pulled in to the machine carrying the trip line around the outer edges of the area to be logged. When the end of the trip line reaches the machine, it is disconnected from the straw line and attached to the main cable and the machine is then ready for operation.

When the first run has been logged, the main cable is detached from the trip line, and the latter pulled through the blocks until it is at the end of the next run which is to be logged. The straw line having been carried out over the second run is passed through a new tail block and connected to the end of the trip line which is then drawn in to the machine and the trip line detached from the straw line and attached to the main cable.

Additional trip line blocks may be needed between the tail trees or between one of the tail trees and the machine in order to reduce wear on the cable. A diagrammatic scheme of the runs on a logging chance is shown in Fig. 76.

The main skidding cable usually runs direct from the machine to the block on the tail tree, although there may be angles in the line, the cable passing through blocks, or working against rollers where the bends occur.¹

The first work of the yarding crew is to clear the area around the landing of debris which would interfere with yarding or loading, following which the yarding of merchantable timber begins.

The main cable to the end of which a butt chain² is attached

¹ The practice of pulling in a straight line is now followed more extensively than formerly because of the delays incident to placing and tending the blocks at the bends in the line.

² A short, heavy chain fastened to the main cable, with a hook on the free end in which the choker sockets or eyes are caught when logs are being yarded.

is run out by the trip line to the first logs to be yarded which are those nearest the machine. The choker¹ is then placed around one end of the log and the free end of the choker caught on the butt chain hook. The log is then drawn to the landing where it is loaded on cars. When a swing donkey is used, the log is dropped by the yarder within reach of the outer end of the main cable of the swing donkey and the log is then pulled to the landing by the auxiliary machine. One large log, or several small ones may be yarded at one time, the number depending on the volume of the logs, the size of equipment and ground conditions.

Additional blocks may be necessary in order to side line logs around stumps or other obstructions.

When the logs available from one end of the landing have been yarded, the yarding engine is shifted to the other end and the process repeated. From two to four hours are required to move the yarding engine from one end of the landing to the other and from five to ten hours to move from one landing to another, including the work necessary to rig the loading machinery and to set the lines for yarding.

The crew required for operating a system of ground yarding varies with different camps and with the difficulty of the "chance" in the same camps. Under average conditions twelve men are used.

1 hook tender	1 chaser
1 swamper	1 signal man
1 sniper	1 engineer
2 rigging slingers	1 fireman
2 choker men	1 wood buck

The hook tender is the boss of the yarding crew, and the amount of work done depends largely on his ability. He plans the work, shows the swamper where roads are to be cleared, designates the logs that are to be skidded and the order in which they are to

¹ A choker is a piece of cable from 1½ to 1¾ inches in diameter and from 15 to 30 feet long. One type has a socket on one end which is caught in the butt hook, and a flat hook on the other end. The free end of the choker is passed around one end of the log, forming a noose, and the flat hook is then caught over the cable. The other type has an eye on each end, one of which is caught on the butt hook. The other end of the cable is thrown around the log in the form of a noose and a sliding hook on the choker is caught in the eye. The latter type does not come loose as easily as the flat-hook type and is preferred when working on rough ground. The flat-hook type is easier to handle and often is used in high-lead yarding.

be taken, and directs and assists the rigging slingers in their work. The head rigging slinger is the hook tender's assistant and working alone or assisted by one or two helpers, he unhooks the chokers from the butt chain when the main cable has been returned to the log, hooks up new turns of logs, and sets "lead" and other blocks when they are required. The swamper works just ahead of the rigging crew, knots the logs, chops out the small trees and brush, cuts roots and improves the runs so that logs can be brought in without being hung up. The chief duty of the choker men is to place the chokers in position on the log. The sniper rounds the forward ends of the logs so that they will more easily slide over obstructions. The chaser passes logs by the butt-chain blocks and unhooks the logs at the landing.¹ The signal man transmits the orders of the hook tender, rigging slinger, or chaser to the engineer either by pulling on a wire attached to the whistle of a yarder or by means of an electric whistle control operated by batteries.

The daily output of ground yarding equipment is extremely variable but ranges between 40,000 and 80,000 board feet. In some cases a higher output has been secured for short periods and in other cases it has fallen below the minimum mentioned.

*High-lead yarding.*²— In this system the main cable passes from the machine through a block suspended 125 or more feet in the air from a nearby spar tree and from thence to a block at the far end of the run. The haul-back line follows the general ground level. Although this method was known in the West as early as 1905, it was not extensively used until about 1915 since which time many installations have been made.³ This method is not commonly employed in other regions due to the absence of trees of a suitable size and height for spars. The system has

¹ When the butt chain blocks are some distance from the landing an extra man may be needed to tend them. Their use is becoming less frequent for this reason.

² See Fig. 77.

³ The high-lead method was used in the South some years previous to 1905. A patent on a high-lead system for western use was granted to H. R. Robinson in 1905 and in a later suit brought to collect royalty from loggers who used that method it was brought out that similar patents had been issued several years previously and that machines built under the earlier patents were in operation before the Robinson patent was granted.

been used in exceptional cases for distances as great as 2000 feet, but this is not considered profitable as a general practice.

The chief advantages of the high-lead over the ground system are (a) the front ends of the logs are elevated and, therefore, do not hang up on stumps, rocks and other obstructions, or dig

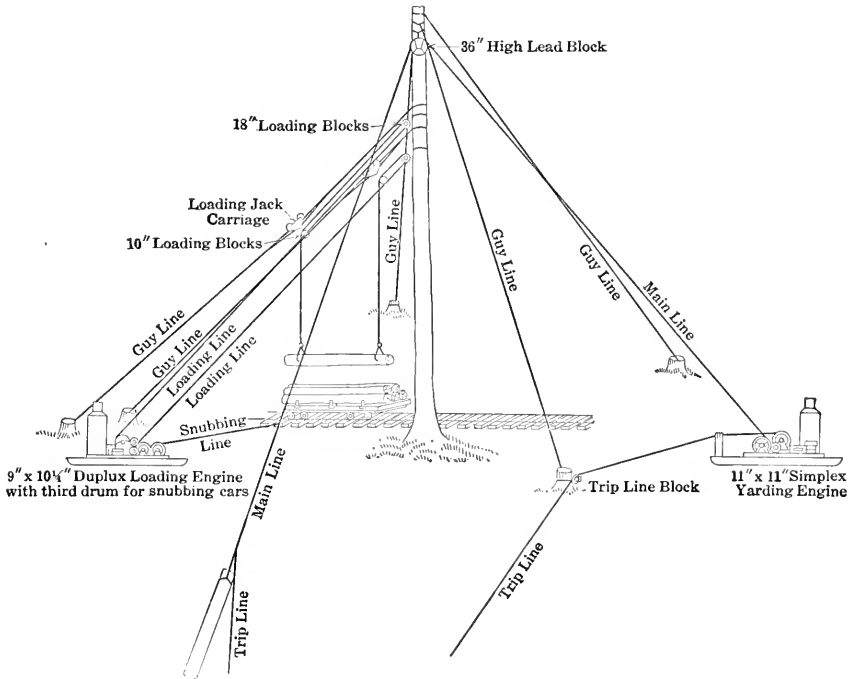

From Bul. 711, U. S. Dept. of Agriculture.

FIG. 77. — Arrangement of High-lead Skidding and Loading Equipment. Pacific Coast.

into the ground so much when crossing depressions; (b) a special landing is not required, although the saving in cost due to this is largely offset by the cost of rigging the spar tree; (c) two moves only are necessary to log an area at one landing as compared to four for a ground system; (d) the loading area can be kept relatively free from débris and yarding, therefore, may be more continuous; (e) and a higher skidding speed¹ may be used as soon

¹ Two-speed engines are used, the lower speed being employed to haul the logs up to a point where the forward end of a log can be elevated, and the higher speed to bring the log from this point to the landing. The change from one speed to another may be made instantaneously.

as the log reaches a point near enough to the spar to have the cable exert a lifting tendency. This distance depends upon the height of the spar tree and the configuration of the ground but seldom exceeds 600 feet.

A main spar tree from 15 to 20 feet from the center of the railroad track is selected at the proposed setting and the top is cut off at a point from 150 to 200 feet above ground. The spar is then guyed with from six to nine lines.¹ In case a suitable tree is not available at the setting a spar may be moved to the site, although this method is resorted to only under exceptional circumstances.

The yarding engine is placed from 150 to 250 feet from the spar tree in order to relieve the strain on the spar. The main cable is supported on a high-lead block of special design, which is suspended under the guy lines at an elevation of from 125 to 175 feet.

A standard type of ground yarding engine may be used for high-lead yarding, but a special three-drum type with higher drum speeds is necessary if the operator secures the full advantage of the system. Some operators now mount their yarders on steel cars instead of on sleds, and place them on a siding near the spar tree, lashing the car to the latter.

The cables and chokers are similar to those used for ground yarding but cables of a smaller size are often used because there is less wear on them.

The crew required to operate this system may consist of eleven men, provided the spar rigging is done by a special crew, which may rig for two skidding units.

1 hook tender	1 engineer
1 rigging slinger	1 fireman
3 choker men	1 wood buck
1 signal man	1 wood splitter
1 chaser	

The output per crew may exceed that for a ground system operating under like conditions by from 15 to 30 per cent.

SWINGING AND ROADING

Overhead, ground yarding and high-lead equipment are frequently used in the Northwest to bring logs from a yarding machine to the railroad spur or to some driveable stream or other body

¹ When nine guy lines are used, six radiate from a point near the top of the spar, and three from some point lower down.

of water on which the logs can be floated to destination. This process is called "swinging" when the distance for which the timber is moved is relatively short and ground improvements are not made. "Rooding" is a term frequently applied to the movement of timber for comparatively long distances, and often presupposes some form of ground improvements such as the installation of fore-and-aft roads. The two terms often are used indiscriminately, however, and the term rooding may be applied to short distance hauling without ground improvements.

There is no standard practice with reference to swinging and rooding because operators are not fully agreed as to the merits of this system especially for logging on a relatively flat chance. The tendency some years ago, when railroad spurs began to displace skid roads, was to put the railroad within yarding distance of every log. This practice was feasible as long as ground conditions were favorable for comparatively cheap railroad grade construction. Many logging operations are now located in a region of rough topography where the cost of railroad construction is high and modern swinging and rooding methods have been developed to reduce the mileage of high-cost railroad that would be necessary to bring every tree within a single yarding distance.

Ground and high-lead swinging are used preferably on the gentle slopes while some form of overhead system has proved the best in mountainous regions, especially for bringing logs up or down steep slopes, and across gorges.

The ground and high-lead systems of swinging often are operated by the standard type of yarding engine which may be used either for yarding or swinging. In general a simple-gearred engine is preferred when the ground system is used. The crew consists of five or more men, depending on topography and output. The minimum crew comprises an engineer, fireman, wood buck, hooker-on, and a chaser.

The distance for which swinging is carried on with ground or high-lead equipment varies with the topography and the aim is to so locate the swing donkeys that the yarding operations will not be held up. Sometimes the distance for a single haul is 1200 feet, but in general, it is but little greater than the yarding distance.

When some form of overhead system is used to swing logs, the distances may be 1200 feet or more since it is practicable to haul

for longer distances than when the logs are dragged along the ground. The Lidgerwood, MacFarlane, North Bend and other overhead skidders are used in addition to other types which have been developed especially for this purpose. The use of a double-sky line system for swinging logs in the redwood region is shown in Fig. 78.¹ The logging railroad is located in a gulch

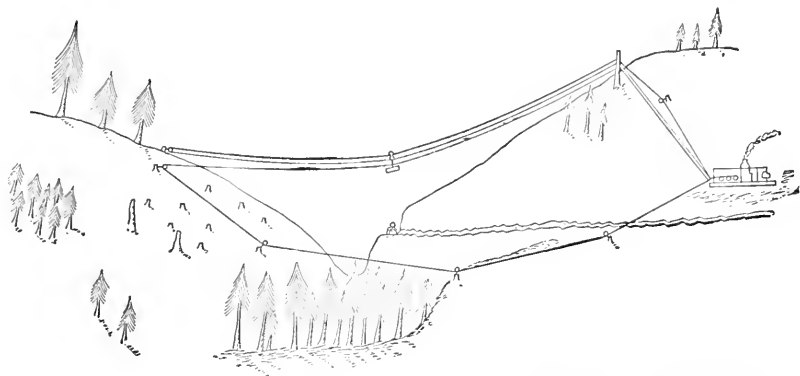

Adapted from The Timberman.

FIG. 78. — A Duplex Aerial Cableway System used to swing Logs from Two Yarding Engines located on opposite Sides of a Canyon.

and higher up on both sides of the slopes yarding donkeys are placed which bring the logs under the overhead cable. A log is picked up on one side of the gulch and dropped within reach of the loading rig along the railroad, and the trolley is then run to the opposite side of the gulch and a log brought from there to the railroad. The machine thus alternately serves two yarding engines. The installation of this machine obviated the necessity of building expensive railroad grades up the slopes to the yarding engines, and enabled the operator to get his logs to the railroad with a minimum of damage from breakage. Special equipment has been devised to handle logs on very steep grades or to lower timber from a higher to some lower level. Some types of such equipment are discussed under aerial trams.²

Roading was formerly used extensively in connection with the ground system of yarding to move the logs from the yarding engine to the railroad or to some stream or body of water on which

¹ See *The Timberman*, August, 1922, p. 144.

² See Chapter XV.

the logs could be floated. Some of the earlier road engines were capable of operating for distances of 1 mile, and sometimes the logs were relayed by two or more machines. One road engine now seldom hauls for more than 3000 feet and at this distance it will handle the output of two ground yarding engines. For long-distance hauling, skid roads or pole roads were installed. The system is less frequently used today than formerly because a skid road or a pole road often costs nearly as much as the grade of a spur logging railroad and the cost of moving logs by road engine is more costly than by railroad. Today many loggers have replaced the road engine, either with an overhead system of transportation or with a short-distance ground system which does not require a skid or pole road, or else the logging spur is built to the setting of the ground yarder. Roading is most extensively practiced in certain sections of the Northwest in which a large part of the log input is rafted to market and in which a pole-road haul of from 1 to 2 miles will reach a driveable stream. A road engine is similar to a simple-gearred yarding engine, but the drum capacity is much greater. It is mounted on a sled in the same manner as a ground yarding machine and is moved about from one setting to another under its own power.

The main cable is 1 or $1\frac{1}{8}$ inches in diameter with a $\frac{5}{8}$ - or $\frac{3}{4}$ -inch haul-back line. The cable is operated on the slack-rope system with the road engine located at the landing and a heavy tail-sheave at a point a short distance behind the yarding engine. The haul-back line which is placed near the main road, but outside of it so that it will not interfere with the operation of the main cable, is hung in snatch blocks located at suitable points. The main cable follows the road and is kept in place by blocks or by rollers where turns are made. Several logs aggregating from 6000 to 11,000 board feet are fastened one behind the other by grabs, and form turns which are attached to the main cable by a chain or short piece of cable which is coupled to the grabs on the forward log. The turns are made up by a grab setter. A chaser follows the logs to the landing, often riding in a rigging sled hollowed out of a log, which is attached to the rear log. The chaser can signal to the road engineer at any point along the line by pulling on a wire stretched along the road which is connected to the whistle on the engine. On arrival at the landing the chaser aids in placing the logs on the landing, removes the grabs from the

logs and returns with the grabs in the rigging sled to the yarding machine.

A dirt road often is used for distances under 2000 feet, but when the length of haul exceeds this a fore-and-aft or a pole road is constructed.¹ Skid roads² were used extensively at one time, but they have been abandoned by most operators, although some still build skid roads when the conditions are favorable for their use. They are more expensive than pole roads since a well constructed grade is necessary and from 80,000 to 100,000 board feet of construction timber is required per mile, exclusive of bridges.

The road should be as straight as possible because curves increase the frictional resistance and reduce the hauling ability of the engine and increase the wear on the cable. Rollers are placed on stumps or posts, or fenders are put alongside the road at curves to reduce the wear on the main cable.

During the early period of logging in the Northwest the road engine sometimes was replaced by a geared locomotive and the logs were dragged between the rails from the yarding engine to the landing. As a rule, the logs were dragged over the cross-ties, but on a road of some permanency planks were spiked on the ties to protect them. A plan sometimes followed was to have a spur track from $\frac{1}{2}$ to 1 mile long running out from each end of the landing, with a donkey working at some point on each spur. The engine went out one spur and with a short cable it coupled to a turn of logs, made up in advance, and dragged them to the landing. It then went out the other spur and brought in a turn from it, alternating in this manner throughout the day. A water tank with a $1\frac{1}{2}$ -inch escape pipe was used to wet the track to facilitate the passage of the logs. On a 1-mile haul one engine handled daily the output from two yarding engines.

FUEL REQUIREMENTS

Wood is the fuel most commonly used in power skidders in all parts of the country, although coal and fuel oil are used in regions where they are readily available.

From the steam-producing standpoint wood is a fairly satisfactory fuel for average logging conditions since it can be secured on the operation and is seemingly cheap. When heavy demands

¹ See page 268. ² See page 148.

are made on the boilers for power, wood is not as satisfactory as fuel oil or coal and, in some parts of the West, wood has been replaced by fuel oil and in other regions where coal can be easily obtained it has been substituted frequently for wood. The use both of wood and of coal represents a high fire hazard because of the heavy spark discharge and this has led to a preference for fuel oil when it can be secured at a reasonable price.

Wood fuel often is cut from merchantable logs which have been skidded to the machine. Cull logs are sometimes used, but they provide an inferior fuel and their use is limited on that account. In the southern pine region, "fat" pine is a common fuel because of its high heat value. It is, however, harder on boiler flues than most other kinds of wood because of the marked changes in the temperature of the fire box. When "fat" wood is first thrown on the fire, the early combustion of the volatile gases creates an intense heat. Before the wood has been consumed to the point where more can be put on the fire, the temperature in the fire box will have dropped to a marked extent. The constant rise and fall of temperature causes a continual contraction and expansion of boiler tubes which often leads to tube leakage.

The amount of wood fuel consumed by a skidder is dependent on the length of haul, the size of the logs and the character of fuel wood. In general an overhead, a re-haul, and a snaking skidder in the South each burn from four to five cords of 2-foot wood daily. A 11- by 13-inch yarding engine in the Northwest will use daily from 1000 to 1600 feet log scale of timber which is equivalent to from four to six 2-foot cords.

Coal is considered a better fuel than wood, but is fully as hazardous from the forest fire point of view and in many places is as expensive as fuel oil, hence the latter is preferred. The coal requirements for a skidder range from 1 to $1\frac{1}{2}$ tons daily.

Oil is considered the most satisfactory fuel for yarding engines and skidders which are located on a railroad because of the low forest fire hazard connected with its use, the ease with which it can be placed in the storage tanks, and the ability of the fireman to maintain an adequate steam pressure when heavy demands are made for power. It is claimed that oil burners may have from 15 to 25 per cent greater efficiency than wood burners because of the ability to always hold a high head of steam. A yarding engine will consume from five to eight barrels of fuel oil

daily, the average being about five gallons of oil per thousand board feet of timber yarded.

SPARK ARRESTERS

The laws of most forested states require the use of some form of spark arrester on wood- and coal-burning skidding machinery. There are several types of spark arresters for stationary engines,

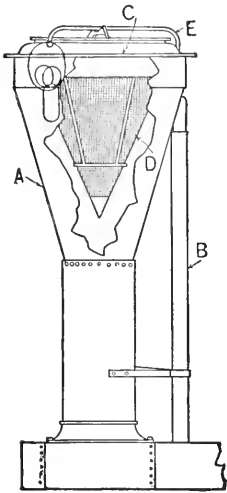

FIG. 79. — The South Bend Spark Arrester adapted to Power Skidding Machinery.

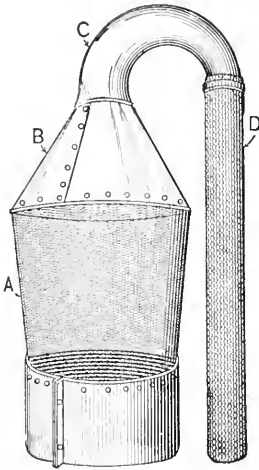

FIG. 80. — The Boomerang Spark Arrester.

two of which are here described. A spark arrester will not completely prevent the emission of live sparks from skidder power plants which are operated under forced draft, but the fire hazard can be decreased by properly screening the stack.

The *South Bend Spark Arrester*¹ is used almost exclusively on power skidders in the southern yellow pine region, and also to some extent in the Northwest.

It has a round tapering shell (A) of sheet metal, an outlet (B) at the side for the discharge of sparks and cinders; and a sheet metal cover (C). A cone-shaped screen (D) attached to the sheet iron cover hangs within the stack, apex downward, and deflects the cinders into the spark receiver at the head of the out-

¹ See Fig. 79.

let pipes. The steam, smoke and gases escape through the screen, in which the cinders do not clog because of its conical form. The screen can be raised by means of the lever lift (*E*) when it is unnecessary to use an arrester or when firing up the boiler.

The *Boomerang Spark Arrester* is used by many loggers on the Pacific Coast. This has a heavy $\frac{1}{4}$ -inch mesh round screen (*A*), slightly flaring toward the top, on which is mounted a heavy sheet iron cone (*B*). The latter ends in a boomerang (*C*) to the open end of which a screen conveyor tube (*D*) is attached. The smoke passes out through the screen while the sparks travel straight up through the steel cone where they are diverted into the boomerang and led into a receptacle by the side of the engine. As the sparks do not come in contact with the screen it does not become clogged.

ELECTRICAL DRIVE

Loggers and the manufacturers of electrical equipment have been interested for many years in the development of logging machinery driven by electrical power, but only a relatively few installations of such equipment have been made. As early as 1908 an electric road engine was tried out in British Columbia, but it did not work satisfactorily because of the inability of the motor to vary its speed, and take up the slack in the line on down-grade pulls. One of the earliest installations of yarding engines with electric drive was made in 1911 and since that time marked improvements have been made in such equipment, especially since 1918. Although the loggers, in general, have not accepted the electric-drive idea in its present stage of development, some have made installations which are giving satisfaction. The modern electrically-driven donkey engine is a combination yarding engine and loader mounted on one sled about 60 feet long. The two-speed motor driving the yarding drums has a rated horse-power of 300 which, by gearing, may be increased to 1200. The loading drums are driven by a 75 horse-power, two-speed motor. The skidding drum has a capacity of 1800 feet of $1\frac{1}{2}$ -inch cable. The gear shifts, frictions and whistle are operated by compressed air. Power for driving the motors is brought to the vicinity of the yarding engine by transmission lines which carry about 13,000 volts, which is stepped down by a transformer located near the machine, to 600 volts.

The combined yarder and loader weighing from 70 to 80 tons is moved about from one point to another on a specially designed steel car. Modern electric yarding engines have proved to have a logging capacity equal to those using steam power.

One of the chief advantages which will result from the more extensive adoption of electric logging machinery is the great reduction in the forest fire hazard. Further, fuel and water are not required and the services of a fireman can be dispensed with. Power lines can be installed at approximately the cost necessary to pipe water to a steam yarding engine.

Those who have experimented with electrical power, state that its use should not be attempted unless adequate power is available at a reasonable price.

BIBLIOGRAPHICAL NOTE TO CHAPTER XIV

- BERRY, E. J.: Advantages Accruing to the Adoption of Electricity in Logging. *The Timberman*, August, 1912, pp. 32 and 33.
- CLARK, E. T.: Pacific Coast Logging. *West Coast Lumberman*, May 1, 1920, pp. 51 to 118.
- COLE, C. O.: Difficulties Confronting Electric Log Haulage. *The Timberman*, August, 1912, pp. 36 and 37.
- DICKINSON, M. H.: Single Main Cable Logging. *The Timberman*, Nov., 1921, pp. 96 C and 96 D.
- FRINK, Francis G.: Washington High-Lead. *The Timberman*. Sept., 1915, p. 46.
- GIBBONS, William H.: Logging in the Douglas Fir Region. U. S. Dept. of Agriculture, Bul. No. 711, Washington, 1918.
- GRAY, R. E.: Progress in Electric Logging. *The Timberman*, Nov., 1921, pp. 62-64.
- HINE, Thomas W.: Utility of the Duplex Logging Engine and the Duplex System of Yarding. *The Timberman*, August, 1910, pp. 36 and 37.
- KALB, Henry A.: Utilization of Compressed Air for Snubbing Logs. *The Timberman*, August, 1912, p. 53.
- MCGIFFERT, J. R.: Development of Cableway Skidder. *American Lumberman*, Oct. 22, 1921, pp. 56 and 57.
- MEREEN, J. D.: Substitution of Electricity for Steam in Modern Logging Operations. *The Timberman*, August, 1912, pp. 29 and 30.
- MURRAY, L. T.: Railroad Construction vs. Donkey Hauls. *The Timberman*, Nov., 1921, pp. 60 and 61.
- MURRAY, L. T.: Changes in Types of Donkey Engines. *The Timberman*, Nov., 1922, pp. 50, 52, and 55.
- O'HEARNE, James: Wire Rope. *The Timberman*, Nov., 1922, pp. 40 and 41.
- TAYLOR, W. S.: Different Stages in the Evolution of Overhead System of Logging. *The Timberman*, Jan. 1914, pp. 30 and 31.

- THOMPSON, Jas. R.: Use of Electricity on Logging Operations. The Timberman, August, 1910, p. 64L.
- VINNEDGE, R. W.: A Composite Flying Machine. The Timberman, Oct. 1913, pp. 33 to 36 incl.
- VINNEDGE, R. W.: Overhead Logging Systems. The Timberman, Nov. 1922, pp. 45-50.
- WILLIAMS, Asa S.: Logging by Steam. Forestry Quarterly, Vol. VI, No. 1, pp. 1-33.

CHAPTER XV

AERIAL TRAMWAYS

Aerial tramways are used for carrying logs and other forest products up or down steep slopes, where other forms of transport are not feasible.

A common type has a stationary main cable stretched between the terminals of the tramway. It may be a single span or it may be supported at frequent intervals on trestles or masts. The trolleys carrying the loads run on this cable, and are drawn along it by a smaller endless power-driven traction line.

Tramways are seldom justified, except where other means of transport are not practicable. Their chief use has been for moving products in mountainous regions, especially where deep gorges must be spanned or ridges crossed. They may be built to operate on steep grades, and are relatively cheap to construct and operate in a very rough country as compared to a railroad. The amount of power required is comparatively small.

They have been installed in the United States only to a very limited extent although frequently used in Europe and India especially for the transport of firewood. Their use in this country will increase as logging operations reach the more inaccessible stands of timber at the higher elevations. Aerial trams have advantages which flumes and slides do not possess, because the two latter require descending grades for operation and they are a one-way system only, while the aerial tram, on the other hand, operates successfully both on ascending and descending grades, and provides a means of transportation in both directions.

Gravity tramways of several types have been used in this country to bring logs from benches to some form of transportation on the lower levels. One such installation in Tennessee was designed to bring logs from a plateau to the logging railroad about 3700 feet distant. The $\frac{3}{4}$ -inch standing line followed the general slope of the ground and was supported at intervals of from 150 to 250 feet on brackets of varying length which were fastened to

trees. The cable rested, free, in a slot in a casting bolted to the end of the brackets, except in depressions where one end of a piece of strap iron was riveted to the outer side of the casting and the other end passed over the cable and was nailed to the bracket.

A log was carried by a pair of trolleys, each having two sheave pulleys which ran on the upper side of the cable. Two short chains each having a ring on one end and a "grab" on the other were used for attaching the logs to the trolleys.

Five sets of trolleys were joined together by a $\frac{3}{8}$ -inch cable, which was wound around a drum, equipped with a friction brake, which was placed at the head of the tramway and served both to control the speed of the descending load and to return the empty trolleys to the head of the tramway. Power for the latter purpose was supplied by a 6-horse-power gasoline engine.

The logs were loaded on the tramway from a set of balanced skids which were placed so that the short ends of the skids were directly under the main cable. Horses brought the logs to the base of the balanced skids upon which they were rolled. The grabs were then driven and the skids elevated until the rings on the grabs could be fastened in the hook on the trolleys.

The maximum capacity of the tramway was 6000 board feet per turn, and approximately thirty minutes were consumed in making one round-trip.

A similar tramway has been used in the Northwest for elevating logs from canyons to plateaus. The cable was suspended between two points and the loaded trolleys were hauled to the top by a hoisting engine.

A special adaptation of a single-wire tramway¹ has been used on an operation in the Northwest for lowering logs on grades up to 60 degrees. The main cable was $1\frac{1}{8}$ inches in diameter and 1500 feet long. It was attached at the head of the tramway to a large tree at a height of 75 feet. The tree was braced securely on three sides with guy wires. A 16-inch sheave block was spliced to the lower end of the main cable and through this block a 1-inch cable 150 feet long was passed. One end of the latter was attached to a stump and the other to the drum of a yarding engine, both stump and yarding engine being in front of and equidistant from the sheave block. The main cable could

¹ See *The Timberman*, Aug. 1909, p. 24.

be lifted several feet above ground by tightening the secondary cable with a few turns on the drum. The logs were attached by chokers to a traveling block that ran on the main cable. The load descended by gravity, its speed being controlled by a $\frac{5}{8}$ -inch cable which was attached to the rear of the traveling block, and then passed through a block fastened to the tail tree and thence down the slope to a drum on the engine. The trip line was held

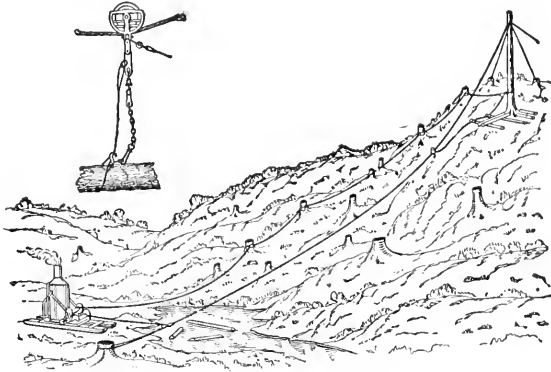

FIG. 81. — A Single-wire Tramway used in the Northwest. The details of the trolley and the method of attaching logs to it are shown in the enlarged cut.

in position by several blocks placed at suitable intervals on the slope. This line also served to return the block to the head of the tramway. In case of a break in the machinery or of the load becoming unmanageable the main cable could be dropped to the ground and the load stopped.

A system of this character may be used for distances of 3000 feet when there are no pronounced elevations between the two ends of the tram.

Logs containing from 5000 to 6000 board feet have been successfully handled. The hourly capacity of this tramway was 12,000 board feet, when the logs averaged from 300 to 500 feet. Three men were required to operate the tram.

A single-wire gravity tramway¹ used in the West had a $1\frac{3}{8}$ -inch main cable 2100 feet long suspended between a tree on the upper slope and one at the base of the grade, as shown in Fig. 82. Automatic trips were placed on the main cable at the loading and

¹ See *The Timberman*, April, 1912.

unloading points. The snubbing line passed through a 2-sheave trolley and had a ball near the free end which engaged a catch in the trolley and served to hold the load in position, and to trip it at the lower end. Power for returning the trolley to the head of the tram was furnished by a drum on a yarding engine at the head of the slope. A cable was fastened near the ends of a log that was to be transported. A hook on the end of the snubbing line was then caught in a ring midway between the ends of the cable and the log hoisted into the air. When the ball on the

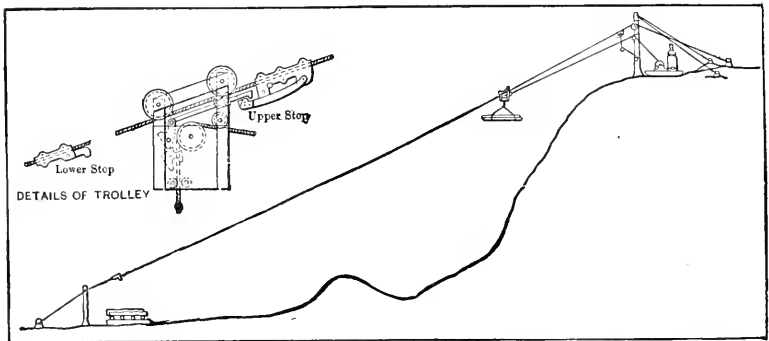

Adapted from The Timberman.

FIG. 82. — A Single-cable Aerial Tramway in use in the Pacific Coast Forests for lowering Logs on Steep Slopes.

snubbing line struck the catch in the trolley, the latter was freed from the stop at the head tree and with its load passed down the main cable by gravity, the speed being controlled by the yarding engine. On reaching the lower end of the cable the trolley was automatically tripped and the log lowered to a skidway along a railroad. Poles 100 feet long were handled with ease. The average time required to traverse the distance from the head to the foot of the tramway was one and one-quarter minutes.

One of the early successful attempts made to move logs for long distances by an aerial tramway system was undertaken in Idaho in 1912 when a line $1\frac{1}{2}$ miles in length was installed to bring timber out of a region in which the cost of railroad building was prohibitive. It was later modified and used to bring out timber from other portions of the forest. This system was not used, however, when logging railroad construction costs were within the limits which the company considered justifiable.

The tramway was built with a standing line $1\frac{1}{2}$ inches in diameter which was suspended from spars, spaced from 500 to 2000 feet apart, depending upon the configuration of the ground surface. The stationary return line for the trolleys was $\frac{5}{8}$ -inch since the chief load which it had to support was the weight of the empty carriers. An endless $\frac{5}{8}$ -inch traction line, run at a speed of 250 feet per minute, furnished the tractive force for moving the loaded and empty carriers. This traction line was driven by a 7- by 9-inch yarding engine, on the single-drum of which a capstan was bolted. The traction line was wound three times around the drum and then passed through three 10-inch blocks at the end of the line, so arranged that two of the blocks, spaced on either side of a central one, acted as spreaders and prevented too sharp an angle in the traction cable. The standing line was built in units 2000 feet in length, the ends of which were moored to stumps or trees. The ends of two sections of cable were 4 feet apart, the intervening space being spanned by a section of U-shaped metal track. There were curves as high as 43 degrees, the standing line at such places being supported on masts spaced 100 feet apart.

The logs were loaded from a skidway at which the elevation of the standing line was 4 feet. A choker, placed near each end of the log was caught in a slot on the lower part of a trolley, and the traction cable was placed on top of the choker in the same slot. Loads were spaced from 50 to 200 feet apart, the cable being stopped whenever a log was loaded. The capacity of this system, operated by a crew of 18 men, was 15,000 board feet per hour.

The design of the hanger and trolley used on a line similar to that in Idaho is shown in Fig. 83. The trolley is made of cast steel and has two 12-inch sheave wheels hung on a frame pivoted at *a* so as to allow it to travel up and down the hanger segment *o* on which the standing line *d* rests. The endless traction line is shown at *b* and *e*. The hanger hook is pivoted at *c* in order to give flexibility to the suspended load so that it can swing in a forward or backward direction. The grip for holding the traction line is shown at *f* and also at *e*, the weight of the load serving to hold the grip *k* against the cable. A chain is wrapped twice around the end of a log and caught in the hook *m* at *n* which is then closed as shown in the cut and locked with the clevis *l*. The release of the load is accomplished by raising the clevis *l* which allows

the hook *m* to open. The main cable is supported on a segment *o* which is pivoted to the hanger so that it will rock slightly towards the load when it approaches. Supports for hangers are placed from 350 to 500 feet apart depending on topography.

Another type, known as the endless cable tramway, has been used for the transportation of shingle bolts. A tram of this

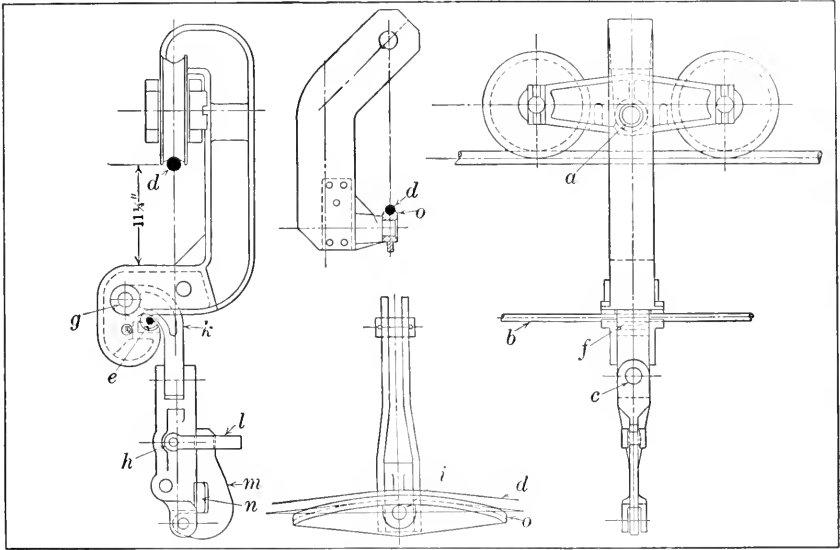

FIG. 83. — The General Form of the Trolley and Hanger used on Some Western Aerial Tramways.

character built in California had a $\frac{3}{4}$ -inch moving cable supported at frequent intervals on 16-inch sheave wheels attached to cross-arms fastened on heavy poles.

The cable was driven by a donkey engine geared to a 6-foot vertical drum around which the cable was wound several times and then passed out over the sheave blocks. About halfway between the two extremities the tramway turned a right angle, the cable passing around two loose drums at this point.

Shingle blocks were brought to temporary platforms by chutes and were attached by hand to grips which were fixed at intervals along the cable. The bolts were tripped automatically at the terminus.

One hundred grips were operated on the line one-half of which

were traveling loaded and the remainder returning empty to the loading point. The average output per hour for the tramway was thirty cords of bolts.

BIBLIOGRAPHICAL NOTE TO CHAPTER XV

- ANONYMOUS: A Newly Patented Aerial Logging Railway. *Western Lumberman*, Toronto, Ontario, Canada, December, 1912, pp. 40-41.
- ANONYMOUS: Heavy Duty Cable Tramway. *The Timberman*, Sept., 1914, pp. 31 and 32 B.
- FORSTER, G. R.: *Das forstliche Transportwesen*, Wien, 1888, pp. 242-250.
- FUJIOKA, M.: *Notes on Aerial Wire Tramway*. Tokyo, Japan, 1915.
- GAYER, Karl: *Forest Utilization*. (Schlich's Manual of Forestry, 2nd. edit., pp. 346-352; translated from the German by W. R. Fisher.) Bradbury, Agnew and Company Ltd., London, 1908.
- NESTOS, R. R.: Aerial Snubbing Device. *The Timberman*, April, 1912, pp. 49 and 52.
- NEWBY, F. E.: Handling Logs on Steep Ground with a Gravity Cable System. *The Timberman*, August, 1910, pp. 31-32.
- RILEY, F. C.: The Opsal Aerial System. *The Timberman*, Sept., 1914, pp. 33 and 34.
- ROGERS, C. G.: Note on the Setikhola Wire Ropeway. *Indian Forester*, Feb., 1902, Vol. XXVIII, No. 2, pp. 69-73.
- STEINBEIS, Ferdinand: *Die Holzbringung im bayerischen Hochgebirge unter den heutigen wirtschaftlichen Verhältnissen*, München, 1897, pp. 31-39.
- WETTICH, Hans: *Moderne Transportanlagen im Dienste der Holzgewinnung und Holzindustrie*. *Centralblatt für das gesamte Forstwesen*, Oct., 1912, pp. 451 to 460.

CHAPTER XVI

TIMBER SLIDES AND CHUTES¹

Slides are channels used chiefly for transporting logs, although pulpwood, crossties, firewood, and acid-wood, may also be handled in this manner. There are two general types; namely, earth



FIG. 84. — A Two-pole Running Log Slide. Idaho.

slides and timber slides, both of which may be combined to form a single slide.

They are in frequent use in Pennsylvania, the Appalachian

¹ The theory of slide design is treated exhaustively in *Beitrag zur Kenntnis der dynamischen Vorgänge beim Abriesen des Holzes in Holzriesen*, by Dr. F. Angerholzer v. Almburg, *Centralblatt für das gesamte Forstwesen*, April, 1911.

mountains, Idaho, Montana, the Northwest and, to a limited extent, in New England and New York.

Slides are built in the valleys of streams or down the slopes of mountains but they are seldom carried across watersheds because the cost of spanning depressions is too great. They vary in length from a few hundred feet to several miles. They are chiefly used in mountainous regions where the stands are light, the country broken, and the slopes so steep that logging



FIG. 85. — The Lower End of a Trailing Log Slide. Note the corduroy bottom over which the tow team travels. Idaho.

railroad construction is not justified. They are occasionally built in a flat country for transporting logs for short distances.

Earth Slide. — An earth or ground slide is used for short distances on steep grades where the soil is free from rocks and débris that would hinder the movement of logs. It is a furrow which is made by dragging logs over the proposed route. If the earth is easily stirred no previous preparation is necessary, otherwise the soil must be loosened in places by a pick.

An improved form called the "trail slide," has a furrow made in a manner similar to the ground slide, with the addition of a continuous "fender" skid on the lower side of the trail. These skids are from 12 to 18 inches in diameter and are fas-

tened together by a lap joint pierced with a 2-inch wooden pin, or with a $\frac{1}{2}$ -inch iron spike. The joint may or may not be supported on a cross-skid. Fender skids are kept in place by stakes driven into the ground on the outer side. Slides of this character



FIG. 86. — A Trailing Two-pole Log Slide in process of construction. Idaho.

are desirable on side-hills, where there is a tendency for the logs to leave an earth trail.

Timber Slide. — A timber slide has a trough or chute made of round or sawed timbers supported on cross-skids. On low grades where logs will not run by gravity it is necessary to clear out a right-of-way 10 or 12 feet wide which serves both for the slide and as a pathway for the animals which draw the tow of logs. Where the grade is sufficient to cause the logs to run by gravity, a right-of-way 8 feet wide is ample.

A common form of round timber slide has two parallel timbers supported on cross-skids placed from 8 to 15 feet apart. The timbers are from 9 to 18 inches in diameter and from 20 to 60 feet long and are cut from trees having a minimum taper. A log 6 or 8 inches in diameter with a hewed face or a 4- by 8-inch plank may be placed between the two slide timbers and fastened to the cross-skids. The poles are placed from 4 to 6 inches apart



FIG. S7. — The Terminus of a Log Slide. Idaho.

at the base on a two-pole slide and from 8 to 15 inches apart when a third pole is used. The timbers usually are placed with their butts up grade because they sliver less, and are joined together by a simple lap joint. They are sunk into a skid directly beneath them and fastened to it by $1\frac{1}{4}$ - or 2-inch hardwood treenails, or $\frac{1}{2}$ - by 12-inch iron spikes. In order to strengthen the slide the joints are always broken.

On level stretches a slide is built on the ground and requires a minimum of bracing and support, while on steep pitches and in crossing depressions it is supported on crib work and is thoroughly braced because rigidity is important.

When the round logs are in place and securely fastend to the

cross-skids, men are set to work to hew the inner faces of the slide timbers. This is particular work because any irregularities on the face of the slide will cause logs to jump. The scoring line is laid off with a chalk line and the timbers then scored with a felling ax and finally hewed smooth with a broadax.

A common method of dumping logs from a slide is to build one side several inches lower than the other. Another method

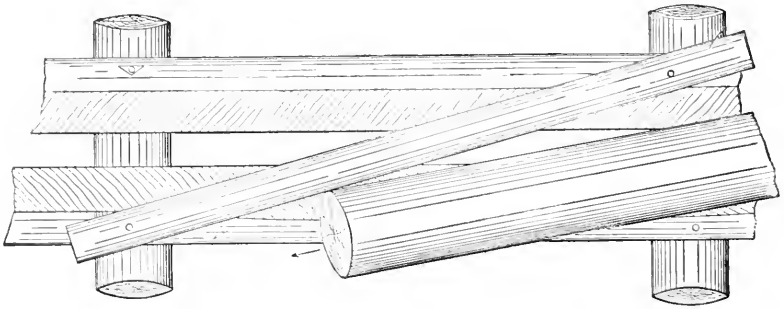

FIG. 88. — A Whip-poor-will Switch used for throwing Logs from a Slide.

used where there are several dumping grounds is to hew down the side of the slide on the dump side and place a switch called a "whippoorwill" diagonally across the slide timbers. The lower part of the slide ends at a landing, where the grade should

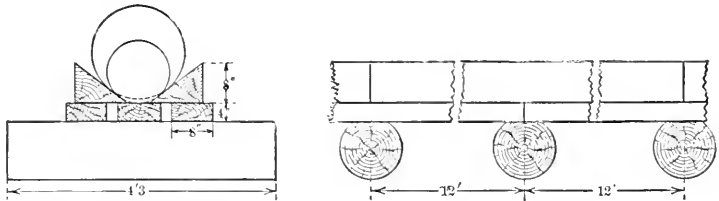

FIG. 89. — A Sawed-timber Slide, a Form sometimes used when Sawed Material is available.

be level or slightly ascending to check the speed of the logs. When the log strikes the switch it is shunted off. When it is desired to send logs past a given dump the upper end of the switch is removed and placed across the depression on the slide timber and fastened by two heavy treenails.

The life of a pole slide is from six to ten years, when kept in repair.

struction is in progress. When a slide is being dismantled the process is reversed and the timbers, as they are taken from the plates, are drawn down the slide to its lower terminus. Since the slide timbers are not spiked to the plates they can be easily removed or put in place.

A right-of-way about 20 feet wide is required when a team is used to draw the logs. This gives ample room for the slide struc-



FIG. 91. — A Fore-and-aft or Pole Road used with a Road Engine. Pacific Coast.

ture and for a runway along the side of it. Tows of 1000 board feet have been handled at one time, and in small timber one team will put in about 7000 board feet daily on a 1-mile haul.

On the Pacific Coast, slides called "fore-and-aft" roads or "pole chutes" are used for trailing logs from yarding engines to a landing, when power for moving the logs is provided by a road engine.

A fore-and-aft road has a trough from two to five poles wide, made from long straight timber with a minimum diameter of 10 inches. The ends of the poles are beveled, fitted together and drift-

bolted to skids placed transversely under them at intervals of from 10 to 15 feet, thus providing a stable foundation. Side braces placed at intervals of 15 or 20 feet prevent the poles from spreading. The slide follows the ground level except where



FIG. 92. — A Timber Chute for bringing Logs down Steep Slopes. New Hampshire.

it crosses deep depressions or streams, when it is supported on cribwork. The roads are built as straight as possible to decrease the loss of engine power through friction.

A fore-and-aft road requires from 90,000 to 120,000 board feet of

timber per mile according to the amount of cribbing necessary.

Chutes also are used on the Pacific Coast as the terminus of a skid or pole road, where the logs are dumped into a stream, pond or other body of water. These chutes have a head which is cross-skidded like a skid road, the "slip" or chute proper and the "apron" or terminus. The cross-skids at the head offer less friction than a pole chute and enable the logs to be readily started. The poles in the chute proper are drift-bolted to heavy cross-stringers set at 10-foot intervals on the upper part, and closer together near the base where the strain is greatest. Side poles serve as fenders to keep the logs in the chute. The apron extends out over the water, nearly parallel to the surface, in order to prevent the logs from striking bottom. The change in gradient from the slip to the apron must be gradual or the impact of the logs against the latter will soon destroy it. Chutes are used only when no other form of transport is feasible for even under the most favorable operating conditions many logs are broken or damaged.

In the Northeast chutes similar to the one shown in Fig. 92 are occasionally built for bringing logs down steep slopes.

Another form of rough chute used in the same region is built as follows: A strip 5 or 6 feet wide is cleared down the slope. Logs are then snaked to a skidway at the head of the cleared strip ready to be sent down by gravity. The first logs that go down are used to form a crude trough of parallel logs down which the bulk of the timber passes. Chutes of this character work best after a heavy frost or a light snowfall.

In parts of the Appalachian region the logs are frequently brought down the beds of the mountain streams. Where the grades are steep and the bottom is smooth, little preparation is needed, but where the bed is rough, poles are laid lengthwise in the stream. The logs are started at the head of a cove and pass down the slide with great rapidity, collecting in a rough-and-tumble skidway at its base. Although timber is often damaged by breakage this is offset by the cheapness of transportation.

Rail Slides. — Slides for short-distance transportation of logs by gravity have been made from steel rails mounted on suitable blocking, where grades are too steep for the use of wheeled vehicles. Standard-sized cross-ties, spaced 10 feet apart, serve as

a support for the slide structure. These may be laid directly on the ground or supported on crib work if it is necessary to elevate them in order to avoid abrupt changes in grade. Blocks 3 or 4 feet long with one end beveled at an angle of 45 degrees are sawed from crossties, and drift-bolted on top of the sills so that there is a space of about 24 inches between the nearest points. Two 45-pound steel rails, spaced 10 inches center to center, are then fastened with railroad spikes to the sills between the side blocks. Another rail also is spiked near the top of each sloping face of the side blocks. Rail joints are braced with angle bars, properly bolted. The advantage of this type of slide is that it can be readily moved from one site to another and can be installed by the logging railroad steel-laying crew at a daily rate of from 40 to 60 feet of slide per man. On one operation a slide of this type was used to lower logs from the top of a steep grade to a loading point along the logging railroad. The logs were brought to the slide on wagons, and unloaded on skids which sloped down from the upper side towards a set of dead rollers at the head of the slide. The logs were pushed forward on the rollers by hand to the slide down which they moved by gravity. This type of slide is well adapted to moving rough logs since the projecting stubs do not catch on the slide.

GRADES

The grade is an important feature of all slides. On trailing slides the grades are so low that logs will not run by gravity, and animal or other power is required to keep them in motion. Running slides have a grade which is steep enough to cause the logs to move by gravity.

Slides vary in gradient at different points along the line and in some parts they may be trailing slides and in other sections running slides. The grade necessary to make logs run by gravity depends on the character and condition of the slide, the kind and size of the timber and whether the slide is used dry, greased or iced. The greater the weight of the log the faster its speed, hence large or long logs will run on lower grades than small or short ones. Heavy hardwood logs will run on lower grades than most softwoods, and peeled logs will run on lower grades than unpeeled ones.

Earth slides with a 25 per cent grade may be used during the

summer but if the grade is as low as 10 per cent they are used to best advantage during cold weather when they can be iced.

During the warm season, horses often are used to drag logs in earth slides. Several logs are fastened together by grabs into a "turn" and a team is attached to the forward log. In cold weather animals can be wholly or partially dispensed with.

Iced timber slides are most efficient and, therefore, may be used on the lowest grades; those lubricated with skid grease rank next; while dry timber slides are the least efficient.

The following table of grades for running timber slides is from European practice:¹

Material transported	Per cent of grade	
	Dry slide	Ice slide
Firewood.....	20-35	6-12
Crossties.....	30
Logs.....	15-20	3- 6

Grades of 25 per cent are considered best for dry running timber slides in which large logs are to be handled, although 45 per cent may be used on short stretches if the slide is built strong and rigid. The minimum grade should not be less than 10 per cent.

Timber slides with maximum grades of 80 per cent and an average grade of 60 per cent have been operated, but are not desirable because of the heavy loss through breakage.

CURVES

Curves on slides must be laid out with reference to the length of material to be handled and the size of the chute. Sharp curves are always undesirable and especially so on steep pitches because the wear is excessive and logs are liable to jump out of the slide.

It is necessary on 2- and 3-pole slides to elevate the outer timber, the amount of elevation depending on the degree of curvature, the grade and the character of material that is being

¹ From Forest Utilization, by Karl Gayer. (Vol. V, "Schlich's Manual of Forestry," p. 325.)

transported. A radius less than 200 feet is not desirable for any form of slide.

OPERATION

Running slides are more expensive to operate than trailing ones because of their higher construction and maintenance expense, and the added cost of returning to the slide the logs which have jumped out of it.

Logs usually are rolled directly into slides either from large skidways on which many logs are stored in advance of chuting, or from small skidways where the logs are sent down as they are yarded. In some cases skidways are dispensed with, the timbers being spread apart at the head of the slide and the logs dragged directly into it.

Logs are sent down singly on running slides. When a part or all of the slide is a trailing one from ten to forty logs are made up into a turn, but if there is a possibility of the logs running even for a short distance they are not fastened together.

In making up a turn on a trailing slide a log is rolled from the skidway into the slide, and is then hauled down a log length by a tow horse or team, so that the next log may be rolled in. Both are then

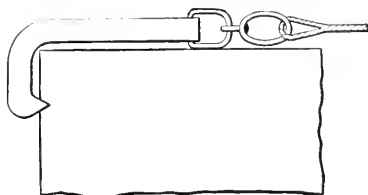

FIG. 93. — An "L" Hook used for attaching the Tow Line to the Turn of Logs.

moved ahead for another log length by attaching the tow line to the rear of the last log. The process is repeated until a turn is made up. The team is then hitched to a chain or rope from 30 to 50 feet long, at the end of which is an "L" hook, swamp hook, grab hook or "jay grab." The hook is then attached to the last log and the tow is started for the landing, and if the logs begin to run in the slide it may be readily detached. The logs are dragged to the landing, or until the grade becomes sufficient for them to run, whereupon the tow is started down the slide and the team returns to the head for more logs. The tow is picked up by another team on the first "dead" stretch and dragged to the next running portion of the slide.

Caterpillar tractor draft has been substituted successfully

for animal draft both in the Northeast and in the West. Machines as small as the 2-ton and as large as the 10-ton class have been used. They possess advantages over animals on long hauls, both because of their greater average speed and because they do not mire as badly as horses on bad bottom. On a 1-mile haul in eastern Oregon, a 10-ton caterpillar tractor has made from twelve to sixteen trips per day, hauling about 3500 board feet per trip, doing work which formerly required six teams.

During the summer season the "slow" stretches of a slide are watered, or are greased with skid grease or crude petroleum to

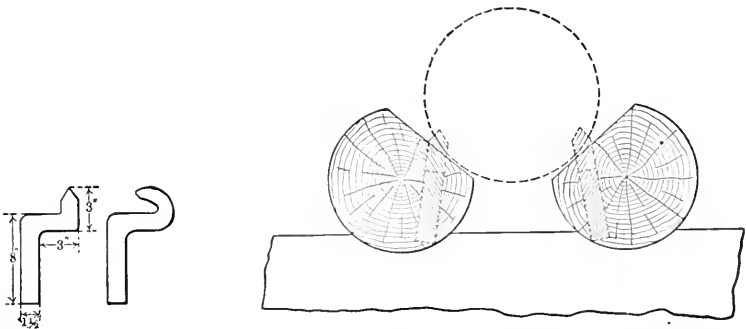

FIG. 94. — Two Common Forms of Goose-necks used for checking the Speed of Logs on Heavy Grades, and the Manner of placing them in the Slide Timbers.

reduce friction. During the cold season such stretches are iced by throwing water on them at night. If the stretch is short and the water is close at hand it may be poured on with a bucket, otherwise a barrel is used in which two holes are bored in one end, one hole being over each slide stick. The barrel is then filled with water and lowered down the slide during the night.

On steep slopes where logs run fast and are apt to leave the slide, several devices are used to check the speed. A common one is a "goose-neck" or "scotch" made from $1\frac{1}{2}$ - or 2-inch round or square iron fashioned as shown in Fig. 94a and b. It is placed in a hole bored through a slide timber and the prong digs into the logs as they pass over it and their progress is retarded. Logs will leave the slide unless the goose-necks are

placed opposite each other. The holes in which the goose-necks are fitted are bored entirely through the slide timbers so that dirt cannot accumulate in them. When not in use the goose-necks may be removed or dropped into notches cut into the slide timbers for that purpose.

Another form of brake has a log one end of which is pivoted to a framework erected above the slide. The free end is armed with spikes that drag on the logs as they pass under them.

On long slides which have both very steep and slight pitches the use of animal draft for moving logs on the slow places is at times impracticable, especially in summer, because of the long steep climb from the lower to the higher elevations. Donkey engines placed at the foot of slides have proved successful both in holding logs back on steep grades and in pulling them over level stretches. A $\frac{5}{8}$ -inch line is used and, in a tow of from 6 to 10 logs, the main cable is attached both to the rear and the front logs. It is necessary to select large round logs for the front and rear, otherwise the tow has a tendency to buckle when being pulled along the slide. Straight chutes are essential when a yarding engine is used because logs will leave the chute when the pull comes on a curve. The greatest success in the use of a donkey engine in connection with log slides is in dry trailing chutes. The daily capacity of one slide in Idaho which was 2000 feet long was from 20,000 to 30,000 board feet.

The control of logs on a chute so steep that the logs either left the slide before they reached the bottom or were badly damaged at the bottom by breakage was solved by an Oregon logger in the following manner.¹ The chute was 1600 feet long and the difference in elevation between the head and foot of the slide was 600 feet. A 6 horse-power gasoline engine was installed at the head of the slide and belted to the shaft of a donkey drum, which was equipped with a hand brake and a friction clutch. The engine was run continuously, power being transmitted from the shaft to the drum by the friction clutch. A $\frac{9}{16}$ -inch cable was wound on the drum and to the free end a 14- by 40-inch round hold-back block was attached to the under side of which a 4- by 6- by 30-inch rudder was fastened which served to keep the hold-back block in position. The cable was attached to the base of the front end of the hold-back block and then carried

¹ The Timberman, March, 1915, p. 36.

diagonally through the block to the upper rear end.¹ The slide timbers were spaced 5 inches apart and the cable ran in this space underneath the turn of logs. An automatic dump was installed at the foot of the slide by cutting a rectangular section 15 by 60 inches in size from the slide timbers.² A turn of logs was made up at the head of the slide behind the hold-back block

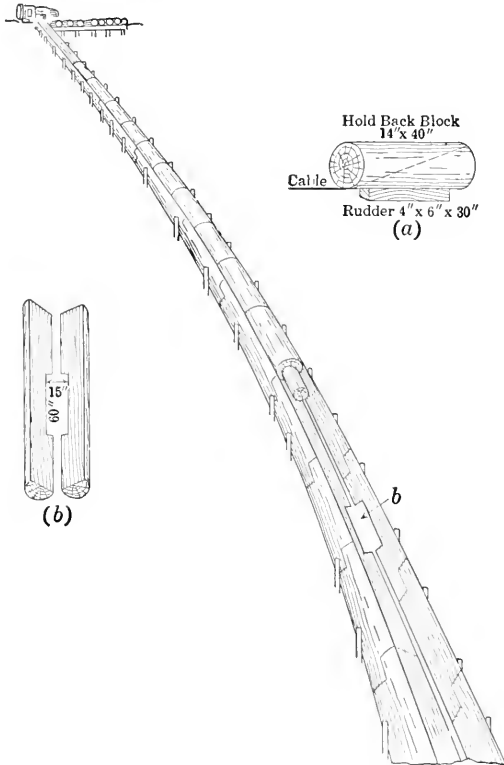

Adapted from The Timberman.

FIG. 95. — A Snubbing Device for lowering Logs down a Chute.

and then lowered by gravity, the speed being controlled by means of a friction brake. When the hold-back block reached the automatic dump the pressure of the logs behind it caused it to turn downward into the slot in the slide and the logs passed over it. The friction was then thrown into gear and as the drum reeled in the cable the hold-back block was pulled up to the head

¹ See Fig. 95a. ² See Fig. 95b.

of the slide. A round trip was made in 8 minutes, from 1500 to 2500 board feet being lowered at one time. Two men were required to operate this system, one to roll logs into the chute and the other to manipulate the drum.

Several slide tenders are required to keep slides greased and watered, adjust goose-necks and make repairs. As a general rule, several kinds and sizes of logs are run indiscriminately during the day, and it is necessary to use goose-necks on large logs and to remove them for the slower running small logs. Where logs have jumped out, laborers are required to return them to the slide. This is done by building an improvised chute from the ground to the slide, and dragging the logs up with a team and tow line, or by rolling the logs up by hand on spiked skids. This work is done after the season's sliding has been completed.

COST

Slides vary greatly in cost depending on their character, the amount of cribbing required, the number of curves, the season of the year in which they are built and the efficiency of the labor.

Running slides are the most expensive form to construct, because they must be built stronger and more rigid than other forms. Curves require about one-third more labor to build than straight stretches. Slides constructed during the winter cost about 25 per cent more to build than during warm weather and are often troublesome in the spring when the frost leaves the ground.

BIBLIOGRAPHICAL NOTE TO CHAPTER XVI

- VON ALMBURG, Dr. F. ANGERHOLZER: Beitrag zur Kenntnis der dynamischen Vorgänge beim Abriesen des Holzes in Holzriesen. Centralblatt für das gesamte Forstwesen, April, 1911, pp. 161-179.
- FORSTER, G. R.: Das Forstliche Transportwesen, pp. 45-68. Mortiz Perles, Wien, 1888.
- GAYER, Karl: Forest Utilization. (Schlich's Manual of Forestry, Vol. V, pp. 316-322; translated by W. R. Fisher.) Bradbury, Agnew and Co., Ltd., London, 1908.
- KUBELKA, August: Der Riesweg als Holzbringungsanstalt des Hochgebirges. Centralblatt für das gesamte Forstwesen. Wien, Aug.-Sept., 1903, pp. 325-377.
- SCHÖNWIESE, Heinrich: Die Wegriesen im Reichforste Cadino. Centralblatt für das gesamte Forstwesen, Aug.-Sept., 1903, pp. 377-387.
- STODDARD, E. I.: Chute Logging in Eastern Oregon. The Timberman, July, 1920, p. 35.

CHAPTER XVII

FOREST RAILROADS

POLE ROADS

Pole roads were formerly used by lumbermen because the material for construction could be secured on the operation at no expense except for labor and stumpage but they are primitive in character and are now seldom used except on an occasional small operation where sawed wooden rails or steel rails cannot be secured at reasonable cost. Animals are used as draft power, although on down grades the cars may descend by gravity under control of a brakeman. Pole roads are seldom built for distances greater than from 2 to 2½ miles.

A 25-foot right-of-way is required from which all brush must be removed and stumps grubbed out or cut level with the ground. The grade is then established. Turnouts for returning teams are provided at intervals of from $\frac{1}{4}$ to $\frac{1}{3}$ of a mile. On a track of this character, ascending grades greatly decrease the hauling ability of animals. The maximum grade for loaded cars hauled by two animals is 1.5 per cent. Where eight horses are used trams with 15 per cent ascending grades on the route to the woods and 3 per cent ascending grades for loaded cars en route to the mill have been used successfully.

The roads have a gauge of 5 or 6 feet, and the rails are long, straight poles from 9 to 12 inches in diameter, with as little taper as can be secured. They are hewed on the inner face to reduce friction on the wheel flange and are laid with the butts all in one direction, the top of one pole being lap-jointed to the butt of the following one. When they are not of the same size at the joint they are hewed down until the car wheels can pass over them readily.

On a hard bottom the poles are laid directly on the ground and are ballasted to make an even track. They are braced at frequent intervals by stakes driven close to them on the out-

side. At curves where the track is likely to spread, braces are placed between the rails and also between the outer rail and trees or stumps. Poles are held together at the lap-joints and fastened to the cross-skids by means of wooden trenails from $1\frac{1}{2}$ to 2 inches in diameter, which are driven into the ground through a hole bored in the pole and skid. Cross-skids are used only on soft ground



Photograph by H. R. McMillan.

FIG. 96. — A Pole Tram-road for Summer Use. The poles are removed during the winter and the right-of-way used as a sled road. Idaho.

and are spaced from 6 to 8 feet apart. They are short round blocks placed under the rails but they do not extend across the track as they would interfere with the foothold of the draft animals.

A crew for building a pole road comprises six men and one team. When the poles can be obtained along the right-of-way a crew will cut and peel the necessary ones and build 500 feet of straight track daily. Curves require about one-third more labor than straight track.

The maintenance of a pole road is low. The chief items aside from the occasional replacement of a pole, are the removal of splinters from the rails, usually with a spade, and greasing the rails with skid grease. One man can maintain 2 miles of track on half time.

The cars are built with a heavy framework of sawed timbers mounted on four wheels, each of which is about 42 inches in

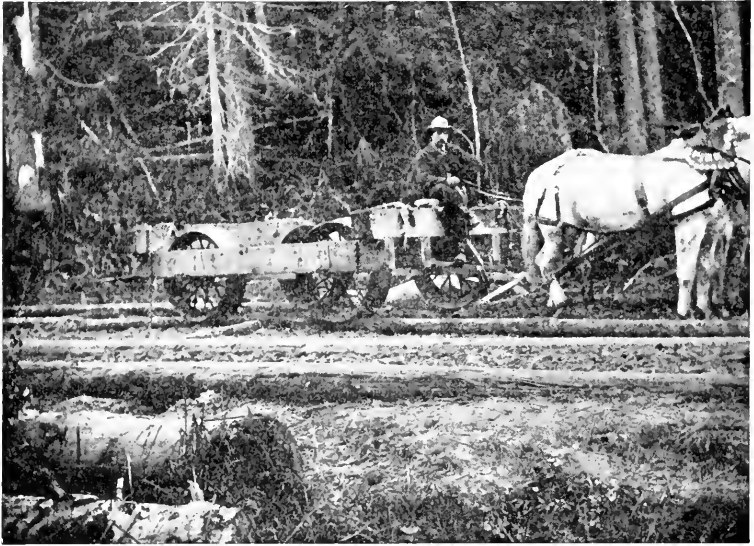

Photograph by H. R. McMillan.

FIG. 97. — A Car used on a Pole Tram-road. The capacity of this car is approximately 1400 board feet. Idaho.

diameter with a slightly concave face, a 4-inch flange on the inner side and a 2-inch flange on the outer. Each wheel turns on a 2-inch fixed axle provided with a side play of 6 inches so that the wheels can adjust themselves to the inequalities of the rail and the uneven gauge.

The bunks are 10 feet long and from 10 to 12 feet apart. A reach which passes through the body of the car and projects $2\frac{1}{2}$ feet beyond the bunks serves as a point of attachment for the draft power.

Cars of this character drawn by two horses will carry 1400 board feet per load. A team will haul loaded cars from 8 to 10 miles daily.

On an Idaho pole tram $1\frac{1}{2}$ miles in length, two horses hauled from 7500 to 9000 board feet daily, each car load containing approximately 1600 feet. On the Pacific Coast a team of eight horses hauled 20,000 feet daily on a $1\frac{1}{2}$ -mile tram road, each car averaging 5000 feet.

Two horses are commonly used although on the Pacific Coast as many as eight are employed on some of the roads.

Light geared locomotives have been used to a limited extent but they are not adapted to this type of rail.

STRINGER ROADS

The stringer road soon superseded the pole road on operations where a sawmill was available for sawing rails.

The early stringer roads were operated by animal power but light geared locomotives or motor trucks are now used almost exclusively except for stocking very small mills.

Stringer roads have a greater capacity than pole roads and may be used to stock a single-band mill. They are employed chiefly on operations where suitable hardwoods are abundant for rails, where the operation is remote and the cost of transporting steel rails is excessive, and when the length of haul is comparatively short and the daily output limited. Such conditions exist in the hardwood region of the Appalachian mountains where this type of road is common.

The disadvantages of a stringer road as compared with steel-railroads are that the rails become soft and wear out rapidly in rainy and wet weather; wheel flanges climb wooden rails more readily than steel; the cost of repairs and materials for a year's operation will largely meet the first cost of steel rails; and the road is about 75 per cent less efficient.

The right-of-way for a stringer road must be carefully graded and crib bridges or trestles built where necessary. The grades should not exceed 3 per cent on the main line and 8 per cent on spurs. The preparation of the roadbed is as expensive as for a narrow-gauge steel road, the only saving effected being the original cost of rails.

A stringer road 3 or 4 miles in length is limited in capacity to 40,000 or 50,000 board feet of logs per day.

The rails are 6 by 6 inches in size and are composed of two sawed pieces, each 3 by 6 inches, placed one on top of the other.

They are fastened to the crossties and to each other by wire spikes. The top rail must be of some wood that will not splinter readily, such as beech and hard maple. Sometimes the rail is also covered with strap iron to prevent wear. The lower rail may be made of an inferior grade of timber such as wormy oak.

The rails are spiked to round crossties from 8 to 12 inches in diameter and 7 feet long, which are cut along the track and are



FIG. 98. — A Stringer Road in the Appalachian Mountain Region.

spaced from 18 to 24 inches apart on main lines, and from 24 to 30 inches on spurs. The gauge is $3\frac{1}{2}$ or 4 feet.

The cost of maintenance of a stringer road in constant use is high because the rails sliver badly and break, requiring such frequent repairs after the first six months that the road must be practically rebuilt in two years.

The cost of constructing stringer roads, exclusive of the value of the timber used, ranges between \$800 and \$1200 per mile, but if many bridges are required the cost is higher.

Geared locomotives are used, the weights varying from twenty-five to thirty tons on main lines and from fifteen to seventeen tons on spurs. Larger ones are too heavy for a wooden track.

A light-weight, 2-truck, 8-wheeled skeleton car is preferred for

these roads. The wheels are 20 or 24 inches in diameter with a 6-inch tread which helps to keep them on the tracks where the gauge is too wide. Cars of this character, built for handling logs up to 20 feet in length, are from 22 to 24 feet long with bunks $7\frac{1}{2}$ or 8 feet wide, and are equipped with handbrakes. Each car weighs about 2 tons, has a rated capacity of from 15,000 to 20,000 pounds weight and usually carries from 1000 to 1200 board feet of logs.

A more simple type of stringer road for use with motor trucks has been used successfully in the South during the last few years. The track consists of 3- by 4-inch wooden rails spiked on 2- by 8-inch stringers placed on the ground. Crossties are not used to support the track. In one case, power was furnished by a $2\frac{1}{2}$ -ton motor truck with double-flanged steel tires, which pulled a two-wheeled trailer. The latter had double-flanged steel tires and the wheels were mounted on fixed axles which permitted a side play of several inches. This equipment carried from 1000 to 1500 board feet per load, and a round trip of $\frac{3}{4}$ mile was made in from 20 to 30 minutes.

STEEL-RAIL ROADS

The successful use of steel-rail logging roads began in 1876, when Scott Gerrish, a logger in southern Michigan, built a railroad for transporting logs from Lake George to the Muskegon River down which they were driven to the mill.

Rail transport is gaining in favor in all sections of the country and with high stumpage values will become the preferred form of transport except where conditions are especially favorable for motor truck transport or for floating and rafting. The only region in which their use is not extensive is in the New England States where water transportation has been the custom for years, due chiefly to the fact that many of the merchantable species will float. The region also is traversed by numerous streams and trunk lines have not penetrated the forest regions to any extent.

Advantages of Railroad Transportation

(1) Accessibility. Railroads have made large areas of timber accessible which otherwise could not be logged because of the lack of streams for floating logs, or the absence of suitable manu-

facturing sites and shipping facilities on the natural water outlets.

(2) Independence of climatic conditions. Rail transport renders a logger practically free from climatic influences since he is not dependent on a snowfall to furnish a bottom for hauling, or on flood waters to float his logs. This enables him to operate throughout the year, with possible short interruptions due to heavy rainfall or snowfall.

(3) Market conditions. The use of railroad transport does not force the manufacturer to anticipate market conditions months in advance, because logs can be cut and hauled to the mill on short notice and special requirements for long timbers or for a heavy cut can be readily met. The plant can be closed during dull market periods without carrying on hand a large quantity of logs in the forest, subject to damage from fire, insects, and sapstain. The operator can turn over his money at frequent intervals and need not invest a large sum in advance in logging expenses.

(4) Utilization of hardwoods. The logger is able to bring out all species. This reduces logging expense, because of the heavier stand per acre secured.

(5) No loss of logs in transport.

(6) Clean logs. Rail transport lands the logs at their destination free from gravel, sand, iron and other foreign matter. A hardwood manufacturer operating on one of the large rivers estimates that clean logs can be manufactured 15 cents per thousand cheaper because of the saving in saws, saw-filing expense and lost time on the part of sawmill labor. This saving is very appreciable in large plants. The value of some hardwoods, such as basswood for cooperage stock and birch for spool stock, is strongly influenced by the brightness of the wood, and even though such species can be floated their value is often reduced by exposure to weather and water.

Railroads for logging purposes can usually be constructed much cheaper than trunk roads because higher grades and sharper curves can be used and also because the roadbed need not always be placed in first-class condition to do satisfactory work. In a rough region, however, the initial expense is great and the cost may be prohibitive if many miles of road must be constructed to reach a tract. Under normal circumstances, rail-

roads are chiefly adapted to large operations since the construction charge must be distributed over a large tonnage if the cost per thousand board feet of timber handled is to be kept within reasonable limits.

CHOICE OF GAUGE

The choice of a narrow- or standard-gauge road for logging operations should be governed by the size of the operation, the topography, the amount of capital available for investment, the initial cost of construction and equipment and also by the cost of operation, because the increased construction cost of a standard-gauge may be more than compensated by a reduced operating charge.

Narrow-gauge roads can be constructed cheaper than standard-gauge because (1) the width of cuts and fills is less; (2) sharper curves¹ can be used because of the shorter wheel-base of locomotives and cars; (3) the cost of track laying is less per mile owing to the use of lighter rails and ties; (4) the initial expense for rolling stock and motive power is not so great.

There is little difference in the cost of trestles and other timber work for narrow- and standard-gauge roads. A narrow-gauge road is desirable for a limited output in a rough region because the cost may be one-third less than that of a standard-gauge. It therefore appeals to loggers with limited funds. It is also desirable in light or scattered stands where the track must be moved frequently. On soft bottom the track is easier to keep in operating condition owing to the lighter equipment used and the smaller loads hauled.

Where a large tonnage is handled, standard-gauge roads are more economical to operate because larger locomotives and cars can be used and the cost of operation per thousand board feet for wages, fuel, oil and repairs for the heavier locomotives and cars will be less because of increased hauling capacity.

Standard-gauge is also desirable because trunk-line cars may be operated over the logging road. This is a great advantage where logs, pulpwood, tanbark and other forest products are to be shipped to outside points, since cars can be loaded in the forest and hauled to destination without reloading.

¹ Curves as high as 50 degrees have been negotiated by narrow-gauge geared locomotives but a lower degree is desirable for efficient work.

RIGHTS-OF-WAY

The right of loggers to build railroads across the lands of others is not recognized by the courts except where the roads have been chartered by the State. In the latter case the right of Eminent Domain is granted, and a line can be forced across foreign holdings by condemnation proceedings and the payment of just compensation to the owner.¹

Many logging roads are not incorporated because the route does not tap a section in which any tonnage, other than that of the owners, originates. Further the incorporation of the road subjects it to regulations governing the hours of labor for train crews, use of air brakes, height of draw bars on the equipment, filing of tariffs, and the submission of reports to the State Railroad Commission.

Chartered roads must be prepared to handle freight and passenger traffic, and many logging companies do not feel justified in maintaining the necessary equipment for this purpose, especially since the handling of outside traffic at times interferes with the operation of logging trains.

Where the owner of a non-chartered road desires a right-of-way across the property of another the land may be bought at private sale, although this course is seldom desirable unless the road is ultimately to become a "common carrier," inasmuch as a narrow strip of property is of little value to the owner and is difficult to sell at the conclusion of logging operations. The more frequent practice is to lease land for a right-of-way for a period sufficient to permit the removal of timber. Such leases can usually be secured on terms satisfactory to all parties, although exorbitant rental is sometimes demanded, when the topography compels the location of the road within restricted limits, such as in a narrow valley.

When timber rights are purchased without the fee to the land, the contract of sale should specify that the purchaser has the right to construct such roads as are necessary to secure the

¹ In the case of Healy Lumber Co. vs. Morris, 33 Washington 490, the Court held that a logging company performing no public function was without power to condemn a way for a logging railroad, notwithstanding the legislature had purported to confer on it that power. The state constitution grants the right to take private property only for private ways of necessity and, therefore, such necessity must be proved.

timber. Even if such a stipulation is not made, some courts¹ have ruled that a sale, or grant of standing trees implies a right of access and the use of the land for the purpose of cutting the timber and afterwards removing the logs. Unless some specific date is mentioned on which these rights terminate, the buyer is entitled to a "reasonable time" for removal of the timber. In case of litigation the length of time covered by the contract is decided by the courts after consideration of the specific case. The use of a strip of land as a right-of-way for a logging railroad by and with the consent of the owner does not give the logger the permanent use of such property unless there has been a specific grant by the land owner, or unless the road bed has been in use for a period long enough to establish a legal right to it by adverse possession.²

LOCATION

The location of the main line of a logging railroad is of great importance, for the engineer must preserve a proper balance between the cost of construction and the maintenance and operating charges. He must choose between an expensive roadbed with low grades and easy curves, or a cheaper roadbed with increased maintenance and operating expenses.

(1) Roads in a rolling or rough region usually enter the tract at the lowest point and follow natural drainage, because it often affords the best grade out of the region and the operator can bring his timber to the main line on a down grade. Roadbeds along natural drainage should be placed above high-water mark when possible, although on roads which are to be used only for a short period, it may be cheaper to build near the stream and suffer a few washouts rather than incur a very heavy construction expense.

(2) The shortest possible route is desirable, but it is better to increase the length of line if heavy cuts, fills, and bridge and trestle construction can be avoided.

(3) "Velocity" grades are often used to advantage in crossing "draws" or depressions but they are feasible only on straight

¹ See a decision of the Supreme Court of Tennessee. *Carson vs. Three States Lumber Company* (Tenn.), 69 Southwestern Reporter, 320. 1902.

² See *Brandon vs. Umpqua Lumber and Timber Co.* 146 Pacific Reporter 46. 1915.

track, for it is dangerous to run trains at high speed on a curved track which has a descending grade. In addition to their influence on the hauling ability of a locomotive, steep pitches are a disadvantage on a road because the track tends to work towards the lower levels and not only is the expense of maintenance greater than for a fairly level road but also the danger of wrecks is increased.

(4) Where logging railroads must cross ridges or ascend or descend very steep grades in a short distance, "switch backs" are preferable to doubling back with a curve since the latter method often necessitates a heavier construction expense. Switch backs and inclines often are the only means at hand for securing timber from elevations above or below the main line.

(5) Grades should not exceed 3 per cent and curves should not exceed 12 degrees on roads that are to be used for several years and over which a large amount of timber is to be hauled, although in a rough region these figures are often increased in practice.

Location in a region without marked topographical relief, such as the flat pineries or the cypress swamps of the South, presents no special difficulties. The main object is to bring the railroad to the timber by the shortest and cheapest route. The construction cost is low on dry lands in these regions, because only limited quantities of material, chiefly earth, must be moved to make the roadbed. Where swamps are crossed piling is used and numerous bridges or trestles may be required, but even here the cost per mile is less than the average in a mountainous region.

In the flat and gently rolling regions of the South the main lines often are located by the woods foreman, although in many cases, engineers could be employed to advantage. In a rolling or rough country, location presents difficult problems, because roads must be confined chiefly to natural drainage and often the only means of access to timber is over a route requiring heavy cuts and fills and expensive bridge and trestle construction. The location of logging railroads in a rough region should be done by a location engineer who is an expert logger. Good railroad engineers without logging experience are usually a failure at logging railroad work because they are not able to subordinate some of their ideals regarding standard railroad construction to the demands of practical logging. Some companies have sufficient work to

furnish continuous employment for logging engineers while others secure their services only when needed.

Spur lines are located with less care than the main lines for they are shorter and of cheaper construction, since they are to be used only for a brief period and a limited amount of timber is to come out over them. They should follow natural drainage in order to provide a down-haul for animal logging, but if power skidders are used the roads may be placed on high ground and the logs dragged up grade, as it is often cheaper to construct and maintain a road on the higher ground, the skidding machine will bring logs up grade as easily as down, and the logs do not acquire momentum and foul the cable, or catch so readily behind stumps or débris.

In fairly level regions, where animals are used for logging, spurs are preferably located so that the maximum haul from any part of the operation will not exceed $\frac{1}{4}$ of a mile, except for small isolated tracts, which do not warrant the expense of building a railroad to them. Where a snaking system is used and the aim is to log all parts of the tract by this system, spurs should be placed approximately parallel to each other and from 1200 to 1600 feet apart, for the maximum efficient radius of the machine does not exceed 800 feet. In cypress and other forests where the area is logged by the cableway system, the spurs are placed parallel and from 1200 to 1400 feet apart. On the West Coast, overhead systems often operate for distances of from 1000 to 1200 feet from either side of the railroad. In mountainous sections spur roads follow main and secondary drainage. Distances greater than 3000 feet are not considered desirable for overhead skidding systems although the spans may be as long as 4000 feet, when the stand is light or railroad construction costs are too high for the amount of timber secured. On the Pacific Coast some operators build their spur roads to the yarding engines. Where spur construction is costly the logs may be brought to the main line by road engines, swing donkeys, slides or flumes. In the Appalachian region spur construction is limited, and railroads are confined to the larger branches of the streams.

The grades and curves permissible on spurs are greater than on main lines because a slow speed is maintained, and lighter motive power is used. For the sake of efficiency and safety it is always desirable to keep grades and curves as low as possible,

although short spurs may have ascending grades as high as 6 per cent for loaded cars, and from 8 to 10 per cent for empty ones, and curves as high as 40 degrees, although they should not exceed 15 degrees under average conditions.

Geared locomotives, only, are suitable for steep grades and sharp curves. The short wheel base permits the locomotive to make sharp turns, and increased power is secured through the gearing. However, on steep grades and sharp curves a geared locomotive can haul only a few cars at one time.

Methods of Location.—Main line location is preceded by reconnaissance work which enables the engineer or logger to determine the problems which confront him and to select one or more feasible routes. In this work a topographic map is very helpful and is now considered an essential part of the equipment of an operator in a rolling or rough region. Such maps may be prepared in connection with a timber cruise, but if not available previous to railroad location they are prepared in connection with reconnaissance. Contour intervals varying from 10 to 50 feet are used depending on the accuracy required and the roughness of the country. Relative differences in elevation are of more importance than absolute differences, because the logger is chiefly interested in the location and height of ridges, degree of slope, width of valley bottoms, size and character of streams, and like factors which have an influence on cheap railroad construction. There is no standard method in use by engineers for collecting data for the preparation of topographic maps. The aneroid barometer, hand level and pocket compass may be the only instruments used, although control points both for distance and elevation may be established by chained compass or transit lines and a line of "Y" levels run along section or other lines. One method used by a western logging engineer on his reconnaissance survey, preliminary to location, is to run out and blaze all section lines; determine distances by pacing, which are checked on quarter-section and section corners; and secure elevations by means of an aneroid barometer. A rough topographic map is prepared from this data and furnishes a basis for the preliminary location.

Having roughly determined the route of the road, the preliminary location follows. The engineer is aided in this work by one or two rod men and two or more axmen, depending on the density of brush along the route. When an expensive road is to

be built, engineers recommend the use of a transit in preliminary work, because of the accuracy demanded in final results. Some use a railroad compass and a hand level of the Abney type both for main lines and spurs. In a fairly level country the railroad compass will meet all needs, in fact some find a small staff compass ample.

The engineer, having traveled over the proposed route one or more times and knowing the problems to be solved, locates a line of tangents and sets stakes marked with the station number, at 100-foot intervals along the right-of-way. As the line progresses, the engineer, by trial, selects the points which will keep his grades and curves within the limits set for the line. Several trial lines may be necessary to secure a satisfactory grade.

On spur lines in a rough region and on main lines in a fairly level region, the preliminary survey is dispensed with. A railroad compass or a box compass is often used in lieu of a transit, and in many sections the woods foreman or superintendent replaces the engineer.

A common method in the pineries of the South is to locate a line of tangents by the use of three 6-foot straight pickets, along which the locator sights, placing center stakes at 100-foot intervals.

The final location of the line of tangents is followed by the location of curves. Loggers have a number of rule-of-thumb methods of locating curves, which, although somewhat inaccurate, are satisfactory for railroads where a high degree of engineering ability is not demanded. Many who use rule-of-thumb methods determine the deflection angle by eye and lay off trial curves, persisting until they find one which will connect their two tangents. Several methods are in general use by logging engineers for laying out curves on logging roads, among them the tangent-offset method; offsets from chords produced, the field man using a table of offsets for a given degree of curvature; by computing in the office from a plotted traverse the offsets from stations on a line of tangents followed by field location; and by the use of a transit or compass to lay off stations on a curve by means of deflection angles.

On main line work in a rough region, the location survey is followed by a line of levels which furnish data for a profile map on which the "elevation of grade" is shown. This is preliminary

to making an estimate of the cost of moving earth and rock. The cubic yardage is computed from cross sections¹ taken along the proposed grade at each station on level or fairly level ground, and at every point where there is a decided change in the configuration of the surface.

BIBLIOGRAPHICAL NOTE TO CHAPTER XVII

- CLARK, E. T.: Pacific Coast Logging. West Coast Lumberman, May 1, 1920, pp. 81 to 92.
- ELLIS, L. R.: Necessity for an Accurate Topographic Map in Logging Operations. Timberman, July, 1911, pp. 49-53.
- HENRY, H. P.: Advantages of Topographic Surveys and Logging Plans. The Timberman, August, 1912, pp. 65-67.
- PEED, W. W.: Necessity for the Logging Engineer in Modern Logging Operations. The Timberman, August, 1910, pp. 47-49.
- RANKIN, R. L.: Practical Topographical Surveys for Building Logging Roads. The Timberman, March, 1912, p. 27.
- VAN ORSDEL, John P.: How to Obtain the Highest Practical Efficiency in Woods Operations. The Timberman, September, 1910, pp. 48-51.
- VAN ORSDEL, John P.: Topographic Survey and its Economic Value in Logging Operations. The Timberman, August, 1910, p. 64.
- WOOD, A. B.: Accurate Topographic Map is a Good Investment in Logging Operations. The Timberman, August, 1912, p. 67.

¹ See "Earthwork and its Cost," by H. P. Gillette. McGraw-Hill Book Co., New York, 1912, pp. 175-182. "Highway Construction," by Austin T. Byrne. John Wiley and Sons, N. Y., 1902, pp. 447-454. "Theory and Practice of Surveying," by J. B. Johnson. John Wiley and Sons, New York, 1901, pp. 438-471.

CHAPTER XVIII

RAILROAD CONSTRUCTION

The construction of the roadbed for a logging railroad usually precedes logging by a few weeks, although it may be several months or a year in advance which is an advantage because the roadbed has an opportunity to settle before the steel is laid and the road operated. This gives a more stable track and one that is cheaper to maintain. In regions subject to heavy rainfall and where the earth washes badly, this practice is not desirable since the roadbed will suffer through erosion.

CLEARING THE RIGHT-OF-WAY

Previous to starting the grading of the right-of-way, it is necessary to cut and remove the standing timber, brush and stumps which will interfere with the roadbed. This work often is done by contract at a stated price per acre, with or without an additional payment for all merchantable saw logs cut.

Main line rights-of-way are generally cut 100 feet wide in order to prevent the track from being covered with "down timber" during wind storms. On spur roads the right-of-way is from 18 to 50 feet wide. In the South, however, rights-of-way for spurs often are made 120 feet wide in order to provide skidway space on each side of the track. The right-of-way crew fells the timber, removes the stumps from the roadbed, if necessary, and cuts the brush from the skidway site. The timber adjacent to the roadbed usually is not felled until the surrounding area is logged, because insects seriously damage felled timber that remains in the forest during the warm months. When the skidway sites are cleared by the skidding crew the cost is greater than when it is done by a special crew both because of the enforced idleness of the teams and the low efficiency of teamsters when performing swamping work which is usually distasteful to them.

The timber cut from a right-of-way may be used for saw logs, culverts, trestles, bridges, corduroy and for filling in low places to reduce the amount of earth required for fills. Material of merchantable value both from green and "dead-and-down"

timber is cut into saw logs and piled on skidways along the right-of-way outside of the grade line.

On main lines and spurs all stumps should be removed from the roadbed unless they are on the site of a proposed fill and will be covered with at least 1 foot of earth; or so located that they will not furnish a bearing for any part of the track; or the character of the ground is such that the removal of the stump during wet weather will cause a soft spot which cannot be kept up during the rainy period.

Where the stumps are to be covered with earth they are cut off near the ground. Those on the right-of-way outside of the roadbed may be cut at any convenient height that will not interfere with the passage of locomotives, log cars, skidders or other equipment. Stumps may be removed by blasting with powder or dynamite, by grubbing or by burning. Blasting often is the cheapest method, but it disturbs the earth for some distance around the stump. The portions of the roadbed from which stumps have been removed by blasting often remain soft for months afterward and during wet weather may be difficult to keep in proper condition. As a rule, southern pine stumps from 24 to 30 inches in diameter will require one day's labor for grubbing. Small- and medium-sized trees can best be removed by cutting all roots from 3 to 4 feet from the base of the tree and allowing the weight of the crown and bole to aid in pulling out the stump.

The construction of the roadbed follows the felling of the timber and the removal of stumps. This covers the movement of earth and rock for cuts and fills, the construction of trestles, culverts, cribbing and other timber structures.

FILLS AND CUTS

Fills on a logging road should be 12 or 14 feet wide on top for a standard-gauge road and 10 or 12 feet wide for a narrow-gauge. The standard slope for an earthwork fill is $1\frac{1}{2} : 1$.¹ When the fill is made from solid rock, a 1 : 1 slope may be ample.

¹ The angle of repose or slope that a face of earth makes with the horizontal when not subjected to the elements is as follows:

Compact earth	50 degrees or $\frac{3}{4}$ to 1
Clay, well drained	45 degrees or 1 to 1
Gravel	40 degrees or $1\frac{1}{4}$ to 1
Dry sand	32 degrees or $1\frac{1}{4}$ to 1
Wet sand	22 degrees or $2\frac{1}{2}$ to 1
Vegetable earth (loam)	23 degrees or $1\frac{3}{4}$ to 1
Wet clay	16 degrees or 3 to 1

In cuts the roadbed must be wide enough to give room for a drainage ditch on either side. These will require about 3 additional feet each, and the cut should be about 16 feet at the base. They must be wide enough to permit the passage of any equipment that may be taken over the road. In earth cuts the ratio of slope is $1\frac{1}{2} : 1$ and in solid rock cuts the walls are perpendicular or nearly so.

Main lines are graded up carefully, and suitable ditches maintained. Even on level sections it is desirable to elevate the

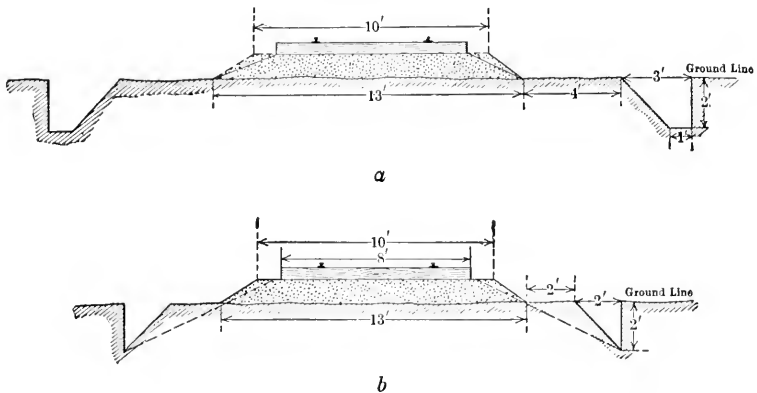

FIG. 99. — Two Methods of constructing a Grade for a Logging Railroad. *a*, main line spur. *b*, secondary spur. The ditch is cut to the dotted line when the track is surfaced.

track and put in ditches, because of the cheaper cost of maintenance during wet weather.

Types of main line spur tracks used in southern Arkansas are shown in Fig. 99. The earth from the ditches is sufficient for ballasting the ties and the grade costs but little except for the ditches.

On spurs a minimum of fill and cut work is done and ditching is not resorted to unless absolutely necessary.

When fills of 2 or more feet are to be made on spur roads, it is a common practice to fill the bed of the grade with logs, if nonmerchantable timber is close at hand, and to place a cover of earth over them to give a bearing for the ties. This practice cheapens the cost of construction, especially when earth for a

fill must be taken from a "borrow" pit. This type of roadbed will last for at least one year.

The movement of earth and rock in the construction of cuts and fills is most frequently done by contract. The unit on which payment is based is the cubic yard, the material being measured "in place," that is, in the natural bank before it has been disturbed. It is customary to classify the material to be moved and to regulate the prices accordingly. The classification and quantity of material moved are determined by the supervising engineer.

The following standard classification is in extensive use:

(1) *Earth*. — Loam, sand, gravel or clay. Material that can be handled with a pick and shovel, or that can be plowed readily.

(2) *Hardpan*. — Very dense clays and gravels, cemented with iron oxide. Soft shales that are easily worked may also be included.

(3) *Loose Rock*. — Shales and other rock that can be quarried without blasting, although blasting may be resorted to occasionally.

(4) *Solid Rock*. — Material requiring blasting for removal.

The contract price per cubic yard for the removal of earth or rock usually includes excavating, hauling, and placing the material in a fill or a waste pit. It is not customary to pay for making a cut and also to pay for a fill made from the same material; in other words, payment for a given cubic yard is made but once. Grading contracts may have an "overhaul" clause which provides that for all earth hauled more than a specified distance ("free haul"), the contractor shall be paid a stated sum per cubic yard for each 100 feet of overhaul. On logging operations the length of free haul ranges from 100 to 500 feet.

The price paid for moving material varies greatly in different regions and is influenced by the length of haul, the kind of material moved, the character of classification, the degree of accuracy used in actual classification and the season of the year; the cost of winter work being about 25 per cent higher than that of work done during the summer.

The average work on logging roads except on the Pacific Coast usually presents no special problems and can be performed with simple equipment which does not require a heavy financial

outlay. Loggers are able, therefore, to contract with local men on favorable terms.

MOVEMENT OF EARTH¹

The movement of earth for road construction, railroad grades and trails may be performed in various ways among which the following are in general use:

(1) With pick and shovel, the earth being loosened by the pick and then thrown directly out of the cut.

(2) Loosening by pick or plow and transport on wheelbarrows, two-wheeled dump carts or dump wagons.

(3) Loosening by plow or by dynamite and transport on drag scrapers, wheeled scrapers or dump cars with horse draft.

(4) Steam shovel, either casting the dirt on or off the grade or placing it in dump or flat cars for transportation away from the site.

(5) Power drag scraper, moving material from cuts or to fills.

The first three methods are used by owners of comparatively simple and inexpensive outfits. Steam shovels and power drag scrapers are used chiefly in the West where a large amount of earth and rock often must be moved in making a logging railroad grade.

Plowing. — Contractors usually assume that a team and driver, with a helper to hold the plow can loosen 25 cubic yards of fairly tough clay, 35 cubic yards of gravelly loam, or 50 cubic yards of

¹ Earth of various kinds increases in bulk when disturbed for removal, as shown in the following table:

Character of material	Increase in bulk
	Per cent.
Earth, freshly loosened.....	14 to 50
Clean sand and gravel.....	14 to 15
Loam, loamy sand and gravel.....	20
Dense clay, dense mixtures of gravel and clay.....	33 to 50
Unusually dense gravel and clay banks.....	50

Shrinkage in volume of embankments is dependent on the method used to compact them. Loose earth with rainfall as the only compacting element will be about 8 per cent above normal at the expiration of a year. Earth compacted with two-wheeled carts or scrapers occupies from 5 to 10 per cent less space than it did "in place" and will shrink slightly more during the next few years.

loam, per hour. A pick-pointed plow drawn by four or six horses and with two men riding the plow beam, is required for breaking up tough clay or hardpan, the usual rate being from 15 to 20 cubic yards per hour. Thirty-five cubic yards of "average earth" per hour is considered satisfactory work.¹

Pick Work. — The pick is used only for light work and in confined places. In one hour a man will loosen from 1.6 to 2.3 cubic yards of earth, from 0.7 to 1.1 cubic yards of gravel, or 0.9 cubic yards of hardpan.¹

Picking and Shoveling. — Pick-loosened earth is nearly always handled with a shovel. This method of moving earth is of importance in forest work because most light railroad grades are constructed in this manner, and it is also used in trail building.

The following table¹ shows the average amount of cubic yardage picked and shoveled by one man per hour.

Material	Capacity per man per hour	Cost per cubic yard ¹	Authority
	Cubic yards.	Cents.	
Hardpan (clay and gravel)	0.4	37 $\frac{1}{2}$	M. Ancelin
Common earth.....	0.8-1.2	19-12 $\frac{1}{2}$	"
Hardpan.....	0.33	45 $\frac{1}{2}$	Cole
Clay (stiff).....	0.85	17 $\frac{1}{2}$	"
Clay.....	1.00	15	"
Sand.....	1.25	12	"
Sandy soil.....	0.8-1.2	19-12 $\frac{1}{2}$	Gillette
Clayey earth.....	1.3	12	"
Clay, fairly tough.....	0.9	17	"
Sandy soil, frozen.....	0.75	20	"
Gravel or clay.....	0.7-0.8	20	Billings
Earth.....	1.1-1.2	13-14	Hodgson

¹ Wages 15 cents per hour.

The hourly output per man shoveling average soil is 1.4 cubic yards, but this may be increased to 2 cubic yards under efficient supervision.

With Dynamite. — A logging operator in Mississippi describes² a method of making cuts in gumbo 5 feet or less in depth when the earth is to be "wasted." The reported cost was 50 per cent less than with the usual methods of moving earth.

Holes of the required depth and 20 inches apart were made

¹ The data on output are taken from "Earthwork and Its Cost," by H. P. Gillette. McGraw Hill Book Company, New York, 1912.

² See American Lumberman, July 15, 1911, p. 50.

with a round, sharpened bar. The outside row of holes had a degree of slant that would produce a cut with sides of the desired slope. After covering the site of the proposed cut with holes, they were loaded with 60 per cent dynamite. The center holes were loaded heavier than the others and were primed for electric firing. The explosion of the central charges fired the others. The length of cut blasted at one time did not exceed 200 feet. A large amount of the earth was thrown entirely out of the cut and the remainder was handled readily with a drag scraper. In tight wet earth one ton of 60 per cent dynamite will loosen earth for 1600 linear feet, where the maximum cut is 5 feet.

Wheelbarrows. — Barrows are not profitable for moving earth except on short hauls, for stony soil, and in places unfavorable for the use of horses. The average load on level runs is approximately 250 pounds or $\frac{1}{10}$ of a cubic yard of earth, and on fairly steep grades $\frac{1}{15}$ of a cubic yard, "place measure."

The average amounts moved, per barrow, on a level in ten hours and the cost per cubic yard for picking, shoveling and moving, when wages are 15 cents per hour, are as follows:¹

Distance	Quantity	Cost per cubic yard
Feet	Cubic yards	Cents
100	10.5	22.50
75	11.1	21.25
50	11.8	20.00
25	12.5	18.75

Two-wheeled Dump Carts. — These are used for transporting material for distances varying from 75 to 500 feet, and are especially serviceable on short hauls and in narrow cuts.

The average load of dump carts on level roads is 0.37 cubic yards, and on steep ascents 0.25 cubic yards, "place measure."

On short hauls one driver attends two carts, leading one to the dump while the other is being loaded. On long hauls he may handle two carts by taking both at one time. The carts are loaded at the pit by shovelmen.

When wages are 15 cents, and horse hire 10 cents per hour the average day's work on level ground for a one-horse cart of

¹ The figures on the amount of work performed and costs are based on data contained in "Earthwork and its Cost," by H. P. Gillette.

$\frac{1}{3}$ -cubic yard capacity, and the cost per cubic yard for plowing, shoveling and hauling average earth are as follows:¹

Distance	Quantity	Cost per cubic yard
Feet	Cubic yards	Cents
100	40.0	20.25
200	33.3	21.50
300	28.5	22.75
400	25.0	24.00

Dump Wagons. — When a wagon is used, a flat-bottom, two-horse type is preferred, which usually has the following capacity:

Character of road	Capacity
	Cubic yards
Very poor earth road.....	0.8
Poor earth road.....	1.0
Good hard earth road.....	1.6

A team will travel 20 miles per day on fairly hard earth roads, that is, 10 miles loaded and 10 miles without a load. On poor roads and soft ground 15 miles is the maximum distance. These rates of travel include occasional stops for rests.

When wages are 15 cents and horse hire 10 cents per hour, the cost per cubic yard, and the average amounts of earth moved daily are as follows:¹

Distance	Quantity	Cost per cubic yard
Feet	Cubic yards	Cents
300	75	20.1
400	..	20.8
500	..	21.5
600	..	22.2
800	50	23.6
1000	34	25.0
2000	26	32.0
3000	..	39.0
4000	..	46.0
5000	..	53.0

¹ The figures on the amount of work performed and costs are based on data contained in "Earthwork and its Cost," by H. P. Gillette.

Drag Scrapers. — A drag scraper is a steel scoop used for moving earth for short distances. It is the preferable form for stony ground and for soils filled with roots. It is drawn by two horses.

The No. 2 scraper, weighing about 100 pounds, is the one commonly used. Its actual capacity, "place measure," is $\frac{1}{6}$ of a cubic yard of tough clay; $\frac{1}{7}$ cubic yard of gravel; or $\frac{1}{5}$ cubic yard of loam.

Drag scrapers work in units of three on short hauls, the teams traveling about 50 feet apart in an ellipse. They are loaded by an extra man as they pass the pit and are dumped by the teamsters. On a 50-foot haul the average ten-hour output for a drag scraper is 62 cubic yards of earth and gravel, and 40 cubic yards of stiff clay. Earth for scraper work is loosened with a plow or by dynamite.

Wheeled Scrapers. — The wheeled scraper has a steel scoop hung low between two wheels. The following sizes are in common use:

Number 1 wheelers are used for short hauls and steep rises and should replace drag scrapers under these conditions except where the soil is rocky or full of roots. Snatch teams are required for loading No. 2 and larger scrapers, and even then it is impossible to fill the bowl in tough clay. Shovels must be used for this purpose.

	Weight	Actual capacity, ¹ "place measure."
	Pounds	Cubic yards
No. 1.....	340 to 450	$\frac{1}{5}$
No. 2.....	475 to 500	$\frac{1}{4}$
No. 2 $\frac{1}{2}$	575	$\frac{1}{3}$
No. 3.....	625 to 800	$\frac{1}{2}$

¹ When the bowl is level full of earth.

When wages are 15 cents and horse hire 10 cents per hour the cost per cubic yard and the amount of earth moved daily with a No. 1 scraper is approximately as follows:¹

¹ The figures on the amount of work performed and costs are based on data contained in "Earthwork and its Cost," by H. P. Gillette.

Distance	Quantity	Cost per cubic yard
Feet	Cubic yards	Cents
100	48.0	8.75
200	34.0	11.50
300	26.6	14.25
400	22.0	17.00
600	16.0	22.50

Cars with Animal Draft. — Horse-drawn dump cars, ranging in capacity from 1 to 3 cubic yards, may be advantageously employed where large quantities of earth are to be moved for a distance of several hundred feet. They are generally run on 16 or 20-pound steel rails, with 6- by 6-inch by 5-foot unballasted ties spaced about 4 feet, center to center. The cost of laying such a track averages \$100 per mile, exclusive of the value of the material.

A dump car with a capacity of 2 cubic yards weighs about 1 ton and holds about 5400 pounds of earth. A horse can pull a loaded car on a level all day, and can go up 4 per cent grades occasionally, if frequent rests are given. The hauling ability of heavy horses pulling cars up different grades is approximately as follows:

Grade	One horse	Two horses
	Cubic yards	Cubic yards
Level.....	2.00	5.0
1 per cent...	1.10	3.0
2 per cent...	0.64	2.0
3 per cent....	0.37	1.5
4 per cent.....	0.18	0.75 to 1.10

When wages are 15 cents and horse hire 10 cents per hour a 2-cubic-yard dump car drawn by one horse will move approximately the following yardage daily:

Distance	Quantity	Cost per cubic yard
Feet	Cubic yards	Cents
1000	85 to 90	0.17
2000	60 to 65	0.18
3000	35 to 40	0.19
4000	20 to 25	0.20

The cars are loaded by shovelers, each handling from 15 to 18 cubic yards daily.¹

Steam Shovels. — Several types are used on logging railroad work where deep cuts or high fills are to be made or heavy ditching done. When a large quantity of earth is to be moved and the work is more or less continuous the standard swinging type of shovel with a $1\frac{1}{2}$ -cubic yard bucket is preferred. The shovel with a self-propelling mechanism, may be mounted on trucks, for use on rails, or on wheels. This type of shovel is best adapted to moving dirt and broken rock, although sometimes it is used for removing logs, windfalls and other débris from the right-of-way. When mounted on wheels it tends to bog down in soft places and, therefore, some difficulty is experienced in using such a machine on logging operations.

Shovels mounted on caterpillar treads and equipped with a $\frac{3}{4}$ -yard dipper often are preferred to either of the types first mentioned because they can be moved ahead of the completed track. Those operated by a 30 horse-power gasoline engine have proved satisfactory, especially in places in which it is difficult to secure water for a steam-operated machine. The daily gasoline requirement is approximately 12 gallons, which amount can be readily packed to the shovel from the end of the railroad line. Such machines have an average capacity of from 20 to 25 cubic yards of material per hour, and on easy work the maximum may be from 40 to 48 yards.

When a general utility machine is desired, the so-called ditcher type often is used. This is a combination crane, steam shovel, pile driver and wrecker which operates from rails laid on top of cars or on the ground. This type of machine has the same disadvantages as the standard steam shovel in that it can be used only at or near the rail head. The cost of moving earth and rock by means of some form of shovel is less than by hand methods when the cut or fill is large. Shovel work often compares favorably in cost with hand methods even where the yardage is small.

Power Drag Scrapers. — These sometimes are used in making heavy cuts and fills. Power is provided by a two-drum yarding engine which operates a main line attached to the fore part of the scraper which pulls it forward and a re-haul which returns

¹ The figures on the amount of work performed and costs are based on data contained in "Earthwork and its Cost," by H. P. Gillette.

the scraper to the working point. The efficiency of this method is less than that of a shovel since there is a good deal of lost time incurred especially on long hauls or on stony ground. The average output per hour of scraping time on one operation was 16.7 cubic yards of earth.¹

ROCK EXCAVATION

Previous to excavation, rock is broken by an explosive into fragments that can be handled readily.

It is transported chiefly in carts, wagons and cars, although it may be moved for short distances on wheelbarrows or thrown out by hand in shallow cuts.

A cubic yard, place measure, of rock increases from 60 to 80 per cent when broken up. On an average only 60 per cent as much yardage of rock can be hauled as of earth.

Payment for the removal of rock which is classified as "loose rock" and "solid rock" is on the basis of the cubic yard, "in place."

A. BLASTING

The holes in which charges are placed are usually bored with hand drills. The diameter and spacing of holes depend upon the kind of explosive used, the character of the rock and the method of handling it. As a rule, the holes are spaced a distance apart equal to their depth, although in hard rock they often are placed closer together. Close spacing increases the amount of drill work required and the quantity of explosive used, although it is often more economical because of the smaller size of material, which makes handling cheaper.

*Drilling.*² — Hand drilling usually is preferred for logging work because of the limited amount of rock moved and the difficulties of transporting drilling machinery and equipment to the site of the work. Power driven drills are used on some operations on which there is a large amount of rock work to be done. Most of these drills are operated by compressed air piped from a compressor on the shovel or from a special air-compressing equipment, driven

¹ See *Logging in the Douglas Fir Region*. By W. H. Gibbons, Bul. No. 711, U. S. Dept. of Agriculture, page 188.

² See *Handbook of Rock Excavation*, by H. B. Gillette, McGraw-Hill Book Co., Inc., New York, 1916, pp. 21 to 36.

by a gasoline engine, which is moved forward over the proposed route in advance of actual rock removal.

There are three forms of drills used for hand work; namely, the "churn drill," "the jumper drill" and the "hand drill."

Churn Drill. — This is the most economical form of drill for holes up to 30 feet in depth and from $1\frac{1}{2}$ to $2\frac{1}{2}$ inches in diameter.

The drill is a $1\frac{1}{4}$ - or $1\frac{1}{2}$ -inch round iron bar of the required length, on one end of which is welded a steel chisel bit from 30 to 100 per cent wider than the diameter of the rod. Several rods of different lengths are required for drilling a deep hole.

The drill is operated by raising it from 18 to 24 inches and allowing it to drop. One man can operate a drill for holes 3 feet or under in depth, two men for those of medium depth and three or four men for the deepest holes.

Trautwine gives the following as an average ten hours' work for a churn drill:

Character of rock	Diameter of hole	
	Inches	Depth of hole
Hard gneiss, granite or siliceous limestone . . .	$1\frac{3}{4}$	7 to 8
Tough compact hornblende	$1\frac{3}{4}$	5 to 7
Solid quartz	$1\frac{3}{4}$	3 to 5
Ordinary limestone	$1\frac{3}{8}$	8 to 9
Sandstone	$1\frac{3}{8}$	9 to 10

Jumper Drill. — These are shorter than churn drills and are operated by two or more men; one, sitting down, holds the drill and revolves it about $\frac{1}{8}$ of a revolution after each stroke, while the other men strike the drill head with 8- or 12-pound sledge hammers.

The drill rods are of $\frac{7}{8}$ -inch octagon steel and the bits are $1\frac{1}{4}$ or $1\frac{1}{2}$ inches wide. The maximum depth for efficient work with a three-man jumper drill does not exceed 8 feet.

Since it can be held on the exact spot, this drill can be used for smaller holes than a churn drill. It is also best for conglomerate rock, because it is not so easily deflected by pebbles.

The amount of work performed in ten hours by three men, one holder and two strikers, using a jumper is approximately as follows for holes 6 feet in depth:¹

¹ From "Handbook of Rock Excavation," by H. B. Gillette, p. 26.

Character of rock	Feet
Granite.....	7
Trap (basalt).....	11
Limestone.....	16

Hand Drill. — The hand drilling method is similar to jump drilling, except that the operator sitting down holds the drill with one hand and strikes the drill with a $4\frac{1}{2}$ -pound hammer held in the other hand. These are used only for holes of small diameter, 3 feet or less in depth. This drill may be used for horizontal or inclined bores.

Hand drill rods are made of octagon steel and range in size from $\frac{5}{8}$ of an inch in diameter, with a $\frac{3}{4}$ - or 1-inch bit, up to a $\frac{7}{8}$ -inch rod with a $1\frac{1}{4}$ -inch bit. A 1-inch drill rod is the maximum size practicable. Chisel-shaped bits, similar to those for jumper and churn drills, are used.

B. EXPLOSIVES¹

Explosives for blasting belong to two general classes:

1. High explosives which require an intermediate agent for explosion, such as a fulminate detonator.
2. Low explosives which can be fired by direct ignition.

High Explosives. — For blasting purposes these are marketed in the form of dynamite, giant powder, gelatine, and some other similar products. The more powerful forms are composed of a mixture of nitro-glycerine and some absorbent, such as sawdust and wood pulp, while the lower grades contain explosive salts in addition. Nitro-glycerine undergoes no change when combined with the absorbent, the latter acting only as a cushion and as a means of solidifying the liquid.

High explosives are made of varying strengths and are graded on the percentage of nitro-glycerine they contain. The standard grades range from 75 per cent down. Those most frequently used are 40 and 60 per cent, the former being preferred for many classes of work.

High-grade dynamite explodes with great suddenness and will shatter rocks and stumps into small fragments. It is especially

¹ The author is indebted to publications of the E. I. DuPont de Nemours Co., for many facts regarding explosives.

suitable for very hard rock or where small drill holes are necessary. Medium grades are best for soft rock because their explosive force is not so violent and sudden, and the tendency is to heave up large masses of rock rather than to shatter them into smaller fragments.

Dynamite which is rather soft resembles brown sugar. It is packed in paraffine coated paper shells or cartridges, the standard size being $1\frac{1}{4}$ by 8 inches and containing one-half pound. Other sizes, from $\frac{3}{8}$ -inch to 2 inches in diameter and 6 inches and over in length are also manufactured. Dynamite cartridges are packed in sawdust in wooden boxes containing 25 or 50 pounds each.

Dynamite freezes between 38 and 55 degrees Fahrenheit and when frozen must be thawed before use. Thawing kettles which are best for this work consist of a double galvanized iron bucket having an inner water-tight receptacle for dynamite and an outer receptacle for warm water which must not exceed 100 degrees Fahrenheit, otherwise the nitro-glycerine may separate from the absorbent. Cartridges are sometimes spread out on a shelf in a warm room and left during the night but should never be thawed in an oven, near a fire or placed against a stove or steam pipe. A few cartridges can be easily thawed out by placing them flat in a water-tight box and burying them in fresh manure.

Some of the *low-freezing* dynamites will not freeze above 32 degrees Fahrenheit, while the so-called *Trojan powder* is practically non-freezing. Nitro-glycerine evaporates rapidly at 158 degrees F. and at 104 degrees F. dynamite may lose as high as 10 per cent of its nitro-glycerine in a few days' time. Because of the tendency of nitro-glycerine to freeze in cold weather and to evaporate in warm weather dynamite should be kept in a warm place in winter and in a cool place in summer.

Great care must be taken to prevent the dynamite from coming into contact with moisture, because water has a greater affinity for the absorbent than has nitro-glycerine, and the latter will be driven out; on low grades of dynamite the salts of the auxiliary explosives are also expelled.

Dynamite which contains impure nitro-glycerine deteriorates during warm weather, when stored in a warm place, or if kept for long periods. Chemical decomposition takes place, liberating nitrous fumes which often are the cause of violent explosions.

A greenish color on the cartridges is an indication of chemical decomposition, and handling dynamite in such condition is always dangerous.

Nitro-glycerine from the cartridge may be absorbed through the hands, and men who handle dynamite are subject to severe headaches. This may be obviated partially by wearing gloves which should be thrown away as soon as they become saturated.

Loading Holes. — The charge should completely fill the bore hole because explosives exert the greatest disruptive force when there are no air spaces below the tamping.

In loading dry holes the cartridge case is cut on one side, and the cartridge lowered into the hole and gently pressed until it completely fills the bore. This is repeated until a sufficient amount of explosive has been placed. When the hole is wet the cartridge case should not be cut.

The hole is now ready for the primer and for tamping.

Primers and Priming. — Most forms of dynamite are exploded by the use of a fulminate detonator or cap, which is ignited either by a safety fuse or an electric fuse. The former is used for individual charges and the latter where many are to be fired simultaneously.

Safety Fuse and Caps. — There are several grades of safety fuse offered on the market, some of which are waterproofed for submarine work. The fuse used for blasting burns at the rate of 2 or 3 feet per minute, and is marketed in packages containing two coils, each 50 feet long.

The cap is a hollow copper cylinder $\frac{1}{4}$ by $1\frac{1}{2}$ inches in size which is closed at one end. It is partly filled with from five to thirty-one grains of fulminate of mercury. The open end is sealed with shellac, collodion, thin copper foil, or paper. Caps deteriorate very rapidly when exposed to moisture. Several grades are made but for general use a No. 6¹ is preferred.

In making the primer for an ordinary blast a piece of safety fuse of the required length is cut off and one end inserted into the cap until it comes in contact with the filling. The fuse is held in place by crimping the cap $\frac{1}{8}$ -inch from the open end. The fuse and cap are then ready for insertion in the primer, which is a cartridge of dynamite of the same size and quality as that used in the charge.

¹ A No. 6 cap contains 15.4 grains of mercury fulminate.

There are two methods of inserting the cap into the primer. A common method (Fig. 100*a*) is to open the paper at the end of a cartridge, and, with a sharpened stick about the size of a lead pencil, make a hole $\frac{3}{4}$ -inch deep in the dynamite. The cap, with fuse attached, is then inserted in this cavity and should project $\frac{1}{2}$ -inch above the dynamite, otherwise the sputtering of the fuse may ignite the dynamite before it does the cap. The cartridge paper is then tied around the fuse with a string, care being taken not to pull the cap out of the primer. If the cartridges are used in wet places soap or tallow is smeared over the safety fuse at the point where it enters the cartridge to prevent the entrance of moisture into the blasting cap.

Some persons prefer to use the method of attaching caps shown in Fig. 100*b*. A hole is punched in the side of the cartridge with a sharp wooden stick and the fuse attached as shown. This method is satisfactory because the fuse comes against the side of the bore and is not injured or disturbed by the tamping bar, and the cap cannot be pulled from the primer and thus cause a misfire.

Primers are placed on top of the charge, but in deep holes, manufacturers recommend that additional blasting caps without fuse be placed at 5-foot intervals throughout the charge.

Electric Fuse. — When it is desired to fire several different charges at one time electric fuses are used in connection with a battery. They consist of two wires inserted in a cap containing a mixture of fulminate of mercury and potassium nitrate or chlorate. The open end of the cap is plugged with sulphur. The fuses are adjusted as shown in Fig. 100*c*. When an electric fuse is used the primer is placed in the center of the charge. The practice in electric firing is to separate the two wires on the fuse and connect one to a wire on a charge on one side and the other to one on a charge on the opposite side. The entire set is connected up in this manner leaving one free wire extending

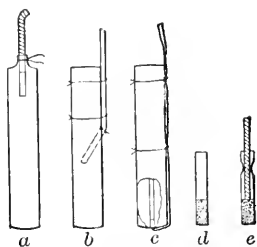

FIG. 100. — Method of placing Caps in the Primer. *a*, and *b*, are for firing with safety fuse. *c*, for firing with an electric battery. *d*, shows the cap ready for the insertion of the fuse. *e*, cap with fuse inserted and the cap shell crimped.

both from the first and the last hole. The two leading wires, 250 feet or more in length, are then connected to the above wires and carried to some protected point. When all is in readiness the leading wires are attached to the poles of the battery and the charge fired by an electric firing machine.

Tamping. — Tamping should always be done with a wooden bar, never with a tool having any metal parts, and the tamping material must be free from all forms of grit, and of such a nature that it will pack firmly. The most satisfactory is moist clay or loam.

After the charge has been pressed tightly in the bore a paper wad may be placed over the primer to keep it dry and from 2 to 3 inches of tamping material put in and firmly, but gently, packed. Two or 3 inches more of tamping material are again added and thoroughly tamped. After 5 or 6 inches of earth have been placed in the bore the tamping can be carried on without fear of premature explosion. The hole should be filled to the surface and the material tightly packed, or it will blow out and much of the force of the explosive will be lost.

Low Explosives. — Low explosives belong to either the soda or the saltpeter class and are known as black powder. The average contain approximately 75 per cent of nitrate of soda, or India saltpeter, 10 per cent of sulphur, and 15 per cent of carbon. Dynamite of 75 per cent strength is usually rated as six times stronger than average black powder. Soda powders can be made cheaper than saltpeter powders but are more absorbent of moisture and, therefore, deteriorate quicker.

Black powder is especially suited for loosening hardpan, shale, and other soft or rotten rock where a lifting action is desired. It is much slower than high-grade dynamite and does not shatter the rock as much. It is also used in redwood operations to blast open logs that are too large to be handled by available equipment.

Black powder is fired by a safety fuse, by a safety fuse and a cap of low power, or by an electric fuse. In loading holes the powder may be placed loose or in cartridges. When the holes open downward the latter form is the only method possible.

In priming holes it is customary to place the safety fuse or safety fuse and cap at the top of the charge while electric fuses are ordinarily placed in the center of the charge.

Moist clay is the most satisfactory tamping material, 2 or 3 inches of dry earth being placed over the powder to prevent the upper end of the charge from becoming moist.

When blasting with black powder the holes may be "sprung" with dynamite before the powder is inserted, in order that a larger cavity may be made for the powder. Dynamite of 40 per cent strength is used for "springing," about $\frac{1}{20}$ of a pound per cubic yard being fired in shale, and $\frac{1}{10}$ of a pound per cubic yard in sandstone. "Sprung" holes should not be charged until they have become cool.

The amount of black powder required per cubic yard of material to be blasted is governed by the depth of hole, character of rock, and spacing of holes. Authorities on the use of black powder do not attempt to give any rules for determining the amount of charge. Charges of 1 pound per cubic yard have proved successful in side cuts and from $1\frac{1}{2}$ to 3 pounds per cubic yard in through cuts.¹ The amount to use under given conditions can be determined only after a few trial shots.

Black powder is put up in 25- and 50-pound cans.

STUMP BLASTING

The removal of stumps from the right-of-way of roads, trails, logging grades, and from pond and building sites can often be accomplished to best advantage by the use of explosives. Dynamite of the 20, 40 and 60 per cent grades is preferable to black powder for this purpose.

The position of the blast with reference to the stump should be governed by the size of stump, character of root system, and kind of soil. Charges should be placed under the main body of the stump, and as near as possible to its toughest part.

In sandy soils, stumps with a shallow root system require more explosive than those with tap roots. They blast easier in heavy and moist soils than in light or dry ones.

For blasting yellow pine stumps with long tap roots the charge should be placed in the tap root and at a distance under ground at least equal to the diameter of the stump. Forty per cent dynamite is usually preferred.

Cypress stumps have many lateral roots and since they usually

¹ See "Handbook of Cost Data," by H. B. Gillette, p. 204.

grow on mucky soil they are difficult to blow out. A quick powerful explosive, such as 60 per cent dynamite, is recommended by manufacturers. The common practice with swamp species is to place a $\frac{1}{2}$ -pound cartridge under each large lateral root, and 4 or 5 pounds under the center of the stump. The charge is then fired with an electric blasting machine.

Stumps with defective centers often split apart and allow the force of the explosive to pass upward without blowing out the roots. This can be obviated by placing a chain around the top of the stump.

The holes in which the explosive is placed are best bored by a 2-inch auger welded to a 5-foot iron rod that has a ring on the upper end through which a round stick can be inserted for a handle.

The depth of the charge below the stump should be governed largely by the size of the stump. Dynamite, in exploding, tends to exert an equal force in all directions. When placed under a stump the soil below the charge offers greater resistance than the soil above and the force is exerted upward in the form of an inverted cone. Consequently the deeper the charge is placed the wider the cone at the surface of the earth.

A rule¹ followed with success in Minnesota was to place the charge at least 1-foot deep for all stumps 1 foot or less in diameter, and proportionally deeper as the diameter increased.

Holes are charged, primed and tamped in a manner similar to bore holes in rock. Enough explosive should be placed under the stump to remove it at the first shot, because it is difficult to make an effective blast in loosened dirt.

One thousand stumps, ranging from 18 to 48 inches in diameter and averaging 30 inches, which were blasted in Minnesota required from one-half to eight, 40 per cent dynamite cartridges, the average number being three per stump.

The DuPont Powder Company recommends, in general, a charge of $1\frac{1}{2}$ pounds of 20 per cent dynamite for each foot in diameter of stump, up to 4 feet; above this diameter $2\frac{1}{2}$ pounds per foot in diameter.

On dry ground one man can bore holes, load, and blow out an average of fifty stumps per day, if they are not widely scattered.

¹ See Minnesota Farmer's Institute Annual, No. 21, 1908.

TIMBER WORK

The construction of trestles, culverts, cribbing, and other timber work is done just previous to track laying.

Trestles are used in crossing streams where some form of bridge is required and to span depressions when it is necessary to elevate the roadbed above the ground level in order to maintain a given grade. They usually are cheaper than a fill when the grade line is 4 feet or more above the ground level, and although less permanent, the life of the wooden structure is generally ample to meet the logger's needs. Trestle timbers also may be salvaged when the road is abandoned.

They are built in two types known as pile trestles and framed trestles, and are made in sections, called bents, which are spaced 12 or 14 feet apart.

Pile Trestles. — These are used in stream beds and swampy spots where suitable foundations for framed trestles cannot be secured, and also for structures 75 feet or more in height when the cost of constructing framed trestles is high.¹

Pile trestles are cheaper than framed trestles when the railroad grade makes an oblique angle with the contours, because of the saving in excavation for mud sills which would have to be cribbed up on one side of the bent and sunk into the earth at the opposite side.

Low pile trestle bents often have three round piles from 12 to 15 inches in diameter, driven in a row across the roadbed. On a standard-gauge road one pile is placed in the center of the roadbed and the outer piles are placed from 24 to 28 inches on either side of it. On medium-height trestles for standard-gauge track four piles are used, the two inner ones being spaced 3 feet apart, center to center, and the outer piles 26 inches, center to center, on either side of the middle ones. When the height exceeds 100 feet, five or six piles may be used. They are driven with a pile driver to bed rock, or solid bottom, and are sawed off at the required height above ground. A 10- by 10-inch, a 12- by 12-inch, or a 15- by 15-inch timber, called a "cap," is drift bolted on top of them with drift bolts.

¹ Pile trestles 120 feet in height and nearly 400 feet long have been erected in the Northwest, to span canyons, at a cost far below that for any other form of suitable structure.

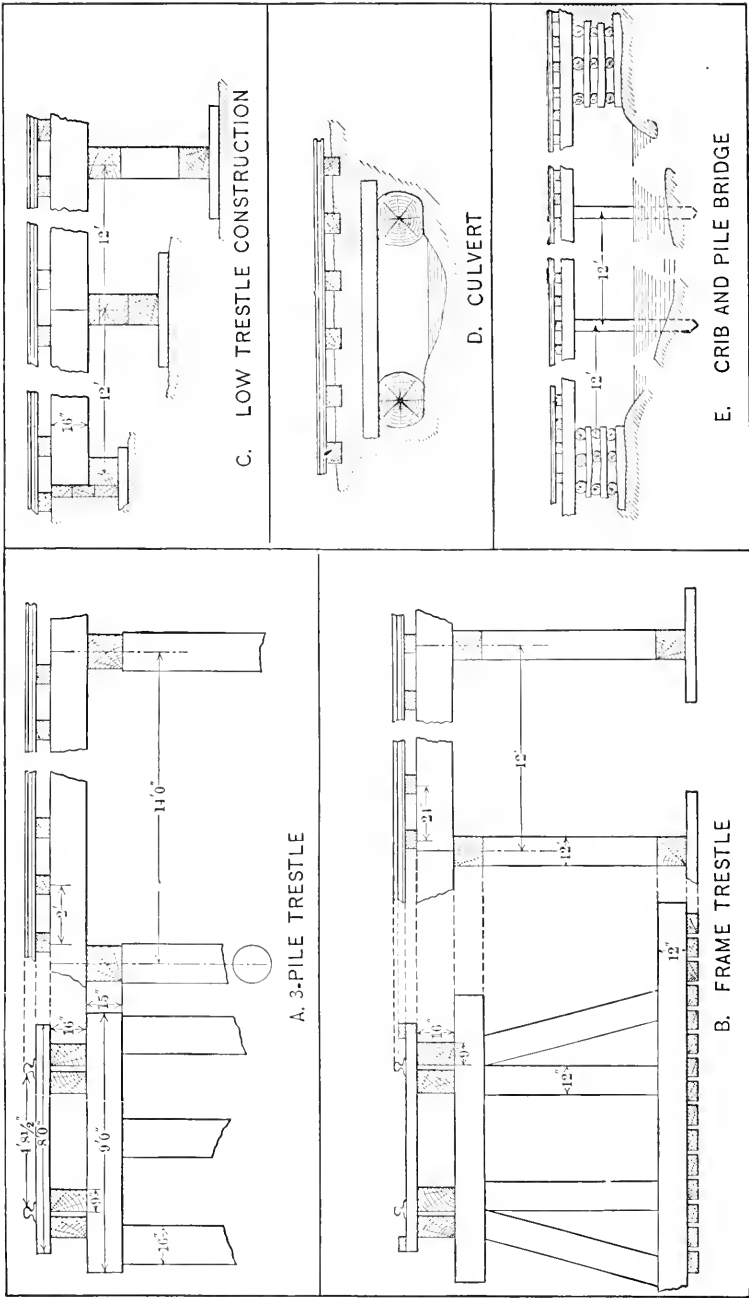

Fig. 101. — Forms of Trestles and Culverts commonly used on Logging Railroads.

The bents are connected by stringers, each 8 by 14 inches or 9 by 16 inches in size, which are placed at right angles on top of the caps and support the crossties. Two stringers are used under each rail. They are spaced 2 inches apart with washers, and then bolted together. They may also be drift bolted to the caps to hold them in position. Sawed ties,¹ 6 by 8 inches by 8 feet, are placed 24 inches, center to center, on top of the stringers, and are often sunk about $\frac{1}{2}$ inch into them. Every fourth or fifth crosstie also is drift-bolted to the stringers. Three- by 8-inch guard rails are then placed on top of the ends of the ties parallel to the stringers and spiked to every other tie to prevent the ties from bunching.

When the trestle is less than 9 feet high it is seldom braced, but where the height exceeds this it is braced on each side with 3- by 6-inch scantlings placed diagonally across each row of piles, the top end of the brace being fastened to the cap and the lower end to the opposite side of the bent just above the ground. The scantlings are spiked to the cap and to each pile.

Where the bent exceeds 20 feet in height it is divided into two or more stories by horizontal braces, of 3- by 8-inch scantlings, and each story is braced diagonally in the manner described above. At each story every bent is connected by a longitudinal brace. Bents over 20 feet in height have five piles whose diameter should not be less than one-twentieth of their length. One pile is placed in the center of each bent and two others are placed on either side at a distance of approximately 24 inches, center to center. The two other piles are placed about 1 foot out at the top of the bent and are given a batter of 2 inches for each foot of height.

In swampy sections the main line is sometimes built on piling. The advantage of this form of road is that a firm foundation is secured in places where dirt ballast could not be used, stumps need not be removed, and the cost of maintenance for the first few years is low.

In cypress swamps these roads are made of piles from 12 to 15 inches in diameter, driven down to a solid foundation, which may be from 60 to 80 feet. Piles 30 feet long are made from one cypress stick but lengths greater than this are secured by placing

¹ Hewed crossties are seldom used for trestle work because of the variation in thickness.

piles on top of one another. Cypress is used for the top log and tupelo for the lower ones. The bents are placed at 6-foot intervals and have two piles driven $56\frac{1}{2}$ inches apart, center to center.

A pile driver crew for building a road of this character is made up of eight men who can cut and drive from twenty to thirty-six piles (from 60 to 100 feet of track) per day of ten hours. The



Photograph by R. C. Hall.

FIG. 102. — A Round-timber Framed Logging Railroad Trestle. The Skidway on the right is several feet below the level of the track. Alabama.

roads are built from 2 to 6 feet above the ground level, and the piles are sawed off at the desired height.

Stringers 8 by 8 inches, or 8 by 10 inches, are laid on top of the piles and on these 6- by 8-inch by 8-foot cross-ties are laid, 24 inches center to center.

Framed Trestles. — These are made both of round and squared timbers, but if the former must be brought from a considerable distance it is advisable to use the latter because they are easier to fit, and are more durable.

The frames, or bents, have four supports, or legs, from 15 to

18 inches in diameter or 10- by 12-inch, or 12- by 12-inch squared timbers. On a standard-gauge road two of the legs are vertical and 36 inches apart, while the other two legs are given a batter of from 2 to 3 inches for each foot of height. The legs rest on a timber called a sill to which they are drift bolted. Sills vary in length according to the height of the trestle and project about



FIG. 103. — The Pole Foundation for a Dunnage Road in a Cypress Swamp, Louisiana.

2 feet beyond the base of the outer legs. The tops of the legs are covered with a cap 12 or 14 feet long on which the stringers rest.

Framed bents may rest on mud sills, or on piles. When the former are used they are frequently 3 by 12 inches by 4 feet in size and are placed at right angles to the bent, and a sufficient number are used to provide a greater bearing surface than that offered by the main sill. Mud sills are suited for a bottom solid enough to provide a firm support but they are not adapted to use in swamps or stream beds. The foundations used in the

two latter cases have piles driven to bed rock, one being placed under the base of each leg, and cut off 2 or 3 feet above high-water mark.

Stringers, ties and guard rails are used as on a pile trestle, and the bents are braced in the same manner.

Framed trestles often are put together on the ground and raised to a vertical position by means of a hoisting or yarding engine and suitable blocks and tackle. Trestles 132 feet in height and 600 feet long have been erected in this manner. This procedure reduces the amount of top work necessary and makes it possible to use less skilled labor than would be required if the bents were framed in the air. Standardized framed trestle structures have been designed for use on lines where frequent changes in roadbed are necessary. The structure is built in sections or units which may be taken down and readily placed in a new structure without reframing. This practice, however, is not followed extensively in logging railroad construction.

Cost of Trestles. — Framed trestles are frequently built by contract, the price being regulated by the amount of timber used and the height of the trestle. Payment for pile trestles, when built by contract, is made on the basis of the number of piles driven and the amount of sawed timber used in the remainder of the structure.

Truss Bridge. — This type of bridge is not in common use although some have been built where the conditions were unfavorable for the erection of pile or framed trestles.

Dunnage or Dust Road. — This is a type of a cheap logging road employed for spurs in the cypress swamps of Louisiana where the bottom is too soft for dirt ballast, and the cost of a pile road is not warranted by the amount of timber to be removed.

The construction of a dunnage road is preceded by clearing a right-of-way from 15 to 20 feet wide from which all brush is cut and stumps removed from the line of the roadbed. The latter is covered with small poles 5 or 6 inches in diameter, laid close together, lengthwise of the right-of-way. These give a wide bearing surface and serve as a bed on which the ballast is placed. The cross-ties are laid on the poles and the rails spiked to them. The track is then ballasted with bark, edgings, sawdust and other sawmill refuse which is brought from the mill

in "dunnage" cars. The dunnage is dumped on either side of the rails, then thoroughly tamped under the ties and, when the track is leveled up, it is ready for operation. Light-weight locomotives, from 18 to 30 tons, are used because this type of roadbed will not stand heavy traffic.

Cribwork. — A crib foundation may be used when logging railroads cross low places that are too soft for a fill, and where the lumber company is not prepared to put in piling. Logs 18 or 24 inches in diameter and 16 or 18 feet long are placed across the right-of-way at intervals of 8 feet. On top of these, and parallel to the roadbed, round stringers from 18 to 24 inches in



Photograph by F. W. Haasis.

FIG. 104. — A Crib Bridge on a Logging Railroad Spur. A cheap method of spanning shallow depressions. Louisiana.

diameter are placed $56\frac{1}{2}$ inches, center to center. These are notched into the cross-skids and drift bolted to them. The crossties are then laid on top of these stringers. The cross-skids are given a greater bearing surface by placing "shims" or poles from 4 to 6 inches in diameter and 8 or 10 feet long at right angles under them.

Cribbed bents, similar to those shown in Fig. 104, are sometimes used on spur lines to span shallow depressions because they can be rapidly constructed at a low labor cost. They are now seldom used when a structure more than a few feet in height is erected because of the large amount of timber required to construct them.

Corduoy for Logging Roads. — Loggers in the South often corduroy unballasted spur tracks on wet ground with 16- or 20-foot poles from 4 to 12 inches in diameter (Fig. 105). The poles are placed between each tie and project out far enough on either

side to rest on solid ground or on roots and provide a level support to the track. Even though the latter does sink temporarily under the weight of the train, it will go down evenly so that there is no danger of derailment, while shims or poles placed



FIG. 105. — A Spur Logging Railroad Corduroyed with Poles in order to provide an Adequate Bearing Surface on a Soft Bottom. Arkansas.

under the ties parallel with the roadbed often allow the track to settle on one side.

Another advantage of cross poles is that they will support the car wheels in case of derailment. One man can cut poles and lay them in place on 100 feet of track daily, provided the material is close at hand.

When spurs cross swampy ground, some loggers dispense with ties and cover the roadbed with large poles 10 or 12 feet long to

which the rails are spiked. A road of this character will support traffic on a very wet bottom better than a dirt grade.

Brush Ballast. — Spur tracks crossing swamps and muddy places often are ballasted with brush, including swamped tree tops, piled 2 or 3 feet high on the grade. Coniferous brush is preferable to hardwood, but either may be used. The crossties are laid



FIG. 106. — A Culvert on a Logging Railroad Spur ready for the Earth Cover. Note the use of non-merchantable material for filling depressions on both sides of the culvert. Washington.

on top of the brush and the rails spiked to them. When the track has been used a few times the brush ballast flattens out and cross poles are then placed between the ties. One man can cut and pile brush on from 100 to 150 feet of roadbed, per day, provided it can be secured along the right-of-way.

Culverts. — These are used where the grade crosses very small streams, or slight depressions where it is necessary to have drainage from one side of the grade to the other.

They are ordinarily made by placing logs from 18 to 30 inches

in diameter across the right-of-way on either side of the stream or depression and covering them with slabs split from 12- to 18-inch timbers¹. Brush is often piled on top of the slabs to prevent the dirt from falling through, and the grade is then built over the culvert.

When the span is short and the grade is high enough above the stream to permit it, several poles or crossties may be laid across the gap parallel to the roadbed, and the crossties supporting the rails placed on top of them.

Box culverts made of plank are seldom used because of the greater cost for material. Round galvanized iron culverts are now used on some main lines.

Cattle Guards. — Log roads that pass over private lands or cross public highways use cattle guards to prevent stock from passing down the right-of-way. The usual type is an open pit 3 or 4 feet deep, 5½ feet long and 3 or 4 feet wide, which is inclosed with a frame of 12- by 12-inch timbers. A division fence extends from the guard to the highway fence.

TRACK SUPPLIES

Crossties. — The size of crossties used depends on the gauge of the road. They may be sawed or hewed. Narrow-gauge ties are made 6 or 7 feet long and standard-gauge ones are 8 feet. Squared ties are 6 by 8 inches in size and pole ties, for a narrow gauge, have a 3- to 5-inch face, and for a standard-gauge a 6-inch face.

Ties usually are cut on the operation and are made both from hardwoods and softwoods. Hewed pole ties made from second-growth pine are seldom as satisfactory as squared ones because they break readily and cause frequent derailments. An expert tie hacker will hew thirty-five or forty standard ties per day, an average man twenty-five or thirty. Some operators who own sawmills and cut crossties for the market use the rejects on their logging operation.

New ties are placed at 24-inch intervals, center to center, on main lines and spurs. On the latter they wear out before they decay because of the frequent pulling and driving of spikes. On tangents only every other tie may be spiked which lengthens its

¹ See Fig. 106.

life because a tie which has been spiked four times becomes so weakened that it often breaks under the rail especially if the ends of the tie are not well ballasted. When spurs are taken up only two spikes in each cross-tie may be pulled, one on the outer side of one rail and the other on the inner side of the opposite rail. The tie may then be forced to one side and removed. When the track is relaid, the spikes in the tie are pulled slightly, the rail slipped under the spike heads and the latter then driven tight against the rail flange. The average annual tie renewals on southern logging operations average about two hundred per year.

Crossties of special length are required for a switch. A set of timbers for a single switch ranges in length from 9 to 15 feet and the number varies with the frog; e.g. a number 8 frog requires 47 and a number 10 frog 56. These are often sawed out in the mill. On rough track the long switch ties may be replaced by two standard-length ones.

Steel Rails. — Rails are classified according to their weight in pounds per linear yard, and those of a given weight are now made of a uniform size.

The chief parts of a rail are the head, the web, and the flange base. The head contains 42 per cent of the metal, the web 21 per cent and the flange 37 per cent.

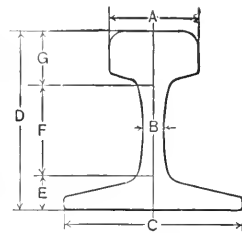

FIG. 107. — A Standard Rail Head. *a*, the head. *b*, the web. *c*, the flange base.

WEIGHTS AND DIMENSIONS OF STANDARD RAILS

Rail part	Weight per yard in pounds							
	40	45	50	55	60	65	70	75
	Dimensions in inches							
<i>A</i>	1 $\frac{7}{8}$ 2 $\frac{5}{8}$ 2 $\frac{5}{8}$ 2 $\frac{5}{8}$	2 2 $\frac{7}{8}$ 2 $\frac{7}{8}$ 2 $\frac{7}{8}$	2 $\frac{1}{8}$ 2 $\frac{7}{8}$ 2 $\frac{7}{8}$ 2 $\frac{7}{8}$	2 $\frac{1}{4}$ 2 $\frac{1}{4}$ 2 $\frac{1}{4}$ 2 $\frac{1}{4}$	2 $\frac{3}{8}$ 2 $\frac{3}{8}$ 2 $\frac{3}{8}$ 2 $\frac{3}{8}$	2 $\frac{1}{2}$ 2 $\frac{1}{2}$ 2 $\frac{1}{2}$ 2 $\frac{1}{2}$	2 $\frac{7}{8}$ 2 $\frac{7}{8}$ 2 $\frac{7}{8}$ 2 $\frac{7}{8}$	2 $\frac{1}{2}$ 2 $\frac{1}{2}$ 2 $\frac{1}{2}$ 2 $\frac{1}{2}$
<i>B</i>	3 $\frac{1}{2}$ 3 $\frac{1}{2}$ 3 $\frac{1}{2}$ 3 $\frac{1}{2}$	3 $\frac{1}{4}$ 3 $\frac{1}{4}$ 3 $\frac{1}{4}$ 3 $\frac{1}{4}$	3 $\frac{7}{8}$ 3 $\frac{7}{8}$ 3 $\frac{7}{8}$ 3 $\frac{7}{8}$	4 $\frac{1}{8}$ 4 $\frac{1}{8}$ 4 $\frac{1}{8}$ 4 $\frac{1}{8}$	4 $\frac{1}{4}$ 4 $\frac{1}{4}$ 4 $\frac{1}{4}$ 4 $\frac{1}{4}$	4 $\frac{7}{8}$ 4 $\frac{7}{8}$ 4 $\frac{7}{8}$ 4 $\frac{7}{8}$	4 $\frac{5}{8}$ 4 $\frac{5}{8}$ 4 $\frac{5}{8}$ 4 $\frac{5}{8}$	4 $\frac{1}{2}$ 4 $\frac{1}{2}$ 4 $\frac{1}{2}$ 4 $\frac{1}{2}$
<i>C and D</i>	3 $\frac{1}{2}$ 3 $\frac{1}{2}$ 3 $\frac{1}{2}$ 3 $\frac{1}{2}$	3 $\frac{1}{4}$ 3 $\frac{1}{4}$ 3 $\frac{1}{4}$ 3 $\frac{1}{4}$	3 $\frac{7}{8}$ 3 $\frac{7}{8}$ 3 $\frac{7}{8}$ 3 $\frac{7}{8}$	4 $\frac{1}{8}$ 4 $\frac{1}{8}$ 4 $\frac{1}{8}$ 4 $\frac{1}{8}$	4 $\frac{1}{4}$ 4 $\frac{1}{4}$ 4 $\frac{1}{4}$ 4 $\frac{1}{4}$	4 $\frac{7}{8}$ 4 $\frac{7}{8}$ 4 $\frac{7}{8}$ 4 $\frac{7}{8}$	4 $\frac{5}{8}$ 4 $\frac{5}{8}$ 4 $\frac{5}{8}$ 4 $\frac{5}{8}$	4 $\frac{1}{2}$ 4 $\frac{1}{2}$ 4 $\frac{1}{2}$ 4 $\frac{1}{2}$
<i>E</i>	1 $\frac{3}{4}$ 1 $\frac{3}{4}$ 1 $\frac{3}{4}$ 1 $\frac{3}{4}$	1 $\frac{3}{4}$ 1 $\frac{3}{4}$ 1 $\frac{3}{4}$ 1 $\frac{3}{4}$	2 $\frac{1}{8}$ 2 $\frac{1}{8}$ 2 $\frac{1}{8}$ 2 $\frac{1}{8}$	2 $\frac{1}{4}$ 2 $\frac{1}{4}$ 2 $\frac{1}{4}$ 2 $\frac{1}{4}$	2 $\frac{1}{2}$ 2 $\frac{1}{2}$ 2 $\frac{1}{2}$ 2 $\frac{1}{2}$	2 $\frac{3}{4}$ 2 $\frac{3}{4}$ 2 $\frac{3}{4}$ 2 $\frac{3}{4}$	2 $\frac{1}{2}$ 2 $\frac{1}{2}$ 2 $\frac{1}{2}$ 2 $\frac{1}{2}$	2 $\frac{3}{4}$ 2 $\frac{3}{4}$ 2 $\frac{3}{4}$ 2 $\frac{3}{4}$
<i>F</i>	1 $\frac{3}{4}$ 1 $\frac{3}{4}$ 1 $\frac{3}{4}$ 1 $\frac{3}{4}$	1 $\frac{3}{4}$ 1 $\frac{3}{4}$ 1 $\frac{3}{4}$ 1 $\frac{3}{4}$	2 $\frac{1}{8}$ 2 $\frac{1}{8}$ 2 $\frac{1}{8}$ 2 $\frac{1}{8}$	2 $\frac{1}{4}$ 2 $\frac{1}{4}$ 2 $\frac{1}{4}$ 2 $\frac{1}{4}$	2 $\frac{1}{2}$ 2 $\frac{1}{2}$ 2 $\frac{1}{2}$ 2 $\frac{1}{2}$	2 $\frac{3}{4}$ 2 $\frac{3}{4}$ 2 $\frac{3}{4}$ 2 $\frac{3}{4}$	2 $\frac{1}{2}$ 2 $\frac{1}{2}$ 2 $\frac{1}{2}$ 2 $\frac{1}{2}$	2 $\frac{3}{4}$ 2 $\frac{3}{4}$ 2 $\frac{3}{4}$ 2 $\frac{3}{4}$
<i>G</i>	1 $\frac{1}{4}$ 1 $\frac{1}{4}$ 1 $\frac{1}{4}$ 1 $\frac{1}{4}$	1 $\frac{1}{8}$ 1 $\frac{1}{8}$ 1 $\frac{1}{8}$ 1 $\frac{1}{8}$	1 $\frac{1}{8}$ 1 $\frac{1}{8}$ 1 $\frac{1}{8}$ 1 $\frac{1}{8}$	1 $\frac{1}{4}$ 1 $\frac{1}{4}$ 1 $\frac{1}{4}$ 1 $\frac{1}{4}$	1 $\frac{1}{2}$ 1 $\frac{1}{2}$ 1 $\frac{1}{2}$ 1 $\frac{1}{2}$	1 $\frac{3}{4}$ 1 $\frac{3}{4}$ 1 $\frac{3}{4}$ 1 $\frac{3}{4}$	1 $\frac{1}{2}$ 1 $\frac{1}{2}$ 1 $\frac{1}{2}$ 1 $\frac{1}{2}$	1 $\frac{3}{4}$ 1 $\frac{3}{4}$ 1 $\frac{3}{4}$ 1 $\frac{3}{4}$

Rails are sold by the long ton. Although the standard rail length is 30 feet, shippers reserve the right to include 10 per cent of from 24- to 28-foot rails in a given order.

Narrow-gauge roads use 25- or 35-pound rails; and standard-gauge 35- or 45-pound rails on spurs, and from 45- to 70-pound rails on main lines. The lighter rails are an advantage on spurs because they can be handled more readily.

The long tons of rails of different weights required per mile of road may be found by multiplying the weight per yard by 11 and dividing the result by 7.¹ Ordinarily the weight of the rail in pounds per yard should equal the number of short tons carried on all the drivers of the heaviest locomotive that is to be used.

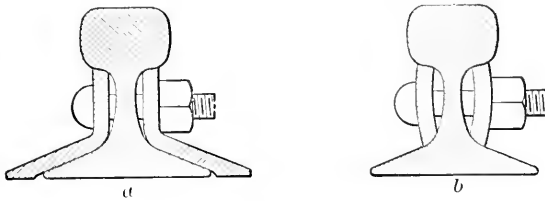

FIG. 108. — Forms of Rail Fastenings. *a*, angle bars. *b*, fish plates.

For example, a locomotive having a weight of 80,000 pounds on its drivers should not be operated on less than a 40-pound rail.

Lumber companies may buy or lease second-hand rails from trunk-line railroads. The latter practice was common in some sections, where trunk lines had second-hand steel, which accumulated when a change in the weight of the rails was made on their lines. The lease of steel at low rates served to encourage the development of the lumber industry along the trunk line because it reduced the lumberman's investment in equipment.

Rail Fastenings. — Either angle bars or fish plates are used to strengthen and brace the rails at the joint.

Angle bars, which are of several patterns, are bolted on each side of the joint with from two or three bolts in each rail head (Fig. 108*a*.) They are used both on main-line and spur logging roads.

¹ Example: weight of rail, 60 pounds per yard; then $\frac{60 \times 11}{7} = 94$ tons, 640 pounds.

Fish plates, sometimes called "straps," are plain bars of steel bolted to the rail in the same manner as the angle bars, but usually with not more than two bolts per rail head (Fig. 108*b*). They are especially adapted to spur track use because they can be put on quicker than angle bars and are equally serviceable for light traffic. Standard requirements call for 357 joints per mile.

Spikes. — Rails are fastened to the crossties by square spikes which vary in length and size with the weight of rail. Four spikes are driven to each tie, one on each side of each rail.

ESTIMATED AMOUNT OF MATERIAL REQUIRED FOR ONE MILE OF TRACK FOR RAILS OF A GIVEN WEIGHT

Weight of rails per yard	16	20	25	30	35	40	45	55	60	65
Number of tons of 2240 pounds	25 $\frac{1}{7}$	31 $\frac{3}{17}$	39 $\frac{2}{7}$	47 $\frac{1}{7}$	55	62 $\frac{1}{7}$	70 $\frac{3}{4}$	86 $\frac{1}{2}$	94 $\frac{1}{2}$	102 $\frac{1}{2}$
Pounds of spikes	1689	1689	2708	2708	2708	4182	4182	5867	5867	5867
Number of angle bars	357	357	357	357	357	357	357	357	357	357
Number of crossties	3520	3520	3520	3520	3017	2640	2640	2640	2640	2348
Pounds of bolts and nuts	546	582	582	610	610	1073	1073	1146	1169	1169

Turnouts. — The device used to connect two given sets of track is known as a turnout. It has three separate parts known as the switch, the frog and the guard rails.

(1) The switch is the movable part of the turnout and is the point at which the two divergent tracks meet. There are two kinds in use by loggers; (a) the stub-switch in which both main-line rails are cut (Fig. 109), and (b) the split switch in which but one main-line rail is cut (Fig. 109). The latter is preferred because of its greater safety.

(2) Frogs provide the means by which the flanges of the wheels can cross the rail of the track when the train is entering or leaving a switch (Fig. 109*c*). Frogs are built ready for use in the track and are made for various degrees of curvature, each size being designated by a number. Those in most common use on standard-gauge logging roads are No. 6 ($9^{\circ} 32'$), No. 8 ($7^{\circ} 09'$) and No. 10 ($5^{\circ} 43'$). The number of a given frog can be determined by dividing the length of frog by the width of the frog heel, the quotient being the frog number.

(3) Both on the main line and the spurs, guard rails, from 10

to 15 feet long, are placed opposite the frog and serve to hold the wheel flanges against the outer rail and thus make the wheel flanges on the opposite side of the car follow the proper rail. The space between the head of the guard rail and that of the main rail is 2 inches.

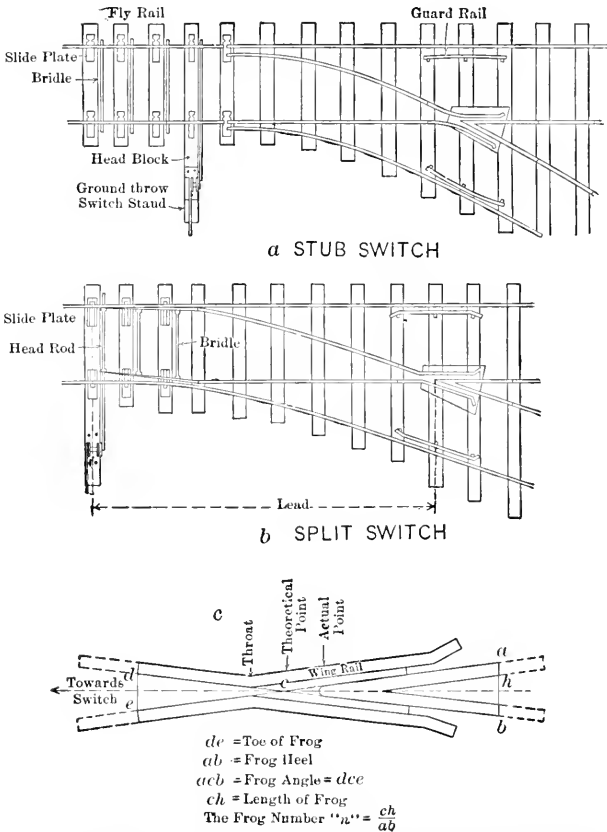

FIG. 109. — Two Forms of Turnouts used on Logging Railroads. *a*, the stub switch. *b*, the split switch. *c*, a standard frog.

STEEL LAYING AND REMOVAL

The work of laying steel and taking it up may be done either by hand labor, or by track-laying and lifting machines. The work is done both by contract and by day labor, although the latter is the more common.

A crew of from twenty-one to twenty-five men, provided with a light engine, and one or more cars carrying crossties, rails and other supplies will lay, by hand, from 1500 to 2000 feet of track, daily. The usual unit for expressing the amount of work done in laying or taking up track is the 30-foot rail and the average day's work for each man in the crew is from five to six rails either laid in the track or taken up or both. Some highly efficient crews are able to lay ten rails per man, daily. When laying or taking up track by hand, the rails and ties are carried on flat cars each holding from fifteen to twenty pairs of rails with the required number of ties. The cars are pushed ahead of the locomotive to the point where construction is to begin. Ties are then laid in position on the right-of-way, and the rails placed on them. The rails are connected by angle bars or fish plates and spiked to every third or fourth tie. This gives the rail sufficient bracing to hold up the train which is pushed forward a rail length and the operation repeated. In taking up track this process is reversed. The cost is about the same as for laying track.

Track-laying crews are followed by back spikers, who complete the spiking of the track. On main line and curves four spikes are placed in each tie, two for each rail, but on spurs every other tie may be spiked. The track can be taken up more readily if it has a minimum number of spikes to pull and the life of the tie is also increased. A crew of seven men will back-spike 1600 feet of track per day.

Spurs are moved with such frequency that it is seldom feasible to carry a stock of bent rails for curved portions of the track. In nearly all cases it is practicable to bend the rails to the proper curve as they are spiked. On main-line work a rail-bending machine is sometimes used.

Where spurs are being built constantly the steel-laying crew may spend alternate days in removing steel and ties from an abandoned road and in placing them on a new roadbed.

On main lines the expansion of the rails during warm weather must be taken into account in order to prevent buckling. To remedy this a space of $\frac{5}{16}$ inch in winter and $\frac{1}{16}$ inch in summer is left between rail ends. On spurs the rails seldom fit closely so that this factor may be disregarded.

Hand methods require a crew of strong men to handle the heavy

cross-ties and rails and a full crew is necessary to work to advantage. In order to reduce the amount of heavy work involved in track laying and lifting and to make it possible to work efficiently with a smaller crew of average strength men, several types of track laying and lifting machines have been devised. These are of two general types: (1) those that handle the rails and ties in sections or panels one rail length long; (2) those that handle rails and ties separately.

The first method is best adapted to flat lands where there are few curves and turnouts on the line, for where these occur the track sections must be broken up before they can be relaid. The rails are laid with "even joints." The equipment includes a locomotive, several flat cars and a locomotive crane mounted on a flat car. The train is backed out to the end of the line that is to be taken up, the bolts on one end of the fish plates are removed, and chains are attached to each corner of a 30-foot section, which is then elevated several feet by means of a cable on the track mover. The latter is then revolved in an arc of 180 degrees and the section deposited on the flat car directly behind it. The train is then run forward a rail length and the process repeated. When ten sections, or 300 feet of track, have been placed on a flat car, it is switched out by the locomotive and an empty substituted. After loading several flat cars, the train proceeds to a new line where with the track mover ahead the process is reversed and the track laid. On one operation a track foreman, who ran the machine, one laborer on the flat car to fasten and loosen chains, and three or four laborers on the ground to handle the sections and to bolt up and unbolt fish plates have laid 2000 feet of track daily, in addition to clearing the right-of-way and cutting wood for fuel.

When there are many curves in the track it is cheaper to break up the panels and to handle the cross-ties and rails separately. Two general types of machines adapted to this work are on the market. One of them, the so-called Norby track-laying and lifting machine¹ is mounted on a 42-foot flat car and has a skeleton steel hollow framework 12 feet high, 10½ feet wide and from 34 to 40 feet long. An over-head I-beam track is bolted to the framework over the center of the car and extends 26 feet beyond both ends of the framework. A four-wheeled trolley travels along

¹ See Fig. 110.

this track, being actuated by an endless cable driven by two drums and a 5- by 7-inch twin engine placed above the center of the steel framework. Steam for the engine is piped from the locomotive. Both the rails and the cross ties are handled by this trolley. A track-laying outfit comprises the track-laying machine, a flat car for cross ties and a locomotive. In taking up track, the train with the track machine in front is pushed within 30 feet of the end of the road and the rail fastenings removed. The trolley is then run out to the end of the boom and a loose rail lifted by means of rail tongs and carried back and dropped under the framework of the machine. When both rails have been placed on the car, the cross ties are made up into bundles containing several pieces, a choker is placed around them and the unit raised by

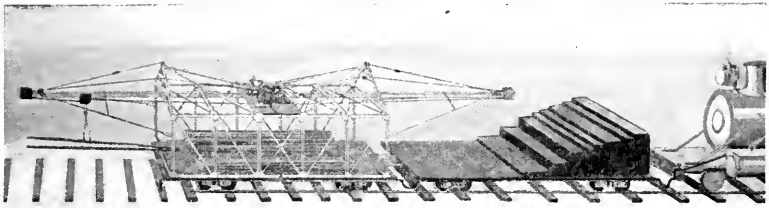

FIG. 110. — The Norby Track-Laying and Lifting Device..

the trolley and carried above the rails on the car to a flat car at the rear of the machine. A crew of twelve men, exclusive of the foreman and the locomotive attendants, can pick up or lay about 1800 feet of track daily.

Another type of track-laying and lifting machine is mounted on a special car with a steel framework and has two endless parallel chains spaced about 4 feet apart which extend from the rear of the machine to the ends of a cantilever arm which projects 22 feet beyond the trucks on the forward part of the machine. These chains are driven by a small reversible duplex engine, which is furnished with steam by the locomotive. The chains rest on sills on top of the car on which the cross ties are piled and are used to carry cross ties from the car to the end of the cantilever arm or vice versa. The cross ties are raised above the chain by short sections of 2- by 4-inch pieces which are placed on the sills parallel to the chain. The rails are carried on bunks on both sides of the machine. When track is being taken up,

the machine is run out to the end of the road, the rail fastenings removed, and the rails pulled, by a power driven cable, over rollers to the bunks on the car. The cross-ties are then picked up and placed upon the endless chain on the cantilever arm which carries them to the rear of the machine where they are stacked upon the 2- by 4-inch timbers on top of the sills. As loading progresses additional strips are placed along the chains until the front end of the machine is reached. In track laying the cross-ties are rolled down upon the endless chain and carried to the end of the cantilever arm where they are placed in position by the crew. The rails are rolled from the bunks upon rollers along the side of the car and then pushed forward where they are picked up by means of rail tongs and carried forward and dropped upon the cross-ties. When the rails are in position, the rail fastenings are adjusted, and bridles are placed on the rails at intervals of 7 or 8 feet to hold them upright and in position until the track layer and locomotive have passed. Spiking is done behind the locomotive since more speed can be made by this method. This machine can be operated with a crew of eight men but a crew of from fourteen to sixteen is more efficient.

The back-spiking crew is followed by the surfacing gang which levels up the roadbed with ballast, digs or opens drainage ditches alongside of the track, adjusts the gauge, raises the outer rails on curves, and performs any work necessary to put the road in a condition for operation. On main lines a large amount of surfacing may be done, but on spurs it is limited.

Roads which have sharp curves must have the gauge widened to reduce the frictional resistance of the wheels against the rails. It is customary to widen the gauge at least $\frac{1}{16}$ -inch for each $2\frac{1}{2}$ degrees of curvature in excess of 5 degrees. For example, the gauge would be increased $\frac{1}{2}$ -inch for a 20-degree curve. The extra width allowed is dependent chiefly on the width of the car wheel treads.

The centrifugal force of a train under speed tends to force the wheels against the outer rail. This tendency increases with speed and is greater on a sharp curve than on an easy one. It is overcome by elevating the outer rail and lowering the inner one and also by coning the tread of the wheels. The diagram (Fig. 111) shows the customary elevation for standard-gauge track on curves up to 40 degrees and for speeds up to 30 miles

per hour. The elevation for track of another gauge is approximately in proportion to its relation to the standard-gauge.

An average day's work for surfacing a new roadbed when about 8 inches of dirt are used as ballast, is three rail lengths per man, while on swamp work when from 12 to 15 inches of dirt ballast are used, it is one rail length.

Cost of Construction. — The cost of construction per mile on logging railroads varies widely even in a given region. The two

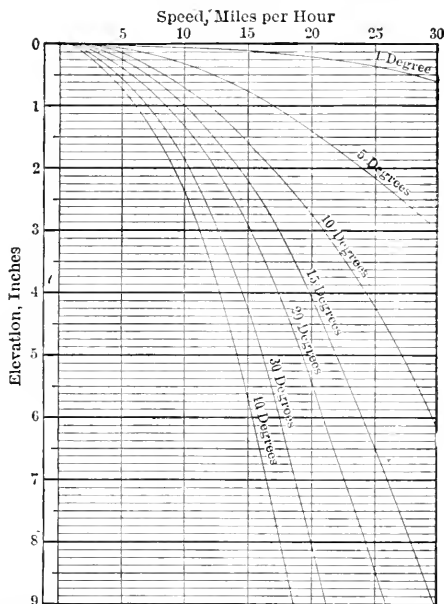

FIG. 111. — Diagram Showing the Customary Elevation of the Outer Rail, in Inches, for Various Degrees of Curvature.

factors that chiefly influence it are topography and the character of the bottom on which the road is to be built.

Construction is cheapest in the flat pine forests of the extreme southern States, where a minimum of grading is required. On the other hand the rough topography of some of the Pacific Coast country often requires heavy grading work and high trestles and the roads must be built more carefully for transporting the large and heavy timber. Swamps such as are found in the eypress region also necessitate a heavy expenditure because the main roads have to be built on piling.

Loggers in all sections spend from 60 to 90 cents per thousand feet of timber hauled for the construction of the road, from 20 to 30 per cent of which is expended on the main line. The cost of main line logging roads, exclusive of rails and other supplies, in the southern pine region ranges from \$1000 to \$2000 per mile, and on the Pacific Coast between \$3000 and \$6000. Spur lines in the South cost from \$300 to \$750 and on the Pacific Coast from \$2000 to \$3000 per mile. The cost of a main line including new steel rails, angle bars, spikes, crossties and supplies will exceed the figures given by from \$3000 to \$4000 per mile.

Maintenance-of-Way. — Section crews are employed to keep the road ballasted up, maintain the gauge, keep the drainage ditches open, replace broken or decayed ties and to make any repairs that may be needed. Maintenance on main lines requires one man per mile, and on spurs one man for 2 miles of track.

BIBLIOGRAPHICAL NOTE TO CHAPTER XVIII

- AMBURN, W. W.: Standardized Timber Bridge for Logging Railroads. *The Timberman*, Feb., 1919, p. 46.
- BYRKIT, G. M.: Machine for Picking up Railroad Track. *The Timberman*, August, 1912, p. 48.
- BYRNE, Austin T.: *Highway Construction*. John Wiley and Sons, New York.
- CORPS OF ENGINEERS, U. S. Army: *Engineer Field Manual, Professional Papers, No. 29*, Washington, 1917.
- CORPS OF ENGINEERS, U. S. Army: *Military Railways, Professional Papers, No. 32*, Washington, 1917.
- Cowling, H. G.: Standard Frame Trestles for Logging Railroad. *The Timberman*, July, 1921, pp. 34 and 36.
- CROSBY, Lloyd R.: Construction of Logging Railroad Tunnels. *The Timberman*, March, 1923, pp. 34 and 35.
- DAVIS, Minot: Steam Shovel in Logging Railroad Construction. *The Timberman*, Nov., 1921, pp. 66 and 68.
- ENGINEER'S HANDBOOK. Useful Information for Practical Men. Compiled for E. I. duPont de Nemours Powder Company, Wilmington, Delaware, 1908.
- FISH, J. C. L.: *Earthwork Haul and Overhaul*. John Wiley and Sons, Inc., New York, 1913.
- GILLETTE, H. P.: *Earthworth and its Cost*. McGraw-Hill Book Co., New York, 1912.
- GILLETTE, H. P.: *Handbook of Clearing and Grubbing*. Clark Book Co., New York, 1917.
- GILLETTE, H. P.: *Handbook of Cost Data*. Myron C. Clark Pub. Co., Chicago, 1910.

- GILLETTE, H. P.: Handbook of Rock Excavation. McGraw-Hill Book Co., New York, 1916.
- JOHNSON, J. B.: Theory and Practice of Surveying. John Wiley and Sons, New York. 1901.
- KINDELAN, J.: The Trackman's Helper, Clark Book Co., New York, 1900.
- LAMB, Frank H.: Steam Shovel in Logging Road Construction. The Timberman, Oct., 1920, pp. 65 and 68.
- POPE, C. R.: Constructing a High Pile Bridge. The Timberman, Feb., 1915, pp. 49 and 50.
- POWERS, Fred W.: Preventing Track Creeping on Grades. The Timberman, Oct., 1919, p. 45.
- SOMERVILLE, S. S.: Building Logging Railroads with a Pile-driver. The Timberman, August, 1910, pp. 37-38.
- STAMM, Samuel A.: A Unique Logging Railroad Bridge. The Timberman, July, 1916, p. 46.
- TRACY, John Clinton: Plane Surveying. John Wiley and Sons, New York. 1908.
- WEBB, W. L.: Railroad Construction. John Wiley and Sons, Inc., New York. 1917.

CHAPTER XIX

INCLINES

Loggers in mountainous regions often find it necessary to raise or lower loaded log cars on grades too steep for the operation of locomotives unless switchbacks are installed. One western logger states that the ratio of track required for inclines as compared to switchbacks is 1 to 5. These conditions may be encountered in bringing timber over a ridge from one valley to another, or from a ridge to a lower level on which the logging railroad is located, or vice versa. Logging inclines are often used to overcome difficulties of this character.

Two different incline systems are in use, namely, the one-way in which loaded cars are lowered in one operation and the empty cars later drawn up to the top; and the counterbalance system in which the empty car ascends as the loaded car descends.

The roadbed for an incline does not require as strong construction as a railroad because there is no pounding action such as is produced by a locomotive. An uneven grade is not a serious handicap unless there are portions which are so gentle that cars cannot be returned to the foot of the incline by gravity, in which case a trip line must be provided which will pass from the hoisting engine through a block at the foot of the incline and then back to the summit.

Inclines should be built approximately in a straight line because greater power is required when the direction of pull is changed and the life of the cable is shortened when it passes over rollers at curves. However, small degrees of curvature are permissible if rollers are placed at such places to reduce cable wear. The maximum efficient length for an incline seldom exceeds 8000 feet.

When loaded cars are hauled up one slope and dropped down on the other side, the distance on the down-grade should not exceed the maximum for an upgrade haul.

One-way Vehicles. — These may have one or two cables, the

former being most frequently used on short lines although it is sometimes used on long ones. The *one-cable* system has a one-drum hoisting or lowering engine placed near the head of the incline, by which the cars are dropped down or pulled up the grades. It sometimes is placed at the summit and is used to raise cars up to the top of the incline and then lower them on the opposite slope. In some cases logs are carried over more than one divide by using two or more raising and lowering machines. On an Oregon operation¹ where two ridges were crossed the logs were first drawn up a 15 per cent incline 1500 feet long, and then lowered down a 20 per cent grade for 3000 feet. At the base of the latter grade the cars were picked up by the cable from a machine near the second summit

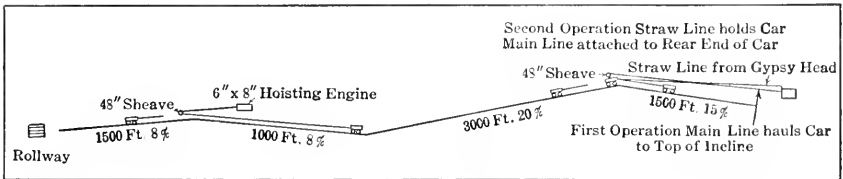

FIG. 112. — An Incline System used to transport Timber across Two Ridges.

and hauled up an 8 per cent grade for 1000 feet, and then lowered on an 8 per cent grade for 1500 feet. The engine at the woods terminus was a 9- by 10-inch yarding engine, carrying 4500 feet of $\frac{3}{4}$ -inch cable which passed through a 48-inch sheave block at the summit, and then was brought back to the foot of the incline and attached to the draw bar of the logging car. The car was drawn to the summit of the first incline where it was held by a small line from the donkey which was attached to the rear drawhead of the car. The main cable was then transferred from the front to the rear drawhead, the small cable released and the car lowered to the foot of the grade. Here it was picked up by the second engine which pulled the load to the top of the second incline and then lowered it to the roadway. The actual time required from one end of the double incline to the other was about 20 minutes, a round trip requiring one hour including loading and unloading the incline car, which was a standard set of logging trucks equipped with safety bunks. An independent brake control was provided by a tender car made from a single set of

¹ See Fig. 112; also *The Timberman*, May, 1915, p. 48A.

logging trucks upon which were mounted two hand brakes. The tender car was connected by chains and rods to the logging car. It was seldom used since the engineers were able to control the speed of the car from the machine.

The loaded car weighed approximately 20 tons and carried from 5000 to 7000 board feet of timber.

An improvement on the method of operating similar inclines suggested by a logger is to fasten the cable around the center of the load and when the latter has nearly reached the summit to increase the speed of the car so that it will cross the divide and drop down the other slope. The sheave block should be hung on a swivel about 20 feet above the center of the track.

A *two-cable* system¹ was developed by a western operator to lower timber from mountain slopes to a railroad at the base, about 1200 feet below. Inclines with lateral spurs were constructed and the loaded cars brought to them for lowering. While most of the inclines were straight, on one there was 1200 feet of track on a 12 degree curve. Power for lowering the cars was provided by a 11- by 13-inch hoisting engine placed at the top of the slope, which had a drum capacity of 12,000 feet of 1 $\frac{1}{8}$ -inch cable. The engine was mounted on a sled so that it could be moved readily under its own power from one set-up to another.

The lowering line led from the engine, placed on the left of the incline, through a three-sheave block on a lowering car, and then back to a stump near the engine but on the opposite side of the track. The lowering car had a steel frame supported on two single trucks, on which was mounted a compound lowering block.

The dead section of the lowering line rested on skids placed along the track and at right angles to it. The moving line rested on sheaves along the side of the track, spaced at 100 foot intervals. On the inside of the curves the cable led over rollers, while on the outside of curves the dead line was held in place by brackets which automatically released or picked up the line when the car had passed a given point.

The "lowering" car pulled the empty log cars from the base of the incline to one of the lateral spurs, where they were left on a siding, and were later taken to the loading point by a geared

¹ See Logging in the Douglas Fir Region, by W. H. Gibbons.

locomotive. Loaded cars were brought out from the lateral spurs by a locomotive and placed on a siding near the incline. The lowering car was then run in on the switch and coupled to the loaded cars, which were then pulled out upon the incline and lowered. Two or three loaded or six empty cars were handled at one time. This system has proved satisfactory on inclines 4800 feet long and with maximum grades of 30 per cent, the machine lowering 40 cars, daily, under these conditions.

Counterbalanced Inclines.— These are designed so that as a loaded car descends an empty one ascends. There may be a single track from the base to a point about midway of the incline where a passing switch is installed and single or double tracks then continued to the summit. Sometimes triple rails are used with a passing switch at the midway point. The loaded and empty cars then use the middle rail in common. A counterbalanced incline built in California was 8000 feet long and had a drop of 3100 feet, the grades running from 10 to 78 per cent with an average of 45 per cent. The lowering engine was equipped with a single drum driven by 14- by 14-inch engines, geared to a ratio of 12 to 1, and providing a car speed of 600 feet per minute. Two independent sets of friction brakes were provided. The 6 by 19 plow steel cable was $1\frac{1}{2}$ inches in diameter and was held down on depressions by sheaves supported on trestle work 16 feet above the ground level. Sheaves also were placed in the track where the cable might drag on the ground in order to keep it out of the dirt.

A special design of car holding 5000 board feet was used which had a steel bulk head 5 feet high at the front end to prevent the logs from sliding forward on the car. The time required to lower a car varied from 10 to 12 minutes including the time necessary to attach the cable at the summit and detach it at the foot of the incline.

There are several devices, known as "snubbing machines," used for lowering logs down an inclined track.

The chief feature of the friction-brake snubbing machine is a heavy frame, carrying a large drum on which is wound the cable that holds the loaded cars in check. The speed of the cars is regulated by means of heavy band brakes placed on flanges attached on either side of the drum.

The haul cable is returned to the top of the incline by various

devices. One type has a small drum placed on one end of the main drum shaft and a trip line from a yarding engine wrapped two or three times around it. When the main cable is to be wound up, the trip line is tightened by sheave pulleys, and, as it is wound in, the main drum is rotated.

Another method is to use a donkey engine equipped with a large drum and $1\frac{1}{8}$ -inch cable with the cars attached to the free end. The speed is controlled chiefly through the car brakes supplemented by friction brakes on the drum. Empties are brought to the head of the incline by winding in the main cable.

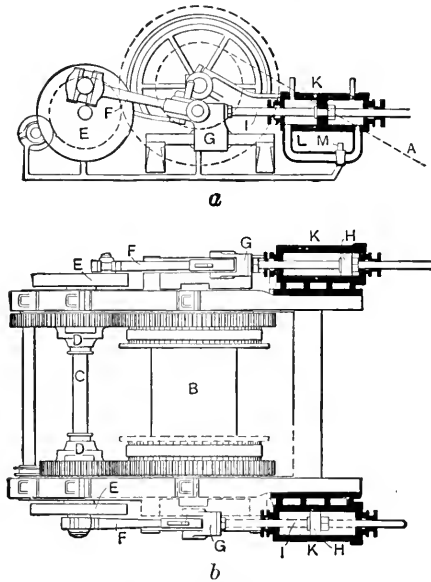

FIG. 113. — A Hydraulic Snubbing Machine. *a*, side view. *b*, top view.

Hydraulic machines,¹ of the type shown in Fig. 113*a* and *b*, have been used in the Northwest to control the speed of cars lowered on inclines.

The water cylinders (*K*) are closed at both ends and are connected with the pipe (*L*) which has a plug valve (*M*) near the middle. When (*M*) is closed the water is confined and holds the pistons (*H*) rigidly in place. Opening the valve (*M*) allows the water to pass alternately from one end of the cylinder to the other, the speed being governed by the extent to which the valve

¹ See *The Timberman*, Portland, Oregon, October, 1909, p. 51.

is opened. The controlling levers are so arranged that the valves (*M*) can only be opened and closed gradually, thus avoiding heavy shocks on the cable. In addition to the hydraulic cylinder brakes the machine is equipped with emergency brake bands and wooden friction blocks. The cable and empty cars are returned to the head of the incline by an auxiliary steam-driven engine.

A snubbing device of the above character was operated on a 4500-foot incline on which there was a difference of 1300 feet elevation. The grade on a portion of the road was 50 per cent and averaged 30 per cent for the entire distance.

One car holding 6000 feet log scale, a total weight of about 20 tons, was lowered with a 1-inch plow steel cable. A greater number of cars could have been handled by increasing the size of the cable, but since the daily requirements were only 30,000 board feet, this was unnecessary.

In a western operation, which had a 20 per cent grade near the end of its logging railroad, the problem of lowering cars was solved in the following manner: A track was built up the slope from the main line to a bench on which a yarding engine was placed both for skidding logs and loading cars. A $\frac{5}{8}$ -inch cable was laid along the track from the bottom of the incline to the top where it was passed through a block in the rear of the yarding engine and then carried down the track to the starting point. One end of the cable was attached to the forward end of the empty cars, and the other end to the drawhead on a locomotive standing on a parallel track beside the empty cars. The cars were pulled up the incline by running the locomotive on the main line toward the mill which hauled the empty cars from the parallel track to the main incline track and then to the summit. Signals for starting and stopping were given by blasts on the whistles of the locomotive and the yarding engine. The speed of descending cars was controlled by the locomotive as it slowly backed toward the base of the hill.

Safety switches were installed both at the top and bottom of the incline so that the cars passing up or down could be shunted from the main track to a siding before they would meet other cars or the locomotive.

Two loaded cars were handled at one time, the locomotive placing two empties at the head of the incline and then taking the loaded cars to the mill. This arrangement resulted in a minimum loss of time for the train crews.

Dudley. — Formerly when it was not possible to build a straight track, and the length of incline exceeded $1\frac{1}{2}$ miles, a special form of traction device, called a “Dudley” or “Dudler,” was used. It was made to operate on ascending or descending grades and either to drag logs over the ties or to haul them on cars.

The Dudley was a traction device with steam or gasoline power mounted on trucks. It was moved along the track by means of a cable wound several times around a bull drum on the machine. The cable was stationary and the ends were attached to stumps or trees at the upper and lower terminals. When the drum was rotated the machine warped itself up or down the incline. Such devices are rarely used today, some form of one-way or counterbalanced incline being substituted for it.

BIBLIOGRAPHICAL NOTE TO CHAPTER XIX

- BADGETT, C. S.: Equipment for Incline Logging. *American Lumberman*, Oct. 8, 1921, p. 54.
- CLARK, A. W.: Overcoming Grades too Steep for Geared Locomotives. *The Timberman*, August, 1909, p. 33.
- HOLMES, H. P.: Lowering Logs on Steep Grades. *The Timberman*, Sept., 1914, pp. 65 and 66.
- MACLAFFERTY, T. H.: Handling Logging Trains on Excessive Grades. *The Timberman*, July, 1911, p. 44.
- MCGILLICUDDY, B. H.: Lowering Systems versus Switchbacks. *The Timberman*, Nov. 1921, pp. 48 and 49.
- NESTOS, R. R.: Aerial Snubbing Device. *The Timberman*, August, 1912, p. 49.
- O’GORMAN, J. S.: Logging Steep Ground with Inclines. *The Timberman*, Nov. 1921, pp. 46 and 47.
- PAULSEN, E. M.: Inclines versus Swing Machines. *The Timberman*, March, 1922, p. 57.
- POTTER, E. O.; Utilization of the Cable Locomotive. *The Timberman*, August, 1909, p. 34.
- SESSOMS, H. W.: Proposed Plan for Steep Hillside Logging. *The Timberman*, Oct. 1913, pp. 74 and 75.
- SESSOMS, H. W.: Lowering Logs on Steep Grades. *The Timberman*, Sept., 1914, pp. 32 and 32A.
- SESSOMS, H. W.: Lowering Systems and Inclines. *The Timberman*, Nov., 1922, pp. 72, 74 and 76.
- WENTWORTH, G. K.: Lowering Logs on a 3200-foot Incline. *The Timberman*, August, 1909, p. 34.
- WILLIAMS, Asa S.: Logging by Steam. *Forestry Quarterly*, Vol. VI, pp. 19-21.

CHAPTER XX

MOTIVE POWER AND ROLLING STOCK

A. LOCOMOTIVES

There are two types of locomotives; namely, rod and geared.

Rod Locomotives. — These have the power transmitted from the cylinders to the drivers by means of a connecting rod. They have a longer wheel-base than geared locomotives, consequently they cannot take as sharp curves, but are the best type for a smooth, well-maintained road of easy grade, and because of their speed are especially serviceable for main-line engines when the haul exceeds 7 or 8 miles.

Those used for logging purposes range in weight from 20 to 150 tons. Saddle-tank locomotives of from 20 to 35 tons' weight are sometimes used on spur tracks, and are more efficient for their size than types with a tender because there is less dead weight for the engine to carry. For main-line work locomotives of 40 tons or more are in general use.

A special form of rod locomotive, known as the Mallet Articulated Locomotive, is used on some main line logging roads that have sharp curves. It has two sets of engines mounted under the boilers, each connected to independent groups of driving wheels. The rear engine is fixed rigidly to the boiler like the regular pattern of rod locomotive. The forward engine and driving wheels are so attached to the boiler that the truck may have a lateral motion when taking curves. This truck is connected to the rear engine by means of a radial draw-bar and steam is transmitted to the cylinders on the front truck through an articulated pipe. The forward pony truck is pivoted and may swing from side to side, independently of the trucks bearing the engines. The cylinders are single or compound expansion, and the exhaust steam of the rear engine is used in the cylinders of the forward engine, thus effecting a saving in fuel.

The advantages of this type of engine are that the wheel base

is materially shortened by having two separate sets of drivers which permit the use of a heavy rod locomotive on a road having curves that are too sharp for the regular type of rod engine of the same weight; and it is so constructed that live steam may be used in the cylinders of both engines to secure greater power to start loads, which increases the hauling power of the locomotive in comparison with that of an ordinary rod engine of the same weight, since an engine can keep in motion a greater load that it can start. Another feature claimed for this locomotive is that the drivers slip less than on other types of rod engines because the forward cylinders depend on the rear ones for steam, and should the drivers connected to the latter slip, the exhaust would fill the feed pipe of the forward cylinders faster than it could be relieved and the resultant back pressure on the high-pressure pistons would reduce the speed and prevent further slipping.

Locomotives of this type, ranging in weight from 81 to 121 tons, are in use on logging roads in the Pacific Northwest. The minimum weight in which they are built is 50 tons. One weighing 121 tons is in operation on the Pacific Coast on a road having 35-degree curves and 8 per cent grades.¹

Geared Locomotives.—The first geared locomotive was constructed about 1885 by E. E. Shay, a Michigan logger, and this locomotive, with modifications and improvements, is in extensive use to-day. Several forms of geared locomotives other than the Shay are now on the market.

The objects sought in geared locomotives are to secure a maximum amount of tractive force with a minimum total weight, a short truck base that will enable the engine to take sharp curves with ease, and a form of truck that will adjust itself readily to an uneven track. These ends are accomplished by making every wheel under the engine and tender a driving wheel; by transmitting power to the driving wheels through a series of bevel gears that bear a ratio to each other of from 2 to 1 or from $2\frac{1}{2}$ to 1; and by the use of swivel trucks on which the drivers are arranged in pairs and connected, one with another, by means of an articulated driving rod. The weight is distributed over a long wheel base which permits the use of a smaller rail, fewer

¹ The Timberman, August, 1910, p. 63.

ties, lighter bridges and a poorer track than for a rod locomotive of the same weight.

On poor track where a speed of from 6 to 12 miles per hour, only, is possible, geared locomotives are preferable to rod because they have large fire boxes, short stroke engines, and a high piston speed. The slow cylinder speed of rod engines causes defective draft on grades.

There are two types of geared locomotives, namely the center shaft and the side shaft.

(1) *Center shaft.* There are several patterns on the market, the ones most commonly used being the Climax and the Heisler.

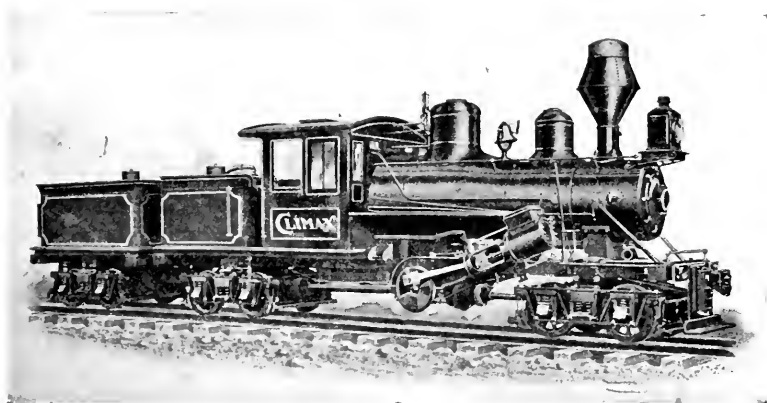

FIG. 114. — A Climax Geared Locomotive.

The Climax is mounted either on two or three four-wheel swivel trucks. When two trucks are used, one is placed under the forward and one under the rear end of the locomotive. When three trucks are used, two are placed under the engine proper and one under the tender. The boiler is the horizontal locomotive type, mounted on a steel channel frame, reinforced with truss rods. Two single-cylinder engines are attached to the frame, one on each side of the boiler, and transmit the power directly to a heavy crank shaft, placed under the boiler and at right angles to it. This shaft is held in position by a frame fixed to the boiler, and power from the shaft is transmitted by gearing to a central articulated line shaft which passes to the forward and rear trucks and runs on bearings on top of each truck axle.

Pinions fitted on this shaft mesh into gears on each axle and thus transmit power to the driving wheels.

Locomotives of this class are built in weights ranging from 18 to 75 tons. Those of from 18 to 60 tons weight have eight drivers and those of from 65 to 75 tons weight have twelve drivers.

A Climax locomotive with an upright engine and a "T" boiler is built in 15- and 18-ton weights. The frame of heavy timbers

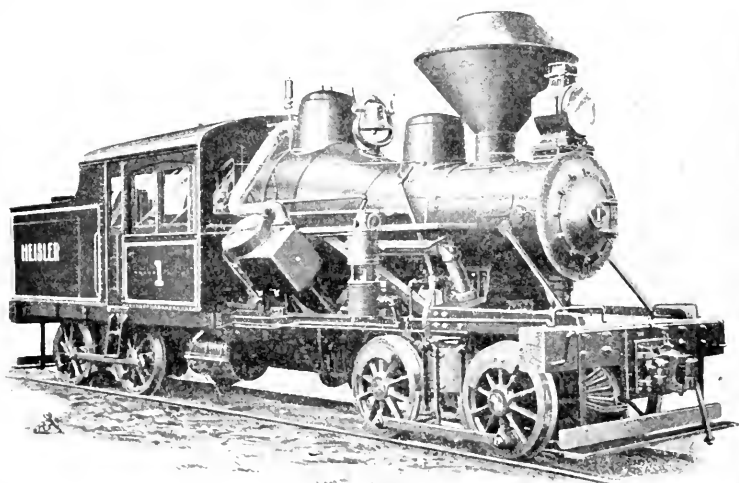

FIG. 115. — A Heisler Geared Locomotive.

is supported at each end by a pair of swivel trucks. Two vertical high-speed, double-acting engines are located in the center of the main frame and are directly connected to a shaft which carries two spur gears of different sizes, which mesh into two main gears on the center driving shaft. These provide a high or low speed as required. A center shaft transmits power to the driving wheels in the same manner as the horizontal style of locomotive previously described. This locomotive is used on stringer and light steel roads.

The Heisler locomotive is built in weights ranging from 18 to 75 tons. The locomotive and tender are carried on a heavy steel frame mounted on two pairs of swivel trucks, one set being

placed under the forward end of the locomotive and the other under the tender.

Power is furnished by two single-cylinder engines attached to the frame one on each side of the boiler. Each engine is inclined at an angle of 45 degrees from the vertical and the reciprocating parts are connected directly to a central single-throw, articulated driving shaft.

Spur wheels are fitted to the center of the forward and the rear axles and pinions attached to each end of the driving shaft mesh into them. The spur wheels and pinions are enclosed in

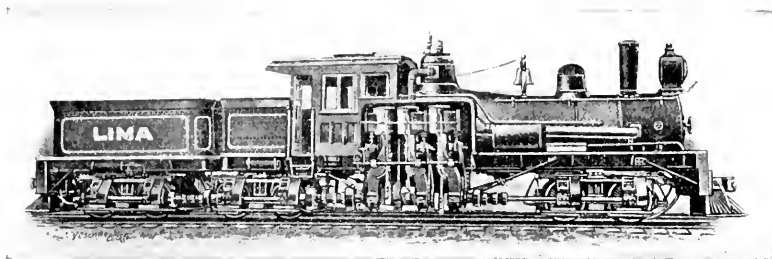

FIG. 116. — A Shay Geared Locomotive.

a tight case which is designed to prevent the entrance of grit and other foreign substances.

(2) *Side Shaft.* — There are two makes of side shaft locomotives, namely, the Shay and the Willamette, both of which are similar in design. The former, built in weights ranging from 13 to 150 tons, has been on the market for many years, while the latter has only recently been offered for sale.

The frame of the Shay is made of heavy steel "I" beams braced with trusses, and is supported on from two to four pairs of four-wheeled swivel trucks. Locomotives weighing 55 tons and less have two trucks; those from 65 to 105 tons, inclusive, three trucks; and the 150-ton locomotives, four trucks. The third and fourth trucks on locomotives weighing from 65 to 150 tons are used to carry the tender.

The boiler is of the horizontal locomotive type with extra large fire box and steam space. The engines are of the vertical type and are attached to the boiler plate on the right-hand side just in front of the cab. Locomotives of from 13 to 20 tons weight are equipped with two cylinders, and those of greater

weight with three cylinders, placed side by side and directly connected 120 degrees apart to a driving rod which is supported on a heavy bearing attached to the boiler. The driving rod is broken both with universal joints and also with two slip joints to permit either an increase, or a decrease in the length when passing around curves. The right-hand wheels on each truck are fitted with gear rims into which the pinions mesh which furnish the driving power for the locomotive.

HAULING ABILITY OF LOCOMOTIVES

The hauling ability of a given locomotive depends largely on (1) the tractive force, (2) the resistance of the load to gravity, and (3) the frictional resistance.

Tractive Force. — The tractive force of a locomotive, sometimes improperly called the “draw-bar pull,” is the power possessed by a locomotive for pulling a train, including the weight of the locomotive itself and its tender. If one end of a rope is passed over a pulley and fastened to a weight hanging in a pit, and the other end is attached to a locomotive running on a straight level track without regard to speed, the tractive force of the locomotive will be represented approximately by the amount of weight the locomotive can lift. Tractive force increases in direct proportion to the area of piston heads, length of stroke and steam pressure in the cylinders, and decreases directly as the diameter of the driving wheels increases.

Tractive force is dependent on the weight of the locomotive on its driving wheels because it adheres to the rail only by the friction developed between these wheels and the rail head, and the resistance to slipping increases with the weight on the driving wheels. The weight on wheels other than drivers has no effect on the tractive force. If the engine is too light in proportion to its power it will be unable to hold itself to the rail and exert a strong pull, while on the other hand if the weight of the locomotive is too great in comparison to its power, it will not haul maximum loads because of the excess weight in itself that must be moved. In industrial locomotives the economical ratio between the weight on the drivers and the tractive force ranges from $4\frac{1}{4}$ to 1 to 5 to 1; *i.e.*, the tractive force in pounds is from 23 to 20 per cent of the total weight on the drivers.

The usual formula employed for determining the tractive force

of single-expansion rod locomotives with a piston speed not exceeding 200 feet per minute is as follows:

$$T = \frac{d^2 \times L \times .85 p}{D}$$

when T represents the tractive force,
 d represents the diameter of the cylinder in inches,
 L represents the length of piston stroke in inches,
 $.85 p$ represents 85 per cent of the boiler pressure,¹
 D represents the diameter of the driving wheel in inches.

As the speed increases the tractive force decreases because the mean effective pressure in the cylinders falls and friction also increases.

Resistance to Gravity. — The resistance to gravity increases in exact proportion to the grade and is 20 pounds per ton of 2000 pounds for each 1 per cent rise in grade; *e.g.*, for a 0.5 per cent grade it is 10 pounds per ton and for a 4 per cent grade it is 80 pounds per ton.

Resistance due to Friction. — The resistance due to friction varies with the character and condition of the roadbed and the rolling stock.

The resistance of the flange friction of wooden rails is about twice that of steel rails. Poorly laid or crooked rails and overloading increase the rolling friction, which is also greater in cold weather than in warm and greater for empty cars than for loaded ones.

Logging cars of good construction, and with well-oiled bearings should have a frictional resistance of from 20 to 25 pounds per ton of weight handled.

The frictional resistance on curves is extremely variable because it is governed by numerous factors, among which are the degree of curvature, length of the wheel base of locomotives and cars, elevation of the outer rail, speed, condition of rolling stock and track, length of train, and length of the curved section. Frictional resistance is partially overcome by increasing the width of track on curves $\frac{1}{16}$ inch for each $2\frac{1}{2}$ degrees of curvature, and also by coning the face of the car wheels so that the greatest diameter is next the flange. When crowded against the rail the

¹ This has been found by practical test to be the average effective pressure in the cylinder.

outer wheels will then travel farther, per revolution of the axle, than those on the inner side of the curve. Friction is also developed because the rigid attachment of the axles to the truck frame does not permit them to assume a radial position with reference to the curve. On a 6-driver rod locomotive the long wheel base is partially overcome by making the center drivers flangeless. On very sharp curves it is customary to lay extra rails inside of the outer rail and outside of the inner rail to provide a support for the flangeless drivers. In determining the amount of frictional resistance due to curves it is the general rule to assume the resistance for standard gauge to be $\frac{1}{2}$ pound per ton per degree. If the wheel base is the same, curve resistance in other gauges is about in proportion to the relation of the gauges.

Calculation of Hauling Capacity. — The hauling capacity of a locomotive in tons of 2000 pounds is determined by dividing the tractive force of the locomotive by the sum of the resistances due to gravity, rolling friction, and curve resistance, and then deduct from this result the weight of the locomotive and tender. This gives the tonnage the locomotive can haul, including the weight of the cars.

The estimated hauling capacity of locomotives of given weights and types may be found in the catalogues of the manufacturers.

The following figures were secured from logging operations. On a 24-degree curve and on a 3.5 per cent grade, two 40-ton Shay engines have hauled six loaded flat cars¹ containing 42,000 board feet, while the same locomotives have hauled eleven cars, 77,000 board feet, around 32-degree curves and up 3 per cent grades. A 60-ton Shay on the same operation hauled five cars, 35,000 board feet, over a road having 24-degree curves and 3.5 per cent grades, and eight or nine cars, of 7000 feet capacity each, over a 32-degree curve and a 3 per cent grade. An 18-ton Shay, operated on a road 4 miles long and having grades ranging from 0 to 8 per cent, and with one 47-degree curve handled, daily, 150,000 board feet.² A 50-ton saddle-tank rod locomotive operated on a road having maximum grades of 2 per cent and curves of 30 degrees has handled eight loaded skeleton cars.

¹ Length 41 feet; weight of each car 27,000 pounds.

² The Timberman, September, 1910.

FUEL FOR LOCOMOTIVES

The fuel used on logging locomotives may be wood, coal, or crude petroleum.

Wood is frequently used in regions where coal and fuel oil are expensive, however, it has several disadvantages.

(1) There is danger from forest fires during the dry season because sparks are thrown for long distances. A high per cent of the forest fires on logging operations start along the railroad.

(2) There is a large bulk of material to be handled. It requires twice the amount of wood as compared to average bituminous coal to secure equal steaming results, and the space occupied by the fuel on the tender is about five times as great. Train crews spend much time daily in taking on wood which involves a time loss both for the train crew and the locomotive.

(3) When pitchy woods are used it is impossible to maintain an even heat, because the resinous matters are driven off first and the burning gas creates an intense heat for a short period, but before the wood has been consumed sufficiently to permit a new supply to be fed into the fire box, the temperature falls markedly. This alternate rising and falling of temperature causes a constant contraction and expansion of the fire box and tube metal and the tubes soon become leaky.

(4) A skillful fireman is required to handle a wood fire so that a sufficient amount of steam may be available at all times, especially on steep grades.

Bituminous coal is preferred to wood on logging roads where it can be secured at a reasonable price, although it is fully as dangerous from the standpoint of forest fires. It is greatly preferred by firemen because the labor is not so exhausting and a more even fire can be maintained.

Fuel oil is preferred when it can be secured at a cost not greatly in excess of other kinds of fuel.

It has the following advantages over wood and coal:

(1) The danger from forest fires is eliminated.

(2) The cost of handling is reduced to a minimum, because the oil may be pumped into the storage tanks on the tender and a sufficient supply carried to run for at least one-half day. The added time saved in taking on fuel as compared to wood is an important item during the course of a month. It is easier to

transport oil in supply tanks than it is to handle an equal fuel value in wood or coal.

(3) A saving in fuel and water is effected on heavy grades and the hauling ability is increased because the steam pressure can be held at a desired point by increasing the oil feed under the boilers. It is not possible to do this with wood or coal, since merely opening and closing the fire box has a marked effect on the efficiency of the locomotive under strained conditions.

(4) A man can learn to fire an oil-burning locomotive in a few days because no especial skill is required. A saving in wages is therefore effected.

The relative value of the three kinds of fuel is approximately as follows:

One ton of good grade bituminous coal is equivalent to $1\frac{1}{2}$ cords of oak wood, or from 2 to $2\frac{1}{2}$ cords of softwood, and from 130 to 190 gallons of crude petroleum.¹

The choice between the different classes of fuel is made either on the basis of forest fire danger or on the relative cost. Some roads passing through the forested regions use oil during the fire season and coal during other periods.

The amount of fuel consumed daily by a logging locomotive is extremely variable, depending on the mileage traveled, the loads hauled, the number of heavy grades traversed, and the efficiency of the fireman. A 45-ton Shay on a western operation averaged 9 barrels of fuel oil daily, while a 37-ton Shay in the same region burned about 5 cords of softwood. A 54-ton rod engine on a southern pine operation averaged 4 cords of pine knots per day, and a 55-ton Shay on the same operation burned from 2 to $2\frac{1}{2}$ tons of bituminous coal.

SPARK ARRESTERS

The laws of most forested states require the installation of some spark arresting device in wood- and coal-burning logging locomotives. Various types of spark arresters are in use, two of which are here described.

¹ Tests on the Boston and Maine, in 1903, showed that from 130 to 140 gallons of crude petroleum were equal to a short ton of Pennsylvania bituminous coal. In 1910 the New York Central and Hudson River Railroad in the Adirondacks found that from 170 to 190 gallons of crude oil were equal to one ton of bituminous coal.

Sequoia Spark Arrester. — This arrester¹ has a $\frac{1}{4}$ -inch mesh wire screen (A) which projects above a cinder pan (B) attached to the stack. From the cinder pan outlet pipes (C) lead to a receptacle below. A light metal deflector is fixed inside the pan to guide the cinders to the outlet pipes. The sparks arrested and deflected by the screen are dropped into the receiving pan. This arrester is used chiefly for wood-burning logging engines. Users claim that the engine exhaust will keep the screen clean

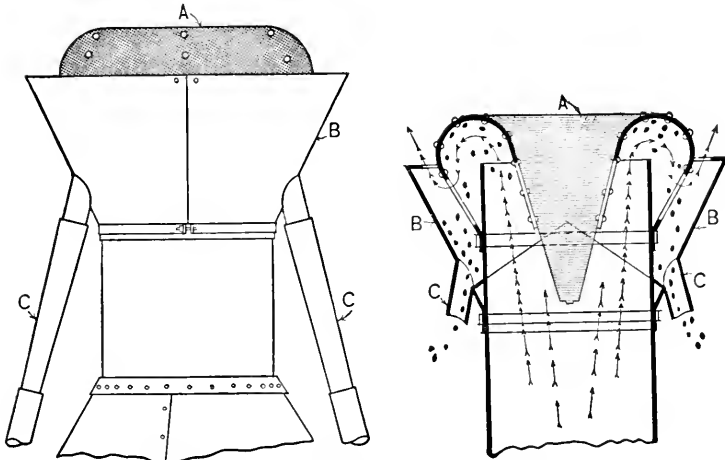

FIG. 117. — The Sequoia Spark Arrester.

and that it does not interfere with the draft. The device is light, and is easily put on and removed.

Radley-Hunter Spark Arrester. — This is an effective locomotive spark arrester² which is used by many lumber companies. The smoke and cinders pass up through the main smoke chamber (A), striking against a spiral cone (B) which gives them a whirling motion, and large cinders are thrown outward by centrifugal force against the perforated screen plate (C). This plate has openings large enough to permit the passage of cinders into the spark chamber (D). Once through this perforated screen plate the cinders are beyond the line of active draft, and by their weight fall into the receptacle (G) from which they are removed through the cleaning-out holes (F). The lighter cinders which are not

¹ Fig. 117.

² Fig. 118.

thrown through the perforated screen plate are carried by the draft against the fine netting (E). In firing up, the natural draft through (A) around (B) and under (E) is unobstructed by netting. This has two advantages: (1) the possibility of clogging is eliminated; (2) there is an easy, free draft when starting the fire. This stack acts as a centrifugal separator which prevents the emission of the larger and more dangerous sparks and only allows the escape of small, light sparks which are dead by the time they leave the stack.

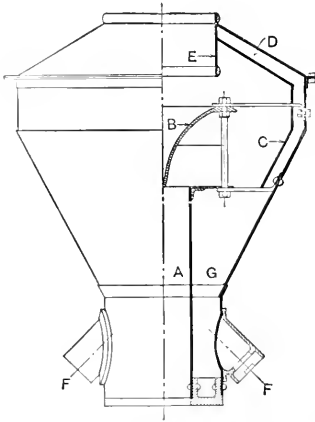

Fig. 118. — The Radley-Hunter Spark Arrester.

WATER

Provision is made for watering locomotives either at the mill or at some convenient point along the railroad. Water may be supplied from storage tanks, by gravity pipe lines from streams, or taken direct from the streams by an injector. The amount of water required is a variable factor, depending on the amount of work performed by the engine and the efficiency of the fireman.

Trautwine says that between 6 and 7 pounds of water are evaporated for each pound of average-grade coal that is consumed. On a basis of $6\frac{1}{2}$ pounds of water (0.8 gallons) per pound of coal, 1600 gallons will be required for each ton of coal, or 800 gallons for each cord of wood consumed. Engines which "blow-off" at frequent intervals will require more water than the amount mentioned.

B. CARS

Logging cars are subject to severe usage and are built chiefly with wooden frames so that repairs can be made at the loggers' machine shop.

NARROW GAUGE

When light rails are employed, the same type of car as described for the stringer-road¹ is often used. When a 35- or 40-pound rail is in use a heavier car is desirable. The main

¹ See page 282.

features are similar to the 8-wheeled stringer-road truck mentioned, but they are built heavier to secure a capacity of from 1500 to 3000 board feet.

BROAD GAUGE

Three types of cars are in use on broad gauge roads, namely, flat cars, skeleton cars, and trucks.

Flat Cars. — These are chiefly used where the logs are hauled for a portion of the distance over a trunk-line road. The latter usually furnishes the cars, keeps them in repair, and provides motive power when the cars are on its line. Payment for this service is made on the basis of the number of cars hauled, the number of thousand board feet of logs handled, or a flat rate per train-mile.

Logging flat cars may have special rails laid on the car floor on which log loaders travel, and also wooden or metal bunks to raise the logs off the car floor.

Logs are held on flat cars by stakes or chains.

(1) *Short Stakes.* — These are made near the loading place by a stake cutter, and are inserted in the stake pockets on the car. They are usually thrown away at the unloading point. If bunk loads only are hauled and the logs do not occupy the entire floor of the car, the bunks are equipped with adjustable "choek blocks," or dogs, which are fitted to the bunk close to the log; or rough blocks or small logs may be inserted between the logs and the stakes to make the load solid. Where a top load is put on a car, the logs wedge between those on the car floor and make a compact load.

(2) *Patent Drop Stakes.* — These project from 2 to 3 feet above the car floor and are equipped with safety trip devices for use in unloading. The logs are seldom bound with chains unless the load is built high.

(3) *Long Stakes.* — For carrying high loads, cars are often equipped with stakes from 5 to 6 feet long, which are cut from saplings or made from sawed material. They are inserted in the stake pockets, and after the greater part of the load has been placed in position the stakes on the opposite sides of the car are bound together with heavy wire, cable, or with chains to prevent the load from spreading at the top. The remainder of the load is then placed on top of the binders. Sapling stakes with wire

binds are used where it is not feasible to return stakes and binding material to the forest for further use.

(4) *Chains*.—Logs may also be made secure with binder chains. After the main body of the load has been placed on the car, either a chain is passed around each end of the load, or one chain may be passed around the center. In the latter case corner bind chains are sometimes used if the car is not provided with stakes. Each set consists of two chains, one of which is fastened near the center, and the other to the outer end of the bunk. The first chain is about 2 feet long and the free end terminates in a ring, 3 or 4 inches in diameter. The second chain is several feet long and its free end terminates in a grab hook. When the first tier of logs is loaded on the car, the corner binds are adjusted on the two outside logs. This is accomplished by placing the long chain over the log, passing the grab hook and chain through the ring in the short chain, drawing the long chain taut and locking it at the ring with the grab hook. The top load is then placed and if necessary a center bind placed around the entire load, and one or more logs placed on top of the chain to tighten it.

Flat cars are from 24 to 41 feet long. Those 36 feet and over in length will carry a double load if the logs do not exceed 18 feet in length. The average car load, for medium-sized logs, is from 4000 to 6000 board feet, with a maximum of about 10,000 feet.

Skeleton Cars.—This type of car has two pairs of 4-wheeled trucks joined together by a heavy wood bolster. A bunk from $8\frac{1}{2}$ to 10 feet long is placed directly over each pair of trucks. Bunks are approximately 11 feet apart on a standard length car, but cars are also built for long logs with bunk centers up to 33 feet apart.

Skeleton car bunks are equipped with a variety of stakes and "chocks" for preventing the bottom tier of logs from rolling off.

One end of each bunk is often provided with bunk spikes, bolted to or driven into the wood while the other end is equipped with a chock or dog, which projects above the bunk when in use, but which may be dropped below the bunk level by means of a rod operated from the opposite side when the car is ready to unload. A single "top bind" chain also may be placed around the center of the load.

Cars are frequently equipped with patent drop stakes, which

project from 18 to 24 inches above the bunk and are held in place by means of chains or bands, which may be loosened by a rod manipulated on the opposite side of the car. Drop stakes are useful when small- and medium-sized logs are handled. They also obviate the use of binding chains. Some operators use round stakes without attachments.

In handling small- and medium-sized logs the loads are sometimes built up square and the logs are held by several sets of binding chains and often by a top bind chain. Logs are loaded

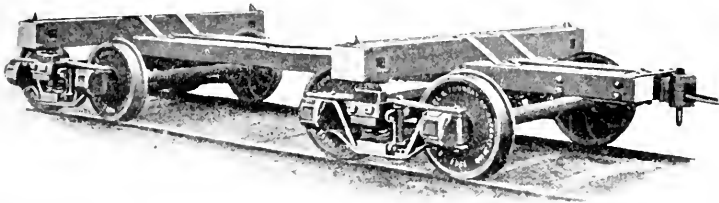

FIG. 119. — A Skeleton Log Car. A type common in the southern yellow pine forests.

in this manner by power loaders and a falsework is used on the side opposite the skidway, against which the loads can be built and held in position until binding chains can be placed.

Skeleton cars are equipped either with hand or air brakes, and usually with pin couplers. They range in weight from 6900 to 18,500 pounds each and have a rated carrying capacity of from 30,000 to 80,000 pounds. They will carry from 1600 to 10,000 board feet. The heavier weight cars are employed exclusively for the heavy timber of the Pacific Coast.

Skeleton cars combine lightness with a maximum carrying capacity, are reasonable in initial cost, and are the cheapest form of car to maintain.

Trucks. — These are used on the Pacific Coast and are especially adapted to long logs. They have two pairs of wheels on which a steel frame is mounted. A steel swivel bunk, 9 or 10 feet long, is mounted on the frame above and midway between the pairs of wheels. The bunk is armed either with steel spikes or

with a long sharp strip of steel which prevents the logs from slipping forward or backward.

Trucks are equipped with hand or air brakes; pin or automatic couplers; patent stakes or "chock blocks" for holding the bunk load in place; and chains for binding the load. They are built in a high and a low type, the former carrying the heaviest loads. They are in common use on roads operated by loggers but are not operated on trunk lines, which will not haul them.

Logs of approximately equal lengths are selected for a given load, and a truck is required under each end of them. The

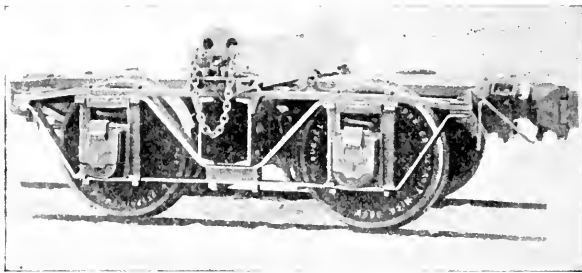

FIG. 120. — A Log Truck, Western Type.

weight of the logs may be sufficient to hold them firmly on the bunk without the use of chains, however, if the train is long and the strain is severe, chains are used. When the cars are equipped with air brakes, extension air-brake hose is adjusted under the log or logs between the two trucks, and is held in place by chain or rope attachments placed around one of the logs.

Trucks weigh from 10,600 to 13,500 pounds each and have a rated carrying capacity of from 50,000 to 75,000 pounds.

In practice low trucks seldom carry more than 5000 board feet and high trucks 7500 feet.

ROLLING STOCK AND MOTIVE POWER EQUIPMENT

The number of logging cars required on a given operation is dependent on

- (1) The amount of timber handled daily.
- (2) Capacity of the individual cars.

(3) The average number of cars hauled per train load.

(4) Manner of loading and handling cars in the woods. When loading is concentrated in one or a few places, fewer cars are required than where loading is done at various points.

(5) Manner of handling cars at the destination. If the train crew unloads the cars on arrival at destination, the number of cars required is less than where the cars are left to be unloaded while the engine returns to the woods for another train load.

(6) The distance that the cars must be hauled. On long hauls a maximum number of cars are on the road to or from the mill; while on a short haul the number is less because of the short time required to make a round trip. The requirements for a large operation having an 8- or 10-mile haul cannot be met unless the number of log cars available is equal to twice the number of loaded cars hauled daily.

The equipment used by a large white pine logging company operating 14 miles of narrow-gauge main line and from 2 to 4 miles of spurs, and delivering daily from 200,000 to 210,000 board feet at the mill was as follows:

- 154 Skeleton logging cars (24 feet long, bunks 8 feet wide, 10 feet center to center), 3000 board feet capacity.
- 2 Caboose (1 for the main line and 1 for the construction train).
- 2 Box cars for hauling supplies to camp.
- 2 Flat cars for the construction train.
- 2 Water tank cars for hauling the camp water supply.

Thirty-five cars were loaded at skidways each morning and each afternoon, making a total of seventy cars daily. The remainder were on the road or in the repair shop.

Three locomotives only were used on this road, two for hauling and one for road construction work. One of them, a 60-ton rod engine, hauled only on the main line, while a 55-ton Shay geared locomotive hauled on the spurs and pulled a train for 7 miles on the main line each morning and night. A 35-ton Shay was used exclusively for construction work and for hauling water for the camp.

A logger in the Missouri shortleaf pine region, operating 35 miles of standard-gauge main line and from 15 to 20 miles of spurs, used the following equipment to handle 125,000 board feet daily (90 cars).

- 316 Skeleton log cars (20 feet long; bunks 10 feet wide, 12 feet center to center).
 2 Caboose (1 for the main line and 1 for the loading crew).
 2 Tank cars for hauling water for the camp.
 2 Flat cars (1 for the construction crew and 1 for the main-line train).
 1 Mule car for transporting the animals used in loading.

Seven rod locomotives of the following weights were used:

1.....	24-ton
1.....	36-ton
1.....	38-ton
2.....	44-ton
1.....	48-ton
1.....	50-ton

Five engines were in constant use in hauling on the main line and spurs; one locomotive was used by the loading crew and construction train; and one was held in reserve.

An Alabama longleaf pine operation with 24 miles of main line, and from 5 to 6 miles of spurs used fifty-three 40-foot flat cars to haul, daily, from twenty-five to thirty cars of logs (70,000 to 90,000 board feet). These cars had a rated capacity of 60,000 pounds and each carried from 2500 to 3500 board feet.

The logs, which were hauled 6 miles over a trunk-line railroad, were loaded on cars provided and kept in repair by the trunk-line railroad which also furnished one 65-ton rod engine for use on its track.

The logging company provided one 54-ton rod, one 40-ton rod, and three Shay locomotives of the following weights: 28, 32, and 55 tons. The rod engines were used on the 18 miles of main-line logging road, while the 32- and 55-ton Shays were used on the spurs, and the 28-ton Shay on the construction train.

On a western operation where 200,000 board feet were hauled, daily, over a 3-mile main line with a 5 per cent maximum grade and many curves, a 55-ton Heisler was used on the main line and a 35-ton Heisler on the $3\frac{1}{2}$ miles of spurs. Forty 40-foot flat cars were required to handle the output

BIBLIOGRAPHICAL NOTE TO CHAPTER XX

- CORPS OF ENGINEERS, U. S. Army: Military Railways. Professional Papers No. 32, Washington, 1917.
 EARLE, Robert T.: Adaptability of the Gypsy Locomotive for Logging Purposes. The Timberman, August, 1910, pp. 34-35.

- EVANS, W. P.: The Mallet Locomotive in the Field of Logging Operations. The Timberman, August, 1910, pp. 61-64.
- HARP, C. A.: The Gasoline Locomotive and its Availability for Logging Roads. The Timberman, August, 1910, pp. 57-58.
- IVES, J. F.: Fuel Oil as a Substitute for Wood and Coal in Logging. The Timberman, August, 1909, p. 39.
- IVES, J. F.: Utilization of Compressed Air on Logging Trucks. The Timberman, August, 1910, p. 60.
- RUSSELL, C. W.: Utilization of Air on Logging Trucks. The Timberman, August, 1910, p. 58.
- TATE, M. K.: Locomotive Maintenance. American Lumberman, July 15, 1922, p. 47.
- TURNER, Harry: Adjustable Air-brake Equipment for the Control of Detached Trucks. The Timberman, August, 1912, p. 54.

CHAPTER XXI

LOADING AND UNLOADING CARS

LOADING CARS

The Crosshaul. — One of the early methods of loading cars was by means of the crosshaul.¹ A crew of five men and a team were required and the daily output did not exceed 40,000 board



FIG. 121. — Loading Log Cars with a Crosshaul. Missouri.

feet. On large operations this method is too slow, although it is still used by loggers who have a small daily output.

Power Loaders. — One of the first successful power loaders was put on the market in 1885 and since that time many forms have been brought out, which differ in the manner of locomotion, character of booms, and other details to meet special requirements. They are used for loading flat and skeleton cars.

¹ See page 138.

A power loader has a steam hoisting engine and drums, an upright boiler, and a rigid or swinging loading boom. It is usually mounted on a truck which is provided with some appliance for transporting the machine. Gasoline engines have been substituted for steam on some patterns but they are not in extensive use.

Loaders are built with a short swinging base-control boom, a long swinging end-control boom, or with a rigid boom. The first two types are adapted for loading on poor track because the logs can be centered on the car and less manual labor is required to build the load securely. They also are desirable where the logs are scattered. Short booms are not adapted to handling long lengths. Rigid booms are used to advantage on good track where the logs are abundant and fairly well decked.

There are two types of loaders.

(1) Loaders operating from log cars. The Barnhart, Model C American, and the Rapid loaders are examples of this type.

(2) Loaders operating from the main railroad track. The Decker, McGiffert, Surry Parker, American Models D and E, and the Browning are the more common machines of this type.

An advantage of the second type of loader is that it may remain in one place until all logs are loaded, while loaders of the first type must change their base for every car unless a locomotive is in attendance to move the train as desired.

(a) *Barnhart*. — This style of loader requires either permanent or temporary tracks on the log car over which the loader passes. When permanent track is used, the rails are laid only the length of the car bed, because otherwise they would interfere when the train rounded sharp curves. The space between the rails on each car is spanned with two Ω -shaped irons placed on the car rails which can be removed as soon as the loader has passed over the gap. Temporary tracks are made in three sections. The loader rests on one section, another spans the gap between the two cars and the third rests on the empty car at the rear of the machine. As the loader proceeds along the train the tracks are picked up by the loader and moved behind it.

The engine, drums, booms, and all working parts are mounted on a steel frame, which is pivoted to a truck frame carrying eight pairs of trucks, with wheels 10 inches in diameter. The loader can revolve in a complete circle by means of a geared

wheel, attached to the truck frame, into which mesh two pinions which are driven by a double rotating engine. One form of this loader uses a chain control for the rotary movement. The weight of the loader is borne on five cone-shaped rollers attached to the truck frame.

The loader moves under its own power from one car to another.

A feature of this loader is a slack pulling device which has a pair of friction sheaves mounted on the boom and driven by a belt. The power is controlled by a hand lever.

Two sizes of loaders are made, the smaller, No. 10, having chain control, an oak boom 25 feet long, a double 6½- by 8-inch



FIG. 122. — The Model C American Log Loader.

hoisting engine with governor control and a 36- by 96-inch vertical boiler.

The No. 12 loader has a steel boom 23 feet 9 inches long, gear and pinion rotary control, double hoisting engines with 7½- by 8-inch cylinders, controlled by a balanced throttle, and a 50- by 82-inch vertical boiler. The pull at the tongs on this machine is from 9 to 10 tons.

The Barnhart, though a fast machine, is more expensive to keep in repair than some of the other types of loaders, and requires skillful labor to secure the maximum output. It is rarely used on narrow-gauge roads. The maximum log that it can handle is one containing about 1500 board feet.

(b) *Model C American.* — This type of loader is similar in character and operation to the Barnhart. It runs on temporary tracks and uses the geared circle for rotating the machine. It is one of the cheapest loaders to keep in repair and will handle a log containing 2000 board feet.

(c) *Rapid.* — The Rapid loader has a stiff wooden boom, an upright boiler and a double hoisting engine. These are mounted on a pair of steel runners on which the loader slides from car

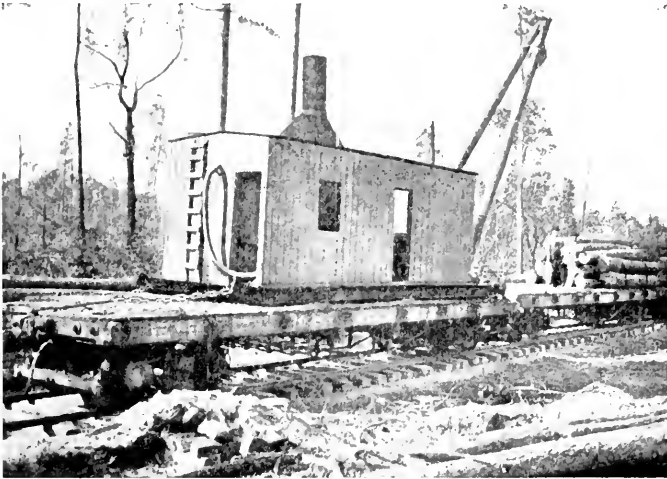

FIG. 123. — The Rapid Log Loader.

to car. Power for moving itself is furnished by a cable and drum. Rapid loaders are sometimes mounted on a heavy pair of two-sleds for sled loading. It is adapted for light work.

(d) *Model D American.* — This loader is used only where light equipment is employed because it is necessary for the loader to lift the empty car from the track in the rear to the front, or vice versa. Model E is similar in character but has eight wheels on the trucks and is adapted for poor track. Both D and E models can move under their own power.

(e) *Decker.* — The frame of this loader has two decks. The upper one is supported by steel posts which rest on bolsters placed directly over the trucks on which the loader is mounted. This deck carries the boiler, engine, and other working parts of the machine, while the lower deck is on a level with the bolsters

and carries a portable track with hinged end sections which may be lowered upon the rails and thus provide a continuous track through the loader.

In operation a train of empties is pushed out to the loader and backed through it until the last car comes in proper position, under the boom, for loading. As other empty cars are required a cable connected to a drum is run through the machine and is attached to the draw bar of the first empty car. This car is then hauled through the loader, pushing the loaded car forward

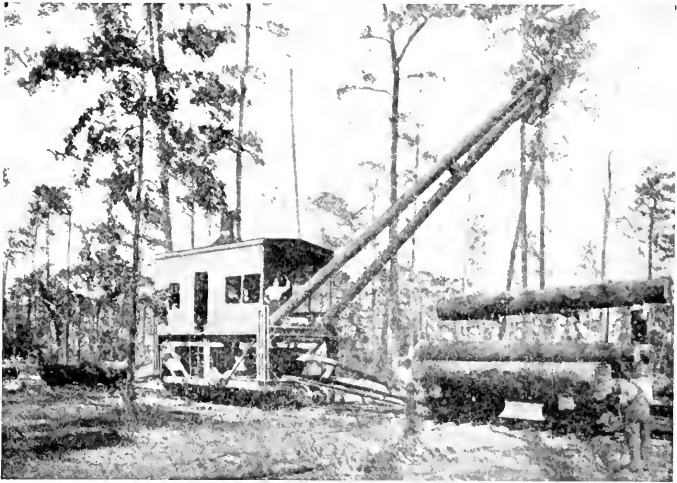

FIG. 124. — The Decker Log Loader.

until the succeeding empty one is in position for loading. The work proceeds in this manner until the skidway has been emptied.

The Decker can travel under its own power from one point to another, and can switch cars if necessary, although the latter is not economical if a locomotive is available. It is recommended for narrow-gauge steel and wooden railroads.

(f) *McGiffert*. — This loader is similar in operation to the Decker. It has an elevated deck which carries the working parts and when the machine is loading the frame is supported on four corner posts or "spuds" which are curved in toward the base. Each post ends in a broad shoe which rests upon the crossties outside of the rails. The empty cars pass under the deck, traveling on the main track. The loader is equipped with

a pair of trucks at both the forward and the rear ends, on which the loader travels. The frames to which these trucks are attached and the trucks themselves are so hung on a shaft under the floor of the deck that during the loading operation they may be brought to a horizontal position under the loader. The machine is then supported on the ties by the spuds. When ready to move, the weight of the loader is lifted from the spuds by bringing the truck frames to a vertical position by means of cables

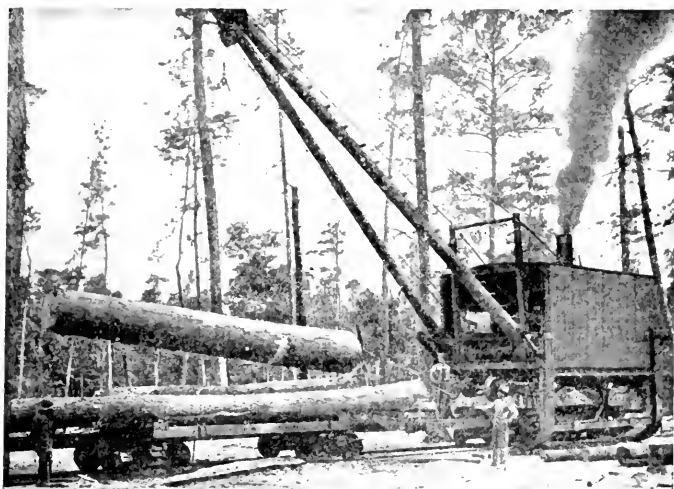

FIG. 125. — The McGiffert Log Loader.

and other mechanism. This raises the loader from the spuds ready for a change of base. Power is transmitted to the axles of the trucks by means of sprocket chains.

This machine has a boom which can swing through an arc of approximately 40 degrees and is adapted for longer logs and wider gauge roads than the Decker because of the greater space between the rail and the deck.

(g) *Surry Parker*. — This loader embodies the same general principles as the two loaders previously described, having the upper deck high enough to permit loaded flat cars to be run under it. An early type was built without a device for transporting itself, being carried about on a flat car. The modern type of machine, however, is portable, the power being transferred from the engines to the axles by a chain drive.

Capacity. — The output per day of a given type of loader is dependent largely on the skill of the operator and the loading crew, provided logs are at hand and the supply of empty cars is adequate. The daily output may be as low as from 30,000 to 40,000 board feet and again may rise to nearly 300,000 board feet. For short logs the swinging-boom base-control type of loader is the more active and under average conditions may load from 100,000 to 130,000 board feet daily.

SPECIAL LOADING DEVICES

A number of special devices are used for loading large logs on cars, especially in the Pacific Coast region.

The "Gin-pole."— This is a modification of the crosshaul, a yarding engine being substituted for horses. A 1-inch loading cable passes through a block attached to a mast or gin-pole about 60 feet in height, which is set in the ground on the side of the track opposite the landing, and is thoroughly braced with guy ropes.

The logs are loaded from a landing along the railroad to which they are brought by a yarding engine, road engine, or swing donkey. Landings are built level with the car bunks and are made from 40 to 300 feet long, but they usually are about 120 feet long to accommodate two 60-foot logs. They may be made of a number of skids from 15 to 18 inches in diameter, placed about 6 feet apart at right angles to the railroad track, and supported on cribwork; or a large log may be placed on the fore part of the landing parallel and next to the track and from this the main skids supported on a cribwork run at right angles. The rear of the landing may be at a lower level than the part nearest the track.

Where top loads are put on cars a "lead log" is placed parallel to the tracks on the side opposite the landing. It projects slightly above the top of the car bunks and in order that the direction of pull may always be at right angles the loading cable is made to pass through the lead blocks which are attached to this log. Where a lead log is not used it is customary to set upright posts 20 feet apart along the track opposite the landing. These are not as convenient as the former because their use makes it necessary for the engineer of the road engine to always leave the logs opposite them.

The loading cable passes from the drum on the road engine, or from a special loading engine through a block at the peak of the gin-pole, then through the lead blocks, then across the car and over and under the center or end of the log to be loaded. The cable is then brought forward and the grab hook on the end of the cable is caught in the edge of the landing, or on the car bunk. By winding in the cable on the drum the log is rolled up the landing and upon the car.

A modification of this device has been brought out for more rapid work and for handling long logs. It has a loading engine similar in type to the yarding engines and two gin-poles and loading lines instead of one. The cables are attached to the logs by means of tongs or slings. Each line may be operated independently or the two may be operated in unison.¹ Gin-pole loading is being superseded by overhead methods.

Loading with Jacks or Peavies. — This method, which is now rarely used, is employed where logs are loaded by hand and only bunk loads are placed on the cars, peavies being used for loading small logs and jacks for large ones.

Overhead systems. — Various forms of overhead loading devices have been developed to replace the gin-pole because they obviate the construction of landings which have limited storage capacity and from which logs must be loaded in the order in which they are yarded, thus eliminating any chance for the loaders to select the logs as they are placed on the cars. The greatest development in overhead loading equipment has been made in the Northwest. Some overhead systems operate without standing lines, while others are equipped with them. The type shown in Fig. 126 has two gin-poles placed from 100 to 200 feet apart, the head pole being from 50 to 60 feet in height. This is located on the side of the track opposite the spot at which the yarding engine delivers the logs. The other pole is from 15 to 20 feet in height and may be a gin-pole or a tall stump. The $\frac{7}{8}$ -inch hoisting line leads from the main drum of the loading engine through a double block at the top of the head pole, then through a single block in the bight of the line. The $\frac{5}{8}$ -inch trip line leads from a second drum on the loader, through a block at the top of the head pole, then through a block on the opposite pole, to the 12-foot crotch spreader. This equipment can move

¹ The Timberman, December, 1910, p. 33.

logs either away from or toward the cars. The landing place can be made large enough to store 100,000 board feet of logs, so that loading can continue when the yarding equipment is temporarily out of commission and the yarding equipment likewise may continue to bring in logs even though loading and hauling may not be in progress.

An overhead loader with a standing line is shown in Fig. 127. Two trees or gin-poles from 200 to 800 feet apart serve as supports for the standing line which is located so that loading may take place from either side of the track. A loading line passes from the loading engine up to and through a block on the near spar,

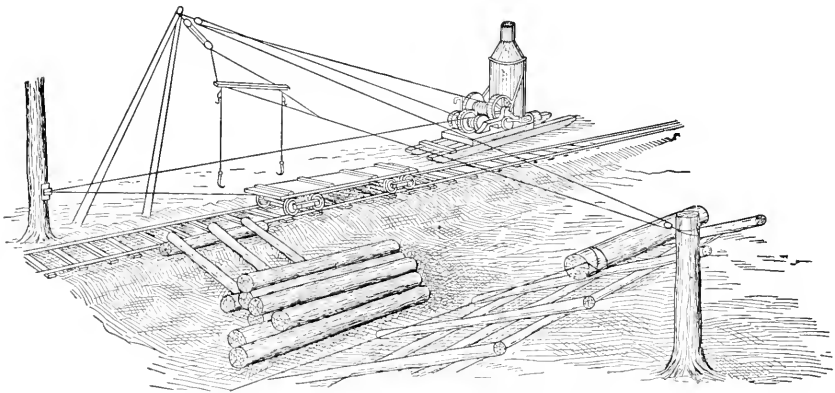

From Bulletin 711, U. S. Dept. of Agriculture.

FIG. 126. — An Overhead Loading System used in the Pacific Coast Forests.

thence to the trolley where it is looped down over sheaves on the carriage to support a block in the bight of the line and then to the far spar where it is fastened. The trolley is moved back and forth by means of trip lines, one of which leads from one end of the trolley to a block on the far spar, then back to and through a block on the near spar and down to a drum on the loader. A similar trip-line is attached to the other end of the trolley and passes to and through a block on the near spar and down to a drum on the loader.

The lifting line is operated independently of the trip-line, hence the load can be raised or lowered as the trolley travels along the standing line.

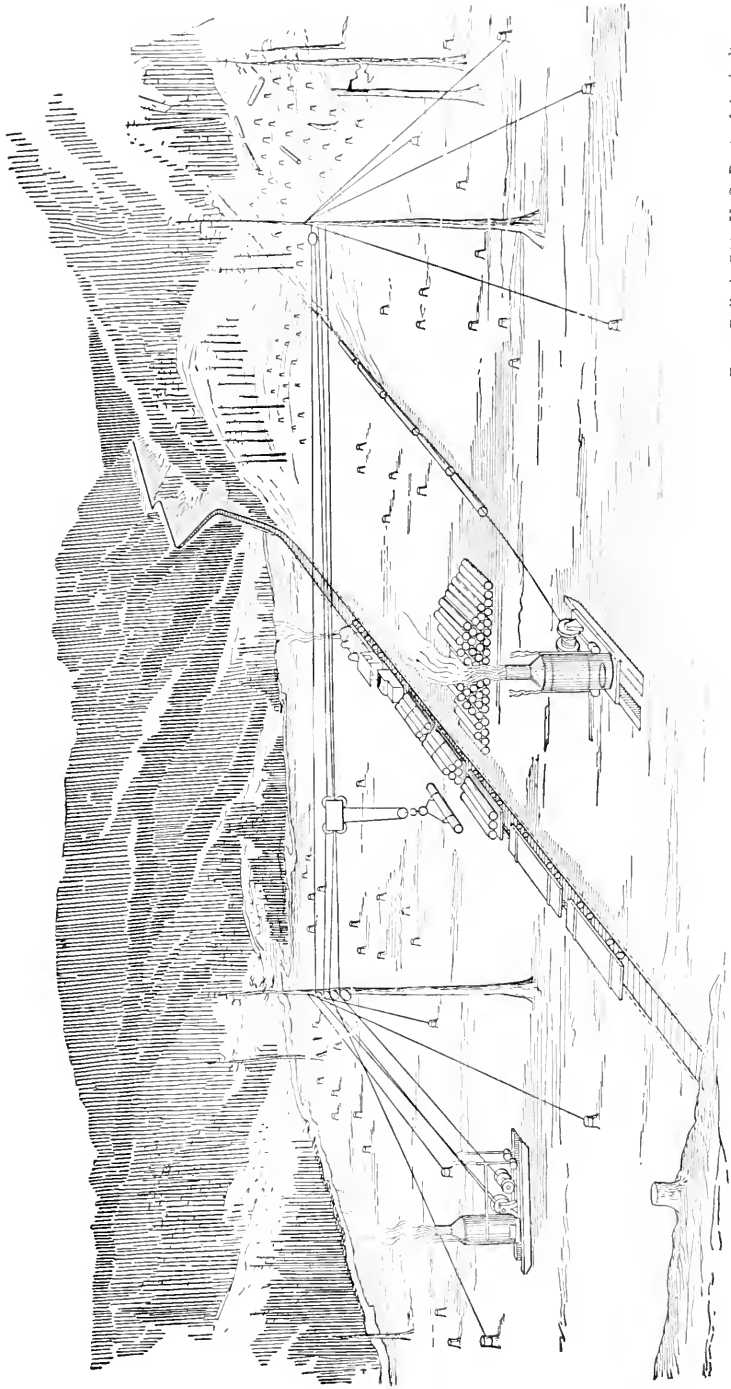

From Bulletin 711, U. S. Dept. of Agriculture.

Fig. 127. — An Overhead Loading System used in the Pacific Coast Forests.

Guy-line System. — This is a common method of loading logs which have been yarded by an overhead or high-lead system.¹ A standing line, usually a guy line for the spar tree, is stretched across the track and from this is suspended a block at a height of about 60 feet above and directly over the center of the track.

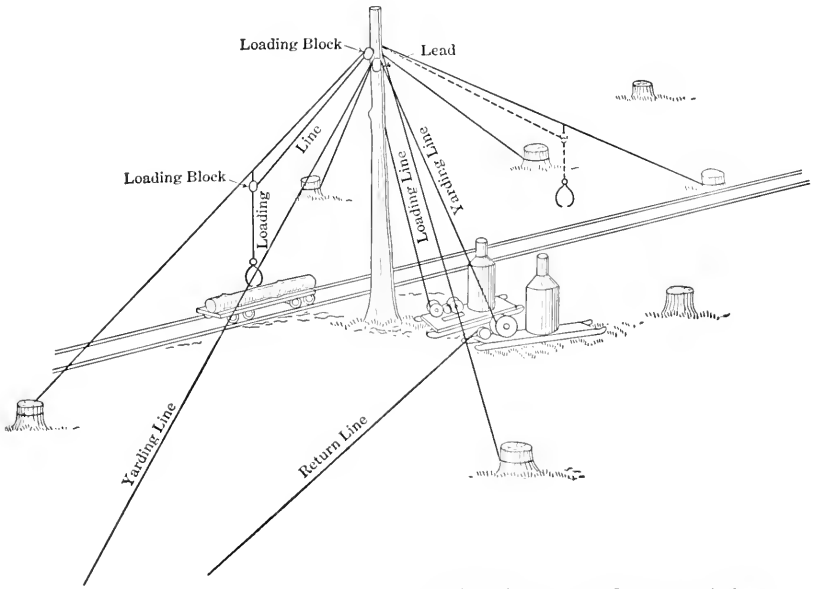

From Bulletin 711, U. S. Dept. of Agriculture.

FIG. 128. — A Single Guy-line Loading System. Pacific Coast Forests.

The loading line passes from a drum on the yarding engine or loader up to and through a block on the head spar and thence to and through the loading block. This method is not capable of handling a very large yarding output. When this is necessary two loading lines may be used.

Swinging-boom loaders. — When logging with an overhead system in small- to medium-sized timber, loading equipment of the type shown in Fig. 129 may be used. An end-control swinging boom about 50 feet long is supported at its base on the head spar tree, and at its outer end by a cable which is also attached to the upper part of the spar. The boom may be moved in a radius of 90 or more degrees by means of the swinging lines, each of

¹ See Fig. 128.

which passes from a small drum on the loading engine, up to and through a block on the spar, through a block on the end of

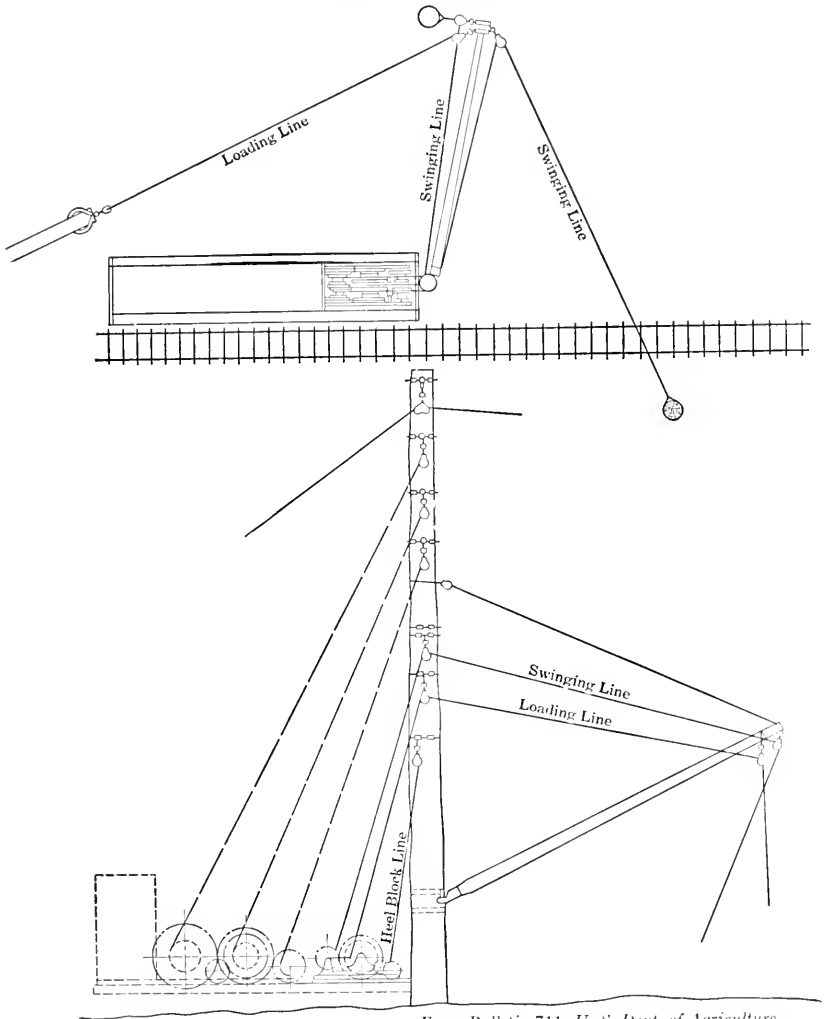

From Bulletin 711, U. S. Dept. of Agriculture.

FIG. 129. — A Swinging-boom Loading Device sometimes used with the Lidgerwood Overhead Logging System.

the boom and thence to a stump or "dead man." By pulling in on one line and letting the other run out, the boom may be swung to one side or the other.

Jack Works. — Where logs are to be raised to a considerable height as from a river or a pond a “jack works” is employed. This method has been used both in the South and in the Northeast, when medium-sized logs are handled. A jack works is a long narrow platform built at a sufficient height above ground to permit the construction of a sloping dock on the side next to the loading tracks, the base of which is flush with the car bunks. The loading tracks on which the log cars are “spotted” are placed parallel to the dock. The length of the platform is governed by the number of cars to be loaded and the switching facilities. If provision is made for moving cars by gravity and the logs are of fairly even length so that any of them will go on a given car, the platform need only be long enough to handle the longest logs. When logs must be assorted before loading and when many cars must be spotted at one time the platform should be of sufficient length to accommodate the maximum number.

A shallow trough runs the entire length of the platform, in which an endless chain travels to which log dogs are attached at approximately 8-foot intervals. A similar trough and chain serves to bring the logs from the water to the platform along which they are carried until they are rolled upon the dock below. The chains are driven either by a steam or gasoline engine. The logs are loaded on cars chiefly by gravity. Skids are placed from the docks to the load as the latter is built up, and the top logs are rolled upon the load with cant hooks.

UNLOADING LOG CARS

The expeditious unloading of log cars is an important factor in train operations because it reduces the amount of rolling stock required. Softwood logs are generally stored in ponds, streams, or on storage skids, but hardwood logs and pulp stock may be placed in large piles on land.

Rollways. — Where water storage is used the track is built along the bank of the stream or pond, or else extended over the water on piling. In the former case it is necessary to construct an inclined rollway over which the logs may be rolled into the water. This has a framework composed of three parallel sets of stringers, spaced 8 feet apart, which extend along the water's edge from 400 to 600 feet. The outer stringer projects over

the water's edge and is supported on piling or on timbers that rest on solid bottom, while the other stringers are supported on round or square uprights placed from 4 to 6 feet apart. Heavy round or square timbers, often shod with railroad iron, are placed on top of and at right angles to the stringers, and serve as a bed over which the logs are rolled. These timbers are spaced

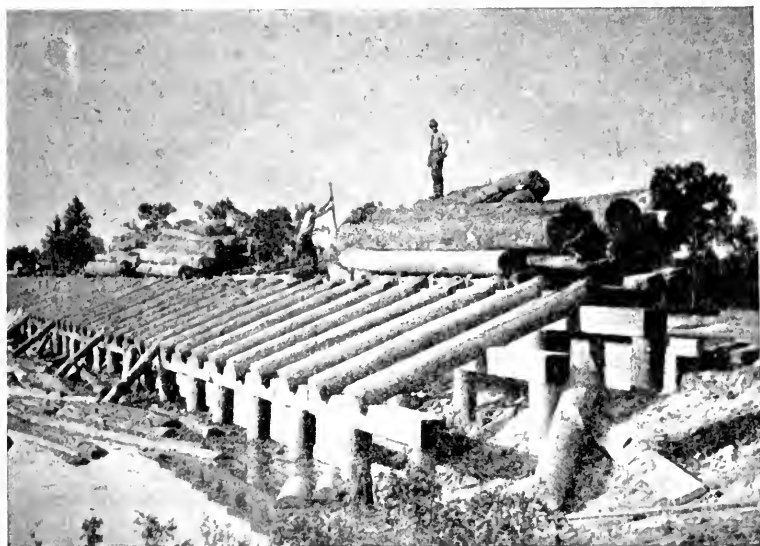

FIG. 130. — A Rollway at the Mill Pond. Texas.

from 4 to 6 feet apart on the stringers and have a pitch of from 15 to 25 degrees. The upper ends are placed level with the top of the car bunks.

When the water is shallow near the rollway, the logs are shunted into deep water by sloping skids which extend from the lower stringer to the bed of the pond or stream.

The railroad track is laid parallel with the rollway and close enough so that the top of the car bunks will be about 6 inches distant. To facilitate unloading, the outer rail is elevated from 12 to 15 inches thus throwing the side of the car next the rollway at a lower level. Many of the logs will roll from the car into the pond when the car stakes are removed, the dogs on the car bunks lowered, or the binding chains are loosened. The remainder of the logs are rolled off the car by means of cant hooks or peavies.

This is one of the simplest methods and is widely used in the Lake States and southern yellow pine region where the timber is of medium size.

On the Pacific Coast where logs are often unloaded into tide-water and rafted, the track is built on piling either over the water or else along the bank. The structure is long enough to accommodate twenty cars or more. Some protection must be given the piling supporting the track and when the trestle is in deep water this is accomplished by driving a pile at the end of each tie. These piles are cut off about 2 feet below the level of the track and are beveled on top to shunt off the falling logs. An additional row of piles is sometimes driven just outside the first one and beveled off in a similar manner. When the trestle is located on land, a slanting roll-way must be built out far enough to carry the logs into deep water.

The outer rail of the track is elevated from 8 to 12 inches, either by leaving the outer legs of the trestle longer, or by elevating the outer ends of the cross-ties by means of blocking.

When car stakes are used the practice is either to knock them out with a maul, or to cut them off with an ax. Logs often will roll off the cars unaided, but when assistance is required, jacks are used for log trucks and often for flats. Power unloaders are often used for unloading flat and skeleton cars.

For dry land storage at mills, skidways are built on one or both sides of the device used for conveying logs into the mill. The skidways are wide enough to hold one car of logs, and long enough to accommodate the required number of cars. Storage skidways are a series of parallel skids placed at right angles to the railroad track, and supported on timbers placed on the ground. The skids slope toward the center at an angle of from 10 to 12 degrees to facilitate handling the logs. The outer rail of the track is elevated to aid in unloading.

Power Unloaders. — There are several types of power unloaders which are used chiefly on the Pacific Coast where large and long logs are handled. However, some types are employed in the Lake States and in the hardwood region.

Swinging-boom log loaders which pick logs from the car and deposit them on either side of the track are among the devices used where logs are stored in piles on dry ground.

An overhead cableway system which is supported on two spars from 500 to 600 feet apart and spanning the railroad track on which the logs are brought in, is sometimes employed where logs are stored in piles.

An ingenious device called a log dump is in use at some plants. One built in Washington has two dumps separated by 30 feet of stationary track, the entire structure being supported on piling.¹ The platform of each dump is 40 feet long and has four latch timbers (*A*)², which are 11 feet long and a fifth timber (*B*), known as the trip timber, which is 36 feet long and of larger size. The frame is hung on a roller timber (*C*) 18 by 18 inches square and 40 feet 2 inches long which rests on heavy cast-iron sills. The roller timber is bound with an iron cylinder to facilitate its rotation. This roller is placed off-center, the distance between the rail on the land side and the center of the roller timber being 25 inches. When the latches (*D*) holding the frame are released the weight of the load will automatically tip the frame toward the brow skid (*E*) through an arc of 15 degrees. The cars are run on the dump, the chains holding the logs on the cars removed, and the latches (*D*) opened. The dump then revolves until the car bunk rests on the brow skid (*E*). Many logs will roll off, but some may have to be started by means of a cable passing through a block rigged on a gin-pole and pulled by a locomotive. The dump will not tip when the load is heaviest on the land side, in which case it is tilted by prying up on the end of the trip timber (*B*). After the logs are off the car the dump is brought to a horizontal position by having men walk out on the trip timber (*B*).

The double dump will handle two cars of 40-foot logs, or one car of long logs by spotting one truck on each track. Three men can unload a car in two and one-half minutes and can unload 350,000 board feet or more daily.

One efficient unloader has a hoisting engine and two drums mounted on a car equipped with a rigid boom. The railroad track is built parallel to the rollway and the unloader runs on an additional track on the land side of the dump. The boom is so placed that it projects at right angles over the far edge of the railroad track. The unloader can travel back and forth

¹ The Timberman, August, 1912, p. 68.

² See Figs. 131 and 132.

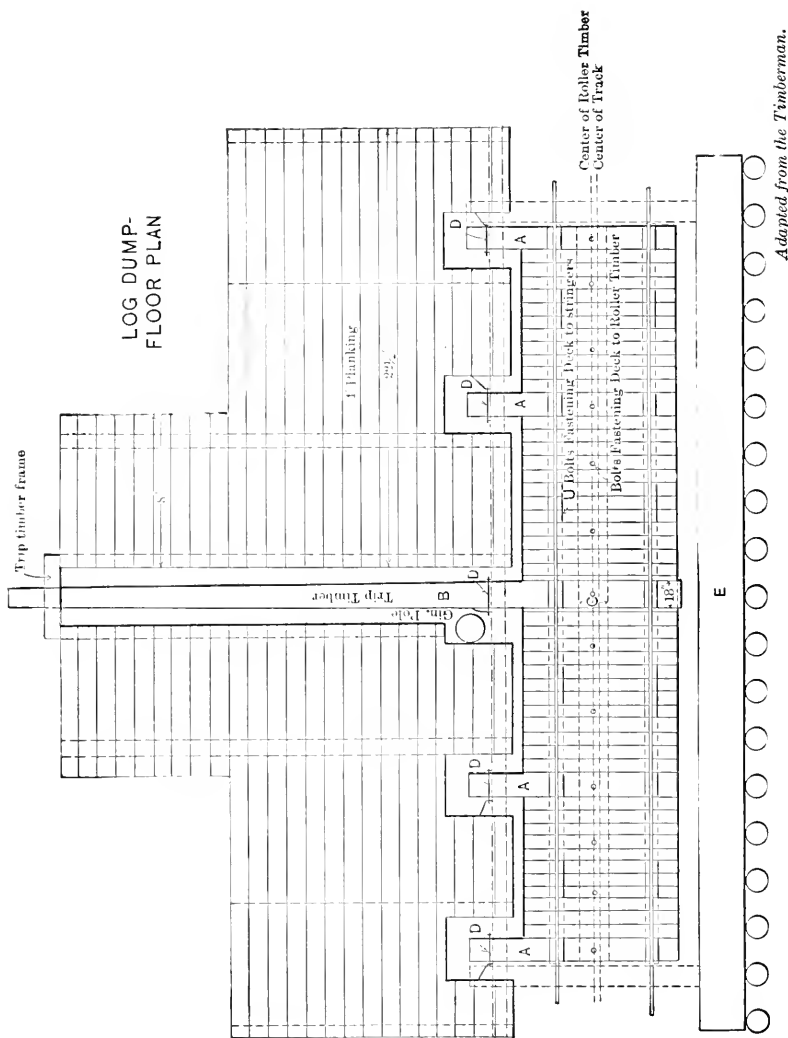

Adapted from the Timberman.

FIG. 131. — Floor Plan of a Tilting Log Dump.

under its own power for a distance of from 500 to 600 feet, thus permitting an entire train to be unloaded without moving the cars. A $\frac{3}{4}$ -inch cable passes from the drums on the hoisting engine through a block on the peak of the boom, down under the logs and the grab hook is caught on the bunk of the car or on the buffer log of the rollway. When the cable is wound on the drum the logs are crowded off the car upon the rollway. Two other drums and cables are used, one for raising and lowering the boom and the other for moving the unloader back and forth on the track. When logs are dumped at one spot, a gin-pole and crosshaul may be used which is operated on the same principle as the unloader just described.

Another form, called a gill-poke, designed to unload heavy logs from cars while the train is in motion has two steel arms 17 feet long made of channel and angle iron. The arms are 18 inches wide except at the ends, where they are made 36 inches wide to give a broad surface in contact with the logs. A heavy casting carrying a sharp edge is attached to the outer end of each arm. The two arms are bolted opposite each other on a 24-inch journal, and are braced with a turnbuckle. The arms and journal are set on a shaft 11 feet long, and 10 inches in diameter, cut down to 8 inches where the journal is fastened to admit the attachment of a collar with ball bearings. The shaft is set on a concrete base, high enough to allow the arms to clear the car bunks, and far enough distant so that when the arm extends across the track at right angles, it reaches 1 foot beyond the outer rail. To unload a train load of logs, the loaded cars are pushed up to the rear of the unloader, a loader arm is swung up against the log, and the train put in motion. The sharp edge of the arm grips the log and as the train advances the arm is turned on its axis and the log or logs are gradually shoved off the car. The momentum acquired in performing the work causes the arms to revolve rapidly on the axis as soon as the logs are dumped, and the opposite arm comes in contact with the logs on the succeeding car. It is seldom necessary to stop the train during the unloading process. The average time consumed in unloading 75,000 board feet of logs from 15 cars is eight minutes.

A more simple form of gill-poke has a heavy timber placed parallel to the land side of the railroad track and elevated about 5 feet above the track level. At suitable intervals this timber

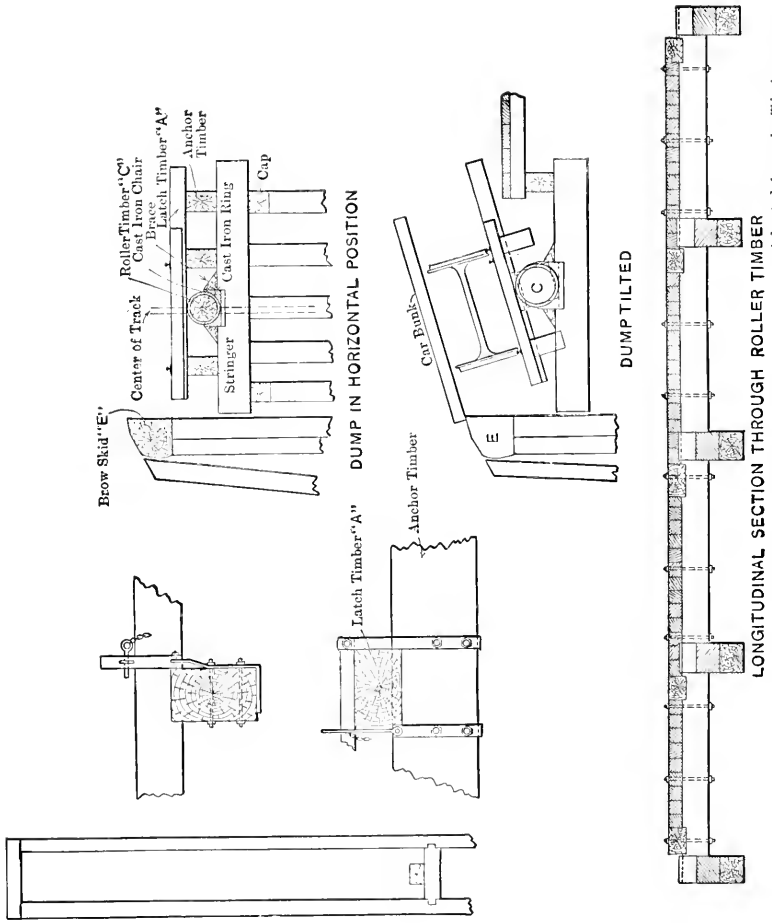

Adapted from the Timbermak.

Fig. 132. — Details of a Tilting Log Dump.

has notches cut in its side facing the track. The gill-poke arm is about 4 inches square and from 6 to 8 feet long and has a blunt collar on one end and a steel prong on the other. The outer rail of the track is elevated and as the cars are slowly pushed by the dumping point, the collar on the arm is inserted in one of the notches in the timber pointing towards the direction of approach, and the sharp end placed against the outside log on the car. As the train proceeds the arm tends to assume a position at right angles to the track and forces the logs from the car. Thirty-two cars carrying 150,000 board feet of logs have been unloaded by this method in twenty minutes.

A device used by a redwood operator in California for unloading logs from cars has a 20- by 28-inch timber, placed across the track at an angle of 45 degrees, and securely fixed at each end on solid supports. The base of the beam is about 8 inches above the car bunk. The loaded train, one log on each car, is brought in from the woods and pushed along the track toward the unloader. The logs striking the slanting timber are pushed off the car as the train advances. When half of the train has been unloaded the locomotive is uncoupled from the rear of the train, and attached to the forward cars, and unloading is continued until completed. Thirty thousand board feet of logs can be unloaded by this device in three minutes.

The overhead monorail system has recently been adapted to unloading, assorting and storing hardwood logs. The capacity of this machine when unloading and assorting, only, is about 65,000 board feet per day. When logs are unloaded, assorted and the log requirements of the mill delivered at the foot of the jack ladder, the daily capacity is about 40,000 board feet.¹

BIBLIOGRAPHICAL NOTE TO CHAPTER XXI

ANONYMOUS: Swinging "Gill-poke" Unloader. *The Timberman*, October, 1909, p. 23.

EVENSON, O. J.: An Improved Log-loading System. *The Timberman*, August, 1912, p. 52.

GIBBONS, W. H.: Logging in the Douglas Fir Region. U. S. Dept. of Agriculture, Bul. 711, Washington, 1918, pp. 229 to 238.

¹ See *American Lumberman*, Nov. 12, 1921, p. 44.

- O'GORMAN, J. S.: Unloading Log Cars with a Stationary Rig. The Timberman, August, 1909, p. 48.
- O'HEARNE, James: Tilting Log Dumps. The Timberman, August, 1912, pp. 68-69.
- VAN ORSDEL, John T.: Cableway Loading System. The Timberman, July, 1911, p. 46.

PART IV
WATER TRANSPORT

CHAPTER XXII

FLOATING AND RAFTING

Nearly every large stream in the forest regions of the United States has at some time in its history served as a highway down which logs and lumber have been floated to sawmills and market. It is still the more common method of transporting logs in the eastern part of the United States, although the use of logging railroads is increasing and, in many regions, they have superseded water transportation, because of the depletion of the timber supply near driveable streams, the extensive logging of non-buoyant species, and the increased value of stumpage.

In the more recently developed timber sections of the Inland Empire and the Pacific Coast water transport early gained a foothold but is now of secondary importance, except where logs are brought to the shores of Puget Sound, and the Pacific Ocean or to the Columbia River, and then rafted and towed to the mill. In the Northwest only large streams are practicable for driving because of the diameter of the logs and the long lengths in which it is desirable to bring them from the forest.

Logs may either be floated singly or rafted. The former method is practiced always on rough water and small streams, and whenever lawful on large ones; however, rafting is compulsory on navigable streams.

Water transport is a cheap method of moving logs for long distances when a low expenditure is necessary for stream improvements and driving, and also for transporting logs out of a well-watered region where otherwise a large mileage of expensive logging railroad would have to be constructed to tap a trunk line.

Water transport has the following disadvantages:

(1) It is limited chiefly to logs which will float. Softwoods and hardwoods are often associated together in the forest and present market conditions make it profitable to remove some or all of the latter, which is often impossible with water transport.

(2) It is dependent on an abundant rainfall to flood the streams. During seasons of drought it may be impossible or very expensive to move logs by water. This results in a short log supply and the closing down or short-time operation of sawmill plants. Sawmills in the northern regions that are dependent on water transportation for a log supply can only run for six or seven months, unless special provisions are made for keeping the log pond open during freezing weather. During the remainder of the year the plant is idle and during this period the owner does not realize on his investment.

(3) There is a heavy loss in driving logs for long distances. Logs of all species that have much sapwood suffer a heavy loss in merchantable volume between the bank and the mill, if they do not reach their destination during the season in which they were logged, because the sapwood is attacked by insects and fungi. Basswood logs which have floated for a short period in water containing vegetable matter acquire a peculiar and unpleasant odor that renders the lumber from them unfit for sugar barrel cooperage and packages for other commodities that are easily tainted.

A very appreciable loss in driving timber is due to sunken and stranded logs. The extent of this loss is dependent on the species driven, and the character of the stream.

The heartwood of stranded logs, especially of hardwoods, suffers from checks and splits when exposed to the weather.

Where timber is brought down rough streams, over waterfalls, and past obstructions it is often badly battered and broken, gravel and sand become imbedded in a large per cent of the logs and occasionally iron and spikes are present, especially where iron dogs are used in rafting. Much of this foreign matter is not readily detected, and mills suffer a monetary loss due to damaged saws and time lost by the sawmill crew.

Strict laws are now in force in most states providing adequate penalties for the theft of logs so that this evil has been largely remedied.

The actual loss in log scale from all causes on the Mississippi river drives average about 10 per cent; on the Cumberland and Tennessee rivers in Kentucky, 10 per cent; in Montana, 10 per cent; spruce, from 5 to 10 per cent and birch, from 25 to 75 per cent on short drives in the Northeast; hardwoods in Pennsyl-

vania, from 25 to 40 per cent; and yellow pine, from 20 to 33 per cent. The loss in the Lake States may be as high as 30 per cent.¹ On short drives of coniferous timber the loss is small and may be from zero to 3 per cent. This loss is due chiefly to sunken and stranded logs and not to the deterioration of sap-wood.²

Floods and storms have caused heavy losses to lumbermen who operate on the large streams.³ Booms break and loose logs are carried past the mills and deposited on the banks at points below, or carried out to sea. Where logs are deposited on lands adjacent to the streams heavy expense is incurred, not only in getting the logs back in the stream but in the payment of damages to owners on whose property the logs are deposited. It seldom is profitable to return logs upstream to the mill and they are often sold at a sacrifice to mills below.

Some States have passed laws regulating the fee that parties may charge for catching stray logs that are afloat, and the conditions under which log catchers may operate.⁴

¹ In the case of *James L. Gates vs. Elliott C. Young*, lumber inspector of District No. 2, Wisconsin, tried in the courts of LaCrosse, Wisconsin, 1901, an attempt was made by plaintiff to compel defendant to reimburse him for difference in scale between the "bank" and the boom. During the trial, prominent lumbermen from the Black River district testified that "there might and would occur a difference between the woods and mouth scale of from 10 to 30 per cent."

² A study of log loss in driving in Eastern Canada showed that out of a total of 101,000 logs, 2.21 per cent sank. Eastern spruce represented 5.1 per cent of the sunken logs, and balsam fir, 94.4 per cent. One hundred and eighty-one balsam logs and forty-one spruce logs, 9.92 of the total contained rot.

³ Notable instances are the floods on the Susquehanna River in Pennsylvania, which caused great loss to operators at Williamsport. In 1860, 50,000,000 feet of logs were carried away, followed in 1861 with a loss nearly as great. In 1889, 300,000,000 feet were carried down the river but a considerable quantity of logs were salvaged. Another flood occurred in 1894, when 150,000,000 feet were strewn along the river from Williamsport to Chesapeake Bay. Although many logs from these floods were recovered the loss to the owners was nevertheless very great.

Floods on the Penobscot River in Maine in December, 1901, carried to sea about 7,000,000 feet of logs, valued at \$100,000.

⁴ The legal fee in Pennsylvania is 50 cents for each thousand feet log scale, held and delivered to the owner.

The legal fee on the Guyandotte River in West Virginia and Kentucky is 25 cents per log.

A stringent State law in Washington forbids anyone catching runaway logs

Runaway logs on the Ohio River have been carried to the Gulf of Mexico. On many other streams draining into the Atlantic and Pacific Oceans logs have been carried to sea and lost. Timber caught on the high seas is the property of the finder. Rafts on the Great Lakes were sometimes broken up during storms and the logs scattered over the beach for many miles. The collection of logs under these conditions was expensive and in some cases the cost was prohibitive.

(4) Stream improvements are of little or no value after the abandonment of logging operations. The improvements made on streams to render them driveable are often costly and of such a nature that they cannot be used for other purposes after logging is completed. Exceptions to this may be noted in the case of the boom sticks used for storage purposes at large sorting centers, which are manufactured into lumber at the conclusion of operations; and of dams on large streams which may be retained for the control of the water supply.

(5) The heavy and long time investment required for mill stocking. With long drives that are now made one or more seasons may elapse before the logs reach the mill. On the Ohio and Mississippi Rivers it is not uncommon for logs to reach their destination the second summer after cutting and in some cases delivery has been delayed from three to five years.¹ This long time investment in stumpage and logging expense is not only a serious drain on the finances of a lumber company but the value of the logs that have been cut for such long periods is greatly depreciated.

(6) The legal complications with riparian owners. The rights of loggers on "floatable" and "navigable" streams are defined by State laws which vary in different states. The driver of logs is liable for damages to property of riparian owners caused by the creation of artificial freshets that overflow the lands,

without permission. This law was found necessary to stop the practice of setting logs adrift from booms at night and then claiming a fee for returning them. Loggers pay 5 cents per tie and 50 cents per log for all runaways that are caught and returned to them.

¹ In 1907 a drive of yellow poplar logs came down the Ohio River from the headwaters of one of the tributaries, where it had been held up for five years because of an insufficient water supply. The loss in merchantable contents of many logs was 75 per cent.

damage the banks, or deposit logs or débris on the property.¹ Navigable streams must be kept open and the rights of all other lawful users of the stream respected.

REQUIREMENTS FOR A DRIVEABLE STREAM

(1) The size of the stream. The stream channel should be wide enough and deep enough to float the largest and longest logs without the formation of jams. High banks are desirable since they confine the water and prevent it from losing its force. When not so confined sufficient water may not be available to float logs for more than a short distance, in which case numerous splash dams have to be built.

The most economical use can be made of a small stream when it is only a little wider than the longest logs and of a sufficient depth to float them clear of all obstructions. If there are such the channel must be capable of improvement at a moderate cost. On large streams logs may be guided around obstructions by the use of booms and other improvements, but in narrow channels this usually is impossible and the stream bed must be improved either by the removal of obstructions, changing the course of the stream or putting in sluices for transporting logs around places where floating by ordinary means is not possible.

(2) The channel must be reasonably straight so that logs will not become jammed at the bends of the stream. This is most important on small streams because of the narrow channel. Oxbows or curves in small streams may be eliminated by making a cut-off or channel connecting the two nearest points, but this is too costly when bends are numerous.

(3) There must be a sufficiently large drainage basin above the part of the stream which is used to ensure an adequate supply of flood water. Coupled with this there must be storage reservoirs for holding water in reserve for flooding the stream. In the North the snow on the watershed may melt and a large part of it run down the streams before the drive begins. Storage basins are necessary to conserve this water.

Lakes form an admirable reservoir and when available are used for this purpose. Surplus water is caught and held in them by placing dams across their mouths and when several

¹ See *Howe vs. Ashland Lumber Co.* Decision of the Supreme Judicial Court of Maine, 85 Atlantic Reporter, 160.

lakes are tributary to one stream driving may proceed long after the spring freshets are over.

Sites for dams should have a narrow channel, high banks, and a solid bottom for their foundation. In order to store the greatest amount of water they should be built at the foot of a lake, at the end of a long stretch of dead water, or at a point where the maximum amount of water can be stored with a minimum of dam height.

Storage reservoirs should be large enough to permit log driving for a minimum of five or six hours daily and the drainage area should furnish enough water to again fill the storage basin before the driving period on the following day.

The required watershed area and the capacity of the storage basins for a given stream are dependent on

(a) The amount of moisture precipitation on the watershed especially during the fall and winter months and also the rapidity with which it is made available in the spring. Drives are generally dependent on flood waters and a rapid run-off is desirable because the storage basins will then be refilled in the minimum time after each splash.

A logger usually relies on his judgment as to whether a watershed is capable of supplying sufficient flood water for driving purposes. He bases his conclusions on flood wood and earth deposits which are visible along the stream banks, on a familiarity with similar streams, and on a general knowledge of rainfall and floods in the vicinity; however, the amount of water available for driving in a given watershed is difficult to determine accurately because specific records from which to draw conclusions are seldom available.

Evaporation may play an important part in influencing the water supply during the summer season by taking moisture both from the soil and from the surface of the storage reservoirs. The water supply for early spring driving is not greatly affected by evaporation, but shallow reservoirs that store water for summer driving have a high rate of evaporation and it is sometimes impossible to collect a head of water.

(b) The quantity of water required in a given time to carry logs down stream between storage reservoirs. On small streams where large quantities of water are not available or where the banks are low and the water leaves the main channel it may

not be possible to drive logs more than a few miles at most before the force of the water is spent. In such cases frequent storage basins are required.

(c) The length of time for which flood water must be available. If artificial freshets are required only for a short time in the spring when the streams are fed from snow water a smaller storage area may be used than when water must be available for several months.

DAMS

Dams for logging purposes are usually built of round timber secured close to the dam site.

It is necessary to construct a dam on solid bottom or bed rock because if this is not done water will work underneath the sills and ultimately cause the structure to go out.

There are three types of timber dams used for logging purposes: (1) the crib or pier dam, (2) the rafter or self-loading dam, (3) the pile dam.

Concrete dams of large size are occasionally used by lumber companies, but they are built by engineers, and loggers are seldom concerned in their construction.

Timber dams on small streams usually have a sluiceway through which logs are run and waste water passed, while on large streams several waste gates are required to take care of surplus water. "Roll dams" which have no gates or sluiceways are also built to raise the stream level. The water and logs pass over the crest of the dam.

The choice of the type of dam to be used depends upon:

(1) The character of the bottoms. When the subsoil is unstable, the dam should be of a type which rests upon solid foundation; otherwise the structure will be undermined and carried away.

(2) The head of water desired. The water pressure against the dam increases with the height of the head of water carried, therefore, the construction must be stronger as the height increases.

Dams are subject chiefly to three forces which cause them to become dislodged and carried away, namely crushing, sliding and overthrow. These are due to the pressure of the water on the upstream face of the structure. The crushing stress is overcome by making the timbers of ample size to resist this pressure,

sliding is prevented by anchoring the structure to bed rock or by placing the mud sills deep enough in the earth to hold them, and overthrow is overcome by increasing the weight of the structure by filling it with rock.

Crib Dams. — The crib dam is a common form and is so-called because the buttresses and wings are built of cribs usually filled with stone to hold them down. It is the preferred type where a large head of water is to be carried and when bed rock or a solid foundation can be reached at a depth of a few feet. Crib dams are made from round timbers hewed on two sides, or from squared timbers. The foundation of a crib dam must be solid, and whenever possible built on bedrock, but if this cannot be done the foundation may rest on piles driven into hard clay or to bedrock. If this is impossible, a row of 3-inch plank or small hewed poles sharpened on one end, is driven across the stream channel just above the upstream mud-sill. These planks and timbers are called toe-spiling.

If there is much water in the stream bed it is diverted to one side by temporary dams made of sand bags or by the construction of sluices made from logs or lumber.

In constructing a dam whose sills are to rest on bedrock, the first work done after the water is diverted is to excavate trenches from 4 to 5 feet wide in which the logs forming the cribwork are to rest. The foundation may be made slightly convex on the upstream side in order that the force of the water will tend to tighten the joints of the dam. Parallel lines of logs called "mud-sills" are placed across the stream from bank to bank, each row being spaced 6 or 8 feet from the adjoining one. The width of the base should be approximately the same as the height of the dam. The mud-sills should be made from large timbers, preferably from 16 to 20 inches in diameter. They should lie flat on the bottom and if possible be fastened to bedrock with $\frac{3}{4}$ -inch drift bolts. A row of cross-skids from 12 to 16 inches in diameter is then laid from 6 to 8 feet apart across the mud-sills in a direction parallel with the stream bed thus forming cribs from 6 by 6 to 8 by 8 feet in size. They extend from the front to the rear row of mud-sills into which they are notched so as to rest firmly. Peeled logs are placed on top of the cross-skids to which they are drift bolted. These lie parallel to the mud-sills. Timbers on the upstream side of the dam are hewed on three faces and fitted to each other so that

a tight face is made or else planks must be spiked to the timbers in order to make the dam tight.

A cribwork is built up until it reaches the level of the stream bed, when it is necessary to provide a "sluiceway" through which logs may pass and also gates through which surplus water may be wasted. Sluiceways are generally from 9 to 15 feet wide and are placed in the center of the natural stream bed. A sufficient number of waste gates is placed on either side to care for the surplus flood water. The sides of the sluiceway and of the waste ways, both of which carry headworks for gates, are made stronger and of larger logs than the rest of the structure and are often reinforced with piers. In building waste gates and sluices the transverse sills are cut off where the opening begins and the cross-skids which form the side walls of the sluice have smooth hewed faces that fit closely together. The cribwork of the dam is then continued to the desired height. When finished, the upstream face of the dam is calked with tow or boarded up with 3-inch plank to make it tight. The cribs are roughly floored with puncheons and filled with rock to weight them down. The cover of boards on the face is sometimes replaced with a bed of gravel although both boards and gravel are frequently used.

Piers are often constructed on each side of the sluiceway above the dam to confine the water, strengthen the dam, and prevent the structure from being undermined.

An apron also extends out from the sluice on the lower side of the dam to carry the water and logs away and to protect the base of the structure.

Where the stream bed is unstable a row of piles is sometimes driven across the dam site near the center of the sluiceway. These are cut off at the stream bed level and prevent the bottom from washing out.

Rafter or Self-loading Dam. — This type is cheaper to build than a crib dam and is used where a large head of water is not required.

Rafter dam foundations are constructed in the same manner as crib dams with pockets 6 by 6, or 8 by 8 feet in size. The mudsills are drift bolted to bedrock when possible. As the framework is built up, the face of the dam is drawn in from the level of the stream bed so that the upstream face has an angle of 3 horizontal

to 1 vertical. The dam should be at least 8 feet wide on top. Two thicknesses of 3-inch plank or hewed poles are spiked on the sloping face, the joints being alternated and the whole covered with a bed of gravel. The rear mud-sill is protected by toe-



Photograph by H. R. McMillan.

FIG. 133. — The Sluiceway and Apron of a Rafter Dam on the Priest River, Idaho.

spiling driven down to hard clay or bedrock, and the cribs are weighted down with stone.

The frame for a rafter dam is frequently supported on round or squared timbers instead of cribwork.

Pile Dam. — The buttresses and wings of this type of dam are formed by a double row of piles driven to bedrock, the space

between them being filled with gravel and stone. The upstream face is banked up with brush and gravel to stop leakage. This type is not in frequent use, although it was at one time common in the Lake States.

SLUICE GATES

Lift Gate. — This is the most common type. It is rectangular in shape, with two outside frame pieces 5 by 7 inches in

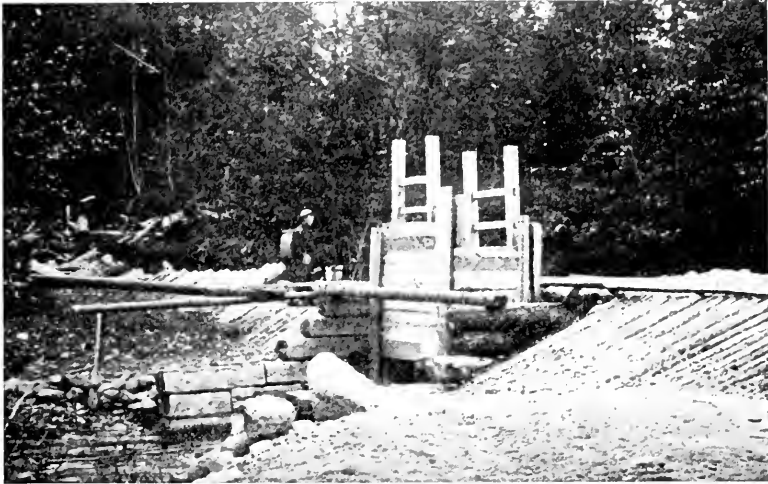

FIG. 134. — The Upstream Face of a Small Rafter Dam, showing a Common Form of Lift-Gate.

cross-section which are made from hardwood. Intermediate “starts” as these pieces are called may be used on wide gates. Mortises 2 by 5 inches in size are cut into the edges of the starts at 14-inch intervals and 2- by 5-inch hardwood slats which are long enough to give the required gate width are fitted into the mortises on opposite starts. The starts and slats form the skeleton frame work of the gate, and also serve as points under which the raising lever may be placed. Two-inch hardwood planks are then spiked crosswise from start to start, the ends of the planks being flush with the edges of the starts. Gates are made 2 inches narrower than the width of the sluice so that they may be moved easily up and down the slides. The slides are placed directly above one of the cross timbers in the sluice, so that there will be

a solid base under the gate which will prevent it from rebounding when it is dropped into position. The slides are made of 5- by 7-inch hardwood strips, 6 feet longer than the crib height. One slide is placed on each side of the sluice way in a notch 16 inches long and 5 inches deep which is cut into the side logs of the sluice. Each slide timber is solidly spiked to the sluice way on the downstream side and provides a backing against which the gate works. The groove in the sluice timbers is widened to 22 inches at the top and a slide similar to those placed in the downstream side is spiked in place in order to keep the gate in position.

Bear-trap Gate. — This type of gate has been used frequently in Pennsylvania. It has two rectangular leaves each of which

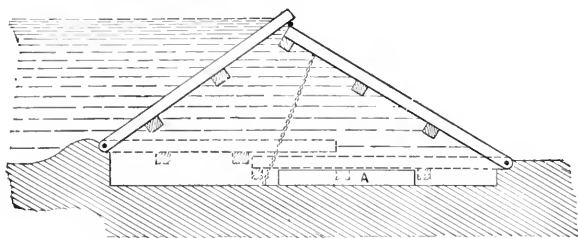

FIG. 135. — The Bear-trap Sluice Gate.

has a length equal to the width of the sluice. They are fastened to the bottom of the sluice by hinges on which they turn. The upstream leaf overlaps the downstream one when the leaves are down and the gate open.

The gate is raised by the pressure of water from the upper pool, which is conveyed in a channel, controlled by a sluice gate, to a chamber (A), Fig. 135, constructed under the gate. A second channel, also provided with a gate or stop cock, connects this chamber with the lower pool. When the connection with the upper pool is opened, while that with the lower pool is closed, water from the upper pool fills the chamber under the gate. This causes the downstream leaf to rise, first by flotation and then by the impulse from the flow of the water. The upper leaf is raised by the lower leaf which slides under it, the friction being reduced by rollers. The height to which the gate rises is limited either by stay chains, or by a wood cleat nailed on the under side of the upper leaf. In lowering the gates the operation is reversed, the connection with the upper pool

being closed while that with the lower pool is opened. The gate may be made to assume any intermediate position by regulating the extent to which the two valves controlling the inlet and outlet of the chamber under the gate are opened.

The objections to this form of gate are: (1) the overlap of the upper leaf over the lower one necessitates lifting a considerable amount of water when the gate is raised; (2) the head of water obtainable is only about one-third of the total width of the leaves; (3) the friction between the two leaves, even when reduced by rollers makes it difficult to operate the gate smoothly; (4) the gate must be made in one section and if the gate is wide one side is apt to go up faster than the other causing twisting strains; (5) any driftwood or stones which may lodge between the leaves make the lowering of the gate impossible until the obstruction is removed. However, water can be let out of the reservoir very rapidly and the gate can be raised and lowered by one man as no special effort is required, both of which are advantages.

Logging dams with "bear-trap" gates 80 feet wide have been built and operated in Wisconsin

Half-moon Gates. — A dam constructed to store water for log sluices often has a gate called the "half-moon." It is not used for wide sluiceways nor for large heads of water. The gate, which is slightly curved, fits tightly into the sluiceway with the convex face upstream. It is supported by four arms from 16 to 24 feet long, which are attached to a beam hung on bearings placed on either side of the top of the sluiceway. A platform erected over the gate supports a drum actuated by a hand wheel with gearing, or by a hand lever. Chains are attached to either side of the gate head and are passed up over the drum. The gate, which swings through an arc of a circle with a radius equal to the length of the supporting braces, is raised by winding in the chain.

Needle or Bracket Gate. — Splash dams, especially in the Appalachian mountain and Pennsylvania regions, are often provided with needle gates which are made of hewed or sawed 3- by 5-inch, or 3- by 6-inch scantlings placed vertically across the opening, thus forming a solid front. The needles are supported at the lower ends by a cross-beam or groove cut in the base sill. The tops rest against a cross-beam to which the needles are attached by short chains. The needles are raised either by a windlass,

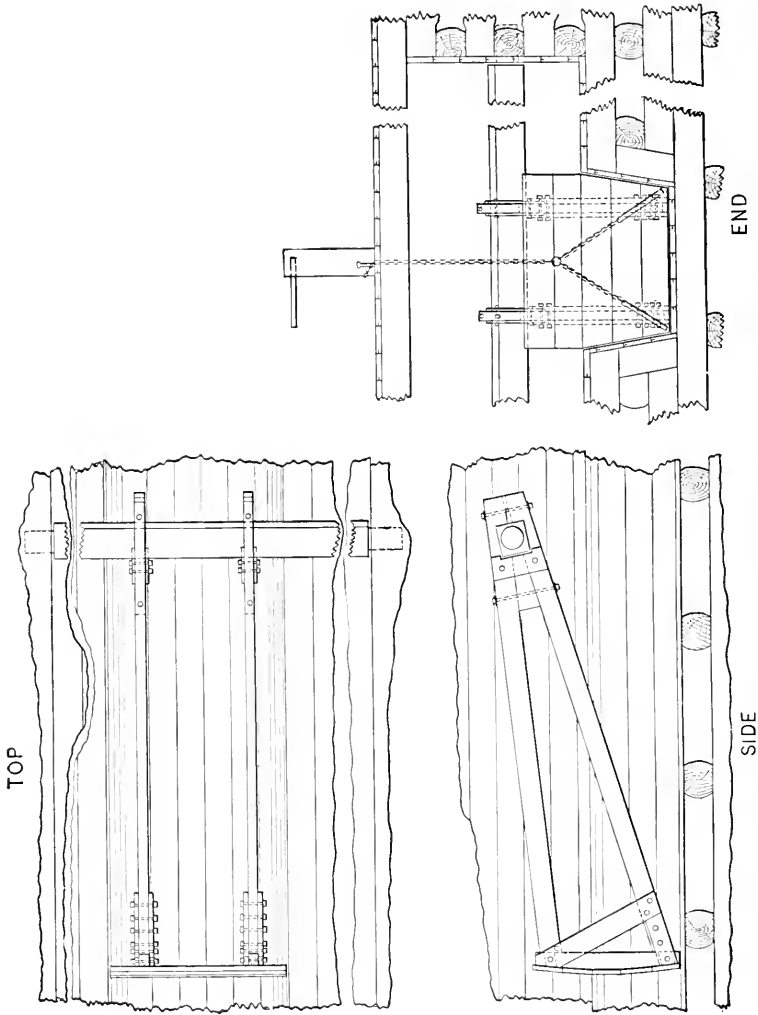

FIG. 136. — A Half-moon Gate used in a Low Sluiceway. Wisconsin.

a crowbar or a lever. They are especially serviceable for dams at storage reservoirs through which logs are not sluiced, but where it is necessary to suddenly release large quantities of water in order to carry logs over very rough stretches. The needles may be liberated by breaking the bottom beam by a charge of dynamite.

Barn-door Gate. — This has one or two heavy gates or doors hung vertically on bearings attached to the sides of the sluice.

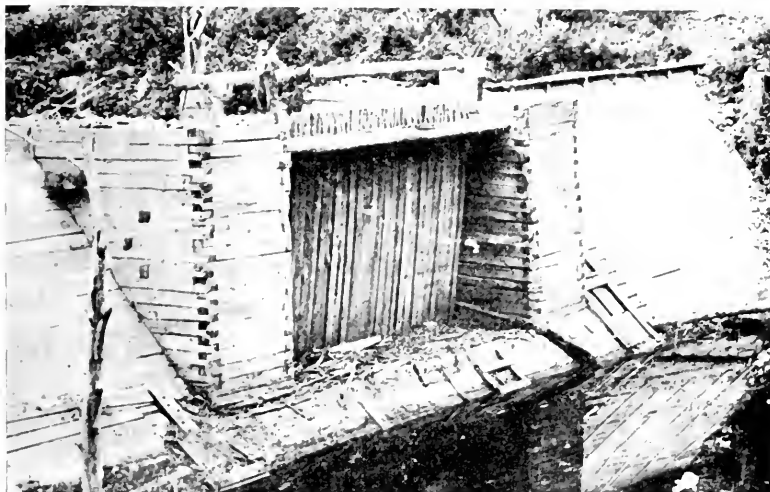

FIG. 137. — An Upstream View of a Rafter Dam having a Needle Gate. Appalachian Mountains.

Double gates are held in place, when closed, by an upright beam in the center of the sluiceway, and single gates by a similar beam placed on one side of the sluiceway. A horizontal pole is sometimes used instead of an upright one to hold the gate shut. These gates have been used in Pennsylvania and in some parts of the Appalachian mountains, but they are not popular because the force of the water throws them open so violently that they are often damaged. A light drop gate often is built to shut off the flow of water while the large gates are being closed.

LOG CARRIERS

Loggers operating near the headwaters of streams occasionally find it desirable to transfer logs from one water course to another in order to bring them down the stream on which the manufacturing plant is located.

A log carrier similar to the log haul-up in a sawmill is used to elevate the logs to the maximum height desired, and a log sluice with a V-box 4 or 5 feet high and 7 or 8 feet across the top then carries the logs to the stream on the other watershed. Water for the sluiceway is furnished by a series of pumps of large capacity.

An interesting example of a device of this sort was a log carrier and sluice constructed in the Nipissing District, Ontario, Canada, to divert logs from the headwaters of the Muskoka River to those of the Trent River. The logs were first transported up a log carrier 300 feet long to a reservoir 80 feet long, 7 feet wide and 8 feet deep, located 40 feet above the initial level. A 450-horse-power engine furnished power for the jack works at the reservoir, and also for a set of centrifugal pumps with a capacity of 20,000 gallons per minute which provided water for the reservoir, and for a log sluice which was 3000 feet long and had a 4.5 per cent grade. The logs as they reached the foot of the sluice were transported by a log carrier up a 100-foot rise to a lake $\frac{5}{8}$ -mile distant, where they were placed in a boom and towed to the head of the river down which they were driven. The second carrier comprised eight sections, each with a massive jack works driven by rope transmission from a 400-horse-power horizontal water wheel located near the center of the haul-up. Water for power purposes was brought in a flume from the terminus of the carrier. The conveyor chains were made with 1-inch round links and had log seats at intervals of 8 feet. The capacity of the carrier was 10,000 logs in twenty-two hours.

IMPROVEMENT OF THE STREAM BED AND BANKS

Before a stream can be driven it must be cleared of fallen timber, snags and boulders. The fallen timber often is cut into short lengths with an ax and allowed to drift downstream, or is hauled out on the banks. Snags, rocks and similar obstructions are removed with dynamite. This work is done in the summer and early fall when the water is low.

Pier Dams and Abutments

Pier dams are cribwork structures used to narrow the channel of a stream, guide logs past rocks and other obstructions, and in some cases to block an old channel and divert the water into another course.

They resemble the piers of crib dams having cribs from 6 to 8 feet square, and mud-sills fastened to bedrock or firmly anchored in the stream bed. The cribs are loaded with rock to give them stability.

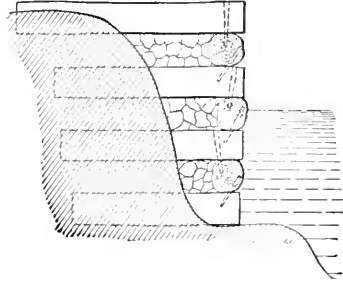

FIG. 138. — An Abutment for the Protection of Stream Banks.

Abutments are used to protect the banks of streams during flood time, and prevent them from being worn away. The usual form is a cribwork of timber built into the bank. The space between the shore and the timbers is filled with rock to prevent the bank earth from washing out. Where streams pass through wide bottoms and the banks are too low to confine the flood water, an artificial

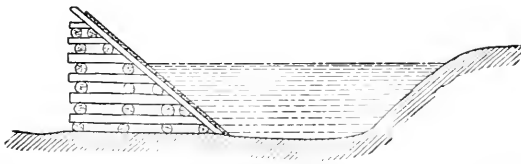

FIG. 139. — An Artificial Channel used to confine Flood Water in a Narrow Bed.

channel is sometimes created by constructing false banks of lumber. Cribwork supports a strong frame of timbers on which heavy planking is nailed.

Booms. — Backwaters, pockets, low banks, obstructions and shallow places where logs are apt to be lost or stranded occur on most streams. Booms, made of long sticks of timber fastened together end to end and moored to objects on shore or to piling or cribs in the stream, are used to confine the logs to the channel. Booms are also used to aid drivers in sluicing logs through dams, for confining logs at assorting gaps and storage

points, and for towing. They are built in many forms and are called sheer booms when used to confine logs for storage purposes in given channels and towing booms when used to impound logs for towing purposes. They are again designated as limber and stiff booms according to their manner of construction. Both sheer booms and towing booms are often of the same pattern and are known as the "plug" boom, "sheep-shank" boom, "chain" boom, "bracket" boom, "fin" boom, and "barge" boom. The first three are single-log limber booms, the names referring to the manner of attachment one to the other; the bracket boom is

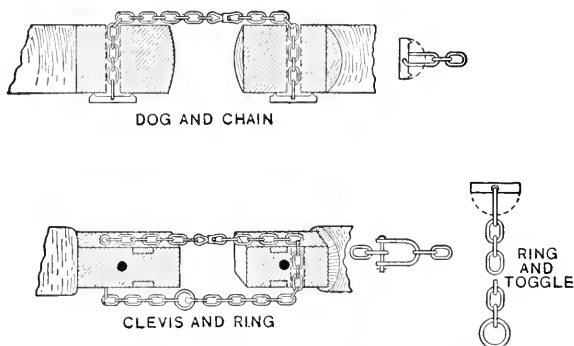

FIG. 140. — The Methods of fastening Boom Sticks with Chains.

a stiff boom several logs wide; and the fin and barge booms are either stiff or limber.

Plug booms, also known as "plug and knock down" booms, have logs fastened end to end with short pieces of rope or withes the ends of which are passed through holes bored in the ends of the boom and securely fastened by plugs.

Booms of this character are serviceable as a makeshift when stronger fastenings are not available.

Sheep-shank booms are temporary booms fastened together by rope, a half hitch being made around the ends of the logs. They are used for repairing breaks in other booms where rope is the only equipment available.

Chain booms are the common form of limber boom in use today. Short chains are used to connect the logs, and are fastened in several different ways: (1) by a chain and dogs; (2) by a ring and toggle; (3) by a clevis, making an endless chain. The latter

form is used very commonly for towing purposes and for storage areas because the booms can be readily uncoupled.

The bracket boom is a stiff boom made three or four logs wide. The logs are fastened together by short boards nailed cross-wise on the boom, or by short poles fastened to the logs by means of wooden plugs, chains or withes. They also are bound together with chains which encircle the boom. They are stronger than single booms and are used on the upstream side of splash dams

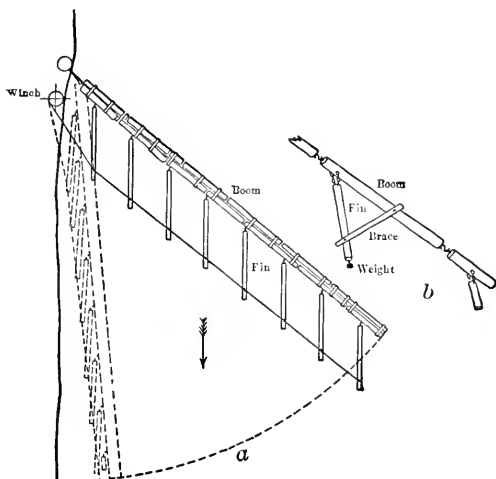

FIG. 141. — A Fin Boom. *a*. A movable fin boom both open and closed. *b*. The arrangement of boom and fins for a permanent fin boom.

for converging logs toward the sluiceway, and are also used around storage areas and assorting gaps as runways for men.

The fin boom is often employed to change the course of logs from one side of a stream to the other, or to guide them past obstructions. It is especially serviceable on a navigable stream where permanent booms cannot be maintained, and in places where it is not feasible to moor the outer end of the boom to a crib or pile. The shore end must always be upstream. The fin boom may be either limber or stiff, preferably the latter, and may be permanent or temporary. It has a main boom to which the ends of pole or plank fins are attached by chains at regular intervals. When the boom must be opened and closed at frequent intervals the outer ends of the fins, which act as rudders,

are connected by a rope or cable which passes around a drum or power-winch located on shore, while on stationary booms the fins are weighted at the ends to give them rigidity, and are fixed in a permanent position by means of a brace extending from the fin to the main boom.

The boom may be thrown across a stream at any angle less than 90 degrees by winding in or letting out the cable, thus increasing or decreasing the angle between the boom and rudders. The boom may be brought to shore by letting out cable.

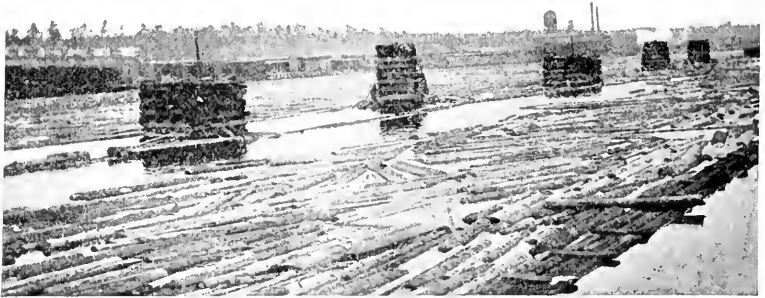

FIG. 142. — Piers placed in a River to hold Storage Booms. Minnesota.

A barge boom is a limber boom, three or four logs wide, the upper end of which is fastened to a barge anchored in midstream and the downstream end to a tree or stump on shore. A boom of this character is serviceable in a navigable stream where permanent booms cannot be used, and where the stream bed cannot be obstructed with piling or cribs. It is often used in connection with a fin boom when it is desired to shunt logs to one side of a wide stream.

STORAGE AND SORTING FACILITIES

On all large streams on which logs are transported, the timber of various companies becomes intermingled and it is necessary to sort out the property of each owner at destination. For this purpose assorting works are maintained at points where

logs are to be manufactured, and extensive log storage facilities also are often provided. Both the assorting and storage works are generally owned by corporations.

The storage booms form large pockets extending sometimes for miles along one or both sides of the stream, into which logs are shunted until the assorters are ready for them, and also to hold assorted logs until wanted for manufacture. The outer boundaries of these pockets are formed by single booms made



Photograph by R. B. Miller.

FIG. 143. — Log Storing and Assorting Works on the St. John's River. New Brunswick.

from logs 2 or 3 feet in diameter fastened together with 1- or 1 $\frac{1}{4}$ -inch chains. The boom sticks are held in place in midstream by piers or nests of piling placed 75 or 100 feet apart.

Piers are built of round logs from 16 to 24 inches in diameter and of various sizes depending on the character of stream in which they are placed and the amount of strain they must withstand.

In cold regions, they are built when the stream has an ice covering strong enough to bear up heavy loads. An opening is cut through the ice slightly larger than the base of the crib, and in this opening the crib is built. The foundation timbers are placed in position and a floor of poles or planks placed over them. As the crib framework is built up, the structure is loaded with stones, thus sinking it as the work proceeds. Cribs are some-

times built on the ice and when nearing completion, a hole is cut large enough to permit the framework to be sunk. This method is not always as satisfactory as the first one described because ice may remain under the bottom of the crib and later cause it to settle unevenly. When the bottom is uneven, the crib must have some open pockets on the outer edge so that when it touches bottom enough rock ballast may be dropped down on the low side to make a level base. This may be done by setting spars at the corners of the crib and raising the low corners to a level by means of blocks and tackle. When cribs must be built in open water, they are constructed on inclined ways at some convenient point along the shore, and when they have reached a height sufficient to form a substantial raft, they are launched and then built up to a height slightly greater than the depth of water in which they are to be placed. They are then floated to the permanent site, loaded with stone and sunk to the stream bed.

When the crib is to rest on a soft mud bottom, the load must be distributed over an area greater than the crib base. Stones are thrown on the bottom and when a sufficient quantity are in place the bed is roughly leveled and the crib sunk in position on top of it.

The logs from which the crib framework is made should be notched where they cross each other and firmly drift bolted together. The outward thrust of the rock ballast may be overcome by nailing round poles in the angle where poles cross or by quartering logs and nailing these pieces in the angle.

In some cases the cribs are built rectangular in form above the water, but usually the upstream face is drawn in at an angle of from 30 to 40 degrees and planked over. The sloping face prevents ice and driftwood from forming a jam behind the crib and causing it to be carried away. A common method of attaching the boom sticks to the cribs is to drive a pile in the center of the crib. After a large iron ring has been loosely fitted over this pile the boom is fastened by a chain to the ring, and as the water rises and falls the ring slips up and down with the chain. When piling is used instead of cribs a nest of three or four piles are driven together and bound with chains or cable.

Storage booms are usually taken in and the chains repaired after the drive is over. They are replaced early in the spring as soon as the ice leaves the stream.

The capacity of storage booms varies with the size and length of timber handled. The following table¹ shows the area in acres required to store spruce logs of several sizes and lengths, and also the number of boom logs required to impound given

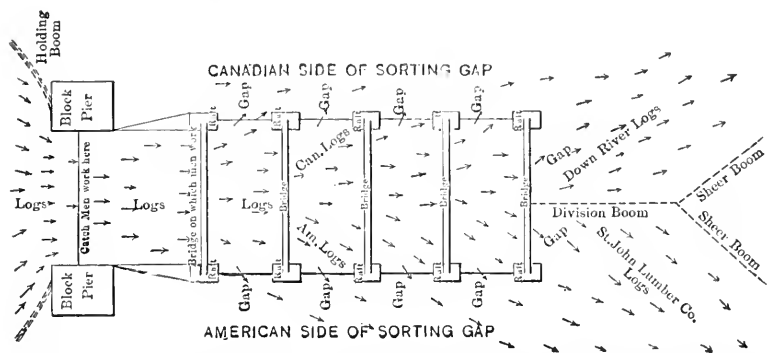

FIG. 144. — A Sorting Gap on the St. John's River near Fredericton. New Brunswick.

quantities of timber when the logs are forced into a compact body by the current of the stream, all sticks floating on the surface.

The average storage capacity of medium-sized white pine and yellow pine logs is approximately 250,000 board feet per acre.

Average length	Average diameter	Average scale per piece ²	Area for storage of 1,000,000 feet
Feet	Inches	Board feet	Acres
15.3	5.9	21.4	13.41
20.5	6.7	31.8	11.94
24.6	10.4	90.7	8.15
30.0	15.6	249.48	5.34

² Blodgett rule.

Assorting Equipment. — The main feature is the assorting gap where logs are separated and deflected into the storage pockets down stream. The usual type of assorting gap has two opposite rafts or bracket booms placed from 30 to 50 feet apart and connected by an elevated runway on which the assorters stand

¹ See Boom Areas, by A. M. Carter, Forestry Quarterly, Vol. X, No. 1, p. 15.

and separate the logs by marks as they pass under them. The gaps are built in many forms depending upon the amount of work to be done and the physical conditions which are encountered. Fig. 144 shows an assorting gap on the St. John's River near Fredericton, New Brunswick. This has two block piers 50 feet apart and behind them are rafts built of five logs each, so arranged that five gaps, each 22 feet wide, are formed on each side. The space between opposite rafts is spanned by 4-foot plank bridges on which the sorters stand. The division boom shown extends

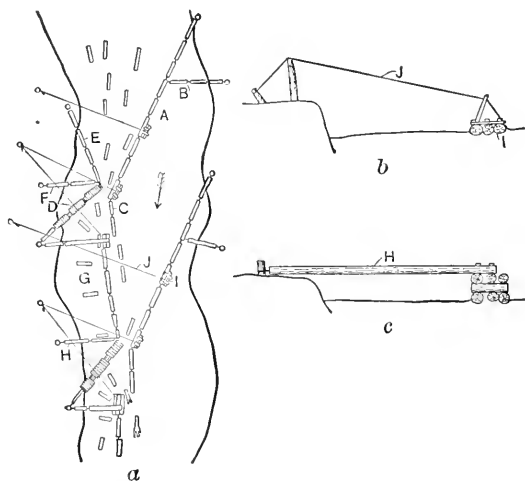

FIG. 145. — A Patent Assorting Works used in the Appalachian Region.

downstream for 2000 feet to sheer booms which deflect the logs to the American and Canadian sides. Seventy-five men are employed at this gap and during the season 150,000,000 board feet of logs are handled.

An assorting device used in the Appalachian region is shown in Fig. 145*a*. This has a sheer boom (*A*) moored to a tree on the bank and braced by a secondary boom at (*B*). The boom (*A*) is held in place in the stream by cables attached as shown in Fig. 145*b*. The lower end of the boom is broken at (*C*) and may be opened to allow logs and driftwood to pass downstream. An assorting platform (*D*), with braces (*E*) and (*F*), is provided on which the workers stand and shunt the logs to be stored into the pocket (*G*). The remainder pass downstream to other storage pockets

or to points below. The boom (*H*) is elevated by means of a built-up raft (Fig. 145c) to allow logs to pass underneath into the storage pocket.

Rafting Works. — These may be located below assorting gaps, at the head of still water on non-navigable streams, or at the terminus of a logging railroad, or other form of transport along the shore of a lake or at tidewater. The form of the rafting works is governed by the character of the stream or body of water and by the form of raft constructed. On rivers where rafts are limited in width because of the size of the channel, they are made long and narrow and the rafting works, if logs of numerous owners are handled, may have many pockets whose boundaries are marked by bracket booms with plank runways which are held in position by piling.

On the Great Lakes where logs are towed loose in booms, storage areas off-shore are provided in which logs are held until a sufficient number have accumulated. These areas are bounded by heavy sheer booms held in place by piling. The rafts are made up by surrounding a group of logs with heavy towing booms and towing them out of the storage areas.

Along some of the tidewaters of the Atlantic seaboard logs are made into bundles and towed to the mills. The rafting works here have an unloading wharf which projects into the stream, and special devices for holding chains and cables while the logs are being bundled.¹

On the tidewater of Puget Sound, where large numbers of logs are rafted to the mills, a rafting works has an unloading dock several hundred feet long. This projects into the storage area which is enclosed by sheer booms held in place by piles driven about 70 feet apart. A rafting pocket 75 feet wide and 800 feet long is enclosed in booms and in this the rafts are built in sections.

Ocean-going rafts are built on or near tidewater in the Northwest. The usual storage area is provided and in addition, cradles or similar structures in which the rafts are built.²

THE DRIVE

The season in which logs are transported by water varies in different regions. In the Northeast and the Lake States loggers depend primarily on the spring flood waters which are caused by

¹ See page 425.

² See page 427.

the melting snow and hence the drive must begin as soon as the ice goes out of the streams, since the water supply gradually decreases as the season advances, and on the smaller streams may be insufficient by early summer.

In the Appalachian mountains and in the South where the snowfall is limited or absent, reliance is placed on freshets or heavy rainfalls for water to float the logs and the drive is conducted whenever water is available. On large bodies of water like the Great Lakes, Puget Sound and the Pacific Ocean the governing factor is the storm period, consequently the summer months are preferred.

Conduct of Drives. — The business conduct of drives on streams may be under the control of one man, a group of individuals, or a corporation, depending upon the ownership of the timber. Rafting is carried on both by individuals and corporations.

Drives upon large rivers often originate on numerous small streams, from each one of which come the logs of an individual or a company. Under these circumstances the small stream improvements are made and the drive upon it is conducted by one firm. On reaching the larger stream the logs of all parties become intermingled and the drive is then conducted as a "union" or corporation drive.

On union drives the expense of improvements and labor hire is apportioned among the companies and individuals according to the amount of timber each has in the stream. The direct control of the drive is vested usually in the interested members, in rotation, and each one has an employec at the assorting gap when the logs are assorted.

A more common method is the control of the main drive by boom companies chartered by the State in which the business is conducted. The stream, if long, may be divided into several sections, each in charge of a separate corporation. The membership of such corporations is usually confined to loggers who use the river for log transportation; however, it often does not include some of the smaller operators. Many of the boom companies operating in the Lake States, especially on the Mississippi River and its tributaries, have a limited capital stock divided among a few shareholders.

Another form of membership is represented by companies, such as the St. John's River Log Driving Company, operating

in the vicinity of Fredericton, New Brunswick.¹ Each logger having 100,000 board feet or more passing through the limits of the company is eligible to membership, on filing with the Secretary a statement of all logs placed in the stream and their point of origin, a list of all log marks used, and certain other required facts. On filing this report the applicant becomes a member and is entitled to one vote for each 100,000 feet of logs he has in the drive. Thus every logger of any consequence has a voice in the administration of the drive.

All states having large streams which are used for the transport of logs have laws relating to the rights and privileges of loggers and setting forth the duties and liabilities of incorporated boom companies. The charters of boom companies usually regulate the prices to be charged for handling and rafting logs. The State laws of Minnesota provide for inspection and scale of logs in the booms by a surveyor-general and his deputies, for which the boom company is charged a fee for all logs scaled. The surveyor-general is empowered to seize and sell logs in case of non-payment of the fee.

On some tributaries of the Ohio River, especially on the Big Sandy down which great quantities of logs have been floated, the practice is for the individuals to drive their logs loose from the headwaters of the small streams to private rafting works located on the lower course of the Big Sandy where the logs are made into rafts by contract, floated to the mouth of the river and there taken in charge by the owner and towed down the Ohio River to the mills.

On the Pacific Coast the logs are brought to tidewater by logging railroads and made into rafts, usually at private rafting works.

A. LOG MARKS AND BRANDS

Some method of identifying the logs of different owners when they are assorted at destination is imperative and lumbermen have adopted the system of branding their logs at the skidways in the forest or at the landing on the stream. The brands are numerals or characters, mounted on the head of a sledge hammer and stamped at several places on both ends of the logs so

¹ St. John's River Log Driving Operations by G. Scott Grimmer, *Canada Lumberman and Woodworker*, Vol. XXXII, No. 11, June, 1912, p. 28.

that no matter what portion of the log is above water the brand can be readily seen.

To further aid in log identification the use of a bark mark, which is a design cut on the log near one end, is obligatory in some states. This may be made either by the sawyers when they cut the trees or at the landing. A bark mark is often used in connection with a "catch mark" painted on the ends of the log. In such cases a brand is not used. The number of brands and marks used on a given stream is sometimes great, each logger often having several to distinguish logs coming from given streams

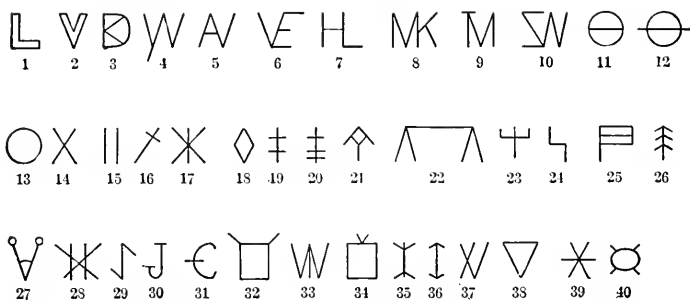

FIG. 146. — Some Mississippi River Log Marks. 1-10, monograms; 11, blaze notch; 12, notch girdle; 13, scalp; 14, cross; 15, notch; 16, dagger; 17, cross girdle; 18, diamond; 19, twenty; 20, thirty; 21, umbrella; 22, saw horse; 23, fork; 24, straight S; 25, flag; 26, pine tree; 27, inverted A with scalps; 28, fifty; 29, pot hook; 30, fish hook; 31, bar C; 32, box with ears; 33, wild goose; 34, sheep head; 35, crow foot; 36, double dagger; 37, fifteen; 38, triangle; 39, star girdle; 40, turtle.

or sections of land. Some loggers use a new set each season in order to keep the logs of different years separate. On the upper Mississippi river more than 2000 log marks have been registered with the Surveyor-general, and over 1600 have been in use during a single season.

The marks and brands represent a great variety of figures comprising single letters, monograms of two or three letters, and many figures which are often given characteristic names by river drivers.

Log brands have always been extensively used in the Adirondack region, while in Maine bark marks are common. Both forms are used on the Mississippi river and its tributaries, and

also in many parts of the Appalachian region. Brands are in extensive use on the Pacific Coast where logs are transported by water, but are seldom used in the interior.

When registered¹ with some designated state or county official (the Surveyor-general in Minnesota, in most other states the County Clerk of the county in which the head office is located) brands constitute trademarks of the individuals or firms registering them, and their rights to the timber so marked are fully protected by law.

The obliteration or removal of brands or bark marks ("de-horning") is regarded as a felony in most states. The highest courts of some states² have held where logs are presumptively marked according to law and are floated down a stream and the owners annually endeavored to recover those that sank and became imbedded in the stream, that such logs cannot be regarded as lost or abandoned property whether the marks are distinguishable or not.

Loggers, therefore, do not lose their property rights in lost logs if originally they were properly marked by the owner, and he used due diligence each year to recover them. On the other hand, according to the Supreme Court of Minnesota,³ logs in water are abandoned when not in the possession of or under the control of any person, and which have no distinctive mark or marks on them that have been recorded with the proper officials. Such logs are the property of the person who collects them and causes them to be marked. These logs are known as "prize" logs and on union drives they are divided in rotation, as they pass the assorting gap, among the loggers having timber in the stream. When the drive is conducted by a boom company all prize logs

¹ "Failure of owner to comply with Compiled Laws, section 5083, providing for the recording of log marks, was only effective to deprive the owner of the statutory presumption of ownership of logs unmarked with the recorded mark, and did not deprive him of his property in logs, the title to which he might establish by other means, including an unrecorded mark used by him." *Whitman vs. Muskegon Log Lifting and Operating Co.* Supreme Court of Michigan, 116 Northwestern 614.

² See *Whitman vs. Muskegon Log Lifting and Operating Co.* Supreme Court of Michigan, 116 Northwestern 614.

³ See *Astell vs. McCuish*, Supreme Court of Minnesota, 124 Northwestern Reporter, 458.

caught in the booms are held as the property of the company and are sold at auction to the highest bidder.

B. SPECIES THAT FLOAT

The majority of the coniferous species indigenous to the United States will float, although there is a heavy loss in driving woods such as southern yellow pine, green hemlock, and the butts of larch and redwood. The buoyancy of hemlock is increased by peeling the timber and allowing it to season for a short period before placing it in the water.

Hardwood logs, such as basswood, poplar, and cucumber, float well and can be driven, although basswood is apt to become discolored, which greatly depreciates its value. Oak, beech, maple, birch, and other heavy hardwoods can only be floated with difficulty unless they are especially prepared or are rafted with lighter species. Some loggers cut and peel oak in July, August, September, and October, place it on skids near the bank, and allow it to dry out from sixty to ninety days. It then becomes light enough to float for short periods.

Another method¹ is to peel and season the logs, then paint the ends with two or three coats of paint and raft with lighter species. Holes also may be bored into logs and plugged up so as to form air spaces and thus increase the buoyancy of the timber.

White birch for spool stock is sometimes driven for short distances in Maine, although the green timber will only float for a short time. One method is to fell the trees during the summer months and leave the tops on them until a large amount of moisture has been removed. Again, the trees may be felled, the tops cut off, and the timber left in the forest to season for from eight to twelve months. This method is less satisfactory than the former because the sapwood of the logs stains badly during summer months, if left for long periods.

The following lists show the relative floating ability of several species.

¹ There is a serious objection to this method of handling hardwoods because their value is reduced by checks and incipient rot. Hardwood cut during the spring or summer must be converted into lumber in a few weeks if the best results are secured.

Floating ability above the average	Average floating ability	Floating ability below the average
Spruce White pine Hemlock (dry) Basswood Poplar White cedar Redwood (except butts) Balsam Larch (except butts) Cypress Cucumber	Yellow pine Sweet gum Sycamore Douglas fir Chestnut	Oak Hickory Birch Beech Elm Ash Cherry Redwood (butts) Larch (butts)

C. LABOR

Labor employed on log drives is chiefly recruited from the logging camps which have ceased operations by the time the streams are in condition to float timber. Although the work is hard, the hours are long and the men are often exposed to many hardships in the pursuit of their work, there is a certain glamour and fascination about it which attracts forest workers and in normal times loggers seldom have difficulty in securing a sufficient number of men.

The laborers in the Northeastern part of the United States are chiefly French Canadians who make admirable river drivers.

Log driving on small streams is done chiefly from the banks, except where log jams occur, while on large streams the work must often be done from boats called bateaux¹ or from the logs themselves. The river drivers are often subject to personal danger in freeing lodged logs and in breaking up jams which form at narrow points in the stream, or in places where the channel is obstructed by rocks. A "key log" around which a jam is formed must be freed before the mass can be started, and this may be done either with tools or by a charge of dynamite. Only the most skillful men are allowed to perform this work, because great presence of mind is required on the part of the driver when the logs start to move. Log drivers, especially on rough water, are among the highest paid men in the

¹ These are strongly built boats with a sharp prow and are fitted with two pairs of oars and guided by a single oar used as a rudder. They have a capacity of from six to ten men.

woods. On small streams log drivers are housed in log camps or in tents, while on river drives the men frequently live in a house boat or a tent called a "wanigan," which is mounted on a scow or raft and floated down the stream as the work proceeds. Tents on shore are also frequently used where facilities can be provided for moving them in wagons or in boats.

D. CONDUCT OF THE DRIVE

The Drive on Small Streams. — Drives usually start on the upper courses of small streams where the logs have been "banked"



FIG. 147. — A Log Driving Crew at the Landing on a Small Stream waiting for a Head of Water. New Hampshire.

in the stream bed, or else scattered over the surface of some lake or pond near its mouth. The "banking ground" is often above a splash dam which furnishes sufficient water to carry the logs down to the rear of another dam or to the main stream on which they are floated to the mill.

As soon as the ice has gone out sufficiently to clear the stream,¹

¹ Sometimes the ice does not break up as early on lakes and large streams, when there is only a slight current, as it does on swift water, and in such cases a channel may be made through the ice in order to start the drive at the earliest possible date.

booms are placed in essential spots along the channel. A head of water is accumulated on the banking ground and a crew is set to work to "break down" the "landing" or "bank;" that is, to set the logs afloat in the current so they can proceed downstream. The sluice gates of the dams are opened a short time before the logs are started through and are not closed until several minutes after the logs have ceased coming, otherwise jams will form at points along the channel. The work starts on the pile farthest downstream and in the center of the channel, the logs from the top of the pile being thrown into the water by means of peavies and timber grapples. This continues until the drivers have cleaned a channel wide enough to enable them to roll the remaining logs from the pile into the stream. After having cleaned up one section they proceed to loosen the next section above, and are sometimes obliged to explode a small charge of dynamite to free logs which are frozen together. When logs are piled on one side of the stream, only, the drivers roll the logs into the stream, beginning at the water's edge. The loose logs float down to the splash dam where they are converged toward the sluiceway by bracket booms. Drivers stationed on the latter keep the logs parallel to the current and prevent them from jamming when they pass through the sluice. Workmen armed with peavies and pike poles² are stationed at strategic points along the stream to prevent logs from becoming stranded on sand bars, and from forming jams on rocks and in narrow places in the channel.

Jams and stranded logs often can be moved by the use of a dog-warp which has two strong hooks attached near the center of a rope stretched across the stream. A crew of three or four men is stationed on either bank and by catching one or the other of the hooks into logs the men are able to pull them in either direction. The use of dynamite is resorted to when other means fail.

¹ In the Appalachian region, logs frequently are not banked but are scattered in the beds of the streams where they await a freshet to carry them down the stream. In such cases a crew to break landing is not required. Dependence is placed on the current to start the logs.

² This is an ash or hickory pole, from 12 to 20 feet long, with a screw pike and hook on one end. It is very serviceable in controlling logs in water. The screw pike when forced into a log has a tenacious grip which enables the workman to exert a strong pull without losing his hold on the log.

The drive on small streams continues until all of the logs have left the banking ground. A crew then starts to "pick rear," that is, to collect all the stranded logs along the stream and in the sloughs and put them into the water so that they will go out with the drive. This work is generally done by men who use timber grapples and peavies for carrying and dragging the logs.



Photograph by D. N. Rogers.

FIG. 148. — A Headworks used to Tow log Rafts across Small Lakes. The winch is operated by hand labor. Maine.

Horses are employed when available and the conditions are suitable for their use.

When the course of the drive is across a lake it is necessary to confine the logs in booms and tow them to the outlet.

A limber boom called a "trap" or "catch" boom is placed at the head of the lake around the mouth of the stream and the logs are confined in it until a sufficient number are secured, when the shore ends of the boom are closed and the raft towed across the lake. The mouth of the stream is either closed temporarily or a second boom placed in position at once. Where the distance is short and the amount of timber to be moved is limited, it is "kedged" or "warped" by "headworks" of the type shown in Fig. 148. This has a capstan, holding from 300 to 400 feet of rope, which is mounted on a raft, and the latter attached to the forward part of the boom. A heavy anchor fastened to the free end of the rope is carried forward in a boat and dropped in the path of the raft. The capstan is then re-

volved either by man or horse power. When the raft reaches the anchor, the latter is lifted and again carried forward. A headworks of this character cannot be used to advantage against a head wind.

Large numbers of logs usually are handled by a "steam or gasoline warping tug" or "alligator," which is a flat-bottomed, steel-shod scow on which is mounted a pair of 20 or 30 horsepower engines and a large capstan or windlass. The boats are propelled either by screws or side wheels and are sometimes constructed so that they may be drawn overland on skids under their own power. Both indirect and direct towing methods are used. In indirect towing a cable is fastened to some convenient tree on shore or an anchor is thrown out several hundred feet in advance of the raft and the tug then run back and attached to the raft which is advanced by winding up the cable on the capstan. This method requires about one-third less fuel than the direct method and can be used when head winds are blowing. As a rule, towing must cease when there are strong adverse winds. Night work often is done because the water usually is more quiet then.

Transport on small streams, as a rule, is more expensive per thousand board feet per mile than on large ones, because of the limited amount of timber handled, the rough character of the channel, and the greater number of improvements per mile which are required.

Individual drives on small streams are in charge of a foreman who often is the woods superintendent, or the boss of the logging camp at which the timber was cut. One or more subforemen aid him in the conduct of the work.

*The Drive on Large Streams.*¹—The driving problems on portions of the route are often similar to those on small streams, but in general the difficulties incident to the transport of logs are not so great. The channel is wider, with longer stretches of smooth water, and the greater volume of timber annually passing downstream makes it practicable to install more improvements than is profitable on small streams. Fewer men are required in proportion to the amount of timber handled and the distance covered, and under normal circumstances the expense per thousand board feet for labor is less. A large part of the driving work on the average stream is the prevention of jams at curves,

¹ See page 402.

on sand bars, at rocky narrows and similar places, and "picking rear" after the main drive has passed. On many large streams the banks for a portion of the distance may be low, so that logs can float out of the channel into sloughs or over land inundated during flood time, and the drivers must keep their booms in good condition to prevent this and to keep the logs moving.

Crews are divided into squads, under sub-foremen, and are stationed at danger points along the stream. These crews must do much of their work from bateaux or by standing on logs, because of the width of the banks. In place of "alligators" and "headworks" powerful side wheel, end wheel or screw tugs are employed for the transport of large quantities of logs across lakes, or down streams where it is necessary to confine the logs in booms.

When the head of the drive reaches the first assorting gap, a crew of men begins assorting and this continues during the summer and fall until the logs are all assorted, the water fails, or ice closes the river. If no ill luck has attended the drive the last logs are usually down by October first.

The drive on the upper Connecticut river originating on the Wild Ammonoosuc in New Hampshire and extending to Bellows Falls (17 miles on the Ammonoosuc and 93 miles on the Connecticut river) begins about the first of April and lasts from twenty-three days to six months. The average time is about six weeks. One hundred men are required on the Ammonoosuc and about sixty on the Connecticut river.

On the Penobscot river in Maine, the average length of drive is approximately 150 miles and the longest drive which originates on either the North or South branch of the West Branch is about 240 miles. The average quantity of material annually driven down the West Branch is 130,000,000 board feet, about three-fourths of which goes to Millinocket, and the remainder to Bangor and vicinity. The drive begins about April 20th and the last logs reach the booms above Bangor about October first. Approximately 2500 men are employed for the first six weeks and after the logs reach the main stream the force is cut to about 200 men, exclusive of those occupied at the assorting gaps.

RAFTING ON STREAMS

Rafting is a common method of handling logs on large streams and lakes and is practiced in all parts of the United States. The motive power is usually end-wheeled or side-wheeled steamers on small bodies of water, and screw-propelled tugs on large bodies of water. Rafts are now seldom drifted with the current. The advantages of rafting are:

- (1) It prevents loose logs from scattering and becoming

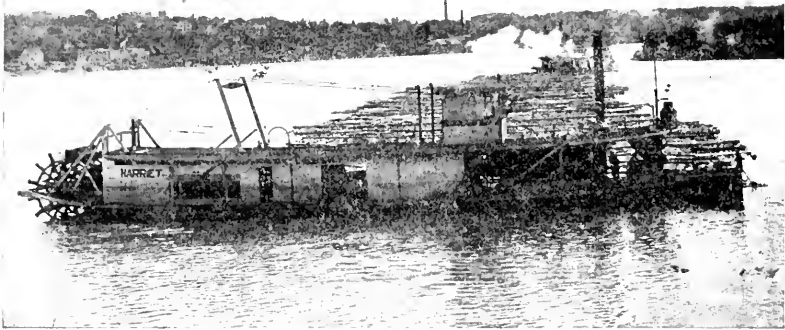

FIG. 149. — A Mississippi River Log Raft, Showing the Method of Control by End-wheeled Steamers.

entangled in bushes along the banks, and from being stranded on flats submerged at high water.

- (2) It enables the water transport of non-buoyant species which can be held up by fastening them to logs which float.

- (3) Extensive booms are not required at destination to catch the logs as they come down.

- (4) It insures prompt delivery on lakes and other waters where there is no current to carry the logs along.

- (5) The Federal Rivers and Harbors Act of March 3, 1899, declares "that it shall be unlawful to float loose timber or logs in streams actually navigated by steamboats in such manner as to obstruct, impede, or endanger navigation."

There are a variety of forms in which rafts are built, depending upon the character of the water on which they are to be towed, the kind of timber rafted and on the Federal regulations¹ governing rafting.

Bag or Sack Booms. — These are used on the Great Lakes and on large rivers. They have a single or double row of boom sticks surrounding the impounded logs. For lake work short boom sticks of large size are preferable because loose logs are less apt to slip under them than they are under the long ones.

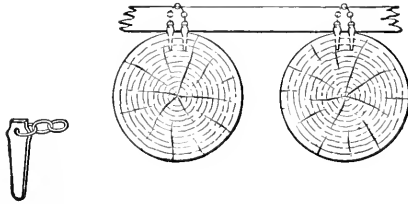

FIG. 150. — Method of fastening Rafting Poles to Logs by means of Iron Dogs.

On the Great Lakes double booms with connecting chains made of $1\frac{1}{4}$ -inch iron are considered superior to single booms, especially for rough water. A type of boom which is serviceable for impounding logs for towing in bad weather is made from white pine logs 24 inches or more in diameter and from 16 to 24 feet in length. The boom sticks are bored 18 inches from the ends for $1\frac{1}{8}$ - or $1\frac{1}{4}$ -inch chains and are blocked across the top and bottom, in front of the chain holes, with hardwood strips to prevent the chains from cutting into the boom sticks. The chains should not be longer than is necessary to permit the ends of the boom sticks being coupled 24 inches apart. Two sets of boom sticks are placed around each raft so that it will not go to pieces if one set of chains is broken. During the period when the exportation of logs was permitted by the Provincial Governments of Canada, large quantities of white pine were rafted to this country and manufactured at points along the Great Lakes. The season for towing was from June 1 to October 15. The rafts contained from 2,000,000 to 6,000,000 board feet each, and were handled by powerful tugs. The transport of logs from Canada

¹ The Federal government specifies the form, size and character of rafts that may traverse certain navigable waters and harbors.

to the United States practically ceased in 1898 when an embargo was placed on the export of logs from Crown lands.

Rafts Fastened with Poles. — The common form of raft on the Ohio River and on some southern streams is one in which the logs are made up into raft sections. The logs in each section are attached to each other by poles placed across the logs and fastened to them by means of rafting dogs. The sections are fastened together by cables.

On the Ohio River poplar and other logs are rafted in lengths of from 20 to 60 feet. The longer logs are preferred because of the greater ease in rafting and also because the laws of adjoining states allow a fee of 25 cents per stick without regard to length, to all parties who catch and hold logs for rafting. On the upper reaches of the Big Sandy River floating logs are caught and about sixty sticks are made into a raft which is from eight to twelve logs wide and from 250 to 400 feet long. The logs are bound together with small poles 20 feet long which are placed at intervals of from 10 to 12 feet. Rafts are equipped with long sweeps at each end to assist in guiding them, and each one is floated down to the mouth of the stream in charge of two men. The owner makes from twelve to sixteen rafts, containing from 700 to 900 sticks, into a fleet and takes it down-stream to the mills under the control of a tug. An occasional fleet containing 2000 logs is handled which is regarded as the maximum size practicable.

A modification of this form of raft is occasionally used for handling yellow pine in the South. The rafts are made up in sections one log long held together by poles which are attached to the logs by wooden plugs driven into holes bored through the poles and into the timbers. Several sections are then made into a raft and floated downstream to the mill under the guidance of raftmen who steer with long sweeps or oars.

On some of the streams in the Northeast assorted logs are made into rafts and towed to the mills. The St. John's River Log Driving Company of Fredericton, New Brunswick, makes up its

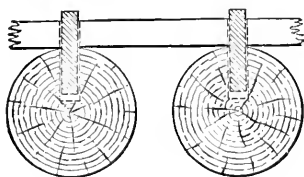

FIG. 151. — Method of Attaching Rafting Poles to Logs, by means of Wooden Pins.

rafts in the following way. The logs after being assorted are run into pockets according to ownership. About thirty logs are fastened together at one end with a "rattling line" which is a cable on which are strung the necessary number of ring dogs. This "joint," as it is called, is then floated out of the pocket and down the "rattling run" to the "bottom makers" who place two boom poles across the raft, and bore holes through the boom



Photograph by R. B. Miller.

FIG. 152. — Loading the Bottom of a Raft with Logs by means of a Parbuckle. A bracket boom is shown on the left. New Brunswick.

poles and logs which are then fastened together with hardwood pins. The rattling lines are then removed and the bottom passes down to a loading machine where a top load of logs is placed upon it. The joints are then sealed and floated downstream where from five to seven of them are fastened together by short pieces of poles, called brackets, and hardwood pins and then towed to the mill by tugs.

For many years rafts on the Mississippi and some other rivers in the Lake States were made into "brails" or sections. The logs were fastened together with poles in a manner similar to the Ohio River method, except that rope and rafting pins were used instead of chain dogs. Two-inch holes were bored in the log on either side of the pole and the ends of a short section of rope placed in these holes and firmly held by hardwood rafting pins

driven in behind them. This was an expensive method because of the large amount of rope required, and it has now been superseded by an improved method patented by an employee of one of the boom companies.

The brails as now made have a set of boom sticks forming a rectangular pocket which is filled with loose logs. The boom sticks are held together by a 3-link chain 10 inches long (Fig. 154) through the outer links of which the pin (Fig. 154*b*) is passed and then driven into 2-inch holes bored in each boom stick. These pins are made of oak and turned to a minimum diameter of 2 inches

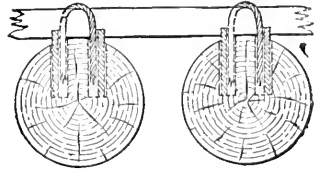

FIG. 153. — Method of fastening Rafting Poles to Logs by means of Wooden Rafting Pins. A method formerly used on the Mississippi River.

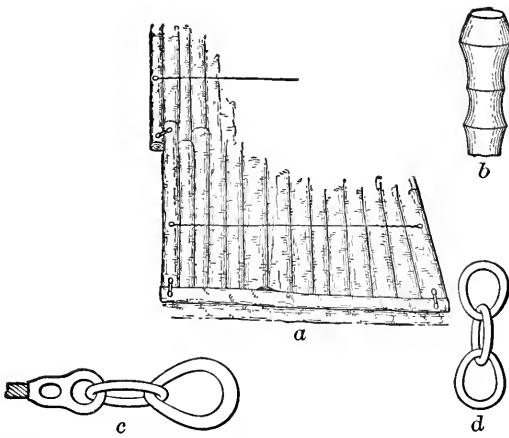

FIG. 154. — Details of a Mississippi River Log Raft. *a*. The method of fastening the boom sticks together, and bracing them with cables. *b*. A rafting pin such as in inserted in the outer links of the chain *d*. *c*. The free end of the cable which is used to strengthen the raft. *d*. 3-link chain through the outer links of which the rafting pins are driven.

and a length of 11 inches. The top end has a swell $2\frac{1}{4}$ inches in diameter, with a slightly smaller swell in the center. The head is large enough to prevent the chain link from slipping over it and the swell in the center binds on the wood and holds the plug fast. A cable is passed through the center links around

the entire brail and further strengthens it. The brail is braced crosswise with cables as shown in Fig. 154*a*. Several links of chain are fastened to the outside boom sticks by means of a rafting pin. On the opposite side one end of a special cable, Fig. 154*c*, is fastened to the boom stick by a pin and the other end carried over to the chain, which is passed through a flattened link and caught. This gives rigidity to the raft.

The chains and cables can be used repeatedly and hence are cheaper than rope, which can be used but once. Rafts of this



FIG. 155. — A Cypress Raft in a Louisiana Bayou. The floating vegetation on the extreme right is the water-hyacinth.

character are made in sections, some of them 300 by 750 feet in size, and containing from 850,000 to 4,000,000 board feet of timber. They are controlled by two end-wheeled boats, one at the rear which serves to regulate the speed, and one at the front end which is floated side on and which guides the raft by pulling it backward or forward across the stream.

Cypress Rafts. — Cypress logs, which are skidded with pull-boats, are rafted down the canals and bayous. A common form of raft has cigar-shaped sections from 150 to 200 feet long, each containing from twenty to thirty logs which are floated loose within the boom sticks. Sinkers are placed between floating logs and fastened to them by poles and chain dogs. Old skidding cable is often used to bind the boom sticks together. A 2-inch hole is bored in the log, and the end of the

cable inserted and made fast by a wooden plug driven in behind it. The sections are fastened together by rope, and made into a long raft which is towed to the mill by small tugs. Navigation is seriously hampered and sometimes stopped by the



FIG. 156. — Raft Bundles at the Mill Pond. North Carolina.

congestion of the watercourses by the water hyacinth and mills have been forced to shut down on account of the lack of logs, due to the closing of the waterways by this plant.

Raft Bundles. — In the Coastal Plain region logs are sometimes made into bundles each containing two car loads of logs, from 20

to 30 pieces, which are bound together firmly with chains. The maximum tow for the larger tugs used on this work is from thirty to forty bundles. From 30 to 40 per cent of the timber cannot be floated and the object of this method of transportation is to make the buoyant carry the non-buoyant logs. Bundles frequently have to be made over because of an excess of heavy logs which causes them to sink. The bundles are constructed at a log dump built over some tidal stream. A cradle of two heavy cables is used to bundle the logs. One end of the cable is fastened to the railroad trestle, and then passed down under the water and up to a winch located in the second story of the log dump. The cables thus make a large loop into which the logs are unloaded. Two binding chains are sunk into the water alongside each cable, one end being temporarily attached to the unloading dock and the other end to a small rope which is placed outside of the cradle. When the logs have been placed in the latter, the bundle is made compact by tightening up the cradle cables, and the binding chains are then brought around the bundle, tied and made fast by heavy iron dogs.

Pacific Coast Rafting. — Logs in the Pacific Coast region are often rafted down the large streams, or towed along Puget Sound to the mills. Two forms of rafts are employed for this work. When logs are to be floated downstream without the aid of a tug, they are made up into "round" booms which are a group of loose logs surrounded by several boom sticks. The raft may be allowed to drift with the current or controlled by tugs, and may or may not be in charge of a raftsman, depending on the character of the stream, and the tides.

Logs that are to be towed to destination are rafted at a "harbor boom," which has a large storage pocket and a rafting pocket. The logs are brought to the harbor boom by rail and dumped into the storage pockets which are areas inclosed by boom sticks held in place by piling. The rafting pockets are narrow lanes about 75 feet wide and from 800 to 1000 feet long inclosed by boom sticks, held in place by piling placed at approximately 70-foot intervals. The logs may or may not be assorted for quality and species. Rafting on tide water can be carried on only during a favorable tide.

The rafters first string boom sticks across the far end and on both sides of the pocket. Logs of approximately equal lengths

are then poled down the run and stowed parallel to each other in the first section of boom sticks. Each row is known as a "tier," and two tiers usually constitute a section about 75 feet square. As soon as two tiers have been stowed, boom sticks called "swifters" are placed across the end of the section at right angles to the tiers, and attached to those on the outer side of the raft unit. New sections are then made up in the same manner, from twelve to fourteen constituting the usual tow. Two rafters can make up about six sections or from 260,000 to 300,000 board feet during a tide.

When the rafting is done in rivers where there is a strong current a slightly different procedure is followed. The rafters start at the near end of the rafting pocket and hang out three or four sections of boom sticks. The logs are then run into the rafting pocket and guided with a pike pole to their place in the "tier." Difficulty is sometimes experienced in turning logs end on in a swift current, if they get crosswise of the rafting pocket. In case piling is not used to confine the rafts, each section is kept from spreading until completed by the use of a rope or cable also called a "swifter" which is fastened to the outside boom sticks. When the sections are completed the "swifters" are removed.

OCEAN RAFTING

The first attempt at rafting logs for transport on the high seas was made about 1884 when a large raft was constructed in Nova Scotia, launched from shore and started toward New York in charge of a tug. This raft was lost because the tug left it to go into port for coal and on return to the high seas was unable to again locate it. After a long period it washed ashore on the Norwegian Coast. The same builder later went to Coos Bay, Oregon, where he built two rafts for transport to San Francisco, one of which reached its destination safely. In the construction of the latter rafts the use of cradles or floating frames was first adopted.

In 1894, raft building began on the Columbia river, where it has reached its highest development. Several rafts now leave annually for San Diego, California, with no losses during recent years. The rafts known as the Benson type, are built cigar-shaped and from 700 to 1000 feet long, with a depth at the center

of from 30 to 35 feet and a breadth of from 50 to 60 feet. The taper extends 100 feet from each end.

Ocean-going rafts are built in a cradle or frame which is moored to piling in deep water. One side of the cradle is detachable and when the raft is completed it is launched by dropping this side and allowing the raft to slide sidewise into the water. A 700-foot cradle requires 200,000 board feet of timber in its construction and with minor repairs it can be used for an indefinite period provided the water is sufficiently fresh to prevent toredos attacks. A derrick hoisting engine, mounted on a scow, is necessary for stowing logs in the cradle. A crew of five or six raftsmen is required.

The logs are floated out to the cradle and, beginning at either end of the latter, the longest and most pliable sticks are used for the outer layers. These sticks should be at least 60 feet long and are placed with their butts toward the center of the raft. This gives a taper to the body of the raft and as the logs gradually work outward the binding chains are drawn tighter. The interior may be filled with any length logs, provided the joints are broken.

After the raft has been built up to a height of 20 feet, a 2 $\frac{1}{4}$ -inch tow chain is laid from stem to stern with 50 feet projecting on either end to which the towing cable is attached. "Herring bone" chains, made from 1 $\frac{3}{4}$ -inch iron, are then attached to the main tow chain on the tapering ends of the raft, then run diagonally across the raft toward either end, and fastened to the binder chains. This prevents the latter from slipping on the conical portion of the raft, distributes the pull of the tow chain over a large portion of the stern, and also gives a limited amount of slack in the center which is essential to permit the raft to bend slightly with the action of the waves.

When the raft is completed, binder chains made from 1 $\frac{3}{4}$ -inch iron are placed entirely around it at 12-foot intervals and are tightened by the hoisting engine. A 700-foot raft containing from 4,000,000 to 5,000,000 board feet requires about 115 tons of chain.¹ A 30-foot raft draws from 20 to 22 feet of water.

¹ A brief description of a similar ocean-going raft constructed at Bonne Bay, Newfoundland, in 1917 may be found in *American Lumberman*, January 25, 1919, p. 35. This raft was built on a plank foundation on a sloping beach and at high tide was pushed out into deeper water as the work progressed.

The safe towing periods are from June 15 to September 15 and, under favorable conditions, the trip can be made in from eighteen to twenty days.

A different type of ocean-going raft was developed some years ago in British Columbia which does not require the use of a cradle such as is used in building the Benson rafts.¹ They are preferred for use where rafts are built in salt water because marine borers

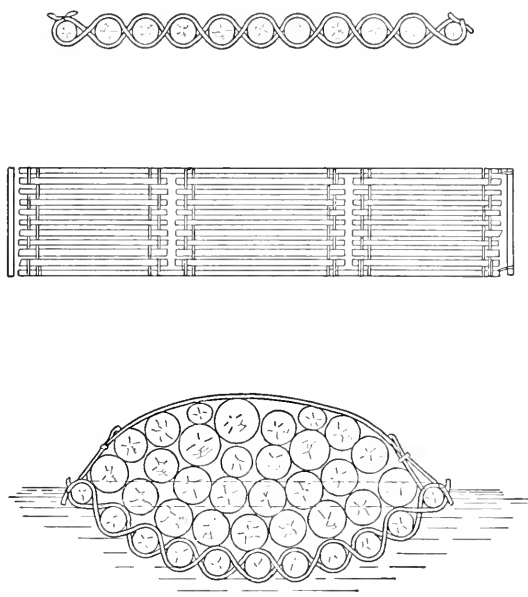

FIG. 157. — General Form of the Davis Patent Log Raft.

attack cradle timbers and necessitate frequent and costly repairs.

A bottom tier of logs is first formed by enclosing an area 70 feet wide and 150 feet long with boom sticks which are bound together with cables. A swifter is also placed crosswise of the side boom sticks at each end in order to keep the raft rectangular in shape. A bottom tier of logs is then placed in position between the swifters and bound together with $1\frac{1}{4}$ -inch cables or with chains.

Several tiers of logs are then placed on the floor and a chain passed around them and fastened to the outside boom sticks. A top load is then placed on the raft and bound together with cables

¹ See Fig. 157

or chains. Cables are then passed over the top of the raft and the cable ends made fast to the side boom sticks. Logs from 32 to 70 feet are most suitable for this form of raft. Joints should be broken in stowing the logs in order to make the raft rigid. A raft 70 by 150 feet in size will carry about 750,000 board feet of timber.

LOG BARGES

Barges are used for the transportation of hardwood logs on some portions of the lower Mississippi river, the logs being brought to the banks of the stream and loaded by power derricks, mounted on barges or by derricks on the barge itself. One of the better types of barge suitable for log transportation is about 100 feet long with an open hatch on each end about 36 feet in length. Two steam derricks are mounted on the center of the barge, a boom projecting over each hold. Such a barge, carrying from 90,000 to 100,000 board feet of logs can be loaded in from twenty-four to thirty working hours by a crew of five men, two working in the hold, one operating a derrick, and two on shore. Barge transportation is desirable on streams where suitable rafting facilities are not available, when logs are to be moved upstream, and with species that are too heavy to float. Although introduced in the Lake States, this method never gained favor in the transport of logs from Canada to the United States, because of the limited capacity of the boats, and the ease and safety with which logs could be rafted.

SUNKEN LOGS

Many streams, on which driving has been carried on for years, have accumulated large numbers of small, heavy butted and sappy logs in their channels. In the Lake States streams which contain large quantities of sunken timber, the "deadheads" average about twenty pieces per thousand board feet.

Many efforts have been made to salvage sunken timber, especially in this region, and although log-raising companies have been formed and have operated to a limited extent, the industry has never assumed large proportions. The obstacles in the way of successful operation have been numerous. According to a decision¹ of the Supreme Court of Michigan the title to

¹ See page 411.

sunken logs remains with the original owners. Where several hundred marks and brands have been used on a stream, it is almost hopeless for a company to attempt to secure title to all the logs raised because many of the owners of given brands and marks are deceased or have left the region. In addition the log raiser must reckon with riparian owners which is a further drawback to the work.¹

There have been numerous methods used in raising logs, some of which have been patented. On shallow streams and on lakes the practice once existed of raising the logs by various means, towing them to the bank where they were stored until they dried out, and then rolling them in the water to float to the mill. This method was not entirely successful because many logs again sank, even though they had been stored on the bank for a period of two years.

When the distance from the point of operation is short, floats made of logs are built and a windlass mounted on them. The float is poled over the sunken logs and the latter raised by means of tongs which are attached to a manila rope wound on the windlass. The raised logs are dogged to the float and poled or towed to the mill or some convenient storage point.

A hoisting engine with suitable booms and grapples, mounted on a flat boat, has also been used. The logs were either rafted and kept afloat by steel tubular buoys 32 feet long by 18 inches in diameter which were scattered throughout the raft, or else loaded on scows and towed to the mill or to some convenient storage point. Occasionally deadheads are attached to rafts of

¹ A law became effective in Wisconsin on June 1, 1921, which provides that deadheads, and sunken, or stranded logs outside of the limits of existing booms, which have remained for more than six years in navigable waters where more than one corporation or individual has floated logs, and in which no booming company has actually operated, are declared "abandoned" and may be salvaged by anyone. Those who salvage logs must publish notice of their intention previous to beginning work. On or before the seventh day of each month during the progress of salvaging, records of the number of logs salvaged, and marks on the logs must be filed with the lumber inspector. Those claiming ownership in the salvaged logs, after proper identification, and within thirty days, may recover logs, by paying a reasonable compensation to the salvager. All logs on which no claims are filed become the property of the operator. This law does not apply to certain streams forming the boundary line between Michigan and Wisconsin, nor to certain other streams or portions of streams specified in the law.

floating timber and thus buoyed up until they reach the mill.

BIBLIOGRAPHICAL NOTE TO CHAPTER XXII

- A Digest of the Laws Relating to Logging which have been Enacted in the Different States. Polk's Lumber Directory, 1904-05. R. L. Polk and Co., Chicago, pp. 96-150E.
- ANONYMOUS: Davis Ocean-going Log Raft. West Coast Lumberman, Dec. 15, 1917, pp. 28 and 29.
- BARROWS, H. K. and BABB, C. C.: Log Driving and Lumbering Water Resources of the Penobscot River, Maine. Water Supply Paper 279, U. S. Geological Survey, Washington, 1912, pp. 211-220.
- BRIDGES, J. B.: Definition of the Law Governing the Use of Driving Streams. The Timberman, August, 1910, pp. 64F and 64G.
- BRIDGES, J. B.: Laws Governing the Use of Streams for Logging Purposes (Pacific Coast). The Timberman, August, 1909, pp. 49-51.
- FASTABEND, John A.: Ocean Log Rafting. The Timberman, August, 1909, pp. 38-39.

CHAPTER XXIII

FLUMES AND LOG SLUICES

Log and lumber flumes, and log sluices are built to transport lumber, crossties, shingle bolts, acid wood, cordwood, pulpwood, mine timbers and saw logs from the forest to mills, railroads or driveable streams, and to carry products from the mill to market, or to rail transport. They are used to some extent in nearly every forest region, but are especially serviceable where stream transportation is not available and when the topography is so rough that railroad construction is costly.

They have several advantages over logging railroads in a rough region: (1) they can be carried over inequalities in the ground, or across gulches on fairly light trestles; (2) they can be operated on steeper grades; (3) they occupy less space than a railroad and hence require smaller cuts and tunnels and can often be located in narrow canyons where there is not sufficient space for a railroad.

The disadvantages are: (1) the transport of crooked and long logs is difficult and costly; (2) the light construction renders them more subject than railroads to damage by windstorms, fires, floods, falling timber and other natural agencies, although they can be repaired more cheaply; (3) they usually offer no means of transporting supplies from the railroad to the saw mill or forest; however, in some instances the edges of the flume box are used as a track over which railroad speeders are run, thus affording communication between the two ends of the flume; (4) the transport of lumber roughens the surface of planed material and also batters the ends of the boards which have to be trimmed after leaving the water so that planing mill work must be done at some point below the lower terminal of the flume.

TYPE OF BOX

There are two types of flume and sluice boxes. One is V-shaped and may have a "backbone"¹ which makes a box 6 or

¹ A triangular strip fastened in the vertex of the flume box.

8 inches wide at the base, with outwardly sloping sides. The other is known as the box flume.

The choice of type and size of box depends on the character and size of material to be transported, the amount of water available, and the ultimate use of the water itself. In some instances when water from flumes is used for irrigation purposes, the box is of larger size than is required for the sole purpose of transporting forest products.

Lumber and log flumes rest on skids on the ground or are elevated on trestles. They sometimes pass through tunnels or cuts although these are avoided whenever possible because of the increased cost of construction.

V-box. — This type of box is commonly used for lumber, crossties, small dimension stock, small round mine timbers, pulpwood,¹ and, when built of large size, for saw logs.² With a backbone it requires less water than any other type.

A box with a vertex angle of 90 degrees is the best because it has a slightly less length of side than greater or lesser angles, it allows the movement of logs with greater crook, it gives more clearance to the log than a box with a greater angle, and is more economical to construct because the joints at the apex can be fitted more easily.

An objection sometimes raised to the use of a V-box for the transport of shingle bolts and other short material is that when the individual pieces are uneven in size and weight they do not all travel at the same speed, therefore, they are apt to double on low grades and on curves.

¹ A pulpwood flume operated in the Adirondack Mountains of Northern New York was 36 inches across the top and 36 inches deep. It was supported on a trestle which in places was 100 feet high. The flume was $2\frac{1}{2}$ miles long, had a capacity of sixty cords of 18-inch pulpwood per hour, and the bolts traversed the distance in $7\frac{1}{2}$ minutes, dropping into a stream down which they were driven to a pulp mill.

² A 5-mile log flume was constructed in Idaho with an average grade of 11 per cent, a maximum grade of 15 per cent, and a maximum curvature of 20 degrees. The box was supported on trestles 16 feet apart with 4- by 8-inch sills, posts, and caps and 2- by 6-inch braces; 5- by 10-inch stringers with 2- by 6-inch lateral braces and round pole supports in the center of each bent; 4- by 6-inch bracket sills spaced from 2 to 4 feet apart depending on the weight carried and the strength required at loading points, and 3- by 6-inch braces. The box was made from 2-inch rough lumber with the cracks battened with $1\frac{1}{4}$ - by 4-inch strips. See *The Timberman*, August, 1912, pp. 42-44.

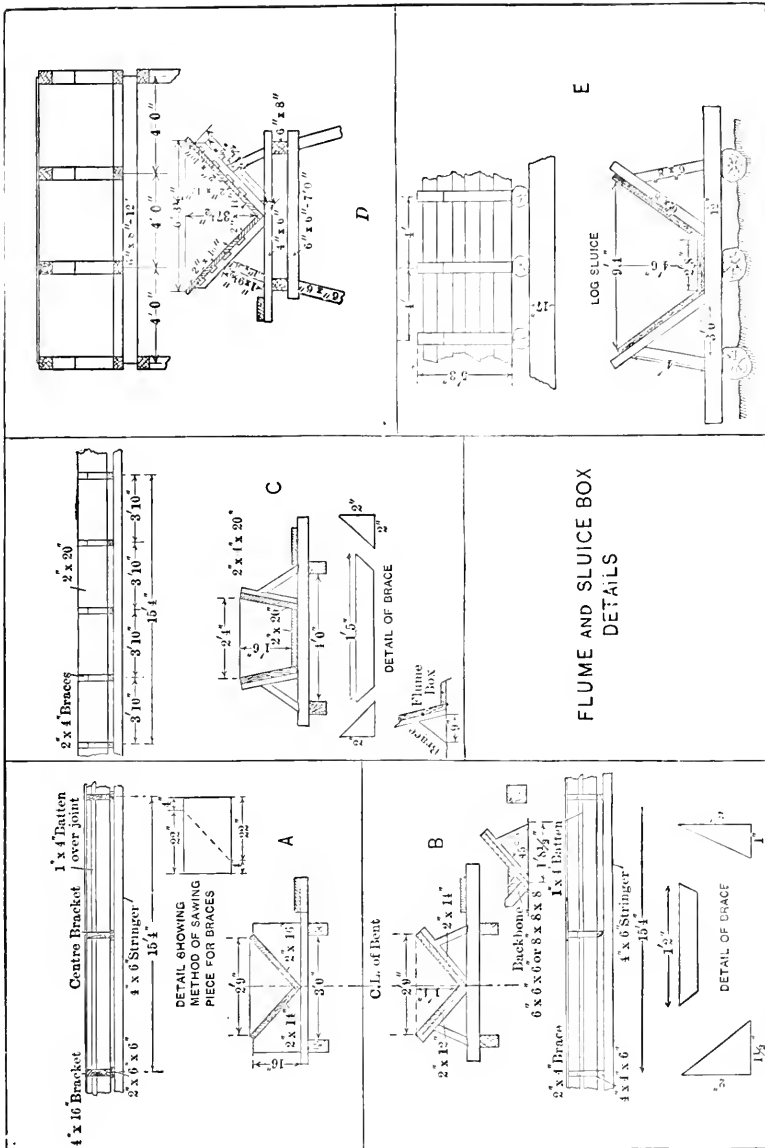

FIG. 158. — General Features of Flume and Sluice Boxes. A and B. V-boxes for lumber, dimension stock and cross-ties. C. Box for slingle bolts, pulpwood and small logs. D. V-box for logs. E. Sluce box for logs, used in stream improvement work.

The box of a V-flume for lumber and crossties has sides ranging from 15 to 18 inches high and is from 30 to 36 inches wide at the top (Fig. 158A and B), while those for floating large logs may have a top width of 60 or more inches. The backbone when added is made from a 6- by 6-inch or 8- by 8-inch timber sawed diagonally. The side boards of the box are 1 inch in thickness for sides up to 30 inches in height, $1\frac{1}{2}$ inches if from 30 to 36 inches high, and 2 inches if from 36 to 48 inches high. The cracks are battened with 1- by 4-inch or 1- by 6-inch strips. The boards range in width from 8 to 14 inches, but are usually from 12 to 14 inches. The lengths are commonly 16 and 24 feet.

Box Flumes.—These are used for lumber and dimension stock (Fig. 158C), shingle bolts, pulpwood, and logs.¹ They are more expensive to construct than a V-flume because the greater weight of water carried necessitates a heavier trestle and the box is more difficult to fashion. Where the water supply is abundant, boxes of this character are sometimes used for lumber transport. A box flume² in California transports 300,000 board feet daily. From five to six boards are clamped together into a unit which is floated singly on the steeper grades toward the head of the flume.³ On the low grades near the lower terminus from twenty-five to thirty units are “dogged” together with manila rope and floated to destination.

For shingle bolts, acid wood, and cord wood a box with a 10-inch bottom, 20-inch sides, and 24 inches across the top is sometimes used. In Northern New York a flume of this size handled 60 cords of spruce pulpwood per hour. As a rule, however, they are larger with a base of approximately 20 inches, sides from 16 to 20 inches high, and a width across the top of

¹ See note, page 450.

² This flume was started in 1891 by the Fresno Flume and Irrigation Company for irrigation purposes, connecting the sawmill at Shaver with the planing mill and shipping depot at Clovis. Near the head, the flume box is rectangular and has sides 12 inches high and a width of 48 inches. On the steep mountain pitches the sides are 32 inches high, and on the lower end 48 inches high. The maximum grades are $4\frac{1}{2}$ per cent and the minimum grade on the flats 0.5 per cent.

³ The clamp, which is patented, is a bar of $\frac{1}{2}$ -inch half-round iron, with a 1-inch flat face having recurved points at each end. The boards are made into piles with the ends flush with each other, a clamp is slipped over the end, and a wedge driven between two boards near the center of the unit. This drives the points into the outer boards and binds the whole load together.

from 30 to 32 inches. The boxes are supported on trestle work similar to that used for the V-flume, although the construction is stronger.

The boxes of log sluices (Fig. 158E) are of larger size than those for lumber flumes and carry more water. They are used chiefly to supplement stream driving by transporting logs through rocky

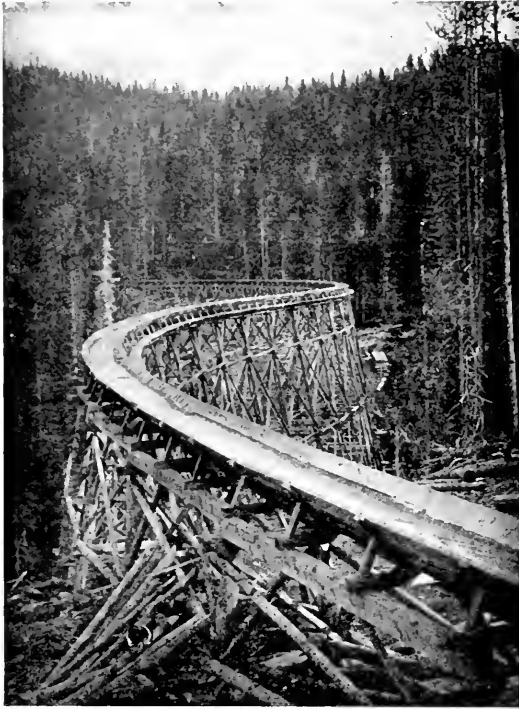

FIG. 159. — A V-flume for transporting Mining Stulls. Montana.

gorges where an excessive amount of water would otherwise be required or where boulders prevent the improvement of the stream for loose driving, and for transporting logs over stretches of streams whose banks are so low that the flood waters scatter the logs over the lowlands. They are also used in connection with log haul-ups to transport logs from one watershed to another, and, in some cases, to transport logs directly from the forest to the mill. They have been used frequently in the Lake States and occasionally in the Northeast.

On account of the large amount of water they must carry to float logs and because of the wear-and-tear they receive, the boxes are made of strong material supported on cribwork which is kept as near the ground as is feasible.

Sluice boxes are sometimes made with two thicknesses of 2-inch plank, the inner set being surfaced and tongued and grooved to insure a tight joint, while the outer planks break joints with the inner and make a tight box. A sluice of this character built in the Lake States for white pine was 36 inches wide at the base, 108 inches wide across the top, and 60 inches high. The water in the sluice was controlled by half-moon gates (Fig. 136), located at the mouth of storage reservoirs.

TRESTLES

Trestles may be built of round timber or of 2- by 6-inch or 4- by 8-inch sawed material. Flumes used for transporting sawed products usually have a trestle made from square-edged material, because it can be secured at the mill and transported to the place of construction in the completed portion of the flume. Where logs, pulpwood, acid wood, and other rough material are transported from the forest to the manufacturing plant, round timber from 8 to 12 inches in diameter is often used for trestle construction for it usually can be secured in the vicinity, although some prefer to erect a portable sawmill at the head of the flume and manufacture lumber for its construction.

Caps for round timber trestles are made either from small timbers hewed on opposite faces to the desired thickness or from sawed material. Stringers are usually made from sawed timber. The braces for round timber trestles are made from small poles.

Caps for square-edged timber trestles are made from 2- by 6-, 4- by 4-, or 4- by 6-inch material, and stringers from 4- by 4-, 4- by 6-, or 6- by 6-inch timbers, the choice depending on the size of the box, the distance between trestle bents, and the amount of water carried.

Braces for the box are placed along the stringers at 2-, 4-, or 8-foot intervals, depending on the length of the span, the form of the box,¹ and the strength required at special points, such as

¹ A V-box with a backbone for fluming lumber requires bracing only at 8-foot intervals, while a box flume should have braces every 4 feet on a 24-foot span. Loading points on log flumes are often braced at 2-foot intervals.

Note:
 All diagonal bracing 1 x 6 nailed with 8d wire, nailed at all contacts, 24" & 16" lengths used, sawn to fit.
 Horizontal bracing 2 x 6 unless otherwise specified. Spiked with 20d spikes.
 Legs Spiked with 20d spikes every 18"

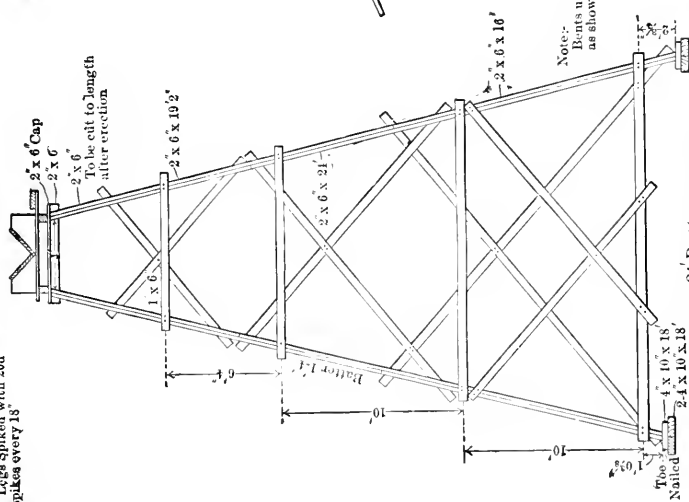

Note:
 Fore & Afts and cross bracing spiked at each contact. Bents less than 60 ft hgt. spaced 15' more than 60 spaced 27' 6"

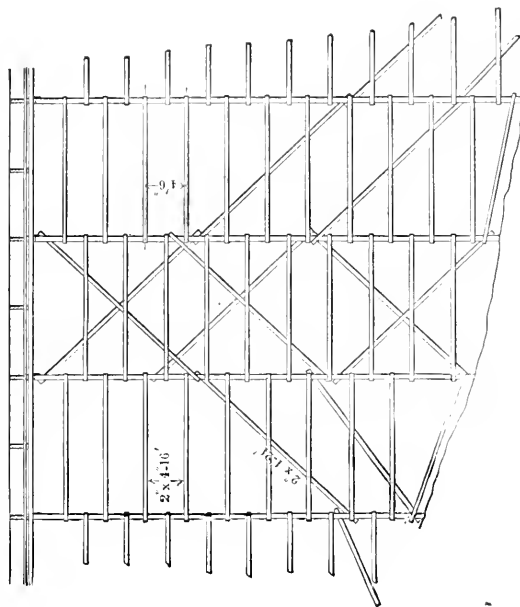

VIEW SHOWING METHOD OF "X" BRACING TO BE USED EVERY 10TH SPAN

Note:
 Bents under 75' constructed as shown.

FIG. 160. — Details of a Trestle Bent for a Lumber Flume; also the Method of cross-bracing the Bents.

loading stations. They may be made from 2- by 4-inch joists or from solid 4-inch blocks (Fig. 15SA and B).

A practical type of trestle¹ for a lumber flume under 75 feet

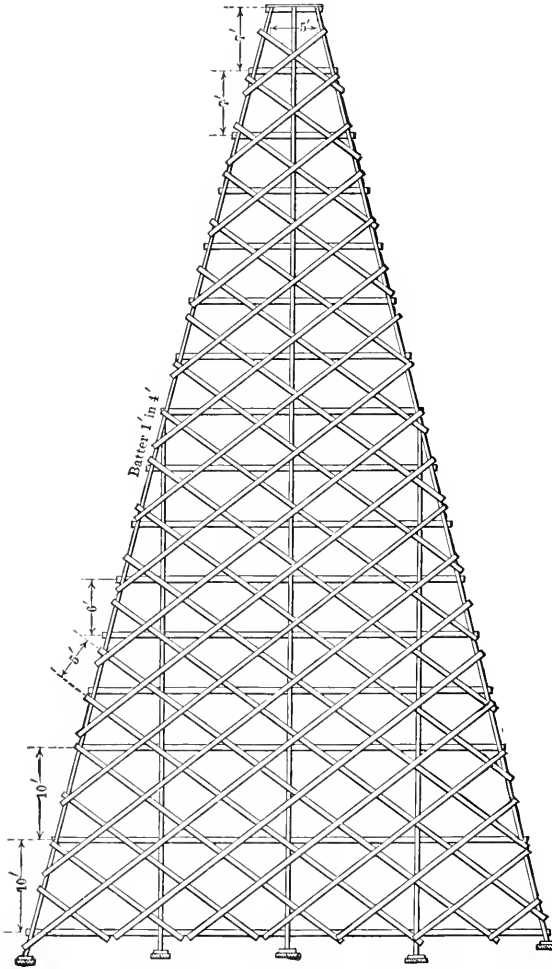

FIG. 161. — A Five-leg Trestle for Heights Greater than 75 feet.

in height has two legs made from 2- by 6-inch joists, doubled and braced (Fig. 160). For heights greater than 75 feet a trestle with five legs is used (Fig. 161).

¹ Designed by F. M. Kettenring, C. E., Vancouver, Washington.

Two 4- by 6-inch stringers rest on the caps which are spiked to the trestle. Solid braces which support the sides of the V-box are placed on the stringers at 8-foot intervals. The details of the brace and other features of the box are shown in Fig. 158A.

TERMINALS

Flume terminals are of several different types. The choice is dependent largely on the kind of material handled and its

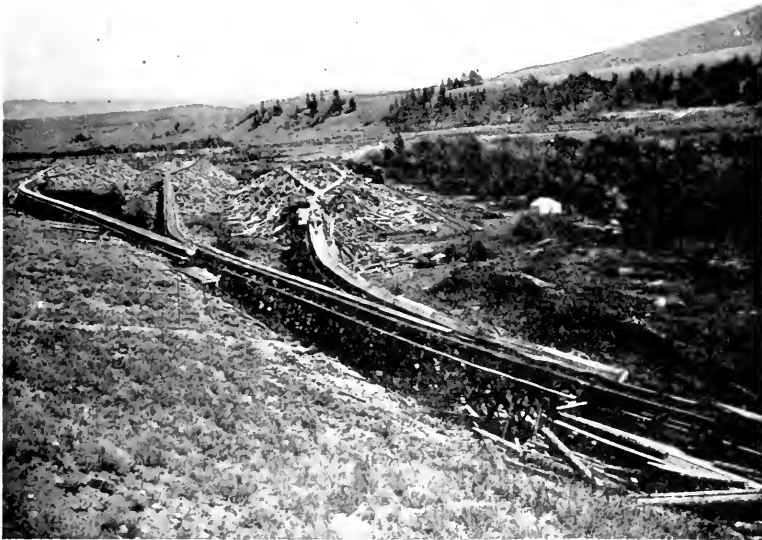

FIG. 162. — The Terminal of a Log Flume, near the Deerlodge National Forest. This type is known as the "elephant." Montana.

disposal at destination. Logs, pulpwood, and rough stock are often dumped into streams thus obviating the necessity for any special form of terminal.

On the Allen flume¹ in the Deerlodge National Forest in Montana round mining timbers are transported to a storage depot where they are loaded on cars and hauled to destination. The flume is about 20 feet high at the dump and the logs are run out upon rollers on a platform. These carry the logs to the point where they are rolled upon cars. The water from the flume

¹ See note, page 452.

falls upon a waterwheel which drives the rollers when the latter are thrown into gear.

Another type of terminal, known as the "elephant," is shown in Fig. 162. The flume forks several times near the terminal and forms branches. Logs are diverted into a given branch by closing the branches not in use, and the logs are run out to the end of the terminal and fall in a rough-and-tumble heap below.

The type of terminal shown in A, Fig. 163, is often used when lumber is dumped on platforms or loading stations. Lumber shoots out from the end of the flume and piles up on the platform at the base of the terminal. When one side becomes filled the shunt board is turned and the lumber diverted to the opposite side.

A form of terminal similar to B, Fig. 163, may be used for crossties and heavy timber. The timbers are removed by hand from the rollers and piled on the unloading platform or on trucks.

LOCATION

The practice followed in flume location will depend upon the data available to the engineer previous to starting the work. If a topographic map of the region is available, possible routes usually can be determined from it. When such a map is not in the possession of the locator a reconnaissance survey is necessary in order that a sketch map may be prepared showing the important topographic features, especially with reference to differential elevations, and to acquire a knowledge of any special field problems which may influence location.

A preliminary survey is made to enable the engineer to make a choice of one of the several possible routes. This work may be done satisfactorily with a transit using the needle for direction and taking stadia readings for distance and elevation. A topographer should accompany the party and make a sketch map of the territory for 100 feet or more on each side of the proposed line. The records made by the engineer should include, in addition to the instrumental data, complete notes on stream crossings, flume feeders, private holdings crossed and any other data that may have a bearing on the final construction of the flume. A map of the route, and a profile of the survey is prepared, following the completion of the preliminary survey.

The final survey must be made with accuracy, stakes being

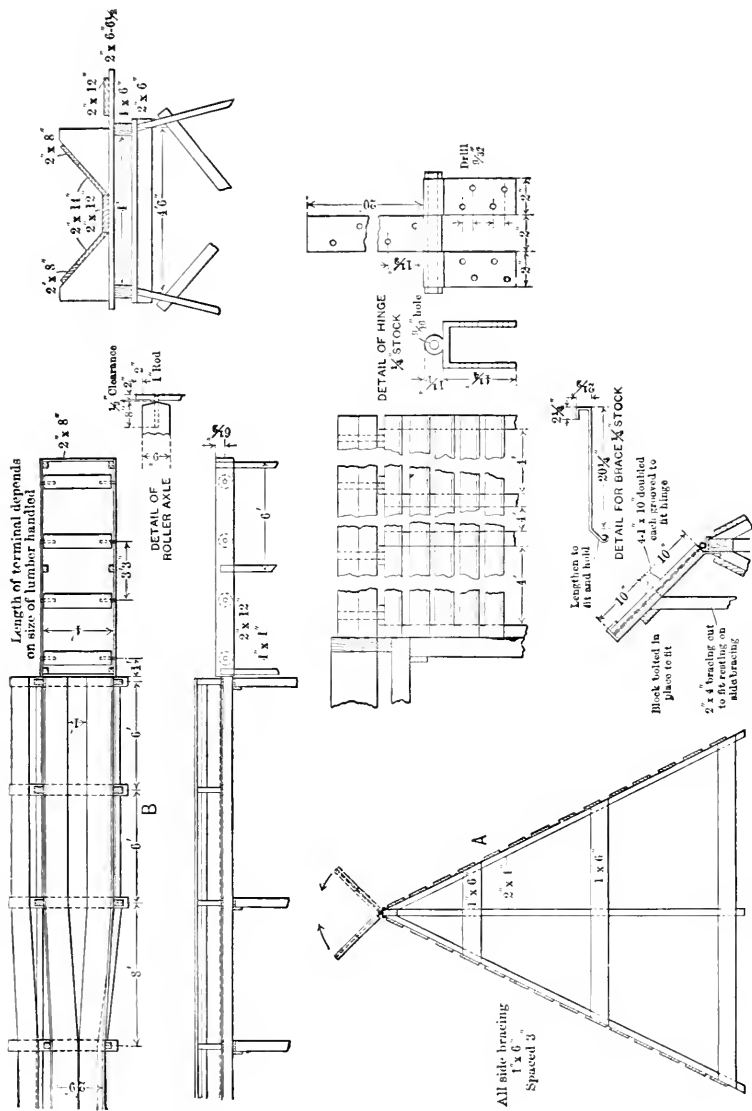

FIG. 163. — Two Types of Flume Terminals. A. For lumber. B. For crossies, heavy timbers, planks, and scantlings.

set as for a railroad survey and a line of levels established. The grade line having been determined from a profile map, it is established in the field.¹ Center stakes for the bents are established at determined intervals, and following this the grade stakes are set for the batter-post mud-sills. The data for the base of each trestle bent are calculated for the use of the con-

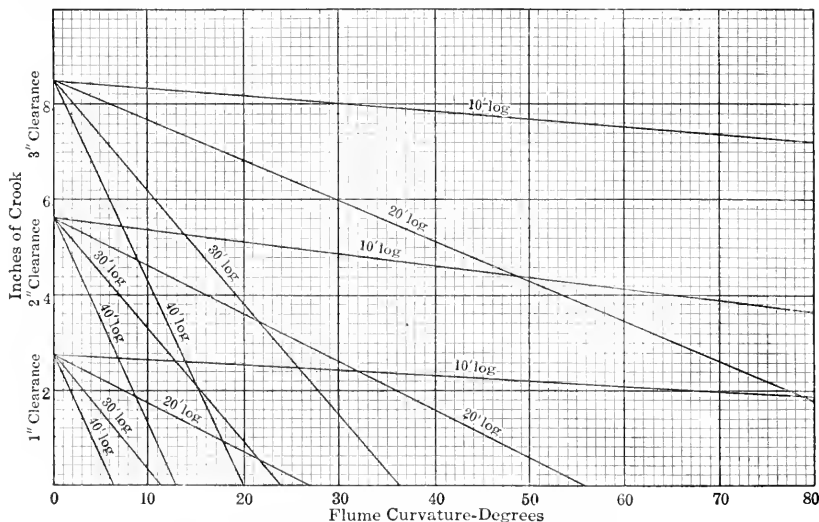

FIG. 164. — Graph Showing the Permissible Flume Curvature in Degrees for Logs of Given Lengths and Crook.

structors, and show the length of the two lower sash braces, the distance along the batter posts, and the length each batter post must extend below the first sash brace in order that the trestle may stand plumb on the mud-sill. The determination of the length of each sash brace is important because it governs the batter of the posts and if it is not properly calculated the spacing between the posts under the cap will vary.

Careful consideration must be given to curves and the maximum degree of curvature required for the longest material that is to be handled must be determined.

The relation of log lengths, both straight and crooked, and the permissible degrees of curvature are shown in Fig. 164.²

¹ The grade line of a flume is the cut-off height of the trestle bents, which is the base of the caps.

² From *The Design of Log Flumes*, by J. P. Martin, *Engineering News*, Nov. 14, 1912.

Curves at the base of steep grades should be avoided, because jams will form which will not only damage the flume but will also cause the lumber to leave it. The most desirable grades for a straight flume are 3 per cent or more. Grades up to 75 per cent may be used on short stretches, provided all sharp changes in elevation have properly proportioned vertical curves.

CONSTRUCTION

The general methods of constructing a V-flume may be illustrated by one built in Washington for the daily transport of 40,000 board feet of lumber and crossties which ranged in length from 8 to 32 feet.

The flume had a maximum height of 128 feet, maximum curves of 8 degrees, and a 3 per cent grade on the upper part and 0.66 per cent on the lower end. Lumber floated at an average rate of 3 miles per hour.

Bents were placed 15.75 feet apart for heights of 65 feet and under, and 23.5 feet apart for heights in excess of this. The batter posts on all trestles under 75 feet were spaced 4 feet apart at the cap, and for heights greater than this 5 feet. The batter in all cases was 1 in 4. In the bent construction only three sizes of lumber were used, namely, 1- by 6-inch, 2- by 6-inch, and 2- by 4-inch, the latter being used for the fore-and-aft bracing. As a rule only 16- and 24-foot lengths were used, because this simplified the work, reduced the time lost in handling, and very little lumber was wasted. A "select common" grade of lumber was used. The first 24-foot section of each bent was framed on the ground, the foot of each batter post being laid on or near the mud-sill on which it was to rest. Bracing was made from 1- by 6-inch and 2- by 6-inch material. When ready, the bent was hoisted in place, and set on the mud-sills by the aid of a block and tackle attached near the top of the nearest bent. When in position it was plumbed up and spiked to the mud-sill. A scantling 2 by 6 inches by 16 feet was then placed against the outside of each post and securely nailed to it with 20-penny spikes. Fore-and-aft braces (Fig. 160) were then nailed on until the top of the 16-foot post was reached when another 2- by 6-inch by 24-foot scantling was set on top of the first post with a lap of 16 feet on the inner one. More fore-and-aft braces were then placed. The addition of 2- by 6-inch by 24-foot scantlings

continued, with proper bracing, until the cut-off height was reached. On the 15.75-foot span a block and tackle was used on each batter post for elevating the material when the height became too great for handing it up. On the 23.5-foot span, lines also were hung on the rear bent to aid in raising the 24-foot fore-and-aft braces.

The cut-off point of the bent was established only when several hundred feet of trestle had been built. A wye level was then placed on a staging built on top of a bent and the line of levels established by it. The 2- by 6-inch caps were elevated and placed in position as soon as the posts were cut off. Cross-bracing was put on after several hundred feet of trestle was erected (Fig. 160). Bents exposed to the wind were also strengthened by wire guys.

The construction crew was made up of from six to eight men, four of whom worked aloft continuously. On low work one man handled and sent up all lumber and another was engaged in framing the lower sections.

The lumber was hauled as near as possible to the point where it was to be used, and was assorted and piled where it could be reached with the least delay. One man built the boxes in 16- or 24-foot sections at the upper end of the flume, placed the brackets inside each section, and placed it and the 4- by 6-inch stringers and the foot planks in the flume ready to float to the front. A man walked the flume and kept the material moving.

Two top men at the front placed the stringers and foot planks in position, trimmed the boxes, set them in place, adjusted the brackets and nailed them to the boxes. A crew of four men placed from twenty to twenty-five 16-foot sections in ten hours. This did not include an 8-inch top board on the box which was not added until the remainder of the flume box was complete.

The amount of labor required to erect a flume trestle increases rapidly with its height and the wages paid to top workers on high trestles also increase with the height above ground. Those working at elevations of 75 feet or more may receive from 40 to 60 per cent more than ground workers.

The number of days' labor, the pounds of nails and the thousands of board feet of lumber required to build trestles of specified heights and of the types shown in Figs. 160 and 161 are given in the Table VIII. The construction of the box and foot-boards re-

quired 68,485 board feet of lumber and approximately 2800 pounds of nails, per mile.

TABLE VIII
AMOUNTS OF LUMBER, NAILS AND DAYS' LABOR REQUIRED
TO CONSTRUCT LUMBER FLUME TRETTLES OF
VARIOUS HEIGHTS¹

	Height in feet							
	10	15	20	25	30	35	40	45
Lumber, board feet...	50	60	75	125	200	350	500	600
Nails, pounds.....	1.0	1.75	2.0	3.75	5.0	7.0	9.5	10.5
Labor, days.....	0.10	0.10	0.10	0.20	0.40	0.50	0.60	0.70

	Height in feet						
	50	55	60	65	70	75	80
Lumber, board feet...	750	1000	1300	1500	1750	2000	2150
Nails, pounds.....	12.0	17.0	20.5	25.0	31.0	35.0	40.5
Labor, days.....	1.00	1.30	1.60	1.90	2.30	2.70	3.10

	Height in feet						
	85	90	95	100	105	110	115
Lumber, board feet...	2350	2550	2750	3000	3250	3450	3850
Nails, pounds.....	47.0	51.0	57.0	61.5	76.0	90.0	112.0
Labor, days.....	3.90	4.8	5.5	6.25	7.00	7.70	9.00

¹ See Figs. 160 and 161.

The size and estimated quantity of lumber and the number of pounds of nails required to build a "V" flume of the type shown in Fig. 158D are given in Table IX. The trestle timbers are for an average height of 7 feet.

OPERATION

The amount of water required for a flume depends on the size of the box, the grade and the amount of leakage. On steep grades a flume requires less water than on low grades because

the flume box becomes a wet slide and the logs run freely with very little water. The age of the flume and the care with which it is maintained largely determine the amount of leakage. Forest Service officials found that on the Allen flume in Montana which



Photograph by H. H. Chapman.

FIG. 165. — A Log Flume entering a Tunnel by means of which it crosses the Continental Divide. The flume runner is holding back some of the mining timbers so that they will not jam in the tunnel. The grade here does not exceed 0.5 per cent. Montana.

carries from 5 to 12 second feet of water the leakage averaged 0.3 second feet per mile. They estimate that the average leakage in a flume in good condition carrying from 5 to 10 second feet of water will approximate 0.45 second feet per mile.

Water for flume operation is admitted from ponds or branch flumes at the head and also at numerous points along the route

by feeders, or troughs which are run from the main stream or some of its branches. If the water supply is limited, every effort is made to keep the flume box tight to prevent waste. This is not so essential, however, when water can be turned in at frequent intervals.

The products are placed in the flume boxes by various means. Sawed lumber and crossties are usually shunted into the flume from an incline at the tail of the mill. Pulpwood and acid wood are frequently rolled or thrown into the box from skidways or floated in from ponds; while logs may be rolled in from skidways, floated in from artificial storage ponds, or elevated by log loaders. The use of ponds is the simplest and cheapest method, while the use of a log loader is the more expensive.

Flumes are operated by crews that feed the flume; by runners who are stationed at points along the route where jams are apt to occur; and by laborers who handle the product at the terminal. The runners usually carry a pick-a-roon to handle the floating material. The size of crew required depends entirely on the character of the flume, those with many curves and low grades requiring the most runners.

On the Allen flume in Montana, which is about 16 miles long, thirty flume tenders were required for handling about 3500 mining stulls and logs daily. Four men fed the flume and twenty-six men patrolled it, the greater number being required where the flume crossed the Continental Divide on a very low grade.

On the American Gulch flume in the same section five men were required on a flume about one mile long the daily run on which averaged from 800 to 1100 mining stulls. Two men fed the flume and three men acted as patrols.

A box log-flume in Oregon, $3\frac{1}{2}$ miles long, has handled an average of 150,000 board feet daily, ten men being required to operate it.¹

NOTES TO CHAPTER XXIII

Page 436. A box flume $3\frac{1}{2}$ miles long for the transportation of logs has been used in Oregon. The problem confronting the operator was to transport timber out of a rolling plateau region down to a mill several miles distant. Owing to the rough character of the country the cost of railroad construction was prohibitive. The engineering problems encountered were not easy to solve because the water supply during the lowest stages did not exceed 100 miners' inches and ex-

¹ See note on page 450.

traordinary efforts had to be made to conserve it. Some canyons from which timber was to be transported had no available water in them and it was necessary to build the flume from one watershed to another to get the timber out.

The preliminary work consisted of a survey of the whole route and a very careful determination of the levels. The construction work was begun at the mill and carried forward each year as required to secure the requisite amount of timber. The first section of the flume was built nearly on a dead level, but as the work progressed a grade of 1 inch in 100 feet was given.

The natural gradient greatly exceeded that given to the flume and it was necessary to build the latter in three units, each ending in a V-shaped chute which led from the flume to a pond at a lower elevation. These ponds were about 75 by 100 feet in size and were located at points where the natural conditions favored their construction. They not only served as storage reservoirs for water and points for the change in grade of the flume but also as places for logs to enter the flume.

The grade line was kept as near the ground as possible in order to avoid expensive trestle work and cuts. However, some cuts could not be avoided and trestles had to be built when the flume crossed canyons or other depressions.

The flume box was constructed of 2- by 12-inch planks and was 6 feet wide and 4 feet deep, except on sharp curves where it was wider. The normal depth of the water was $3\frac{1}{2}$ feet. Trestles were built of sawed timbers and braces of the same sized timbers were placed along the box at 3-foot intervals. A running board extended along one side of the box for the use of flume tenders. Lumber for building the flume was cut in a portable mill which was kept as near the actual construction point as was practicable. This reduced the charge for transport of flume material. Each flume unit was provided with three lift gates suspended from the center of a beam which was supported by two upright posts placed on either side of the flume. One gate was used for the control of the water and the other two for emergency purposes. Should an accident happen to the gate in use, or a log become jammed in it, one or both of the others could be closed and a waste of water prevented. The gates were opened by lifting them with a lever until they cleared a 2-inch cleat nailed across the bottom of the flume when the force of the water raised them to a horizontal position. They were then supported by 2- by 4-inch joists, which were placed across the flume.

In the spring of the year an abundance of water was available and a slight current was created in the flume by keeping open a small extra gate. During this season the logs were floated loose and only an occasional man was needed to keep them moving and to prevent jams. In the summer and fall the water was at a low stage and the logs were dogged together in strings of from 50 to 75 (10,000 to 15,000 board feet) and were towed along the flume by a man who traveled the running board. The opening of the large gates also created an artificial current which assisted in keeping the logs moving. The tow was kept as near the gate as possible and when the latter was opened the logs were rushed through to get the maximum benefit from the accumulated head.

The flume was built at a cost of \$3,000 per mile and it was estimated that with minor repairs, it would last for fifteen years.

A 50-inch log, or two 30-inch logs, side by side, could be floated in the flume, except at the gates. The logs ran three to the thousand board feet, and the average daily capacity of the flume was 150,000 board feet. Twenty-four million board feet have been handled in seven and one-half months.

Page 441. The Allen flume had a 34-inch V-shaped box, the angle at the vertex being 63 degrees. The box was made of six boards 16 feet long, five of which were $2\frac{1}{2}$ by 11 inches, and the sixth $2\frac{1}{2}$ by 12 inches. The cracks were battened by 1- by 4-inch strips. A 6- by 6- by 6-inch backbone was fitted into the vertex. The box was supported on trestle work, composed of 4- by 4-inch uprights, braced diagonally with two 2- by 4-inch timbers, on top of which was a 4- by 4-inch cap. The trestles ranged in height from 2 feet to 72 feet, the longest one being 775 feet. The flume box was braced by 2- by 4-inch timbers placed against the sides of the box and supported by other timbers of the same size. These timbers rested on the caps.

Water was supplied both from a reservoir at the head, and by numerous flume feeders placed along the route which was about 15 miles in length.

The grade varied from 0.5 per cent to 12.5 per cent.

There were twenty rock cuts from 8 to 20 feet in depth and one tunnel 685 feet long.

The flume had a capacity of 3500 logs daily, an average of 116,000 board feet.

The fluming season was about five and one-half months.

Page 450. The American Gulch flume, approximately 1 mile in length, in the Deerlodge National Forest in Montana, had a 30-inch V-box which was chiefly supported on stringers laid on the ground. Very few trestles were constructed. The flume could handle mining stulls 15 inches in diameter and from 14 to 16 feet long. Thirty-three thousand board feet of lumber and 2755 pounds of nails were used in the construction of the box. Seven men built a mile of flume in twenty days.

BIBLIOGRAPHICAL NOTE TO CHAPTER XXIII

- MARTIN, J. P.: The Design of Log Flumes. *Engineering News*, Nov. 14, 1912, pp. 908-913.
- ROBERTSON, J. E.: The Log Flume as a Means of Transporting Logs. *The Timberman*, August, 1909, pp. 45-46.
- STARBUCK, W. D.: Flumes. *The Timberman*, August, 1912, pp. 42-44.
- STEEL, Francis R.: Lumber Flumes. *Bulletin of the Harvard Forest Club*, Vol. I, 1911.

APPENDIX
BIBLIOGRAPHY

BIBLIOGRAPHY

AERIAL TRAMS

- ANONYMOUS: A Newly Patented Aerial Logging Railway. Western Lumberman, Toronto, Ontario, Canada, December, 1912, pp. 40-41.
- ANONYMOUS: Heavy Duty Cable Tramway. The Timberman, Sept., 1914, pp. 31 and 32 B.
- FORSTER, G. R.: Das forstliche Transportwesen, Wien, 1888, pp. 242-250.
- FUJIOKA, M.: Notes on Aerial Wire Tramway. Tokyo, Japan, 1915.
- GAYER, KARL: Forest Utilization. (Schlieh's Manual of Forestry, 2nd. edit., pp. 346-352; translated from the German by W. R. Fisher.) Bradbury, Agnew and Company Ltd., London, 1908.
- JONES, T. P.: Experience with a Cable Tramroad. The Timberman, Oct., 1913, pp. 29 to 32.
- NESTOS, R. R.: Aerial Snubbing Device. The Timberman, Portland, Oregon, April, 1912, p. 49.
- NEWBY, F. E.: Handling Logs on Steep Ground with a Gravity Cable System. The Timberman, August, 1910, pp. 31-32.
- RILEY, F. C.: The Opsal Aerial System. The Timberman, Sept., 1914, pp. 33 and 34.
- ROGERS, C. G.: Note on the Setikhola Wire Ropeway. Indian Forester, Feb. 1902, Vol. XXVIII, No. 2, pp. 69-73.
- STEINBEIS, FERDINAND: Die Holzbringung im bayerischen Hochgebirge unter den heutigen wirtschaftlichen Verhältnissen, München, 1897, pp. 31-39.
- WETTICH, Hans: Moderne Transportanlagen im Dienste der Holzgewinnung und Holzindustrie. Centralblatt für das gesamte Forstwesen, Oct., 1912, pp. 451 to 460.

ANIMALS

- ALLEN, E. W.: The Feeding of Farm Animals. Farmers' Bul. No. 22, U. S. Dept. of Agriculture, Washington, 1901.
- DALRYMPLE, DR. W. H.: Economic Feeding of Work Animals used in Logging Operations. Lumber Trade Journal, Nov. 1, 1914.
- DALRYMPLE, DR. W. H.: Feeding Work Horses and Mules. Lumber Trade Journal, July 1, 1914.
- ENGINEER FIELD MANUAL, Parts I-VII. Professional Papers No. 29, Corps of Engineers, U. S. Army. Fifth (revised) edition, Washington, 1917, pp. 453-500.
- LANGWORTHY, C. F.: Principles of Horse Feeding. Farmers' Bul., No. 170, U. S. Dept. of Agriculture, Washington, 1903.

GENERAL

- BRANIFF, Edward A.: Scientific Management and the Lumber Business. *Forestry Quarterly*, Vol. X, No. 1, pp. 9-14.
- BRYANT, R. C.: *Lumber: Its Manufacture and Distribution*. John Wiley & Sons, Inc., New York, 1922.
- BUREAU OF THE CENSUS, DEPT. OF COMMERCE: *Lumber, Lath, and Shingles Fourteenth Census of the United States, Forest Products, 1919*. Washington, 1922.
- CARY, Austin: Influence of Lumbering upon Forestry. *Proceedings of the Society of American Foresters*, Vol. III, No. 1, Washington, D. C. 1908, pp. 66-81.
- CARY, Austin: *A Manual for Northern Woodsmen*. Published by Harvard University, Cambridge, Mass., 1918.
- DEFEBAUGH, J. E.: *History of the Lumber Industry of America. The American Lumberman*, Chicago, Illinois, Vol. II, 1907.
- FOREST SERVICE, U. S. DEPT. OF AGRICULTURE: *Timber Depletion, Lumber Prices, Lumber Exports and Concentration of Timber Ownership. Report on Senate Resolution 311*. Washington, 1920.
- GAYER, Karl: *Forest Utilization (Vol. V of Schlich's Manual of Forestry; trans. from the German by W. R. Fisher, second edition)*. London, Bradbury, Agnew & Co. Ltd., 1908.
- HALL, William L., and MAXWELL, Hu: *Uses of Commercial Woods of the United States: I. Cedars, Cyresses and Sequoias, Bul. 95; II. Pines, Bul. 99, U. S. Forest Service, Washington, D. C., 1911*.
- HEDGECOCK, George Grant: *Studies upon some Chromogenic Fungi which Discolor Woods*. Missouri Botanical Garden, St. Louis, Seventeenth Annual Report 1906, pp. 59-114.
- HOPKINS, A. D.: *Pinhole Injury to Girdled Cypress in the South Atlantic and Gulf States*. Cir. 82, U. S. Bur. of Entomology, Washington, 1907.
- HOPKINS, A. D.: *Waste and Reduction of Timber Supplies Caused by Insects, and Methods of Prevention and Control*. Report National Conservation Committee, Senate Doc. 676, Vol. II, 1909, pp. 469-497.
- KINNEY, J. P.: *Essentials of American Timber Law*. John Wiley and Sons, Inc., New York, 1917.
- LUMBER, LATH AND SHINGLES, 1910, U. S. Bureau of the Census, Washington, 1912.
- MORRELL, F. W.: *Factors Influencing Logging and Lumbering Costs in Colorado National Forests*. *Forest Club Annual, University of Nebraska, Lincoln, 1911, Vol. III, p. 7*.
- SCHENCK, C. A.: *Logging, Lumbering or Forest Utilization*. Darmstadt, Germany, 1912.
- SESSOMS, H. W.: *Systematic Logging Camp Records*. *The Timberman*, Portland, Oregon, July, 1911, pp. 33-36.
- THE AMERICAN LUMBER INDUSTRY. *Official Report Tenth Annual Meeting National Lumber Manufacturers' Association, Chicago, 1912*.
- THE LUMBER INDUSTRY. *Part I, Standing Timber, Report of the Bureau of Corporations, Department of Commerce and Labor, Washington, 1913*.

- VAN ORSDEL, John P.: Proper Type of Transportation in Logging. *The Timberman*, March 1923, pp. 42 and 43.
- VON SCHRENCK, Hermann: The "Bluing" and "Red Rot" of the Western Yellow Pine, with Special Reference to the Black Hills Forest Reserve. *Bul. No. 36, U. S. Bur. of Plant Industry, Washington, 1903.*

LABOR

- INDUSTRIAL ACCIDENT COMMISSION, CALIFORNIA: Logging and Sawmill Safety Orders, effective March 15, 1917. *The Timberman*, February, 1917, pp. 48 T to 48 X.
- INDUSTRIAL INSURANCE DEPARTMENT, STATE OF WASHINGTON: First Annual Report for the twelve months ending September 30, 1912. Olympia.
- PRATT, C. S.: Washington Workmen's Compensation Act is Successful in its Operation. *The Timberman*, August, 1912, pp. 74-77.
- SPARKS, J. W. and FOREST, E. H. T.: *The Lumbermen's Safety First-First Aid Manual.* Pub. for Industrial Dept., International Y. M. C. A., Association Press, New York.
- STATE SAFETY BOARD OF WASHINGTON: Safety Standards for Logging. *The Timberman*, April, 1920, pp. 45-48.
- U. S. DEPT. OF LABOR, BUREAU OF LABOR STATISTICS: Industrial Survey in Selected Industries in the United States, 1919, *Bul. No. 265.* Washington, May, 1920, pp. 348-356.
- U. S. DEPT. OF LABOR, BUREAU OF LABOR STATISTICS: Wages and Hours of Labor in the Lumber, Millwork and Furniture Industries, 1915. *Bul. No. 225.* Washington, 1918.
- U. S. DEPT. OF LABOR, BUREAU OF LABOR STATISTICS: Workmen's Compensation Laws of the United States and Foreign Countries, *Bul. No. 126,* Washington, December, 1913.
- U. S. DEPT. OF LABOR, BUREAU OF LABOR STATISTICS: Workmen's Compensation Legislation of the United States and Canada, *Bul. No. 272,* Washington, 1921.
- U. S. DEPT. OF LABOR: Description of Occupations, Logging Camps and Sawmills. Washington, 1918.

LOGGING CAMPS

- BEIN, F. L.: Refrigerating System for the Cook House. *The Timberman*, April, 1920 and Oct., 1920.
- COMMISSION OF IMMIGRATION AND HOUSING OF CALIFORNIA: Advisory Pamphlet on Camp Sanitation and Housing. San Francisco, 1914.
- GIBBONS, W. H.: Logging in the Douglas Fir Region. U. S. Dept. of Agriculture, *Bul. No. 711.* Washington, 1918, pp. 11 and 12.
- LIPSCOMB, Dr. W. N.: Logging Camp Sanitation. *The Timberman*, Nov., 1917, pp. 64G to 64I.
- RUEGNITZ, W. C.: Eliminating Waste in the Boarding House. *The Timberman*, Sept. and Nov., 1917.

- RUEGNITZ, W. C.: Standard System of Management of Mess Houses. Nov., 1921, pp. 34 to 38.
- SPRUCE PRODUCTION DIVISION, BUREAU OF AIRCRAFT PRODUCTION: Construction of Camp Kitchens and Mess Halls. The Timberman, Sept., 1918, p. 33.
- THARALDSEN, Thorfinn: Investigation of Feeding Operations. The Timberman, Oct., 1918, pp. 65 to 67.
- WASTELL, A. B.: A Logging Camp on Wheels. The Timberman, August, 1910, pp. 50-51.

LOGGING METHODS IN SPECIFIC REGIONS

Appalachians.

- ASHE, W. W.: Cost of Cutting Large and Small Timber. Southern Lumberman, December 16, 1916, p. 91.
- BOISEN, A. T., and NEWLIN, J. A.: The Commercial Hickories. Bul. 80, U. S. Forest Service, Washington, 1910, pp. 10-13.
- CHITTENDEN, Alfred K.: The Red Gum. Bul. No. 58, U. S. Bur. of Forestry, Washington, 1905, pp. 17-22.
- FOLEY, John: Conservative Lumbering at Sewanee, Tennessee. Bul. No. 39, U. S. Bur. of Forestry, Washington, 1903.
- ZON, Raphael: Management of Second-Growth in the Southern Appalachians. Cir. 118, U. S. For. Ser., Washington, 1907, pp. 8-15.

Coastal Plain.

- SHIELDS, R. W.: Logging in the Dismal Swamp. The Penn. State Farmer, Forestry Annual, Vol. IV, No. 1, May, 1911, p. 22-24.

Lake States.

- PAMEL, A. G.: Logging in Wisconsin. Forest Club Annual, 1909, University of Nebraska, Lincoln, pp. 66-70.

Northeast.

- ANONYMOUS: Camp Operations in Northern Ontario. Canada Lumberman and Woodworker, September, 1911, pp. 66-70.
- ANONYMOUS: Lumbering in New Hampshire. Biennial Report of the Forestry Commission, State of New Hampshire, for the years 1903-1904, Concord, 1904, pp. 98-102.
- BROWN, SIMMONS: Mechanical Log Haulers and their Development. Report of Third Annual Conference of the Woods Dept., Berlin Mills Co. et al, Berlin, New Hampshire, Nov., 1915.
- CARY, Austin: Practical Forestry on a Spruce Tract in Maine. Cir. 131, U. S. For. Ser., Washington, 1907, p. 8.
- CHITTENDEN, Alfred K.: Forest Conditions of Northern New Hampshire. Bul. No. 55, U. S. Bur. of For., Washington, 1905, pp. 76-79.
- DANA, S. T.: Paper Birch in the Northeast. Cir. 163, U. S. For. Ser., Washington, 1909, pp. 23-27.
- FOX, William F.: A History of the Lumber Industry of the State of New York. Bul. 34, U. S. Bureau of Forestry, Washington, 1902, p. 59.

- FROTHINGHAM, Earl H.: Second-growth Hardwoods in Connecticut. Bul. 96, U. S. For. Ser., Washington, 1912, pp. 20-23.
- HAWLEY, R. C., and HAWES, A. F.: Forestry in New England. John Wiley and Sons, Inc., New York, 1912. pp. 235-243.
- HOSMER, Ralph S., and BRUCE, Eugene S.: A Forest Working Plan for Township 40. Bul. No. 30, U. S. Div. of For., Washington, 1901, pp. 42-63.
- INNES, J. S.: Tractor Haulage. Canada Lumberman and Woodworker, July 15, 1922.
- SISSON, Stanley H.: Use of Tractors in Winter Log-hauling. Empire State Forest Products Association, Bul. No. 12. Albany, New York, Dec., 1921.
- WEIGLE, W. G., and FROTHINGHAM, E. H.: The Aspens; Their Growth and Management. Bul. 93, U. S. For. Ser., Washington, 1911, p. 10.
- WILLIAMS, Asa S.: The Mechanical Traction of Sleds. Forestry Quarterly, Vol. VI, pp. 354-362.

Southern Yellow Pine.

- CHAPMAN, C. S.: A Working Plan for Forest Lands in Berkeley County, South Carolina. Bul. No. 56, U. S. Bur. of For., Washington, 1905, pp. 29-30.
- CHAPMAN, H. H.: An Experiment in Logging Lingleaf Pine. Forestry Quarterly, Vol. VII, pp. 385-395.
- FOSTER, J. H.: Forest Conditions in Louisiana. Bul. 114, U. S. For. Ser., Washington, 1912, pp. 28-31.
- REED, Franklin W.: A Working Plan for Forest Lands in Central Alabama. Bul. No. 68, U. S. For. Ser., Washington, 1905, pp. 30-33.

Southwest.

- WOOLSEY, Jr., T. S.: Western Yellow Pine in Arizona and New Mexico. Bul. 101, U. S. For. Ser., Washington, 1911, p. 43.

West.

- ALLEN, E. T.: The Western Hemlock. Bul. No. 33, U. S. Bur. of For., 1902, pp. 28-30.
- BERRY, Swift: Notes on the Management of Redwood Lands. Proceedings of the Society of American Foresters, Vol. VI, No. 1, Washington, 1911, pp. 104-107.
- BRIGHAM, E. J.: Tractor Logging. The Timberman, Oct., 1920, pp. 86-87.
- BRUCE, Donald: The Relative Cost of Making Logs from Small and Large Timber. Dept. of Agriculture, Agricultural Experiment Station, University of California, Bul. 339, Berkeley, Cal., 1922.
- COOPER, Albert W.: Sugar Pine and Western Yellow Pine in California. Bul. No. 69, U. S. For. Ser., Washington, 1906, pp. 30-34.
- DRISSEN, J. P.: Time Study of Motor Truck Logging of Yellow Pine. The Timberman, August, 1921, p. 97.
- ECKBO, Nels B.: Logging in the Redwoods. Forestry Quarterly, Vol. VII, No. 2, pp. 139-142.

- GIRARD, James W.: Inland Empire Sawing and Skidding Studies. The Timberman, Sept., 1920, pp. 36 to 38.
- GIRARD, James W.: Tractor and Horse Skidding in the Inland Empire. The Timberman, Nov., 1922.
- GRAINGER, M. A.: Woodsmen of the West. E. Arnold, London, 1908.
- GREENAMYRE, H. H.: Lumbering in Colorado. Forest Club Annual, 1909, University of Nebraska, Lincoln, pp. 43-60.
- HALLETT, W. E. S.: Lumbering Cottonwood in Nebraska. Forest Club Annual, 1909, Univ. of Nebraska, Lincoln, pp. 35-38.
- HOFFMAN, Bruce: The Sitka Spruce of Alaska. Proceedings of the Society of American Foresters, Vol. VII, No. 2, pp. 232-235.
- KLOBUCHER, Frank J.: Tractor Skidding in the Inland Empire. The Timberman, July, 1922.
- KNAPP, F. M.: Motor Truck Logging Methods. Univ. of Washington, Engineering Experiment Station, Bull. No. 12, Seattle, 1921.
- MARGOLIN, Louis: The Hand Loggers of British Columbia. Forestry Quarterly, Vol. IX, No. 4, pp. 562-567.
- MASON, Fred R.: Study of Daily Production of Big Wheels. The Timberman, April, 1921, p. 39.
- MEIKLEJOHN, E. H.: Truck Logging. The Timberman, Oct., 1920, pp. 85-86.
- MURRAY, L. T.: Railroad Construction vs. Donkey Hauls. The Timberman, Nov., 1921, pp. 60-61.
- PEED, W. W.: Methods Employed and the Costs Incident to Logging Redwood. The Timberman, August, 1909, pp. 28-29.
- POLLEYS, E. G.: A Northern Idaho Lumbering Operation. The Forest Club Annual, 1910, Univ. of Nebraska, Lincoln, pp. 104-111.
- ROSS, Kenneth: Logging by Rail in Montana. The Timberman, August, 1912, p. 47.
- SPENSER, F. F.: Modern Sugar and Yellow Pine Operations in California. The Timberman, August, 1912, pp. 70-73.
- VAN ORSDEL, John P.: Plans for Motor Truck Logging. The Timberman, July, 1921, p. 97.

West Virginia.

- FARQUHAR, Henry H.: Cost of Mountain Logging in West Virginia. Forestry Quarterly, Vol. VII, pp. 255-269.
- ROTHKUGEL, Max: Management of Spruce and Hemlock Lands in West Virginia. Forestry Quarterly, Vol. VI, pp. 40-46.

LOGGING RAILROADS

Construction and maintenance.

- AMBURN, W. W.: Standardized Timber Bridge for Logging Railroads. The Timberman, February, 1919.
- AMBURN, W. W.: Three-purpose Pile Driver. The Timberman, Aug., 1920, p. 48A.
- AMBURN, W. W.: The Value of Drainage. The Timberman, Sept., 1920, p. 60.

- AMBURN, W. W.: Location and Construction of Branch Lines. The Timberman, Oct., 1920, pp. 58-59.
- ANONYMOUS: The Use of Explosives in Blowing Stumps. The Timberman, Dec., 1921, p. 128.
- BYRKIT, G. M.: Machine for Picking up Railroad Track. The Timberman, Portland, Oregon, August, 1912, p. 48.
- BYRNE, Austin T.: Highway Construction. John Wiley and Sons, Inc., New York, 1901.
- CORPS OF ENGINEERS, U. S. Army: Military Railways. Professional Papers, No. 32, Washington, 1917.
- COWLING, H. G.: Standard Frame Trestles for Logging Railroad. The Timberman, July, 1921, p. 34.
- CROSBY, Lloyd R.: Construction of Logging Railroad Tunnels. The Timberman, March, 1923, pp. 34-35.
- DAVIS, Minot: Steam Shovel in Logging Railroad Construction. The Timberman, Nov., 1921, pp. 66-67.
- ENGINEERS' HAND BOOK: Useful Information for Practical Men. Compiled for E. I. duPont de Nemours Powder Company, Wilmington, Delaware, 1908.
- FISH, J. L. C.: Earthwork Haul and Overhaul. John Wiley and Sons, Inc., New York, 1913.
- GILLETTE, H. P.: Handbook of Rock Excavation. McGraw Hill Book Co., New York, 1916.
- GILLETTE, H. P.: Earthwork and its Cost. McGraw-Hill Book Co., New York, 1912.
- GILLETTE, H. P.: Hand Book of Cost Data. Myron C. Clark Pub. Co., Chicago, 1910.
- JOHNSON, J. B.: Theory and Practise of Surveying. John Wiley and Sons, Inc., New York, 1901.
- KINDELAN, J.: The Trackman's Helper. Clark Book Co., New York, 1900.
- KLINE, C. W.: Logging Railroad Maintenance. The Timberman, March, 1923.
- LAMB, Frank H.: Steam Shovel in Logging Railroad Construction. The Timberman, Oct., 1920.
- MARTIN, C. S.: Steam Shovel in Logging Road Construction. The Timberman, Dec., 1919, pp. 65-66.
- NORBY, J. E.: The Norby Track-laying and Lifting Machine. The Timberman, Oct., 1919, p. 41.
- O'NEIL, W. J.: Logging Railroad Bridges. The Timberman, May, 1921, pp. 93-94.
- POPE, C. R.: Constructing a High Pile Bridge. The Timberman, Feb., 1915.
- POWERS, Fred W.: Preventing Track Creeping on Grades. The Timberman, Oct., 1919.
- SOMERVILLE, S. S.: Building Logging Railroads with a Pile-driver. The Timberman, August, 1909, pp. 37-38.
- STAMM, Samuel A.: A Unique Logging Railroad Bridge. The Timberman, July, 1916.

STEWART, D. E.: Combination Crane and Shovel in Road Work. The Timberman, May, 1920, p. 37.

Inclines.

CLARK, A. W.: Overcoming Grades too Steep for Geared Locomotives. The Timberman, Portland, Oregon, August, 1909, p. 33.

JACKSON, THOS. B.: Log Lowering Systems in the Inland Empire. The Timberman, July, 1923, pp. 36-37.

MACLAFFERTY, T. H.: Handling Logging Trains on Excessive Grades. The Timberman, July, 1911, p. 44.

POTTER, E. O.: Utilization of the Cable Locomotive. The Timberman, August, 1909, p. 34.

WENTWORTH, G. K.: Lowering Logs on a 3200-foot Incline. The Timberman, August, 1909, p. 34.

WILLIAMS, ASA S.: Logging by Steam. Forestry Quarterly, Vol. VI, pp. 19-21.

Loading and unloading log cars.

ANONYMOUS: Swinging "Gill-poke" Unloader. The Timberman, Portland, Oregon, Oct., 1909, p. 23.

EVENSON, O. J.: An Improved Log-loading System. The Timberman, August, 1912, p. 52.

GIBBONS, W. H.: Logging in the Douglas Fir Region. U. S. Dept. of Agriculture, Bul. 711. Washington, 1918, pp. 229-238.

O'GORMAN, J. S.: Unloading Log Cars with a Stationary Rig. The Timberman, August, 1909, p. 48.

O'HEARNE, James: Tilting Log Dumps. The Timberman, August, 1912, pp. 68-69.

VAN ORSDEL, John T.: Cableway Loading System. The Timberman, July, 1911, p. 46.

Location.

ELLIS, L. R.: Necessity for an Accurate Topographic Map in Logging Operations. Timberman, July, 1911, pp. 49-53.

HENRY, H. P.: Advantages of Topographic Surveys and Logging Plans. The Timberman, August, 1912, pp. 65-67.

PEED, W. W.: Necessity for the Logging Engineer in Modern Logging Operations. The Timberman, August, 1910, pp. 47-49.

RANKIN, R. L.: Practical Topographical Surveys for Building Logging Roads. The Timberman, March, 1912, p. 27.

VAN ORSDEL, John P.: Topographic Survey and its Economic value in Logging Operations. The Timberman, August, 1910, p. 64.

VAN ORSDEL, John P.: How to Obtain the Highest Practical Efficiency in Woods Operations. The Timberman, Sept., 1910, pp. 48-51.

WOOD, A. B.: Accurate Topographic Map is a Good Investment in Logging Operations. The Timberman, August, 1912, p. 67.

Motive power and rolling stock.

- CORPS OF ENGINEERS, U. S. ARMY: Military Railways. Professional Papers, No. 32, Washington, 1917.
- EARLE, Robert T.: Adaptability of the Gypsy Locomotive for Logging Purposes. *The Timberman*, August, 1910, pp. 34-35.
- EVANS, W. P.: The Mallet Locomotive in the Field of Logging Operations. *The Timberman*, August, 1910, pp. 61-64.
- HARP, C. A.: The Gasoline Locomotive and its Availability for Logging Roads. *The Timberman*, August, 1910, pp. 57-58.
- IVES, J. F.: Utilization of Compressed Air on Logging Trucks. *The Timberman*, August, 1910, p. 60.
- IVES, J. F.: Fuel Oil as a Substitute for Wood and Coal in Logging. *The Timberman*, August, 1909, p. 39.
- RUSSELL, C. W.: Utilization of Air on Logging Trucks. *The Timberman*, August, 1910, p. 58.
- TATE, M. K.: Locomotive Maintenance. *American Lumberman*, July 15, 1922.
- TURNER, Harry: Adjustable Air-brake Equipment for the Control of Detached Trucks. *The Timberman*, August, 1912, p. 54.

POWER LOGGING

- BARTON, W. L.: The Barton Skyline Logging System. *The Timberman*, Oct. 1921, p. 44, and Nov., 1921, pp. 59-60.
- BERRY, E. J.: Advantages Accruing to the Adoption of Electricity in Logging. *The Timberman*, August, 1912, pp. 32-33.
- BOURNS, R. T.: Lawson Overhead Yarding and Loading System. *The Timberman*, Oct., 1920, pp. 55-58.
- COLE, C. O.: Difficulties Confronting Electric Log Haulage. *The Timberman*, August, 1912, pp. 36-37.
- DICKINSON, M. H.: Single Main Cable Logging. *The Timberman*, Nov. 1921, p. 96C.
- FOREST SERVICE, U. S. Dept. of Agriculture: High-lead Logging in California Pine. *The Timberman*, Jan., 1922, pp. 38-39.
- FRINK, Francis G.: Washington High-lead. *The Timberman*, Sept., 1915.
- GASKILL, E. A.: Power Logging Equipment and Methods. *American Lumberman*, May 7, 1921, pp. 73-74.
- GRAMMER, E. S.: Evolution of the Logging Donkey. *The Timberman*, Nov., 1921, pp. 57-58.
- GRAY, R. E.: Electricity in the Lumber and Logging Industries. *The Timberman*, Oct., 1920, pp. 63-64.
- GRAY, R. E.: Progress in Electric Logging. *The Timberman*, Nov., 1921, pp. 62-64.
- HINE, Thomas W.: Utility of the Duplex Logging Engine and the Duplex System of Yarding. *The Timberman*, August, 1910, pp. 36-37.
- KALB, Henry A.: Utilization of Compressed Air for Snubbing Logs. *The Timberman*, August, 1912, p. 53.

- MCGIFFERT, J. R.: Development of Cableway Skidder. *American Lumberman*, Oct. 22, 1921, p. 56.
- MEREEN, J. D.: Substitution of Electricity for Steam in Modern Logging Operations. *The Timberman*, August, 1912, pp. 29-30.
- MURRAY, L. T.: Changes in Types of Donkey Engines. *The Timberman*, Nov. 1922, pp. 50-52.
- POWERS, F. W.: Utilizing One Spar Tree for Two Skylines. *The Timberman*, Nov., 1921, p. 34.
- STIMSON, Chas. W.: Adoption of the Lidgerwood Skidder System (cableway) in Logging Fir Timber. *The Timberman*, August, 1909, pp. 56-57.
- TAYLOR, W. S.: Different Stages in the Evolution of Overhead System of Logging. *The Timberman*, Jan., 1914, pp. 30-31.
- THOMPSON, Jas. R.: Use of Electricity on Logging Operations. *The Timberman*, August, 1910, p. 64L.
- VINNEDGE, R. W.: A Composite Flying Machine. *The Timberman*, Oct., 1913, pp. 33-36.
- VINNEDGE, R. W.: Overhead Logging Systems. *The Timberman*, Nov., 1922, pp. 45 to 49.
- WILLIAMS, Asa S.: Logging by Steam. *Forestry Quarterly*, Vol. VI, No. 1, pp. 1-33.
- WIRKKALA, Oscar: The Wirkkala Slack Line System. *The Timberman*, Nov., 1921, pp. 58-59.

SLIDES

- FANKHAUSER, Dr.: Rieswege in dem Ostalpen. *Schweizerische Zeitschrift für Forstwesen*, March and April, 1906, pp. 69-77 and 113-122.
- FORSTER, G. R.: *Das Forstliche Transportwesen*. Verlag von Moritz Perles, Wien, 1888, pp. 45-68.
- GAYER, Karl: *Forest Utilization* (Schlieh's Manual of Forestry, Vol. V; trans. by W. R. Fisher). Bradbury, Agnew and Company, Ltd., London, 1908, pp. 316-322.
- KUBELKA, August: Der Riesweg als Holzbringungsanstalt des Hochgebirges. *Centralblatt für das gesamte Forstwesen*. Wien, Aug.-Sept., 1903, pp. 325-377.
- SCHÖNWIESE, Heinrich: Die Wegriesen im Reichforste Cadino. *Centralblatt für das gesamte Forstwesen*, Aug.-Sept., 1903, pp. 377-387.
- STODDARD, E. I.: Chute Logging in Eastern Oregon. *The Timberman*, July, 1920, p. 35.
- VON ALMBURG, Dr. F. Angerholzer: Beitrag zur Kenntnis der dynamischen Vorgänge beim Abriesen des Holzes in Holzriesen. *Centralblatt für das gesamte Forstwesen*, April, 1911, pp. 161-179.

STANDING TIMBER IN THE UNITED STATES

- BRADFIELD, Wesley: *Standing Timber in Wood Lots*. Report of the National Conservation Commission, Senate Document No. 676, 60th Congress, 2nd Session, Vol. II, 1909, pp. 181-187.

- FOREST SERVICE, U. S. DEPT. OF AGRICULTURE: Timber Depletion, Lumber Prices, Lumber Exports and Concentration of Timber Ownership. Report on Senate Resolution 311. Washington, 1920.
- HOMANS, G. M.: Standing Timber in Possession of the Federal Government. Report of the National Conservation Commission, Sen. Doc. No. 676, Vol. II, 1909, pp. 192-195.
- KELLOGG, R. S.: Original Forests. Report of National Conservation Commission, Sen. Doc. 676, 60th Congress, Vol. II, 1909, pp. 179-180.
- PETERS, J. Girvin: Standing Timber Owned by the States. Report National Conservation Commission, Senate Document 676, Vol. II, 1909, p. 191.
- SMITH, Herbert Knox: Stand of Timber. Report of National Conservation Commission, Sen. Doc. 676, Vol. II, 1909, pp. 188-190.
- THE LUMBER INDUSTRY: Part I, Standing Timber. Bureau of Corporations, Dept. of Commerce and Labor, 1913.
- ZON, Raphael and SPARHAWK, W. N.: Forest Resources of the World. McGraw-Hill Book Co., Inc., New York, 1923.

WASTE IN LOGGING

- BRYANT, R. C.: The Close Utilization of Timber. Bul. 2, Part 2, Yale Forest School, New Haven, Conn., 1913.
- CARY, Austin: Practical Forestry on a Spruce Tract in Maine. Cir. 131, U. S. For. Service, pp. 5-6.
- CLAPP, Earle H.: Conservative Logging. Report of the National Conservation Commission, Senate Document No. 676, 60th Congress, 2nd session, 1909, pp. 512-546.
- LAUDERBURN, D. E.: Elimination of Waste in Logging. Paper Trade Journal, New York, February 20, 1913, pp. 189-199.
- PETERS, J. Girvin: Waste in Logging Southern Yellow Pine. Yearbook, U. S. Dept. of Agriculture, 1905, pp. 483-494.
- RECKNAGEL, A. B.: Waste in Hardwood Logging. Journal, New York State Forestry Asso., Vol. 3, Jan., 1916, pp. 10-11.
- UPSON, A. T.: Waste in Logging and Milling in Colorado. The Forest Club Annual, 1910, University of Nebraska, Lincoln, pp. 66-77.

WATER TRANSPORT

Flumes.

- MARTIN, J. P.: The Design of Log Flumes. Engineering News, Nov. 14, 1912, pp. 908-913.
- ROBERTSON, J. E.: The Log Flume as a Means of Transporting Logs. The Timberman, August, 1909, pp. 45-46.
- STARBIRD, W. D.: Flumes. The Timberman, August, 1912, pp. 12-14.
- STEEL, Francis R.: Lumber Flumes. Bulletin of the Harvard Forest Club, Vol. I, 1911

Streams.

- ANONYMOUS: Davis Ocean-going Log Raft. West Coast Lumberman, Dec. 15, 1917, pp. 28 and 29.
- BARROWS, H. K. and BABB, C. C.: Log Driving and Lumbering. Water Resources of the Penobscot River, Maine. Water Supply Paper 279, U. S. Geological Survey, Washington, 1912, pp. 211-220.
- BRIDGES, J. B.: Definition of the Law Governing the Use of Driving Streams. The Timberman, August, 1910, pp. 64F and 64G.
- BRIDGES, J. B.: Laws Governing the Use of Streams for Logging Purposes (Pacific Coast). The Timberman, August, 1909, pp. 49-51.
- FASTABEND, JOHN A.: Ocean Log Rafting. The Timberman, August, 1909, pp. 38-39.

TERMS USED IN LOGGING

TERMS USED IN LOGGING¹

[Letters in parentheses following definitions indicate the forest regions (see Fig. 1) in which the terms as defined are used.

- (Gen.) = General = In all forest regions of the United States.
- (C. H. F.) = Central Hardwood Forest.
- (N. F.) = Northern Forest.
- (App.) = Appalachian Forest.
- (L. S.) = Lake States Forest.
- (N. W.) = North Woods.
- (S. F.) = Southern Forest.
- (R. M. F.) = Rocky Mountain Forest.
- (P. C. F.) = Pacific Coast Forest.
- (E. C.) = Eastern Canada.
- (Cal.) = California.

In a few instances very local terms are ascribed to a State instead of to a forest region.]

Acid wood. Wood suitable for the manufacture of wood alcohol and other products of distillation. (N. F., App.)

Aerial line. *See* Skyline.

Aerial skidder. *See* Cableway skidder.

Alder grab. The stem of an alder, or other small tree, which is bent over and plugged into a hole bored in a boom stick, or secured in some other way, to hold a boom or logs inshore. (N. F.)

Alley, n. *See* Dingle.

Alligator, n. 1. A boat used in handling floating logs. It can be moved overland from one body of water to another by its own power, usually applied through drum and cable. (N. W., L. S.)

2. *See* Go-devil.

Anchor line. A line attached to a small buoy and to one fluke of an anchor used in towing a raft of logs. It is employed to free the anchor when fast to rocks or snags. (N. F.)

Angle bar. A steel plate with a flange base, having from four to six holes, through which bolts may be inserted. Two angle bars are used to hold steel rails together at the joints, one angle bar being placed against each side of the web and both bolted to it. (Gen.)

Apron, n. 1. A platform projecting downstream from the sluiceway of a dam to launch well into the stream logs which pass through the sluiceway. (Gen.)

2. A platform built of timbers at the foot of a slide, which guides in the desired direction logs leaving the slide. (Gen.)

Ark, n. *See* Wanigan.

At the base. When referring to the diameter of standing timber, a term used in timber contracts, meaning at the ground as contrasted with the usual

¹ From Forest Terminology, Part II. Terms used in the Lumber Industry. Prepared by the Author as Chairman of a Committee of the Society of American Foresters.

- custom of measuring at the stump. (Supreme Court of North Carolina, 54 Southeastern Reporter, 844.)
- Backbone, n.** A triangular piece of wood which is placed in the apex of a V-box flume. (Gen.)
- Backing chain.** A chain used to prevent logging trucks from sliding under the logs. It is used chiefly on long trains where there is a great strain. (P. C. F.)
- Back line.** *See* Haul back.
- Back-spiker, n.** One of the members of a crew which completes the spiking of rails to crossties after the track has been laid by the steel gang. (Gen.)
- Bag boom.** An open "limber" boom used to impound logs at the mouth of a stream emptying into a lake or similar body of water. The ends of the boom are made fast to the shore below the mouth of the stream, and when the boom is filled the ends are brought together and closed, forming a round boom. (L. S.) *See* Round boom.
- Ballhooter, n.** One who rolls or slides logs down a hillside. (App.)
- Bank, v.** *See* Bank up, to.
- Bank, n.** 1. *See* Landing.
2. The logs cut or skidded in one day above the required amount and held over by the saw crew or skidders, to be reported when the required daily number is not reached. (N. F.)
- Banking ground.** *See* Landing.
- Bank up, to.** To pile up logs on a landing. (Gen.)
Syn.: bank, roll up.
- Baptist cone.** *See* Cap.
- Barge boom.** A boom, the upstream end of which is attached to a barge anchored in the stream. It is used on navigable streams (on which permanent works are not permitted) in combination with a fin boom to divert logs from one side of a stream to the other. (S. F.)
- Bark drag.** *See* Ranking jumper.
- Barker, n.** 1. One who peels bark in gathering tanbark. (Gen.)
Syn.: peeler, spudder.
2. A machine used to remove bark from pulpwood.
3. *See* Rosser, 1.
- Barking iron.** *See* Spud.
- Bark ladder.** A platform mounted on a wagon or sled and used in hauling tanbark. (N. F.)
- Bark mark.** A symbol chopped into the side of a log to indicate its ownership; when used with the end mark it serves as an additional means of identification. (Gen.) *See* Mark.
Syn.: catch mark (L. S.), side mark (N. F.), contramarque (E. C.).
- Bark marker.** One who cuts the bark mark on logs. (Gen.)
- Bark rack.** A frame used to hold bark on a sled. (N. W.)
- Bark slide.** A V-shaped trough used on steep hillsides to slide tanbark down to the roads. (N. F.)
- Barn boss.** One who has charge of the stables in a logging camp. (Gen.)
Syn.: feeder. (N. W.)
- Barndoor gate.** In a logging dam sluiceway, a swinging door attached by

- hinges to the side of the sluice so that it can be swung across the opening to prevent the outflow of water. (Gen.)
- Batch, n.** A raft of lumber composed of a number of units. (S. F.)
- Batten, n.** A log less than 11 inches in diameter, inside bark, at the small end. (Maine.)
- Battery, n.** Two or more road engines for dragging logs, set at intervals on a long skid road. A "side" may include a "battery," which in turn may include a roader, a "half-breed" and a yarding donkey. The term is not commonly used. (P. C. F.)
- Bean house.** The foreman's office at a depot camp. (E. C.)
- Beaver, n.** See Swamper; Woodpecker.
- Becket, n.** 1. A large hook formerly used in loading logs on cars by means of tackle. It is now seldom used. (P. C. F.)
2. An eye or grommet in a rope through which another rope or cable may play. (Gen.)
- Bed a tree, to.** To level up the path in which a tree is to fall, so that it may not be shattered. (P. C. F.)
- Bicycle, n.** See Trolley.
- Bigness scale.** See Full scale.
- Big wheels.** See Logging wheels.
- Billet, n.** A short, round section of a log. (Gen.)
- Binder, n.** A springy pole used to tighten a binding chain. (Gen.)
Syn.: jim binder.
- Binding chain.** A chain used to bind together a load of logs. (Gen.)
Syn.: wrapper chain. (N. F.)
- Binding logs.** Logs placed on the top of the chain binding a load, in order to take up the slack. (Gen.)
- Birl, v.** To cause a floating log to rotate rapidly by treading upon it. (Gen.)
- Bitch chain.** 1. A short, heavy chain with hook and ring, used to fasten the lower end of a gin pole to a sled or car when loading logs. (N. F.)
2. A short, heavy chain connecting the main line and the haul back line of a yarding donkey, also serving as a point of attachment for the tackle fastened to the logs. When a cable is used instead of a chain, it is known as a bitch line.
Syn.: butt chain, butt line. (P. C. F.)
- Bitch line.** See Bitch chain, 2.
- Black cypress.** A term used by woodsmen to denote cypress timber of heavy weight. (S. F.)
- Blaze, v.** To mark, by cutting into trees, the course of a boundary, road, trail or the like. (Gen.)
Syn.: spot. (N. W.)
- Block, n.** 1. A pulley of several types used in power logging to change the direction of haul, or to increase the pulling power. (P. C. F.)
2. See Brail.
- Block-and-whip.** An arrangement of a cable and block, to secure added power for moving logs. The free end of the main cable, bearing a swamp hook, is passed through a block fastened to the log to be moved, and then attached to a stump. When a log has been pulled ahead as far as practi-

- able, the cable and swamp hook are moved forward to another stump. (P. C. F.) *See* Block hold.
- Block hold.** An arrangement of cables and blocks to secure added power for moving logs. The free end of the main cable is passed through a block attached to the log to be moved, and then fastened to some stationary object. Power is then applied to the opposite end of the cable. Two blocks and three blocks respectively are attached to the object to be moved. (P. C. F.) *See* Block-and-whip.
Syn.: one-block hold.
- Block tender.** *See* Chaser.
- Blow, n.** A break in a dam, usually at the base, due to the lack of proper toe piling. (N. W.)
- Blow down.** *See* Windfall.
- Blue jay.** *See* Road monkey.
- Bluing, n.** The result of fungus attack, which turns the sapwood of certain trees blue. (Gen.)
- Board foot.** A unit of measure in the lumber trade. It is a section 12 by 12 inches in size and 1 inch thick, or its equivalent. (Gen.)
- Board up, to.** To place a spring board in position. (P. C. F.)
- Bob, n.** A single pair of sled runners on which the forward ends of logs are loaded. (L. S., N. W.)
Syn.: sloop. (E. C.)
- Bobber, n.** *See* Deadhead.
- Bob logs, to.** To transport logs on a bob or dray. (N. F.)
- Body wood.** Cord wood cut from those portions of the stems of trees which are clear of branches. (N. F.)
- Bolster, n.** *See* Bunk.
- Bolt, n.** A segment sawed or split from a short log. A term usually applied to blocks from which shingles, staves and vehicle stock are manufactured. (Gen.)
Syn.: shingle bolt, stave bolt, spoke bolt.
- Boom, n.** Logs or timbers fastened together end to end and used to hold floating logs. The term sometimes includes the logs inclosed, as a boom of logs. (Gen.)
- Boomage, n.** Toll for use of a boom. (Gen.)
- Boom buoy.** *See* Boom stay.
- Boom chain.** A short chain which fastens boom sticks end to end. (Gen.)
- Boom Company.** A corporation engaged in handling floating logs, and owning booms and booming privileges. (N. F.)
- Boom pin.** A wooden plug used to fasten to boom sticks the chain, rope, or withe which holds them together. (Gen.)
- Boom rat.** One who works on a boom. (N. F.)
- Boom stay.** A heavy weight used to anchor booms in deep water; its position is indicated by a pole or float attached to it. (N. F.)
Syn.: boom buoy.
- Boom stick.** A timber which forms part of a boom. (Gen.)
- Bottle butted.** *See* Swell butted.

- Bottom, n.** The lower tier or layer of logs in a joint, usually fastened together by boom poles and pins. (E. C.)
- Bottom loader.** See Ground loader.
- Bottom sill.** See Mudsill.
- Bow man.** A log driver who sits in the forward end of a bateau.
- Box, v.** See Notch.
- Box, n.** See Undercut.
- Bracket boom.** A stiff boom, three or four logs wide, the logs being fastened together by short boards placed crosswise and spiked, or by transverse poles fastened with wooden pins, withes, chains, or spikes. (Gen.)
- Bracket gate.** See Needle gate.
- Brail, v.** To fasten logs in brails.
- Brail, n.** A section of a log raft, six of which make an average tow. (L. S.)
Syn.: block. (S. F.)
- Brake sled.** A logging sled so constructed that, when the pole team holds back, a heavy iron on the side of each runner of the forward sled is forced into the roadbed. (N. F.)
- Brand, n.** See Mark.
- Break in a landing, to.** To roll logs from the landing into a stream. (R. M. F.)
- Break out, to.** 1. To start a sled whose runners are frozen to the ground. (N. W., L. S.)
2. To open a logging road after heavy snowfall. (N. W., L. S.)
- Breastwork log.** See Fender skid.
- Briar, n.** A cross-cut saw. (Gen.)
- Bridle, n.** 1. A device for controlling the speed of logs on a skid road. It consists of a short rope with two hooks at one end, which are driven into the first log of the turn; at the other end is a clamp which runs over the cable. (P. C. F.)
2. A device for controlling the speed of logging sleds. It is a chain or clevis placed around the forward end of the rear sled runners. (N. W.)
- Bridle man.** One who follows a turn of logs down the skid road and tends the "bridle." (P. C. F.)
- Broadleaf, a.** See Hardwood.
- Brow, n.** See Landing.
- Brow skid.** 1. The chief beam in a frame to which tackle for loading logs on cars is fastened when a gin-pole is not used. (P. C. F.)
Syn.: draw skid, lead log.
2. A large log, placed parallel with the railroad track, which forms the front part of a landing used for loading logs upon cars. (P. C. F.)
- Brush.** See Slash.
- Brush a road, to.** To cover with brush the mudholes and swampy places in a logging road, to make it solid. (N. F.)
- Brusher, n.** On an operation where stave bolts are being made, one who cuts and piles limbs from felled trees. (S. F.)
- Brush out, to.** To clear away the brush from a survey line, gutter road or other logging road. (Gen.)
Syn.: bush out, to.

- Brush snow fence.** A snowbreak to protect a logging road; used most commonly on wide marshes. It consists of brush which is set upright in the ground before it freezes. (N. F.)
- Brutting crew.** A crew which rolls logs down slopes too steep for teams. (App.)
- Buck, n.** *See* Chore boy.
- Buck, v.** 1. To saw felled trees into logs. (P. C. F.)
 2. To bring or carry, as to buck water or wood. (Gen.)
 3. In hewing half-moon crossties, the stick of timber is hewed to a proper size and then "bucked" or split into two pieces. (S. F.)
- Bucker, n.** 1. One who saws felled trees into logs. (P. C. F.) Syn.: cross cutter (P. C. F.), log maker (S. F.).
 2. One who brings or carries. *See* Buck.
- Bucking board.** A spring board used in bucking large timber. (P. C. F.)
See Spring board.
- Bucking chute.** A short pole chute at a landing, in which long logs are bucked before loading. (Cal.)
- Buck swamper.** *See* King swamper.
- Buckwheat, v.** *See* Hang up, to.
- Buckwheater, n.** A novice at lumbering. (Gen.)
- Buggy, n.** *See* Trolley.
- Bull block.** A large yarding block having a throat of sufficient width to allow a choker and butt chain to pass through it. (P. C. F.)
 Syn.: butt chain block, jumbo, lead block, Tommy Moore.
- Bull bucker.** *See* Saw boss.
- Bull chain.** A chain wrapped around the first log of a turn in order to check the speed. (App.)
- Bull cook.** *See* Chore boy.
- Bull donkey.** *See* Roader.
- Bull load.** A turn of logs ready for hauling with a road engine. (P. C. F.)
- Bully, n.** *See* Camp foreman.
- Bummer, n.** A small truck with two low wheels and a short pole, used in skidding logs. (N. F., S. F.)
 Syn.: dolly (L. S., R. M. F.), drag cart, self-loading skidder, skidder.
- Bunch, v.** To skid logs together at some convenient point for wagon or cart hauling. (Gen.)
- Bunch load, to.** To encircle several logs with a chain and load them at once, by steam or horse power. (N. F.)
- Bunch logs, to.** To collect logs in one place for loading. (Gen.)
- Bunch team.** A team used to bunch logs. (Gen.)
- Bunk, v.** To place upon the bunks, as to "bunk a log." (Gen.)
- Bunk, n.** 1. The heavy timber upon which the logs rest on a logging sled. (N. F.)
 Syn.: bolster.
 2. The cross beam on a log car or truck, on which the logs rest. (Gen.)
 3. A log or truck. (S. F., P. C. F.)
 4. A logger's bed in a lumber camp. (Gen.)
- Bunk chain.** *See* Toggle chain.

- Bunk hook.** The hook attached to the end of the bunk on a logging car, which may be raised to hold the logs in place or lowered to release them. (Gen.)
- Bunkhouse, n.** The sleeping quarters of a logging crew. (Gen.)
- Bunk load.** A load of logs not over one log deep; *i.e.*, in which every log rests on the bunks. (Gen.)
- Bunk spikes.** Sharp spikes set upright in the bunks of a logging sled to hold the logs in place. (N. F.)
- Burton, n.** In logging, a tackle composed of two or more blocks which is used to increase the hauling power of the pulling line. The log is attached to a block in the bight of the running part. (P. C. F.)
- Bush a road, to.** To mark the route of a logging road across a marsh or the ice by setting up bushes. (N. F.)
- Busher, n.** *See* Swamper.
- Bush monkey.** One who piles tanbark. (Cal.)
- Bush out, to.** *See* Brush out, to.
- Butt, n.** The base of a tree, or the big end of a log. (Gen.)
- Butt chain.** *See* Bitch chain.
- Butt chain block.** *See* Bull block.
- Butt cut.** 1. The first log above the stump. (Gen.)
Syn.: butt log. (Gen.)
2. In gathering tanbark, the section of bark taken from the butt of a tree before felling it for further peeling. (N. F.)
- Butt hook.** The hook by which the cable is attached to the tackle on the logs. (P. C. F.)
- Butt line.** *See* Bitch chain.
- Butt log.** *See* Butt cut.
- Butt off, to.** 1. To cut a piece from the end of a log on account of a defect. (Gen.)
Syn.: long butt, to. (P. C. F., App., N. W.)
2. To square the end of a log. (N. F.)
- Buttress, n.** A wall or abutment built along a stream to prevent the logs in a drive from cutting the bank or jamming. (Gen.)
Syn.: crib. (App.)
- Butt team.** *See* Wheelers; Snub-yoke.
- Cableway skidder.** A power skidding device, a distinguishing feature of which is a main cable, suspended between a head spar tree and a tail tree, on which the trolley travels which wholly or partially elevates the logs from the ground. (Gen.)
Syn.: aerial skidder, flying machine. (P. C. F.)
- Cache, n.** A storehouse for logging camp supplies. (E. C.) *See* Headquarters.
- Camboose, n.** A fireplace in the center of the early logging camps of Eastern Canada, which served both for cooking and for heating purposes. (E. C.)
- Camp car.** A flat car equipped with seats and used to haul loggers back and forth between camp and the logging operation. (P. C. F.)
Syn.: cattle car, mulligan ear. (P. C. F.)

- Camp foreman.** One who has charge of a logging camp and the logging operations conducted from that camp. (Gen.)
Syn.: bully (N. F.), push (P. C. F.), twister (App.), shanty boss (E. C.).
- Camp inspector.** A lazy lumberjack, who goes from one logging camp to another, working only a short time in each. (N. F.) *See* Pouch.
Syn.: rodeur (E. C.)
- Canary, n.** An iron rod about 6 feet long with a hook on one end and a handle on the other. It is used to pull the binding chain under a bundle of logs that are to be loaded on logging wheels. (L. S.)
- Cannon a log, to.** In loading logs by steam or horse power, to send up a log so that it swings crosswise, instead of parallel to the load. (N. F.)
Syn.: gun a log, to. (R. M. F.)
- Cant dog.** A short handled peavey. (Gen.)
- Cant hook.** A tool like a peavey, but having a toe ring and lip at the end instead of a pike. *See* Peavey. (Gen.)
- Cap, n.** A cone of sheet iron or steel, with a hole in the end through which a chain passes, which is fitted over the end of a log before snaking it, to prevent catching on stumps, roots or other obstacles, in steam skidding. (S. F.)
Syn.: Baptist cone.
- Captain, n.** A term applied by negro workmen to the foreman of any crew. (S. F.) *See* Saw boss; Team boss.
- Catamaran, n.** A small raft carrying a windlass and grapple, used to recover sunken logs. (Gen.)
Syn.: sinker boat (Gen.), gunboat, monitor, pontoon (P. C. F.)
- Catch boom.** A boom fastened across a stream to catch and hold floating logs. (Gen.)
Syn.: trap boom.
- Catch mark.** *See* Bark mark.
- Caterpillar, n.** *See* Log hauler.
- Catface, n.** A partly healed fire scar on the stem of a tree. (P. C. F.)
- Catpiece, n.** A small stick in which holes are made at regular intervals, placed on the top of uprights firmly set in floating booms. The uprights are fitted to enter the holes in the catpiece, so as to narrow or widen the space between the booms at the entrance to a sluiceway or sorting jack. The catpiece is held by the uprights high enough above water to allow logs to float freely under it. (N. W., L. S.)
- Cattle car.** *See* Camp car.
- Cattyman, n.** An expert river driver. (N. F.)
- Center jam.** A jam formed on an obstacle in the middle of a stream, and which does not reach either shore. (Gen.)
Syn.: stream jam.
- Chainer, n.** *See* Sled tender.
- Chain grapples.** *See* Grapples.
- Chain tender.** *See* Sled tender.
- Chance, n.** 1. A term used to define the ease or difficulty with which a particular logging operation or part of an operation can be conducted.

- A good "chance" is one where conditions are favorable for easy logging.
(N. F.)
Syn.: show (P. C. F.)
2. A logging unit. (Gen.)
- Chaser, n.** 1. A member of the hauling crew on a skidroad who accompanies the turn of the logs to the landing, unhooks the grabs, and sees that they are returned to the yarding engine. (P. C. F., R. M. F.)
Syn.: frogger, sled tender (Cal.), pigman (P. C. F.)
2. A member of the yarding crew who tends a bull block, unhooks the choker at the landing, and sees that it is returned to the woods. (P. C. F.)
Syn.: block tender. (Cal.)
- Check, n.** A longitudinal crack in timber caused by too rapid seasoning.
(Gen.)
Syn.: season check.
- Check scaler.** One who re-scales logs in order to detect errors on the part of a scaler. (Gen.)
- Cheese block.** See Chock block.
- Chickadee, n.** See Road monkey.
- Chink, v.** To close the crevices between the logs in a logging camp with wood or moss. (N. W.)
Syn.: moss (N. F.), stog (E. C.). See Daub; Mud.
- Chipper and notcher.** The chief of several saw crews. He notches the timber and keeps a tally of the number of logs cut by each saw crew. (S. F.)
- Chock block.** 1. A small wedge or block used to prevent a log from rolling.
(Gen.)
Syn.: cheese block. (P. C. F.)
2. A device used on patent log car bunks to prevent logs from rolling off.
(P. C. F.)
- Choker, n.** A noose of wire rope by which a log is dragged. The rope is from 20 to 50 feet in length and has a choker hook on one end and a braided eye on the other. (P. C. F.)
- Choker-hole digger.** See Gopher.
- Choker hook.** A hook fastened to one end of a choker. The cable is caught in the hook when the choker is adjusted around the log in the form of a noose. (Gen.)
- Choker man.** The member of a yarding crew who fastens the chokers on the logs. (P. C. F., R. M. F.)
- Chopper, n.** See Faller.
- Chopping board.** See Spring board.
- Chore boy.** One who cleans the sleeping quarters and stable in a logging camp, cuts firewood, builds fires and carries water. (Gen.)
Syn.: lobby hog (App.), shanty boss, swamper (N. W.), buck, bull cook, flunky, greaser.
- Chuck up, to.** See Chunk up, to.
- Chunk, v.** To clear the ground, with engine or horses, of obstructions which can not be removed by hand. (P. C. F.)
- Chunk bucker.** One who, in advance of felling, bucks up merchantable

- windfalls and also other down timber which may interfere with yarding. (P. C. F.)
- Chunk up, to.** 1. To collect and pile for burning the slash left after logging. (N. W., L. S.)
2. In burning brush, to throw upon the fire the unburned pieces around the edge of the pile. (P. C. F.)
- Syn.: chuck up, to.
- Churn butted.** *See* Swell butted.
- Chute, n.** A trough built of round timbers in which logs are transported up or down a grade, either by animal power or by gravity. (E. C., P. C. F.)
- Syn.: slide, flume.
- Chute boat.** *See* Rigging sled.
- Chute grease.** A heavy oil applied to skids to lessen the frictional resistance of logs dragged over them. (P. C. F.)
- Syn.: skid grease.
- Chute greaser.** *See* Greaser.
- Cinch line.** *See* Swifter.
- Coal off, to.** To cut a forest clean for charcoal wood. (N. F.)
- Coffee mill.** *See* corkscrew.
- Commissary, n.** A general store for supplying lumbermen. (App., S. F.)
- See* Van.
- Conk, n.** 1. The decay in the wood of trees caused by a fungus. (N. F., P. C. F.)
2. The visible fruiting organ of a tree fungus. (N. F., P. C. F.)
- Conky, a.** Affected by conk. (N. F., P. C. F.)
- Connected truck.** *See* Skeleton log car.
- Contramarque.** *See* Bark mark.
- Cook camp.** The building used as kitchen and dining room in a logging camp. (Gen.)
- Syn.: cook house, cook shanty.
- Cookee, n.** A cook's helper and a dishwasher in a logging camp. (Gen.)
- See* Flunky.
- Cook house.** *See* Cook camp.
- Cook shanty.** *See* Cook camp.
- Corduroy, v.** To build a corduroy road. (Gen.)
- Corduroy road.** A roadway having logs laid side by side across it, as in marshy places. (Gen.)
- Corkscrew, n.** A geared logging locomotive. (P. C. F.)
- Syn.: coffee mill (N. W.), stem winder, thousand legs (App.).
- Corner, v.** In felling timber, to cut through the sapwood on all sides to prevent the latter from splitting. (App.)
- Corner binds.** Four stout chains, used on logging sleds, to bind the two outside logs of the lower tier to the bunks, and thus give a firm bottom to the load. (N. F.)
- Corner man.** In building a camp or barn of logs, one who notches the logs so that they will fit closely and make a square corner. (N. F.)
- Coupling grab.** *See* Grapples.
- Cover up logs, to.** To fell trees on top of those already cut. (N. F.)

Crab, n. See Headworks.

Cradle, n. A framework of timbers in which ocean-going log rafts are built.
(P. C. F.)

Cradle knolls. 1. Small knolls which require grading in the construction of logging roads. (N. W., L. S.)

2. Small knolls which must be avoided in pointing a tree for felling.
(P. C. F.)

Crazy chain. The short chain used to hold up that tongue of a sprinkler sled which is not in use. (N. F.)

Crazy dray. See Go-devil.

Creek. See Float road.

Crib, n. 1. Specifically, a raft of logs; loosely applied to a boom of logs.
(N. F.)

2. See Buttress.

3. One of the supports under a logging bridge, flume, or railroad built of round logs laid crib fashion. (Gen.)

Crib dam. A dam built with cribs of logs, filled with stones, and planked on the up-stream face. (Gen.)

Crib logs, to. To surround floating logs with a boom and draw them by a windlass on a raft (a *erab*), or to tow them with a steamboat. (N. W., L. S.)

Cross chains. Chains connecting the front and rear sleds of a logging sled.
(N. F.)

Syn.: lead chains, tag chains (N. W.).

Cross-cut saw. A saw which cuts the wood fibres on the cross section. (Gen.)

Cross cutter. See Bucker.

Crosshaul. The cleared space in which a team moves in crosshauling.
(N. F.)

2. See Crotch chain.

Crosshaul, to. To load cars or sleds with logs by horse power and crotch or loading chain. (Gen.)

Crotch, v. To cut notches on opposite sides of a log near the end, into which dogs are fastened. (P. C. F.)

Crotch, n. See Go-devil.

Crotch chain. A tackle for loading logs on sleds, wagons, cars, or skidways by crosshauling. (Gen.)

Syn.: crosshaul (S. F.), parbuckle (N. W.).

See Loading chain.

Crotch tongue. Two pieces of wood, in the form of a V, joining the front and rear sleds of a logging sled. (N. W., L. S.)

Cruise, v. To estimate the amount and value of standing timber. (Gen.)

Syn.: estimate, value.

Cruiser, n. One who cruises. (Gen.)

Syn.: estimator, land looker, valuer.

Cull, n. 1. Logs which are rejected, or parts of logs deducted in measurement on account of defects. (Gen.)

2. A crosstie which does not meet specifications. (Gen.)

Cull, v. See Scale.

Culler, n. *See* Scaler.

Cut, n. A season's output of logs. (Gen.)

Cut a log, to. To move one end of a log forward or backward, so that the log will roll in the desired direction. (Gen.)

Cutaway dam. *See* Splash dam.

Cut-off. An artificial channel by which the course of a stream is straightened to facilitate log driving. (N. F.)

Cutter, n. *See* Faller.

Daub, v. *See* Mud.

Deacon seat. The bench in front of the sleeping bunks in a logging camp. (N. F.)

Syn.: dog seat.

Dead and down. Dead timber which is either standing or down. (Gen.)

Deadener, n. A heavy log or timber, with spikes set in the butt end, so fastened in a log slide that the logs passing under it come in contact with the spikes and have their speed retarded. (Gen.)

Deadhead, n. A sunken or partly sunken log. (Gen.)

Syn.: sinker (Gen.), bobber (N. F.), jil-poke (N. W.)

Deadman, n. 1. A fallen tree on the shore, or a timber to which the hawser of a boom is attached. (N. F., P. C. F.)

2. A log buried in the ground to which a guy line or an anchor line is attached. (Gen.)

3. *See* Widow maker.

Deadwater. *See* Stillwater.

Decker. One who rolls logs upon a skidway or log deck. (Gen.)

Decking chain. *See* Loading chain.

Decking hook. A light peavey used by a top loader. (App.)

Deck up, to. To pile logs upon a skidway. (Gen.)

Deer foot. A V-shaped iron catch on the side of a logging car, in which the binding chain is fastened. (Gen.)

Dehorn, v. To saw off the ends of logs bearing the owner's mark and put on a new mark. (Kentucky.)

Depot, n. The headquarters of a logging operation. (E. C.)

Depot camp. A logging camp comprising several buildings which are to be used for more than one year. (E. C.)

Dhobie tongs. Skidding tongs used with bummers. (S. F.)

Dingle, n. The roofed-over space between the kitchen and the sleeping quarters in a logging camp, commonly used as a store-room. (N. W., L. S.)

Syn.: alley (N. W.)

Dinkey, n. A small logging locomotive. (App., S. F.)

Dog, n. A short, heavy piece of steel, bent and pointed at one end with an eye or ring at the other. It is used for many purposes in logging, and is sometimes so shaped that a blow directly against the line of draft will loosen it. (Gen.)

See Rafting dog.

Syn.: tail hook. (P. C. F.)

Dog boat. *See* Rigging sled.

- Dogger, n.** One who attaches the dogs or hooks to a log before it is power skidded. (S. F., P. C. F.)
- Dog hook.** 1. The hook on the end of a dogwarp. (N. F.)
2. In yarding with a line horse, a hook on the end of a haul-up chain of a size to permit its being hooked into a link of the chain when the latter is looped around a log or other object. (P. C. F.)
- Dog room.** The lounging room in a logging camp. (N. W.)
- Dogs, n.** See Skidding tongs.
- Dog seat.** See Deacon seat.
- Dogwarp, n.** A rope with a strong hook on the end which is used in breaking dangerous jams on falls and rapids and in moving logs from other difficult positions. (N. F.)
Syn.: hand dog (N. F.), hand grab (E. C.).
- Dog wedge.** An iron wedge with a ring in the butt, which is driven into the end of a log and a chain hitched in the ring for skidding the log by horse power; also used in gathering up logs on a drive by running a rope through the rings and pulling a number of logs at a time through marshes or partially submerged meadows to the channel. (N. F.)
- Dolbeer.** See Spool donkey.
- Dolly, n.** See Fairleader; Load roller; Bummer.
- Dolphin, n.** A cluster of piles to which a boom is secured. (P. C. F.)
- Donkey, n.** A portable steam engine, equipped with drums and cable, used in steam logging. See Half-breed; Roader; Spool donkey; Yarding donkey. (P. C. F.)
- Donkey doctor.** In a logging camp, one who repairs donkey engines. (P. C. F.)
- Donkey logging.** Yarding on the ground with a donkey engine, as contrasted with animal logging, or other power logging methods. (P. C. F.)
- Donkey sled.** The heavy sled-like frame upon which a donkey engine is mounted. (P. C. F.)
- Dote, n.** The general term used by lumbermen to denote decay or rot in timber. (Gen.)
- Doty, a.** Decayed. (Gen.)
Syn.: dozy.
- Double couplers.** Two coupling grabs joined by a short cable, used for fastening logs together. (P. C. F.)
Syn.: four paws.
- Double dray.** See Jumbo.
- Double header.** A place from which it is possible to haul a full load of logs to the landing, and where partial loads are topped out or finished to the full hauling capacity of teams. (N. W., L. S.)
- Down-hill clevis.** A brake on a logging sled, consisting of a clevis encircling the runner, to the bottom of which a heavy square piece of iron is welded. (N. F.)
- Dozy, a.** See Doty.
- Drag cart.** See Bummer.
- Drag in, to.** See Dray in, to.

- Drag road.** 1. A road over which skidding teams return to the woods after having delivered their load at the landing. (R. M. F.) *See* Dray road; Gutter road.
- Drag sled.** *See* Dray.
- Draw hook.** *See* Gooseneek.
- Draw skid.** *See* Brow skid.
- Dray, n.** A single sled used in dragging logs. One end of the log rests upon the sled. (N. F.)
Syn.: drag sled, lizard, scoot, skidling sled, yarding sled.
- Dray dog, to.** To seize the rear end of a ranking jumper with a peavey and turn it around.
- Dray in, to.** To drag logs from the place where they are cut directly to the skidway or landing. (N. F.)
Syn.: drag in, to.
- Dray road.** A narrow road, cut wide enough to allow the passage of a team and dray. (N. F.)
Syn.: drag road.
- Drive, v.** To float logs or timbers from the forest to the mill or shipping point. (Gen.)
Syn.: float.
- Drive, n.** 1. A body of logs or timbers in process of being floated from the forest to the mill or shipping point. (Gen.)
2. That part of logging which consists in floating logs or timbers. (Gen.)
- Driving road.** *See* Float road.
- Drum logs, to.** To haul logs by drum and cable out of a hollow or cove. (App.)
- Dry-ki, n.** Trees killed by flooding. (N. F.)
- Dry pick, to.** As applied to a jam, to remove logs singly while the water is cut off. (N. F.)
- Dry roll, to.** In sacking the rear, to roll stranded logs into the bed of the stream from which the water has been cut off preparatory to flooding. (N. F.)
- Dry rot.** Decay in timber without apparent moisture. (Gen.)
- Dry slide.** *See* Slide.
- Dry sloop, to.** To sloop logs on bare ground when the slope is so steep that it would be dangerous to sloop on snow. (N. F.)
- Dudley, n.** *See* Dudley.
- Dudley, n.** An engine for hauling logs, which propels itself and drags its load by revolving a large spool around which are several turns of a cable fixed at each end of the track. (P. C. F.)
Syn.: dudler.
- Duffle, n.** The personal belongings of a woodsman or lumberjack which he takes into the woods. (Gen.)
Syn.: dunnage. (N. W.)
- Duffle bag.** A canvas saek used to carry the clothing and personal belongings of wood workers.
Syn.: dunnage bag.
See Turkey.

- Dump hook.** A levered chain grab hook attached to the evener to which a team is hitched in loading logs. A movement of the lever releases the hook from the logging chain without stopping the team. (N. F.)
- Dump logs, to.** To roll logs over a bluff, or from a logging car or sled into the water. (Gen.)
- Dunnage, n.** 1. Sawmill refuse, used to ballast logging railroad spurs in a cypress swamp. (S. F.)
Syn.: dust.
2. *See* Duffle.
- Dunnage bag.** *See* Duffle bag.
- Dust, n.** *See* Dunnage.
- Dust a dam, to.** To fill with earth or gravel the cracks or small holes between planks in the gate of a splash dam. (N. W.)
- Duster, n.** A dead standing yellow-pine tree with a sound heart. (S. F.)
- Dutchman, n.** A short stick placed transversely between the outer logs of a load to divert the load toward the middle and so keep any logs from falling off. (N. F.)
- Earth slide.** A furrow in the earth in which logs are dragged. This is sometimes iced in winter to facilitate skidding. (App.) *See* Gutter road.
- End mark.** *See* Mark.
- Estimate, v.** *See* Cruise.
- Estimator, n.** *See* Cruiser.
- Face log.** *See* Head log.
- Fairleader.** A device consisting of four rollers or sheave wheels arranged in pairs, the axes of each pair being at right angles to each other. It is placed on a support on the front end of a donkey sled and gives the cable a straight lead onto the drum. (P. C. F.)
Syn.: dolly. (P. C. F.)
- Faller, n.** One who fells trees. (Gen.) *See* Head faller; Second faller.
Syn.: chopper (App.), sawyer (Gen.), cutter, flathead (S. F.)
- Falling ax.** An ax with a long helve and a long, narrow bit, designed especially for felling trees. (Gen.)
- Falling crew.** A crew of two or three fallers. (Cal.)
Syn.: falling set, pair of fallers (P. C. F.)
- Falling irons.** *See* Falling plates.
- Falling plates.** Thin, wide plates of iron which are placed above and below falling wedges when the wood is so soft that the wedges cut into it. (P. C. F.)
Syn.: falling irons.
- Falling set.** *See* Falling crew.
- Falling wedge.** A wedge used to throw a tree in the desired direction, by driving it into the saw kerf. (Gen.)
- Fantail, v.** To lay out radial runs for pullboat logging, each main run having one or more branches. (S. F.)
- Fatwood.** *See* Lightwood.
- Feeder, n.** *See* Barn boss.
- Fence boom.** A patent log-towing boom used at one time on the Great Lakes. (E. C.)
- Fender boom.** *See* Sheer boom.

- Fender skid.** A skid placed on the lower side of a skidding trail on a slope to hold the log on the trail while being skidded. (Gen.)
Syn.: breastwork log, glancer, sheer skid.
- Fiddle butts.** Large spruce butt logs suitable for the manufacture of musical instruments. (N. W.)
- Fid hook.** A slender, flat hook used to keep another hook from slipping on a chain. (N. W., L. S.)
- File a saw, to.** *See* Fit a saw, to.
- Filer, n.** One who files the cross-cut saws in the woods. (Gen.)
Syn.: saw fitter.
- Fin boom.** A form of boom used on navigable streams (where permanent booms are not allowed) to direct logs from one side of the stream to the other. By changing the angle between the fins attached on the downstream face of the boom and the boom itself the latter may be thrown across the stream at any angle less than 90 degrees. (Gen.)
Syn.: rudder boom. (P. C. F.)
- Firm red heart.** Firm heartwood which has a reddish color due to decayed wood adjacent to it. It is an incipient stage of red rot. (S. F.)
Syn.: red heart.
- Fish plate.** A narrow bar of steel having from four to six holes through which bolts may be inserted. Two fish plates are used to join steel rails at the joints, one plate being placed against each side of the web and both bolted to it. (Gen.)
- Fit, v.** 1. To notch a tree for falling and after it is felled to mark it into the log lengths into which it is to be cut. (N. F.)
2. To ring, split, and peel tanbark. (N. F.)
- Fit a saw, to.** To put it into proper condition for sawing. (Gen.)
Syn.: file a saw, to.
- Fitter, n.** 1. One who notches the tree for felling and after it is felled marks the log lengths into which it is to be cut. (N. F.)
2. One who cuts limbs from felled trees and rings and slits the bark preparatory to peeling tanbark. (N. F.)
Syn.: preparer.
- Flagman, n.** One who transmits orders from the tong hooker to the steam skidder leverman. (S. F.)
- Flathead.** *See* Faller.
- Float, v.** *See* Drive.
- Float road.** A channel cleared in a swamp and used to float cypress logs from the woods to the boom at the river or mill. (S. F.)
Syn.: creek, driving road.
- Flood, v.** *See* Splash.
- Flood dam.** *See* Splash dam.
- Flume, v.** To transport logs or timbers by a flume. (Gen.)
Syn.: sluice.
- Flume, n.** A trough in which water runs, used in transporting logs, lumber or timbers. (Gen.)
Syn.: chute (E. C.), sluice, water slide, wet slide.

- Flunkey, n.** 1. An assistant to the cook in a logging camp. (P. C. F.)
2. *See* Cookee; Chore boy.
- Flying drive.** A drive the main portion of which is put through with the utmost dispatch, without stopping to pick rear. (N. F.)
- Flying machine.** *See* Cableway skidder.
- Fly road.** *See* Tote road.
- Flying machine.** *See* Cableway skidder.
- Fly rollway.** A skidway or landing on a steep slope, from which the logs are released at once by removing the brace which holds them. (N. F.)
- Fore-and-aft road.** A skid road made of logs placed parallel to its direction, making the road resemble a chute. (P. C. F.)
Syn.: pole chute, stringer road.
- Four paws.** *See* Double couplers.
- Froe, n.** 1. A steel blade, 6 or 7 inches long, with a wooden handle at right angles to the blade. It is used to rive shakes and split staves from bolts. (Gen.)
2. An iron wedge used in splitting logs. (Gen.)
3. A contemptuous term applied to a dull ax. (App.)
- Frog, n.** 1. The junction of two branches of a flume. (P. C. F.)
2. The junction of two branches of a chute; also any place where an opening is made in a chute to permit the yarding of logs into it. (Cal.)
3. A timber placed at the mouth of a slide to direct the discharge of the logs. (Gen.)
Syn.: throw out.
- Frogger, n.** *See* Sled tender.
- Frog shoveler.** A member of a chute crew or a yarding crew who cleans out dirt and bark at frogs. (Cal.)
- Front, n.** The point at which logging on a particular operation is being conducted. (Texas.)
- Full scale.** Measurement of logs, in which no reduction is made for defects. (Gen.)
Syn.: bigness scale. (N. F.)
- Gaff, n.** The steel point of a pike pole, consisting of a screw point and a spur. (Gen.)
- Gangway, n.** The inclined plane up which logs are moved from the water into a sawmill. (Gen.)
Syn.: jack ladder, log jack, log way, slip.
- Gap stick.** The pole placed across the entrance of a sorting jack to close it, when not in use. (Gen.)
- Gee throw.** A heavy, wooden lever, with a curved iron point, used to break out logging sleds. (N. F.)
Syn.: starting bar.
- Gill-poke.** A swinging-arm type of log car unloader. (P. C. F.)
- Gin pole.** A pole secured by guy ropes, to the top of which tackle for loading logs is fastened. (Gen.)
- Glancer, n.** *See* Fender skid.
- Glancing boom.** *See* Sheer boom.

- Glisse skids.** Freshly peeled skids up which logs are slid instead of rolled when being loaded. (N. F.)
Syn.: slip skids.
- Glut, n.** A wooden wedge used in tie making. (S. F.)
- Go-back road.** A road upon which empty logging sleds can return to the skidways for reloading, without meeting the loaded sleds en route to the landing. (N. F.)
Syn.: short road.
- Go-devil.** A small sled, without a tongue, often made from the natural fork of a tree and used as an aid in skidding logs on stony or bare ground. (L. S., N. F.)
Syn.: alligator, crazy dray (S. F.), crotch, travois (L. S., N. F.)
- Gooseneck, n.** 1. A wooden bar used to couple two logging trucks. (Gen.)
Syn.: rooster (P. C. F.)
2. The point of draft on a logging sled; it consists of a curved iron hook bolted to the roll. (N. F.)
Syn.: draw hook.
3. A V-shaped pair of thills joining the forward and rear sets of runners of a logging sled. (N. W.)
4. A curved iron driven into the bottom of a slide to check the speed of descending logs. (App., R. M. F.)
Syn.: scotch, sprag. (App.)
5. *See* Yoke.
- Goosepen.** A large hole burned in a standing tree. (P. C. F.)
- Gopher, n.** 1. One who makes a hole under a load of logs so that the chains on a pair of logging wheels can be placed around it. (Cal.)
2. In power logging, one who digs holes under the log so that a choker can be adjusted on it. (Cal.)
Syn.: choker-hole digger, swamper.
- Grab-driver.** One who attaches coupling grabs to a turn of logs. (App.)
- Grab hook.** A hook having a narrow throat, adapted to grasp any link of a chain. (Gen.)
- Grab link.** *See* Slip grab.
- Grabs, n.** *See* Skidding tongs.
- Grab setter.** One who attaches the grabs when logs are transported on logging wheels. (S. F.)
- Grab skipper.** A short iron pry or hammer, used to remove the skidding tongs from a log. (App., S. F.)
- Grapples, n.** 1. Two small iron dogs joined by a short chain, and used to couple logs end to end when skidding on mountains, so that several logs may be skidded by one horse at the same time. (N. F.)
Syn.: chain grapples, coupling grab (P. C. F.), trail dog (R. M. F.).
2. *See* Skidding tongs.
- Grass line.** *See* Straw line.
- Gravel a dam. to.** To cover with gravel or earth the upstream side of the timber work of a dam, to make it water tight. (N. F.)
- Greaser, n.** 1. One who applies skid grease to a chute. (P. C. F., R. M. F.)
Syn.: chute greaser, skid greaser.
2. *See* Chore boy.

- Grips, n.** *See* Skidding tongs.
- Ground hog.** *See* Ground skidder.
- Ground loader.** That member of a loading crew who attaches the tongs or loading hooks to the log, or who guides the logs up the skids. (Gen.)
Syn.: bottom loader, hooker, hooker-on, send-up man (Gen.), hookman, tong puller (S. F.), tong hooker (App.), sender (E. C.).
- Ground skidder.** A power skidder which skids logs on the ground. (Gen.)
Syn.: ground hog. (App.).
- Grouser, n.** A large and long stick of squared timber sharpened at the lower end and placed in the bow of a steam logging boat; it takes the place of an anchor in shallow water, and can be raised or lowered by steam power. (N. W., L. S.)
- Guard a hill, to.** To keep a logging road on a steep decline in condition for use. (N. F.)
- Gun, v.** 1. To aim a tree in felling it. In case of very large, brittle trees, such as redwood, a sighting device is used. (Cal.)
Syn.: point, swing.
2. *See* Cannon a log, to.
- Gun, n.** A device which is inserted into an undercut to determine the direction of fall of the tree. (P. C. F.)
Syn.: gunning stick, shot-gun, timber compass.
- Gun a log, to.** *See* Cannon a log, to.
- Gun boat.** *See* Catamaran.
- Gunning stick.** *See* Gun.
- Gutterman.** *See* Swamper.
- Gutter road.** The path followed in skidding logs. (Gen.)
Syn.: drag road, earth slide, runway, skidding trail, snaking trail.
- Guy line.** 1. Lines used to hold raft timbers together. (N. W.)
2. Lines which support a gin-pole, or spar and tail trees. (Gen.)
- Gypo, n.** A logging crew usually of from four to eight men who work on a contract basis. (R. M. F.)
- Gypsy yarder.** *See* Spool donkey.
- Hack, v.** To hew. Usually applied only to the hewing of crossties. (Gen.)
- Half-breed, n.** A donkey engine designed for long distance yarding or for use as a roader on short distance hauling. (P. C. F.) *See* Yarding donkey.
Syn.: donkey.
- Half-moon tie.** A tie made from a stick of timber yielding two ties. (S. F.)
- Hand-bag.** *See* Hand-bank.
- Hand-bank, v.** To haul to the banking ground, with hand sleds, ties or other timbers that are to be floated. (R. M. F.)
Syn.: hand-bag.
- Hand-banker.** One who hauls ties on a hand sled from the stump to the landing. (R. M. F.)
- Handbarrow.** Two strong, light poles held in position by rungs, upon which bark or wood is carried by two men. (N. W., L. S.)
Syn.: ranking bar.
- Hand dog.** *See* Dogwarp.
- Hand grab.** *See* Dogwarp.

- Hand log, to.** To move timber without the aid of animal or mechanical draft. (Gen.)
- Hand logger.** Formerly one who logged without the use of animals or power. The term is now sometimes applied to loggers in the Northwest who use animals instead of power skidders. (P. C. F., R. M. F., S. F.)
- Hand pike.** A piked lever, usually from 6 to 8 feet long, for handling floating logs. (Gen.)
Syn.: pike lever. (N. W.)
- Hand skid, to.** To move timber by hand to a point where it can be reached by horse or any other form of transport. (R. M. F.)
- Hand skidder.** One who accompanies a log as it is being dragged and places short skids beneath it. (P. C. F.)
- Hand sluice, to.** To shoot logs down steep slopes on a crude slide made by felling timber down the slope, cutting off the tops and arranging the boles so that a rough trough results. Snow greatly facilitates hand sluicing. (E. C.)
- Hang an ax, to, v.** To fit a handle to an ax. (Gen.)
- Hang the boom, to.** To put the boom in place. (Gen.)
- Hang up, to.** 1. To fell a tree so that it catches against another instead of falling to the ground. (Gen.)
Syn.: lodge (Gen.), buckwheat (App.).
2. In hauling with a team, to get the load stuck either in the mud or behind a stump.
3. As applied to river driving, to discontinue; thus a drive may be "hung up" for lack of water or for some other reason.
- Hardwood, a.** As applied to trees and logs, broadleaved, belonging to the dicotyledons (Gen.)
Syn.: broadleaf.
- Hardwood, n.** A broadleaved, or dicotyledonous, tree. (Gen.)
- Haul, v.** As applied to a skidway of logs that is being broken into, to slip or slide. (N. W.)
- Haul, n.** In logging, the distance and route over which teams must go between two given points, as between the yard or skidway and the landing. (Gen.)
- Haul back.** A small wire rope, traveling between the power skidder and a pulley set near the logs to be dragged, used to return the main cable with tongs, chokers, or hooks to the next log. (P. C. F., R. M. F., S. F.)
- Haul back.** A small wire rope, traveling between the donkey engine and a pulley set near the logs to be dragged, used to return the cable. (P. C. F.)
Syn.: back line, pull back, trip line.
- Haul back block.** The block used on the haul back line. (P. C. F.)
- Haul up.** A light chain and hook by which a horse may be hitched to a cable in order to move it where desired. (P. C. F.)
- Hay road.** See Tote road.
- Hay wire outfit.** A contemptuous term for poor logging equipment. (N. F.)
- Head block.** The log placed under the front end of the skids in a skidway to raise them to the desired height. (N. F.)
- Head bucker.** See Saw boss.
- Head chopper.** The foreman of a yarding crew. (N. W.)

- Head driver.** An expert river driver who, during the drive, is stationed at a point where a jam is feared. Head drivers usually work in pairs. (N. F.)
Syn.: log watch (N. F.), jam cracker (P. C. F.)
- Head faller.** The chief of a crew of fallers. (P. C. F., R. M. F.) *See* Second faller.
- Head grabs.** The grabs, on the first log of a turn, to which the draft power is attached. (App.) *See* Skidding tongs.
- Head hooker.** The chief of a pullboat skidding crew. (S. F.)
- Head loader.** When two men are engaged in loading logs on trucks or cars, one is termed head loader and the other second loader. (P. C. F., R. M. F.)
See Top loader.
- Head log.** 1. The front bottom log on a skidway. (N. F.)
Syn.: face log.
2. The front log in a turn. (P. C. F.)
Syn.: lead log.
- Head push.** *See* Straw boss.
- Headquarters, n.** In logging, the distributing point for supplies, equipment and mail; not usually the executive or administrative center. (Gen.)
- Head-spar tree.** In steam skidding, the tree near the railroad to which one end of the cable upon which the trolley runs is attached. (Gen.)
Syn.: head tree, spar tree.
- Head tree.** *See* Head-spar tree.
- Headworks, n.** A platform or raft, with windlass or capstan, which is attached to the front of a log raft or boom of logs for warping, kedging, or winding it through lakes and still water, by hand or horsepower. (N. W., L. S.)
Syn.: crab. (N. F., S. F.)
- Helper, n.** *See* Second faller.
- Herder, n.** One who patrols a lumber or log flume to prevent jams. (Cal.)
- High-lead logging.** A modification of donkey yarding, the main cable rigging at the railroad being suspended on a head-spar similar to that used in cableway logging. (P. C. F.)
- Hoist, n.** *See* Incline; Loading tripod.
- Hold, n.** The attachment of tackle to a log or other object to be moved. (P. C. F.)
- Holding boom.** *See* Storage boom.
- Hookaroon, n.** A recurved pike, or a pike and a hook fitted to a handle from 36 to 38 inches long. Used in handling crosssties, lumber, poles, posts, staves, timber, and like products. (Gen.)
Syn.: pickaroon.
- Hooker, n.** 1. One who works with a teamster in bunching logs. (Cal.)
2. *See* Ground loader.
3. *See* Hook tender.
- Hooker-on.** *See* Ground loader.
- Hookman.** 1. One who works with a cant hook or peavey. (L. S., R. M. F.)
2. *See* Ground loader.
- Hook tender.** The foreman of a yarding crew; specifically, one who directs the attaching of the cable to a turn of logs. (P. C. F.)
Syn.: hooker (P. C. F.), logger (Cal.), yarding hook tender (R. M. F.).

- Horse dam.** A temporary dam made by placing large logs across a stream, in order to raise the water behind it, so as to float the rear. (N. F.)
- Horse logs, to.** In river driving, to drag stranded logs back to the stream by the use of peaveys. (N. F.)
- Hot logging.** A logging operation in which logs go forward from stump to mill without pause. (Gen.)
- Hot skidway.** A skidway from which logs are immediately loaded. (N. W.)
- Hovel, n.** A stable for logging teams. (N. W., L. S.)
- Ice a road, to.** To sprinkle water on a logging road so that a coating of ice may form, thus facilitating the hauling of logs. (N. F.)
- Ice box.** *See* Sprinkler.
- Ice guards.** Heavy timbers fastened fan shaped about a cluster of boom piles at an angle of approximately 30 degrees to the surface of the water. They prevent the destruction of the boom by ice, through forcing it to mount the guards and be broken up. (N. E.)
- Incline, n.** A portion of a logging railroad, the grade of which is too steep for the operation of locomotives, and up or down which the log cars are raised or lowered by means of a cable and power. When logs are hauled up grade the incline is sometimes called a hoist. (Gen.)
- Jack, n.** 1. A type of jack screw sometimes used for rolling logs off from the right of way, where railroad grading is being done by hand. The jack screw was formerly used to shift logs on a landing when cars were being loaded by hand. (P. C. F.)
2. In aerial logging, a shoe which rests on a guy line and supports the loading block. (P. C. F.)
- Jack chain.** An endless spiked chain which moves logs from one point to another, usually from the mill pond into the sawmill. (Gen.)
Syn.: jacker chain (Gen.), bull chain, log haul chain (P. C. F.)
- Jackpot, n.** 1. A contemptuous expression applied to an unskillful piece of work in logging. (N. F.)
2. An irregular pile of logs. (App.)
3. A bad slash. (N. W.)
4. Lodgement of one or more trees in another in felling.
Syn.: siwash. (P. C. F.)
- Jack works.** *See* Loading jack.
- Jam, v.** To form an obstruction of logs in a stream. (N. F., E. C.)
- Jam, n.** A stoppage or congestion of logs in a stream, due to an obstruction or to low water. (Gen.)
- Jam cracker.** *See* Head driver.
- Jam hook.** *See* Swamp hook.
- Jammer, n.** 1. An improved form of gin, mounted on a movable framework, and used to load logs on sleds and cars by horse power. (N. F.)
2. A power log loader, usually of the McGiffert type. (Cal.)
- Jam, to break a.** To start in motion logs which have jammed. (Gen.)
- Jay hawk, to.** To strip one 4-foot length of bark from a tanbark oak, leaving the tree standing. (P. C. F., N. W.)
- Jay hole.** On steep skidding roads, a place of refuge for the team when the turn of logs has attained high speed. (App.)

- J-hook, n.** A hook, with a recurved head, to each end of which a grab is attached by a short chain. The J-hook is fastened to the top of the forward log of a turn on a skipper road and serves as the point of attachment for the draft. If the logs start to run, the draft animals can be automatically freed by turning them at right angles to the road. (App.)
- Jiboo, v.** To remove a dog from a log. (N. W., L. S.)
- Jig, v.** *See* Jigger.
- Jigger, v.** To pull a log by horse power over a level place in a slide. (Gen.)
Syn.: jig, lazy haul, to (Gen.), trail (R. M. F.).
- Jig team.** A team of horses used to jigger logs. (App.)
- Jil-poke, v.** To obstruct or hang up temporarily, a log drive. (N. W.)
- Jil-poke, n.** *See* Deadhead.
- Jim binder.** *See* Binder.
- Jim crow.** A type of rail bender used for bending or straightening steel rails. (Gen.)
- Jim crow loads.** A logging car or truck loaded with a log so large that one constitutes a load. (P. C. F.)
- Jobber, n.** A logging contractor or subcontractor. (Gen.)
- Jobber's sun.** A term applied to the moon in a jobber's or contractor's logging camp, on account of the early and late hours of commencing and ending work. (N. W., L. S.)
- Joint, n.** A section of a raft. (E. C.)
- Juggler.** *See* Log roller.
- Jumbo, n.** 1. A type of tongueless double sled used for short-distance hauling. (L. S.)
Syn.: double dray.
2. *See* Bull block.
- Jumper, n.** A sled made wholly of wood, used for hauling supplies over bare ground into a logging camp. (N. F., E. C.)
See Mudboat; Whip-poor-will.
Syn.: tote sled.
- Katydid, n.** *See* Logging wheels.
- Kedge.** *See* Warp.
- Key log.** In river driving, a log which is so caught or wedged that a jam is formed and held. (Gen.)
- Kilhig, n.** A short, stout pole used as a lever or brace to direct the fall of a tree. (N. W.)
- King swamper, n.** A head swamper. (S. F., App.)
Syn.: buck swamper.
- Knot, v.** *See* Limb.
- Knot bumper.** *See* Limber.
- Knotter, n.** *See* Limber.
- Laker, n.** A log driver expert at handling logs on lakes. (N. F.)
- Landing, n.** 1. A place to which logs are hauled or skidded preparatory to transportation by water or rail. A *rough-and-tumble* landing is one in which no attempt is made to pile the logs regularly. (Gen.)
Syn.: bank, banking ground, brow, log dump, rollway, yard.
2. A platform, usually at the foot of a skid road, where logs are collected

- and loaded on cars. A *lightning landing* is one having such an incline that the logs may roll upon the cars without assistance. (Gen.)
3. A cribwork of logs, constituting a platform alongside the railroad track, upon which logs are hauled by a donkey, ready for loading upon cars or trucks. (P. C. F.)
- Syn.: rollway.
- Landing crew.** A crew that constructs landings. (P. C. F.)
- Landing man.** One who unloads logging sleds at the landing. (N. F.)
- Landing, to break a.** To roll a pile of logs from a landing or bank into the water. (Gen.)
- Land looker.** See Cruiser.
- Lap, n.** Tops left in the woods in logging. (Gen.)
- Syn.: lapwood.
- Lapwood, n.** See Lap.
- Lash pole.** A cross pole which holds logs together in a raft. (Gen.)
- Lazy haul, to.** See Jigger.
- Lead, n.** A block or roller attached to a stationary object which guides the pull of a cable. (P. C. F.)
- Lead block.** See Bull block.
- Lead chains.** See Cross chains.
- Leaders, n.** In an ox or horse team, the forward pair. (Gen.)
- Lead log.** See Brow skid; Head log.
- Lead strap.** A wire rope, with an eye at each end, used to anchor the block in setting a lead. (P. C. F.)
- L-hook, n.** An L-shaped hook with a long cable, chain, or rope attached. The hook is fastened to the rear of a turn of logs in the trailing portion of a slide and the draft animals to the cable. When the turn starts to run on a steep portion of the slide the hook is automatically released and prevents the logs from dragging the draft animals. (App.)
- Lift gate.** In a logging dam sluiceway, a gate which may be moved up or down in vertical slides or grooves, fastened to the sides of the sluiceway. (Gen.)
- Lightning landing.** See Landing, 2.
- Lightwood, n.** Pine wood which is heavily impregnated with a resinous substance. (S. F.)
- Syn.: fatwood.
- Limb, v.** To remove the limbs from a felled tree.
- Syn.: knot. (P. C. F.)
- Limber, n.** One who cuts the limbs from felled trees. (Gen.)
- Syn.: knot bumper (App.) knotter. (P. C. F., R. M. F.)
- Limber boom.** A flexible boom, the sticks of which are usually joined to each other by means of short chains or short pieces of manila rope or wire cable.
- Lineman, n.** One in charge of hauling logs in a chute. (S. F.)
- Line horse.** 1. The horse which drags the cable from the yarding engine or skidder to the log to which the cable is to be attached. (S. F.)
2. A horse used to aid the rigging crew in changing lines. Formerly, the animal used to haul out the cable from the yarding engine to the log. (P. C. F.)

- Lizard, n.** A crude sled made from the crotch of a tree, used in skidding logs in muddy places. The forward end of the log rests on the sled. (S. F.)
See Dray.
- Loader, n.** 1. One who loads logs on sleds or cars. (Gen.)
2. *See Steam loader.*
- Loader leverman.** One who operates the levers controlling the drums on a power loading device. (S. F.)
- Loaderman.** *See Loader.*
- Loading chain.** A long chain used in loading or piling logs with horses. (N. F.)
Syn.: decking chain, loading line, rolling chain.
See Crotch chain.
- Loading dock.** *See Loading jack.*
- Loading jack.** A platformed framework upon which logs are hoisted from the water for loading upon cars. (N. F.)
Syn.: jack works (N. F.), loading dock. (L. S.)
- Loading line.** 1. The cable on a power skidding device used for loading logs on cars. (Gen.)
2. *See Loading chain.*
- Loading tripod.** Three long timbers joined at their tops in the shape of a tripod, for holding a pulley block in proper position to load logs on cars from a lake or stream. (L. S.)
Syn.: hoist.
- Lobby, n.** In a logging camp, a room in which the men wash and wait for meal-time. Generally found in two-storied camps which have the sleeping quarters on the second floor. (App.)
- Lobby hog.** *See Chore boy.*
- Lock down.** A strip of tough wood, with holes in the ends, which is laid across a raft of logs. Rafting pins are driven through the holes into the logs, thus holding the raft together. (N. F.)
- Lodge, to.** *See Hang up, to.*
- Logan, n.** *See Pokelogan.*
- Log boat.** A short, tongueless sled with wood runners, used to haul logs to a portable mill operation. (N. F.)
- Log chute.** 1. A trough made of timbers and used for sliding logs down hill, either dry or by aid of water. (E. C.)
- Log deck.** The platform upon a loading jack. (Gen.)
- Log dump.** *See Landing.*
- Log fixer.** *See Rosser.*
- Logger, n.** 1. One engaged in logging.
Syn.: lumber jack.
2. *See Hook tender.*
- Logging sled.** The heavy double sled used to haul logs from the skidway or yard to the landing. (N. F.)
Syn.: sleigh, twin sleds, two sleds, wagon sled.
- Logging-sled road.** A road leading from the skidway to the landing. (N. F.)
- Logging truck.** A four-wheeled logging railroad truck with a bunk on which

is carried one end of a load of logs. The opposite ends of the logs are supported on a similar truck, a gooseneck often being omitted. (P. C. F.)

Syn.: truck.

Logging wheels. A pair of wheels from 7 to 12 feet in diameter, for transporting logs. (Gen.)

Syn.: katydid, slip-tongue cart, sulky, timber wheels (Gen.), big wheels. (Cal.)

Log hauler. A steam or gasoline power engine with a special traction device which is used in place of horses to haul logging sleds. (N. F.)

Syn.: caterpillar. (E. C.)

Log maker. See *Bucker*.

Log scale. The contents of a log, or of a number of logs considered collectively. (Gen.)

Log sorter. See *Mark caller*.

Log spur. See *Spur*.

Log stamp. See *Marking hammer*.

Log, to. To cut logs and deliver them at a place from which they can be transported by water or rail, to the mill. (Gen.)

Log watch. See *Head driver*.

Long butt, to. See *Butt off, to*.

Lookout. See *Signal man*.

Loose-tongued sloop. See *Swing dingle*.

Lop, v. To cut the limbs from a felled tree. (Gen.)

Syn.: top-lop. (E. C.)

Lot, n. A piece of standing timber, small in area. (N. F.)

Lubber lift, to. To raise the end of a log by means of a pry, and through the use of weight instead of strength. (N. F.)

Lug hooks. A pair of tongs attached to the middle of a short bar, and used by two men to carry small logs. (Gen.)

Syn.: timber carrier, timber grapple.

Lumber, v. To log or to manufacture logs into lumber, or both. (Gen.)

Lumberjack, n. One who works in a logging camp. (Gen.)

Syn.: timber beast, woodhick (App., N. W.), logger (P. C. F.), shanty man. (E. C.)

Lumberman, n. One engaged in lumbering. (Gen.)

Main line. See *Skyline*.

Mark, n. A letter or sign indicating ownership, which is stamped on the ends of logs. (Gen.) See *Bark mark*.

Syn.: brand, end mark.

Mark caller. In sorting logs, one who stands at the lower end of the sorting jack and calls the different marks, so that the logs may be guided into the proper channels or pockets. (Gen.)

Syn.: log sorter. (N. W.)

Marker, n. 1. One who puts the mark on the ends of logs. (Gen.)

2. One who marks boles into log lengths for buckers. (Cal.)

Market, n. A log 19 inches in diameter at the small end and 13 feet long. (New York.) See *Quebec standard*.

Syn.: standard.

- Marking hammer.** A hammer bearing a raised device which is stamped on logs to indicate ownership. (Gen.)
Syn.: marking iron (Gen.), log stamp, stamping hammer. (E. C.)
- Marking iron.** See Marking hammer.
- Match, v.** See Mate.
- Mate, v.** To place together in a raft logs of similar size. (Gen.)
Syn.: match.
- Merchantable log.** A log that will make lumber of a quality and in sufficient amount to make it profitable to take it to a mill and have it sawed. (Supreme Court of Michigan, S2 Northwest Reporter, 230.)
- Merchantable timber.** Usually interpreted to mean timber that can be manufactured and sold at not less than cost. The purpose for which the timber is to be used and local customs are factors which influence the degree of utilization.
- Messenger.** See Haul back.
- Mill pond.** The pond near a sawmill in which logs to be sawn are held. (Gen.)
- Mill scale.** The scale of logs made at the rafting boom or at the sawmill. (Gen.)
- Mine prop.** A small stull. (R. M. F.)
- Monitor.** See Catamaran.
- Moss, v.** See Chink.
- Mud, v.** To fill with soft clay or mortar the crevices between the logs in a logging camp. It usually is preceded by chinking. (N. E.) See Chink.
Syn.: daub. (R. M. F.)
- Mudboat, n.** A low sled with wide runners, used for hauling logs in swamps. (S. F., N. F.)
Syn.: jumper. (N. W.)
- Mudsill, n.** 1. The bed piece or bottom timber of a dam which is placed across the stream, usually resting on rocks or in the mud. (Gen.)
Syn.: bottom sill.
2. Short pieces of timber placed crosswise underneath the main sill of each bent in a railroad bridge. (Gen.)
- Mule cart.** A 4-wheeled vehicle used in the Coastal Plain region for hauling logs. The logs are suspended under the axle of the rear wheels. (S. F.)
- Mulligan car.** See Camp car.
- Needle gate.** In a logging dam sluiceway, narrow timbers or poles with two or more squared faces which are placed in contact across the opening of the sluice to prevent the outflow of water. One or more "needles" may be removed without disturbing the remainder. (Gen.)
Syn.: bracket gate.
- Nick, n.** See Undercut.
- Nipper, n.** A member of the steel crew, who by means of a crow-bar and a block used as a fulcrum holds the end of the cross-tie against the base of the rail while the spikes are being driven. (Gen.)
- North Carolina pine.** Pine timber cut in the Coastal Plain region of Virginia, North Carolina, and South Carolina. (S. F.)

- Nose, v.** To round off the end of a log in order to make it drag or slip more easily. (Gen.)
Syn.: snipe.
- Notch, v.** To make an undercut in a tree preparatory to felling it. (Gen.)
Syn.: box, undercut.
- Notch, n.** *See* Undercut.
- One-block hold.** *See* Block hold.
- Overrun, n.** The difference between the mill cut of merchantable lumber and the log scale. Usually calculated as a per cent of 1000 feet log scale. (Gen.)
- Pair of fallers.** *See* Falling crew.
- Parbuckle, n.** *See* Crotch chain.
- Park, v.** To collect crossties along a strip road, usually by hand. (R. M. F.)
- Peaker, n.** 1. A load of logs narrowing sharply toward the top and thus shaped like an inverted V. (Gen.)
Syn.: wind splitter.
2. The top log of a load. (Gen.)
- Peavey, n.** A stout lever from 5 to 7 feet long, fitted at the larger end with a metal socket and spike and a curved steel hook which works on a bolt; used in handling logs, especially in driving. A peavey differs from a cant hook in having a pike instead of a toe ring and lip at the end. (Gen.)
See Cant dog; Cant hook.
- Pecky, a.** A term applied to a defect common in bald cypress. (S. F.)
Syn.: peggy.
- Peeler, n.** *See* Barker.
- Peggy, a.** *See* Pecky.
- Pickaroon, n.** A piked pole fitted with a curved hook, used in holding boats to jams in driving, and for pulling logs from brush and eddies out into the current. (Gen.)
- Pick the rear, to.** *See* Sack the rear, to.
- Pier dam.** A pier built from the shore, usually slanting downstream, to narrow and deepen the channel, to guide logs past an obstruction, or to throw all the water on one side of an island. (N.F.)
Syn.: side pier, wing dam.
- Pig, n.** *See* Rigging sled.
- Pigman, n.** *See* Chaser.
- Pig tail.** An iron device driven into trees or stumps to support a wire or small rope. (P. C. F.)
- Pike lever.** *See* Hand pike.
- Pike pole.** A piked pole from 12 to 20 feet long, with or without a hook, used in holding boats to jams in driving and for pulling logs from brush and eddies out into the current. (Gen.)
Syn.: gaff. (E. C.)
- Pile dam.** A dam formed by a double row of piles between which are placed stones, gravel, and fine material to prevent the passage of water. (L. S.)
- Pin dot.** Small rotten spots on the ends of logs. (Gen.)
- Pine sawyer.** A beetle of the genus *Monohammus* which attacks the sapwood of pine logs. (S. F.)

- Pin worm holes.** Small holes in timber and lumber made by the larvae of certain beetles. (Gen.)
- Pit, n.** A skidway elevated so that its base is level with the logging car bunks. (App.)
- Pitch pocket.** In coniferous woods, an opening between the annual growth rings containing pitch. (Gen.)
Syn.: pitch seam. (P. C. F.)
- Pitch seam.** See Pitch pocket.
- Pitch streak.** In coniferous woods, a well-defined accumulation of pitch at one point. (Gen.)
- Plug, n.** A steel pin about 2 inches in diameter and 18 inches long. Two of the plugs are joined together by chains which are attached to a large ring. They are used on pullboat operations in a cypress swamp in place of skidding tongs. (S. F.)
Syn.: puppy.
- Plug and knock down.** A device for fastening boom sticks together, in the absence of chains. It consists of a withe secured by wooden plugs in holes bored in the booms. (N. F.)
- Pocket boom.** A boom in which logs are held after they are sorted. (Gen.)
- Point, v.** See Gun.
- Pokelogan, n.** A bay or pocket into which logs may float during a drive. (N. W., L. S.)
Syn.: logan, set-back.
- Pole chute.** See Fore-and-aft road.
- Pole tie.** A tie made from a stick of timber yielding only one tie. (Gen.)
- Pole tram road.** A logging road, the rails of which are round poles. (App., S. F.)
- Pontoon.** See Catamaran.
- Potter, n.** A round stick, 3 or 4 inches in diameter and 2½ or 3 feet long, around the center of which is fitted an iron clasp to which is fastened a short piece of chain with a hook on the free end. It is used when loading logging sleds to prevent logs from rolling off the far side of the load until binding chains are placed in position. (N. W.)
- Pouch, n.** A French term applied derisively by lumber jacks to woods workers who shift from camp to camp. (N. W.) See Camp inspector.
- Preparer, n.** See Fitter.
- Prime log.** In the export market, one that is free from defects. (Gen.)
- Prize logs.** Logs which come to the sorting jack without marks denoting ownership. (N. F.) See Stray.
- Prop, n.** In mining, a round, squared, or split timber which supports the cap and lagging or which is placed directly under the roof to support the same without a cap or lagging. (Gen.)
- Pull back.** See Haul back.
- Pullboat.** A flatboat, carrying a steam skidder or a donkey, used in logging cypress. (S. F.)
- Pull the briar, to.** To use a cross-cut saw. (N. F.)
- Puppy, n.** See Plug.
- Push.** See Camp foreman.

Put in, to. In logging, to deliver logs at the landing. (Gen.)

Quarter tie. A tie made from a stick of timber yielding four or more ties. (S. F.)

Quebec deal. *See* Deal.

Quebec standard. A white pine log 22 inches in diameter, inside bark, at the small end and 12 feet long. A spruce or balsam log 14 inches in diameter inside bark at small end and 12 feet long. (E. C.) *See* Market.

Quickwater, n. That part of a stream which has fall enough to create a decided current. (Gen.)

Syn.: white water. (N. W.)

Ant.: stillwater.

Raft bundle. Logs bound together into a circular unit for towing. (S. F.)

Rafter dam. A dam in which long timbers are set on the upstream side at an angle of from 20 to 40 degrees to the water surface. The pressure of the water against the timbers holds the dam solidly against the stream bed. (N. F.)

Syn.: self-loading dam, slant dam.

Rafting dog. A wedge-shaped piece of metal with a ring or eye in the blunt end. Dogs are driven into boom sticks and often into the timbers being rafted, the raft members being held together by chains, cables, or rope, passed through the rings or eyes.

Rafting pin. A round or wedge-shaped wooden pin used to wedge cable in the rafting pin holes on a raft. (Gen.)

Rag a wedge, to. To roughen the surface of a wooden wedge with an ax to prevent it from jumping out of the saw cut in frozen timber. (E. C.)

Ram pike. A tree broken off by wind and with a splintered end on the portion left standing. (N. F.)

Rank, v. To haul and pile regularly, as, to *rank* bark or cord wood. (Gen.)

Ranking bar. *See* Handbarrow.

Ranking jumper. A wood-shod sled upon which tanbark is hauled. (N. F.)

Syn.: bark dray. (App.)

Ratline, n. A rope through which at intervals small pins are driven into the logs which are to compose a raft joint. Its purpose is to hold the logs together until the boom poles can be adjusted. (E. C.)

Syn.: rattling line.

Rattling line. *See* Ratline.

Rave, n. A piece of iron or wood which secures the beam to the runners of a logging sled. (N. W., L. S.)

Rawhide, v. To carry on one's back. Usually applied to the carrying of tanbark. (App.)

Rear, n. The up-stream end of a drive; the logs may be either stranded or floating. "*Floating rear*" comprises those logs which may be floated back into the current; "*dry rear*," those which must be dragged or rolled back. (Gen.)

Syn.: tail end. (N. W.)

Receiving boom. *See* Storage boom.

Red heart. *See* Firm red heart.

- Refuse, n.** That portion of a tree which cannot be removed profitably from the forest or utilized profitably at the manufacturing plant. (Gen.)
- Return line.** *See* Haul back.
- Rick, n.** A pile of cordwood, stave bolts, or other material split from short logs. (Gen.)
2. A pile of firewood 8 feet long, 4 feet high, and of a width equal to the length of one stick. (C. H. F.)
- Ride, n.** The side of a log upon which it rests when being dragged. (Gen.)
- Ride a log, to.** To stand on a floating log. (Gen.)
- Ridge runner.** A farmer who is an intermittent logger. (App.)
- Rigger.** *See* Rigging slinger.
- Rigging, n.** The cables, blocks and hooks used in skidding logs by steam power. (Gen.)
- Rigging sled.** A sled used to haul hooks and blocks on a skid road. (P. C. F.)
Syn.: chute boat, dog boat, pig.
- Rigging slinger.** 1. A member of a yarding crew, whose chief duty is to place chokers or grabs on logs. (P. C. F.)
2. One who attaches the rigging to trees, in steam skidding. (S. F.)
Syn.: rigger.
- Ring, n.** A section of tanbark, usually 4 feet long. (N. F.)
- Ring rot.** Decay in a log, which follows the annual rings more or less closely. (Gen.)
- Rise, n.** The difference in diameter, or taper, between two points on a log. (Gen.)
- Rive, v.** To split shingles or shakes from bolts. (Gen.)
- River boss.** The foreman in charge of a log drive. (N. F.)
- River driver.** One who works on a log drive. (Gen.)
- River hog.** *See* River rat.
- River pig.** *See* River rat.
- River rat.** A log driver whose work is chiefly on the river; contrasted with Laker. (N. F.)
Syn.: river hog, river pig.
- Road donkey.** *See* Roader.
- Road engine.** *See* Roader.
- Roader, n.** A donkey engine mounted on a heavy sled, which is used for long-distance hauling either on the ground or on a skid road. It is equipped with three drums — one for the pulling line, one for the haul back, and one for loading. (P. C. F.) *See* Yarding donkey.
Syn.: bull donkey, road donkey, road engine (P. C. F.), Takoma (Cal.), donkey.
- Road gang.** That portion of the crew of a logging camp which cuts logging roads and keeps them in repair. (N. F.)
- Road monkey.** One whose duty is to keep a logging road in proper condition. (N. W., L. S., P. C. F.)
Syn.: dolly, roller, stump roller, stump spool, upright roller, yarding spool.
- Road roller.** A flanged roller placed upright at a bend in a skid road to

- direct the cable. It is sometimes used instead of a bull block in yarding logs. (P. C. F.)
- Syn.: blue jay, chickadee (N. F.), sandman.
- Road scale.** The scale of logs which is taken on the landing. (P. C. F.)
- Rocker, n.** The top bunk on the forward pair of runners of a logging sled. It is fastened to the lower bunk by a kingpin. (N. W.)
- Rodeur.** *See* Camp inspector.
- Roll, n.** The crossbar of a logging sled into which the tongue is set. (N. W., L. S.)
- Syn.: roller.
- Roll a log, to.** To so attach a choker to a log that the latter rolls sidewise when power is applied to a cable. (P. C. F.)
- Roll bark.** Hemlock tanbark that has not been carefully dried and hence is of inferior quality. (N. F.)
- Roll-down man.** *See* Tailer-in.
- Roller, n.** *See* Roll; Road roller.
- Rolling chain.** *See* Loading chain.
- Rolling dam.** A dam for raising the water in a shallow stream. It has no sluiceways, but a smooth top of timber over which, under a sufficient head of water, logs may slide or roll. (Gen.)
- Roll logs, to.** To turn over the logs on a landing so that the bark marks can be inspected by the scaler. (E. C.)
- Roll the boom, to.** To roll a boom of logs along the shore of a lake against which it is held by wind, by the use of a cable operated by a steamboat or kedge. The cable is attached to the outer side of the boom, hauled up, then attached again, thus propelling the boom by revolving it against the shore when it would be impossible to tow it. (N. W., L. S.)
- Roll up.** *See* Bank up.
- Rollway, n.** *See* Landing.
- Rooster, n.** *See* Gooseneck.
- Rosser, n.** 1. One who barks and smooths the ride of a log in order that it may slide more easily. (N. F.)
- Syn.: log fixer, rosser (P. C. F.), scalper, slipper. (App.)
2. One who peels pulpwood and logs. (N. W.)
3. *See* Barker.
- Rossing-mill, n.** A plant at which bark is removed from pulpwood by means of machinery. (N. W., E. C.)
- Rotten knot.** A knot which is not as hard as the surrounding wood. (Gen.)
- Rough and tumble landing.** *See* Landing.
- Round boom.** A limber boom used to impound logs during towing. (L. S.)
- See* Bag boom.
- Round knot.** A knot that is oval or circular in form. (Gen.)
- Round timber.** Timber which has not been bled for crude turpentine. (S. F.)
- Round turn.** A space at the head of a logging-sled road, in which the sled may be turned round without unhitching the team. (N. F.)
- Rudder boom.** *See* Fin boom.
- Run, n.** A narrow trail, cleared of brush and stumps, down which logs are pulled by a power skidder. (S. F.)

- Run cutter.** One who clears narrow trails which radiate from a pullboat or from a head-spar tree, down which logs are hauled by a power skidder. (S. F.)
- Runner chain.** A chain bound loosely around the forward end of the runners of a logging sled as a brake. (N. W., L. S.)
- Runner dog.** A curved iron attached to a runner of the hind sled of a logging sled, which holds the loaded sled on steep hills by being forced into the bed of the road by any backward movement. (N. F.)
- Running slide.** A slide on which logs run by gravity. (App.)
- Runway.** *See* Gutter road.
- Rutter, n.** A form of plow for cutting ruts in a logging road for the runners of the sleds to run in. (N. W., L. S.)
- Sack the rear, to.** To follow a drive and roll in logs which have lodged or grounded. (Gen.)
Syn.: pick the rear, to; sweep the rear, to. (E. C.)
- Sack the slide, to.** To return to a slide logs which have jumped out. (Gen.)
- Saddle, n.** The depression cut in a transverse skid in a skid road to guide the logs which pass over it. (P. C. F.)
- Saddlebag, v.** As applied to a boom, to catch on an obstruction and double around it. (Gen.)
- Sampson, n.** 1. An appliance for loosening or starting logs by horsepower. It usually consists of a strong, heavy timber and a chain terminating in a heavy swamp hook. The timber is placed upright beside the piece to be moved, the chain fastened around it, and the hook inserted low down on the opposite side. Leverage is then applied by a team hitched to the upper end of the upright timber. (N. F.)
- Sampson a tree, to.** To direct the fall of a tree by means of a lever and pole. (N. F.)
- Sandman.** *See* Road monkey.
- Sap stain.** Discoloration of the sapwood. (Gen.)
- Satchel stick.** A stick carried on the shoulder and used by a lumberjack to support his turkey. (App.)
- Saw boss.** Foreman of the felling and log-making crews. (S. F.)
Syn.: captain (S. F.), bull bucker, head bucker. (P. C. F.)
- Saw fitter.** *See* Filer.
- Saw kerf.** The width of cut made by a saw. (Gen.)
- Saw timber.** Logs suitable in size and length for the production of merchantable lumber.
- Sawyer, n.** *See* Faller.
- Scale, v.** To measure the volume of logs. (Gen.)
Syn.: cull. (E. C.)
- Scale book.** A book especially designed for recording the contents of sealed logs. (Gen.)
- Scaler, n.** One who determines the volume of logs. (Gen.)
Syn.: culler. (E. C.)
- Scalper, n.** *See* Rosser.
- Schoodic chain bind.** A method of binding logs to the bunk of a dray. Two forms are in use, namely, the single schoodic and the double schoodic. (N. W.)

Scoot, n. *See* Dray.

Score, v. In hewing timber, to mark with lines or with ax hacks the limits of the cut, both as to width and depth. (Gen.)

Scotch, n. *See* Gooseneck.

Scratch grade. A logging railroad grade on which only light work has been done. (P. C. F., S. F.)

Seam. *See* Check.

Season check. *See* Check.

Second faller. The subordinate in a crew of two fallers. (P. C. F.) *See* Head faller.

Syn.: faller, helper. (N. F.)

Second loader. *See* Head loader.

Section, n. A portion of a log raft, separated by swifters, usually containing two tiers of logs. (P. C. F.)

Self-loading dam. *See* Rafter dam.

Self-loading skidder. *See* Bummer.

Sender. *See* Ground loader.

Send-up man. *See* Ground loader.

Send up, to. In loading, to raise logs up skids with cant hooks, or by steam or horse power. (Gen.)

Set back. *See* Pokelogan.

Set gauge. A tool used by a cross-cut saw filer to regulate the amount of set given to each tooth. (Gen.)

Syn.: spider.

Setting, n. The temporary station of a portable sawmill, a yarding engine, or other machine used in logging. (Gen.)

Syn.: set-up.

Set-up, n. *See* Setting.

Shackle. *See* Yoke.

Shake, n. 1. A form of shingle split from a bolt of wood and used to cover both the roofs and sides of buildings. Those made of sugar pine are 32 inches long, 5 inches wide, and $\frac{3}{16}$ of an inch thick on the thin edge.

Syn.: hand-made shingle, roof board. (App.)

2. A crack in timber, due to frost or wind. (Gen.)

Syn.: windshake.

Shake roof. *See* Split roof.

Shanty boat. *See* Wanigan.

Shanty boss. 1. *See* Camp foreman.

2. *See* Chore boy.

Shanty man. *See* Lumberjack.

Sheer boom. A boom so secured that it guides floating logs in the desired direction. (N. F.)

Syn.: fender boom, glancing boom.

Sheer skid. *See* Fender skid.

Shim, n. Blocking placed under crossties to level up the track; also used to keep the track from sinking into the mud. (Gen.)

Shim up, to, v. To place shims under a railroad track. (Gen.)

- Shingle bolt.** A short split section of a log from which shingles are manufactured. (Gen.) *See* Bolt.
- Shoot a jam, to.** To loosen a log jam with dynamite. (Gen.)
- Shore hold.** The attachment of the hawser of a raft of logs to an object on the shore. (N. W., L. S.)
- Short road.** *See* Go-back road.
- Shot-gun, n.** *See* Gun.
- Shot holes.** Holes made in wood by boring insects. (App.)
- Show, n.** *See* Chance.
- Side, n.** The crew of men, including fallers, buckers, rigging men, loaders, and all others working with a yarding donkey. When a roader or swing donkey takes logs from the yarding donkey the men operating them are included in the side. (P. C. F.)
- Side boss.** The foreman of a "side." (P. C. F.)
- Side jam.** A jam which has formed on one side of a stream, usually where the logs are forced to the shore at a bend by the current, or where the water is shallow or there are partially submerged rocks. (N. F.)
- Side line logs, to.** 1. To throw the hauling cable around a stump, out of the direct line of pull, in order to change the direction of travel of the log and thus avoid some obstruction in its path. (Gen.)
Syn.: siwash. (P. C. F.)
2. To draw logs up to the main hauling cable. (S. F.)
- Side-line man.** One who carries the side lines from the main cable of a pull-boat and attaches them to the logs that are to be skidded. (S. F.)
- Side mark.** *See* Bark mark.
- Side pier.** *See* Pier dam.
- Side pole.** *See* Sway bar.
- Side winder.** A tree knocked down unexpectedly by the falling of another. (Gen.)
- Signal man.** One who transmits orders from the foreman of a yarding crew to the engineer of the yarding donkey.
Syn.: lookout, signal punk, whistle punk.
- Signal punk.** *See* Signal man.
- Single cord.** A pile of wood, 8 feet long, 4 feet high, and 2 feet wide. (C. H. F.)
- Single coupler.** Single coupling grabs joined by a short chain or cable, used for fastening logs together. (App.)
Syn.: tail grab.
- Single out, to.** To float logs, usually cypress, one at a time, from the woods to the float road. (S. F.)
- Sinker, n.** *See* Deadhead.
- Sinker boat.** *See* Catamaran.
- Siwash.** *See* Side line logs, to; Jackpot.
- Skeleton log car.** A car having a skeleton frame. (Gen.)
Syn.: connected truck. (P. C. F.)
- Skid, v.** 1. To draw logs from the stump to the skidway, landing or mill. (Gen.)

- Syn.: snake, twitch, yard. (N. W.)
2. As applied to a road, to reinforce by placing logs or poles across it.
- Skid, n.** A log or pole, commonly used in pairs, upon which logs are handled or piled (Gen.); or the log or pole laid transversely in a skid road. (P. C. F.)
- Skidder, n.** 1. One who skids logs. (Gen.)
2. A steam or electrically driven device operating on or near a railroad track, which skids logs by means of a cable. Three general systems are in use; the cable-way or overhead system, the chief distinguishing feature of which is a cable suspended between a head-spar tree and a tail tree, on which travels a trolley from which cables run that wholly or partially elevate the log above the ground; the slack-rope system, a ground system in which the skidding cable is returned to the logs by a smaller cable called a haul back; the snaking system, a ground system in which the skidding line is pulled out by an animal. (Gen.)
- Syn.: steam skidder.
3. The foreman of a crew which constructs skid roads. (P. C. F.)
4. *See* Bummer.
- Skidding chain.** A heavy chain used in skidding logs. (Gen.)
- Skidding hooks.** *See* Skidding tongs.
- Skidding sled.** *See* Dray.
- Skidding tongs.** 1. A pair of hooks attached by links to a ring and used for skidding logs. (Gen.)
- Syn.: dogs, grabs, grapples, grips, head grabs, skidding hooks
2. Tongs used in skidding logs. (Gen.)
- Skidding trail.** *See* Gutter road.
- Skid grease.** *See* Chute grease.
- Skid greaser.** *See* Greaser.
- Skid-off, n.** A launching way for lumber rafts. (S. F.)
- Skid road.** 1. A road or trail leading from the stump to the skidway or landing. (Gen.)
- Syn.: travois road. (N. F.)
2. A road over which logs are dragged, having heavy transverse skids partially sunk in the ground, usually at intervals of about 5 feet. (P. C. F.)
- Skid up, to.** 1. To level or reinforce a logging road by the use of skids. (Gen.)
2. To collect logs and pile them on a skidway. (Gen.)
- Skidway, n.** Two skids laid parallel at right angles to a road, usually raised above the ground at the end nearest the road. Logs are usually piled upon a skidway as they are brought from the stump for loading upon sleds, wagons or cars. (Gen.)
- Syn.: yard. (N. W.)
- Skidway, to break a.** To roll piled logs off a skidway. (Gen.)
- Skip the grabs, to.** To release the skidding grabs from the log by means of a grab skipper (App.)
- Skipper, n.** 1. A sledge hammer with pointed ends which is used to pry skidding tongs loose from logs. (App.) *See* Grab skipper.

- Skipper road.** A skid road on which poles are placed zigzag across the road, the angle between skids being about 60 degrees; or a road on which poles are placed transversely at intervals of from 4 to 6 feet. (App.)
- Sky hooker.** *See* Top loader.
- Skyline, n.** The cable suspended between the head-spar tree and the tail tree in cableway logging, on which the trolley travels. (P. C. F.)
Syn.: aerial line, main line, standing line, track cable.
- Skyline logging.** Logging with a cableway skidder. (P. C. F.)
- Slab tie.** The third tie made from a stick of timber too small to make four ties and too large to make two ties. (S. F.)
- Slack puller.** 1. A power-operated device on an overhead steam skidder which pulls slack out of the skidding line when the trolley has been run out to the desired point in the run. (Gen.)
2. One who pulls slack on the skidding line of an overhead steam skidder. (S. F.)
- Slack-rope system.** A system of power logging in which the main skidding cable is returned from the machine to the logs by means of a smaller cable known as the "haul back" or messenger. (Gen.)
- Slack water.** 1. In river driving, the temporary slackening of the current caused by the formation of a jam. (Gen.)
2. Low water or dead water. (N. W.)
- Slant dam.** *See* Rafter dam.
- Slash, n.** 1. The débris left after logging, wind or fire. (Gen.)
Syn.: slashing.
2. Forest land which has been logged off and upon which the limbs and tops remain, or which is deep in débris as the result of fire or wind. (Gen.)
- Slash boards.** *See* Splash boards.
- Slashing, n.** *See* Slash.
- Sled tender.** 1. One who assists in loading and unloading logs or skidding with a dray. (N. F.)
Syn.: chainer (L. S.), chain tender, chaser, frogger.
- Sleigh.** *See* Logging sled.
- Slide, n.** A trough built of logs or timber, used to transport logs down a slope. (Gen.)
Syn.: chute, dry slide, slip.
- Slide tender.** One who keeps a slide in repair. (Gen.)
- Slip, n.** *See* Slide.
- Slip grab.** A pear-shaped link attached by a swivel to a skidding evener or whiffletree, through which the skidding chain is passed. The chain runs freely when the slip grab is held sideways, but catches when the grab is straight. (N. F.)
Syn.: grab link.
- Slip man.** *See* Pond man.
- Slipper, n.** *See* Rosser.
- Slip skids.** *See* Glisse skids.
- Slip-tongue cart.** A special form of logging wheels used for transporting logs. (S. F., P. C. F.) *See* Logging wheels.

- Sloop, n.** 1. A single pair of long sled runners, equipped with a tongue and bunks on which short logs are loaded. Used chiefly in farming communities. (N. W.)
2. *See* Bob.
- Sloop logs, to.** To haul logs down steep slopes on a dray or sloop equipped with a tongue. (N. F.)
- Slough pig.** Usually a second-rate river driver who is assigned to picking logs out of sloughs in advance of the rear. (N. F.)
- Sluice, v.** 1. *See* Flume.
2. To float logs through the sluiceway of a splash dam. (N. F.)
3. *See* Splash.
4. *See* Hand sluice.
- Sluice, n.** *See* Flume.
- Sluice gate.** The gate closing a sluiceway in a splash dam. (Gen.)
- Sluiceway, n.** The opening in a splash dam through which logs pass. (Gen.)
- Snag, n.** 1. A standing tree stem from which the crown has been broken. (Gen.) *See* Ram pike.
Syn.: stub.
2. A sunken log or a submerged stump. (Gen.)
- Snake, v.** *See* Skid.
- Snaking system.** A system of power logging in which the main cable is returned to the woods by an animal. (Gen.)
- Snaking trail.** *See* Gutter road.
- Snatch team.** *See* Tow team.
- Snib, v.** In river driving, to be carried away purposely, but ostensibly by accident, on the first portion of a jam that moves; to ride away from work under guise of being accidentally carried off. (N. W., L. S.)
- Snipe, v.** *See* Nose.
- Sniper, n.** One who noses logs before they are skidded. (Gen.)
- Snow a road, to.** To cover bare spots in a logging road with snow, to facilitate the passage of sleds. (N. F.)
- Snow slide.** A temporary slide on a steep slope, made by dragging a large log through deep snow which is soft or thawing; when frozen solidly, it may be used to slide logs to a point where they can be reached by sleds. (N. W.)
- Snub, v.** To check, usually by means of a snub line, the speed of logging sleds or logs on steep slopes, or of a log raft. (Gen.)
- Snubber, n.** A device consisting of a drum or drums, controlled by powerful hand or power brakes, or both, which is used in lowering logs or log ears on steep grades, by means of a cable. (P. C. F.)
- Snub line.** 1. A rope or cable attached to the rear bunk of a logging sled used to control the speed on steep grades. (N. W.)
2. A wire rope used with a donkey for snubbing logs, or log cars. (P. C. F.)
- Snub yoke.** The wheelers in an ox team. (App., S. F.) *See* Butt team; Wheelers.
- Softwood, a.** As applied to trees and logs, needle-leaved, coniferous. (Gen.)
- Softwood, n.** A coniferous tree. (Gen.)

- Solid jam.** 1. In river driving, a jam formed solidly and extending from bank to bank of a stream. (N. F.)
 2. A drive is said to be "in a solid jam" when the stream is full of logs from the point to which the rear is cleared to the mill, sorting jack or storage boom. (N. F.)
- Sorting boom.** A strong boom used to guide logs into the sorting jack, to both sides of which it is usually attached. (Gen.)
- Sorting gap.** See Sorting jack.
- Sorting jack.** A raft, secured in a stream, through an opening in which logs pass to be sorted by their marks and diverted into pocket booms or the downstream channel. (Gen.)
 Syn.: sorting gap.
- Sound knot.** A knot which is solid across its face, as hard as the surrounding wood, and so fixed that it will retain its place in the piece. (Gen.)
- Spanish windlass.** A device for moving heavy objects in logging. It consists of a rope or chain, within a turn of which a lever is inserted and power gained by twisting. (N. F.)
 Syn.: twister.
- Spar tree.** See Head-spar tree.
- Spider.** See Set gauge.
- Spiked skid.** A skid in which spikes are inserted in order to keep logs from sliding back when being loaded or piled. (Gen.)
- Spike knot.** A knot sawed in a lengthwise direction. (Gen.)
 Syn.: horn knot, mule-ear knot, slash knot. (P. C. F.)
- Spike peddler.** One who delivers spikes to spikers in a railroad track-laying crew. (S. F.)
- Splash, v.** To drive logs by releasing a head of water confined by a splash dam. (Gen.)
 Syn.: flood, sluice.
- Splash boards.** 1. Boards placed temporarily on top of a rolling dam to heighten the dam, and thus to increase the head of water available for river driving. (N. F.)
 Syn.: slash boards. (N. W.)
 2. A false gate placed on the upstream side of a lift gate as an aid in raising the latter. (N. W.)
- Splash dam.** A dam built to store a head of water for driving logs. (Gen.)
 Syn.: cut-away dam (E. C.), flood dam. (Gen.)
- Splicer, n.** One who splices cables on a logging operation. (P. C. F.)
- Split roof.** A roof of a logging camp or barn made by laying strips split from straight-grained timber. The strips run from the ridge pole to the eaves, and break the joints with other strips, as in a shingle roof. (N. F.)
- Spool donkey.** A donkey engine equipped with a spool or capstan, instead of a drum. (P. C. F.)
 Syn.: dolbeer (Cal.), gypsy yarder, donkey.
- Spool tender.** 1. One who guides the cable on a spool donkey. (P. C. F.)
 2. One who operates the loading drum on a donkey. (P. C. F.)
- Spot, v.** 1. See Blaze.
 2. To place logging cars at a loading point or opposite a landing. (S. F., P. C. F.)

Spotting line. A cable by which a log loader or power skidder moves itself for short distances; also a line used to pull empty log cars into position for loading. (S. F., P. C. F.)

Sprag. *See* Gooseneck.

Spreader, n. 1. A stout stick which holds apart the free ends of two chains which are attached to a large ring. The term is often applied to the entire rig. The spreader is used in skidding on rough bottom or on steep grades in place of a doubletree. (Gen.)

Syn.: equalizer, stretcher.

2. A piece of steel rail used to separate the loading hooks in loading with a gin pole. (P. C. F.)

Spring board. A short board, shod at one end with an iron calk, which is inserted in a notch cut in a tree, on which the faller stands while felling the tree. (P. C. F.) *See* Bucking Board.

Syn.: chopping board.

Spring pole. 1. A springy pole attached to the tongue of a logging sled and passing over the roll and under the beam, for holding the weight of the tongue off the horses' necks. (N. F.)

2. A device for steadying a cross-cut saw, so that one man can use it instead of two. (P. C. F.)

Sprinkler, n. A large wooden tank from which water is sprinkled over logging roads during freezing weather in order to ice the surface. (N. W., L. S.)

Syn.: ice box, tank, water box.

Sprinkler sleds. The sleds upon which the sprinkler is mounted. They consist of two sleds whose runners turn up at each end, fastened together by cross chains, and each having a pole, in order that the sprinkler may be hauled in either direction without turning around. (N. F.)

Spud, n. 1. A tool for removing bark. (Gen.)

Syn.: barking iron.

2. *See* Stump spud.

Spudder, n. *See* Barker.

Spur, n. A branch logging railroad. (Gen.)

Stag, v. To cut off trousers at the knee, or boots at the ankle. (N. F., P. C. F.)

Stamping hammer. *See* Marking hammer.

Standard, n. *See* Market.

Standard knot. 1. A knot that is sound and not over $1\frac{1}{2}$ inches in diameter. (S. F.)

Syn.: tight knot. (P. C. F.)

2. In hardwoods and cypress, a knot that is not more than $1\frac{1}{4}$ inches in diameter.

Standard lengths. Lengths into which rough lumber is cut for general use. The standard lengths in southern yellow pine are multiples of 2 feet, from 4 to 24 feet inclusive. In surfaced products, such as flooring, ceiling, drop siding, and like material, the standard lengths range in multiples of 1 foot, from 4 to 20 feet inclusive. Hardwood standard lengths run from 4 to 16 feet inclusive. In the province of Quebec, Canada, the standard lengths are 12 and 13 feet.

Standing line. *See* Skyline.

Start, n. A pin or pins fastened to the runners of a dray and holding in place the upper removable bar or bunk. (N. W.)

Starting bar. *See* Gee throw.

Stay boom. A boom fastened to a main boom and attached upstream to the shore to give added strength to the main boom. (Gen.)

Steam bucking saw. A portable steam-driven saw used for bucking logs at the landing. (Cal.)

Syn.: drag saw.

Steam dago. A power-driven log bucking device. (P. C. F.)

Steam hauler. A geared steam tractor used to haul loaded logging sleds over an iced road. It is equipped with a spiked metal belt which runs over sprocket wheels replacing the driving wheels, and is guided by a sled, turned by a steering wheel, upon which the front end rests. (N. F.)

Steam jammer. *See* Steam loader.

Steam loader. A machine operated by steam and used for loading logs upon cars. (Gen.)

Syn.: loader, steam jammer.

Steam skidder. *See* Skidder.

Steel crew. The crew which lays and takes up railroad track. (Gen.)

Stem winder. *See* Corkscrew.

Still water. That part of a stream having such slight fall that no current is apparent. Ant.: quickwater. (Gen.)

Syn.: deadwater.

Stock, n. The handle of a cant hook or peavey. (App.)

Stock logs, to. To deliver logs from stump to mill or railroad. (S. F.)

Stog, v. *See* Chink.

Storage boom. A strong boom used to hold logs in storage at a sawmill. (Gen.)

Syn.: holding boom, receiving boom.

Stow logs, to. In rafting, to place logs together and parallel within boom sticks which mark the outside of the raft section. (P. C. F.)

Straight line. The direct attachment of a pulling cable from a donkey engine to a log without the use of block and tackle. (P. C. F.)

Straw boss, n. A subforeman in a logging camp. (N. W., L. S.)

Syn.: head push.

Stray. 1. A marked log passing through the sorting gap of a boom company and about the disposition of which there have been no instructions given. (L. S.)

2. A log which has passed the mill where it should have been taken from the water. (N. F., E. C.)

3. *See* Prize log.

Straw line. In power skidding, a small cable which is used in changing the skidding lines from one run to another. (P. C. F.)

Syn.: grass line.

Stream jam. *See* Center jam.

Stretcher. *See* Spreader.

Stringer road. 1. *See* Fore-and-aft road.

- 2.** A tram road with sawed wooden rails, used for hauling logs. (App.)
- Strip, v.** To mark off strips for tie hackers. (R. M. F.)
- Strip, n.** An area of timber designated to be cut by a tie hacker. (R. M. F.)
- Strip road.** In a crosstie operation, a road cut out by the tie hacker on a given strip so that the haulers can reach the ties. (R. M. F.)
- Stub.** *See* Snag.
- Stull, n.** A timber used in a mine to support the sides and roofs of the passages. (Gen.) *See* Mine prop; Prop.
- Stumpage, n.** The value of timber as it stands uncut in the woods; or, in a general sense, the standing timber itself. (Gen.)
- Stump roller.** *See* Road roller.
- Stump spool.** *See* Road roller.
- Stump spud.** A tool with a crowbar point on one end and a small spoon-like shovel on the other end, used in digging holes under stumps, preparatory to placing a blasting charge. (P. C. F.)
Syn.: spud.
- Sulky.** *See* Logging wheels.
- Swamp, v.** To clear the ground of underbrush, fallen trees, and other obstructions preparatory to constructing a logging road, opening out a gutter road, skidding with animals, or yarding with a donkey engine. (Gen.)
- Swamper, n.** 1. One who swamps. (Gen.)
Syn.: beaver, busher, gutterman. (N. F.)
2. One who walks behind a horse truck loaded with logs and applies the brake. (Cal.)
3. *See* Gopher.
4. *See* Chore boy.
- Swamp hook.** A large, single hook on the end of a chain, used in handling logs, in skidding and in loading with a crosshaul. (Gen.)
Syn.: jam hook. (N. W.)
- Sway bar.** 1. A strong bar or pole, two of which couple and hold in position the front and rear bunks of a logging sled. They are provided with a knuckle joint which permits the bunks to be jackknifed when the sleds are traveling empty. (N. F.)
Syn.: side pole.
2. The bar used to couple together two logging cars. (Gen.)
- Sweep, n.** The natural crook in a log. (Gen.)
- Sweeps, n.** Trees overhanging a stream which impede log driving. (E. C.)
- Sweep the rear, to.** *See* Sack the rear, to.
- Swell butted.** As applied to a tree, greatly enlarged at the base. (Gen.)
Syn.: bottle butted, churn butted.
- Swifter, n.** 1. Logs which are placed across the end of a raft section in order to prevent the logs in the raft from having too much play. (P. C. F.)
2. A rope or cable placed across the end of the first tier of each raft section in order to hold the boom sticks in position. Swifterns are unnecessary where there are permanent booms to hold the raft sticks in place. (P. C. F.)
Syn.: cinch line.
- Swing, v.** *See* Gun.

- Swing dingle.** A single sled with wood-shod runners and a tongue with lateral play, used in hauling logs down steep slopes on bare ground. (N. F.)
Syn.: loose-tongued sloop.
- Swing donkey.** A donkey engine stationed between the yarding engine and the road engine or railroad. (P. C. F.)
- Swing team.** In a logging team of six, the pair between the leaders and the butt team. (Gen.)
- Swing yoke.** In an ox team of three or more yokes, the pairs between the leaders and the wheelers. (App., S. F.) *See* Swing team.
- Tag chain.** *See* Cross chain.
- Tag line.** In yarding with a donkey engine, an extra cable used for various purposes. It may serve as an extension to the main cable in order to reach logs beyond the range of the pulling line; also it may be used to attach a block to a log or serve some similar purpose. (P. C. F.)
- Tail chain.** A brake consisting of a heavy chain bound around the trailing end of logs, used to check the speed of sleds on steep slopes. (N. W.)
- Tail-down, to.** To roll logs on a skidway to a point on the skids where they can be easily reached by the loading crew. (N. F.)
Syn.: tail-in. (S. F.)
- Tail end.** *See* Rear.
- Tailer-in, n.** One who tails down for a loading crew. (S. F.)
Syn.: roll-down man. (S. F.)
- Tail grab.** *See* Single coupler.
- Tail hold.** 1. A means of obtaining increased power in moving a log by tackle. The cable is passed through a block attached to the log and the end fastened to a stationary object, so that hauling on the other end gives twice the power which would be attained by direct attachment of the cable to the log. (P. C. F.)
2. The attachment of the rear end of a donkey sled, usually to a tree or stump. (P. C. F.)
- Tail hook.** *See* Dog.
- Tail-in, to.** *See* Tail-down, to.
- Tail tree.** In power skidding, a tree at the end of a run to which the tackle is fastened. (S. F., P. C. F.)
- Takoma.** *See* Roader.
- Tally board.** A thin, smooth board used by a scaler to record the number or volume of logs. (Gen.)
- Tally man.** One who records or tallies the measurements of logs as they are called by the scaler. (N. F.)
- Tank, n.** *See* Sprinkler.
- Tank conductor.** One who has charge of the crew which operates a sprinkler or tank, and who regulates the flow of water, in icing logging roads. (N. F.)
- Tank heater.** A sheet-iron cylinder extending through a tank or sprinkler, in which a fire is kept to prevent the water in the tank from freezing while icing logging roads in extremely cold weather. (N. F.)
- Tanking.** The act of hauling water in a tank, to ice a logging road. (N. F.)
- Tap line.** A chartered logging railroad which shares with the trunk line railroads in a division of the through lumber rate to market, on products originating at the plant of the owners of the logging railroad. (S. F.)

Team boss. One who has charge of the skidding teams in a logging operation. (S. F.)

Syn.: captain.

Tee, n. A strip of iron about 6 inches long with a hole in the center, to which a short chain is attached; it is passed through a hole in a gate plank, turned crosswise, and so used to hold the plank when tripped in a splash dam. (N. W.)

Syn.: toggle. (R. M. F.)

Thousand legs. See Corkscrew.

Three-block hold. See Block hold.

Throw, v. See Wedge a tree, to.

Throw line. See Trip line.

Throw out. See Frog.

Tide, n. A freshet. In the Appalachian region logs are rolled into a stream and a "tide" awaited to carry them to the boom. (App.)

Tie chopper. See Tie hacker.

Tie cutter. See Tie hacker.

Tie hack. See Tie hacker.

Tie maker. See Tie hacker.

Tier, n. In rafting, the group of parallel logs which are stowed in each raft section. (P. C. F.)

Tight knot. See Standard knot.

Timber, n. 1. A term which may have any of the following meanings: wood suitable for building houses and ships, and for use in carpentry and joinery; trees cut down and squared or capable of being squared or cut into beams, rafters, boards, etc.; growing trees suitable for constructive purposes; trees generally; woods or a single piece of wood, whether suitable for use or already in construction; the body, stem, or trunk of a tree. The meaning to be given to the term depends upon the connection in which it is used and sometimes upon the occupation of the person who uses the term. (Supreme Court of Georgia, 52 Southeastern Reporter, 324.)

2. A term which has a restricted meaning depending on the connection in which it is employed. It may refer to standing trees or stems, or trunks of trees cut and shaped for use in the erection of buildings or other structures and not manufactured into lumber, within the ordinary meaning of "lumber." It does not ordinarily refer to the articles manufactured therefrom, such as shingles, lath, fence rails, railroad ties, etc. (Supreme Court of North Carolina, 82 Southeastern, 1036.)

Timber beast. See Lumberjack.

Timber carrier. See Lug hooks.

Timber compass. See Gun.

Timber contract. See Timber right.

Timber grapple. See Lug hooks.

Timber plugger. One who surreptitiously plugs knot holes and bad knots, especially on spar timber. (S. F.)

Timber right. A term used to denote the purchase of standing timber, without the acquisition of title to the land (Gen.)

Syn.: timber contract.

Timber wheels. *See* Logging wheels.

Toe piling. Sharpened poles or timbers which are driven next to the upstream face of the mudsills of a dam to prevent water from getting under the foundations. (Gen.)

Syn.: toe spiling.

Toe ring. The heavy ring or ferrule on the end of a cant hook. It has a lip on the lower edge to prevent slipping when a log is grasped. (Gen.)

Toe spiling. *See* Toe piling.

Toggle, n. *See* Toc.

Toggle chain. 1. A short chain with a ring at one end and a toggle hook and a ring at the other, fastened to the sway bar or bunk of a logging sled and used to regulate the length of a binding chain. (N. F.)

Syn.: bunk chain.

2. *See* Boom chain.

Toggle hook. A grab hook with a long shank, used on a toggle chain. (N. F.)

Tombstone, n. A slab torn from the bole, which adheres to the stump when a tree is felled. (S. F.)

Tommy Moore. *See* Bull block.

Tong, v. To handle logs with skidding tongs. (N. F.)

Tong hooker. 1. One who places the skidding tongs or chokers on logs which are being skidded by power or hauled on high-wheeled carts. (S. F.)

2. *See* Ground loader.

Tong puller. *See* Ground loader.

Tong unhooker. One stationed near the power skidder who releases the skidding tongs or removes the chokers from logs which have been drawn alongside the railroad. (S. F.)

Top bind chains. *See* Top chains.

Top chains. Chains used to secure the upper tiers of a load of logs after the capacity of the regular binding chains has been filled. (Gen.)

Syn.: top bind chains. (S. F.)

Top load. A load of logs piled more than one tier high, as distinguished from a bunk load. (Gen.)

Top leader. That member of a loading crew who stands on the top of a load and places logs as they are sent up. (Gen.)

Syn.: sky hooker. (N. F.)

Top-lop, v. *See* Lop.

Tote, v. To haul supplies to a logging camp. (N. F.)

Tote road. A road used for hauling supplies to a logging camp. (N. F.)

Syn.: fly road, hay road.

Tote sled. *See* Jumper.

Tow team. An extra team stationed at an incline in a logging road to assist the regular teams in ascending with loaded sleds. (N. F.)

Syn.: snatch team.

Traction, n. An oil burning or a gasoline traction engine used in hauling log trucks. (Cal.)

Trail, v. *See* Jigger.

Trail, n. 1. *See* Turn.

2. The path traveled by a team when trailing logs in a chute. (R. M. F.)

Trail chute. *See* Trailing slide.

Trail dogs. *See* Grapples.

Trailers, n. Several logging sleds hitched one behind another and pulled by from 4 to 8 horses driven by one man, thus saving teamster's wages; also applied to sleds or wagons drawn by a steam or gasoline log hauler. (N. F., E. C.)

Trailing slide. A slide on which the grade is so low that animals are required to move the logs. (App.)

Syn.: trail chute. (R. M. F.)

Trail slide. An earth skidding trail, reinforced on the lower side by a fender skid. (App.)

Train, n. *See* Turn.

Tram, n. *See* Tramway.

Tramway, n. A light or temporary railroad for the transportation of logs often with wooden rails and operated by horse power. (Gen.)

Syn.: tram.

Trap boom. *See* Catch boom.

Travois, n. *See* Go-devil.

Travois road. *See* Skid road.

Trip, v. *See* Wedge a tree, to.

Trip, n. *See* Turn.

Trip a dam, to. To remove the planks which close a splash dam. (N. F.)

Trip line, n. 1. A light rope attached to a dog hook, used to free the latter when employed in breaking a jam, a skidway or a load. (N. F.)

Syn.: throw line.

2. *See* Haul back.

Tripsill, n. A timber placed across the bottom of the sluiceway in a splash dam, against which rest the planks by which the dam is closed. (Gen.)

Trolley, n. A traveling block used on a skyline in steam skidding. (S. F., P. C. F.)

Syn.: bicycle, carriage (S. F., P. C. F.), buggy. (Cal.)

Trough roof. A roof on a logging camp or barn, made of small logs split lengthwise, hollowed into troughs and laid from ridge pole to eaves. The joints of the lower tier are covered by inverted troughs. (N. F.)

Truck, n. 1. A heavy wagon used to haul logs, either with animal or power traction. (Gen.)

2. *See* Logging truck.

Truck driver. A teamster who skids logs with a bumper.

Tump line. Two leather straps sewed or buckled to a leather head strap about four inches wide, and used to carry packs. (E. C.)

Turkey, n. A bag containing a lumberjack's outfit. To "histe the turkey" is to take one's personal belongings and leave camp. (N. W., L. S.)

See Duffle bag.

Turn, n. 1. A single trip and return made by one team in hauling logs—*e.g.*, a four-tun road is a road the length of which will permit only four round trips per day. (N. F.)

Syn.: trip. (Gen.)

2. Two or more logs coupled together end to end for hauling. (P. C. F.)

Syn.: trail, train.

- Turn-around**, *n.* A cleared area, surrounding a bunched pile of logs, in which logging wheels turn. (Texas.)
- Turner**. *See* Log roller.
- Turnout**, *n.* A short side road from a logging-sled road, to allow loaded sleds to pass. (N. W., L. S.)
- Twin sled**. *See* Logging sled.
- Twister**, *n.* 1. *See* Spanish windlass.
2. *See* Camp foreman.
- Twitch**, *v.* *See* Skid.
- Two-block hold**. *See* Block hold.
- Two-faced tie**. A pole tie with only two hewed faces. It is made from a stick of timber too small to hew four sides. (S. F.)
- Two sled**. *See* Logging sled.
- Undercut**, *v.* *See* Notch.
- Undercut**, *n.* The notch cut in a tree to determine the direction in which the tree is to fall, and to prevent splitting. (Gen.)
Syn.: notch (Gen.), nick (S. F.), box (N. F.).
- Undercut hold**. A method of arranging the choker on a log so that when a forward pull is exerted the log will roll backward. (P. C. F.)
Syn.: underhold roll.
- Undercutter**, *n.* 1. A skilled woodsman who chops the undercut in trees so that they shall fall in the proper direction. (Gen.)
2. A tool used to support the back of a cross-cut saw when a bucker is making a cut from the under side of a log. (P. C. F.)
- Underhold roll**. *See* Undercut hold.
- Union drive**. A drive of logs belonging to several owners, who share the expense pro rata. (N. F.)
- Upright roller**. *See* Road roller.
- Value**, *v.* *See* Cruise.
- Valuer**, *n.* *See* Cruiser.
- Van**, *n.* 1. The small store in a logging camp in which clothing, tobacco, and medicine are kept to supply the crew. (N. W., L. S.) *See* Commissary.
Syn.: wanigan. (N. W.)
2. Clothing and small wares supplied to woodsmen. (E. C.)
- Wagon sled**. *See* Logging sled.
- Wane**, *n.* Bark or the lack of bark or a decrease in wood from any cause on the edge of a board, plank, or timber. (Gen.)
- Wanigan**, *n.* 1. A houseboat used as sleeping quarters or as kitchen and dining-room by river drivers. (N. W., L. S.)
2. The outfit of a logging crew, especially of a log-driving crew. (N. W.)
3. *See* Van.
- Warp**, *v.* To tow a boom of logs with a headworks or alligator.
Syn.: kedge.
- Waste**, *n.* On a logging operation, that portion of the tree which has merchantable value, but is not utilized. The standard varies with the species, location of the timber, and market conditions. (Gen.)
- Water box**. *See* Sprinkler.
- Water buck**. One who packs water, either for a logging crew or for a donkey engine. (Cal.)

- Water ladder.** Pole guides up and down which a barrel slides in filling a sprinkler by horse power. (N. W., L. S.)
- Water slide.** *See* Flume.
- Water stain.** Streaks or patches of red or brown discoloration in firm wood of hemlock.
- Water streak.** A dark streak in oak lumber due to injury to the standing timber. (App.)
- Weaver's bind.** A method of binding chains around logs on a dray. (N. W.)
- Wedge a tree, to.** To topple over with wedges a tree that is being felled. (Gen.)
Syn.: throw, trip.
- Well, n.** A hole dug in the snow surrounding a tree in order that the chopper may cut the tree at the required height. (R. M. F.)
- Wet slide.** *See* Flume.
- Wheel camp.** 1. An operation in which the logs are transported to the skidways on logging wheels. (Cal.)
2. A camp, the quarters of which are mounted on railroad trucks. (P. C. F.)
- Whealers, n.** In a team, the pair next to the load. (App., E. C., S. F.).
See Snub yoke.
Syn.: butt team.
- Whiffletree neckyoke.** A heavy logging neckyoke, to the ends of which short whiffletrees are attached by rings. From the ends of the whiffletrees wide straps run to the breeching, thus giving the team added power in holding back loads on steep slopes. (N. F.)
- Whip-poor-will, n.** A small log fastened diagonally across a log slide and used to shunt logs onto a dump. (App.)
Syn.: jumper.
- Whistle boy.** One who transmits orders from the foreman of a skidding crew to the engineer of a pullboat. (S. F.)
- Whistle punk.** *See* Signal man.
- White water.** *See* Quick water.
- White water man.** A log driver who is expert in breaking jams on rapids or falls. (N. F.)
- Widow maker.** 1. A broken limb hanging loose in the top of a tree, which in its fall may injure a man below (N. F.); or a breaking cable (P. C. F.).
Syn.: deadman. (N. W.)
2. A tree which in falling is lodged in the top of another. (App.)
- Wigwam, to make a.** In felling trees, to lodge several in such a way that they support each other. (N. F.)
- Windfall, n.** An area upon which the trees have been thrown by wind; also, a single tree thrown by wind. (Gen.)
Syn.: blow down, wind slash.
- Windshake, n.** *See* Shake.
- Wind slash.** *See* Windfall.
- Wind splitter.** *See* Peaker.
- Wing dam.** *See* Pier dam.
- Wing jam.** A jam which is formed against an obstacle in the stream and

slants upstream until the upper end rests solidly against one shore, with an open channel for the passage of logs on the opposite side. (N. F.)

Woodboat, n. A single sled with two skids attached by their forward ends to the bunk, and with their rear ends dragging, which is used to haul cordwood off of steep or rocky slopes. (N. W.)

Wood buck. *See* Wood bucker.

Wood bucker. One who cuts wood for a donkey, road engine, or other power skidding device. (P. C. F., R. M. F.)

Syn.: wood buck.

Woodhick. *See* Lumberjack.

Wood passer. One who transports wood fuel in a flatboat from the cutting point to a pullboat. (S. F.)

Woodpecker, n. A poor chopper. (Gen.)

Syn.: beaver. (N. W.)

Wrapper chain. *See* Binding chain.

Yard, v. *See* Skid; Rank.

Yard, n. *See* Skidway; Landing.

Yarding donkey. A donkey engine mounted upon a heavy sled, used in yarding logs by drum and cable. It hauls logs from the stump to a skidroad or to a landing, for short distances only. *See* Half-breed; Roader; Donkey.

Yarding hook tender. *See* Hook tender.

Yarding sled. *See* Dray.

Yarding spool. *See* Road roller.

Yard tender. *See* Decker.

Yoke, n. The heavy U-shaped part of a block by which the block is attached to an object. (Gen.)

Syn.: gooseneck, shackle.

LOGGING CAMP KITCHEN UTENSILS

TABLE X
TABLE AND COOKING UTENSILS
Required for a Northern Camp Feeding Fifty Men¹

Table Utensils			
Dinner Plates.....	50	Soup Ladles.....	9
Soup Plates.....	50	Sugar Bowls.....	9
Coffee and Tea Dippers (1 pint)	50	Bowls for Sauce and Pickles....	18
Forks.....	50	Vinegar Bottles.....	9
Knives.....	50	Molasses Jugs.....	9
Table Spoons.....	50	Pepper Shakers.....	9
Tea Spoons.....	50	Salt Shakers.....	9
Vegetable Dishes, 6-inch.....	18	Bumpers, 2 quart.....	18
Platters, 8-inch.....	9	Bumpers, 1 quart.....	9
Cooking Utensils			
Roast Pan, 17 × 17 × 4 inches, heavy iron, with cover.....	1	Chopping Knives.....	1
Biscuit and Cake Pans.....	6	Dippers, long handled.....	1
Fry Pan.....	1	Dipper, short handled.....	1
Bread Tins.....	18	Faucets.....	2
Bean Pots, large.....	2	Nutmeg Grater.....	1
Lard Frying Kettle with Drainer	1	Sieves.....	1
Beef Boilers, heavy.....	2	Skimmers.....	3
Coffee and Tea Boilers.....	2	Mixing Spoons.....	3
Kettles, enamelled.....	2	Carving Knife.....	1
Wash Boilers.....	1	Bread Knife.....	1
Pastry Board.....	1	Meat Fork.....	1
Chopping Bowl.....	1	Doughnut Cutter.....	1
Lunch Buckets.....	..	Biscuit Cutter.....	1
Fireless Cooker, complete.....	1	Rolling Pin.....	1
Meat Chopper.....	1	Meat Cleaver.....	1
Water Pails.....	3	Meat Saw.....	1
Mixing Pans.....	2	Flour Sifter.....	1
Dish Pans, large.....	2	Grease Brush.....	1
Butcher Knives.....	1	Can Opener.....	1

¹ Reported at the First Annual Conference of the Woods Department Berlin Mills Co., et al, Nov. 25 and 26, 1913.

General Utensils

Cook Stoves	2	Towels	
Brooms		Rags	
Alarm Clock	1	Scrubbing Pails	2
Kerosene Oil Cans	2	Mop Wringers	2
Hanging Lamps	12	Mop Handles	2
Hand Lamps	1	Wash Basin	1
Lanterns	2	Wash Board	1
Matches	Pot Glove (or cleaner)	1
Soap	Brush for pots, etc.	1

ANIMAL RATIONS

TABLE XI
WOLFF-LEHMANN FEEDING STANDARDS¹

[Showing amounts of nutrients per 1000 pounds live weight for one day's feeding.]

Animal	Total dry matter	Digestible nutrients			Fuel ³ value
		Protein	Carbohydrates	Fat	
	Pounds	Pounds	Pounds	Pounds	Calories ⁴
Oxen: ²					
At rest in stall.....	18	0.7	8.0	0.1	16,600
At light work.....	22	1.4	10.0	0.3	22,500
At medium work.....	25	2.0	11.5	0.5	27,200
At heavy work.....	28	2.8	13.0	0.8	32,755
Horses.....					
At light work.....	20	1.5	9.5	0.4	22,150
At medium work.....	24	2.0	11.0	0.6	26,700
At heavy work.....	26	2.5	13.3	0.8	32,750

¹ From The Feeding of Farm Animals, by E. W. Allen. Farmers' Bulletin No. 22, U. S. Department of Agriculture, Washington, D. C., 1901, p. 12.

² For an unworked ox of 1000 pounds weight, the standard calls for 0.78 pound of digestible protein, 8 pounds of digestible carbohydrates, and 0.1 pound of digestible fat, which would furnish 16,600 calories of heat and energy. When heavily worked the same ox would require, according to the standard, food with four times as much protein and of nearly twice the fuel value.

³ The value of food to produce heat for the body and energy for work is measured in calories and is calculated from the nutrients digested. The fuel value of one pound of digestible fat is estimated to be 4230 calories and of one pound of digestible protein or of carbohydrates about 1860 calories. The total value of a feeding stuff is found by using these factors, the equivalents for the common foods being given on pages 134 and 135.

⁴ A calorie is the amount of heat required to raise the temperature of one pound of water about 4 degrees.

TABLE XII

DRY MATTER AND DIGESTIBLE FOOD INGREDIENTS IN 100
POUNDS OF FEEDING STUFFS¹

Feeding stuff	Total dry matter	Protein	Carbohydrates	Fat	Fuel value
	Pounds	Pounds	Pounds	Pounds	Calories
Green fodder:					
Corn fodder (average of all varieties).....	20.7	1.10	12.08	0.37	26,076
Kafir-corn fodder.....	27.0	0.87	13.80	0.43	29,101
Rye fodder.....	23.4	2.05	14.11	0.44	31,914
Oat fodder.....	37.8	2.44	17.99	0.97	42,093
Redtop, in bloom.....	34.7	2.06	21.24	0.58	45,785
Orchard grass, in bloom.....	27.0	1.91	15.91	0.58	35,593
Meadow fescue, in bloom.....	30.1	1.49	16.78	0.42	35,755
Timothy, at different stages.....	38.4	2.01	21.22	0.64	45,909
Kentucky blue grass.....	34.9	2.66	17.78	0.69	40,930
Hungarian grass.....	28.9	1.92	15.63	0.36	34,162
Red clover, at different stages.....	29.2	3.07	14.82	0.69	36,187
Crimson clover.....	19.3	2.16	9.31	0.44	23,191
Alfalfa, at different stages.....	28.2	3.89	11.20	0.41	29,798
Cowpea.....	16.4	1.68	8.08	0.25	19,209
Soy bean.....	28.5	2.79	11.82	0.63	29,833
Rape.....	14.3	2.16	8.65	0.32	21,457
Corn silage (recent analyses).....	25.6	1.21	14.56	0.88	33,046
Corn fodder, field cured.....	57.8	2.34	32.34	1.15	69,358
Corn stover, field cured.....	59.5	1.98	33.16	0.57	67,766
Hay from —					
Barley.....	89.4	5.11	35.94	1.55	82,894
Oats.....	84.0	4.07	33.35	1.67	76,649
Orchard grass.....	90.1	4.78	41.99	1.40	92,900
Redtop.....	91.1	4.82	46.83	0.95	100,078
Timothy (all analyses).....	86.8	2.89	43.72	1.43	92,729
Kentucky blue grass.....	78.8	4.76	37.46	1.99	86,927
Hungarian grass.....	92.3	4.50	51.67	1.34	110,131
Meadow fescue.....	80.0	4.20	43.34	1.73	95,725
Mixed grasses.....	87.1	4.22	43.26	1.33	93,925
Mixed grasses and clover.....	87.1	6.16	42.71	1.46	97,059
Red clover.....	84.7	7.38	38.15	1.81	92,324
Alsike clover.....	90.3	8.15	41.70	1.36	98,460
White clover.....	90.3	11.46	41.82	1.48	105,346
Crimson clover.....	91.4	10.49	38.13	1.29	95,877
Alfalfa.....	91.6	10.58	37.33	1.38	94,936
Cowpea.....	89.3	10.79	38.40	1.51	97,865
Soy bean.....	88.7	10.78	38.72	1.54	98,569
Wheat straw.....	90.4	0.37	36.30	0.40	69,894
Rye straw.....	92.9	0.63	40.58	0.38	78,254
Oat straw.....	90.8	1.20	38.64	0.76	77,310
Soy-bean straw.....	89.9	2.30	39.98	1.03	82,987
Roots and tubers:					
Mangel-wurzels.....	9.1	1.03	5.65	0.11	12,889
Turnips.....	9.5	0.81	6.46	0.11	13,986
Ruta-bagas.....	11.4	0.88	7.74	0.11	16,497
Carrots.....	11.4	0.81	7.83	0.22	16,999

¹ From The Feeding of Farm Animals, by E. W. Allen. Farmers' Bulletin No. 22, U. S. Department of Agriculture, Washington, D. C., 1901, p. 8.

TABLE XII

DRY MATTER AND DIGESTIBLE FOOD INGREDIENTS IN 100 POUNDS OF FEEDING STUFFS—*Continued.*

Feeding stuff	Total dry matter	Protein	Carbohydrates	Fat	Fuel value
	Pounds	Pounds	Pounds	Pounds	Calories
Grains and other seeds:					
Corn (average of dent and flint)	81.1	7.14	66.12	4.97	157,237
Kafir corn	87.5	5.78	53.58	1.33	116,022
Barley	89.1	8.69	64.83	1.60	143,499
Oats	89.0	9.25	48.34	1.18	124,757
Rye	88.4	9.12	69.73	1.36	152,400
Wheat (all varieties)	89.5	10.23	69.21	1.68	154,848
Cottonseed (whole)	89.7	11.08	33.13	18.44	160,017
Mill products:					
Corn meal	85.0	6.26	65.26	3.50	147,797
Corn-and-cob meal	84.9	4.76	60.06	2.94	132,972
Barley meal	88.1	7.36	62.88	1.96	138,918
Ground corn and oats, equal parts	88.1	7.01	61.20	3.87	143,202
Pea meal	89.5	16.77	51.78	0.65	130,216
Waste products:					
Rye bran	88.2	11.47	52.40	1.79	126,352
Wheat bran, all analyses	88.5	12.01	41.23	2.87	111,138
Wheat middlings	84.0	12.79	53.15	3.40	136,996
Wheat shorts	88.2	12.22	49.98	3.83	131,855
Buckwheat bran	88.5	19.29	31.65	4.56	113,992
Buckwheat middlings	88.2	22.34	36.14	6.21	134,979
Cottonseed feed	92.0	9.65	38.57	3.37	103,911
Cottonseed meal	91.8	37.01	16.52	12.58	152,653
Cottonseed hulls	88.9	1.05	32.21	1.89	69,839
Linseed meal (old process)	90.8	28.76	32.81	7.06	144,313
Linseed meal (new process)	90.1	30.59	38.72	2.90	141,155

TABLE XIII

RATIONS ACTUALLY FED TO HORSES AND DIGESTIBLE NUTRIENTS AND ENERGY IN RATIONS CALCULATED TO A BASIS OF 1000 POUNDS LIVE WEIGHT¹

Kind of horses	Weight of horses.		Nutrients in ration per 1000 pounds live weight				Digestible nutrients in rations per 1000 pounds live weight				Energy in digestible nutrients.
	Lbs	Rations actually fed	Protein.	Fat.	Nitrogen-free extract.	Crude fiber.	Protein.	Fat.	Nitrogen-free extract.	Crude fiber.	
	Lbs	Lbs	Lbs	Lbs	Lbs	Lbs	Lbs	Lbs	Lbs	Lbs	Calories
<i>Army horses²</i>											
United States:											
Cavalry.....	1050	{ Oats, 12.... Hay, 14....	2.14	0.90	12.82	4.95	1.25	0.57	8.00	1.97	23,309
Artillery.....	1125	{ Oats, 12.... Hay, 14....	2.00	0.84	11.96	4.62	1.16	0.53	7.48	1.84	21,750
Mules.....	1025	{ Oats, 9.... Hay, 14....	1.84	0.78	11.39	4.80	1.00	0.48	6.88	1.94	20,250
<i>Farm horses</i>											
General average for moderate work.											
	2.38	0.77	11.99	4.08	1.49	0.42	8.09	1.63	22,710
<hr/>											
Farm mules, Virginia Station.	1310	{ Hay, 15 2 Corn, 10.5 Corn silage 10 5	1.70	0.82	12.00	4.00	0.72	0.42	8.22	1.75	21,655
Average of 6, including above.	1.64	0.78	11.54	3.74	0.69	0.39	7.95	1.60	20,675
<hr/>											
<i>Horses with severe work.</i>											
Truck and draft horses:											
Chicago, Ill., daily ration.	1500	{ Oats, 7.5.... Hay, 20....	1.38	0.58	8.99	4.34	0.64	0.34	5.11	1.79	15,450
South Omaha, Neb....	1500	{ Oats, 15.... Hay, 12....	1.65	0.70	9.57	3.27	1.04	0.45	6.23	1.27	17,800
Average of 5, including above.	1.80	0.76	10.49	3.49	1.12	0.49	6.94	1.35	19,560
<hr/>											
<i>Feeding standards and average rations.</i>											
<i>American experiments.</i>											
Horses with light work:											
Driving horses.....	1.58	0.22	5.27	1.18	15,895
General average.....	0.99	0.32	5.06	1.24	14,890
Horses with moderate work:											
Express and cab horses.....	1.06	0.49	7.33	1.72	20,860
Farm horses.....	1.57	0.40	8.09	1.62	22,760
General average.....	1.49	0.42	8.09	1.63	22,710
Mules with moderate work: Farm mules.	0.69	0.39	7.95	1.60	20,675
Horses with severe work: Truck and draft horses.	1.12	0.49	6.94	1.35	19,560

¹ From Principles of Horse Feeding, by C. F. Langworthy. Farmers' Bulletin No. 170, U. S. Department of Agriculture, Washington, D. C., 1903, p. 31.

² The standard salt allowance is 2 ounces weekly.

TABLE XIV
RATIONS FED BY LOGGERS

<i>Horses:</i>		
Heavy work at a sawmill, Canada	15 pounds hay. 10 pounds ground grain. 1 pound bran. 8 pounds oats.	Barley 1 to 1. Oats.
Maine logging operation.	10½ pounds corn. 12 pounds oats. 20 pounds hay.	Animals weighing about 1600 pounds each.
<i>Mules:</i>		
Louisiana logging operation.	13½ pounds corn-alfalfa. 5 pounds chops. 16 pounds hay.	Animals weighing about 1300 pounds each.
Missouri logging operation.	8 pounds oats. 7 pounds corn. 20 pounds hay.	Animals weighing from 1200 to 1300 pounds each.
<i>Oxen.</i>		
Mississippi logging operation.	20 pounds cottonseed hulls. 5 pounds cottonseed meal. 10 pounds hay.	
Alabama logging operation.	21 pounds corn. Corn fodder (unlimited).	
Louisiana logging operation.	26 pounds corn. 14 pounds hay.	

TABLE XV
WEIGHT OF FEEDING STUFFS PER QUART¹

Feeding stuff	Pound	Ounces
Corn, cracked.....	1	12
Corn meal.....	1	8
Corn-and-cob meal.....	1	6
Oats, whole.....	1	...
Oats, ground.....	...	12
Wheat, whole.....	1	14
Wheat bran.....	...	10
Wheat bran, coarse.....	...	8
Wheat middlings.....	1	2
Wheat middlings, coarse.....	...	13
Rye bran.....	...	10
Gluten meal.....	1	11
Gluten feed.....	1	3
Linseed meal.....	1	2
Cottonseed meal.....	1	8

¹ From The Feeding of Farm Animals, by E. W. Allen. Farmers' Bulletin No. 22, U. S. Department of Agriculture, p. 19, Washington, D. C., 1901.

INDEX

(Numbers refer to pages. Illustrations are indicated by an asterisk after page number.)

A

- Abutments, for improvement of stream banks, 399, 399*.
- Acid-wood, 22.
 - transport in flumes, 433, 436, 450.
- Acts, Workmen's Compensation, 57.
- Adirondaek Mountain region, length of logs cut in, 110.
 - log brands in, 410.
 - pulpwood flume in, 434.
 - skidding with animals in, 145.
- Aerial tramways, 255.
 - California, 260.
 - Idaho, 258.
 - Northwest, 256.
 - Tennessee, 255.
- Alabama, cars and locomotives used on an operation in, 358.
- Alder, resistance of wood in cross-cut sawing, 86.
- Alligator for log towing, 417.
- American log loader, Model C, 362*, 363.
 - Model D, 363.
- Angle bar, 324, 324*, 325.
- Animal draft, 129.
 - for headworks, 417.
 - for power logging, 230.
 - movement of earth with, 302.
 - wagons, 191.
- Animals, barns for, 67.
- Animals, corrals for, 69.
 - decking logs with, 138.
 - "drumming" with, 149.
 - feed stuffs for, 526.
 - feeding standards, 525.
 - hand logging with, 145.
 - hauling, bummers, 184.
 - cars, 280, 281.
 - carts, 189.
 - pole roads, 280.
 - sleds, 177, 178.
 - snow plows, 171.
 - sprinklers, 173.
 - wagons, 190, 192.
 - horses, 131.
 - loading log cars with, 360.
 - mules, 132.
 - output per team, skidding, 156.
 - oxen, 130.
 - picking rear with, 416.
 - rations for, 132, 528.

- Animals, snaking logs with, 145.
 stables for, 67.
 trips, daily, with two sleds, 178.
 water for, 134.
- Appalachians, chutes in, 270.
 drumming in, 149.
 hand logging in, 144.
 log marks and brands used in, 411.
 slides in, 262.
 snaking with animals in, 146.
 stringer railroads in, 281, 282.
- Arkansas, bummers used in, 184.
 railroad spur grade in, 295, 295*.
- Arresters, spark, 251, 350.
 locomotive, 350.
 Radley-Hunter, 351, 352*.
 Sequoia, 351, 351*.
 power skidder, 251.
 Boomerang, 251*, 252.
 South Bend, 251, 251*.
- Ash, 7, 20.
 buoyancy of, 413.
 lumber cut, 1919, 20.
 stand, by regions, 7.
 per acre, 20.
 United States, 7.
- Aspen, resistance of wood in cross-cut sawing, 86.
 saw timber, stand, by regions, 7.
 United States, 7.
- Assorting gap, 403*, 405, 405*, 406*.
- Assorting, log, 402, 405.
- Ax, broad, 83, 83*.
 falling, 82, 83*.
 felling timber with, 106.
 handles for, 82, 83.
 turpentine, 83, 83*.
 weight of, 82, 83, 117.

B

- Back spiking, railroad track, 330.
- Bag boom, 420.
- Ballast, brush, for railroad track, 321.
- Balsam, buoyancy of, 413.
- Bank, breaking down a, 415.
- Banking grounds, 414.
- Baptist cone, 237.
- Barge boom, 400, 402.
- Barge, log, 430.
- Bark mark, 410.
- Bark, peeling of, 99.
- Barking or rossing, 116.
- Barn-door sluice gate, 397.
- Barnhart log loader, 361.
- Barns, board, 67.
 car, 67, 68, 68*.
 log, 63.
 size, 65, 67.
 tent, 67.
- Bars, angle, 324, 324*, 325.

- Basswood, 19.
 buoyancy of, 412, 413.
 lumber cut, 1920, 19.
- Bateaux, 413.
- Bear-trap sluice gate, 394, 394*.
- Beech, 7, 18.
 buoyancy of, 412, 413.
 lumber cut, 1920, 18.
 resistance of wood in cross-cut sawing, 86.
 saw timber, stand, by regions, 7.
 United States, 7.
- Bibliography, 455.
- Birch, 7, 18.
 buoyancy of, 412, 413.
 paper, 19.
 per cent of logs lost on drives, 384.
 preparation for floating, 412.
 resistance of wood in cross-cut sawing, 86.
 stand, by regions, 7.
 per acre, 19.
 United States, 7.
- Blacksmith tools, 64.
- Blade, saw, 84, 85.
- Blasting, rock, drilling, 304.
 explosives for, 306, 310.
 loading holes, 308.
 primers and priming for, 308.
 safety fuse and caps, 308.
 tamping, 310.
 stumps, 311.
- Boards, spring, 92, 92*.
- Bob, 161.
- Bole, utilization of, 109, 113.
- Bolts, shingle, 22.
 stave, 22.
- Bonus, Brown's Bay System, 43, 44.
 felling and log-making, 47.
 task system, 48.
 waste elimination, 47.
- Boom, bag or sack, 420.
 barge, 400, 402.
 bracket, 400, 401.
 catch, 416.
 chain, 400, 400*.
 companies, 408.
 Canada, 408.
 liability of, 409.
 fin, 400, 401*.
 harbor, 426.
 limber, 400.
 plug, 400.
 round, 426.
 sheep-shank, 400.
 sheer, 400.
 sticks, 403.
 stiff, 400.
 storage, 403.
 towing, 400.
 trap, 416.
- Box, flume and log sluice, 433.

- Box, flume and log sluice, square-box, 436.
 V-box, 434.
- Bracket boom, 400, 401.
- Bracket or needle gate, logging dam, 395, 397*.
- Brands, log, 409, 410*.
 dehorning, 411.
 legal status of, 411.
 recording, 411.
 validity of, Minnesota, 411.
- Breakage of bole in felling, 47, 101.
- Bridge, crib, 319, 319*.
 sled, 169.
 truss, 318.
- British Columbia, hand-logging in, 145.
- Broad gauge railroad, 285.
 cars for, 353.
 flat, 353.
 chains for, 354.
 stakes for, 353.
 skeleton, 354.
 trucks, 355.
- Brush, ballast, railroad, 321.
 disposal of, Colorado, 28.
 National Forests, 28.
- Brutting, 144.
- Bucking timber, Northwest, 112.
- Bummer, 184, 185*.
- Bundles, raft, 425, 425*.
- Bunks, log camp, 63, 70.
 log car, 353, 354, 355.

C

- Cable, aerial tramway, 255, 256, 257, 259.
 cableway skidder, 216, 217, 221, 223, 226.
 incline, 335, 336.
 loading, 366, 367.
 pullboats, 233.
 re-haul skidder, 238.
 road engine, 248.
 slack-rope system, 233, 236, 238.
 snaking machine, 229.
- Cableway skidder, power logging, single cable, 221.
 slack puller for, 218, 219*.
 steel spar, 215*, 216.
 tail trees for, 216, 223, 226.
 trolleys, 217, 219*, 222, 224, 226.
- Cableway system, power skidding, 214.
 adaptability, 215.
 capacity, 223, 225, 228.
 crew for, 223.
 duplex aerial, 226, 227*, 228*.
 head spar trees for, 216, 218*.
 Lidgerwood, 215, 215*, 217.
 loading logs with, 371, 371*.
 logging radius, 220, 225, 226.
 MacFarlane, 223, 224*.
 mountain, 221.
 North Bend, 225, 225*.

- Cableway system, power skidding, Northwest, 214.
 operation, 219, 221, 224, 226, 228.
 regions in which used, 214.
 relay system, 221, 222*.
- California, aerial tramway in, 260.
 flumes in, 436.
 log car unloading device used in, 379.
 logging with wheeled vehicles in 189, 192.
 towing log rafts to, 427.
 traction engine used in, 197*.
- Camp, air space of, 76.
 blacksmith shop, 63.
 boarding department, 71.
 crew, 71.
 buildings, 62.
 size of, 64.
 ear, 69, 70.
 advantages of, 69.
 Oregon operation, 70.
 Colorado, 28.
 construction of, 61, 66.
 cook shanty, 62.
 equipment for, 521.
 cypress, 33, 61, 70*, 71.
 early type, 60.
 floating, 61, 70*, 71.
 hauling supplies to, 73.
 hygiene, 73.
 Lake States, 30.
 location of, 60, 61.
 Northeast, 29.
 Northwest, 34.
 portable, 65, 66*.
 character of, 65.
 moving, 66.
 size, 66.
 railroad operation, 61.
 rations, 72.
 sanitary service, 73, 80.
 sites for, 60.
 southern yellow pine, 32, 65.
 store, 62, 65, 71.
 storehouse, 63.
 West Virginia, 35.
- Canada, log carrier used in, 398.
 log driving company in New Brunswick, 408.
 log sorting device used in, 405.
 rafting logs in, 421.
- Canals, pullboat logging, 233.
- Cant hook, 96, 96*.
- Caps, high explosive, 308, 309*.
- Car camp, 69.
- Carriers, log, 398.
- Cars, animal draft, 278.
 broad gauge railroad, 353.
 capacity, 354, 355, 356.
 dump, movement of earth with, 299.
 flat, 353.
 chains for, 354.
 stakes for, 353.

- Cars, frictional resistance of, 347.
 loading logs on, by crosshaul, 360.
 by power loaders, 360, 360*.
 by special devices, 366.
 logging trucks, 355, 356*.
 movement of earth with, 302.
 narrow gauge, 282, 352.
 number required, 357, 358.
 pole tram road, 280.
 skeleton, 354, 355*.
 stakes for, 353.
 stringer railroad, 282.
 unloading log, 372.
- Carts, log, 185, 187*, 188*.
- Caterpillar tractor, 204.
- Cattle guards, 322.
- Cedar, Port Orford, 14.
 saw tooth patterns for, 85, 85*.
 western red, 7.
 saw timber, stand, per acre, 13.
 regional, 7, 9, 10.
 United States, 7.
 white, buoyancy of, 413.
- Central States, forest area, 3.
- Chain boom, 400, 401.
- Chains, log car, 354.
 log sleds, 159, 174.
 log wagon, 193.
- Channels, artificial, for improving stream beds, 399, 399*.
- Cherry, 20.
 buoyancy of, 413.
- Chestnut, 7, 18.
 buoyancy of, 413.
 lumber cut, 1920, 18.
 saw timber, stand, per acre, 18.
 by regions, 7.
 United States, 7.
- Chock blocks, log car, 354.
- Chokers, animal skidding, 150, 151*.
 power skidding, 242.
- Chutes, log, 262, 269*, 270.
- Clearing right-of-way, railroad, 293.
- Climax geared locomotive, 343, 343*.
- Coal, locomotive, 349, 350.
- Coastal Plain region, animal logging in, 145.
 carts for logging, 185.
 hand logging in, 144.
 mule carts used in, 190.
 rafting logs in, 425, 425*.
- Colorado, portable mill operations in, 27.
- Columbia River, rafting logs on, 427.
- Connecticut River, log drive on, 418.
- Contract logging (*see* logging, contract).
- Contracts, logging, 48.
 "gipo," 49.
 "log cutting," 48.
- Cook house, camp, 63.
- Coppice, best felling season for, 99.
- Corduroy, 167, 319.
- Cordwood, 26.

- Cottonwood, 7, 20.
 lumber cut, 1919, 20.
 saw timber, stand, by regions, 7.
 United States, 7.
 saw tooth patterns for, 85, 85*.
- Crew, backspiking, railroad track, 327.
 construction, flume, 446.
 ocean-going rafts, 428.
 felling and log-making, Colorado, 28.
 floating and rafting logs, 415, 418, 427.
 loading log cars, crosshaul, 360.
 log drive, 418.
 rafting logs, 427.
 sorting logs, 405.
 steel laying and lifting, 326.
 surfacing, railroad, 331.
- Cribs, for storage booms, 404.
- Cribwork, logging railroad, 319.
- Crosshaul, decking logs with, 137*, 138, 141.
 loading, log cars, 360, 360*.
 motor trucks, 202.
 sleds, 174.
 wagons, 194.
- Crossties, 322, 325.
 hewed, 22, 26.
- Crotch sled, 157.
- Cucumber, 20.
 buoyancy of, 413.
- Culverts, logging railroad, 314*, 321, 321*.
- Cumberland River log drives, per cent of logs lost on, 384.
- Curves, flume, 444.
 railroad, 288, 291.
 slide, 272.
- Cuts and fills, 294.
- Cutting areas, timber felling, 104.
- Cypress, blasting stumps of, 311.
 buoyancy of, 413.
 deadening of, 100.
 girdling, 100.
 insect damage to, 100.
 logging, 33.
 labor, 54.
 log lengths, 110.
 lumber cut, 1920, 12.
 ownership of, 5.
 raft, 424, 424*.
 sawtimber, stand, per acre, 11.
 regional, 7.
 United States, 7.
 saw tooth patterns for, 85, 85*.
 yellow, 13.

D

- Dams, logging, 389.
 concrete, 389.
 construction of, 390, 391.
 crib, 390.
 cribwork for, 391.

- Dams, logging, pier, 399.
pile, 392.
rafter or self-loading, 391.
roll, 389.
self-loading or rafter, 391.
sites for, 388.
sluice gates for, 393, 393*, 394*, 396*, 397*.
types of, 389.
- Davis ocean-going log raft, 429, 429*.
- Deadening timber, 100.
- Decker log loader, 363, 364*.
- Decking logs, 137*, 138.
- Defects, log, crook or sweep, 113.
crotches or forks, 113.
sweep or crook, 113.
- Depreciation, barns, canvas, 67.
camp cars, 69.
motor truck roads, 202.
slide, pole, 266.
steam log hauler, 180.
railroad, stringer, 282.
tractors, 208.
two-sleds, 163.
- Dogs, logging, 151, 151*.
- Dog-warp, 415.
- Douglas fir (*see* fir, Douglas).
- Draft power, animal, 129.
- Drill, churn, 305.
hand, 306.
jumper, 305.
- Drilling rock, 304.
- Drive, log, alligator for towing logs, 417.
boom companies, 408.
conduct of a, 408, 414.
floating and rafting logs, 383.
headworks for towing logs, 416, 416*.
improvement of stream beds and banks, 398.
labor on, 413.
large streams, 417.
log carriers used in Canada on, 398.
picking rear, 416, 418.
requirements for a driveable stream, 387.
St. John's River, 421.
season, 407, 414.
small streams, 414.
sorting and storage facilities for a, 402.
storage reservoirs, 388.
union, 408.
- Driveable stream, requirements for, 387.
- Drivers, log, 413.
- Drumming, 149.
- Dry rooms, logging camps, 78.
- Dudley, 340.
- Dump, log, 375, 376*, 378*.
- Dunnage road, 317*, 318.
- Duplex aerial cableway system, 226.
- Dust road, 317*, 318.
- Dynamite, blasting rock with, 306.
blasting stumps with, 311.
breaking down landings with, 415.

Dynamite, caps for firing, 308.
 care of, 307.
 electric firing of, 309.
 loosening earth with, 298.
 springing holes with, 311.
 strength of, 306.

E

Earth, angle of repose, 294.
 bulk of, when disturbed, 297.
 classification of, for excavation, 296.
 "free haul" in grading contracts, 296.
 hauling, in cars, 302.
 drag scrapers, 301.
 dump carts, 299.
 dump wagons, 300.
 loosening with dynamite, 298.
 measurement of, 296.
 movement of, in cars, animal draft, 302.
 pick work, 298.
 picking and shoveling, 298.
 plowing, 297.
 scrapers, 301.
 shovels, steam, 303.
 wagons, dump, 300.
 wheelbarrows, 299.
 wheeled scrapers, 301.

Efficiency, labor, 51.
 Electric drive, 252.
 Elm, 20.
 buoyancy of, 413.
 lumber cut, 1920, 20.
 Eminent domain, right of, for a logging railroad, 286.
 Engines, traction, capacity, 196, 198.
 four-wheeled, 196.
 fuel requirements, 196, 197.
 three-wheeled, 196, 197*.
 wagon haul, 196, 197*.

Equipment, railroad, rolling stock and motive power, 356.
 snaking, 149.
 wagon haul, 193.

Excavation, rock, 304.
 blasting, 304.
 drilling, 304.
 explosives for, 306.

Explosives, high, 306.
 low, 310.

F

Faller, tree, 94, 94*.
 Falling ax, 82, 83.
 Fantailing, pullboat logging, 233, 234*.
 Fastenings, rail, 324, 325.
 Feeding standards, Wolff-Lehmann, 525.
 Feeding stuffs, ingredients in, 526.
 Fees for catching runaway logs, 385.

- Felling and log-making, one-man hours required for, 54.
 season of, 98, 99.
- Felling timber, bonus for, 47.
 breakage in, 101.
 crews, 100, 102, 103, 104.
 cutting areas, 104.
 direction of fall, 100.
 kerosene, use of, 97.
 kilbig or sampson, use of, 93, 93*.
 methods, 26, 28, 29, 31, 32, 33, 34, 36.
 notching, 105, 105*.
 power machines for, 90.
- Fills and cuts, ratio of slope for, 294.
 width of, 295.
- Fin boom, 400, 401*.
- Fir, Douglas, buoyancy of, 413.
 cross-cut saws for cutting, 86, 86*.
 logging, one-man hours required for, 54.
 log lengths, 110.
 lumber cut, 1920, 8.
 stand, per acre, 8.
 regional, 7.
 United States, 7.
 silver, resistance of wood to cross-cut sawing, 86.
- Firs, true, saw timber, stand, regional, 7.
 United States, 7.
- Fish plates, 324, 324*.
- Flat cars, logging, 353.
- Floating camps, 71.
- Floating logs, 30, 32, 33, 34, 37, 383.
- Floods, loss of logs from, 385.
- Flumes, 433.
 advantages of, 433.
 backbone, for 433.
 box, 436.
 capacity, 434, 436, 445, 450, 452.
 construction of, 445, 452.
 curves for, 444, 444*.
 disadvantages, 433.
 grades for, 445, 451.
 location of, 442.
 material required to construct, 447, 448.
 Northeast, 30.
 Northwest, 35.
 operation of, 447, 451.
 terminals, 441, 441*, 443*.
 trestles for, 438, 439*, 440*.
 V-box, 434, 435*, 437*.
- Force, tractive, locomotives, 346.
- Fore-and-aft roads, 268, 268*.
- Forest area, United States, 3.
- Forest labor, 41.
- Forest regions, United States, 3.
- Forked trees, waste in log-making, 113, 114*.
- Frog, railroad, 325, 326*.
- Fuel, power logging, coal, 250.
 locomotive, 349.
 oil, 250.
 wood, 250.
- Fuse, blasting, electric, 309.
 safety, 308.

G

- Gap, assorting, 403*, 405, 405*, 406*.
 Garbage, camp, disposal of, 75.
 Gate, flume, 451.
 logging dam, barn door, 397.
 bear trap, 394, 394*.
 bracket, 395, 397*.
 half-moon, 395, 396*.
 lift, 393, 393*.
 needle, 395, 397*.
 Gauge, narrow, 285.
 railroad, choice of, 285.
 saw, 84.
 sled, 159, 161, 181.
 standard, 285.
 widening on curves, 330.
 Geared locomotives, advantages of, 342.
 center shaft, 343.
 Climax, 343, 343*.
 Heisler, 344, 344*.
 Shay, 345, 345*.
 side shaft, 345.
 Willamette, 345.
 Gill-poke, unloading logs with, 377.
 Gin-pole, loading, log cars, 366.
 motor trucks, 202.
 Gipo logging, 49.
 Girdling timber, 100.
 Go-devil, 157, 157*.
 Gooseneck, two-sled, 163.
 Gooseneck or scotch, log slide, 274, 274*.
 Grab, maul, 152, 152*.
 skidding, 150, 151*.
 skipper, 152, 152*.
 Grading, railroad, 293.
 Gravity, resistance of load to, logging railroad, 347.
 Ground, bare, effect on skidding output, 153.
 Ground yarding, 239.
 Guards, cattle, 322.
 Gum and cypress logging, one-man hours required for, 54.
 Gum, buoyancy of, 413.
 red, lumber cut, 1920, 18.
 saw timber, stand, per acre, 18.
 regional, 7.
 United States, 7.
 Gumbo, loosening with dynamite, 298.
 Gun stick, 94, 95*.
 Guy-line loading, 370, 370*.

H

- Half-moon gate logging dam, 395, 396*.
 Hand logging, 144.
 Handles, logging tool, 82, 83, 84, 84*, 96.
 Hardpan, classification of, 296.
 Hardwood, buoyancy of, 412, 413.
 damage, fungi, 99.
 insects, 98.
 log lengths, 110.
 logging, one-man hours required for, 54.
 loss in transport, 384.

- Hardwood, lumber cut, 1919, 17.
 ownership of, 5.
 preparation for floating, 412.
 season for felling, 99.
 strength, influence of cutting season on, 99.
 volume, by regions, 4.
- Haulers, log, gasoline, 180.
 steam, 178, 179*.
- Hauling ability of locomotives, 346.
- Hauling, carts, 185.
 motor trucks, 198.
 road engine, 245.
 sled, 173.
 steam log hauler, 178.
 traction engine, 196.
 tractors, 209.
 wagons, 194.
- Headspare, cableway skidder, 216, 218*, 223, 226.
- Headworks, towing, 416, 416*.
- Heisler geared locomotive, 344, 344*.
- Hemlock, buoyancy of, 412, 413.
 eastern, lumber cut, 1919, 10.
 saw timber, stand, per acre, 10.
 regional, 7.
 United States, 7.
 western, lumber cut, 1919, 11.
 saw timber, stand, per acre, 10.
 regional, 7.
 United States, 7.
 saw tooth patterns for, 85, 85*.
- Hickory, buoyancy of, 413.
 lumber cut, 1919, 20.
 saw timber, stand, per acre, 19.
 regional, 7.
 United States, 7.
- High-lead yarding, 243.
- Hook, cant, 96, 96*.
- Horses, advantages of, 131.
 hauling log wagons, 194.
 miles traveled daily, 178, 195.
 picking rear on a log drive with, 416.
 rations for, 132, 528.
 regions in which used, 131.
 use in cableway skidding, 221.
 slide operation, 273.
 snaking, 145.
 snaking system, 230.
 water requirements, 134.
 weight of, 131.
- Hours, one-man, required in logging, 54.
- House, portable, material for, 66.
 bath, sanitary regulations for, 78.
 bunk, sanitary regulations for, 77.
- Hydraulic machines, incline, 338, 338*.
- Hygiene, camp, 73.
- I
- Idaho, log flume in, 434.
 log slides in, 263*, 264*, 265*.
 pole tram roads in, 281.

- Improvement of stream beds and banks, 398.
 Inclines, cables for, 335, 336, 337.
 capacity, 336, 337, 339.
 counterbalanced, 337.
 dudleys for, 340.
 hydraulic lowering device for, 338.
 lowering logs on, 336, 339.
 one-cable, 335.
 one-way, 334.
 snubbing machines for, 338.
 two-cable, 336.
 West Virginia, 37.
 Insect damage, cypress, 100.
 felled timber, 98.

J

- Jack works, 372.
 Jacks, loading, 367.
 Jammers, horse, 174.
 Jams, log, on streams, 415, 417.
 Jumbo sled, 161.

K

- Kentucky, legal fee for catching stray logs on streams in, 385.
 Kerosene, use in felling timber, 97.
 Killig or sampson, 93, 93*.
 Kitchens, camp, sanitary regulations for, 80.

L

- "L" hook, 273, 273*.
 Labor, 41.
 camp hygiene, 73.
 camps for, 60.
 character, 42.
 contract, 48.
 cypress region, 33.
 efficiency of, 51.
 employment of, 41, 42.
 Lake States, 30.
 log driving, 413.
 medical attention for, 58.
 Northeast, 29.
 Northwest, 34.
 southern pine region, 32.
 unions, 53.
 wages, factors which influence, 50.
 West Virginia, 35.
 Lake States, boom companies in, 408.
 carts, log, use of, 31.
 forest area, 3.
 labor, 30.
 logging methods, early, 23.
 logs, per cent lost on drives, 385.
 raising sunken, 130.
 ownership of timber in, 5.

- Lake States, saw timber, area of, 4.
 species, 7.
 volume, 4.
- Landings, "breaking down", 415.
 car loading at, 366, 368.
 water transport, 140, 181.
- Larch, buoyancy of, 413.
 resistance of wood in cross-cut sawing, 86.
- Latrines, camp, sanitary regulations for, 78.
- Legislation, Workmen's Compensation, 57.
- Lengths, log, cypress, 110.
 Lake States, 110.
 Northeast, 110.
 Northwest, 110.
 South, 110.
- Lidgerwood cableway skidder, 215, 215*.
- Liens, log, 50.
- Limber boom, 400.
- Lizard, 158.
- Loaders, horse, for sleds, 174.
 power, 360.
 Barnhart, 361.
 capacity, 366.
 Decker, 363, 364*.
 gin-pole, 366.
 McGiffert, 364, 365*.
 Model "C" American, 362*, 363.
 Model "D" American, 363.
 overhead, 367, 368*, 369, 370*.
 Rapid, 363, 363*.
 Surry Parker, 365.
 swinging-boom, 370, 371*.
- Loading, cableway skidder, 370*, 371*.
 crosshaul, 360.
 devices for, 366.
 flumes, 450.
 from water storage, 372.
 guy-line system, 370, 370*.
 hand, 367.
 jaek, 367.
 jaek works, 372.
 jammers, 174.
 motor trucks, 202.
 portable houses, 66.
 power, 360.
 sleds, 174.
 snaking system, 232.
 special devices for, 366.
 wagons, 194.
- Location, flumes, 442.
 railroads, 287.
- Locomotives, dragging logs with, 249.
 fuel for, 349.
 geared, 342.
 hauling ability, 346, 348.
 number required, 357, 358.
 resistance, frictional, 347.
 rod, 341.
 tractive force, 346.
 water for, 352.

- Log barge, 430.
 booms, 399.
 brands, 409.
 carriers, 398.
 tractor logging, 209.
 carts, 185, 187*, 188*.
 decking, 137*, 138.
 drive, 407, 408, 414, 417.
 dumps, 375, 376*, 378*.
 flumes, 433.
 haulers, gasoline, 180.
 steam, 178, 179*.
 lengths, 110.
 loaders, power, 360.
 marks and brands, 409, 410*.
 property rights in, 411.
 registration of, 411.
 sluices, 433, 435*, 437.
 storage, 136, 373.
- Logging, cars, 282, 352.
 contracts, 24, 25, 48.
 dams, 389.
 Colorado, 27.
 cypress, 33.
 gipo, 49.
 hand, 144.
 industry, character of, 22.
 products of, 22.
 labor, 29, 30, 32, 33, 34, 35.
 Lake States, 30.
 New England, 25.
 Northeast, 28.
 Northwest, 34.
 operations, early, 22.
 organization of, 55, 56.
 portable mill, 24.
 power, 23, 214.
 electrical, 252.
 railroads, 23, 278.
 regions, early, 5.
 season, 25, 27, 28, 30, 32, 33, 34, 35.
 southern yellow pine, 32.
 West Virginia, 35.
- Log-making, bole, extent of utilization, 108.
 equipment for, 82.
 felling and log-making, 98.
 hours, one-man, required for, 54.
 log lengths, 110.
 measuring sticks for, 95.
 methods, 110.
 power bucking, 90, 112.
 season, 98.
 southern yellow pine, 32.
 trimming lengths, 114.
 organization of crews for, 100.
 waste in, 113, 114*.
- Logs, buoyancy of, 412, 413.
 floating and rafting, 383.
 end checking of, 100.
 liens on, 50.

- Logs, prize, 411.
 - saw, 22, 108.
 - sunken, 430.
 - ownership of, 411.
 - salvaging of, 430.
- Lower Mississippi region, forest area, 3.
 - saw timber, area, 4.
 - species, 7.
 - volume, 4.
- Loyal Legion of Loggers and Lumbermen, 56.
 - camp sanitary regulations of, 77.

M

- MacFarlane cableway system, 223, 224*.
- McGiffert log loader, 364, 365*.
- Maine, log brands and marks in, 410.
 - paper birch, preparation for floating, 412.
 - steam log hauler record in, 182.
- Maintenance of way, railroad, 332.
- Mallet articulated locomotive, 341.
- Maple, buoyancy of, 412, 413.
 - lumber cut, 1920, 18.
 - resistance of wood in cross-cut sawing, 86.
 - saw timber, stand, regional, 7.
 - United States, 7.
- Marks, log, 409, 410*.
 - property rights in, 411.
 - registration of, 411.
- Maul, grab, 152, 152*.
- Mauls, 92.
- Measuring sticks, log-making, 95.
- Meat house, sanitary regulations for, 79.
- Medical attention, logging camps, 58.
- Michigan, sunken logs, raising, 430.
- Middle Atlantic States, forest area, 3.
 - saw timber, area, 4.
 - species, 7.
 - volume, 4.
- Mine timbers, transport in flumes, 441.
- Minnesota, validity of log marks in, 411.
- Mississippi River, boom companies on, 408.
 - log loss on drives on, 384, 385.
 - log marks used on, 410, 410*.
 - rafting logs on, 419*, 422, 423*.
- Model "C" American log loader, 362*, 363.
- Model "D" American log loader, 363.
- Monorail system, assorting and storing logs with, 379.
- Montana, logs lost on drives in, 384.
- Motive power, logging railroads, 341.
- Motor trucks (*see* trucks, motor).
- Mud sills, dam, 390.
- Mule carts, 190.
- Mules, advantages of, 132.
 - hauling with, 189, 191, 195.
 - power logging, use in, 230.
 - rations for, 132.
 - water requirements, 134.
 - weight of, 132.

N

- Nails, amounts required to construct flumes, 447, 448.
- Narrow gauge railroad, advantages of, 285.
cars for, 352.
- Needle or bracket gate, sluice, 395, 397*.
- New Brunswick, log driving companies in, 408.
log sorting device in, 405.
rafting logs in, 421, 422*.
- New England, forest area, 3.
logging, portable mill, 24, 25.
saw timber, area, 4.
species, 7.
volume, 4.
- North Bend cableway system, 225, 255*.
- North Carolina, power logging in, 214.
- Northeast, camps, logging, 60.
chutes used in, 270.
crews, felling, 102.
felling and log-making, 29, 102.
haulers, log, used in, 178.
labor, 42.
loading sleds in, 174.
log lengths, 110.
logging methods, 23, 28.
portable mill operations in, 24.
rafting logs in, 421, 422*.
sleds and sled hauling in, 158, 159*, 161, 162*.
- Northwest, aerial tramways in, 256.
camps, car, 69.
chutes, 270.
development of logging in, 24.
felling and log-making, 34, 106.
floating and rafting, 407, 426, 427.
forest area, 3.
hand logging, 144.
labor, 34, 42, 43, 54, 55.
log lengths, 110.
logging methods, 34.
power, bucking, 112.
skidding, 214, 223, 225, 239, 243.
rafting, ocean, 427.
Puget Sound, 426.
saws used in, 85, 85*.
saw timber, area, 4.
species, 7.
volume, 4.
slides, log, 268, 270, 275.
unloading log cars, 374.
yarding logs in, 215, 223, 225, 239, 243.
- Notching timber, 105, 105*.

O

- Oak, buoyancy of, 412, 413.
chestnut, peeling of, 99.
lumber cut, 1920, 17.
resistance of wood in cross-cut sawing, 86.
saw timber, stand, regional, 7.
United States, 7.
white, saw tooth patterns for, 85, 85*.

- Occupations, logging, 59.
- Ocean rafting, 427.
- Ohio River, rafting logs on, 421.
- Overhead systems, loading, 367.
 - logging, 214.
- Oxen, advantages of, 130.
 - rations for, 133, 529.
 - regions in which used, 130.
 - weight of, 130.

P

- Pacific Coast (*see* Northwest).
- Pacific Ocean, rafting on, 427.
- Peavey, 96, 96*.
 - loading cars with, 367.
- Pennsylvania, logging methods, early, 23.
- Pick rear, 416, 418.
- Pick work, in earth, 298.
- Pickaroon, 97.
- Piece work, bonus system for, 43.
 - payment on basis of, 43.
 - premiums, general rules for, 45.
 - standard of, 45.
- Piers for stream improvements, 402, 403, 403*.
- Pike poles, 415.
- Pile dam, 392.
- Pine, eastern white, buoyancy of, 413.
 - log lengths, 110.
 - logs, sunken, 430.
 - lumber cut, 1920, 10.
 - logging, labor required, 54.
 - ownership of, 5.
 - saw tooth patterns for, 85, 85*.
 - stand, per acre, 9.
 - United States, 7.
- Jeffrey, saw timber, stand, regional, 7.
 - United States, 7.
- loblolly, ownership of, 5.
- lodgepole, lumber cut, 1919, 15.
 - saw timber, stand, per acre, 15.
 - regional, 7.
 - United States, 7.
- Scotch, resistance of wood in cross-cut sawing, 86.
- southern, 21.
- southern yellow, blasting stumps of, 311.
 - buoyancy of, 412, 413.
 - logging, 32.
 - labor required, 54.
 - log lengths, 110.
 - lumber cut, 1920, 9.
 - saw timber, stand, per acre, 14.
 - regional, 7.
 - United States, 7.
 - saw tooth patterns for, 85, 85*.
- sugar, lumber cut, 1919, 14.
 - saw timber, stand, per acre, 14.
 - regional, 7.
 - United States, 7.

- Pine**, western white, lumber cut, 1919, 10.
 saw timber, stand, per acre, 10.
 regional, 7.
 United States, 7.
 western yellow, lumber cut, 1920, 9.
 saw timber, stand, per acre, 9.
 regional, 7.
 United States, 7.
- Plates, fish, 321, 324*.
 Plowing earth, output per hour, 297.
 Plug boom, 400.
 Pockets, rafting, 426.
 Pole railroad, 278.
 Pole, pike, 415.
 Poles, cutting, 26.
 rafting, 420*, 421, 421*, 423*.
 Poplar, yellow, buoyancy of, 412, 413.
 lumber cut, 1920, 17.
 resistance of wood in cross-cut sawing, 86.
 saw timber, stand, per acre, 17.
 regional, 7.
 United States, 7.
 saw tooth patterns for, 85, 85*.
 Portable house camp, 65, 66*.
 Potter, 175.
 Powder, black, 310.
 Power, animal draft, 129.
 bucking machines, 90.
 felling machines, 90.
 loaders, 360.
 Power skidding, 214.
 cableway, 215.
 electric drive, 252.
 fuel for, 249.
 relation to forest management, 125.
 slack-rope, 232.
 snaking, 229.
 spark arresters for, 251, 251*.
 Power unloaders, 374.
 Primers and priming, high explosive, 308, 309*.
 Prize logs, 411.
 Puget Sound, rafting on, 426.
 Pullboats, canals for, 233.
 crews for, 237.
 "fantailing," 233, 231*.
 operation of, 235.
 output, 238.
 preparation of logs for skidding, 236.
 Pulpwood, 22, 110, 117, 434.

R

- Raft**, bundles, 425, 425*.
 Davis, 429, 429*.
 log, cypress, 424, 424*.
 Great Lakes, 420.
 Mississippi River, 419*, 422, 423*.
 poles for fastening a, 420*, 421, 421*, 423*.
 New Brunswick, 421.
 Northwest, 426.

- Raft, ocean, 427.
 Ohio River, 421.
- Rafter or self-loading dam, 391, 392*, 393*.
- Rafting, dogs, 420, 420*.
 logs, 383.
 pockets, 426.
 poles, 420*, 421, 421*, 423*.
 stream, 419, 419*.
 works, 407, 426.
- Rail slides, 270.
- Railroad, advantages of rail transport, 283.
 chartered, 286.
 choice of gauge, 285.
 construction of, 293, 313, 331.
 crossties for, 322, 325.
 culverts for, 314*, 321, 321*.
 dunnage or dust, 317*, 318.
 forest, 278.
 grades for, 288.
 inclines on, 334.
 location of, 287.
 locomotives for, 341.
 logging, 23, 30, 31, 33, 34, 35, 36.
 maintenance of way on, 332.
 pole road, 278, 279*, 280*.
 rights-of-way, 286.
 steel laying and lifting, 326.
 stringer, 281.
- Rails, bending of, 327.
 elevation of, 330.
 expansion of, 327.
 fastenings for, 324, 324*.
 guard, 315.
 laying and lifting, 326.
 resistance of, to friction, 347.
 steel, 323, 323*, 325.
 stringer road, 282.
 weight of, 324, 325.
- Rapid log loader, 363, 363*.
- Rations, animal, 132, 528.
 logging camp, 72, 74.
 list of, 74.
 waste of, 72.
- Red gum (*see* gum, red).
- Redwood, buoyancy of, 412, 413.
 log lengths, 110.
 logging, labor required for, 54.
 lumber cut, 1920, 11.
 robbing logs, 117.
 saw timber, stand, per acre, 11.
 regional, 7.
 United States, 7.
 saw tooth patterns for, 85, 85*.
- Regulations, sanitary, for logging camps, 77.
- Re-haul skidder, 238.
- Reservoirs, storage, 388.
- Resistance, frictional, on a logging railroad, 347.
- Right-of-way, logging railroad, 286, 293.
- Riparian owners, complications with, on log drives, 386.
- Road engine, 248.

- Roading, 245, 246, 248.
 Roads, dunnage, 317*, 318.
 fore-and-aft pole, 268, 268*.
 motor truck, 200.
 pole, 278.
 pullboat, 234, 234*.
 rail, 278.
 skid, 148, 249.
 skipper, 147, 148*.
 sled, 164, 164*, 165.
 stringer rail, 281.
 tractor, resistance on, 211, 212.
 wagon, 193.
 Rock, blasting, 304.
 classification of, 296.
 excavation of, 304.
 Rocky Mountain region, forest area, 3.
 saw timber, stand, area, 4.
 volume, 4.
 Rod locomotives, 341.
 Rolling stock, logging railroad, 341.
 Rollways for unloading log cars, 372, 373*.
 Rossing, 116.
 Rut cutter, 172, 172*.

S

- Sack boom, 420.
 Safety laws, logging, 58.
 Sampson or kilhig, 93, 93*
 Sanitation, camp, 75, 80.
 Saw, blade of, 84, 85*, 89*.
 felling timber with, 106.
 fitting, 86, 88.
 tools, 86.
 gauge of, 84.
 handles for, 84, 84*.
 length, 84.
 life of, 89.
 rakers, 85, 87.
 set, 87.
 teeth, 85, 85*, 89*.
 Scotch, log slide, 274, 274*.
 Scrapers, drag, 301, 303.
 Self-loading dam, 391, 393*.
 Shay locomotive, 345, 345*.
 Sheep-shank boom, 400.
 Shovels, movement of earth with, 298.
 steam, 303.
 Skeleton cars, 354, 355*.
 Skid roads, 148, 249.
 Skidding, bonus for, 43.
 cableway, 34, 214, 215*, 217*, 218*, 219*, 220*, 224*, 225*.
 Colorado, 28.
 crews, 153.
 cypress, 33.
 double trees for, 149.
 grabs for, 150, 151*.
 J-hook for, 151, 151*.
 labor required for, 54.

- Skidding, Lake States, 31.
 New England, 26, 29.
 Northwest, 34.
 power, relation to forest management, 125.
 pullboat, 33, 233.
 southern yellow pine, 32.
 spreaders for, 149, 150*.
 West Virginia, 36.
- Skids, balanced, for loading aerial tramways, 256.
 fender, timber slide, 263.
 hardwood, for log wagon, 193.
- Skidways, 136, 137*, 139*, 140*, 141*.
 capacity, 139.
 loading logs from, 141, 142, 174.
 railroad haul, 141, 141*.
 sled haul, 136, 137*.
 wagon haul, 141, 191*.
- Skipper, grab, 152, 152*.
 road, 147, 148*.
- Slack puller, cableway skidder, 218, 219.
- Slack-rope system, power logging, 232, 233, 238, 239, 243.
- Sledge, 92.
- Sleds, 157, 157*, 159*, 162*, 181*.
 bob, 161.
 chains for, 160, 175.
 go-devil, 157, 157*.
 hauling with, 173.
 jumbo, 161.
 lizard, 158.
 loading, 174.
 roads for, 164, 164*, 165, 165*.
 scoot, 26.
 two-sled, 161, 162*.
 chains for, 174.
 yarding, 158, 159*.
- Slide, timber, 262, 262*, 263*, 264, 264*, 265*, 266*, 267*.
 trail, 263.
- Slides, log, brake for, 275.
 capacity of, 275.
 checking speed on, 274, 275.
 construction of, 263, 264, 267, 271.
 curves on, 272.
 earth, 263.
 grades on, 271.
 life of, 266.
 maintenance of, 277.
 operation of, 273.
 rail, 270.
 sawed timber, 266*, 267, 267*.
 snubbing device for, 275, 276*.
- Slope, effect on felling output, 102.
 effect on skidding output, 153, 154, 155.
- Sluice gates, 393.
- Sluice, log, 433, 437.
- Snaking, animal, 145, 146*, 147*, 148*.
 equipment for, 149, 150*, 151*, 152*.
 power, 229, 230*.
- Sniping logs, 117.
- Snow, effect on skidding output, 154, 155.
- Snow plows, 171.

- Snow shed, 170, 170*.
 Snubbing device, 165, 176, 176*, 177*.
 log slide, 275, 276*.
 motor truck, 202.
 Snubbing machine, hydraulic, 338, 338*.
 Softwoods, eastern, saw timber, stand, regional, 7.
 species, 7.
 United States, 7.
 western, saw timber, stand, regional, 7.
 species, 7.
 United States, 7.
 Sorting gap, 405.
 Sorting logs, 402.
 South Atlantic States, forest area, 3.
 saw timber, stand, species, 7.
 volume, 7.
 Southern pine region, camps, 65, 66*.
 felling and log-making, 32, 101.
 labor, 32, 51.
 log lengths, 110.
 logging methods, 32.
 Spark arresters, 251, 251*, 351, 352*.
 Spars, cableway, 216, 219.
 Spikes, railroad, 325.
 Spiking, back, 327.
 Spreader, 149, 150*.
 Spring board, 92, 92*.
 Sprinkler for a sled road, 172, 175*.
 Spruce, buoyancy of, 413.
 eastern, lumber cut, 1919, 13.
 stand per acre, 13.
 Engelmann, stand per acre, 16.
 log lengths, 110.
 resistance of wood in cross-cut sawing, 86.
 rossing, 116.
 saw timber, stand, regional, 7.
 United States, 7.
 saw tooth patterns for, 85, 85*.
 Sitka, stand per acre, 16.
 western, lumber cut, 1919, 16.
 stand per acre, 16.
 Spur, logging railroad, 295, 295*, 317*, 318.
 Stables, camp, 63, 65, 67, 68*.
 Stakes, log car, 353.
 Standard log lengths, 110.
 Standards, feeding, Wolff-Lehmann, 525.
 Steel laying and lifting, 326.
 Stick, measuring, 95.
 Storage booms, 403.
 Storehouse, camp, 63, 65.
 Streams, driveable, requirements for, 387.
 improvement of, 398.
 large, drive on, 417.
 rafting on, 419.
 small, drive on, 414, 417.
 Stringer railroad, 281.
 capacity, 281.
 cars for, 282.
 construction of, 281.
 disadvantages, 281.

- Stringer railroad, grades on, 281.
 maintenance of, 282.
 rails for, 281.
- Stump, blasting, 311.
 heights of, 107.
- Stumpage, ownership of, 4, 5.
- Summary of logging methods, 24.
- Sunken logs, 411, 430.
- Supervision, labor required for, 54.
- Supplies, track, 322.
- Surfacing railroads, 331.
- Surry Parker log loader, 365.
- Sweep, logs, 113.
- Swinging, 245.
- Swinging-boom log loader, 370, 371*.
- Switch, railroad, 325, 326*.
 slide, 266.
- Sycamore, buoyancy of, 413.

T

- Tail tree, cableway skidding, 216, 223, 226.
 pullboat logging, 234.
- Tamping explosives, for rock blasting, 310.
 for stump blasting, 312.
- Tanbark, peeling, 99.
- Task system, payment of labor, 48.
- Team boss, duties of, 191.
- Teeth, cross-cut saw, 85, 85*, 89*.
- Tennessee River, per cent of logs lost on, 384.
- Terminals, flume, 441, 441*, 443*.
- Terms used in logging, 469.
- Timber, deadening, 100.
 felling, 106.
 saw, ownership of, 4, 5.
 volume, by regions, 4.
- Timber slides and chutes (*see* slides).
- Timber work, railroad grade, 313.
- Tongs, animal skidding, 150, 151*.
 pullboat skidding, 237.
- Towing booms, 400, 420.
- Towing rafts, 421, 422, 424, 426, 429.
- Track laying and lifting, 326.
- Traction engines, 196, 197*.
- Traction force, locomotives, 346.
- Tractors, 204, 205*, 209*.
 adaptability, 204.
 caterpillar, for log slide draft, 273.
 crawler, 204, 205*, 207*.
 advantages of, 206.
 efficiency of, 211.
 gasoline consumption of, 208.
 hauling with, 211.
 life of, 208.
 skidding with, 208, 210.
 speed of, 211.
 tractive power of, 212.
 wheeled, 204.
- Trailers, motor truck, 200.

- Tramways, aerial, 35, 255.
 capacity, 256, 257, 259, 261.
 endless cable, 260.
 gravity, 255.
 hangers for, 259, 260*.
 single wire, 256, 257*, 258*.
 trolleys for, 259, 260*.
- Transportation, 121.
 primary, 126.
 secondary, 123.
- Travois, 157, 157*.
- Tree faller, 94, 94*.
- Trestle, flume, 438, 439*, 440*.
 framed, 314, 316, 316*.
 pile, 313, 314*.
- Trolley, aerial tramway, 256, 257*, 258*, 259, 260*.
 cableway skidder, 217, 219*, 222, 224, 226.
- Truck, logging, 355, 356*.
 motor, 35, 198.
 adaptability to logging, 198.
 capacity, 202.
 loading, 202.
 roads for, 200.
 trailers for, 200.
 types, 199.
 use on a stringer road, 283.
- Tug, log towing, 417.
- Turnout, logging railroad, 325, 326*.
- Turpentine ax, 83, 83*.
- Two-sled, binding chains for, 174.
 hauling with, 161.
 loading, 174.
 roads for, 165.

U

- Undercut, felling, 105.
- Undercutter, 97, 97*.
- Unions, labor, 53.
- United States, eastern, timber ownership in, 4.
 forest area, 3.
 timber, volume of, 3.
- Unloaders, power, 374.
- Unloading log cars, 360.
 cableway system, 375.
 gill-poke, 377.
 hand methods, 372.
 labor required, 54.
 log dump for, 375, 376*, 378*.
 rollways for, 372, 373*.
 motor trucks, 202.
 wagons, 194.

V

- Vehicles, wheeled, 184.

W

- Wage, basis of payment, 43.
- Wages, factors which influence, 50.

- Wagons, capacity, 195.
equipment for, 193.
log, eight-wheeled, 192, 193*.
four-wheeled, 190, 191*.
hauling with, 194.
loading, 194, 195.*
mule carts, 190.
roads for, 193.
six-wheeled, 192.
- Wanigan, 414.
- Waste, felling and log-making, 113.
elimination of, 47.
table, in logging camps, 72.
- Water, camp, purity of, 75.
for animals, 134.
for locomotives, 352.
- Wedges, 91, 91*.
- West Virginia, logging in, 35.
- Western yellow pine (*see* pine, western yellow).
- Wheelbarrows, moving earth with, 299.
- Whip-poor-will switch, log slide, 266, 266*.
- Willow, resistance of wood in cross-cut sawing, 86.
- Wood fuel, logging 349, 350.
- Workmen's compensation legislation, 57.
- Works, rafting, 407.

Y

- Yarding engine, crew for, 242.
duplex, 226, 227*, 228*.
- Yarding sled, 158.
capacity, 160.
hauling with, 160.
roads for, 164, 164*.

BOOKS
ON
FORESTRY

PUBLISHED BY
JOHN WILEY & SONS, Inc.
NEW YORK

Books on Forestry

Forest Physiography—Physiography of the United States and Principles of Soils in Relation to Forestry.

By ISAIAH BOWMAN, Ph.D., Director American Geographical Society. xii+759 pages. 6 by 9. 292 figures and 6 plates, including a New Geologic Map of North America, in colors. Cloth.....net, \$5.00

A book on physiography for students of forestry, and also a work which historians and economists will find of value.

Elements of Forestry.

By FREDERICK FRANKLIN MOON, B.A., M.F., Professor of Forest Engineering, and NELSON COURTLANDT BROWN, B.A., M.F., Professor of Forest Utilization, The New York State College of Forestry, Syracuse University. xvii+392 pages. 5¼ by 8. 65 figures. Cloth.....net, \$3.50

A textbook of broad scope, containing general information on all phases of the subject.

Forest Products; Their Manufacture and Use.

By NELSON COURTLANDT BROWN, B.A., M.F., Professor of Forest Utilization, The New York State College of Forestry, Syracuse University. xix+450 pages. 6 by 9. 120 figures. Cloth.....net, \$4.00

A book for lumbermen, manufacturers, users and importers of forest products, foresters, and students in professional schools of forestry.

The American Lumber Industry.

By NELSON COURTLANDT BROWN. xiv+275 pages. 6 by 9. 36 figures. Clothnet, \$3.00

Embracing the principal features of the resources, production, distribution and utilization of lumber in the United States.

Logging—The Principles and General Methods of Operation in the United States.

By RALPH CLEMENT BRYANT, F.E., M.A., Manufacturers' Association Professor of Lumbering, Yale University. Second Edition, Thoroughly Revised and Reset. xiii+556 pages. 6 by 9. 165 figures. Cloth.net, \$4.50

Discusses at length the chief facilities and methods for the movement of the timber from the stump to the manufacturing plant.

Lumber: Its Manufacture and Distribution.

By RALPH CLEMENT BRYANT. xxi+539 pages. 6 by 9. 155 figures. Clothnet, \$4.50

The only textbook on lumber manufacture and distribution now available in any language.

Forest Valuation.

By HERMAN HAUPT CHAPMAN, M.F., Harriman Professor of Forest Management, Yale University Forest School. xvi+310 pages. 6 by 9. Clothnet, \$3.00

Treats the subject in a manner that may be readily grasped by the average reader, without previous preparation or study.

Forest Mensuration.

By HERMAN HAUPT CHAPMAN, M.F. xvii+553 pages. 6 by 9. 88 figures. Clothnet, **\$5.00**

A thorough discussion of the measurement of the volume of felled timber, in the forms of logs or other products, of the measurement of the volume of standing timber, and of the growth of trees, stands of timber and forests.

Farm Forestry.

By JOHN ARDEN FERGUSON, A.M., M.F., Professor of Forestry at The Pennsylvania State College. viii+241 pages. 5¼ by 8. Illustrated. Clothnet, **\$2.00**

This book brings together in available form ideas and principles relating to the care and management of the farm woodlot and the utilization of the products of the woodlot.

The Principles of Handling Woodlands.

By HENRY SOLON GRAVES, M.A., Dean of the School of Forestry, Yale University. xxi+325 pages. 5¼ by 8. 63 figures. Cloth.....net, **\$2.50**

Takes up the cutting of mature stands of timber and their replacement by new growth; cuttings in immature stands, and forest protection with reference to forest fires.

Principles of American Forestry.

By SAMUEL B. GREEN, Late Professor of Horticulture and Forestry, University of Minnesota. xiii+334 pages. 5 by 7¼. 73 figures. Cloth, **\$2.00**

A book for the general reader who wishes to secure a general idea of the subject of forestry in North America.

Manual of Forestry for the Northeastern United States.

Being Volume I of "Forestry in New England", Revised.

By RALPH CHIPMAN HAWLEY, M.F., Professor of Forestry, Yale University, and AUSTIN FOSTER HAWES, M.F., formerly State Forester of Connecticut and of Vermont. xii+281 pages. 6 by 9. 65 figures. Clothnet, **\$3.50**

Furnishes the woodland owner with a brief survey of the whole field of forestry.

The Practice of Silviculture.

With Particular Reference to Its Application in the United States. By RALPH CHIPMAN HAWLEY. xi+352 pages. 5¼ by 8. 82 figures. Clothnet, **\$4.00**

A new textbook, presenting the subject from the standpoint of the teacher and covering a field heretofore unfilled.

The Development of Forest Law in America.

By J. P. KINNEY, A.B., LL.B., M.F., Chief Supervisor of Forests, United States Indian Service. xxxix+254 pages. 6 by 9. Cloth.....net, **\$2.50**

A logical presentation of the chronological development of legislation in this field.

The Essentials of American Timber Law.

By J. P. KINNEY, A.B., LL.B., M.F. xxix+279 pages. 6 by 9. Cloth, net, \$3.00

Gives the existing law regarding trees and their products as property. A book for both foresters and lawyers.

Both books ordered at one time.....net \$5.00

Studies of Trees.

By J. J. LEVISON, M.F., formerly Lecturer on Ornamental and Shade Trees, Yale University Forest School. x+253 pages. 5¼ by 7½. 155 half-tone figures. Cloth.....net, \$2.00

Takes up in a brief and not too technical way the most important facts concerning the identification, structure and uses of our more common trees, considering their habits, enemies and care.

(Also issued in loose-leaf form. Complete set of 20 pamphlets, 8 by 10½. \$1.00 net. Cloth binder, sold separately, 50 cents net.)

Forest Management.

By A. B. RECKNAGEL, B.A., M.F., Professor of Forest Management and Utilization, and JOHN BENTLEY, JR., B.S., M.F., Assistant Professor of Forest Engineering, Cornell University. xiii+267 pages. 6 by 9. 26 figures. Clothnet, \$2.50

Treats the subjects, forest mensuration, forest organization, forest finance, and forest administration in such a manner as to be readily understood and used by the layman timber owner and manager.

The Theory and Practice of Working Plans (Forest Organization).

By A. B. RECKNAGEL, B.A., M.F. Second Edition, Thoroughly Revised. xiv+265 pages. 6 by 9. Illustrated. Clothnet, \$2.50

A book of value to the practicing forester, as well as to the student. The best of European methods are presented, adapted to the needs of American forestry.

Identification of the Economic Woods of the United States.

Including a Discussion of the Structural and Physical Properties of Wood. Second Edition, Revised and Enlarged.

By SAMUEL J. RECORD, M.A., M.F., Professor of Forest Products, Yale University. ix+157 pages. 6 by 9. 15 figures and 6 full-page half-tone plates. Clothnet, \$2.50

An efficient aid in the study and identification of wood. The new edition brings the work right up to date in every respect.

The Mechanical Properties of Wood.

Including a Discussion of the Factors Affecting the Mechanical Properties, and Methods of Timber Testing.

By SAMUEL J. RECORD, M.A., M.F. xi+165 pages. 6 by 9. 51 figures. Clothnet, \$2.50

All unnecessary technical language and descriptions have been avoided, making the subject-matter readily available to everyone interested in wood.

Range and Pasture Management.

By ARTHUR W. SAMPSON, Associate Professor of Range Management, University of California. xix+421 pages. 6 by 9. 130 figures, 1 plate showing stock-poisoning plants in natural colors. Cloth.....net, **\$4.00**

Provides systematic instruction for those who desire a practical working knowledge of the subject, as well as for those who wish to follow technical grazing work as a profession and fit themselves for such positions as those offered by the United States Forest Service.

Livestock Husbandry on Range and Pasture.

By ARTHUR W. SAMPSON. (In Preparation.)
Devoted to a discussion of the management of range and pasture livestock.

Native American Forage Plants.

By ARTHUR W. SAMPSON. (In Preparation.)

Treats in detail all important native forage grasses and broad-leaved plants; pasture values, natural history, growth requirements and life processes of vegetation as related to forage production; and pastoral botany.

Shade-Trees in Towns and Cities.

By WILLIAM SOLOTAROFF, B.S., Late Secretary and Superintendent of the Shade-Tree Commission of East Orange, N. J. xviii+287 pages. 6 by 9. 46 full-page plates and 35 figures in the text. Cloth.....net, **\$3.50**

Takes up the questions of the selection, planting and care of trees as applied to the art of street decoration; their diseases and remedies; their municipal control and supervision.

Field Book for Street-Tree Mapping.

By WILLIAM SOLOTAROFF, B.S. 160 pages. 4½ by 7¾. Each, **\$1.25**
net. One dozennet, **\$12.00**

Blank field books for enumerating street-trees when taking a tree census.

Handbook for Rangers and Woodsmen.

By JAY L. B. TAYLOR, formerly Forest Ranger, United States Forest Service. ix+420 pages. 4¼ by 6¾. 236 figures. Flexible "Fabrikoid" bindingnet, **\$3.00**

A guide for inexperienced men in woods work, and for others whose work or recreation takes them into rough and unsettled regions.

Seeding and Planting in the Practice of Forestry.

By JAMES W. TOUMNEY, M.S., M.A., Morris K. Jesup Professor of Silviculture, Yale University. xxxvi+455 pages. 6 by 9. 140 figures. Clothnet, **\$4.00**

A manual for the guidance of forestry students, foresters, nurserymen, forest owners, and farmers.

Handbook of Field and Office Problems in Forest Mensuration.

By HUGO WINKENWERDER, Dean, College of Forestry, University of Washington, and ELIAS T. CLARK, Associate Professor of Forestry, University of Washington. ix+133 pages. 5 by 7½. Flexible bindingnet, **\$2.00**

A series of carefully selected type exercises prepared as an aid to the laboratory instruction in forest mensuration, which may be used as practical illustrations to supplement recitation and textbook work.

The Valuation of American Timberlands.

By K. W. WOODWARD, Professor of Forestry, New Hampshire State College. vii+253 pages. 6 by 9. 13 figures. Cloth.....net, **\$3.00**

This book supplies valuable information needed by the investor, timber cruiser and student of forestry. It gives for the continental United States and its outlying territories, Hawaii and the Canal Zone excepted, the principal facts regarding the timber resources.

French Forests and Forestry—Tunisia, Algeria, Corsica. With a Translation of the Algerian Code of 1903.

By THEODORE S. WOOLSEY, JR., M.F., Executive Member of the Inter-allied War Timber Committee, 1917-1919, Paris, France; formerly Lecturer, Yale Forest School. xv+238 pages. 6 by 9. Illustrated. Cloth. net, **\$3.00**

The results of a study of the more important phases of forest practice in Corsica, Algeria, and Tunisia, setting forth the essentials of method which may be applied directly in the United States.

Studies in French Forestry.

By THEODORE S. WOOLSEY, JR. Two chapters by WILLIAM B. GREELEY, formerly Chief of the Forestry Section, Engineers, A.E.F., Tours, France, and now Chief Forester, U. S. Forest Service. vii+550 pages. 6 by 9. Profusely illustratednet, **\$6.00**

This general book on French forestry is of interest to students, practicing foresters, lumbermen, estate owners, and all members of the 10th and 20th Engineers (Forestry) A. E. F.

Forest Protection.

By DAVID T. MASON, Forest Engineer. (In Preparation.)

Shows how the facts and principles developed by entomologists, pathologists, and others may be applied in a businesslike way to the protection of forests.

**PLEASE DO NOT REMOVE
CARDS OR SLIPS FROM THIS POCKET**

UNIVERSITY OF TORONTO LIBRARY

Med

